

## FCC Test Report

**Report No.:** RF160513C20-7

**FCC ID:** V65E6820

**Test Model:** E6820/E6820TM

**Received Date:** Apr. 19, 2016

**Test Date:** Apr. 28, 2016 ~ Jun. 06, 2016

**Issued Date:** Jun. 16, 2016

**Applicant:** Kyocera Corporation c/o Kyocera Communications, Inc.

**Address:** 8611 Balboa Avenue, San Diego, CA 92123

**Issued By:** Bureau Veritas Consumer Products Services (H.K.) Ltd., Taoyuan Branch

**Lab Address:** No. 47-2, 14th Ling, Chia Pau Vil., Lin Kou Dist., New Taipei City, Taiwan  
( R.O.C )

**Test Location (1):** No. 19, Hwa Ya 2nd Rd, Wen Hwa Tsuen, Kwei Shan Hsiang, Taoyuan  
Hsien 333, Taiwan, R.O.C.



This report is for your exclusive use. Any copying or replication of this report to or for any other person or entity, or use of our name or trademark, is permitted only with our prior written permission. This report sets forth our findings solely with respect to the test samples identified herein. The results set forth in this report are not indicative or representative of the quality or characteristics of the lot from which a test sample was taken or any similar or identical product unless specifically and expressly noted. Our report includes all of the tests requested by you and the results thereof based upon the information that you provided to us. You have 60 days from date of issuance of this report to notify us of any material error or omission caused by our negligence, provided, however, that such notice shall be in writing and shall specifically address the issue you wish to raise. A failure to raise such issue within the prescribed time shall constitute your unqualified acceptance of the completeness of this report, the tests conducted and the correctness of the report contents. Unless specific mention, the uncertainty of measurement has been explicitly taken into account to declare the compliance or non-compliance to the specification. The report must not be used by the client to claim product certification, approval, or endorsement by TAF or any government agencies.

## Table of Contents

<b>Release Control Record .....</b>	<b>4</b>
<b>1 Certificate of Conformity .....</b>	<b>5</b>
<b>2 Summary of Test Results.....</b>	<b>6</b>
2.1 Measurement Uncertainty.....	6
2.2 Modification Record .....	6
<b>3 General Information .....</b>	<b>7</b>
3.1 General Description of EUT .....	7
3.2 Description of Test Modes.....	9
3.2.1 Test Mode Applicability and Tested Channel Detail.....	11
3.3 Duty Cycle of Test Signal .....	13
3.4 Description of Support Units .....	17
3.4.1 Configuration of System under Test .....	17
3.5 General Description of Applied Standards.....	18
<b>4 Test Types and Results .....</b>	<b>19</b>
4.1 Radiated Emission and Bandedge Measurement .....	19
4.1.1 Limits of Radiated Emission and Bandedge Measurement .....	19
4.1.2 Limits of Unwanted Emission Out of the Restricted Bands .....	19
4.1.3 Test Instruments .....	20
4.1.4 Test Procedures.....	21
4.1.5 Deviation from Test Standard .....	21
4.1.6 Test Set Up .....	22
4.1.7 EUT Operating Conditions.....	22
4.1.8 Test Results .....	23
4.2 Conducted Emission Measurement.....	65
4.2.1 Limits of Conducted Emission Measurement .....	65
4.2.2 Test Instruments .....	65
4.2.3 Test Procedures.....	66
4.2.4 Deviation from Test Standard .....	66
4.2.5 Test Setup.....	66
4.2.6 EUT Operating Conditions.....	66
4.2.7 Test Results .....	67
4.3 Transmit Power Measurement.....	69
4.3.1 Limits of Transmit Power Measurement .....	69
4.3.2 Test Setup.....	69
4.3.3 Test Instruments .....	70
4.3.4 Test Procedure .....	70
4.3.5 Deviation from Test Standard .....	70
4.3.6 EUT Operating Conditions.....	70
4.3.7 Test Result .....	71
4.4 Peak Power Spectral Density Measurement .....	77
4.4.1 Limits of Peak Power Spectral Density Measurement .....	77
4.4.2 Test Setup.....	77
4.4.3 Test Instruments .....	77
4.4.4 Test Procedures.....	77
4.4.5 Deviation from Test Standard .....	78
4.4.6 EUT Operating Conditions.....	78
4.4.7 Test Results .....	79
4.5 Frequency Stability .....	84
4.5.1 Limit of Frequency Stability Measurement .....	84
4.5.2 Test Setup.....	84
4.5.3 Test Instruments .....	84
4.5.4 Test Procedure .....	84
4.5.5 Deviation from Test Standard .....	84

4.5.6 EUT Operating Condition .....	84
4.5.7 Test Results .....	85
4.6 6 dB Bandwidth Measurement.....	86
4.6.1 Limits of 6 dB Bandwidth Measurement.....	86
4.6.2 Test Setup.....	86
4.6.3 Test Instruments .....	86
4.6.4 Test Procedure .....	86
4.6.5 Deviation from Test Standard .....	86
4.6.6 EUT Operating Condition .....	86
4.6.7 Test Results .....	87
<b>5 Pictures of Test Arrangements.....</b>	<b>89</b>
<b>Appendix – Information on the Testing Laboratories .....</b>	<b>90</b>

### Release Control Record

Issue No.	Description	Date Issued
RF160513C20-7	Original Release	Jun. 16, 2016

## 1 Certificate of Conformity

**Product:** PDA Phone

**Brand:** KYOCERA

**Test Model:** E6820/E6820TM

**Sample Status:** Identical Prototype

**Applicant:** Kyocera Corporation c/o Kyocera Communications, Inc.

**Test Date:** Apr. 28, 2016 ~ Jun. 06, 2016

**Standards:** 47 CFR FCC Part 15, Subpart E (Section 15.407)  
ANSI C63.10:2013

The above equipment has been tested by **Bureau Veritas Consumer Products Services (H.K.) Ltd., Taoyuan Branch**, and found compliance with the requirement of the above standards. The test record, data evaluation & Equipment Under Test (EUT) configurations represented herein are true and accurate accounts of the measurements of the sample's EMC characteristics under the conditions specified in this report.

**Prepared by :**



**Date:**

Jun. 16, 2016

Ivonne Wu / Supervisor

**Approved by :**

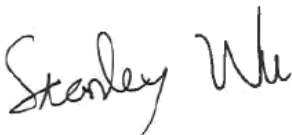

**Date:**

Jun. 16, 2016

Stanley Wu / Assistant Manager

## 2 Summary of Test Results

47 CFR FCC Part 15, Subpart E (Section 15.407)			
FCC Clause	Test Item	Result	Remarks
15.407(b)(6)	AC Power Conducted Emissions	Pass	Meet the requirement of limit. Minimum passing margin is -18.77 dB at 2.12200 MHz.
15.407(b) (1/2/3/4/6)	Radiated Emissions & Band Edge Measurement	Pass	Meet the requirement of limit. Minimum passing margin is -3.87 dB at 62.98 MHz.
15.407(a)(1/2 /3)	Max Average Transmit Power	Pass	Meet the requirement of limit.
15.407(a)(1/2 /3)	Peak Power Spectral Density	Pass	Meet the requirement of limit.
15.407(e)	6 dB Bandwidth	Pass	Meet the requirement of limit. (U-NII-3 Band only)
15.407(g)	Frequency Stability	Pass	Meet the requirement of limit.
15.203	Antenna Requirement	Pass	No antenna connector is used.

### 2.1 Measurement Uncertainty

Where relevant, the following measurement uncertainty levels have been estimated for tests performed on the EUT as specified in CISPR 16-4-2:

Measurement	Frequency	Expanded Uncertainty (k=2) (±)
Conducted Emissions at mains ports	150 kHz ~ 30 MHz	2.44 dB
Radiated Emissions up to 1 GHz	30 MHz ~ 200 MHz	2.93 dB
	200 MHz ~ 1000 MHz	2.95 dB
Radiated Emissions above 1 GHz	1 GHz ~ 18 GHz	2.26 dB
	18 GHz ~ 40 GHz	1.94 dB

### 2.2 Modification Record

There were no modifications required for compliance.

### 3 General Information

#### 3.1 General Description of EUT

<b>Product</b>	PDA Phone
<b>Brand</b>	KYOCERA
<b>Test Model</b>	E6820/E6820TM
<b>Status of EUT</b>	Identical Prototype
<b>Power Supply Rating</b>	5.0 Vdc or 9.0 Vdc (adapter) 5.0 Vdc (host equipment) 3.8 Vdc (Li-ion battery)
<b>Modulation Type</b>	256QAM, 64QAM, 16QAM, QPSK, BPSK
<b>Modulation Technology</b>	OFDM
<b>Transfer Rate</b>	802.11a: 54.0/ 48.0/ 36.0/ 24.0/ 18.0/ 12.0/ 9.0/ 6.0 Mbps 802.11n: up to MCS7 802.11ac: up to V9
<b>Operating Frequency</b>	5180 ~ 5240 MHz, 5260 ~ 5320 MHz, 5500 ~ 5700 MHz, 5745 ~ 5825 MHz
<b>Number of Channel</b>	5180 ~ 5240 MHz: 4 for 802.11a, 802.11n (HT20) 2 for 802.11n (HT40) 1 for 802.11ac (VHT80) 5260 ~ 5320 MHz: 4 for 802.11a, 802.11n (HT20) 2 for 802.11n (HT40) 1 for 802.11ac (VHT80) 5500 ~ 5700 MHz: 11 for 802.11a, 802.11n (HT20) 5 for 802.11n (HT40) 2 for 802.11ac (VHT80) 5745 ~ 5825 MHz: 5 for 802.11a, 802.11n (HT20) 2 for 802.11n (HT40) 1 for 802.11ac (VHT80)
<b>Output Power</b>	86.30 mW for 5180 ~ 5240 MHz 84.72 mW for 5260 ~ 5320 MHz 82.99 mW for 5500 ~ 5700 MHz 71.29 mW for 5745 ~ 5825 MHz
<b>Antenna Type</b>	Monopole antenna with -0.9 dBi gain (5180 ~ 5240 MHz) Monopole antenna with -0.5 dBi gain (5260 ~ 5320 MHz) Monopole antenna with 0.1 dBi gain (5500 ~ 5700 MHz) Monopole antenna with 0.3 dBi gain (5745 ~ 5825 MHz)
<b>Antenna Connector</b>	N/A
<b>Accessory Device</b>	Refer to Note as below
<b>Data Cable Supplied</b>	Refer to Note as below

**Note:**

1. All models are listed as below.

Brand	Model	Difference
KYOCERA	E6820	E6820 and E6820TM are the same with electrically identical.
	E6820TM	The difference between E6820 and E6820TM are minor cosmetic changes and changes to the UI (software).

2. The EUT contains following accessory devices.

Product	Brand	Model	Description
Adapter	KYOCERA	SCP-49ADT	I/P: 100-240 Vac, 50/60 Hz, 400 mA O/P: 5.0 Vdc, 1800 mA or 9.0 Vdc, 1800 mA
Battery	KYOCERA	SCP-67LBPS	3.8 Vdc, 3240 mAh
USB Cable	KYOCERA	SCP-22SDC	1.0 m shielded cable w/o core

3. The above EUT information is declared by manufacturer and for more detailed features description, please refer to the manufacturer's specifications or user's manual.



### 3.2 Description of Test Modes

#### FOR 5180 ~ 5240 MHz

4 channels are provided for 802.11a, 802.11n (HT20):

Channel	Frequency (MHz)	Channel	Frequency (MHz)
36	5180	44	5220
40	5200	48	5240

2 channels are provided for 802.11n (HT40):

Channel	Frequency (MHz)	Channel	Frequency (MHz)
38	5190	46	5230

1 channel is provided for 802.11ac (VHT80):

Channel	Frequency (MHz)
42	5210

#### FOR 5260 ~ 5320 MHz

4 channels are provided for 802.11a, 802.11n (HT20):

Channel	Frequency (MHz)	Channel	Frequency (MHz)
52	5260	60	5300
56	5280	64	5320

2 channels are provided for 802.11n (HT40):

Channel	Frequency (MHz)	Channel	Frequency (MHz)
54	5270	62	5310

1 channel is provided for 802.11ac (VHT80):

Channel	Frequency (MHz)
58	5290

### FOR 5500 ~ 5700 MHz

11 channels are provided for 802.11a, 802.11n (HT20):

Channel	Frequency (MHz)	Channel	Frequency (MHz)
100	5500	124	5620
104	5520	128	5640
108	5540	132	5660
112	5560	136	5680
116	5580	140	5700
120	5600		

5 channels are provided for 802.11n (HT40):

Channel	Frequency (MHz)	Channel	Frequency (MHz)
102	5510	126	5630
110	5550	134	5670
118	5590		

2 channels are provided for 802.11ac (VHT80):

Channel	Frequency (MHz)	Channel	Frequency (MHz)
106	5530	122	5610

### FOR 5745 ~ 5825 MHz:

5 channels are provided for 802.11a, 802.11n (HT20):

Channel	Frequency (MHz)	Channel	Frequency (MHz)
149	5745	161	5805
153	5765	165	5825
157	5785		

2 channels are provided for 802.11n (HT40):

Channel	Frequency (MHz)	Channel	Frequency (MHz)
151	5755	159	5795

1 channel is provided for 802.11ac (VHT80):

Channel	Frequency (MHz)
155	5775

### 3.2.1 Test Mode Applicability and Tested Channel Detail

EUT Configure Mode	Applicable To				Description
	RE $\geq$ 1G	RE $<$ 1G	PLC	APCM	
-	√	√	√	√	-

Where **RE $\geq$ 1G**: Radiated Emission above 1 GHz      **RE $<$ 1G**: Radiated Emission below 1 GHz  
**PLC**: Power Line Conducted Emission      **APCM**: Antenna Port Conducted Measurement

**NOTE:**

1. The EUT had been pre-tested on the positioned of each 3 axis. The worst case was found when positioned on **Y-plane**.
2. "-" means no effect.

#### **Radiated Emission Test (Above 1 GHz):**

- Pre-Scan has been conducted to determine the worst-case mode from all possible combinations between available modulations, data rates and antenna ports (if EUT with antenna diversity architecture).
- Following channel(s) was (were) selected for the final test as listed below.

EUT Configure Mode	Frequency Band (MHz)	Mode	Available Channel	Tested Channel	Modulation Technology	Modulation Type	Data Rate (Mbps)
-	5180-5240	802.11a	36 to 48	36, 44, 48	OFDM	BPSK	6.0
-		802.11n (HT20)	36 to 48	36, 44, 48	OFDM	BPSK	MCS0
-		802.11n (HT40)	38 to 46	38, 46	OFDM	BPSK	MCS0
-		802.11ac (VHT80)	42	42	OFDM	BPSK	V0
-	5260-5320	802.11a	52 to 64	52, 60, 64	OFDM	BPSK	6.0
-		802.11n (HT20)	52 to 64	52, 60, 64	OFDM	BPSK	MCS0
-		802.11n (HT40)	54 to 62	54, 62	OFDM	BPSK	MCS0
-		802.11ac (VHT80)	58	58	OFDM	BPSK	V0
-	5500-5700	802.11a	100 to 140	100, 116, 140	OFDM	BPSK	6.0
-		802.11n (HT20)	100 to 140	100, 116, 140	OFDM	BPSK	MCS0
-		802.11n (HT40)	102 to 134	102, 110, 134	OFDM	BPSK	MCS0
-		802.11ac (VHT80)	106 to 122	106, 122	OFDM	BPSK	V0
-	5745-5825	802.11a	149 to 165	149, 157, 165	OFDM	BPSK	6.0
-		802.11n (HT20)	149 to 165	149, 157, 165	OFDM	BPSK	MCS0
-		802.11n (HT40)	151 to 159	151, 159	OFDM	BPSK	MCS0
-		802.11ac (VHT80)	155	155	OFDM	BPSK	V0

#### **Radiated Emission Test (Below 1 GHz):**

- Pre-Scan has been conducted to determine the worst-case mode from all possible combinations between available modulations, data rates and antenna ports (if EUT with antenna diversity architecture).
- Following channel(s) was (were) selected for the final test as listed below.

EUT Configure Mode	Frequency Band (MHz)	Mode	Available Channel	Tested Channel	Modulation Technology	Modulation Type	Data Rate (Mbps)
-	5180-5240	802.11a	36 to 48	36	OFDM	BPSK	6.0
-	5260-5320	802.11ac (VHT80)	58	58	OFDM	BPSK	V0
-	5500-5700	802.11n (HT20)	100 to 140	100	OFDM	BPSK	MCS0
-	5745-5825	802.11n (HT40)	151 to 159	151	OFDM	BPSK	MCS0

**Power Line Conducted Emission Test:**

Pre-Scan has been conducted to determine the worst-case mode from all possible combinations between available modulations, data rates and antenna ports (if EUT with antenna diversity architecture).

Following channel(s) was (were) selected for the final test as listed below.

EUT Configure Mode	Frequency Band (MHz)	Mode	Available Channel	Tested Channel	Modulation Technology	Modulation Type	Data Rate (Mbps)
-	5745-5825	802.11n (HT40)	151 to 159	151	OFDM	BPSK	MCS0

**Antenna Port Conducted Measurement:**

This item includes all test value of each mode, but only includes spectrum plot of worst value of each mode.

Pre-Scan has been conducted to determine the worst-case mode from all possible combinations between available modulations, data rates and antenna ports (if EUT with antenna diversity architecture).

Following channel(s) was (were) selected for the final test as listed below.

EUT Configure Mode	Frequency Band (MHz)	Mode	Available Channel	Tested Channel	Modulation Technology	Modulation Type	Data Rate (Mbps)
-	5180-5240	802.11a	36 to 48	36, 44, 48	OFDM	BPSK	6.0
-		802.11n (HT20)	36 to 48	36, 44, 48	OFDM	BPSK	MCS0
-		802.11n (HT40)	38 to 46	38, 46	OFDM	BPSK	MCS0
-		802.11ac (VHT80)	42	42	OFDM	BPSK	V0
-	5260-5320	802.11a	52 to 64	52, 60, 64	OFDM	BPSK	6.0
-		802.11n (HT20)	52 to 64	52, 60, 64	OFDM	BPSK	MCS0
-		802.11n (HT40)	54 to 62	54, 62	OFDM	BPSK	MCS0
-		802.11ac (VHT80)	58	58	OFDM	BPSK	V0
-	5500-5700	802.11a	100 to 140	100, 116, 140	OFDM	BPSK	6.0
-		802.11n (HT20)	100 to 140	100, 116, 140	OFDM	BPSK	MCS0
-		802.11n (HT40)	102 to 134	102, 110, 134	OFDM	BPSK	MCS0
-		802.11ac (VHT80)	106 to 122	106, 122	OFDM	BPSK	V0
-	5745-5825	802.11a	149 to 165	149, 157, 165	OFDM	BPSK	6.0
-		802.11n (HT20)	149 to 165	149, 157, 165	OFDM	BPSK	MCS0
-		802.11n (HT40)	151 to 159	151, 159	OFDM	BPSK	MCS0
-		802.11ac (VHT80)	155	155	OFDM	BPSK	V0

**Test Condition:**

Applicable To	Environmental Conditions	Input Power	Tested by
RE $\geq$ 1G	25 deg. C, 65 % RH	120 Vac, 60 Hz	Toby Tian
RE $<$ 1G	25 deg. C, 65 % RH	120 Vac, 60 Hz	Toby Tian
PLC	25 deg. C, 65 % RH	120 Vac, 60 Hz	Toby Tian
APCM	25 deg. C, 65 % RH	3.8 Vdc	Luke Chen

### 3.3 Duty Cycle of Test Signal

#### MODULATION TYPE: BPSK

Duty cycle of test signal is < 98 %, duty factor is required.

**802.11a:** Duty cycle =  $2.027/2.540 = 0.798$ , Duty factor =  $10 * \log(1/0.798) = 0.98$

**802.11n (HT20):** Duty cycle =  $1.883/2.396 = 0.786$ , Duty factor =  $10 * \log(1/0.786) = 1.05$

**802.11n (HT40):** Duty cycle =  $897.44/1426.28 = 0.629$ , Duty factor =  $10 * \log(1/0.629) = 2.01$

**802.11ac (VHT80):** Duty cycle =  $208.33/745.19 = 0.280$ , Duty factor =  $10 * \log(1/0.280) = 5.53$

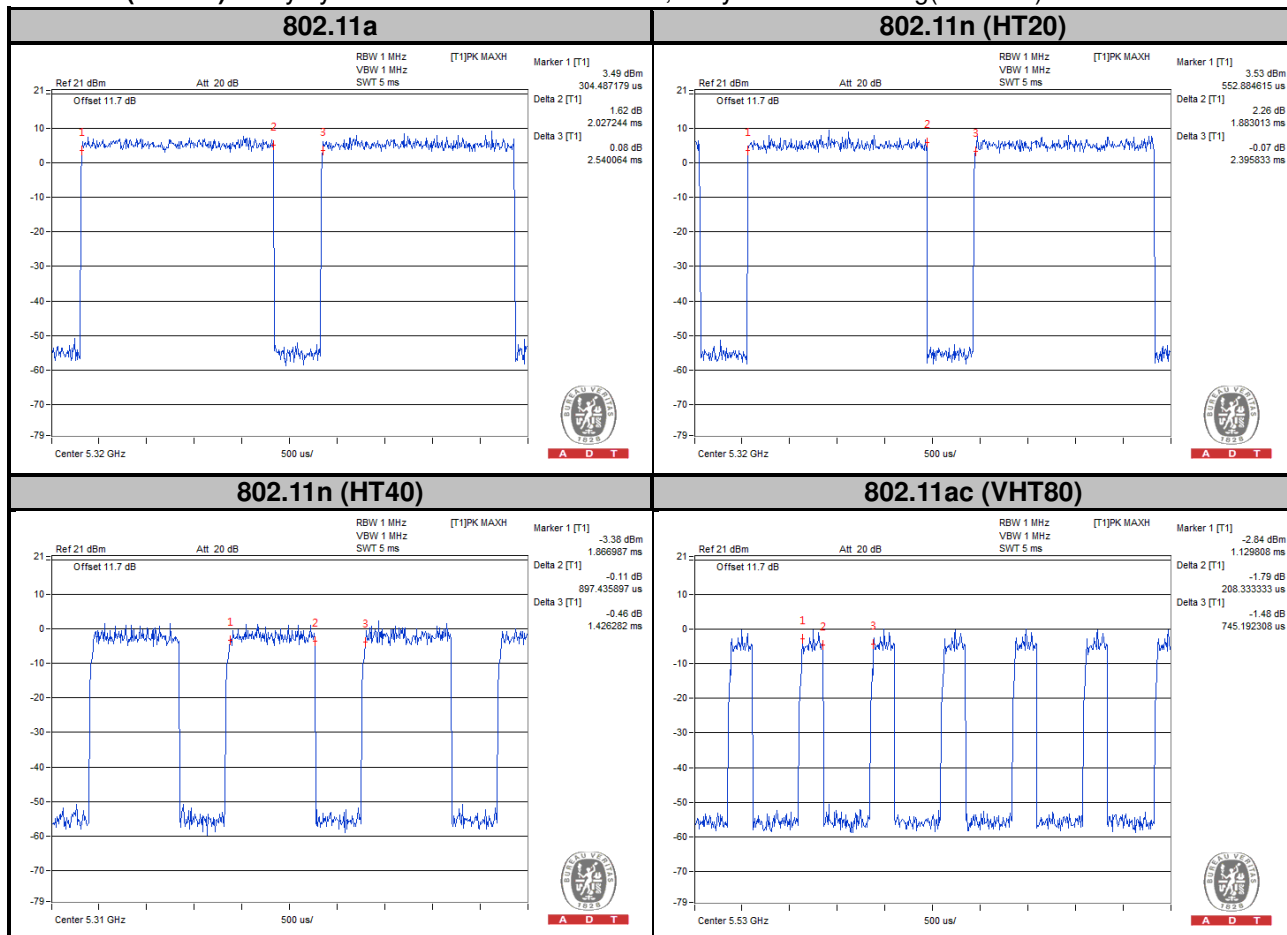

**MODULATION TYPE: QPSK**

Duty cycle of test signal is < 98 %, duty factor is required.

**802.11a:** Duty cycle =  $1.018/1.538 = 0.662$ , Duty factor =  $10 * \log(1/0.662) = 1.79$

**802.11n (HT20):** Duty cycle =  $953.53/1466.35 = 0.650$ , Duty factor =  $10 * \log(1/0.650) = 1.87$

**802.11n (HT40):** Duty cycle =  $456.73/985.58 = 0.463$ , Duty factor =  $10 * \log(1/0.463) = 3.34$

**802.11ac (VHT80):** Duty cycle =  $112.18/649.04 = 0.173$ , Duty factor =  $10 * \log(1/0.173) = 7.62$



**MODULATION TYPE: 16QAM**

Duty cycle of test signal is < 98 %, duty factor is required.

**802.11a:** Duty cycle =  $512.82/1025.64 = 0.5$ , Duty factor =  $10 * \log(1/0.5) = 3.01$

**802.11n (HT20):** Duty cycle =  $488.78/1001.60 = 0.488$ , Duty factor =  $10 * \log(1/0.488) = 3.12$

**802.11n (HT40):** Duty cycle =  $232.37/761.22 = 0.305$ , Duty factor =  $10 * \log(1/0.305) = 5.15$

**802.11ac (VHT80):** Duty cycle =  $56.09/592.95 = 0.095$ , Duty factor =  $10 * \log(1/0.095) = 10.24$

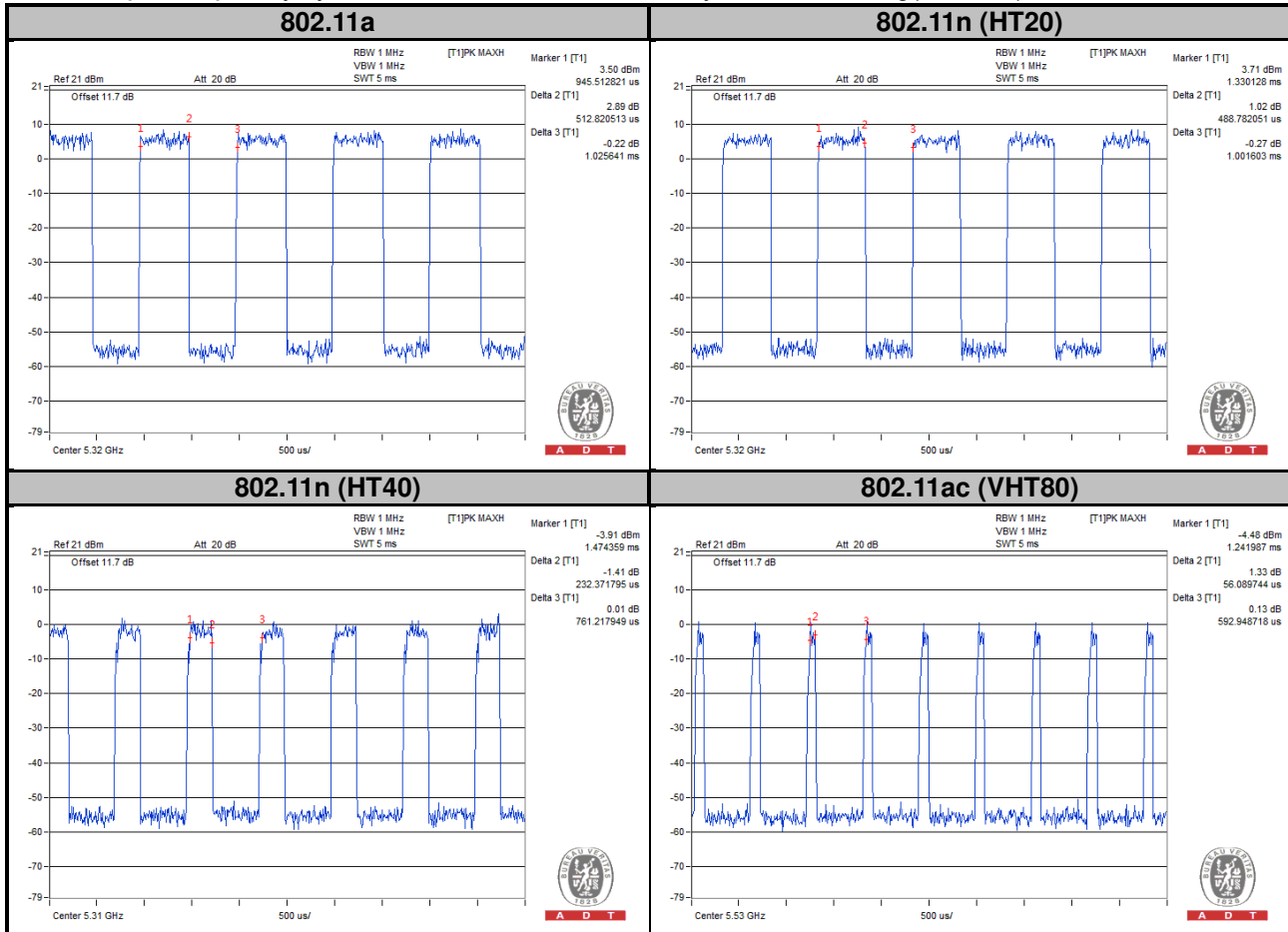

**MODULATION TYPE: 64QAM**

Duty cycle of test signal is < 98 %, duty factor is required.

**802.11a:** Duty cycle =  $264.42/769.23 = 0.344$ , Duty factor =  $10 * \log(1/0.344) = 4.64$

**802.11n (HT20):** Duty cycle =  $256.41/769.23 = 0.333$ , Duty factor =  $10 * \log(1/0.333) = 4.77$

**802.11n (HT40):** Duty cycle =  $112.18/649.04 = 0.173$ , Duty factor =  $10 * \log(1/0.173) = 7.62$

**802.11ac (VHT80):** Duty cycle =  $32.05/568.91 = 0.056$ , Duty factor =  $10 * \log(1/0.056) = 12.49$

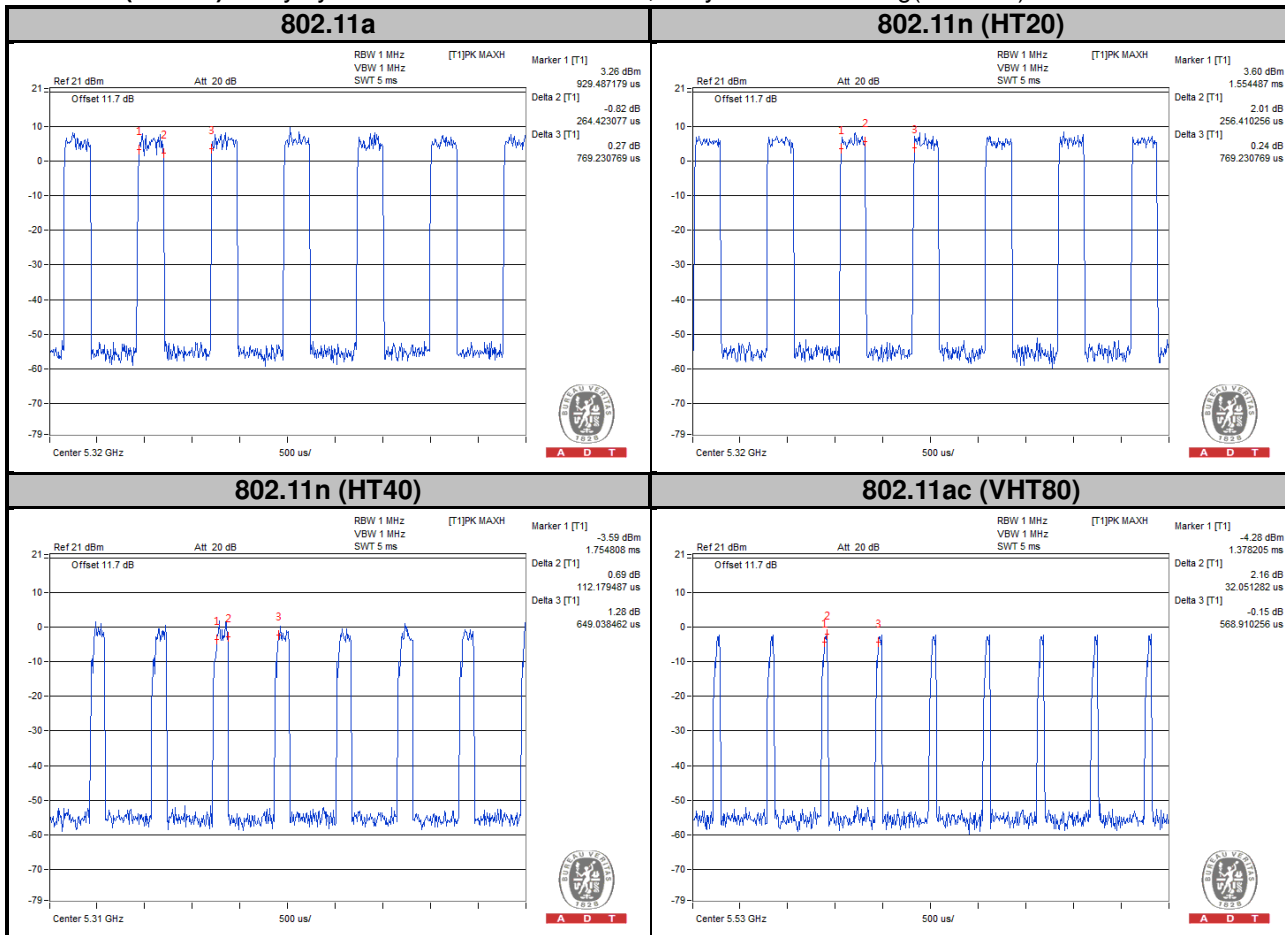

**MODULATION TYPE: 256QAM**

Duty cycle of test signal is < 98 %, duty factor is required.

**802.11ac (VHT80):** Duty cycle =  $24.04/560.90 = 0.043$ , Duty factor =  $10 * \log(1/0.043) = 13.68$

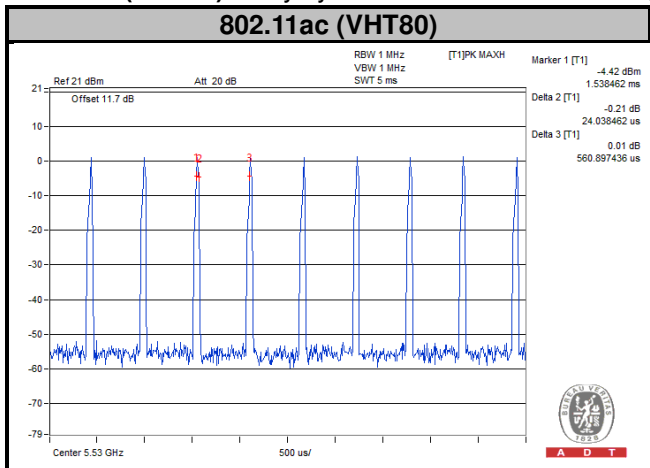



### 3.4 Description of Support Units

The EUT has been tested as an independent unit together with other necessary accessories or support units. The following support units or accessories were used to form a representative test configuration during the tests.

No.	Product	Brand	Model No.	Serial No.	FCC ID
1.	Earphone	GaLien Electron	HF-HB05D	N/A	N/A

No.	Signal Cable Description Of The Above Support Units
1.	N/A

Note:

1. All power cords of the above support units are non-shielded (1.8m).

#### 3.4.1 Configuration of System under Test

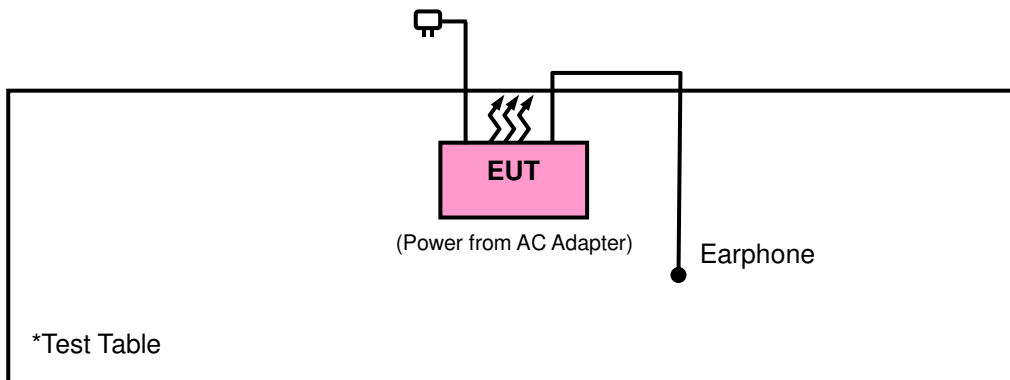

### 3.5 General Description of Applied Standards

The EUT is a RF Product. According to the specifications of the manufacturer, it must comply with the requirements of the following standards:

**FCC Part 15, Subpart E (15.407)**

**789033 D02 General UNII Test Procedures New Rules v01r02**

ANSI C63.10-2013

All test items have been performed and recorded as per the above standards.

**NOTE:** The EUT has been verified to comply with the requirements of FCC Part 15, Subpart B, Class B (DoC).  
The test report has been issued separately.

## 4 Test Types and Results

### 4.1 Radiated Emission and Bandedge Measurement

#### 4.1.1 Limits of Radiated Emission and Bandedge Measurement

Radiated emissions which fall in the restricted bands must comply with the radiated emission limits specified as below table. Other emissions shall be at least 20 dB below the highest level of the desired power:

Frequencies (MHz)	Field Strength (microvolts/meter)	Measurement Distance (meters)
0.009 ~ 0.490	2400/F (kHz)	300
0.490 ~ 1.705	24000/F (kHz)	30
1.705 ~ 30.0	30	30
30 ~ 88	100	3
88 ~ 216	150	3
216 ~ 960	200	3
Above 960	500	3

#### NOTE:

1. The lower limit shall apply at the transition frequencies.
2. Emission level (dBuV/m) = 20 log Emission level (uV/m).
3. For frequencies above 1000 MHz, the field strength limits are based on average detector, however, the peak field strength of any emission shall not exceed the maximum permitted average limits, specified above by more than 20 dB under any condition of modulation.

#### 4.1.2 Limits of Unwanted Emission Out of the Restricted Bands

Applicable To	Limit	
789033 D02 General UNII Test Procedures New Rules v01r02	Field Strength at 3 m	
	PK: 74 (dBμV/m)	AV: 54 (dBμV/m)
Applicable To	EIRP Limit	Equivalent Field Strength at 3 m
15.407(b)(1)	PK: -27 (dBm/MHz)	PK: 68.2 (dBμV/m)
15.407(b)(2)		
15.407(b)(3)		
15.407(b)(4)	PK: -27 (dBm/MHz) <sup>*1</sup> PK: -17 (dBm/MHz) <sup>*2</sup>	PK: 68.2 (dBμV/m) <sup>*1</sup> PK: 78.2 (dBμV/m) <sup>*2</sup>

**NOTE:** <sup>\*1</sup> beyond 10 MHz of the band edge <sup>\*2</sup> within 10 MHz of band edge

The following formula is used to convert the equipment isotropic radiated power (eirp) to field strength:

$$E = \frac{1000000\sqrt{30P}}{3} \mu\text{V/m, where } P \text{ is the eirp (Watts).}$$

#### 4.1.3 Test Instruments

Description & Manufacturer	Model No.	Serial No.	Date of Calibration	Due Date of Calibration
Test Receiver Agilent	N9038A	MY51210203	Jan. 21, 2016	Jan. 20, 2017
Spectrum Analyzer Agilent	N9010A	MY52220314	Sep. 03, 2015	Sep. 02, 2016
Spectrum Analyzer ROHDE & SCHWARZ	FSU43	101261	Dec. 17, 2015	Dec. 16, 2016
BILOG Antenna SCHWARZBECK	VULB9168	9168-472	Jan. 07, 2016	Jan. 06, 2017
HORN Antenna SCHWARZBECK	BBHA 9120 D	9120D-969	Jan. 04, 2016	Jan. 03, 2017
HORN Antenna SCHWARZBECK	BBHA 9170	9170-480	Jan. 08, 2016	Jan. 07, 2017
Loop Antenna	EM-6879	269	Jul. 31, 2015	Jul. 30, 2016
Bluetooth Tester	CBT	100980	Apr. 27, 2015	Apr. 26, 2017
Agilent Communications Tester-Wireless	8960 Series 10	MY53201073	Jul. 03, 2015	Jul. 02, 2017
Preamplifier EMCI	EMC 012645	980115	Dec. 21, 2015	Dec. 20, 2016
Preamplifier EMCI	EMC 184045	980116	Dec. 21, 2015	Dec. 20, 2016
Preamplifier EMCI	EMC 330H	980112	Dec. 28, 2015	Dec. 27, 2016
Power Meter Anritsu	ML2495A	1232002	Sep. 21, 2015	Sep. 20, 2016
Power Sensor Anritsu	MA2411B	1207325	Sep. 21, 2015	Sep. 20, 2016
RF signal cable HUBER+SUHNNER	SUCOFLEX 104	309219/4 2950114	Oct. 12, 2015	Oct. 11, 2016
RF signal cable HUBER+SUHNNER	SUCOFLEX 104	250130/4	Oct. 12, 2015	Oct. 11, 2016
RF Coaxial Cable Worken	8D-FB	Cable-Ch10-01	Oct. 12, 2015	Oct. 11, 2016
Software BV ADT	E3 6.120103	NA	NA	NA
Antenna Tower MF	MFA-440H	NA	NA	NA
Turn Table MF	MFT-201SS	NA	NA	NA
Antenna Tower & Turn Table Controller MF	MF-7802	NA	NA	NA

- Note: 1. The calibration interval of the above test instruments is 12 / 24 months and the calibrations are traceable to NML/ROC and NIST/USA.
2. The test was performed in HwaYa Chamber 10.
3. The horn antenna and preamplifier (model: EMC 184045) are used only for the measurement of emission frequency above 1 GHz if tested.
4. The FCC Site Registration No. is 690701.
5. The IC Site Registration No. is IC7450F-10.

#### 4.1.4 Test Procedures

- a. The EUT was placed on the top of a rotating table 0.8 meters (for below 1 GHz) / 1.5 meters (for above 1 GHz) above the ground at 3 meter chamber room for test. The table was rotated 360 degrees to determine the position of the highest radiation.
- b. The EUT was set 3 meters away from the interference-receiving antenna, which was mounted on the top of a variable-height antenna tower.
- c. The height of antenna is varied from one meter to four meters above the ground to determine the maximum value of the field strength. Both horizontal and vertical polarizations of the antenna are set to make the measurement.
- d. For each suspected emission, the EUT was arranged to its worst case and then the antenna was tuned to heights from 1 meter to 4 meters and the rotatable table was turned from 0 degrees to 360 degrees to find the maximum reading.
- e. The test-receiver system was set to quasi-peak detect function and specified bandwidth with maximum hold mode when the test frequency is below 1 GHz.
- f. The test-receiver system was set to peak and average detected function and specified bandwidth with maximum hold mode when the test frequency is above 1 GHz. If the peak reading value also meets average limit, measurement with the average detector is unnecessary.

**Note:**

1. The resolution bandwidth and video bandwidth of test receiver/spectrum analyzer is 120 kHz for Quasi-peak detection (QP) at frequency below 1 GHz.
2. The resolution bandwidth of test receiver/spectrum analyzer is 1 MHz and the video bandwidth is 3 MHz for Peak detection (PK) at frequency above 1 GHz.
3. The resolution bandwidth of test receiver/spectrum analyzer is 1 MHz and the video bandwidth is 3 MHz for RMS Average (Duty cycle < 98 %) for Average detection (AV) at frequency above 1 GHz, then the measurement results was added to a correction factor ( $10 \log(1/\text{duty cycle})$ ).
4. The resolution bandwidth of test receiver/spectrum analyzer is 1 MHz and the video bandwidth is 10 Hz (Duty cycle  $\geq 98$  %) for Average detection (AV) at frequency above 1 GHz.
5. All modes of operation were investigated and the worst-case emissions are reported.

#### 4.1.5 Deviation from Test Standard

No deviation.

#### 4.1.6 Test Set Up

##### <Frequency Range below 1 GHz>

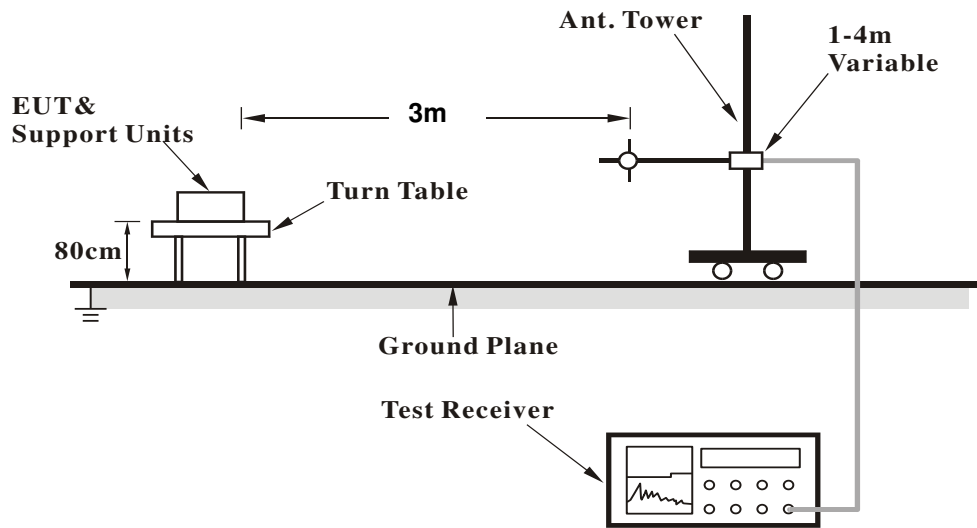

##### <Frequency Range above 1 GHz>

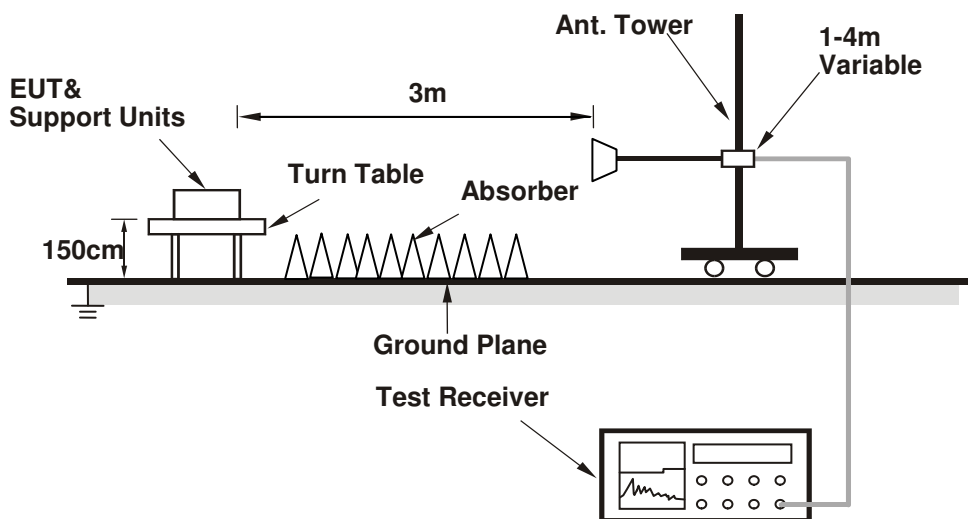

For the actual test configuration, please refer to the attached file (Test Setup Photo).

#### 4.1.7 EUT Operating Conditions

- Placed the EUT on a testing table.
- Use the software to control the EUT under transmission condition continuously at specific channel frequency.

4.1.8 Test Results  
 Above 1 GHz Data :  
 802.11a

EUT Test Condition		Measurement Detail	
Channel	Channel 36	Frequency Range	1 GHz ~ 40 GHz
Input Power	120 Vac, 60 Hz	Detector Function	Peak (PK) Average (AV)
Environmental Conditions	25 deg. C, 65 % RH	Tested By	Toby Tian

Antenna Polarity & Test Distance: Horizontal at 3 m										
Frequency (MHz)	Emission Level (dBuV/m)	Read Level (dBuV)	Limit (dBuV/m)	Margin (dB)	Antenna Factor (dB/m)	Cable Loss (dB)	Preamp Factor (dB)	Antenna Height (cm)	Table Angle (Degree)	Remark
5022	43.05	42.91	54	-10.95	31.23	6.15	37.24	201	235	Average
5022	60.18	60.04	74	-13.82	31.23	6.15	37.24	201	235	Peak
5180	95.52	95.29			31.35	6.22	37.34	201	235	Average
5180	104.78	104.55			31.35	6.22	37.34	201	235	Peak
5458	38.57	37.75	54	-15.43	31.56	6.34	37.08	201	235	Average
5458	59.81	58.99	74	-14.19	31.56	6.34	37.08	201	235	Peak

Antenna Polarity & Test Distance: Vertical at 3 m										
Frequency (MHz)	Emission Level (dBuV/m)	Read Level (dBuV)	Limit (dBuV/m)	Margin (dB)	Antenna Factor (dB/m)	Cable Loss (dB)	Preamp Factor (dB)	Antenna Height (cm)	Table Angle (Degree)	Remark
5132	41.99	41.78	54	-12.01	31.31	6.2	37.3	199	211	Average
5132	60.8	60.59	74	-13.2	31.31	6.2	37.3	199	211	Peak
5180	95.18	94.95			31.35	6.22	37.34	199	211	Average
5180	105.08	104.85			31.35	6.22	37.34	199	211	Peak
5426	38.51	37.79	54	-15.49	31.53	6.32	37.13	199	211	Average
5426	60.29	59.57	74	-13.71	31.53	6.32	37.13	199	211	Peak

Remarks:

- Emission Level = Read Level + Antenna Factor + Cable Loss - Preamp Factor  
 Margin value = Emission level – Limit value
- 5180 MHz: Fundamental Frequency

EUT Test Condition		Measurement Detail	
Channel	Channel 44	Frequency Range	1 GHz ~ 40 GHz
Input Power	120 Vac, 60 Hz	Detector Function	Peak (PK) Average (AV)
Environmental Conditions	25 deg. C, 65 % RH	Tested By	Toby Tian

Antenna Polarity & Test Distance: Horizontal at 3 m										
Frequency (MHz)	Emission Level (dBuV/m)	Read Level (dBuV)	Limit (dBuV/m)	Margin (dB)	Antenna Factor (dB/m)	Cable Loss (dB)	Preamp Factor (dB)	Antenna Height (cm)	Table Angle (Degree)	Remark
5012	38.53	38.42	54	-15.47	31.21	6.13	37.23	200	236	Average
5012	60.53	60.42	74	-13.47	31.21	6.13	37.23	200	236	Peak
5220	97.92	97.67			31.37	6.24	37.36	200	236	Average
5220	107.14	106.89			31.37	6.24	37.36	200	236	Peak
5446	38.79	38.02	54	-15.21	31.56	6.34	37.13	200	236	Average
5446	59.45	58.68	74	-14.55	31.56	6.34	37.13	200	236	Peak

Antenna Polarity & Test Distance: Vertical at 3 m										
Frequency (MHz)	Emission Level (dBuV/m)	Read Level (dBuV)	Limit (dBuV/m)	Margin (dB)	Antenna Factor (dB/m)	Cable Loss (dB)	Preamp Factor (dB)	Antenna Height (cm)	Table Angle (Degree)	Remark
5008	38.33	38.22	54	-15.67	31.21	6.13	37.23	197	214	Average
5008	60.48	60.37	74	-13.52	31.21	6.13	37.23	197	214	Peak
5220	98.14	97.89			31.37	6.24	37.36	197	214	Average
5220	107.24	106.99			31.37	6.24	37.36	197	214	Peak
5392	38.63	37.99	54	-15.37	31.51	6.31	37.18	197	214	Average
5392	60.06	59.42	74	-13.94	31.51	6.31	37.18	197	214	Peak

Remarks:

- Emission Level = Read Level + Antenna Factor + Cable Loss - Preamp Factor  
Margin value = Emission level – Limit value
- 5220 MHz: Fundamental Frequency



EUT Test Condition		Measurement Detail	
Channel	Channel 48	Frequency Range	1 GHz ~ 40 GHz
Input Power	120 Vac, 60 Hz	Detector Function	Peak (PK) Average (AV)
Environmental Conditions	25 deg. C, 65 % RH	Tested By	Toby Tian

Antenna Polarity & Test Distance: Horizontal at 3 m										
Frequency (MHz)	Emission Level (dBuV/m)	Read Level (dBuV)	Limit (dBuV/m)	Margin (dB)	Antenna Factor (dB/m)	Cable Loss (dB)	Preamp Factor (dB)	Antenna Height (cm)	Table Angle (Degree)	Remark
5144	38.87	38.67	54	-15.13	31.32	6.2	37.32	197	240	Average
5144	60.08	59.88	74	-13.92	31.32	6.2	37.32	197	240	Peak
5240	98.14	97.82			31.39	6.25	37.32	197	240	Average
5240	107.12	106.8			31.39	6.25	37.32	197	240	Peak
5432	38.74	38	54	-15.26	31.55	6.32	37.13	197	240	Average
5432	59.66	58.92	74	-14.34	31.55	6.32	37.13	197	240	Peak
Antenna Polarity & Test Distance: Vertical at 3 m										
Frequency (MHz)	Emission Level (dBuV/m)	Read Level (dBuV)	Limit (dBuV/m)	Margin (dB)	Antenna Factor (dB/m)	Cable Loss (dB)	Preamp Factor (dB)	Antenna Height (cm)	Table Angle (Degree)	Remark
5034	38.34	38.2	54	-15.66	31.23	6.15	37.24	205	219	Average
5034	59.98	59.84	74	-14.02	31.23	6.15	37.24	205	219	Peak
5240	98.15	97.83			31.39	6.25	37.32	205	219	Average
5240	107.15	106.83			31.39	6.25	37.32	205	219	Peak
5370	38.77	38.15	54	-15.23	31.49	6.31	37.18	205	219	Average
5370	59.71	59.09	74	-14.29	31.49	6.31	37.18	205	219	Peak

Remarks:

- Emission Level = Read Level + Antenna Factor + Cable Loss - Preamp Factor  
Margin value = Emission level – Limit value
- 5240 MHz: Fundamental Frequency

EUT Test Condition		Measurement Detail	
Channel	Channel 52	Frequency Range	1 GHz ~ 40 GHz
Input Power	120 Vac, 60 Hz	Detector Function	Peak (PK) Average (AV)
Environmental Conditions	25 deg. C, 65 % RH	Tested By	Toby Tian

Antenna Polarity & Test Distance: Horizontal at 3 m										
Frequency (MHz)	Emission Level (dBuV/m)	Read Level (dBuV)	Limit (dBuV/m)	Margin (dB)	Antenna Factor (dB/m)	Cable Loss (dB)	Preamp Factor (dB)	Antenna Height (cm)	Table Angle (Degree)	Remark
5092	38.62	38.42	54	-15.38	31.28	6.19	37.27	200	239	Average
5092	60.59	60.39	74	-13.41	31.28	6.19	37.27	200	239	Peak
5260	97.44	97.05			31.41	6.25	37.27	200	239	Average
5260	107.6	107.21			31.41	6.25	37.27	200	239	Peak
5458	38.78	37.96	54	-15.22	31.56	6.34	37.08	200	239	Average
5458	61.76	60.94	74	-12.24	31.56	6.34	37.08	200	239	Peak

Antenna Polarity & Test Distance: Vertical at 3 m										
Frequency (MHz)	Emission Level (dBuV/m)	Read Level (dBuV)	Limit (dBuV/m)	Margin (dB)	Antenna Factor (dB/m)	Cable Loss (dB)	Preamp Factor (dB)	Antenna Height (cm)	Table Angle (Degree)	Remark
5002	38.33	38.23	54	-15.67	31.2	6.13	37.23	202	214	Average
5002	60.02	59.92	74	-13.98	31.2	6.13	37.23	202	214	Peak
5260	96.31	95.92			31.41	6.25	37.27	202	214	Average
5260	106.12	105.73			31.41	6.25	37.27	202	214	Peak
5460	38.84	38.02	54	-15.16	31.56	6.34	37.08	202	214	Average
5460	61.26	60.44	74	-12.74	31.56	6.34	37.08	202	214	Peak

Remarks:

- Emission Level = Read Level + Antenna Factor + Cable Loss - Preamp Factor  
Margin value = Emission level – Limit value
- 5260 MHz: Fundamental Frequency

EUT Test Condition		Measurement Detail	
Channel	Channel 60	Frequency Range	1 GHz ~ 40 GHz
Input Power	120 Vac, 60 Hz	Detector Function	Peak (PK) Average (AV)
Environmental Conditions	25 deg. C, 65 % RH	Tested By	Toby Tian

Antenna Polarity & Test Distance: Horizontal at 3 m										
Frequency (MHz)	Emission Level (dBuV/m)	Read Level (dBuV)	Limit (dBuV/m)	Margin (dB)	Antenna Factor (dB/m)	Cable Loss (dB)	Preamp Factor (dB)	Antenna Height (cm)	Table Angle (Degree)	Remark
5136	38.43	38.22	54	-15.57	31.31	6.2	37.3	180	236	Average
5136	61.2	60.99	74	-12.8	31.31	6.2	37.3	180	236	Peak
5300	97.72	97.2			31.44	6.27	37.19	180	236	Average
5300	107.1	106.58			31.44	6.27	37.19	180	236	Peak
5382	38.99	38.35	54	-15.01	31.51	6.31	37.18	180	236	Average
5382	60.63	59.99	74	-13.37	31.51	6.31	37.18	180	236	Peak
Antenna Polarity & Test Distance: Vertical at 3 m										
Frequency (MHz)	Emission Level (dBuV/m)	Read Level (dBuV)	Limit (dBuV/m)	Margin (dB)	Antenna Factor (dB/m)	Cable Loss (dB)	Preamp Factor (dB)	Antenna Height (cm)	Table Angle (Degree)	Remark
5054	38.31	38.15	54	-15.69	31.24	6.17	37.25	166	209	Average
5054	59.94	59.78	74	-14.06	31.24	6.17	37.25	166	209	Peak
5300	96.82	96.3			31.44	6.27	37.19	166	209	Average
5300	106.23	105.71			31.44	6.27	37.19	166	209	Peak
5442	38.66	37.9	54	-15.34	31.55	6.34	37.13	166	209	Average
5442	60.46	59.7	74	-13.54	31.55	6.34	37.13	166	209	Peak

Remarks:

- Emission Level = Read Level + Antenna Factor + Cable Loss - Preamp Factor  
Margin value = Emission level – Limit value
- 5300 MHz: Fundamental Frequency

EUT Test Condition		Measurement Detail	
Channel	Channel 64	Frequency Range	1 GHz ~ 40 GHz
Input Power	120 Vac, 60 Hz	Detector Function	Peak (PK) Average (AV)
Environmental Conditions	25 deg. C, 65 % RH	Tested By	Toby Tian

Antenna Polarity & Test Distance: Horizontal at 3 m										
Frequency (MHz)	Emission Level (dBuV/m)	Read Level (dBuV)	Limit (dBuV/m)	Margin (dB)	Antenna Factor (dB/m)	Cable Loss (dB)	Preamp Factor (dB)	Antenna Height (cm)	Table Angle (Degree)	Remark
5078	38.37	38.2	54	-15.63	31.27	6.17	37.27	168	237	Average
5078	60.23	60.06	74	-13.77	31.27	6.17	37.27	168	237	Peak
5320	96.46	95.91			31.45	6.29	37.19	168	237	Average
5320	107.8	107.25			31.45	6.29	37.19	168	237	Peak
5448	39.72	38.95	54	-14.28	31.56	6.34	37.13	168	237	Average
5448	60.53	59.76	74	-13.47	31.56	6.34	37.13	168	237	Peak
Antenna Polarity & Test Distance: Vertical at 3 m										
Frequency (MHz)	Emission Level (dBuV/m)	Read Level (dBuV)	Limit (dBuV/m)	Margin (dB)	Antenna Factor (dB/m)	Cable Loss (dB)	Preamp Factor (dB)	Antenna Height (cm)	Table Angle (Degree)	Remark
5086	38.27	38.1	54	-15.73	31.27	6.17	37.27	191	217	Average
5086	61.28	61.11	74	-12.72	31.27	6.17	37.27	191	217	Peak
5320	95.04	94.49			31.45	6.29	37.19	191	217	Average
5320	106.08	105.53			31.45	6.29	37.19	191	217	Peak
5456	38.94	38.12	54	-15.06	31.56	6.34	37.08	191	217	Average
5456	59.71	58.89	74	-14.29	31.56	6.34	37.08	191	217	Peak

Remarks:

- Emission Level = Read Level + Antenna Factor + Cable Loss - Preamp Factor  
Margin value = Emission level – Limit value
- 5320 MHz: Fundamental Frequency

EUT Test Condition		Measurement Detail	
Channel	Channel 100	Frequency Range	1 GHz ~ 40 GHz
Input Power	120 Vac, 60 Hz	Detector Function	Peak (PK) Average (AV)
Environmental Conditions	25 deg. C, 65 % RH	Tested By	Toby Tian

Antenna Polarity & Test Distance: Horizontal at 3 m										
Frequency (MHz)	Emission Level (dBuV/m)	Read Level (dBuV)	Limit (dBuV/m)	Margin (dB)	Antenna Factor (dB/m)	Cable Loss (dB)	Preamp Factor (dB)	Antenna Height (cm)	Table Angle (Degree)	Remark
5370	42.02	41.4	54	-11.98	31.49	6.31	37.18	166	239	Average
5370	60.54	59.92	74	-13.46	31.49	6.31	37.18	166	239	Peak
5470	59.15	58.32	68.2	-9.05	31.57	6.34	37.08	166	239	Peak
5500	92.37	91.44			31.6	6.36	37.03	166	239	Average
5500	102.18	101.25			31.6	6.36	37.03	166	239	Peak
5725	58.66	57.38	68.2	-9.54	31.96	6.75	37.43	166	239	Peak
Antenna Polarity & Test Distance: Vertical at 3 m										
Frequency (MHz)	Emission Level (dBuV/m)	Read Level (dBuV)	Limit (dBuV/m)	Margin (dB)	Antenna Factor (dB/m)	Cable Loss (dB)	Preamp Factor (dB)	Antenna Height (cm)	Table Angle (Degree)	Remark
5454	41.09	40.27	54	-12.91	31.56	6.34	37.08	188	266	Average
5454	60.91	60.09	74	-13.09	31.56	6.34	37.08	188	266	Peak
5470	58.03	57.2	68.2	-10.17	31.57	6.34	37.08	188	266	Peak
5500	91.66	90.73			31.6	6.36	37.03	188	266	Average
5500	101.27	100.34			31.6	6.36	37.03	188	266	Peak
5725	59.57	58.29	68.2	-8.63	31.96	6.75	37.43	188	266	Peak

Remarks:

- Emission Level = Read Level + Antenna Factor + Cable Loss - Preamp Factor  
Margin value = Emission level – Limit value
- 5500 MHz: Fundamental Frequency
- 5470 MHz & 5725 MHz: Out of Restricted Band

EUT Test Condition		Measurement Detail	
Channel	Channel 116	Frequency Range	1 GHz ~ 40 GHz
Input Power	120 Vac, 60 Hz	Detector Function	Peak (PK) Average (AV)
Environmental Conditions	25 deg. C, 65 % RH	Tested By	Toby Tian

Antenna Polarity & Test Distance: Horizontal at 3 m										
Frequency (MHz)	Emission Level (dBuV/m)	Read Level (dBuV)	Limit (dBuV/m)	Margin (dB)	Antenna Factor (dB/m)	Cable Loss (dB)	Preamp Factor (dB)	Antenna Height (cm)	Table Angle (Degree)	Remark
5400	38.71	38.05	54	-15.29	31.52	6.32	37.18	163	244	Average
5400	60.48	59.82	74	-13.52	31.52	6.32	37.18	163	244	Peak
5470	57.82	56.99	68.2	-10.38	31.57	6.34	37.08	163	244	Peak
5580	96.02	94.98			31.71	6.49	37.16	163	244	Average
5580	106.56	105.52			31.71	6.49	37.16	163	244	Peak
5725	58.14	56.86	68.2	-10.06	31.96	6.75	37.43	163	244	Peak
Antenna Polarity & Test Distance: Vertical at 3 m										
Frequency (MHz)	Emission Level (dBuV/m)	Read Level (dBuV)	Limit (dBuV/m)	Margin (dB)	Antenna Factor (dB/m)	Cable Loss (dB)	Preamp Factor (dB)	Antenna Height (cm)	Table Angle (Degree)	Remark
5456	38.71	37.89	54	-15.29	31.56	6.34	37.08	189	265	Average
5456	60.19	59.37	74	-13.81	31.56	6.34	37.08	189	265	Peak
5470	57.33	56.5	68.2	-10.87	31.57	6.34	37.08	189	265	Peak
5580	95.83	94.79			31.71	6.49	37.16	189	265	Average
5580	105.23	104.19			31.71	6.49	37.16	189	265	Peak
5725	58.83	57.55	68.2	-9.37	31.96	6.75	37.43	189	265	Peak

Remarks:

- Emission Level = Read Level + Antenna Factor + Cable Loss - Preamp Factor  
Margin value = Emission level – Limit value
- 5580 MHz: Fundamental Frequency
- 5470 MHz & 5725 MHz: Out of Restricted Band

EUT Test Condition		Measurement Detail	
Channel	Channel 140	Frequency Range	1 GHz ~ 40 GHz
Input Power	120 Vac, 60 Hz	Detector Function	Peak (PK) Average (AV)
Environmental Conditions	25 deg. C, 65 % RH	Tested By	Toby Tian

Antenna Polarity & Test Distance: Horizontal at 3 m										
Frequency (MHz)	Emission Level (dBuV/m)	Read Level (dBuV)	Limit (dBuV/m)	Margin (dB)	Antenna Factor (dB/m)	Cable Loss (dB)	Preamp Factor (dB)	Antenna Height (cm)	Table Angle (Degree)	Remark
5398	38.61	37.95	54	-15.39	31.52	6.32	37.18	186	234	Average
5398	61.16	60.5	74	-12.84	31.52	6.32	37.18	186	234	Peak
5470	58.49	57.66	68.2	-9.71	31.57	6.34	37.08	186	234	Peak
5700	94.72	93.53			31.9	6.69	37.4	186	234	Average
5700	104.89	103.7			31.9	6.69	37.4	186	234	Peak
5725	59.04	57.76	68.2	-9.16	31.96	6.75	37.43	186	234	Peak
Antenna Polarity & Test Distance: Vertical at 3 m										
Frequency (MHz)	Emission Level (dBuV/m)	Read Level (dBuV)	Limit (dBuV/m)	Margin (dB)	Antenna Factor (dB/m)	Cable Loss (dB)	Preamp Factor (dB)	Antenna Height (cm)	Table Angle (Degree)	Remark
5458	38.62	37.8	54	-15.38	31.56	6.34	37.08	181	185	Average
5458	60.41	59.59	74	-13.59	31.56	6.34	37.08	181	185	Peak
5470	57.02	56.19	68.2	-11.18	31.57	6.34	37.08	181	185	Peak
5700	93.41	92.22			31.9	6.69	37.4	181	185	Average
5700	103	101.81			31.9	6.69	37.4	181	185	Peak
5725	60.5	59.22	68.2	-7.7	31.96	6.75	37.43	181	185	Peak

Remarks:

- Emission Level = Read Level + Antenna Factor + Cable Loss - Preamp Factor  
Margin value = Emission level – Limit value
- 5700 MHz: Fundamental Frequency
- 5470 MHz & 5725 MHz: Out of Restricted Band

EUT Test Condition		Measurement Detail	
Channel	Channel 149	Frequency Range	1 GHz ~ 40 GHz
Input Power	120 Vac, 60 Hz	Detector Function	Peak (PK) Average (AV)
Environmental Conditions	25 deg. C, 65 % RH	Tested By	Toby Tian

Antenna Polarity & Test Distance: Horizontal at 3 m										
Frequency (MHz)	Emission Level (dBuV/m)	Read Level (dBuV)	Limit (dBuV/m)	Margin (dB)	Antenna Factor (dB/m)	Cable Loss (dB)	Preamp Factor (dB)	Antenna Height (cm)	Table Angle (Degree)	Remark
*5714	59.55	58.36	68.2	-8.65	31.93	6.69	37.43	206	236	Peak
*5725	61.05	59.77	78.2	-17.15	31.96	6.75	37.43	206	236	Peak
5745	92.08	90.81			31.99	6.75	37.47	206	236	Average
5745	101.55	100.28			31.99	6.75	37.47	206	236	Peak
*5850	61.01	59.49	78.2	-17.19	32.15	6.88	37.51	206	236	Peak
*5861	59.63	58	68.2	-8.57	32.18	6.95	37.5	206	236	Peak
Antenna Polarity & Test Distance: Vertical at 3 m										
Frequency (MHz)	Emission Level (dBuV/m)	Read Level (dBuV)	Limit (dBuV/m)	Margin (dB)	Antenna Factor (dB/m)	Cable Loss (dB)	Preamp Factor (dB)	Antenna Height (cm)	Table Angle (Degree)	Remark
*5714	58.94	57.75	68.2	-9.26	31.93	6.69	37.43	212	166	Peak
*5725	59.77	58.49	78.2	-18.43	31.96	6.75	37.43	212	166	Peak
5745	90.83	89.56			31.99	6.75	37.47	212	166	Average
5745	100.9	99.63			31.99	6.75	37.47	212	166	Peak
*5850	60.2	58.68	78.2	-18	32.15	6.88	37.51	212	166	Peak
*5861	59.95	58.32	68.2	-8.25	32.18	6.95	37.5	212	166	Peak

Remarks:

- Emission Level = Read Level + Antenna Factor + Cable Loss - Preamp Factor  
Margin value = Emission level – Limit value
- 5745 MHz: Fundamental Frequency
- \*: Out of Restricted Band



EUT Test Condition		Measurement Detail	
Channel	Channel 157	Frequency Range	1 GHz ~ 40 GHz
Input Power	120 Vac, 60 Hz	Detector Function	Peak (PK) Average (AV)
Environmental Conditions	25 deg. C, 65 % RH	Tested By	Toby Tian

Antenna Polarity & Test Distance: Horizontal at 3 m										
Frequency (MHz)	Emission Level (dBuV/m)	Read Level (dBuV)	Limit (dBuV/m)	Margin (dB)	Antenna Factor (dB/m)	Cable Loss (dB)	Preamp Factor (dB)	Antenna Height (cm)	Table Angle (Degree)	Remark
*5714	59.9	58.71	68.2	-8.3	31.93	6.69	37.43	196	233	Peak
*5725	60.74	59.46	78.2	-17.46	31.96	6.75	37.43	196	233	Peak
5785	99.18	97.86			32.04	6.82	37.54	196	233	Average
5785	108.16	106.84			32.04	6.82	37.54	196	233	Peak
*5850	59.6	58.08	78.2	-18.6	32.15	6.88	37.51	196	233	Peak
*5861	60.52	58.89	68.2	-7.68	32.18	6.95	37.5	196	233	Peak
Antenna Polarity & Test Distance: Vertical at 3 m										
Frequency (MHz)	Emission Level (dBuV/m)	Read Level (dBuV)	Limit (dBuV/m)	Margin (dB)	Antenna Factor (dB/m)	Cable Loss (dB)	Preamp Factor (dB)	Antenna Height (cm)	Table Angle (Degree)	Remark
*5714	59.85	58.66	68.2	-8.35	31.93	6.69	37.43	210	165	Peak
*5725	58.66	57.38	78.2	-19.54	31.96	6.75	37.43	210	165	Peak
5785	98.04	96.72			32.04	6.82	37.54	210	165	Average
5785	107.14	105.82			32.04	6.82	37.54	210	165	Peak
*5850	61.35	59.83	78.2	-16.85	32.15	6.88	37.51	210	165	Peak
*5861	59.54	57.91	68.2	-8.66	32.18	6.95	37.5	210	165	Peak

Remarks:

- Emission Level = Read Level + Antenna Factor + Cable Loss - Preamp Factor  
Margin value = Emission level – Limit value
- 5785 MHz: Fundamental Frequency
- \*: Out of Restricted Band

EUT Test Condition		Measurement Detail	
Channel	Channel 165	Frequency Range	1 GHz ~ 40 GHz
Input Power	120 Vac, 60 Hz	Detector Function	Peak (PK) Average (AV)
Environmental Conditions	25 deg. C, 65 % RH	Tested By	Toby Tian

Antenna Polarity & Test Distance: Horizontal at 3 m										
Frequency (MHz)	Emission Level (dBuV/m)	Read Level (dBuV)	Limit (dBuV/m)	Margin (dB)	Antenna Factor (dB/m)	Cable Loss (dB)	Preamp Factor (dB)	Antenna Height (cm)	Table Angle (Degree)	Remark
*5714	57.83	56.64	68.2	-10.37	31.93	6.69	37.43	195	237	Peak
*5725	58.74	57.46	78.2	-19.46	31.96	6.75	37.43	195	237	Peak
5825	96.4	94.93			32.12	6.88	37.53	195	237	Average
5825	105.99	104.52			32.12	6.88	37.53	195	237	Peak
*5850	60.97	59.45	78.2	-17.23	32.15	6.88	37.51	195	237	Peak
*5861	59.82	58.19	68.2	-8.38	32.18	6.95	37.5	195	237	Peak
Antenna Polarity & Test Distance: Vertical at 3 m										
Frequency (MHz)	Emission Level (dBuV/m)	Read Level (dBuV)	Limit (dBuV/m)	Margin (dB)	Antenna Factor (dB/m)	Cable Loss (dB)	Preamp Factor (dB)	Antenna Height (cm)	Table Angle (Degree)	Remark
*5714	59.2	58.01	68.2	-9	31.93	6.69	37.43	209	163	Peak
*5725	58.98	57.7	78.2	-19.22	31.96	6.75	37.43	209	163	Peak
5825	95.64	94.17			32.12	6.88	37.53	209	163	Average
5825	104.99	103.52			32.12	6.88	37.53	209	163	Peak
*5850	59.06	57.54	78.2	-19.14	32.15	6.88	37.51	209	163	Peak
*5861	59.32	57.69	68.2	-8.88	32.18	6.95	37.5	209	163	Peak

Remarks:

- Emission Level = Read Level + Antenna Factor + Cable Loss - Preamp Factor  
Margin value = Emission level – Limit value
- 5825 MHz: Fundamental Frequency
- \*: Out of Restricted Band

### 802.11n (HT20)

EUT Test Condition		Measurement Detail	
Channel	Channel 36	Frequency Range	1 GHz ~ 40 GHz
Input Power	120 Vac, 60 Hz	Detector Function	Peak (PK) Average (AV)
Environmental Conditions	25 deg. C, 65 % RH	Tested By	Toby Tian

#### Antenna Polarity & Test Distance: Horizontal at 3 m

Frequency (MHz)	Emission Level (dBuV/m)	Read Level (dBuV)	Limit (dBuV/m)	Margin (dB)	Antenna Factor (dB/m)	Cable Loss (dB)	Preamp Factor (dB)	Antenna Height (cm)	Table Angle (Degree)	Remark
5058	43.87	43.7	54	-10.13	31.25	6.17	37.25	189	239	Average
5058	59.96	59.79	74	-14.04	31.25	6.17	37.25	189	239	Peak
5180	94.59	94.36			31.35	6.22	37.34	189	239	Average
5180	103.83	103.6			31.35	6.22	37.34	189	239	Peak
5448	38.7	37.93	54	-15.3	31.56	6.34	37.13	189	239	Average
5448	60.65	59.88	74	-13.35	31.56	6.34	37.13	189	239	Peak

#### Antenna Polarity & Test Distance: Vertical at 3 m

Frequency (MHz)	Emission Level (dBuV/m)	Read Level (dBuV)	Limit (dBuV/m)	Margin (dB)	Antenna Factor (dB/m)	Cable Loss (dB)	Preamp Factor (dB)	Antenna Height (cm)	Table Angle (Degree)	Remark
5124	42.84	42.64	54	-11.16	31.31	6.19	37.3	146	207	Average
5124	60.23	60.03	74	-13.77	31.31	6.19	37.3	146	207	Peak
5180	94.09	93.86			31.35	6.22	37.34	146	207	Average
5180	103.36	103.13			31.35	6.22	37.34	146	207	Peak
5434	38.74	38	54	-15.26	31.55	6.32	37.13	146	207	Average
5434	60.68	59.94	74	-13.32	31.55	6.32	37.13	146	207	Peak

#### Remarks:

- Emission Level = Read Level + Antenna Factor + Cable Loss - Preamp Factor  
Margin value = Emission level – Limit value
- 5180 MHz: Fundamental Frequency

EUT Test Condition		Measurement Detail	
Channel	Channel 44	Frequency Range	1 GHz ~ 40 GHz
Input Power	120 Vac, 60 Hz	Detector Function	Peak (PK) Average (AV)
Environmental Conditions	25 deg. C, 65 % RH	Tested By	Toby Tian

Antenna Polarity & Test Distance: Horizontal at 3 m										
Frequency (MHz)	Emission Level (dBuV/m)	Read Level (dBuV)	Limit (dBuV/m)	Margin (dB)	Antenna Factor (dB/m)	Cable Loss (dB)	Preamp Factor (dB)	Antenna Height (cm)	Table Angle (Degree)	Remark
5052	38.4	38.24	54	-15.6	31.24	6.17	37.25	166	213	Average
5052	60.66	60.5	74	-13.34	31.24	6.17	37.25	166	213	Peak
5220	87.73	87.48			31.37	6.24	37.36	166	213	Average
5220	106.99	106.74			31.37	6.24	37.36	166	213	Peak
5448	38.79	38.02	54	-15.21	31.56	6.34	37.13	166	213	Average
5448	60.49	59.72	74	-13.51	31.56	6.34	37.13	166	213	Peak

Antenna Polarity & Test Distance: Vertical at 3 m										
Frequency (MHz)	Emission Level (dBuV/m)	Read Level (dBuV)	Limit (dBuV/m)	Margin (dB)	Antenna Factor (dB/m)	Cable Loss (dB)	Preamp Factor (dB)	Antenna Height (cm)	Table Angle (Degree)	Remark
5090	38.51	38.31	54	-15.49	31.28	6.19	37.27	169	209	Average
5090	60.08	59.88	74	-13.92	31.28	6.19	37.27	169	209	Peak
5220	97.73	97.48			31.37	6.24	37.36	169	209	Average
5220	107.04	106.79			31.37	6.24	37.36	169	209	Peak
5390	38.63	37.99	54	-15.37	31.51	6.31	37.18	169	209	Average
5390	59.81	59.17	74	-14.19	31.51	6.31	37.18	169	209	Peak

Remarks:

- Emission Level = Read Level + Antenna Factor + Cable Loss - Preamp Factor  
Margin value = Emission level – Limit value
- 5220 MHz: Fundamental Frequency

EUT Test Condition		Measurement Detail	
Channel	Channel 48	Frequency Range	1 GHz ~ 40 GHz
Input Power	120 Vac, 60 Hz	Detector Function	Peak (PK) Average (AV)
Environmental Conditions	25 deg. C, 65 % RH	Tested By	Toby Tian

Antenna Polarity & Test Distance: Horizontal at 3 m										
Frequency (MHz)	Emission Level (dBuV/m)	Read Level (dBuV)	Limit (dBuV/m)	Margin (dB)	Antenna Factor (dB/m)	Cable Loss (dB)	Preamp Factor (dB)	Antenna Height (cm)	Table Angle (Degree)	Remark
5056	38.84	38.67	54	-15.16	31.25	6.17	37.25	200	245	Average
5056	60.46	60.29	74	-13.54	31.25	6.17	37.25	200	245	Peak
5240	98.27	97.95			31.39	6.25	37.32	200	245	Average
5240	107.63	107.31			31.39	6.25	37.32	200	245	Peak
5450	38.89	38.07	54	-15.11	31.56	6.34	37.08	200	245	Average
5450	60.32	59.5	74	-13.68	31.56	6.34	37.08	200	245	Peak
Antenna Polarity & Test Distance: Vertical at 3 m										
Frequency (MHz)	Emission Level (dBuV/m)	Read Level (dBuV)	Limit (dBuV/m)	Margin (dB)	Antenna Factor (dB/m)	Cable Loss (dB)	Preamp Factor (dB)	Antenna Height (cm)	Table Angle (Degree)	Remark
5122	38.56	38.38	54	-15.44	31.29	6.19	37.3	130	215	Average
5122	59.76	59.58	74	-14.24	31.29	6.19	37.3	130	215	Peak
5240	96.82	96.5			31.39	6.25	37.32	130	215	Average
5240	105.7	105.38			31.39	6.25	37.32	130	215	Peak
5448	38.66	37.89	54	-15.34	31.56	6.34	37.13	130	215	Average
5448	59.65	58.88	74	-14.35	31.56	6.34	37.13	130	215	Peak

Remarks:

- Emission Level = Read Level + Antenna Factor + Cable Loss - Preamp Factor  
Margin value = Emission level – Limit value
- 5240 MHz: Fundamental Frequency

EUT Test Condition		Measurement Detail	
Channel	Channel 52	Frequency Range	1 GHz ~ 40 GHz
Input Power	120 Vac, 60 Hz	Detector Function	Peak (PK) Average (AV)
Environmental Conditions	25 deg. C, 65 % RH	Tested By	Toby Tian

Antenna Polarity & Test Distance: Horizontal at 3 m										
Frequency (MHz)	Emission Level (dBuV/m)	Read Level (dBuV)	Limit (dBuV/m)	Margin (dB)	Antenna Factor (dB/m)	Cable Loss (dB)	Preamp Factor (dB)	Antenna Height (cm)	Table Angle (Degree)	Remark
5012	38.39	38.28	54	-15.61	31.21	6.13	37.23	200	235	Average
5012	60.42	60.31	74	-13.58	31.21	6.13	37.23	200	235	Peak
5260	97.1	96.71			31.41	6.25	37.27	200	235	Average
5260	107.32	106.93			31.41	6.25	37.27	200	235	Peak
5388	38.7	38.06	54	-15.3	31.51	6.31	37.18	200	235	Average
5388	60.16	59.52	74	-13.84	31.51	6.31	37.18	200	235	Peak
Antenna Polarity & Test Distance: Vertical at 3 m										
Frequency (MHz)	Emission Level (dBuV/m)	Read Level (dBuV)	Limit (dBuV/m)	Margin (dB)	Antenna Factor (dB/m)	Cable Loss (dB)	Preamp Factor (dB)	Antenna Height (cm)	Table Angle (Degree)	Remark
5062	38.37	38.2	54	-15.63	31.25	6.17	37.25	193	214	Average
5062	61.49	61.32	74	-12.51	31.25	6.17	37.25	193	214	Peak
5260	96.81	96.42			31.41	6.25	37.27	193	214	Average
5260	106.18	105.79			31.41	6.25	37.27	193	214	Peak
5458	38.75	37.93	54	-15.25	31.56	6.34	37.08	193	214	Average
5458	60.74	59.92	74	-13.26	31.56	6.34	37.08	193	214	Peak

Remarks:

- Emission Level = Read Level + Antenna Factor + Cable Loss - Preamp Factor  
Margin value = Emission level – Limit value
- 5260 MHz: Fundamental Frequency

EUT Test Condition		Measurement Detail	
Channel	Channel 60	Frequency Range	1 GHz ~ 40 GHz
Input Power	120 Vac, 60 Hz	Detector Function	Peak (PK) Average (AV)
Environmental Conditions	25 deg. C, 65 % RH	Tested By	Toby Tian

Antenna Polarity & Test Distance: Horizontal at 3 m										
Frequency (MHz)	Emission Level (dBuV/m)	Read Level (dBuV)	Limit (dBuV/m)	Margin (dB)	Antenna Factor (dB/m)	Cable Loss (dB)	Preamp Factor (dB)	Antenna Height (cm)	Table Angle (Degree)	Remark
5024	38.34	38.2	54	-15.66	31.23	6.15	37.24	166	237	Average
5024	60.26	60.12	74	-13.74	31.23	6.15	37.24	166	237	Peak
5300	97.99	97.47			31.44	6.27	37.19	166	237	Average
5300	107.92	107.4			31.44	6.27	37.19	166	237	Peak
5448	38.96	38.19	54	-15.04	31.56	6.34	37.13	166	237	Average
5448	61.2	60.43	74	-12.8	31.56	6.34	37.13	166	237	Peak
Antenna Polarity & Test Distance: Vertical at 3 m										
Frequency (MHz)	Emission Level (dBuV/m)	Read Level (dBuV)	Limit (dBuV/m)	Margin (dB)	Antenna Factor (dB/m)	Cable Loss (dB)	Preamp Factor (dB)	Antenna Height (cm)	Table Angle (Degree)	Remark
5020	38.33	38.21	54	-15.67	31.21	6.15	37.24	190	214	Average
5020	61.11	60.99	74	-12.89	31.21	6.15	37.24	190	214	Peak
5300	96.35	95.83			31.44	6.27	37.19	190	214	Average
5300	106.36	105.84			31.44	6.27	37.19	190	214	Peak
5450	38.77	37.95	54	-15.23	31.56	6.34	37.08	190	214	Average
5450	60.23	59.41	74	-13.77	31.56	6.34	37.08	190	214	Peak

Remarks:

- Emission Level = Read Level + Antenna Factor + Cable Loss - Preamp Factor  
Margin value = Emission level – Limit value
- 5300 MHz: Fundamental Frequency

EUT Test Condition		Measurement Detail	
Channel	Channel 64	Frequency Range	1 GHz ~ 40 GHz
Input Power	120 Vac, 60 Hz	Detector Function	Peak (PK) Average (AV)
Environmental Conditions	25 deg. C, 65 % RH	Tested By	Toby Tian

Antenna Polarity & Test Distance: Horizontal at 3 m										
Frequency (MHz)	Emission Level (dBuV/m)	Read Level (dBuV)	Limit (dBuV/m)	Margin (dB)	Antenna Factor (dB/m)	Cable Loss (dB)	Preamp Factor (dB)	Antenna Height (cm)	Table Angle (Degree)	Remark
5134	38.31	38.1	54	-15.69	31.31	6.2	37.3	179	243	Average
5134	59.87	59.66	74	-14.13	31.31	6.2	37.3	179	243	Peak
5320	95.64	95.09			31.45	6.29	37.19	179	243	Average
5320	105.74	105.19			31.45	6.29	37.19	179	243	Peak
5406	43.85	43.19	54	-10.15	31.52	6.32	37.18	179	243	Average
5406	60.22	59.56	74	-13.78	31.52	6.32	37.18	179	243	Peak
Antenna Polarity & Test Distance: Vertical at 3 m										
Frequency (MHz)	Emission Level (dBuV/m)	Read Level (dBuV)	Limit (dBuV/m)	Margin (dB)	Antenna Factor (dB/m)	Cable Loss (dB)	Preamp Factor (dB)	Antenna Height (cm)	Table Angle (Degree)	Remark
5090	38.26	38.06	54	-15.74	31.28	6.19	37.27	206	210	Average
5090	60.02	59.82	74	-13.98	31.28	6.19	37.27	206	210	Peak
5320	94.13	93.58			31.45	6.29	37.19	206	210	Average
5320	104.49	103.94			31.45	6.29	37.19	206	210	Peak
5450	42.29	41.47	54	-11.71	31.56	6.34	37.08	206	210	Average
5450	60.68	59.86	74	-13.32	31.56	6.34	37.08	206	210	Peak

Remarks:

- Emission Level = Read Level + Antenna Factor + Cable Loss - Preamp Factor  
Margin value = Emission level – Limit value
- 5320 MHz: Fundamental Frequency



EUT Test Condition		Measurement Detail	
Channel	Channel 100	Frequency Range	1 GHz ~ 40 GHz
Input Power	120 Vac, 60 Hz	Detector Function	Peak (PK) Average (AV)
Environmental Conditions	25 deg. C, 65 % RH	Tested By	Toby Tian

Antenna Polarity & Test Distance: Horizontal at 3 m										
Frequency (MHz)	Emission Level (dBuV/m)	Read Level (dBuV)	Limit (dBuV/m)	Margin (dB)	Antenna Factor (dB/m)	Cable Loss (dB)	Preamp Factor (dB)	Antenna Height (cm)	Table Angle (Degree)	Remark
5448	43.26	42.49	54	-10.74	31.56	6.34	37.13	182	241	Average
5448	60.76	59.99	74	-13.24	31.56	6.34	37.13	182	241	Peak
5470	59.57	58.74	68.2	-8.63	31.57	6.34	37.08	182	241	Peak
5500	93.39	92.46			31.6	6.36	37.03	182	241	Average
5500	103.91	102.98			31.6	6.36	37.03	182	241	Peak
5725	60.75	59.47	68.2	-7.45	31.96	6.75	37.43	182	241	Peak

Antenna Polarity & Test Distance: Vertical at 3 m										
Frequency (MHz)	Emission Level (dBuV/m)	Read Level (dBuV)	Limit (dBuV/m)	Margin (dB)	Antenna Factor (dB/m)	Cable Loss (dB)	Preamp Factor (dB)	Antenna Height (cm)	Table Angle (Degree)	Remark
5434	42.78	42.04	54	-11.22	31.55	6.32	37.13	182	153	Average
5434	60.65	59.91	74	-13.35	31.55	6.32	37.13	182	153	Peak
5470	58.56	57.73	68.2	-9.64	31.57	6.34	37.08	182	153	Peak
5500	92.85	91.92			31.6	6.36	37.03	182	153	Average
5500	102.08	101.15			31.6	6.36	37.03	182	153	Peak
5725	59.19	57.91	68.2	-9.01	31.96	6.75	37.43	182	153	Peak

Remarks:

- Emission Level = Read Level + Antenna Factor + Cable Loss - Preamp Factor  
Margin value = Emission level – Limit value
- 5500 MHz: Fundamental Frequency
- 5470 MHz & 5725 MHz: Out of Restricted Band

EUT Test Condition		Measurement Detail	
Channel	Channel 116	Frequency Range	1 GHz ~ 40 GHz
Input Power	120 Vac, 60 Hz	Detector Function	Peak (PK) Average (AV)
Environmental Conditions	25 deg. C, 65 % RH	Tested By	Toby Tian

Antenna Polarity & Test Distance: Horizontal at 3 m										
Frequency (MHz)	Emission Level (dBuV/m)	Read Level (dBuV)	Limit (dBuV/m)	Margin (dB)	Antenna Factor (dB/m)	Cable Loss (dB)	Preamp Factor (dB)	Antenna Height (cm)	Table Angle (Degree)	Remark
5402	38.74	38.08	54	-15.26	31.52	6.32	37.18	187	240	Average
5402	59.9	59.24	74	-14.1	31.52	6.32	37.18	187	240	Peak
5470	59.16	58.33	68.2	-9.04	31.57	6.34	37.08	187	240	Peak
5580	97.33	96.29			31.71	6.49	37.16	187	240	Average
5580	107.58	106.54			31.71	6.49	37.16	187	240	Peak
5725	59.18	57.9	68.2	-9.02	31.96	6.75	37.43	187	240	Peak
Antenna Polarity & Test Distance: Vertical at 3 m										
Frequency (MHz)	Emission Level (dBuV/m)	Read Level (dBuV)	Limit (dBuV/m)	Margin (dB)	Antenna Factor (dB/m)	Cable Loss (dB)	Preamp Factor (dB)	Antenna Height (cm)	Table Angle (Degree)	Remark
5412	38.65	37.98	54	-15.35	31.53	6.32	37.18	194	154	Average
5412	60.25	59.58	74	-13.75	31.53	6.32	37.18	194	154	Peak
5470	58.29	57.46	68.2	-9.91	31.57	6.34	37.08	194	154	Peak
5580	96.69	95.65			31.71	6.49	37.16	194	154	Average
5580	106.92	105.88			31.71	6.49	37.16	194	154	Peak
5725	59.32	58.04	68.2	-8.88	31.96	6.75	37.43	194	154	Peak

Remarks:

- Emission Level = Read Level + Antenna Factor + Cable Loss - Preamp Factor  
Margin value = Emission level – Limit value
- 5580 MHz: Fundamental Frequency
- 5470 MHz & 5725 MHz: Out of Restricted Band

EUT Test Condition		Measurement Detail	
Channel	Channel 140	Frequency Range	1 GHz ~ 40 GHz
Input Power	120 Vac, 60 Hz	Detector Function	Peak (PK) Average (AV)
Environmental Conditions	25 deg. C, 65 % RH	Tested By	Toby Tian

Antenna Polarity & Test Distance: Horizontal at 3 m										
Frequency (MHz)	Emission Level (dBuV/m)	Read Level (dBuV)	Limit (dBuV/m)	Margin (dB)	Antenna Factor (dB/m)	Cable Loss (dB)	Preamp Factor (dB)	Antenna Height (cm)	Table Angle (Degree)	Remark
5426	38.59	37.87	54	-15.41	31.53	6.32	37.13	174	238	Average
5426	60.42	59.7	74	-13.58	31.53	6.32	37.13	174	238	Peak
5470	58.26	57.43	68.2	-9.94	31.57	6.34	37.08	174	238	Peak
5700	94.67	93.48			31.9	6.69	37.4	174	238	Average
5700	104.06	102.87			31.9	6.69	37.4	174	238	Peak
5725	59.71	58.43	68.2	-8.49	31.96	6.75	37.43	174	238	Peak
Antenna Polarity & Test Distance: Vertical at 3 m										
Frequency (MHz)	Emission Level (dBuV/m)	Read Level (dBuV)	Limit (dBuV/m)	Margin (dB)	Antenna Factor (dB/m)	Cable Loss (dB)	Preamp Factor (dB)	Antenna Height (cm)	Table Angle (Degree)	Remark
5428	38.58	37.86	54	-15.42	31.53	6.32	37.13	197	152	Average
5428	60.14	59.42	74	-13.86	31.53	6.32	37.13	197	152	Peak
5470	57.46	56.63	68.2	-10.74	31.57	6.34	37.08	197	152	Peak
5700	93.14	91.95			31.9	6.69	37.4	197	152	Average
5700	103.56	102.37			31.9	6.69	37.4	197	152	Peak
5725	59.33	58.05	68.2	-8.87	31.96	6.75	37.43	197	152	Peak

Remarks:

- Emission Level = Read Level + Antenna Factor + Cable Loss - Preamp Factor  
Margin value = Emission level – Limit value
- 5700 MHz: Fundamental Frequency
- 5470 MHz & 5725 MHz: Out of Restricted Band

EUT Test Condition		Measurement Detail	
Channel	Channel 149	Frequency Range	1 GHz ~ 40 GHz
Input Power	120 Vac, 60 Hz	Detector Function	Peak (PK) Average (AV)
Environmental Conditions	25 deg. C, 65 % RH	Tested By	Toby Tian

Antenna Polarity & Test Distance: Horizontal at 3 m										
Frequency (MHz)	Emission Level (dBuV/m)	Read Level (dBuV)	Limit (dBuV/m)	Margin (dB)	Antenna Factor (dB/m)	Cable Loss (dB)	Preamp Factor (dB)	Antenna Height (cm)	Table Angle (Degree)	Remark
*5714	58.91	57.72	68.2	-9.29	31.93	6.69	37.43	172	236	Peak
*5725	59.47	58.19	78.2	-18.73	31.96	6.75	37.43	172	236	Peak
5745	92.88	91.61			31.99	6.75	37.47	172	236	Average
5745	102.25	100.98			31.99	6.75	37.47	172	236	Peak
*5850	59.99	58.47	78.2	-18.21	32.15	6.88	37.51	172	236	Peak
*5861	60	58.37	68.2	-8.2	32.18	6.95	37.5	172	236	Peak
Antenna Polarity & Test Distance: Vertical at 3 m										
Frequency (MHz)	Emission Level (dBuV/m)	Read Level (dBuV)	Limit (dBuV/m)	Margin (dB)	Antenna Factor (dB/m)	Cable Loss (dB)	Preamp Factor (dB)	Antenna Height (cm)	Table Angle (Degree)	Remark
*5714	60.28	59.09	68.2	-7.92	31.93	6.69	37.43	188	159	Peak
*5725	58.96	57.68	78.2	-19.24	31.96	6.75	37.43	188	159	Peak
5745	92.72	91.45			31.99	6.75	37.47	188	159	Average
5745	101.95	100.68			31.99	6.75	37.47	188	159	Peak
*5850	60.3	58.78	78.2	-17.9	32.15	6.88	37.51	188	159	Peak
*5861	59.27	57.64	68.2	-8.93	32.18	6.95	37.5	188	159	Peak

Remarks:

- Emission Level = Read Level + Antenna Factor + Cable Loss - Preamp Factor  
Margin value = Emission level – Limit value
- 5745 MHz: Fundamental Frequency
- \*: Out of Restricted Band

EUT Test Condition		Measurement Detail	
Channel	Channel 157	Frequency Range	1 GHz ~ 40 GHz
Input Power	120 Vac, 60 Hz	Detector Function	Peak (PK) Average (AV)
Environmental Conditions	25 deg. C, 65 % RH	Tested By	Toby Tian

Antenna Polarity & Test Distance: Horizontal at 3 m										
Frequency (MHz)	Emission Level (dBuV/m)	Read Level (dBuV)	Limit (dBuV/m)	Margin (dB)	Antenna Factor (dB/m)	Cable Loss (dB)	Preamp Factor (dB)	Antenna Height (cm)	Table Angle (Degree)	Remark
*5714	60.11	58.92	68.2	-8.09	31.93	6.69	37.43	184	234	Peak
*5725	58.58	57.3	78.2	-19.62	31.96	6.75	37.43	184	234	Peak
5785	98.92	97.6			32.04	6.82	37.54	184	234	Average
5785	107.92	106.6			32.04	6.82	37.54	184	234	Peak
*5850	59.5	57.98	78.2	-18.7	32.15	6.88	37.51	184	234	Peak
*5861	61.72	60.09	68.2	-6.48	32.18	6.95	37.5	184	234	Peak
Antenna Polarity & Test Distance: Vertical at 3 m										
Frequency (MHz)	Emission Level (dBuV/m)	Read Level (dBuV)	Limit (dBuV/m)	Margin (dB)	Antenna Factor (dB/m)	Cable Loss (dB)	Preamp Factor (dB)	Antenna Height (cm)	Table Angle (Degree)	Remark
*5714	59.93	58.74	68.2	-8.27	31.93	6.69	37.43	187	168	Peak
*5725	58.2	56.92	78.2	-20	31.96	6.75	37.43	187	168	Peak
5785	98.26	96.94			32.04	6.82	37.54	187	168	Average
5785	107.51	106.19			32.04	6.82	37.54	187	168	Peak
*5850	59.39	57.87	78.2	-18.81	32.15	6.88	37.51	187	168	Peak
*5861	59.03	57.4	68.2	-9.17	32.18	6.95	37.5	187	168	Peak

Remarks:

- Emission Level = Read Level + Antenna Factor + Cable Loss - Preamp Factor  
Margin value = Emission level – Limit value
- 5785 MHz: Fundamental Frequency
- \*: Out of Restricted Band

EUT Test Condition		Measurement Detail	
Channel	Channel 165	Frequency Range	1 GHz ~ 40 GHz
Input Power	120 Vac, 60 Hz	Detector Function	Peak (PK) Average (AV)
Environmental Conditions	25 deg. C, 65 % RH	Tested By	Toby Tian

Antenna Polarity & Test Distance: Horizontal at 3 m										
Frequency (MHz)	Emission Level (dBuV/m)	Read Level (dBuV)	Limit (dBuV/m)	Margin (dB)	Antenna Factor (dB/m)	Cable Loss (dB)	Preamp Factor (dB)	Antenna Height (cm)	Table Angle (Degree)	Remark
*5714	59.39	58.2	68.2	-8.81	31.93	6.69	37.43	197	242	Peak
*5725	58.54	57.26	78.2	-19.66	31.96	6.75	37.43	197	242	Peak
5825	97.16	95.69			32.12	6.88	37.53	197	242	Average
5825	106.27	104.8			32.12	6.88	37.53	197	242	Peak
*5850	59.13	57.61	78.2	-19.07	32.15	6.88	37.51	197	242	Peak
*5861	58.62	56.99	68.2	-9.58	32.18	6.95	37.5	197	242	Peak
Antenna Polarity & Test Distance: Vertical at 3 m										
Frequency (MHz)	Emission Level (dBuV/m)	Read Level (dBuV)	Limit (dBuV/m)	Margin (dB)	Antenna Factor (dB/m)	Cable Loss (dB)	Preamp Factor (dB)	Antenna Height (cm)	Table Angle (Degree)	Remark
*5714	58.73	57.54	68.2	-9.47	31.93	6.69	37.43	186	159	Peak
*5725	58.98	57.7	78.2	-19.22	31.96	6.75	37.43	186	159	Peak
5825	96.26	94.79			32.12	6.88	37.53	186	159	Average
5825	105.51	104.04			32.12	6.88	37.53	186	159	Peak
*5850	61.01	59.49	78.2	-17.19	32.15	6.88	37.51	186	159	Peak
*5861	60.43	58.8	68.2	-7.77	32.18	6.95	37.5	186	159	Peak

Remarks:

- Emission Level = Read Level + Antenna Factor + Cable Loss - Preamp Factor  
Margin value = Emission level – Limit value
- 5825 MHz: Fundamental Frequency
- \*: Out of Restricted Band

### 802.11n (HT40)

EUT Test Condition		Measurement Detail	
Channel	Channel 38	Frequency Range	1 GHz ~ 40 GHz
Input Power	120 Vac, 60 Hz	Detector Function	Peak (PK) Average (AV)
Environmental Conditions	25 deg. C, 65 % RH	Tested By	Toby Tian

#### Antenna Polarity & Test Distance: Horizontal at 3 m

Frequency (MHz)	Emission Level (dBuV/m)	Read Level (dBuV)	Limit (dBuV/m)	Margin (dB)	Antenna Factor (dB/m)	Cable Loss (dB)	Preamp Factor (dB)	Antenna Height (cm)	Table Angle (Degree)	Remark
5050	41.09	40.95	54	-12.91	31.24	6.15	37.25	200	241	Average
5050	59.93	59.79	74	-14.07	31.24	6.15	37.25	200	241	Peak
5190	89.94	89.71			31.35	6.22	37.34	200	241	Average
5190	101.39	101.16			31.35	6.22	37.34	200	241	Peak
5450	38.84	38.02	54	-15.16	31.56	6.34	37.08	200	241	Average
5450	60.02	59.2	74	-13.98	31.56	6.34	37.08	200	241	Peak

#### Antenna Polarity & Test Distance: Vertical at 3 m

Frequency (MHz)	Emission Level (dBuV/m)	Read Level (dBuV)	Limit (dBuV/m)	Margin (dB)	Antenna Factor (dB/m)	Cable Loss (dB)	Preamp Factor (dB)	Antenna Height (cm)	Table Angle (Degree)	Remark
5018	41.69	41.57	54	-12.31	31.21	6.15	37.24	179	214	Average
5018	60.3	60.18	74	-13.7	31.21	6.15	37.24	179	214	Peak
5190	90.45	90.22			31.35	6.22	37.34	179	214	Average
5190	100.3	100.07			31.35	6.22	37.34	179	214	Peak
5456	38.58	37.76	54	-15.42	31.56	6.34	37.08	179	214	Average
5456	60.76	59.94	74	-13.24	31.56	6.34	37.08	179	214	Peak

#### Remarks:

- Emission Level = Read Level + Antenna Factor + Cable Loss - Preamp Factor  
Margin value = Emission level – Limit value
- 5190 MHz: Fundamental Frequency

EUT Test Condition		Measurement Detail	
Channel	Channel 46	Frequency Range	1 GHz ~ 40 GHz
Input Power	120 Vac, 60 Hz	Detector Function	Peak (PK) Average (AV)
Environmental Conditions	25 deg. C, 65 % RH	Tested By	Toby Tian

Antenna Polarity & Test Distance: Horizontal at 3 m										
Frequency (MHz)	Emission Level (dBuV/m)	Read Level (dBuV)	Limit (dBuV/m)	Margin (dB)	Antenna Factor (dB/m)	Cable Loss (dB)	Preamp Factor (dB)	Antenna Height (cm)	Table Angle (Degree)	Remark
5024	39.47	39.33	54	-14.53	31.23	6.15	37.24	202	239	Average
5024	60.67	60.53	74	-13.33	31.23	6.15	37.24	202	239	Peak
5230	91.21	90.9			31.39	6.24	37.32	202	239	Average
5230	100.71	100.4			31.39	6.24	37.32	202	239	Peak
5448	38.85	38.08	54	-15.15	31.56	6.34	37.13	202	239	Average
5448	60.77	60	74	-13.23	31.56	6.34	37.13	202	239	Peak
Antenna Polarity & Test Distance: Vertical at 3 m										
Frequency (MHz)	Emission Level (dBuV/m)	Read Level (dBuV)	Limit (dBuV/m)	Margin (dB)	Antenna Factor (dB/m)	Cable Loss (dB)	Preamp Factor (dB)	Antenna Height (cm)	Table Angle (Degree)	Remark
5120	38.87	38.69	54	-15.13	31.29	6.19	37.3	194	213	Average
5120	60.2	60.02	74	-13.8	31.29	6.19	37.3	194	213	Peak
5230	90.13	89.84			31.37	6.24	37.32	194	213	Average
5230	100.68	100.39			31.37	6.24	37.32	194	213	Peak
5412	38.71	38.04	54	-15.29	31.53	6.32	37.18	194	213	Average
5412	60.42	59.75	74	-13.58	31.53	6.32	37.18	194	213	Peak

Remarks:

- Emission Level = Read Level + Antenna Factor + Cable Loss - Preamp Factor  
Margin value = Emission level – Limit value
- 5230 MHz: Fundamental Frequency



EUT Test Condition		Measurement Detail	
Channel	Channel 54	Frequency Range	1 GHz ~ 40 GHz
Input Power	120 Vac, 60 Hz	Detector Function	Peak (PK) Average (AV)
Environmental Conditions	25 deg. C, 65 % RH	Tested By	Toby Tian

Antenna Polarity & Test Distance: Horizontal at 3 m										
Frequency (MHz)	Emission Level (dBuV/m)	Read Level (dBuV)	Limit (dBuV/m)	Margin (dB)	Antenna Factor (dB/m)	Cable Loss (dB)	Preamp Factor (dB)	Antenna Height (cm)	Table Angle (Degree)	Remark
5024	38.46	38.32	54	-15.54	31.23	6.15	37.24	208	243	Average
5024	60.53	60.39	74	-13.47	31.23	6.15	37.24	208	243	Peak
5270	90.93	90.54			31.41	6.25	37.27	208	243	Average
5270	100.12	99.73			31.41	6.25	37.27	208	243	Peak
5418	39.41	38.74	54	-14.59	31.53	6.32	37.18	208	243	Average
5418	60	59.33	74	-14	31.53	6.32	37.18	208	243	Peak
Antenna Polarity & Test Distance: Vertical at 3 m										
Frequency (MHz)	Emission Level (dBuV/m)	Read Level (dBuV)	Limit (dBuV/m)	Margin (dB)	Antenna Factor (dB/m)	Cable Loss (dB)	Preamp Factor (dB)	Antenna Height (cm)	Table Angle (Degree)	Remark
5098	38.71	38.52	54	-15.29	31.28	6.19	37.28	210	211	Average
5098	60.21	60.02	74	-13.79	31.28	6.19	37.28	210	211	Peak
5270	89.89	89.5			31.41	6.25	37.27	210	211	Average
5270	99.13	98.74			31.41	6.25	37.27	210	211	Peak
5392	38.98	38.34	54	-15.02	31.51	6.31	37.18	210	211	Average
5392	59.81	59.17	74	-14.19	31.51	6.31	37.18	210	211	Peak

Remarks:

- Emission Level = Read Level + Antenna Factor + Cable Loss - Preamp Factor  
Margin value = Emission level – Limit value
- 5270 MHz: Fundamental Frequency

EUT Test Condition		Measurement Detail	
Channel	Channel 62	Frequency Range	1 GHz ~ 40 GHz
Input Power	120 Vac, 60 Hz	Detector Function	Peak (PK) Average (AV)
Environmental Conditions	25 deg. C, 65 % RH	Tested By	Toby Tian

Antenna Polarity & Test Distance: Horizontal at 3 m										
Frequency (MHz)	Emission Level (dBuV/m)	Read Level (dBuV)	Limit (dBuV/m)	Margin (dB)	Antenna Factor (dB/m)	Cable Loss (dB)	Preamp Factor (dB)	Antenna Height (cm)	Table Angle (Degree)	Remark
5074	38.68	38.51	54	-15.32	31.27	6.17	37.27	193	239	Average
5074	59.96	59.79	74	-14.04	31.27	6.17	37.27	193	239	Peak
5310	91.03	90.5			31.45	6.27	37.19	193	239	Average
5310	100.15	99.62			31.45	6.27	37.19	193	239	Peak
5408	41.55	40.89	54	-12.45	31.52	6.32	37.18	193	239	Average
5408	59.95	59.29	74	-14.05	31.52	6.32	37.18	193	239	Peak
Antenna Polarity & Test Distance: Vertical at 3 m										
Frequency (MHz)	Emission Level (dBuV/m)	Read Level (dBuV)	Limit (dBuV/m)	Margin (dB)	Antenna Factor (dB/m)	Cable Loss (dB)	Preamp Factor (dB)	Antenna Height (cm)	Table Angle (Degree)	Remark
5030	38.82	38.68	54	-15.18	31.23	6.15	37.24	218	206	Average
5030	60.5	60.36	74	-13.5	31.23	6.15	37.24	218	206	Peak
5310	90.57	90.04			31.45	6.27	37.19	218	206	Average
5310	99.69	99.16			31.45	6.27	37.19	218	206	Peak
5356	39.81	39.22	54	-14.19	31.48	6.29	37.18	218	206	Average
5356	61.01	60.42	74	-12.99	31.48	6.29	37.18	218	206	Peak

Remarks:

- Emission Level = Read Level + Antenna Factor + Cable Loss - Preamp Factor  
Margin value = Emission level – Limit value
- 5310 MHz: Fundamental Frequency

EUT Test Condition		Measurement Detail	
Channel	Channel 102	Frequency Range	1 GHz ~ 40 GHz
Input Power	120 Vac, 60 Hz	Detector Function	Peak (PK) Average (AV)
Environmental Conditions	25 deg. C, 65 % RH	Tested By	Toby Tian

Antenna Polarity & Test Distance: Horizontal at 3 m										
Frequency (MHz)	Emission Level (dBuV/m)	Read Level (dBuV)	Limit (dBuV/m)	Margin (dB)	Antenna Factor (dB/m)	Cable Loss (dB)	Preamp Factor (dB)	Antenna Height (cm)	Table Angle (Degree)	Remark
5414	40.41	39.74	54	-13.59	31.53	6.32	37.18	194	238	Average
5414	60.38	59.71	74	-13.62	31.53	6.32	37.18	194	238	Peak
5470	57.19	56.36	68.2	-11.01	31.57	6.34	37.08	194	238	Peak
5510	90.5	89.6			31.6	6.36	37.06	194	238	Average
5510	99.66	98.76			31.6	6.36	37.06	194	238	Peak
5725	58.76	57.48	68.2	-9.44	31.96	6.75	37.43	194	238	Peak
Antenna Polarity & Test Distance: Vertical at 3 m										
Frequency (MHz)	Emission Level (dBuV/m)	Read Level (dBuV)	Limit (dBuV/m)	Margin (dB)	Antenna Factor (dB/m)	Cable Loss (dB)	Preamp Factor (dB)	Antenna Height (cm)	Table Angle (Degree)	Remark
5450	39.35	38.53	54	-14.65	31.56	6.34	37.08	165	170	Average
5450	60.93	60.11	74	-13.07	31.56	6.34	37.08	165	170	Peak
5470	58.11	57.28	68.2	-10.09	31.57	6.34	37.08	165	170	Peak
5510	88.38	87.48			31.6	6.36	37.06	165	170	Average
5510	98.64	97.74			31.6	6.36	37.06	165	170	Peak
5725	59.28	58	68.2	-8.92	31.96	6.75	37.43	165	170	Peak

Remarks:

- Emission Level = Read Level + Antenna Factor + Cable Loss - Preamp Factor  
Margin value = Emission level – Limit value
- 5510 MHz: Fundamental Frequency
- 5470 MHz & 5725 MHz: Out of Restricted Band

EUT Test Condition		Measurement Detail	
Channel	Channel 110	Frequency Range	1 GHz ~ 40 GHz
Input Power	120 Vac, 60 Hz	Detector Function	Peak (PK) Average (AV)
Environmental Conditions	25 deg. C, 65 % RH	Tested By	Toby Tian

Antenna Polarity & Test Distance: Horizontal at 3 m										
Frequency (MHz)	Emission Level (dBuV/m)	Read Level (dBuV)	Limit (dBuV/m)	Margin (dB)	Antenna Factor (dB/m)	Cable Loss (dB)	Preamp Factor (dB)	Antenna Height (cm)	Table Angle (Degree)	Remark
5406	40.38	39.72	54	-13.62	31.52	6.32	37.18	197	235	Average
5406	59.81	59.15	74	-14.19	31.52	6.32	37.18	197	235	Peak
5470	59.67	58.84	68.2	-8.53	31.57	6.34	37.08	197	235	Peak
5550	91.16	90.15			31.68	6.42	37.09	197	235	Average
5550	101.45	100.44			31.68	6.42	37.09	197	235	Peak
5725	60.18	58.9	68.2	-8.02	31.96	6.75	37.43	197	235	Peak
Antenna Polarity & Test Distance: Vertical at 3 m										
Frequency (MHz)	Emission Level (dBuV/m)	Read Level (dBuV)	Limit (dBuV/m)	Margin (dB)	Antenna Factor (dB/m)	Cable Loss (dB)	Preamp Factor (dB)	Antenna Height (cm)	Table Angle (Degree)	Remark
5448	39.69	38.92	54	-14.31	31.56	6.34	37.13	170	155	Average
5448	60.7	59.93	74	-13.3	31.56	6.34	37.13	170	155	Peak
5470	58.29	57.46	68.2	-9.91	31.57	6.34	37.08	170	155	Peak
5550	90.34	89.33			31.68	6.42	37.09	170	155	Average
5550	100.45	99.44			31.68	6.42	37.09	170	155	Peak
5725	60.21	58.93	68.2	-7.99	31.96	6.75	37.43	170	155	Peak

Remarks:

- Emission Level = Read Level + Antenna Factor + Cable Loss - Preamp Factor  
Margin value = Emission level – Limit value
- 5550 MHz: Fundamental Frequency
- 5470 MHz & 5725 MHz: Out of Restricted Band

EUT Test Condition		Measurement Detail	
Channel	Channel 134	Frequency Range	1 GHz ~ 40 GHz
Input Power	120 Vac, 60 Hz	Detector Function	Peak (PK) Average (AV)
Environmental Conditions	25 deg. C, 65 % RH	Tested By	Toby Tian

Antenna Polarity & Test Distance: Horizontal at 3 m										
Frequency (MHz)	Emission Level (dBuV/m)	Read Level (dBuV)	Limit (dBuV/m)	Margin (dB)	Antenna Factor (dB/m)	Cable Loss (dB)	Preamp Factor (dB)	Antenna Height (cm)	Table Angle (Degree)	Remark
5454	38.95	38.13	54	-15.05	31.56	6.34	37.08	176	235	Average
5454	59.68	58.86	74	-14.32	31.56	6.34	37.08	176	235	Peak
5470	57.84	57.01	68.2	-10.36	31.57	6.34	37.08	176	235	Peak
5670	92.58	91.42			31.88	6.62	37.34	176	235	Average
5670	102.09	100.93			31.88	6.62	37.34	176	235	Peak
5725	58.4	57.12	68.2	-9.8	31.96	6.75	37.43	176	235	Peak
Antenna Polarity & Test Distance: Vertical at 3 m										
Frequency (MHz)	Emission Level (dBuV/m)	Read Level (dBuV)	Limit (dBuV/m)	Margin (dB)	Antenna Factor (dB/m)	Cable Loss (dB)	Preamp Factor (dB)	Antenna Height (cm)	Table Angle (Degree)	Remark
5434	39.01	38.27	54	-14.99	31.55	6.32	37.13	125	161	Average
5434	60.24	59.5	74	-13.76	31.55	6.32	37.13	125	161	Peak
5470	59.05	58.22	68.2	-9.15	31.57	6.34	37.08	125	161	Peak
5670	91.4	90.24			31.88	6.62	37.34	125	161	Average
5670	101.71	100.55			31.88	6.62	37.34	125	161	Peak
5725	59.56	58.28	68.2	-8.64	31.96	6.75	37.43	125	161	Peak

Remarks:

- Emission Level = Read Level + Antenna Factor + Cable Loss - Preamp Factor  
Margin value = Emission level – Limit value
- 5670 MHz: Fundamental Frequency
- 5470 MHz & 5725 MHz: Out of Restricted Band

EUT Test Condition		Measurement Detail	
Channel	Channel 151	Frequency Range	1 GHz ~ 40 GHz
Input Power	120 Vac, 60 Hz	Detector Function	Peak (PK) Average (AV)
Environmental Conditions	25 deg. C, 65 % RH	Tested By	Toby Tian

Antenna Polarity & Test Distance: Horizontal at 3 m										
Frequency (MHz)	Emission Level (dBuV/m)	Read Level (dBuV)	Limit (dBuV/m)	Margin (dB)	Antenna Factor (dB/m)	Cable Loss (dB)	Preamp Factor (dB)	Antenna Height (cm)	Table Angle (Degree)	Remark
*5714	59.51	58.32	68.2	-8.69	31.93	6.69	37.43	195	241	Peak
*5725	60.15	58.87	78.2	-18.05	31.96	6.75	37.43	195	241	Peak
5755	90.5	89.21			32.01	6.75	37.47	195	241	Average
5755	100.86	99.57			32.01	6.75	37.47	195	241	Peak
*5850	61.13	59.61	78.2	-17.07	32.15	6.88	37.51	195	241	Peak
*5861	59.16	57.53	68.2	-9.04	32.18	6.95	37.5	195	241	Peak
Antenna Polarity & Test Distance: Vertical at 3 m										
Frequency (MHz)	Emission Level (dBuV/m)	Read Level (dBuV)	Limit (dBuV/m)	Margin (dB)	Antenna Factor (dB/m)	Cable Loss (dB)	Preamp Factor (dB)	Antenna Height (cm)	Table Angle (Degree)	Remark
*5714	60.16	58.97	68.2	-8.04	31.93	6.69	37.43	178	163	Peak
*5725	59.58	58.3	78.2	-18.62	31.96	6.75	37.43	178	163	Peak
5755	89.6	88.31			32.01	6.75	37.47	178	163	Average
5755	99.05	97.76			32.01	6.75	37.47	178	163	Peak
*5850	59.46	57.94	78.2	-18.74	32.15	6.88	37.51	178	163	Peak
*5861	61.75	60.12	68.2	-6.45	32.18	6.95	37.5	178	163	Peak

Remarks:

- Emission Level = Read Level + Antenna Factor + Cable Loss - Preamp Factor  
Margin value = Emission level – Limit value
- 5755 MHz: Fundamental Frequency
- \*: Out of Restricted Band

EUT Test Condition		Measurement Detail	
Channel	Channel 159	Frequency Range	1 GHz ~ 40 GHz
Input Power	120 Vac, 60 Hz	Detector Function	Peak (PK) Average (AV)
Environmental Conditions	25 deg. C, 65 % RH	Tested By	Toby Tian

Antenna Polarity & Test Distance: Horizontal at 3 m										
Frequency (MHz)	Emission Level (dBuV/m)	Read Level (dBuV)	Limit (dBuV/m)	Margin (dB)	Antenna Factor (dB/m)	Cable Loss (dB)	Preamp Factor (dB)	Antenna Height (cm)	Table Angle (Degree)	Remark
*5714	58.73	57.54	68.2	-9.47	31.93	6.69	37.43	195	241	Peak
*5725	60.8	59.52	78.2	-17.4	31.96	6.75	37.43	195	241	Peak
5795	92.08	90.73			32.07	6.82	37.54	195	241	Average
5795	101.32	99.97			32.07	6.82	37.54	195	241	Peak
*5850	58.68	57.16	78.2	-19.52	32.15	6.88	37.51	195	241	Peak
*5861	58.7	57.07	68.2	-9.5	32.18	6.95	37.5	195	241	Peak
Antenna Polarity & Test Distance: Vertical at 3 m										
Frequency (MHz)	Emission Level (dBuV/m)	Read Level (dBuV)	Limit (dBuV/m)	Margin (dB)	Antenna Factor (dB/m)	Cable Loss (dB)	Preamp Factor (dB)	Antenna Height (cm)	Table Angle (Degree)	Remark
*5714	58.81	57.62	68.2	-9.39	31.93	6.69	37.43	181	178	Peak
*5725	60.79	59.51	78.2	-17.41	31.96	6.75	37.43	181	178	Peak
5795	90.58	89.23			32.07	6.82	37.54	181	178	Average
5795	100.2	98.85			32.07	6.82	37.54	181	178	Peak
*5850	58.24	56.72	78.2	-19.96	32.15	6.88	37.51	181	178	Peak
*5861	58.94	57.31	68.2	-9.26	32.18	6.95	37.5	181	178	Peak

Remarks:

- Emission Level = Read Level + Antenna Factor + Cable Loss - Preamp Factor  
Margin value = Emission level – Limit value
- 5795 MHz: Fundamental Frequency
- \*: Out of Restricted Band

**802.11ac (VHT80)**

EUT Test Condition		Measurement Detail	
Channel	Channel 42	Frequency Range	1 GHz ~ 40 GHz
Input Power	120 Vac, 60 Hz	Detector Function	Peak (PK) Average (AV)
Environmental Conditions	25 deg. C, 65 % RH	Tested By	Toby Tian

**Antenna Polarity & Test Distance: Horizontal at 3 m**

Frequency (MHz)	Emission Level (dBuV/m)	Read Level (dBuV)	Limit (dBuV/m)	Margin (dB)	Antenna Factor (dB/m)	Cable Loss (dB)	Preamp Factor (dB)	Antenna Height (cm)	Table Angle (Degree)	Remark
5098	40.76	40.57	54	-13.24	31.28	6.19	37.28	201	248	Average
5098	60.02	59.83	74	-13.98	31.28	6.19	37.28	201	248	Peak
5210	79.31	79.06			31.37	6.24	37.36	201	248	Average
5210	96.47	96.22			31.37	6.24	37.36	201	248	Peak
5422	38.64	37.97	54	-15.36	31.53	6.32	37.18	201	248	Average
5422	60.55	59.88	74	-13.45	31.53	6.32	37.18	201	248	Peak

**Antenna Polarity & Test Distance: Vertical at 3 m**

Frequency (MHz)	Emission Level (dBuV/m)	Read Level (dBuV)	Limit (dBuV/m)	Margin (dB)	Antenna Factor (dB/m)	Cable Loss (dB)	Preamp Factor (dB)	Antenna Height (cm)	Table Angle (Degree)	Remark
5016	40.09	39.96	54	-13.91	31.21	6.15	37.23	196	215	Average
5016	60.15	60.02	74	-13.85	31.21	6.15	37.23	196	215	Peak
5210	79.25	79			31.37	6.24	37.36	196	215	Average
5210	96.75	96.5			31.37	6.24	37.36	196	215	Peak
5448	38.68	37.91	54	-15.32	31.56	6.34	37.13	196	215	Average
5448	60.2	59.43	74	-13.8	31.56	6.34	37.13	196	215	Peak

## Remarks:

- Emission Level = Read Level + Antenna Factor + Cable Loss - Preamp Factor  
Margin value = Emission level – Limit value
- 5210 MHz: Fundamental Frequency



EUT Test Condition		Measurement Detail	
Channel	Channel 58	Frequency Range	1 GHz ~ 40 GHz
Input Power	120 Vac, 60 Hz	Detector Function	Peak (PK) Average (AV)
Environmental Conditions	25 deg. C, 65 % RH	Tested By	Toby Tian

Antenna Polarity & Test Distance: Horizontal at 3 m										
Frequency (MHz)	Emission Level (dBuV/m)	Read Level (dBuV)	Limit (dBuV/m)	Margin (dB)	Antenna Factor (dB/m)	Cable Loss (dB)	Preamp Factor (dB)	Antenna Height (cm)	Table Angle (Degree)	Remark
5038	39.37	39.22	54	-14.63	31.24	6.15	37.24	206	239	Average
5038	59.94	59.79	74	-14.06	31.24	6.15	37.24	206	239	Peak
5290	86.13	85.66			31.43	6.27	37.23	206	239	Average
5290	97.35	96.88			31.43	6.27	37.23	206	239	Peak
5364	47.01	46.39	54	-6.99	31.49	6.31	37.18	206	239	Average
5364	60.56	59.94	74	-13.44	31.49	6.31	37.18	206	239	Peak
Antenna Polarity & Test Distance: Vertical at 3 m										
Frequency (MHz)	Emission Level (dBuV/m)	Read Level (dBuV)	Limit (dBuV/m)	Margin (dB)	Antenna Factor (dB/m)	Cable Loss (dB)	Preamp Factor (dB)	Antenna Height (cm)	Table Angle (Degree)	Remark
5068	38.87	38.72	54	-15.13	31.25	6.17	37.27	191	224	Average
5068	59.06	58.91	74	-14.94	31.25	6.17	37.27	191	224	Peak
5290	85.12	84.65			31.43	6.27	37.23	191	224	Average
5290	96.06	95.59			31.43	6.27	37.23	191	224	Peak
5446	43.37	42.6	54	-10.63	31.56	6.34	37.13	191	224	Average
5446	59.76	58.99	74	-14.24	31.56	6.34	37.13	191	224	Peak

Remarks:

- Emission Level = Read Level + Antenna Factor + Cable Loss - Preamp Factor  
Margin value = Emission level – Limit value
- 5290 MHz: Fundamental Frequency

EUT Test Condition		Measurement Detail	
Channel	Channel 106	Frequency Range	1 GHz ~ 40 GHz
Input Power	120 Vac, 60 Hz	Detector Function	Peak (PK) Average (AV)
Environmental Conditions	25 deg. C, 65 % RH	Tested By	Toby Tian

Antenna Polarity & Test Distance: Horizontal at 3 m										
Frequency (MHz)	Emission Level (dBuV/m)	Read Level (dBuV)	Limit (dBuV/m)	Margin (dB)	Antenna Factor (dB/m)	Cable Loss (dB)	Preamp Factor (dB)	Antenna Height (cm)	Table Angle (Degree)	Remark
5388	41.57	40.93	54	-12.43	31.51	6.31	37.18	190	232	Average
5388	61.04	60.4	74	-12.96	31.51	6.31	37.18	190	232	Peak
5470	58.5	57.67	68.2	-9.7	31.57	6.34	37.08	190	232	Peak
5530	87.59	86.63			31.63	6.42	37.09	190	232	Average
5530	98.2	97.24			31.63	6.42	37.09	190	232	Peak
5725	59.55	58.27	68.2	-8.65	31.96	6.75	37.43	190	232	Peak
Antenna Polarity & Test Distance: Vertical at 3 m										
Frequency (MHz)	Emission Level (dBuV/m)	Read Level (dBuV)	Limit (dBuV/m)	Margin (dB)	Antenna Factor (dB/m)	Cable Loss (dB)	Preamp Factor (dB)	Antenna Height (cm)	Table Angle (Degree)	Remark
5430	40.61	39.87	54	-13.39	31.55	6.32	37.13	196	163	Average
5430	60.29	59.55	74	-13.71	31.55	6.32	37.13	196	163	Peak
5470	59.05	58.22	68.2	-9.15	31.57	6.34	37.08	196	163	Peak
5530	86.49	85.53			31.63	6.42	37.09	196	163	Average
5530	97.99	97.03			31.63	6.42	37.09	196	163	Peak
5725	59.59	58.31	68.2	-8.61	31.96	6.75	37.43	196	163	Peak

Remarks:

- Emission Level = Read Level + Antenna Factor + Cable Loss - Preamp Factor  
Margin value = Emission level – Limit value
- 5530 MHz: Fundamental Frequency
- 5470 MHz & 5725 MHz: Out of Restricted Band

EUT Test Condition		Measurement Detail	
Channel	Channel 122	Frequency Range	1 GHz ~ 40 GHz
Input Power	120 Vac, 60 Hz	Detector Function	Peak (PK) Average (AV)
Environmental Conditions	25 deg. C, 65 % RH	Tested By	Toby Tian

Antenna Polarity & Test Distance: Horizontal at 3 m										
Frequency (MHz)	Emission Level (dBuV/m)	Read Level (dBuV)	Limit (dBuV/m)	Margin (dB)	Antenna Factor (dB/m)	Cable Loss (dB)	Preamp Factor (dB)	Antenna Height (cm)	Table Angle (Degree)	Remark
5434	39.06	38.32	54	-14.94	31.55	6.32	37.13	196	232	Average
5434	60.96	60.22	74	-13.04	31.55	6.32	37.13	196	232	Peak
5470	59.56	58.73	68.2	-8.64	31.57	6.34	37.08	196	232	Peak
5610	87.3	86.19			31.77	6.56	37.22	196	232	Average
5610	98.26	97.15			31.77	6.56	37.22	196	232	Peak
5725	58.72	57.44	68.2	-9.48	31.96	6.75	37.43	196	232	Peak
Antenna Polarity & Test Distance: Vertical at 3 m										
Frequency (MHz)	Emission Level (dBuV/m)	Read Level (dBuV)	Limit (dBuV/m)	Margin (dB)	Antenna Factor (dB/m)	Cable Loss (dB)	Preamp Factor (dB)	Antenna Height (cm)	Table Angle (Degree)	Remark
5356	38.89	38.3	54	-15.11	31.48	6.29	37.18	195	170	Average
5356	60.75	60.16	74	-13.25	31.48	6.29	37.18	195	170	Peak
5470	57.85	57.02	68.2	-10.35	31.57	6.34	37.08	195	170	Peak
5610	86.87	85.76			31.77	6.56	37.22	195	170	Average
5610	97.51	96.4			31.77	6.56	37.22	195	170	Peak
5725	59.32	58.04	68.2	-8.88	31.96	6.75	37.43	195	170	Peak

Remarks:

- Emission Level = Read Level + Antenna Factor + Cable Loss - Preamp Factor  
Margin value = Emission level – Limit value
- 5610 MHz: Fundamental Frequency
- 5470 MHz & 5725 MHz: Out of Restricted Band

EUT Test Condition		Measurement Detail	
Channel	Channel 155	Frequency Range	1 GHz ~ 40 GHz
Input Power	120 Vac, 60 Hz	Detector Function	Peak (PK) Average (AV)
Environmental Conditions	25 deg. C, 65 % RH	Tested By	Toby Tian

Antenna Polarity & Test Distance: Horizontal at 3 m										
Frequency (MHz)	Emission Level (dBuV/m)	Read Level (dBuV)	Limit (dBuV/m)	Margin (dB)	Antenna Factor (dB/m)	Cable Loss (dB)	Preamp Factor (dB)	Antenna Height (cm)	Table Angle (Degree)	Remark
*5714	60.57	59.38	68.2	-7.63	31.93	6.69	37.43	193	240	Peak
*5725	59.81	58.53	78.2	-18.39	31.96	6.75	37.43	193	240	Peak
5775	86.21	84.85			32.04	6.82	37.5	193	240	Average
5775	97.53	96.17			32.04	6.82	37.5	193	240	Peak
*5850	59.75	58.23	78.2	-18.45	32.15	6.88	37.51	193	240	Peak
*5861	61.72	60.09	68.2	-6.48	32.18	6.95	37.5	193	240	Peak
Antenna Polarity & Test Distance: Vertical at 3 m										
Frequency (MHz)	Emission Level (dBuV/m)	Read Level (dBuV)	Limit (dBuV/m)	Margin (dB)	Antenna Factor (dB/m)	Cable Loss (dB)	Preamp Factor (dB)	Antenna Height (cm)	Table Angle (Degree)	Remark
*5714	59.24	58.05	68.2	-8.96	31.93	6.69	37.43	178	156	Peak
*5725	61.34	60.06	78.2	-16.86	31.96	6.75	37.43	178	156	Peak
5775	84.95	83.59			32.04	6.82	37.5	178	156	Average
5775	96.62	95.26			32.04	6.82	37.5	178	156	Peak
*5850	59.38	57.86	78.2	-18.82	32.15	6.88	37.51	178	156	Peak
*5861	60.94	59.31	68.2	-7.26	32.18	6.95	37.5	178	156	Peak

Remarks:

- Emission Level = Read Level + Antenna Factor + Cable Loss - Preamp Factor  
Margin value = Emission level – Limit value
- 5775 MHz: Fundamental Frequency
- \*: Out of Restricted Band

**9 kHz ~ 30 MHz DATA:**

The amplitude of spurious emissions attenuated more than 20 dB below the permissible value is not required to be report.

**30 MHz ~ 1 GHz WORST-CASE DATA:**

**802.11a**

EUT Test Condition		Measurement Detail	
Channel	Channel 36	Frequency Range	30 MHz ~ 1 GHz
Input Power	120 Vac, 60 Hz	Detector Function	Peak (PK) Quasi-peak (QP)
Environmental Conditions	25 deg. C, 65 % RH	Tested By	Toby Tian

Antenna Polarity & Test Distance: Horizontal at 3 m										
Frequency (MHz)	Emission Level (dBuV/m)	Read Level (dBuV)	Limit (dBuV/m)	Margin (dB)	Antenna Factor (dB/m)	Cable Loss (dB)	Preamp Factor (dB)	Antenna Height (cm)	Table Angle (Degree)	Remark
66.86	26.36	46.07	40	-13.64	11.12	0.85	31.68	113	7	Peak
79.47	32.27	54.55	40	-7.73	8.37	0.89	31.54	137	29	Peak
93.05	26.78	49.22	43.5	-16.72	8.53	0.99	31.96	110	11	Peak
143.49	28.16	46.16	43.5	-15.34	12.47	1.16	31.63	123	167	Peak
209.45	26.35	46.86	43.5	-17.15	9.77	1.33	31.61	107	185	Peak
228.85	25.36	45.22	46	-20.64	10.58	1.41	31.85	122	3	Peak

Antenna Polarity & Test Distance: Vertical at 3 m										
Frequency (MHz)	Emission Level (dBuV/m)	Read Level (dBuV)	Limit (dBuV/m)	Margin (dB)	Antenna Factor (dB/m)	Cable Loss (dB)	Preamp Factor (dB)	Antenna Height (cm)	Table Angle (Degree)	Remark
37.76	35.98	53.13	40	-4.02	13.24	0.63	31.02	136	133	Peak
62.98	36.02	55.1	40	-3.98	11.59	0.83	31.5	136	21	Peak
79.47	35.33	57.61	40	-4.67	8.37	0.89	31.54	111	263	Peak
144.46	24.59	42.55	43.5	-18.91	12.51	1.16	31.63	121	31	Peak
217.21	22.47	42.69	46	-23.53	10.09	1.36	31.67	124	71	Peak
556.71	20.66	31.89	46	-25.34	18.61	2.19	32.03	106	210	Peak

Remarks:

- Emission Level = Read Level + Antenna Factor + Cable Loss - Preamp Factor  
Margin value = Emission level – Limit value

802.11ac (VHT80)

EUT Test Condition		Measurement Detail	
Channel	Channel 58	Frequency Range	30 MHz ~ 1 GHz
Input Power	120 Vac, 60 Hz	Detector Function	Peak (PK) Quasi-peak (QP)
Environmental Conditions	25 deg. C, 65 % RH	Tested By	Toby Tian

**Antenna Polarity & Test Distance: Horizontal at 3 m**

Frequency (MHz)	Emission Level (dBuV/m)	Read Level (dBuV)	Limit (dBuV/m)	Margin (dB)	Antenna Factor (dB/m)	Cable Loss (dB)	Preamp Factor (dB)	Antenna Height (cm)	Table Angle (Degree)	Remark
81.41	32.61	55.12	40	-7.39	8.15	0.9	31.56	129	0	Peak
93.05	26.92	49.36	43.5	-16.58	8.53	0.99	31.96	138	241	Peak
138.64	26.14	44.38	43.5	-17.36	12.27	1.15	31.66	131	240	Peak
218.18	26.19	46.38	46	-19.81	10.13	1.37	31.69	105	208	Peak
241.46	24.68	43.92	46	-21.32	11.11	1.46	31.81	136	256	Peak
643.04	21.74	31.34	46	-24.26	20.13	2.34	32.07	133	142	Peak

**Antenna Polarity & Test Distance: Vertical at 3 m**

Frequency (MHz)	Emission Level (dBuV/m)	Read Level (dBuV)	Limit (dBuV/m)	Margin (dB)	Antenna Factor (dB/m)	Cable Loss (dB)	Preamp Factor (dB)	Antenna Height (cm)	Table Angle (Degree)	Remark
38.73	36.01	52.99	40	-3.99	13.39	0.63	31	114	105	Peak
62.98	36.13	55.21	40	-3.87	11.59	0.83	31.5	116	200	Peak
77.53	35.29	57.16	40	-4.71	8.85	0.87	31.59	118	175	Peak
542.16	20.93	32.26	46	-25.07	18.28	2.16	31.77	138	171	Peak
594.54	21.23	31.69	46	-24.77	19.48	2.25	32.19	116	76	Peak
709.97	23.18	31.49	46	-22.82	20.96	2.47	31.74	137	294	Peak

Remarks:

- Emission Level = Read Level + Antenna Factor + Cable Loss - Preamp Factor  
Margin value = Emission level – Limit value

### 802.11n (HT20)

EUT Test Condition		Measurement Detail	
Channel	Channel 100	Frequency Range	30 MHz ~ 1 GHz
Input Power	120 Vac, 60 Hz	Detector Function	Peak (PK) Quasi-peak (QP)
Environmental Conditions	25 deg. C, 65 % RH	Tested By	Toby Tian

#### Antenna Polarity & Test Distance: Horizontal at 3 m

Frequency (MHz)	Emission Level (dBuV/m)	Read Level (dBuV)	Limit (dBuV/m)	Margin (dB)	Antenna Factor (dB/m)	Cable Loss (dB)	Preamp Factor (dB)	Antenna Height (cm)	Table Angle (Degree)	Remark
70.74	30.04	50.45	40	-9.96	10.53	0.85	31.79	113	307	Peak
81.41	33.56	56.07	40	-6.44	8.15	0.9	31.56	107	47	Peak
91.11	27.54	50.15	43.5	-15.96	8.38	0.97	31.96	103	126	Peak
144.46	25.68	43.64	43.5	-17.82	12.51	1.16	31.63	135	238	Peak
228.85	25.21	45.07	46	-20.79	10.58	1.41	31.85	112	30	Peak
593.57	21.69	32.17	46	-24.31	19.46	2.24	32.18	131	53	Peak

#### Antenna Polarity & Test Distance: Vertical at 3 m

Frequency (MHz)	Emission Level (dBuV/m)	Read Level (dBuV)	Limit (dBuV/m)	Margin (dB)	Antenna Factor (dB/m)	Cable Loss (dB)	Preamp Factor (dB)	Antenna Height (cm)	Table Angle (Degree)	Remark
38.73	35.11	52.09	40	-4.89	13.39	0.63	31	126	341	Peak
61.04	34.53	53.3	40	-5.47	11.82	0.82	31.41	108	83	Peak
77.53	34.81	56.68	40	-5.19	8.85	0.87	31.59	100	85	Peak
142.52	26.2	44.23	43.5	-17.3	12.44	1.16	31.63	128	293	Peak
227.88	20.81	40.69	46	-25.19	10.54	1.41	31.83	129	68	Peak
728.4	23.8	31.68	46	-22.2	21.22	2.5	31.6	129	333	Peak

Remarks:

- Emission Level = Read Level + Antenna Factor + Cable Loss - Preamp Factor  
Margin value = Emission level – Limit value

802.11n (HT40)

EUT Test Condition		Measurement Detail	
Channel	Channel 151	Frequency Range	30 MHz ~ 1 GHz
Input Power	120 Vac, 60 Hz	Detector Function	Peak (PK) Quasi-peak (QP)
Environmental Conditions	25 deg. C, 65 % RH	Tested By	Toby Tian

Antenna Polarity & Test Distance: Horizontal at 3 m										
Frequency (MHz)	Emission Level (dBuV/m)	Read Level (dBuV)	Limit (dBuV/m)	Margin (dB)	Antenna Factor (dB/m)	Cable Loss (dB)	Preamp Factor (dB)	Antenna Height (cm)	Table Angle (Degree)	Remark
83.35	32.46	55.01	40	-7.54	8.18	0.92	31.65	116	302	Peak
143.49	28.28	46.28	43.5	-15.22	12.47	1.16	31.63	137	138	Peak
207.51	26.84	47.46	43.5	-16.66	9.69	1.33	31.64	112	39	Peak
223.03	26.17	46.19	46	-19.83	10.34	1.39	31.75	120	208	Peak
617.82	22.74	32.78	46	-23.26	19.82	2.29	32.15	125	299	Peak
703.18	23.14	31.61	46	-22.86	20.86	2.45	31.78	127	202	Peak

Antenna Polarity & Test Distance: Vertical at 3 m										
Frequency (MHz)	Emission Level (dBuV/m)	Read Level (dBuV)	Limit (dBuV/m)	Margin (dB)	Antenna Factor (dB/m)	Cable Loss (dB)	Preamp Factor (dB)	Antenna Height (cm)	Table Angle (Degree)	Remark
37.76	35.73	52.88	40	-4.27	13.24	0.63	31.02	129	267	Peak
62.01	35.33	54.24	40	-4.67	11.71	0.83	31.45	132	142	Peak
80.44	34.91	57.4	40	-5.09	8.13	0.89	31.51	127	280	Peak
141.55	26.13	44.19	43.5	-17.37	12.41	1.16	31.63	107	335	Peak
224.97	22.39	42.35	46	-23.61	10.42	1.4	31.78	122	103	Peak
743.92	23.9	31.34	46	-22.1	21.44	2.53	31.41	109	24	Peak

Remarks:

- Emission Level = Read Level + Antenna Factor + Cable Loss - Preamp Factor  
Margin value = Emission level – Limit value



## 4.2 Conducted Emission Measurement

### 4.2.1 Limits of Conducted Emission Measurement

Frequency (MHz)	Conducted Limit (dBuV)	
	Quasi-peak	Average
0.15 - 0.5	66 - 56	56 - 46
0.50 - 5.0	56	46
5.0 - 30.0	60	50

Note: 1. The lower limit shall apply at the transition frequencies.

2. The limit decreases in line with the logarithm of the frequency in the range of 0.15 to 0.50 MHz.

### 4.2.2 Test Instruments

Description & Manufacturer	Model No.	Serial No.	Date Of Calibration	Due Date Of Calibration
Test Receiver ROHDE & SCHWARZ	ESCI	100613	Nov. 16, 2015	Nov. 15, 2016
RF signal cable (with 10dB PAD) Woken	5D-FB	Cable-cond1-01	Dec. 26, 2015	Dec. 25, 2016
LISN ROHDE & SCHWARZ (EUT)	ESH3-Z5	835239/001	Feb. 26, 2016	Feb. 25, 2017
LISN ROHDE & SCHWARZ (Peripheral)	ESH3-Z5	100311	Jul. 24, 2015	Jul. 23, 2016
Software ADT	BV ADT_Cond_ V7.3.7.3	NA	NA	NA

- Note:**
1. The calibration interval of the above test instruments is 12 months and the calibrations are traceable to NML/ROC and NIST/USA.
  2. The test was performed in HwaYa Shielded Room 1.
  3. The VCCI Site Registration No. is C-2040.

#### 4.2.3 Test Procedures

- a. The EUT was placed 0.4 meters from the conducting wall of the shielded room with EUT being connected to the power mains through a line impedance stabilization network (LISN). Other support units were connected to the power mains through another LISN. The two LISNs provide 50 ohm/ 50uH of coupling impedance for the measuring instrument.
- b. Both lines of the power mains connected to the EUT were checked for maximum conducted interference.
- c. The frequency range from 150 kHz to 30 MHz was searched. Emission levels under (Limit -20 dB) was not recorded.

**NOTE:** All modes of operation were investigated and the worst-case emissions are reported.

#### 4.2.4 Deviation from Test Standard

No deviation.

#### 4.2.5 Test Setup

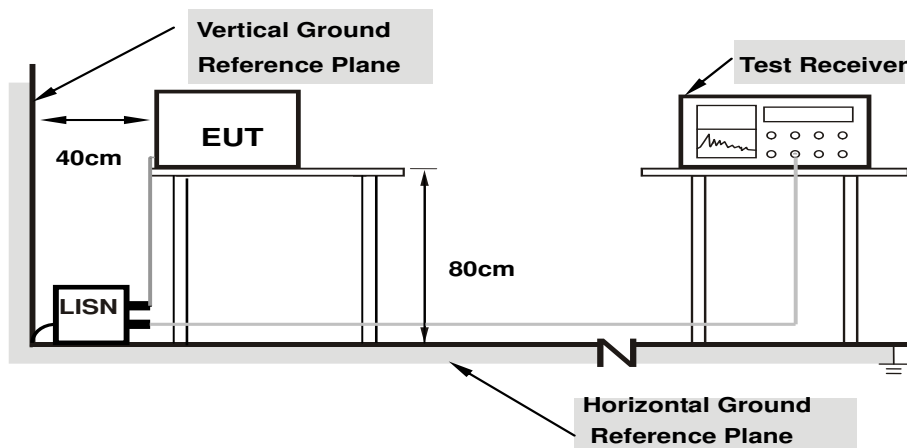

- Note: 1.Support units were connected to second LISN.**  
**2.Both of LISNs (AMN) are 80 cm from EUT and at least 80 from other units and other metal planes**

For the actual test configuration, please refer to the attached file (Test Setup Photo).

#### 4.2.6 EUT Operating Conditions

- a. Placed the EUT on a testing table.
- b. Use the software to control the EUT under transmission condition continuously at specific channel frequency.

#### 4.2.7 Test Results

Frequency Range	150kHz ~ 30MHz	Detector Function & Resolution Bandwidth	Quasi-Peak (QP) / Average (AV), 9kHz
Input Power	120Vac, 60Hz	Environmental Conditions	25°C, 65%RH
Tested by	Toby Tian	Test Date	2016/4/29

Phase Of Power : Line (L)										
No	Frequency (MHz)	Correction Factor (dB)	Reading Value (dBuV)		Emission Level (dBuV)		Limit (dBuV)		Margin (dB)	
			Q.P.	AV.	Q.P.	AV.	Q.P.	AV.	Q.P.	AV.
1	0.19572	10.03	26.20	12.54	36.23	22.57	63.79	53.79	-27.56	-31.22
2	0.26499	10.06	28.33	17.40	38.39	27.46	61.27	51.27	-22.88	-23.81
3	0.53800	10.14	21.88	9.79	32.02	19.93	56.00	46.00	-23.98	-26.07
4	0.77400	10.17	26.84	11.88	37.01	22.05	56.00	46.00	-18.99	-23.95
5	1.01400	10.20	26.43	13.69	36.63	23.89	56.00	46.00	-19.37	-22.11
6	2.26600	10.29	26.79	15.64	37.08	25.93	56.00	46.00	-18.92	-20.07

Remarks:

1. Q.P. and AV. are abbreviations of quasi-peak and average individually.
2. The emission levels of other frequencies were very low against the limit.
3. Margin value = Emission level – Limit value
4. Correction factor = Insertion loss + Cable loss
5. Emission Level = Correction Factor + Reading Value

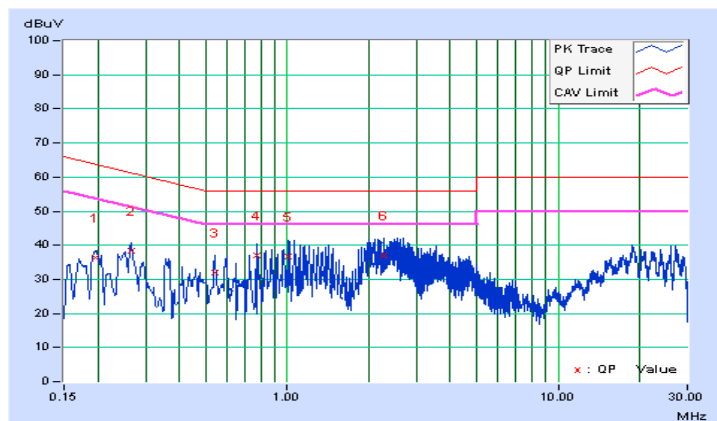

Frequency Range	150kHz ~ 30MHz	Detector Function & Resolution Bandwidth	Quasi-Peak (QP) / Average (AV), 9kHz
Input Power	120Vac, 60Hz	Environmental Conditions	25°C, 65%RH
Tested by	Toby Tian	Test Date	2016/4/29

Phase Of Power : Neutral (N)										
No	Frequency (MHz)	Correction Factor (dB)	Reading Value (dBuV)		Emission Level (dBuV)		Limit (dBuV)		Margin (dB)	
			Q.P.	AV.	Q.P.	AV.	Q.P.	AV.	Q.P.	AV.
1	0.15400	10.03	31.02	18.97	41.05	29.00	65.78	55.78	-24.74	-26.79
2	0.18200	10.03	29.18	18.94	39.21	28.97	64.39	54.39	-25.18	-25.42
3	0.25006	10.06	26.50	20.79	36.56	30.85	61.76	51.76	-25.19	-20.90
4	0.25006	10.06	26.43	20.79	36.49	30.85	61.76	51.76	-25.26	-20.90
5	0.99800	10.21	22.23	15.06	32.44	25.27	56.00	46.00	-23.56	-20.73
6	2.12200	10.29	25.29	16.94	35.58	27.23	56.00	46.00	-20.42	-18.77

Remarks:

1. Q.P. and AV. are abbreviations of quasi-peak and average individually.
2. The emission levels of other frequencies were very low against the limit.
3. Margin value = Emission level – Limit value
4. Correction factor = Insertion loss + Cable loss
5. Emission Level = Correction Factor + Reading Value

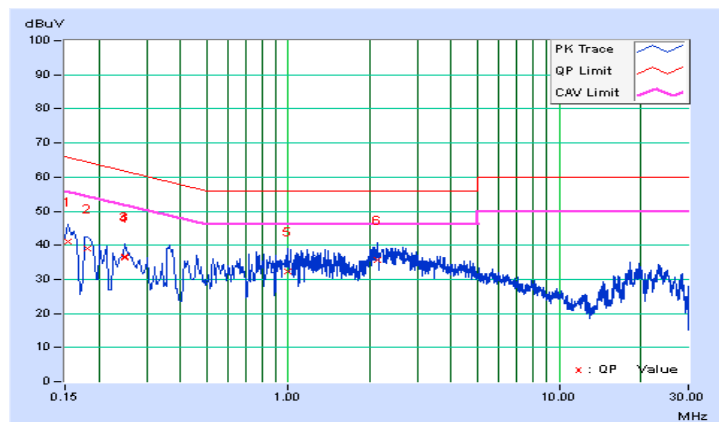

### 4.3 Transmit Power Measurement

#### 4.3.1 Limits of Transmit Power Measurement

Operation Band	EUT Category	Limit
U-NII-1	Outdoor Access Point	1 Watt (30 dBm) (Max. e.i.r.p $\leq$ 125 mW (21 dBm) at any elevation angle above 30 degrees as measured from the horizon)
	Fixed point-to-point Access Point	1 Watt (30 dBm)
	Indoor Access Point	1 Watt (30 dBm)
	√ Mobile and Portable client device	250 mW (24 dBm)
U-NII-2A	√	250 mW (24 dBm) or 11 dBm+10 log B*
U-NII-2C	√	250 mW (24 dBm) or 11 dBm+10 log B*
U-NII-3	√	1 Watt (30 dBm)

\*B is the 26 dB emission bandwidth in megahertz

#### 4.3.2 Test Setup

##### <Power Output Measurement>

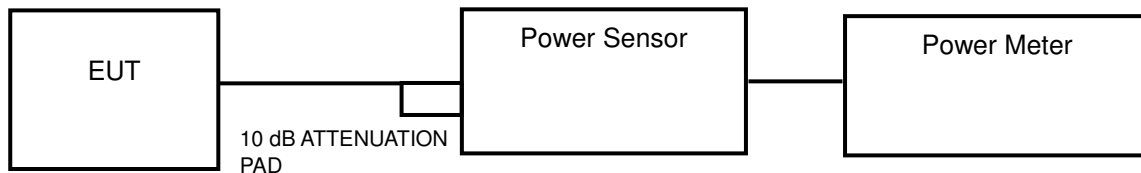

or



##### <26 dB Bandwidth>

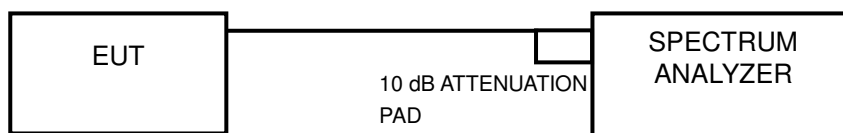

#### 4.3.3 Test Instruments

Refer to section 4.1.2 to get information of above instrument.

#### 4.3.4 Test Procedure

##### **Average Power Measurement**

<802.11a, 802.11n (HT20), 802.11n (HT40)>

Method PM is used to perform output power measurement, trigger and gating function of wide band power meter is enabled to measure max output power of TX on burst. Duty factor is not added to measured value.

<802.11ac (VHT80)>

Method SA-1 is used to perform output power measurement, trigger and gating function of spectrum analyzer is enabled to measure max output power of TX on burst. Duty factor is not added to measured value.

##### **26 dB Bandwidth**

- 1) Set RBW = approximately 1 % of the emission bandwidth.
- 2) Set the VBW > RBW.
- 3) Detector = Peak.
- 4) Trace mode = max hold.
- 5) Measure the maximum width of the emission that is 26 dB down from the peak of the emission. Compare this with the RBW setting of the analyzer. Readjust RBW and repeat measurement as needed until the RBW/EBW ratio is approximately 1 %.

#### 4.3.5 Deviation from Test Standard

No deviation.

#### 4.3.6 EUT Operating Conditions

The software provided by client to enable the EUT under transmission condition continuously at lowest, middle and highest channel frequencies individually.

#### 4.3.7 Test Result

##### Power Output:

##### 802.11a

Channel	Frequency (MHz)	Maximum Conducted Power (mW)	Maximum Conducted Power (dBm)	Power Limit (dBm)	Pass / Fail
36	5180	48.31	16.84	24	Pass
44	5220	86.70	19.38	24	Pass
48	5240	85.31	19.31	24	Pass
52	5260	84.72	19.28	24	Pass
60	5300	77.80	18.91	24	Pass
64	5320	45.19	16.55	24	Pass
100	5500	28.91	14.61	24	Pass
116	5580	82.99	19.19	24	Pass
140	5700	26.18	14.18	24	Pass
149	5745	16.14	12.08	30	Pass
157	5785	69.02	18.39	30	Pass
165	5825	42.07	16.24	30	Pass

##### Note:

##### For U-NII-2A, U-NII-2C Band:

1.  $11 \text{ dBm} + 10\log(29.47) = 25.69 \text{ dBm} > 24 \text{ dBm}$ .
2.  $11 \text{ dBm} + 10\log(30.41) = 25.83 \text{ dBm} > 24 \text{ dBm}$ .
3.  $11 \text{ dBm} + 10\log(22.52) = 24.53 \text{ dBm} > 24 \text{ dBm}$ .
4.  $11 \text{ dBm} + 10\log(22.56) = 24.53 \text{ dBm} > 24 \text{ dBm}$ .
5.  $11 \text{ dBm} + 10\log(28.71) = 25.58 \text{ dBm} > 24 \text{ dBm}$ .
6.  $11 \text{ dBm} + 10\log(22.71) = 24.56 \text{ dBm} > 24 \text{ dBm}$ .

### 802.11n (HT20)

Channel	Frequency (MHz)	Maximum Conducted Power (mW)	Maximum Conducted Power (dBm)	Power Limit (dBm)	Pass / Fail
36	5180	47.32	16.75	24	Pass
44	5220	86.30	19.36	24	Pass
48	5240	86.10	19.35	24	Pass
52	5260	83.95	19.24	24	Pass
60	5300	81.85	19.13	24	Pass
64	5320	44.77	16.51	24	Pass
100	5500	28.91	14.61	24	Pass
116	5580	82.79	19.18	24	Pass
140	5700	26.67	14.26	24	Pass
149	5745	16.33	12.13	30	Pass
157	5785	71.29	18.53	30	Pass
165	5825	42.56	16.29	30	Pass

**Note:**

**For U-NII-2A, U-NII-2C Band:**

1.  $11 \text{ dBm} + 10\log(32.41) = 26.11 \text{ dBm} > 24 \text{ dBm}$ .
2.  $11 \text{ dBm} + 10\log(29.96) = 25.77 \text{ dBm} > 24 \text{ dBm}$ .
3.  $11 \text{ dBm} + 10\log(23.22) = 24.66 \text{ dBm} > 24 \text{ dBm}$ .
4.  $11 \text{ dBm} + 10\log(22.98) = 24.61 \text{ dBm} > 24 \text{ dBm}$ .
5.  $11 \text{ dBm} + 10\log(32.40) = 26.11 \text{ dBm} > 24 \text{ dBm}$ .
6.  $11 \text{ dBm} + 10\log(22.97) = 24.61 \text{ dBm} > 24 \text{ dBm}$ .



### 802.11n (HT40)

Channel	Frequency (MHz)	Maximum Conducted Power (mW)	Maximum Conducted Power (dBm)	Power Limit (dBm)	Pass / Fail
38	5190	23.12	13.64	24	Pass
46	5230	34.59	15.39	24	Pass
54	5270	32.73	15.15	24	Pass
62	5310	19.45	12.89	24	Pass
102	5510	15.67	11.95	24	Pass
110	5550	33.04	15.19	24	Pass
134	5670	31.26	14.95	24	Pass
151	5755	18.49	12.67	30	Pass
159	5795	27.29	14.36	30	Pass

**Note:**

**For U-NII-2A, U-NII-2C Band:**

1.  $11 \text{ dBm} + 10\log(42.73) = 27.31 \text{ dBm} > 24 \text{ dBm}$ .
2.  $11 \text{ dBm} + 10\log(42.85) = 27.32 \text{ dBm} > 24 \text{ dBm}$ .
3.  $11 \text{ dBm} + 10\log(44.07) = 27.44 \text{ dBm} > 24 \text{ dBm}$ .
4.  $11 \text{ dBm} + 10\log(43.05) = 27.34 \text{ dBm} > 24 \text{ dBm}$ .
5.  $11 \text{ dBm} + 10\log(43.68) = 27.40 \text{ dBm} > 24 \text{ dBm}$ .

### 802.11ac (VHT80)

Channel	Frequency (MHz)	Maximum Conducted Power (mW)	Maximum Conducted Power (dBm)	Power Limit (dBm)	Pass / Fail
42	5210	20.84	13.19	24	Pass
58	5290	23.60	13.73	24	Pass
106	5530	24.04	13.81	24	Pass
122	5610	23.82	13.77	24	Pass
155	5775	16.63	12.21	30	Pass

**Note:**

**For U-NII-2A, U-NII-2C Band:**

- $11 \text{ dBm} + 10\log(85.31) = 30.31 \text{ dBm} > 24 \text{ dBm}$ .
- $11 \text{ dBm} + 10\log(85.30) = 30.31 \text{ dBm} > 24 \text{ dBm}$ .
- $11 \text{ dBm} + 10\log(84.96) = 30.29 \text{ dBm} > 24 \text{ dBm}$ .

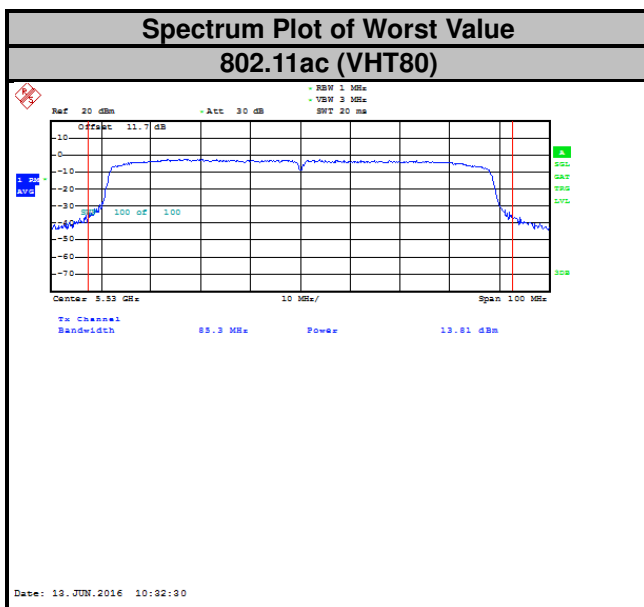

**26 dB Bandwidth:**
**802.11a**

Channel	Frequency (MHz)	26 dBc Bandwidth (MHz)
36	5180	22.64
44	5220	30.30
48	5240	26.86
52	5260	29.47
60	5300	30.41
64	5320	22.52
100	5500	22.56
116	5580	28.71
140	5700	22.71

**802.11n (HT20)**

Channel	Frequency (MHz)	26 dBc Bandwidth (MHz)
36	5180	22.79
44	5220	31.42
48	5240	31.22
52	5260	32.41
60	5300	29.96
64	5320	23.22
100	5500	22.98
116	5580	32.40
140	5700	22.97

**802.11n (HT40)**

Channel	Frequency (MHz)	26 dBc Bandwidth (MHz)
38	5190	42.69
46	5230	43.19
54	5270	42.73
62	5310	42.85
102	5510	44.07
110	5550	43.05
134	5670	43.68

### 802.11ac (VHT80)

Channel	Frequency (MHz)	26 dBc Bandwidth (MHz)
42	5210	85.60
58	5290	85.31
106	5530	85.30
122	5610	84.96

### Spectrum Plot of Worst Value

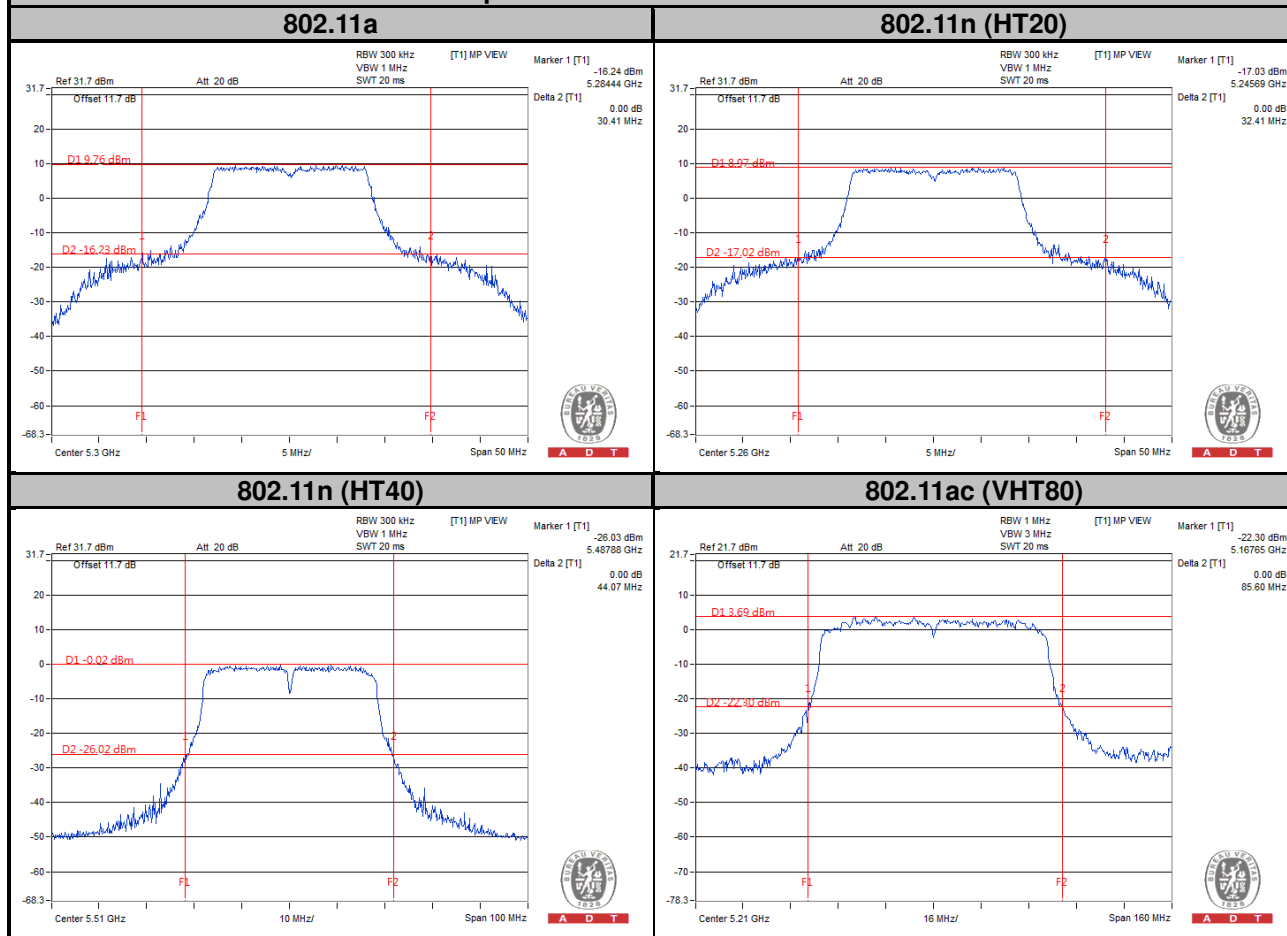

#### 4.4 Peak Power Spectral Density Measurement

##### 4.4.1 Limits of Peak Power Spectral Density Measurement

Operation Band	EUT Category		Limit
U-NII-1		Outdoor Access Point	17 dBm/MHz
		Fixed point-to-point Access Point	
		Indoor Access Point	
	√	Mobile and Portable client device	11 dBm/MHz
U-NII-2A		√	11 dBm/MHz
U-NII-2C		√	11 dBm/MHz
U-NII-3		√	30 dBm/500 kHz

##### 4.4.2 Test Setup

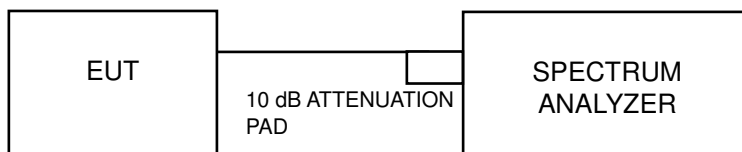

##### 4.4.3 Test Instruments

Refer to section 4.1.3 to get information of above instrument.

##### 4.4.4 Test Procedures

###### For U-NII-1, U-NII-2A, U-NII-2C band:

Using method SA-2

1. Set span to encompass the entire emission bandwidth (EBW) of the signal.
2. Set RBW = 1 MHz, Set VBW ≥ 3 RBW, Detector = RMS
3. Sweep time = auto, trigger set to “free run”.
4. Trace average at least 100 traces in power averaging mode.
5. Record the max value and add 10 log (1/duty cycle)

###### ※For U-NII-3:

1. Set span to encompass the entire emission bandwidth (EBW) of the signal.
2. Set RBW = 500 kHz, Set VBW ≥ 3 RBW, Detector = RMS
3. Use the peak marker function to determine the maximum power level in any 500 kHz band segment within the fundamental EBW.
4. Sweep time = auto, trigger set to “free run”.
5. Trace average at least 100 traces in power averaging mode.
6. Record the max value and add 10 log (1/duty cycle)

#### 4.4.5 Deviation from Test Standard

No deviation.

#### 4.4.6 EUT Operating Conditions

The software provided by client to enable the EUT under transmission condition continuously at lowest, middle and highest channel frequencies individually.

#### 4.4.7 Test Results

##### 802.11a

Channel	Frequency (MHz)	PSD w/o Duty Factor (dBm)	Duty Factor	PSD with Duty Factor (dBm)	Maximum Limit (dBm)	Pass / Fail
36	5180	1.78	0.98	2.76	11	Pass
44	5220	4.59	0.98	5.57	11	Pass
48	5240	4.69	0.98	5.67	11	Pass
52	5260	4.83	0.98	5.81	11	Pass
60	5300	5.11	0.98	6.09	11	Pass
64	5320	2.74	0.98	3.72	11	Pass
100	5500	1.49	0.98	2.47	11	Pass
116	5580	5.56	0.98	6.54	11	Pass
140	5700	0.47	0.98	1.45	11	Pass

**Note:** Refer to section 3.3 for duty cycle spectrum plot.

##### 802.11n (HT20)

Channel	Frequency (MHz)	PSD w/o Duty Factor (dBm)	Duty Factor	PSD with Duty Factor (dBm)	Maximum Limit (dBm)	Pass / Fail
36	5180	1.43	1.05	2.48	11	Pass
44	5220	4.31	1.05	5.36	11	Pass
48	5240	4.44	1.05	5.49	11	Pass
52	5260	4.65	1.05	5.70	11	Pass
60	5300	4.92	1.05	5.97	11	Pass
64	5320	2.43	1.05	3.48	11	Pass
100	5500	1.25	1.05	2.30	11	Pass
116	5580	5.37	1.05	6.42	11	Pass
140	5700	0.09	1.05	1.14	11	Pass

**Note:** Refer to section 3.3 for duty cycle spectrum plot.

### 802.11n (HT40)

Channel	Frequency (MHz)	PSD w/o Duty Factor (dBm)	Duty Factor	PSD with Duty Factor (dBm)	Maximum Limit (dBm)	Pass / Fail
38	5190	-2.58	2.01	-0.57	11	Pass
46	5230	-1.30	2.01	0.71	11	Pass
54	5270	-1.01	2.01	1.00	11	Pass
62	5310	-0.87	2.01	1.14	11	Pass
102	5510	0.14	2.01	2.15	11	Pass
110	5550	-0.06	2.01	1.95	11	Pass
134	5670	-0.91	2.01	1.10	11	Pass

**Note:** Refer to section 3.3 for duty cycle spectrum plot.

### 802.11ac (VHT80)

Channel	Frequency (MHz)	PSD w/o Duty Factor (dBm)	Duty Factor	PSD with Duty Factor (dBm)	Maximum Limit (dBm)	Pass / Fail
42	5210	-6.84	5.53	-1.31	11	Pass
58	5290	-5.29	5.53	0.24	11	Pass
106	5530	-4.31	5.53	1.22	11	Pass
122	5610	-4.92	5.53	0.61	11	Pass

**Note:** Refer to section 3.3 for duty cycle spectrum plot.



### Spectrum Plot of Worst Value

#### 802.11a

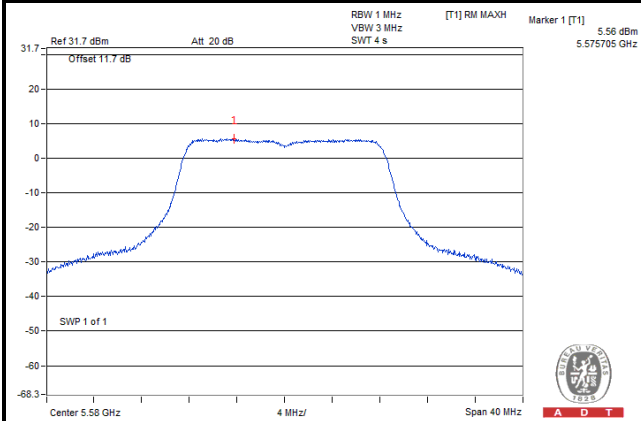

#### 802.11n (HT20)

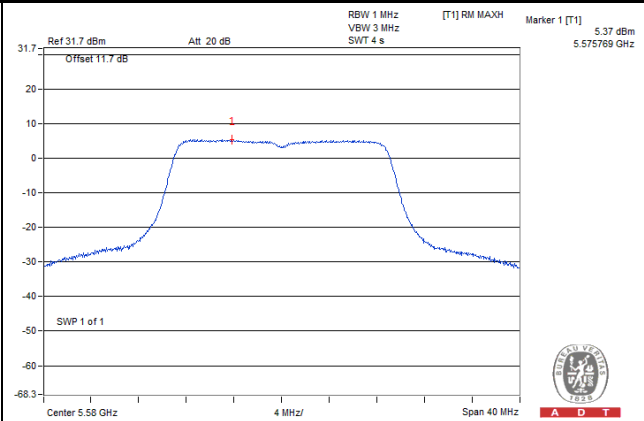

#### 802.11n (HT40)

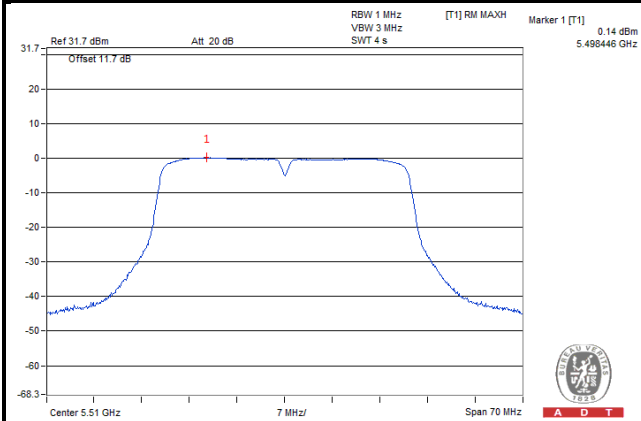

#### 802.11ac (VHT80)

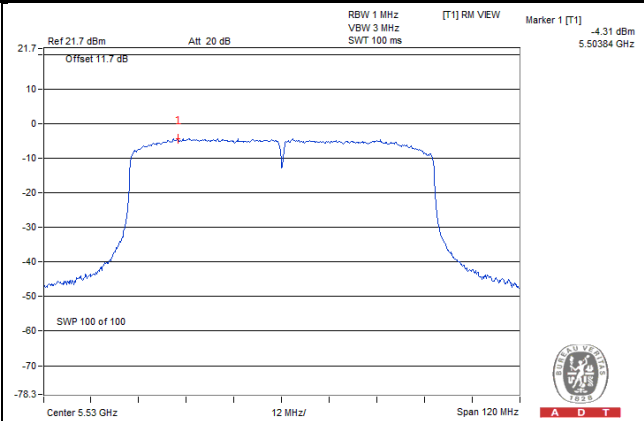

## For U-NII-3 Band

### 802.11a

Channel	Frequency (MHz)	PSD w/o Duty Factor (dBm)	Duty Factor	PSD with Duty Factor (dBm)	Limit (dBm/500 kHz)	Pass / Fail
149	5745	-3.95	0.98	-2.97	30	Pass
157	5785	2.68	0.98	3.66	30	Pass
165	5825	0.69	0.98	1.67	30	Pass

**Note:** Refer to section 3.3 for duty cycle spectrum plot.

### 802.11n (HT20)

Channel	Frequency (MHz)	PSD w/o Duty Factor (dBm)	Duty Factor	PSD with Duty Factor (dBm)	Limit (dBm/500 kHz)	Pass / Fail
149	5745	-4.18	1.05	-3.13	30	Pass
157	5785	2.50	1.05	3.55	30	Pass
165	5825	0.21	1.05	1.26	30	Pass

**Note:** Refer to section 3.3 for duty cycle spectrum plot.

### 802.11n (HT40)

Channel	Frequency (MHz)	PSD w/o Duty Factor (dBm)	Duty Factor	PSD with Duty Factor (dBm)	Limit (dBm/500 kHz)	Pass / Fail
151	5755	-6.22	2.01	-4.21	30	Pass
159	5795	-3.70	2.01	-1.69	30	Pass

**Note:** Refer to section 3.3 for duty cycle spectrum plot.

### 802.11ac (VHT80)

Channel	Frequency (MHz)	PSD w/o Duty Factor (dBm)	Duty Factor	PSD with Duty Factor (dBm)	Limit (dBm/500 kHz)	Pass / Fail
155	5775	-8.37	5.53	-2.84	30	Pass

**Note:** Refer to section 3.3 for duty cycle spectrum plot.

### Spectrum Plot of Worst Value

#### 802.11a

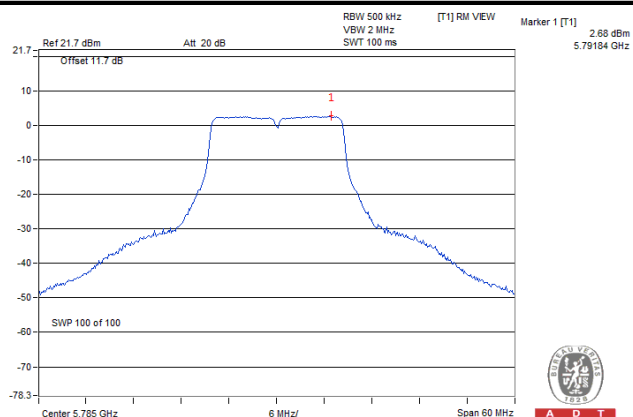

#### 802.11n (HT20)

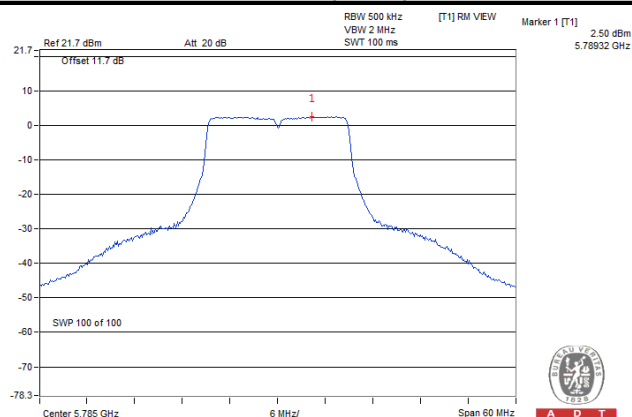

#### 802.11n (HT40)

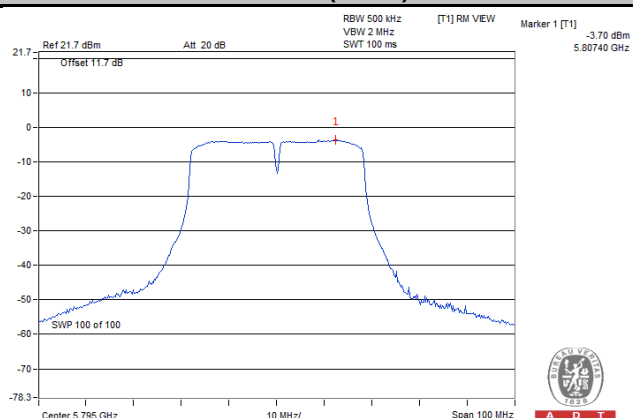

#### 802.11ac (VHT80)

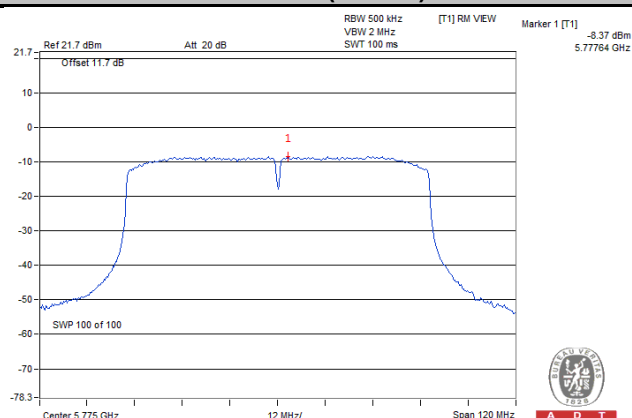

## 4.5 Frequency Stability

### 4.5.1 Limit of Frequency Stability Measurement

The frequency of the carrier signal shall be maintained within band of operation.

### 4.5.2 Test Setup

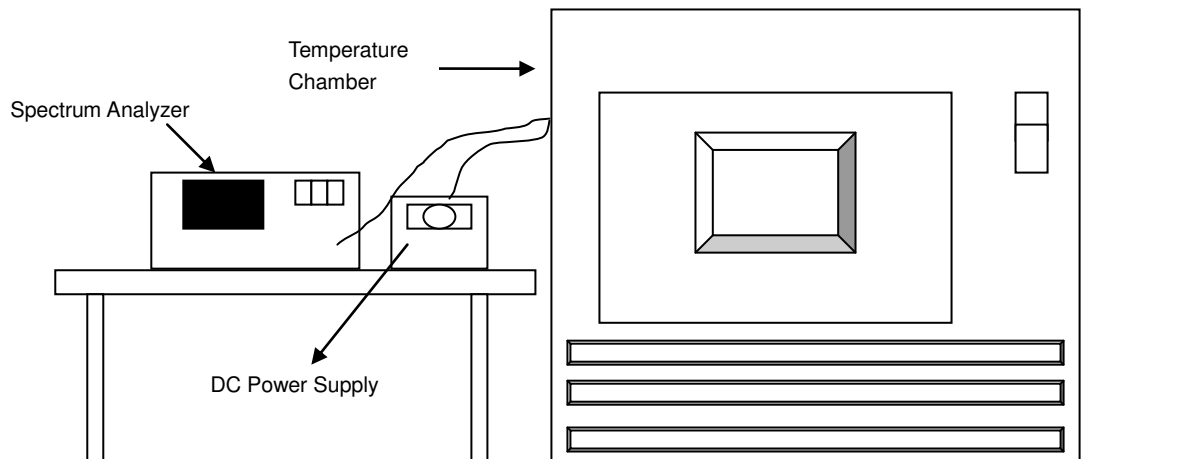

### 4.5.3 Test Instruments

Refer to section 4.1.3 to get information of above instrument.

### 4.5.4 Test Procedure

- a. To ensure emission at the band edge is maintained within the authorized band, those values shall be measured by radiation emissions at upper and lower frequency points, and finally compensated by frequency deviation as procedures below.
- b. The EUT was operated at the maximum output power, and connected to the spectrum analyzer, which is set to maximum hold function and peak detector. The peak value of the power envelope was measured and noted. The upper and lower frequency points were respectively measured relatively 10 dB lower than the measured peak value.
- c. The frequency deviation was calculated by adding the upper frequency point and the lower frequency point divided by two. Those detailed values of frequency deviation are provided in table below.

### 4.5.5 Deviation from Test Standard

No deviation.

### 4.5.6 EUT Operating Condition

Set the EUT transmit at un-modulation mode to test frequency stability.

#### 4.5.7 Test Results

Frequency Stability Versus Temp.									
Operating Frequency: 5320 MHz									
Temp. (°C)	Power Supply (Vdc)	0 Minute		2 Minute		5 Minute		10 Minute	
		Measured Frequency (MHz)	Frequency Drift (ppm)	Measured Frequency (MHz)	Frequency Drift (ppm)	Measured Frequency (MHz)	Frequency Drift (ppm)	Measured Frequency (MHz)	Frequency Drift (ppm)
55	3.8	5320.017915	3.367	5320.017769	3.340	5320.017691	3.325	5320.017987	3.381
50	3.8	5320.018288	3.438	5320.018646	3.505	5320.018598	3.496	5320.018310	3.442
40	3.8	5320.018559	3.489	5320.018654	3.506	5320.018703	3.516	5320.018095	3.401
30	3.8	5320.019766	3.715	5320.019834	3.728	5320.019972	3.754	5320.019808	3.723
20	3.8	5320.020319	3.819	5320.020154	3.788	5320.021048	3.956	5320.020769	3.904
10	3.8	5320.022113	4.157	5320.021858	4.109	5320.022132	4.160	5320.022286	4.189
0	3.8	5320.020295	3.815	5320.020471	3.848	5320.020458	3.845	5320.020688	3.889
-10	3.8	5320.019140	3.598	5320.018890	3.551	5320.019345	3.636	5320.019261	3.620
-20	3.8	5320.018598	3.496	5320.018888	3.550	5320.018779	3.530	5320.018356	3.450
-30	3.8	5320.017080	3.211	5320.017914	3.367	5320.017220	3.237	5320.017577	3.304

Frequency Stability Versus Temp.									
Operating Frequency: 5320 MHz									
Temp. (°C)	Power Supply (Vdc)	0 Minute		2 Minute		5 Minute		10 Minute	
		Measured Frequency (MHz)	Frequency Drift (ppm)	Measured Frequency (MHz)	Frequency Drift (ppm)	Measured Frequency (MHz)	Frequency Drift (ppm)	Measured Frequency (MHz)	Frequency Drift (ppm)
20	3.3	5320.029507	5.546	5320.029690	5.581	5320.029616	5.567	5320.029893	5.619
	3.8	5320.020319	3.819	5320.020154	3.788	5320.021048	3.956	5320.020769	3.904
	4.35	5320.031570	5.934	5320.031257	5.875	5320.031126	5.851	5320.031256	5.875

## 4.6 6 dB Bandwidth Measurement

### 4.6.1 Limits of 6 dB Bandwidth Measurement

The minimum of 6 dB Bandwidth Measurement is 0.5 MHz.

### 4.6.2 Test Setup

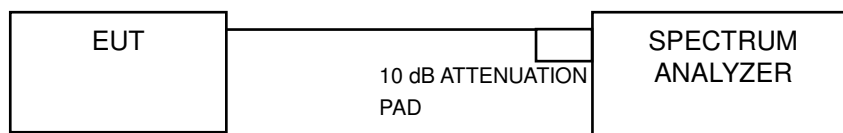

### 4.6.3 Test Instruments

Refer to section 4.1.3 to get information of above instrument.

### 4.6.4 Test Procedure

#### MEASUREMENT PROCEDURE REF

- Set resolution bandwidth (RBW) = 100 kHz
- Set the video bandwidth (VBW)  $\geq 3 \times$  RBW, Detector = Peak.
- Trace mode = max hold.
- Sweep = auto couple.
- Measure the maximum width of the emission that is constrained by the frequencies associated with the two amplitude points (upper and lower) that are attenuated by 6 dB relative to the maximum level measured in the fundamental emission

### 4.6.5 Deviation from Test Standard

No deviation.

### 4.6.6 EUT Operating Condition

The software provided by client to enable the EUT under transmission condition continuously at lowest, middle and highest channel frequencies individually.

#### 4.6.7 Test Results

##### 802.11a

Channel	Frequency (MHz)	6 dB Bandwidth (MHz)	Minimum Limit (MHz)	Pass / Fail
149	5745	16.41	0.5	Pass
157	5785	16.42	0.5	Pass
165	5825	16.40	0.5	Pass

##### 802.11n (HT20)

Channel	Frequency (MHz)	6 dB Bandwidth (MHz)	Minimum Limit (MHz)	Pass / Fail
149	5745	17.64	0.5	Pass
157	5785	17.64	0.5	Pass
165	5825	17.63	0.5	Pass

##### 802.11n (HT40)

Channel	Frequency (MHz)	6 dB Bandwidth (MHz)	Minimum Limit (MHz)	Pass / Fail
151	5755	35.67	0.5	Pass
159	5795	35.46	0.5	Pass

##### 802.11ac (VHT80)

Channel	Frequency (MHz)	6 dB Bandwidth (MHz)	Minimum Limit (MHz)	Pass / Fail
155	5775	75.30	0.5	Pass

### Spectrum Plot of Worst Value

#### 802.11a

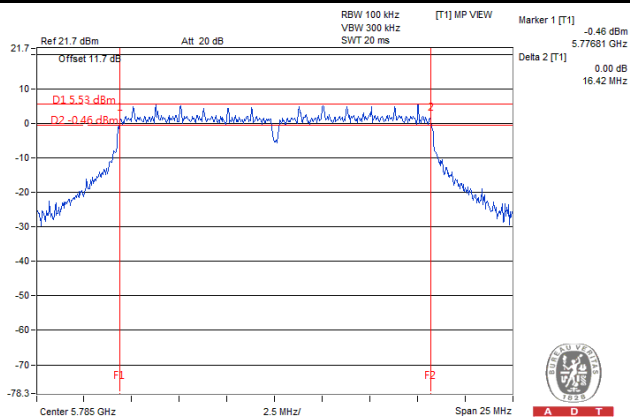

#### 802.11n (HT20)

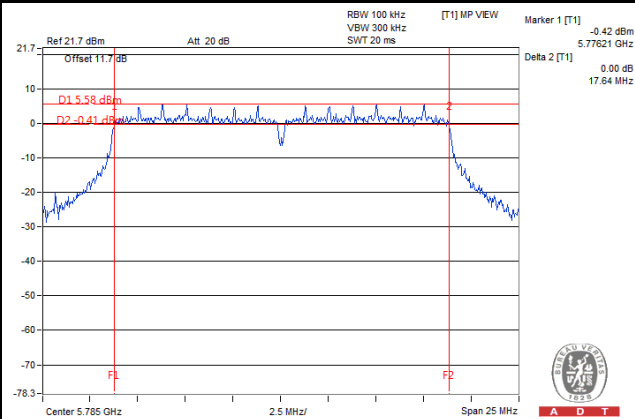

#### 802.11n (HT40)

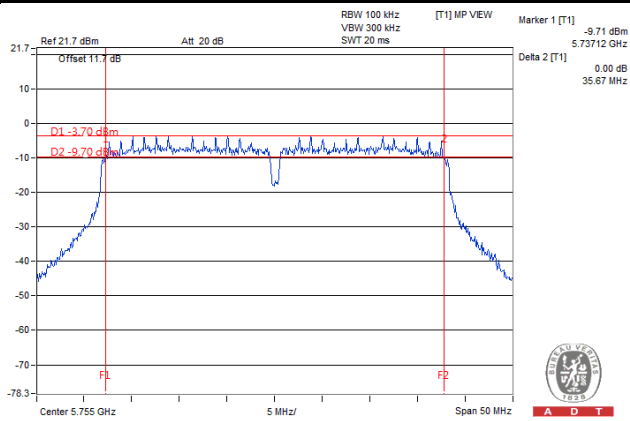

#### 802.11ac (VHT80)

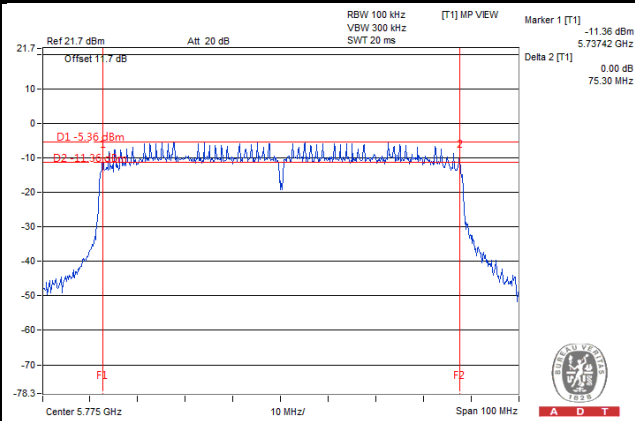



## 5 Pictures of Test Arrangements

Please refer to the attached file (Test Setup Photo).

## Appendix – Information on the Testing Laboratories

We, Bureau Veritas Consumer Products Services (H.K.) Ltd., Taoyuan Branch, were founded in 1988 to provide our best service in EMC, Radio, Telecom and Safety consultation. Our laboratories are accredited and approved according to ISO/IEC 17025.

If you have any comments, please feel free to contact us at the following:

**Linko EMC/RF Lab**

Tel: 886-2-26052180

Fax: 886-2-26051924

**Hsin Chu EMC/RF/Telecom Lab**

Tel: 886-3-6668565

Fax: 886-3-6668323

**Hwa Ya EMC/RF/Safety**

Tel: 886-3-3183232

Fax: 886-3-3270892

**Email:** [service.adt@tw.bureauveritas.com](mailto:service.adt@tw.bureauveritas.com)

**Web Site:** [www.bureauveritas-adt.com](http://www.bureauveritas-adt.com)

The address and road map of all our labs can be found in our web site also.

--- END ---