

FCC Test Report

Report No.: RF160513C20-6

FCC ID: V65E6820

Test Model: E6820/E6820TM

Received Date: Apr. 19, 2016

Test Date: Apr. 28, 2016 ~ May 03, 2016

Issued Date: Jun. 16, 2016

Applicant: Kyocera Corporation c/o Kyocera Communications, Inc.

Address: 8611 Balboa Avenue, San Diego, CA 92123

Issued By: Bureau Veritas Consumer Products Services (H.K.) Ltd., Taoyuan Branch

Lab Address: No. 47-2, 14th Ling, Chia Pau Vil., Lin Kou Dist., New Taipei City, Taiwan
(R.O.C)

Test Location (1): No. 19, Hwa Ya 2nd Rd, Wen Hwa Tsuen, Kwei Shan Hsiang, Taoyuan
Hsien 333, Taiwan, R.O.C.



This report is for your exclusive use. Any copying or replication of this report to or for any other person or entity, or use of our name or trademark, is permitted only with our prior written permission. This report sets forth our findings solely with respect to the test samples identified herein. The results set forth in this report are not indicative or representative of the quality or characteristics of the lot from which a test sample was taken or any similar or identical product unless specifically and expressly noted. Our report includes all of the tests requested by you and the results thereof based upon the information that you provided to us. You have 60 days from date of issuance of this report to notify us of any material error or omission caused by our negligence, provided, however, that such notice shall be in writing and shall specifically address the issue you wish to raise. A failure to raise such issue within the prescribed time shall constitute your unqualified acceptance of the completeness of this report, the tests conducted and the correctness of the report contents. Unless specifically mentioned, the uncertainty of measurement has been explicitly taken into account to declare the compliance or non-compliance to the specification.

Table of Contents

Release Control Record	4
1 Certificate of Conformity	5
2 Summary of Test Results.....	6
2.1 Measurement Uncertainty.....	6
2.2 Modification Record	6
3 General Information	7
3.1 General Description of EUT	7
3.2 Description of Test Modes.....	8
3.2.1 Test Mode Applicability and Tested Channel Detail.....	9
3.3 Duty Cycle of Test Signal	11
3.4 Description of Support Units	12
3.4.1 Configuration of System under Test	12
3.5 General Description of Applied Standards.....	12
4 Test Types and Results	13
4.1 Radiated Emission and Bandedge Measurement	13
4.1.1 Limits of Radiated Emission and Bandedge Measurement	13
4.1.2 Test Instruments	14
4.1.3 Test Procedures.....	15
4.1.4 Deviation from Test Standard	15
4.1.5 Test Set Up	16
4.1.6 EUT Operating Conditions.....	16
4.1.7 Test Results	17
4.2 Conducted Emission Measurement.....	27
4.2.1 Limits of Conducted Emission Measurement	27
4.2.2 Test Instruments	27
4.2.3 Test Procedures.....	28
4.2.4 Deviation from Test Standard	28
4.2.5 Test Setup.....	28
4.2.6 EUT Operating Conditions.....	28
4.2.7 Test Results	29
4.3 6 dB Bandwidth Measurement.....	31
4.3.1 Limits of 6 dB Bandwidth Measurement.....	31
4.3.2 Test Setup.....	31
4.3.3 Test Instruments	31
4.3.4 Test Procedure	31
4.3.5 Deviation from Test Standard	31
4.3.6 EUT Operating Conditions.....	31
4.3.7 Test Result	32
4.4 Conducted Output Power Measurement	34
4.4.1 Limits of Conducted Output Power Measurement.....	34
4.4.2 Test Setup.....	34
4.4.3 Test Instruments	34
4.4.4 Test Procedures.....	34
4.4.5 Deviation from Test Standard	34
4.4.6 EUT Operating Conditions.....	34
4.4.7 Test Results	35
4.5 Power Spectral Density Measurement	36
4.5.1 Limits of Power Spectral Density Measurement.....	36
4.5.2 Test Setup.....	36
4.5.3 Test Instruments	36
4.5.4 Test Procedure	36
4.5.5 Deviation from Test Standard	36
4.5.6 EUT Operating Condition	36

4.5.7 Test Results	37
4.6 Conducted Out of Band Emission Measurement	39
4.6.1 Limits of Conducted Out of Band Emission Measurement.....	39
4.6.2 Test Setup.....	39
4.6.3 Test Instruments	39
4.6.4 Test Procedure	39
4.6.5 Deviation from Test Standard	39
4.6.6 EUT Operating Condition	39
4.6.7 Test Results	40
5 Pictures of Test Arrangements.....	46
Appendix – Information on the Testing Laboratories	47

Release Control Record

Issue No.	Description	Date Issued
RF160513C20-6	Original Release	Jun. 16, 2016

1 Certificate of Conformity

Product: PDA Phone

Brand: KYOCERA

Test Model: E6820/E6820TM

Sample Status: Identical Prototype

Applicant: Kyocera Corporation c/o Kyocera Communications, Inc.

Test Date: Apr. 28, 2016 ~ May 03, 2016

Standards: 47 CFR FCC Part 15, Subpart C (Section 15.247)
ANSI C63.10:2013

The above equipment has been tested by **Bureau Veritas Consumer Products Services (H.K.) Ltd., Taoyuan Branch**, and found compliance with the requirement of the above standards. The test record, data evaluation & Equipment Under Test (EUT) configurations represented herein are true and accurate accounts of the measurements of the sample's EMC characteristics under the conditions specified in this report.

Prepared by :  , **Date:** Jun. 16, 2016
Ivonne Wu / Supervisor

Approved by :  , **Date:** Jun. 16, 2016
Stanley Wu / Assistant Manager

2 Summary of Test Results

47 CFR FCC Part 15, Subpart C (Section 15.247)			
FCC Clause	Test Item	Result	Remarks
15.207	AC Power Conducted Emission	Pass	Meet the requirement of limit. Minimum passing margin is -15.97 dB at 0.36600 MHz.
15.205 / 15.209 / 15.247(d)	Radiated Emissions and Band Edge Measurement	Pass	Meet the requirement of limit. Minimum passing margin is -3.22 dB at 38.73 MHz.
15.247(d)	Antenna Port Emission	Pass	Meet the requirement of limit.
15.247(a)(2)	6 dB Bandwidth	Pass	Meet the requirement of limit.
15.247(b)	Conducted power	Pass	Meet the requirement of limit.
15.247(e)	Power Spectral Density	Pass	Meet the requirement of limit.
15.203	Antenna Requirement	Pass	No antenna connector is used.

2.1 Measurement Uncertainty

Where relevant, the following measurement uncertainty levels have been estimated for tests performed on the EUT:

The listed uncertainties are the worst case uncertainty for the entire range of measurement. Please note that the uncertainty values are provided for informational purposes only and are not used in determining the PASS/FAIL results.

Measurement	Frequency	Expanded Uncertainty (k=2) (\pm)
Conducted Emissions at mains ports	150 kHz ~ 30 MHz	2.44 dB
Radiated Emissions up to 1 GHz	30 MHz ~ 200 MHz	2.93 dB
	200 MHz ~ 1000 MHz	2.95 dB
Radiated Emissions above 1 GHz	1 GHz ~ 18 GHz	2.26 dB
	18 GHz ~ 40 GHz	1.94 dB

2.2 Modification Record

There were no modifications required for compliance.

3 General Information

3.1 General Description of EUT

Product	PDA Phone
Brand	KYOCERA
Test Model	E6820/E6820TM
Status of EUT	Identical Prototype
Power Supply Rating	5.0 Vdc or 9.0 Vdc (adapter) 5.0 Vdc (host equipment) 3.8 Vdc (Li-ion battery)
Modulation Type	CCK, DQPSK, DBPSK for DSSS 64QAM, 16QAM, QPSK, BPSK for OFDM
Modulation Technology	DSSS, OFDM
Transfer Rate	802.11b: 11.0 / 5.5 / 2.0 / 1.0 Mbps 802.11g: 54.0 / 48.0 / 36.0 / 24.0 / 18.0 / 12.0 / 9.0 / 6.0 Mbps 802.11n: up to MCS7
Operating Frequency	2412 ~ 2462 MHz
Number of Channel	11 for 802.11b, 802.11g, 802.11n (HT20)
Output Power	409.26 mW
Antenna Type	Monopole antenna with 0.4 dBi gain
Antenna Connector	N/A
Accessory Device	Refer to Note as below
Data Cable Supplied	Refer to Note as below

Note:

- All models are listed as below.

Brand	Model	Difference
KYOCERA	E6820	E6820 and E6820TM are the same with electrically identical.
	E6820TM	The difference between E6820 and E6820TM are minor cosmetic changes and changes to the UI (software).

- The EUT contains following accessory devices.

Product	Brand	Model	Description
Adapter	KYOCERA	SCP-49ADT	I/P: 100-240 Vac, 50/60 Hz, 400 mA O/P: 5.0 Vdc, 1800 mA or 9.0 Vdc, 1800 mA
Battery	KYOCERA	SCP-67LBPS	3.8 Vdc, 3240 mAh
USB Cable	KYOCERA	SCP-22SDC	1.0 m shielded cable w/o core

- The above EUT information is declared by manufacturer and for more detailed features description, please refer to the manufacturer's specifications or user's manual.

3.2 Description of Test Modes

11 channels are provided for 802.11b, 802.11g and 802.11n (HT20):

Channel	Frequency (MHz)	Channel	Frequency (MHz)
1	2412	7	2442
2	2417	8	2447
3	2422	9	2452
4	2427	10	2457
5	2432	11	2462
6	2437		

3.2.1 Test Mode Applicability and Tested Channel Detail

EUT Configure Mode	Applicable To				Description
	RE \geq 1G	RE<1G	PLC	APCM	
-	√	√	√	√	-

Where **RE \geq 1G**: Radiated Emission above 1 GHz **RE<1G**: Radiated Emission below 1 GHz
PLC: Power Line Conducted Emission **APCM**: Antenna Port Conducted Measurement

NOTE: The EUT had been pre-tested on the positioned of each 3 axis. The worst case was found when positioned on **Y-plane**.
NOTE: “-” means no effect.

Radiated Emission Test (Above 1 GHz):

- Pre-Scan has been conducted to determine the worst-case mode from all possible combinations between available modulations, data rates and antenna ports (if EUT with antenna diversity architecture).
- Following channel(s) was (were) selected for the final test as listed below.

EUT Configure Mode	Mode	Available Channel	Tested Channel	Modulation Technology	Modulation Type	Data Rate (Mbps)
-	802.11b	1 to 11	1, 6, 11	DSSS	DBPSK	1.0
-	802.11g	1 to 11	1, 6, 11	OFDM	BPSK	6.0
-	802.11n (HT20)	1 to 11	1, 6, 11	OFDM	BPSK	MCS0

Radiated Emission Test (Below 1 GHz):

- Pre-Scan has been conducted to determine the worst-case mode from all possible combinations between available modulations, data rates and antenna ports (if EUT with antenna diversity architecture).
- Following channel(s) was (were) selected for the final test as listed below.

EUT Configure Mode	Mode	Available Channel	Tested Channel	Modulation Technology	Modulation Type	Data Rate (Mbps)
-	802.11n (HT20)	1 to 11	11	OFDM	BPSK	MCS0

Power Line Conducted Emission Test:

- Pre-Scan has been conducted to determine the worst-case mode from all possible combinations between available modulations, data rates and antenna ports (if EUT with antenna diversity architecture).
- Following channel(s) was (were) selected for the final test as listed below.

EUT Configure Mode	Mode	Available Channel	Tested Channel	Modulation Technology	Modulation Type	Data Rate (Mbps)
-	802.11n (HT20)	1 to 11	11	OFDM	BPSK	MCS0

Bandedge Measurement:

- Pre-Scan has been conducted to determine the worst-case mode from all possible combinations between available modulations, data rates and antenna ports (if EUT with antenna diversity architecture).
- Following channel(s) was (were) selected for the final test as listed below.

EUT Configure Mode	Mode	Available Channel	Tested Channel	Modulation Technology	Modulation Type	Data Rate (Mbps)
-	802.11b	1 to 11	1, 11	DSSS	DBPSK	1.0
-	802.11g	1 to 11	1, 11	OFDM	BPSK	6.0
-	802.11n (HT20)	1 to 11	1, 11	OFDM	BPSK	MCS0

Antenna Port Conducted Measurement:

- This item includes all test value of each mode, but only includes spectrum plot of worst value of each mode.
- Pre-Scan has been conducted to determine the worst-case mode from all possible combinations between available modulations, data rates and antenna ports (if EUT with antenna diversity architecture).
- Following channel(s) was (were) selected for the final test as listed below.

EUT Configure Mode	Mode	Available Channel	Tested Channel	Modulation Technology	Modulation Type	Data Rate (Mbps)
-	802.11b	1 to 11	1, 6, 11	DSSS	DBPSK	1.0
-	802.11g	1 to 11	1, 6, 11	OFDM	BPSK	6.0
-	802.11n (HT20)	1 to 11	1, 6, 11	OFDM	BPSK	MCS0

Test Condition:

Applicable To	Environmental Conditions	Input Power	Tested by
RE≥1G	25 deg. C, 65 % RH	120 Vac, 60 Hz	Toby Tian
RE<1G	25 deg. C, 65 % RH	120 Vac, 60 Hz	Toby Tian
PLC	25 deg. C, 65 % RH	120 Vac, 60 Hz	Toby Tian
APCM	25 deg. C, 65 % RH	3.8 Vdc	Luke Chen

3.3 Duty Cycle of Test Signal

802.11b: Duty cycle of test signal is 100 %

802.11g: Duty cycle = $2.021/2.534 = 0.80$, Duty factor = $10 * \log(1/0.80) = 0.97$

802.11n (HT20): Duty cycle = $1.879/2.400 = 0.783$, Duty factor = $10 * \log(1/0.783) = 1.06$

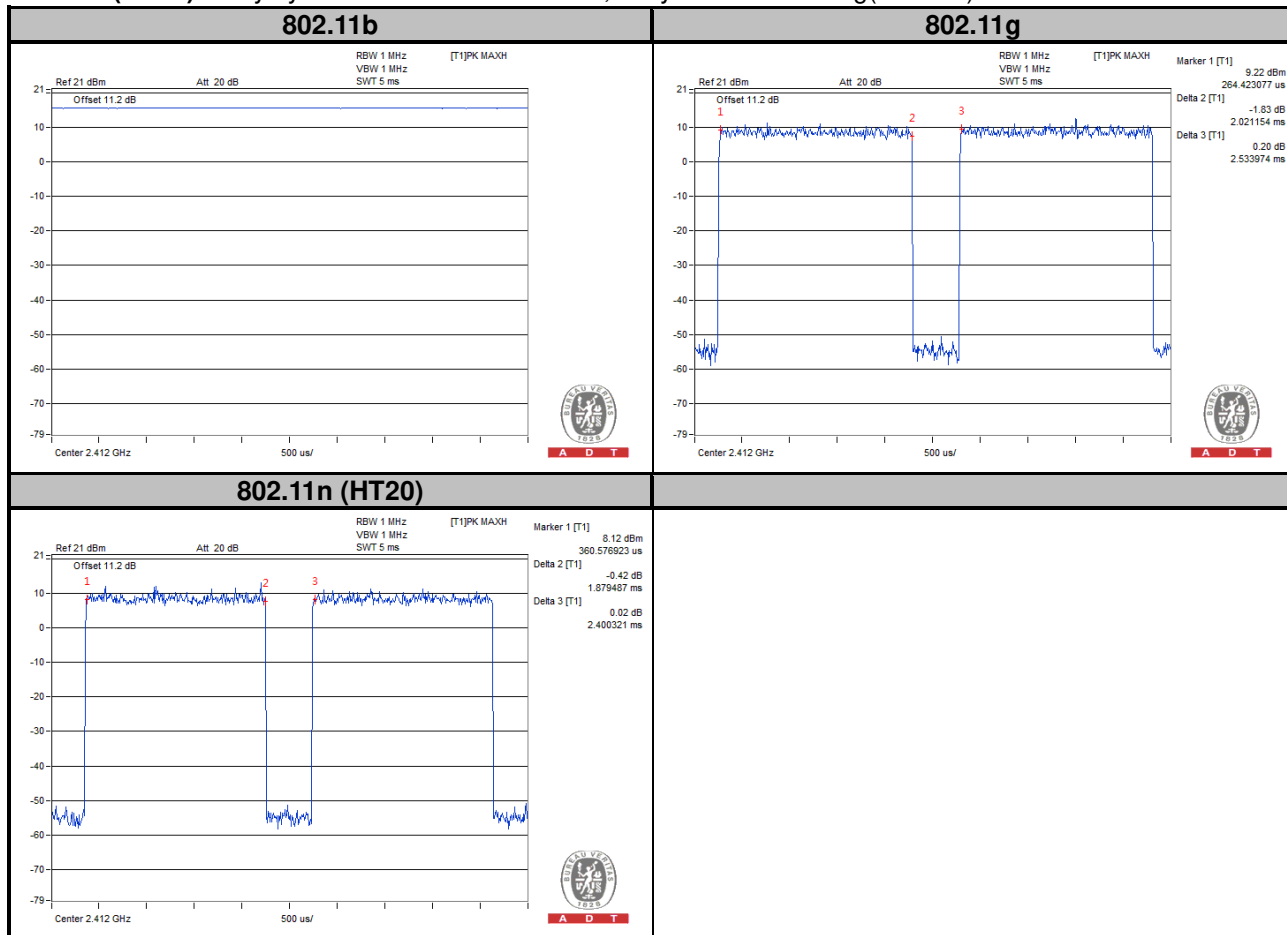

3.4 Description of Support Units

The EUT has been tested as an independent unit together with other necessary accessories or support units. The following support units or accessories were used to form a representative test configuration during the tests.

No.	Product	Brand	Model No.	Serial No.	FCC ID
1.	Earphone	GaLien Electron	HF-HB05D	N/A	N/A

No.	Signal Cable Description Of The Above Support Units
1.	N/A

Note:

1. All power cords of the above support units are non-shielded (1.8m).

3.4.1 Configuration of System under Test

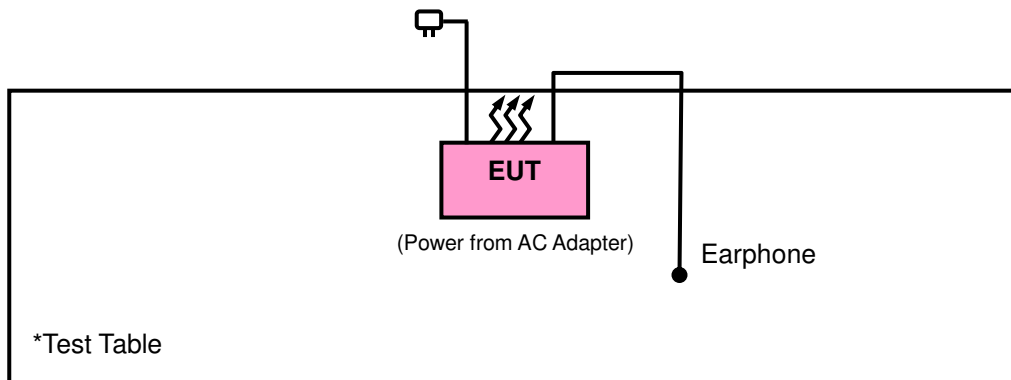

3.5 General Description of Applied Standards

The EUT is a RF Product. According to the specifications of the manufacturer, it must comply with the requirements of the following standards:

FCC Part 15, Subpart C (15.247)

558074 D01 DTS Meas Guidance v03r05

ANSI C63.10-2013

All test items have been performed and recorded as per the above standards.

NOTE: The EUT has been verified to comply with the requirements of FCC Part 15, Subpart B, Class B (DoC). The test report has been issued separately.

4 Test Types and Results

4.1 Radiated Emission and Bandedge Measurement

4.1.1 Limits of Radiated Emission and Bandedge Measurement

Radiated emissions which fall in the restricted bands must comply with the radiated emission limits specified as below table. Other emissions shall be at least 20 dB below the highest level of the desired power:

Frequencies (MHz)	Field Strength (microvolts/meter)	Measurement Distance (meters)
0.009 ~ 0.490	2400/F (kHz)	300
0.490 ~ 1.705	24000/F (kHz)	30
1.705 ~ 30.0	30	30
30 ~ 88	100	3
88 ~ 216	150	3
216 ~ 960	200	3
Above 960	500	3

NOTE:

1. The lower limit shall apply at the transition frequencies.
2. Emission level (dBuV/m) = 20 log Emission level (uV/m).
3. For frequencies above 1000 MHz, the field strength limits are based on average detector, however, the peak field strength of any emission shall not exceed the maximum permitted average limits, specified above by more than 20 dB under any condition of modulation.

4.1.2 Test Instruments

Description & Manufacturer	Model No.	Serial No.	Date of Calibration	Due Date of Calibration
Test Receiver Agilent	N9038A	MY51210203	Jan. 21, 2016	Jan. 20, 2017
Spectrum Analyzer Agilent	N9010A	MY52220314	Sep. 03, 2015	Sep. 02, 2016
Spectrum Analyzer ROHDE & SCHWARZ	FSU43	101261	Dec. 17, 2015	Dec. 16, 2016
BILOG Antenna SCHWARZBECK	VULB9168	9168-472	Jan. 07, 2016	Jan. 06, 2017
HORN Antenna SCHWARZBECK	BBHA 9120 D	9120D-969	Jan. 04, 2016	Jan. 03, 2017
HORN Antenna SCHWARZBECK	BBHA 9170	9170-480	Jan. 08, 2016	Jan. 07, 2017
Loop Antenna	EM-6879	269	Jul. 31, 2015	Jul. 30, 2016
Bluetooth Tester	CBT	100980	Apr. 27, 2015	Apr. 26, 2017
Agilent Communications Tester-Wireless	8960 Series 10	MY53201073	Jul. 03, 2015	Jul. 02, 2017
Preamplifier EMCI	EMC 012645	980115	Dec. 21, 2015	Dec. 20, 2016
Preamplifier EMCI	EMC 184045	980116	Dec. 21, 2015	Dec. 20, 2016
Preamplifier EMCI	EMC 330H	980112	Dec. 28, 2015	Dec. 27, 2016
Power Meter Anritsu	ML2495A	1232002	Sep. 21, 2015	Sep. 20, 2016
Power Sensor Anritsu	MA2411B	1207325	Sep. 21, 2015	Sep. 20, 2016
RF signal cable HUBER+SUHNNER	SUCOFLEX 104	309219/4 2950114	Oct. 12, 2015	Oct. 11, 2016
RF signal cable HUBER+SUHNNER	SUCOFLEX 104	250130/4	Oct. 12, 2015	Oct. 11, 2016
RF Coaxial Cable Worken	8D-FB	Cable-Ch10-01	Oct. 12, 2015	Oct. 11, 2016
Software BV ADT	E3 6.120103	NA	NA	NA
Antenna Tower MF	MFA-440H	NA	NA	NA
Turn Table MF	MFT-201SS	NA	NA	NA
Antenna Tower & Turn Table Controller MF	MF-7802	NA	NA	NA

- Note: 1. The calibration interval of the above test instruments is 12 months and the calibrations are traceable to NML/ROC and NIST/USA.
2. The test was performed in HwaYa Chamber 10.
3. The horn antenna and preamplifier (model: EMC 184045) are used only for the measurement of emission frequency above 1 GHz if tested.
4. The FCC Site Registration No. is 690701.
5. The IC Site Registration No. is IC7450F-10.

4.1.3 Test Procedures

- a. The EUT was placed on the top of a rotating table 0.8 meters (for below 1 GHz) / 1.5 meters (for above 1 GHz) above the ground at 3 meter chamber room for test. The table was rotated 360 degrees to determine the position of the highest radiation.
- b. The EUT was set 3 meters away from the interference-receiving antenna, which was mounted on the top of a variable-height antenna tower.
- c. The height of antenna is varied from one meter to four meters above the ground to determine the maximum value of the field strength. Both horizontal and vertical polarizations of the antenna are set to make the measurement.
- d. For each suspected emission, the EUT was arranged to its worst case and then the antenna was tuned to heights from 1 meter to 4 meters and the rotatable table was turned from 0 degrees to 360 degrees to find the maximum reading.
- e. The test-receiver system was set to quasi-peak detect function and specified bandwidth with maximum hold mode when the test frequency is below 1 GHz.
- f. The test-receiver system was set to peak and average detected function and specified bandwidth with maximum hold mode when the test frequency is above 1 GHz. If the peak reading value also meets average limit, measurement with the average detector is unnecessary.

Note:

1. The resolution bandwidth and video bandwidth of test receiver/spectrum analyzer is 120 kHz for Quasi-peak detection (QP) at frequency below 1 GHz.
2. The resolution bandwidth of test receiver/spectrum analyzer is 1 MHz and the video bandwidth is 3 MHz for Peak detection (PK) at frequency above 1 GHz.
3. The resolution bandwidth of test receiver/spectrum analyzer is 1 MHz and the video bandwidth is 3 MHz for RMS Average (Duty cycle < 98 %) for Average detection (AV) at frequency above 1 GHz, then the measurement results was added to a correction factor ($10 \log(1/\text{duty cycle})$).
4. The resolution bandwidth of test receiver/spectrum analyzer is 1MHz and the video bandwidth is 10 Hz (Duty cycle $\geq 98 \%$) for Average detection (AV) at frequency above 1 GHz.
5. All modes of operation were investigated and the worst-case emissions are reported.

4.1.4 Deviation from Test Standard

No deviation.

4.1.5 Test Set Up

<Frequency Range below 1 GHz>

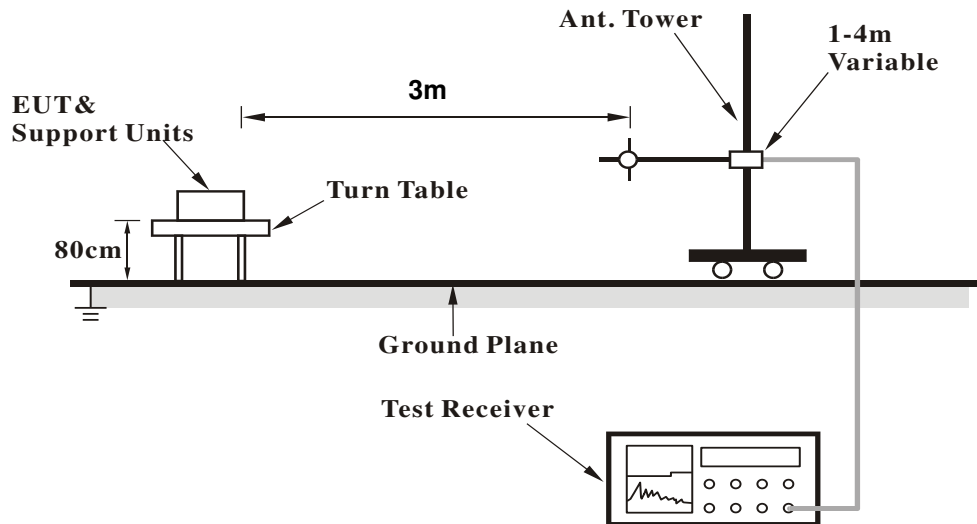

<Frequency Range above 1 GHz>

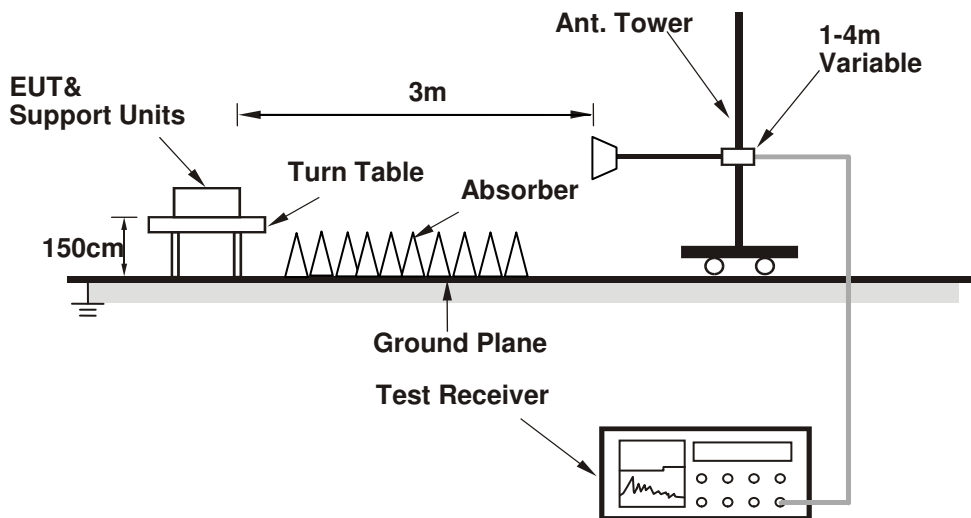

For the actual test configuration, please refer to the attached file (Test Setup Photo).

4.1.6 EUT Operating Conditions

- Placed the EUT on a testing table.
- Use the software to control the EUT under transmission condition continuously at specific channel frequency.

4.1.7 Test Results

Above 1 GHz Data :

802.11b

EUT Test Condition		Measurement Detail	
Channel	Channel 1	Frequency Range	1 GHz ~ 25 GHz
Input Power	120 Vac, 60 Hz	Detector Function	Peak (PK) Average (AV)
Environmental Conditions	25 deg. C, 65 % RH	Tested By	Toby Tian

Antennal Polarity & Test Distance: Horizontal at 3 m										
Frequency (MHz)	Emission Level (dBuV/m)	Read Level (dBuV)	Limit (dBuV/m)	Margin (dB)	Antenna Factor (dB/m)	Cable Loss (dB)	Preamp Factor (dB)	Antenna Height (cm)	Table Angle (Degree)	Remark
2386	35.84	42.35	54	-18.16	26.91	4.08	37.5	205	175	Average
2386	57.7	64.21	74	-16.3	26.91	4.08	37.5	205	175	Peak
2412	105.45	111.92			26.96	4.09	37.52	205	175	Average
2412	111.42	117.89			26.96	4.09	37.52	205	175	Peak
2484	34.36	40.38	54	-19.64	27.15	4.15	37.32	205	175	Average
2484	56.49	62.51	74	-17.51	27.15	4.15	37.32	205	175	Peak

Antennal Polarity & Test Distance: Vertical at 3 m										
Frequency (MHz)	Emission Level (dBuV/m)	Read Level (dBuV)	Limit (dBuV/m)	Margin (dB)	Antenna Factor (dB/m)	Cable Loss (dB)	Preamp Factor (dB)	Antenna Height (cm)	Table Angle (Degree)	Remark
2388	35.51	42.02	54	-18.49	26.91	4.08	37.5	201	245	Average
2388	56.58	63.09	74	-17.42	26.91	4.08	37.5	201	245	Peak
2412	102.71	109.18			26.96	4.09	37.52	201	245	Average
2412	108.29	114.76			26.96	4.09	37.52	201	245	Peak
2484	34.24	40.26	54	-19.76	27.15	4.15	37.32	201	245	Average
2484	57.08	63.1	74	-16.92	27.15	4.15	37.32	201	245	Peak

Remarks:

- Emission Level = Read Level + Antenna Factor + Cable Loss - Preamp Factor
Margin value = Emission level – Limit value
- 2412 MHz: Fundamental frequency.

EUT Test Condition		Measurement Detail	
Channel	Channel 6	Frequency Range	1 GHz ~ 25 GHz
Input Power	120 Vac, 60 Hz	Detector Function	Peak (PK) Average (AV)
Environmental Conditions	25 deg. C, 65 % RH	Tested By	Toby Tian

Antennal Polarity & Test Distance: Horizontal at 3 m										
Frequency (MHz)	Emission Level (dBuV/m)	Read Level (dBuV)	Limit (dBuV/m)	Margin (dB)	Antenna Factor (dB/m)	Cable Loss (dB)	Preamp Factor (dB)	Antenna Height (cm)	Table Angle (Degree)	Remark
2356	34.67	41.3	54	-19.33	26.81	4.05	37.49	204	156	Average
2356	56.84	63.47	74	-17.16	26.81	4.05	37.49	204	156	Peak
2437	105.56	111.84			27.06	4.12	37.46	204	156	Average
2437	111.5	117.78			27.06	4.12	37.46	204	156	Peak
2484	34.5	40.52	54	-19.5	27.15	4.15	37.32	204	156	Average
2484	57.81	63.83	74	-16.19	27.15	4.15	37.32	204	156	Peak

Antennal Polarity & Test Distance: Vertical at 3 m										
Frequency (MHz)	Emission Level (dBuV/m)	Read Level (dBuV)	Limit (dBuV/m)	Margin (dB)	Antenna Factor (dB/m)	Cable Loss (dB)	Preamp Factor (dB)	Antenna Height (cm)	Table Angle (Degree)	Remark
2368	33.86	40.48	54	-20.14	26.81	4.07	37.5	204	223	Average
2368	57.57	64.19	74	-16.43	26.81	4.07	37.5	204	223	Peak
2437	102.83	109.11			27.06	4.12	37.46	204	223	Average
2437	108.45	114.73			27.06	4.12	37.46	204	223	Peak
2488	34.41	40.37	54	-19.59	27.2	4.16	37.32	204	223	Average
2488	57.73	63.69	74	-16.27	27.2	4.16	37.32	204	223	Peak

Remarks:

- Emission Level = Read Level + Antenna Factor + Cable Loss - Preamp Factor
Margin value = Emission level – Limit value
- 2437 MHz: Fundamental frequency.

EUT Test Condition		Measurement Detail	
Channel	Channel 11	Frequency Range	1 GHz ~ 25 GHz
Input Power	120 Vac, 60 Hz	Detector Function	Peak (PK) Average (AV)
Environmental Conditions	25 deg. C, 65 % RH	Tested By	Toby Tian

Antennal Polarity & Test Distance: Horizontal at 3 m										
Frequency (MHz)	Emission Level (dBuV/m)	Read Level (dBuV)	Limit (dBuV/m)	Margin (dB)	Antenna Factor (dB/m)	Cable Loss (dB)	Preamp Factor (dB)	Antenna Height (cm)	Table Angle (Degree)	Remark
2322	33.65	40.37	54	-20.35	26.72	4.03	37.47	201	164	Average
2322	56.57	63.29	74	-17.43	26.72	4.03	37.47	201	164	Peak
2462	105.45	111.61			27.1	4.13	37.39	201	164	Average
2462	111.43	117.59			27.1	4.13	37.39	201	164	Peak
2488	35.51	41.47	54	-18.49	27.2	4.16	37.32	201	164	Average
2488	57.37	63.33	74	-16.63	27.2	4.16	37.32	201	164	Peak

Antennal Polarity & Test Distance: Vertical at 3 m										
Frequency (MHz)	Emission Level (dBuV/m)	Read Level (dBuV)	Limit (dBuV/m)	Margin (dB)	Antenna Factor (dB/m)	Cable Loss (dB)	Preamp Factor (dB)	Antenna Height (cm)	Table Angle (Degree)	Remark
2376	33.64	40.21	54	-20.36	26.86	4.07	37.5	200	237	Average
2376	56.61	63.18	74	-17.39	26.86	4.07	37.5	200	237	Peak
2462	102.93	109.09			27.1	4.13	37.39	200	237	Average
2462	108.31	114.47			27.1	4.13	37.39	200	237	Peak
2500	34.86	40.75	54	-19.14	27.2	4.16	37.25	200	237	Average
2500	57.3	63.19	74	-16.7	27.2	4.16	37.25	200	237	Peak

Remarks:

- Emission Level = Read Level + Antenna Factor + Cable Loss - Preamp Factor
Margin value = Emission level – Limit value
- 2462 MHz: Fundamental frequency.

802.11g

EUT Test Condition		Measurement Detail	
Channel	Channel 1	Frequency Range	1 GHz ~ 25 GHz
Input Power	120 Vac, 60 Hz	Detector Function	Peak (PK) Average (AV)
Environmental Conditions	25 deg. C, 65 % RH	Tested By	Toby Tian

Antennal Polarity & Test Distance: Horizontal at 3 m

Frequency (MHz)	Emission Level (dBuV/m)	Read Level (dBuV)	Limit (dBuV/m)	Margin (dB)	Antenna Factor (dB/m)	Cable Loss (dB)	Preamp Factor (dB)	Antenna Height (cm)	Table Angle (Degree)	Remark
2390	45.04	51.57	54	-8.96	26.91	4.08	37.52	206	162	Average
2390	63.71	70.24	74	-10.29	26.91	4.08	37.52	206	162	Peak
2412	98.48	104.95			26.96	4.09	37.52	206	162	Average
2412	108.35	114.82			26.96	4.09	37.52	206	162	Peak
2500	35.19	41.08	54	-18.81	27.2	4.16	37.25	206	162	Average
2500	57.03	62.92	74	-16.97	27.2	4.16	37.25	206	162	Peak

Antennal Polarity & Test Distance: Vertical at 3 m

Frequency (MHz)	Emission Level (dBuV/m)	Read Level (dBuV)	Limit (dBuV/m)	Margin (dB)	Antenna Factor (dB/m)	Cable Loss (dB)	Preamp Factor (dB)	Antenna Height (cm)	Table Angle (Degree)	Remark
2390	43.05	49.58	54	-10.95	26.91	4.08	37.52	202	234	Average
2390	62.7	69.23	74	-11.3	26.91	4.08	37.52	202	234	Peak
2412	95.59	102.06			26.96	4.09	37.52	202	234	Average
2412	104.92	111.39			26.96	4.09	37.52	202	234	Peak
2500	34.91	40.8	54	-19.09	27.2	4.16	37.25	202	234	Average
2500	57.14	63.03	74	-16.86	27.2	4.16	37.25	202	234	Peak

Remarks:

- Emission Level = Read Level + Antenna Factor + Cable Loss - Preamp Factor
Margin value = Emission level – Limit value
- 2412 MHz: Fundamental frequency.

EUT Test Condition		Measurement Detail	
Channel	Channel 6	Frequency Range	1 GHz ~ 25 GHz
Input Power	120 Vac, 60 Hz	Detector Function	Peak (PK) Average (AV)
Environmental Conditions	25 deg. C, 65 % RH	Tested By	Toby Tian

Antennal Polarity & Test Distance: Horizontal at 3 m										
Frequency (MHz)	Emission Level (dBuV/m)	Read Level (dBuV)	Limit (dBuV/m)	Margin (dB)	Antenna Factor (dB/m)	Cable Loss (dB)	Preamp Factor (dB)	Antenna Height (cm)	Table Angle (Degree)	Remark
2378	34.83	41.4	54	-19.17	26.86	4.07	37.5	205	163	Average
2378	57.51	64.08	74	-16.49	26.86	4.07	37.5	205	163	Peak
2437	101.19	107.47			27.06	4.12	37.46	205	163	Average
2437	110.68	116.96			27.06	4.12	37.46	205	163	Peak
2490	36.47	42.43	54	-17.53	27.2	4.16	37.32	205	163	Average
2490	57.67	63.63	74	-16.33	27.2	4.16	37.32	205	163	Peak
Antennal Polarity & Test Distance: Vertical at 3 m										
Frequency (MHz)	Emission Level (dBuV/m)	Read Level (dBuV)	Limit (dBuV/m)	Margin (dB)	Antenna Factor (dB/m)	Cable Loss (dB)	Preamp Factor (dB)	Antenna Height (cm)	Table Angle (Degree)	Remark
2340	34.65	41.33	54	-19.35	26.77	4.04	37.49	203	235	Average
2340	57.32	64	74	-16.68	26.77	4.04	37.49	203	235	Peak
2437	97.6	103.88			27.06	4.12	37.46	203	235	Average
2437	107.18	113.46			27.06	4.12	37.46	203	235	Peak
2492	36.1	41.99	54	-17.9	27.2	4.16	37.25	203	235	Average
2492	57.36	63.25	74	-16.64	27.2	4.16	37.25	203	235	Peak

Remarks:

- Emission Level = Read Level + Antenna Factor + Cable Loss - Preamp Factor
Margin value = Emission level – Limit value
- 2437 MHz: Fundamental frequency.

EUT Test Condition		Measurement Detail	
Channel	Channel 11	Frequency Range	1 GHz ~ 25 GHz
Input Power	120 Vac, 60 Hz	Detector Function	Peak (PK) Average (AV)
Environmental Conditions	25 deg. C, 65 % RH	Tested By	Toby Tian

Antennal Polarity & Test Distance: Horizontal at 3 m										
Frequency (MHz)	Emission Level (dBuV/m)	Read Level (dBuV)	Limit (dBuV/m)	Margin (dB)	Antenna Factor (dB/m)	Cable Loss (dB)	Preamp Factor (dB)	Antenna Height (cm)	Table Angle (Degree)	Remark
2340	34.09	40.77	54	-19.91	26.77	4.04	37.49	200	167	Average
2340	57.07	63.75	74	-16.93	26.77	4.04	37.49	200	167	Peak
2462	98.5	104.66			27.1	4.13	37.39	200	167	Average
2462	108.27	114.43			27.1	4.13	37.39	200	167	Peak
2484	44.04	50.06	54	-9.96	27.15	4.15	37.32	200	167	Average
2484	67.42	73.44	74	-6.58	27.15	4.15	37.32	200	167	Peak

Antennal Polarity & Test Distance: Vertical at 3 m										
Frequency (MHz)	Emission Level (dBuV/m)	Read Level (dBuV)	Limit (dBuV/m)	Margin (dB)	Antenna Factor (dB/m)	Cable Loss (dB)	Preamp Factor (dB)	Antenna Height (cm)	Table Angle (Degree)	Remark
2378	34.11	40.68	54	-19.89	26.86	4.07	37.5	198	233	Average
2378	56.4	62.97	74	-17.6	26.86	4.07	37.5	198	233	Peak
2462	95.76	101.92			27.1	4.13	37.39	198	233	Average
2462	104.86	111.02			27.1	4.13	37.39	198	233	Peak
2484	41.95	47.97	54	-12.05	27.15	4.15	37.32	198	233	Average
2484	59.87	65.89	74	-14.13	27.15	4.15	37.32	198	233	Peak

Remarks:

- Emission Level = Read Level + Antenna Factor + Cable Loss - Preamp Factor
Margin value = Emission level – Limit value
- 2462 MHz: Fundamental frequency.

802.11n (HT20)

EUT Test Condition		Measurement Detail	
Channel	Channel 1	Frequency Range	1 GHz ~ 25 GHz
Input Power	120 Vac, 60 Hz	Detector Function	Peak (PK) Average (AV)
Environmental Conditions	25 deg. C, 65 % RH	Tested By	Toby Tian

Antennal Polarity & Test Distance: Horizontal at 3 m

Frequency (MHz)	Emission Level (dBuV/m)	Read Level (dBuV)	Limit (dBuV/m)	Margin (dB)	Antenna Factor (dB/m)	Cable Loss (dB)	Preamp Factor (dB)	Antenna Height (cm)	Table Angle (Degree)	Remark
2390	45.63	52.16	54	-8.37	26.91	4.08	37.52	205	152	Average
2390	63.54	70.07	74	-10.46	26.91	4.08	37.52	205	152	Peak
2412	98.66	105.13			26.96	4.09	37.52	205	152	Average
2412	108.37	114.84			26.96	4.09	37.52	205	152	Peak
2488	35.22	41.18	54	-18.78	27.2	4.16	37.32	205	152	Average
2488	56.94	62.9	74	-17.06	27.2	4.16	37.32	205	152	Peak

Antennal Polarity & Test Distance: Vertical at 3 m

Frequency (MHz)	Emission Level (dBuV/m)	Read Level (dBuV)	Limit (dBuV/m)	Margin (dB)	Antenna Factor (dB/m)	Cable Loss (dB)	Preamp Factor (dB)	Antenna Height (cm)	Table Angle (Degree)	Remark
2390	44.67	51.2	54	-9.33	26.91	4.08	37.52	204	229	Average
2390	62.98	69.51	74	-11.02	26.91	4.08	37.52	204	229	Peak
2412	95.6	102.07			26.96	4.09	37.52	204	229	Average
2412	104.93	111.4			26.96	4.09	37.52	204	229	Peak
2492	35.03	40.92	54	-18.97	27.2	4.16	37.25	204	229	Average
2492	56.99	62.88	74	-17.01	27.2	4.16	37.25	204	229	Peak

Remarks:

- Emission Level = Read Level + Antenna Factor + Cable Loss - Preamp Factor
Margin value = Emission level – Limit value
- 2412 MHz: Fundamental frequency.

EUT Test Condition		Measurement Detail	
Channel	Channel 6	Frequency Range	1 GHz ~ 25 GHz
Input Power	120 Vac, 60 Hz	Detector Function	Peak (PK) Average (AV)
Environmental Conditions	25 deg. C, 65 % RH	Tested By	Toby Tian

Antennal Polarity & Test Distance: Horizontal at 3 m										
Frequency (MHz)	Emission Level (dBuV/m)	Read Level (dBuV)	Limit (dBuV/m)	Margin (dB)	Antenna Factor (dB/m)	Cable Loss (dB)	Preamp Factor (dB)	Antenna Height (cm)	Table Angle (Degree)	Remark
2382	35.36	41.92	54	-18.64	26.86	4.08	37.5	202	176	Average
2382	57.24	63.8	74	-16.76	26.86	4.08	37.5	202	176	Peak
2437	101.25	107.53			27.06	4.12	37.46	202	176	Average
2437	110.77	117.05			27.06	4.12	37.46	202	176	Peak
2500	37.44	43.33	54	-16.56	27.2	4.16	37.25	202	176	Average
2500	57.96	63.85	74	-16.04	27.2	4.16	37.25	202	176	Peak

Antennal Polarity & Test Distance: Vertical at 3 m										
Frequency (MHz)	Emission Level (dBuV/m)	Read Level (dBuV)	Limit (dBuV/m)	Margin (dB)	Antenna Factor (dB/m)	Cable Loss (dB)	Preamp Factor (dB)	Antenna Height (cm)	Table Angle (Degree)	Remark
2384	34.92	41.48	54	-19.08	26.86	4.08	37.5	204	240	Average
2384	57.52	64.08	74	-16.48	26.86	4.08	37.5	204	240	Peak
2437	97.6	103.88			27.06	4.12	37.46	204	240	Average
2437	107.14	113.42			27.06	4.12	37.46	204	240	Peak
2490	36.43	42.39	54	-17.57	27.2	4.16	37.32	204	240	Average
2490	57.16	63.12	74	-16.84	27.2	4.16	37.32	204	240	Peak

Remarks:

- Emission Level = Read Level + Antenna Factor + Cable Loss - Preamp Factor
Margin value = Emission level – Limit value
- 2437 MHz: Fundamental frequency.

EUT Test Condition		Measurement Detail	
Channel	Channel 11	Frequency Range	1 GHz ~ 25 GHz
Input Power	120 Vac, 60 Hz	Detector Function	Peak (PK) Average (AV)
Environmental Conditions	25 deg. C, 65 % RH	Tested By	Toby Tian

Antennal Polarity & Test Distance: Horizontal at 3 m										
Frequency (MHz)	Emission Level (dBuV/m)	Read Level (dBuV)	Limit (dBuV/m)	Margin (dB)	Antenna Factor (dB/m)	Cable Loss (dB)	Preamp Factor (dB)	Antenna Height (cm)	Table Angle (Degree)	Remark
2376	34.4	40.97	54	-19.6	26.86	4.07	37.5	200	157	Average
2376	56.84	63.41	74	-17.16	26.86	4.07	37.5	200	157	Peak
2462	98.78	104.94			27.1	4.13	37.39	200	157	Average
2462	108.38	114.54			27.1	4.13	37.39	200	157	Peak
2484	47.59	53.61	54	-6.41	27.15	4.15	37.32	200	157	Average
2484	67.77	73.79	74	-6.23	27.15	4.15	37.32	200	157	Peak
Antennal Polarity & Test Distance: Vertical at 3 m										
Frequency (MHz)	Emission Level (dBuV/m)	Read Level (dBuV)	Limit (dBuV/m)	Margin (dB)	Antenna Factor (dB/m)	Cable Loss (dB)	Preamp Factor (dB)	Antenna Height (cm)	Table Angle (Degree)	Remark
2338	34.21	40.87	54	-19.79	26.77	4.04	37.47	212	242	Average
2338	56.77	63.43	74	-17.23	26.77	4.04	37.47	212	242	Peak
2462	95.8	101.96			27.1	4.13	37.39	212	242	Average
2462	105.07	111.23			27.1	4.13	37.39	212	242	Peak
2484	45.62	51.64	54	-8.38	27.15	4.15	37.32	212	242	Average
2484	66.4	72.42	74	-7.6	27.15	4.15	37.32	212	242	Peak

Remarks:

- Emission Level = Read Level + Antenna Factor + Cable Loss - Preamp Factor
Margin value = Emission level – Limit value
- 2462 MHz: Fundamental frequency.

9 kHz ~ 30 MHz DATA:

The amplitude of spurious emissions attenuated more than 20 dB below the permissible value is not required to be report.

30 MHz ~ 1 GHz WORST-CASE DATA:

802.11n (HT20)

EUT Test Condition		Measurement Detail	
Channel	Channel 11	Frequency Range	30 MHz ~ 1 GHz
Input Power	120 Vac, 60 Hz	Detector Function	Peak (PK) Quasi-peak (QP)
Environmental Conditions	25 deg. C, 65 % RH	Tested By	Toby Tian

Antennal Polarity & Test Distance: Horizontal at 3 m										
Frequency (MHz)	Emission Level (dBuV/m)	Read Level (dBuV)	Limit (dBuV/m)	Margin (dB)	Antenna Factor (dB/m)	Cable Loss (dB)	Preamp Factor (dB)	Antenna Height (cm)	Table Angle (Degree)	Remark
74.62	31.09	52.34	40	-8.91	9.57	0.86	31.68	113	246	Peak
87.23	31.41	54.03	40	-8.59	8.25	0.95	31.82	101	322	Peak
141.55	28.27	46.33	43.5	-15.23	12.41	1.16	31.63	122	89	Peak
204.6	26.48	47.3	43.5	-17.02	9.56	1.31	31.69	136	154	Peak
219.15	26.87	47.02	46	-19.13	10.18	1.37	31.7	111	209	Peak
682.81	23.52	32.33	46	-22.48	20.61	2.42	31.84	137	159	Peak

Antennal Polarity & Test Distance: Vertical at 3 m										
Frequency (MHz)	Emission Level (dBuV/m)	Read Level (dBuV)	Limit (dBuV/m)	Margin (dB)	Antenna Factor (dB/m)	Cable Loss (dB)	Preamp Factor (dB)	Antenna Height (cm)	Table Angle (Degree)	Remark
38.73	36.78	53.76	40	-3.22	13.39	0.63	31	112	150	Peak
63.95	35.16	54.39	40	-4.84	11.47	0.84	31.54	129	67	Peak
76.56	36.12	57.78	40	-3.88	9.09	0.87	31.62	105	69	Peak
562.53	20.81	31.93	46	-25.19	18.75	2.2	32.07	108	226	Peak
682.81	23.16	31.97	46	-22.84	20.61	2.42	31.84	109	315	Peak
748.77	23.73	31.02	46	-22.27	21.5	2.53	31.32	125	190	Peak

Remarks:

- Emission Level = Read Level + Antenna Factor + Cable Loss - Preamp Factor
Margin value = Emission level – Limit value

4.2 Conducted Emission Measurement

4.2.1 Limits of Conducted Emission Measurement

Frequency (MHz)	Conducted Limit (dBuV)	
	Quasi-peak	Average
0.15 - 0.5	66 - 56	56 - 46
0.50 - 5.0	56	46
5.0 - 30.0	60	50

Note: 1. The lower limit shall apply at the transition frequencies.

2. The limit decreases in line with the logarithm of the frequency in the range of 0.15 to 0.50 MHz.

4.2.2 Test Instruments

Description & Manufacturer	Model No.	Serial No.	Date of Calibration	Due Date of Calibration
Test Receiver ROHDE & SCHWARZ	ESCI	100613	Nov. 16, 2015	Nov. 15, 2016
RF signal cable (with 10dB PAD) Woken	5D-FB	Cable-cond1-01	Dec. 26, 2015	Dec. 25, 2016
LISN ROHDE & SCHWARZ (EUT)	ESH3-Z5	835239/001	Feb. 26, 2016	Feb. 25, 2017
LISN ROHDE & SCHWARZ (Peripheral)	ESH3-Z5	100311	Jul. 24, 2015	Jul. 23, 2016
Software ADT	BV ADT_Cond_ V7.3.7.3	NA	NA	NA

Note: 1. The calibration interval of the above test instruments is 12 months and the calibrations are traceable to NML/ROC and NIST/USA.

2. The test was performed in HwaYa Shielded Room 1.

3. The VCCI Site Registration No. is C-2040.

4.2.3 Test Procedures

- a. The EUT was placed 0.4 meters from the conducting wall of the shielded room with EUT being connected to the power mains through a line impedance stabilization network (LISN). Other support units were connected to the power mains through another LISN. The two LISNs provide 50 ohm/50 uH of coupling impedance for the measuring instrument.
- b. Both lines of the power mains connected to the EUT were checked for maximum conducted interference.
- c. The frequency range from 150 kHz to 30 MHz was searched. Emission levels under (Limit – 20 dB) was not recorded.

NOTE: All modes of operation were investigated and the worst-case emissions are reported.

4.2.4 Deviation from Test Standard

No deviation.

4.2.5 Test Setup

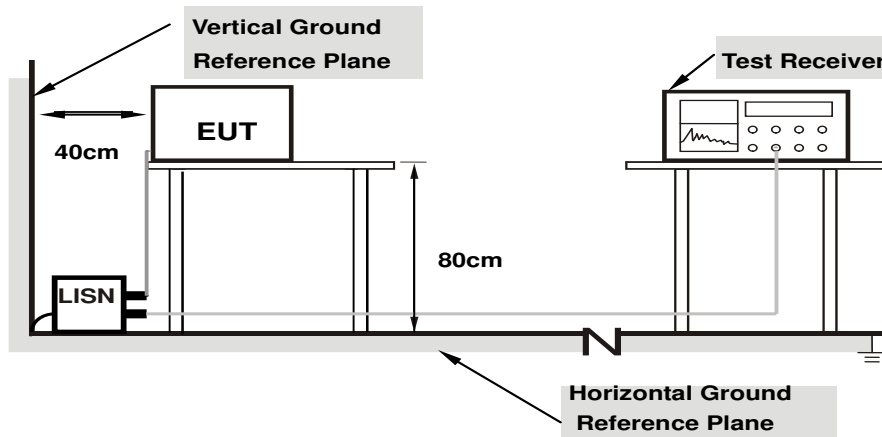

Note: 1.Support units were connected to second LISN.

For the actual test configuration, please refer to the attached file (Test Setup Photo).

4.2.6 EUT Operating Conditions

- a. Placed the EUT on a testing table.
- b. Use the software to control the EUT under transmission condition continuously at specific channel frequency.

4.2.7 Test Results

Frequency Range	150kHz ~ 30MHz	Detector Function & Resolution Bandwidth	Quasi-Peak (QP) / Average (AV), 9kHz
Input Power	120Vac, 60Hz	Environmental Conditions	25°C, 65%RH
Tested by	Toby Tian	Test Date	2016/4/29

Phase Of Power : Line (L)										
No	Frequency (MHz)	Correction Factor (dB)	Reading Value (dBuV)		Emission Level (dBuV)		Limit (dBuV)		Margin (dB)	
			Q.P.	AV.	Q.P.	AV.	Q.P.	AV.	Q.P.	AV.
1	0.15000	10.01	26.22	13.09	36.23	23.10	66.00	56.00	-29.77	-32.90
2	0.26429	10.06	28.31	17.34	38.37	27.40	61.30	51.30	-22.93	-23.90
3	0.36200	10.10	24.89	12.28	34.99	22.38	58.68	48.68	-23.69	-26.30
4	0.75800	10.17	24.06	8.27	34.23	18.44	56.00	46.00	-21.77	-27.56
5	1.07800	10.21	28.61	12.70	38.82	22.91	56.00	46.00	-17.18	-23.09
6	2.12948	10.28	27.58	15.89	37.86	26.17	56.00	46.00	-18.14	-19.83

Remarks:

1. Q.P. and AV. are abbreviations of quasi-peak and average individually.
2. The emission levels of other frequencies were very low against the limit.
3. Margin value = Emission level – Limit value
4. Correction factor = Insertion loss + Cable loss
5. Emission Level = Correction Factor + Reading Value

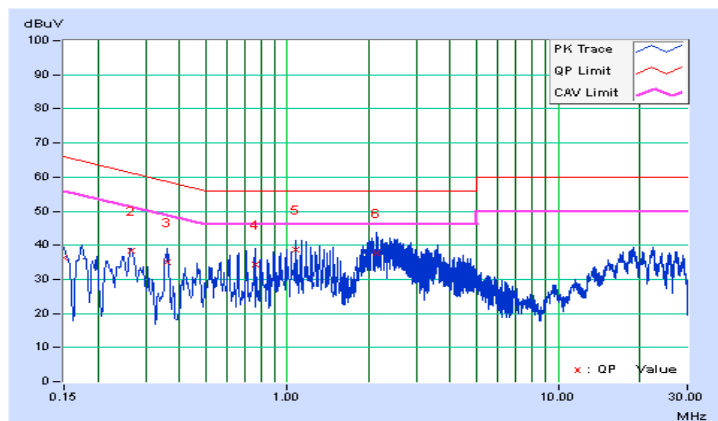

Frequency Range	150kHz ~ 30MHz	Detector Function & Resolution Bandwidth	Quasi-Peak (QP) / Average (AV), 9kHz
Input Power	120Vac, 60Hz	Environmental Conditions	25°C, 65%RH
Tested by	Toby Tian	Test Date	2016/4/29

Phase Of Power : Neutral (N)										
No	Frequency (MHz)	Correction Factor (dB)	Reading Value (dBuV)		Emission Level (dBuV)		Limit (dBuV)		Margin (dB)	
			Q.P.	AV.	Q.P.	AV.	Q.P.	AV.	Q.P.	AV.
1	0.15400	10.03	33.83	21.40	43.86	31.43	65.78	55.78	-21.93	-24.36
2	0.17384	10.03	31.86	20.78	41.89	30.81	64.77	54.77	-22.88	-23.96
3	0.24164	10.06	27.00	19.61	37.06	29.67	62.04	52.04	-24.98	-22.37
4	0.36600	10.11	28.38	22.51	38.49	32.62	58.59	48.59	-20.10	-15.97
5	0.89000	10.20	23.66	14.55	33.86	24.75	56.00	46.00	-22.14	-21.25
6	2.12600	10.29	25.25	17.06	35.54	27.35	56.00	46.00	-20.46	-18.65

Remarks:

1. Q.P. and AV. are abbreviations of quasi-peak and average individually.
2. The emission levels of other frequencies were very low against the limit.
3. Margin value = Emission level – Limit value
4. Correction factor = Insertion loss + Cable loss
5. Emission Level = Correction Factor + Reading Value

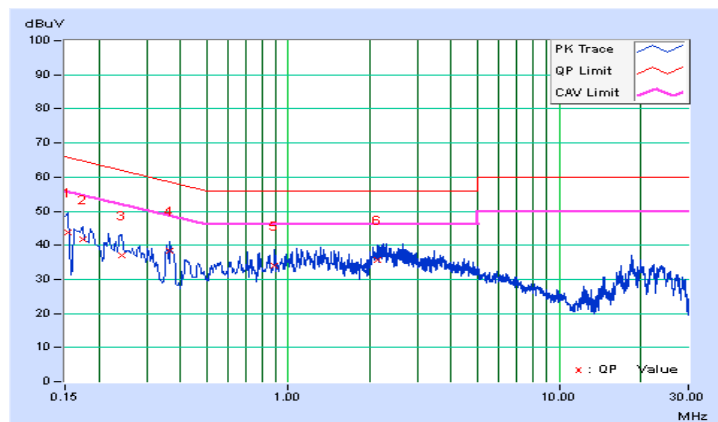

4.3 6 dB Bandwidth Measurement

4.3.1 Limits of 6 dB Bandwidth Measurement

The minimum of 6 dB Bandwidth Measurement is 0.5 MHz.

4.3.2 Test Setup

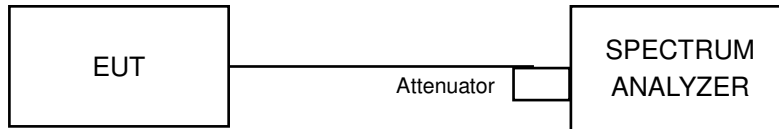

4.3.3 Test Instruments

Refer to section 4.1.2 to get information of above instrument.

4.3.4 Test Procedure

- Set resolution bandwidth (RBW) = 100 kHz
- Set the video bandwidth (VBW) $\geq 3 \times$ RBW, Detector = Peak.
- Trace mode = max hold.
- Sweep = auto couple.
- Measure the maximum width of the emission that is constrained by the frequencies associated with the two amplitude points (upper and lower) that are attenuated by 6 dB relative to the maximum level measured in the fundamental emission

4.3.5 Deviation from Test Standard

No deviation.

4.3.6 EUT Operating Conditions

The software provided by client to enable the EUT under transmission condition continuously at lowest, middle and highest channel frequencies individually.

4.3.7 Test Result

802.11b

Channel	Frequency (MHz)	6 dB Bandwidth (MHz)	Minimum Limit (MHz)	Pass / Fail
1	2412	7.13	0.5	Pass
6	2437	7.13	0.5	Pass
11	2462	7.57	0.5	Pass

802.11g

Channel	Frequency (MHz)	6 dB Bandwidth (MHz)	Minimum Limit (MHz)	Pass / Fail
1	2412	16.41	0.5	Pass
6	2437	16.40	0.5	Pass
11	2462	16.38	0.5	Pass

802.11n (HT20)

Channel	Frequency (MHz)	6 dB Bandwidth (MHz)	Minimum Limit (MHz)	Pass / Fail
1	2412	17.61	0.5	Pass
6	2437	17.61	0.5	Pass
11	2462	16.98	0.5	Pass

Spectrum Plot of Worst Value

802.11b

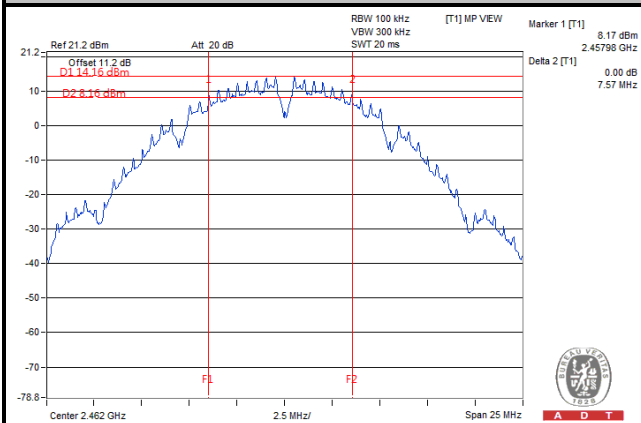

802.11g

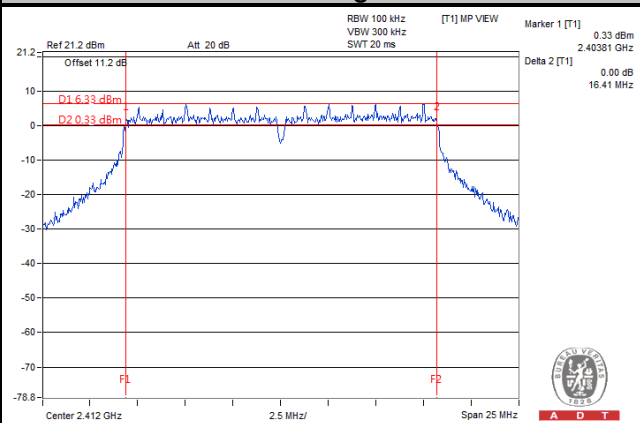

802.11n (HT20)

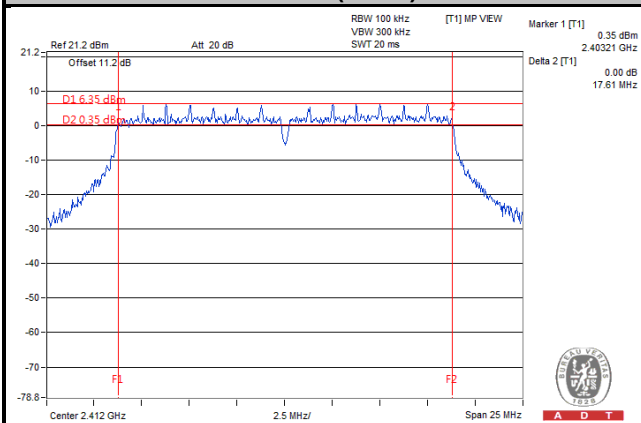

4.4 Conducted Output Power Measurement

4.4.1 Limits of Conducted Output Power Measurement

For systems using digital modulation in the 2400–2483.5 MHz bands: 1 Watt (30 dBm)

4.4.2 Test Setup

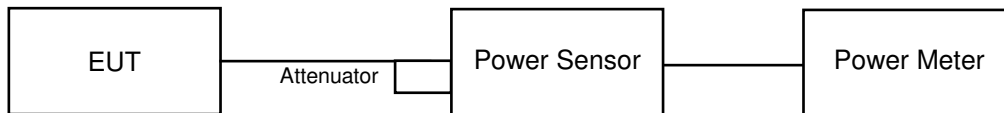

4.4.3 Test Instruments

Refer to section 4.1.2 to get information of above instrument.

4.4.4 Test Procedures

A peak power sensor was used on the output port of the EUT. A power meter was used to read the response of the peak power sensor. Record the power level.

4.4.5 Deviation from Test Standard

No deviation.

4.4.6 EUT Operating Conditions

The software provided by client to enable the EUT under transmission condition continuously at lowest, middle and highest channel frequencies individually.

4.4.7 Test Results

802.11b

Channel	Frequency (MHz)	Peak Power (mW)	Peak Power (dBm)	Limit (dBm)	Pass / Fail
1	2412	266.07	24.25	30	Pass
6	2437	272.27	24.35	30	Pass
11	2462	273.53	24.37	30	Pass

802.11g

Channel	Frequency (MHz)	Peak Power (mW)	Peak Power (dBm)	Limit (dBm)	Pass / Fail
1	2412	343.56	25.36	30	Pass
6	2437	381.94	25.82	30	Pass
11	2462	323.59	25.1	30	Pass

802.11n (HT20)

Channel	Frequency (MHz)	Peak Power (mW)	Peak Power (dBm)	Limit (dBm)	Pass / Fail
1	2412	347.54	25.41	30	Pass
6	2437	409.26	26.12	30	Pass
11	2462	367.28	25.65	30	Pass

4.5 Power Spectral Density Measurement

4.5.1 Limits of Power Spectral Density Measurement

The Maximum of Power Spectral Density Measurement is 8 dBm.

4.5.2 Test Setup

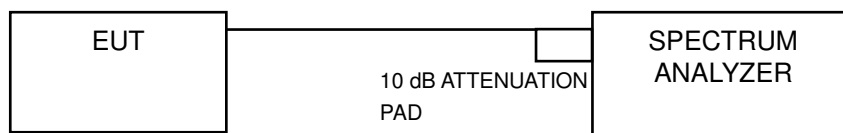

4.5.3 Test Instruments

Refer to section 4.1.2 to get information of above instrument.

4.5.4 Test Procedure

- a. Set analyzer center frequency to DTS channel center frequency.
- b. Set the span to 1.5 times the DTS bandwidth.
- c. Set the RBW to: $3 \text{ kHz} \leq \text{RBW} \leq 100 \text{ kHz}$.
- d. Set the VBW $\geq 3 \times \text{RBW}$.
- e. Detector = peak.
- f. Sweep time = auto couple.
- g. Trace mode = max hold.
- h. Allow trace to fully stabilize.
- i. Use the peak marker function to determine the maximum amplitude level within the RBW.

4.5.5 Deviation from Test Standard

No deviation.

4.5.6 EUT Operating Condition

The software provided by client to enable the EUT under transmission condition continuously at lowest, middle and highest channel frequencies individually.

4.5.7 Test Results

802.11b

Channel	Frequency (MHz)	PSD (dBm)	Limit (dBm)	Pass / Fail
1	2412	-1.04	8	Pass
6	2437	-0.55	8	Pass
11	2462	-0.44	8	Pass

802.11g

Channel	Frequency (MHz)	PSD (dBm)	Limit (dBm)	Pass / Fail
1	2412	-8.04	8	Pass
6	2437	-5.88	8	Pass
11	2462	-8.21	8	Pass

802.11n (HT20)

Channel	Frequency (MHz)	PSD (dBm)	Limit (dBm)	Pass / Fail
1	2412	-8.08	8	Pass
6	2437	-5.87	8	Pass
11	2462	-8.67	8	Pass

Spectrum Plot of Worst Value

802.11b

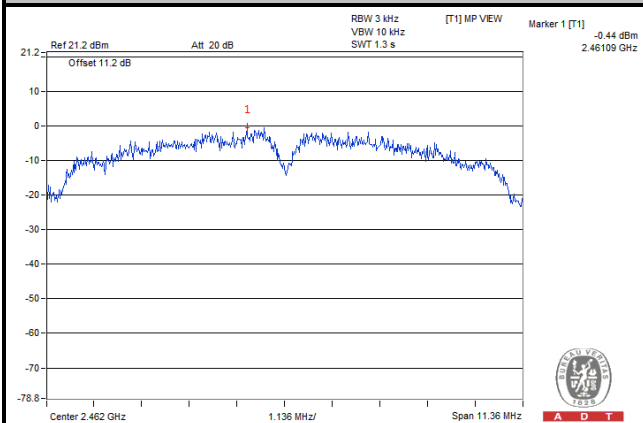

802.11g

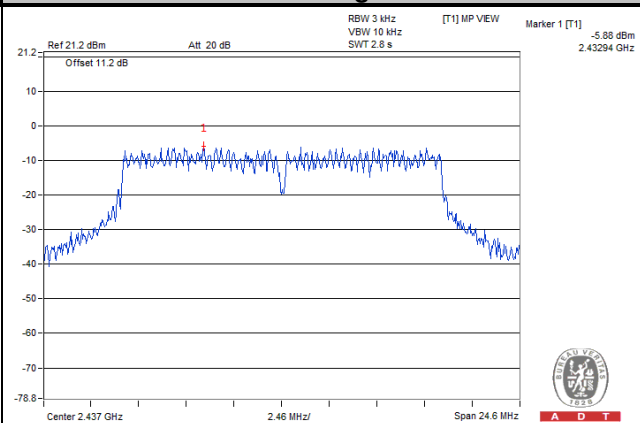

802.11n (HT20)

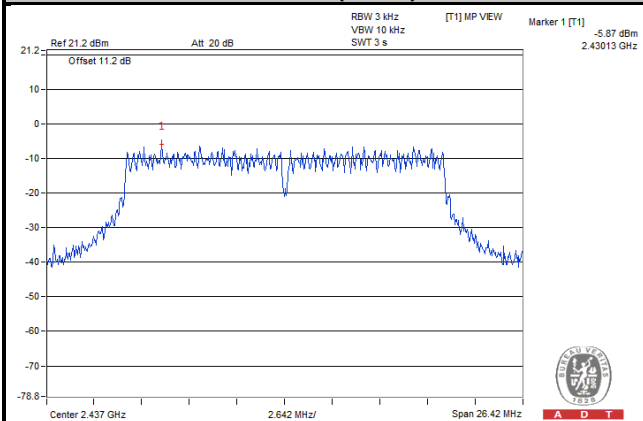

4.6 Conducted Out of Band Emission Measurement

4.6.1 Limits of Conducted Out of Band Emission Measurement

Below 20 dB of the highest emission level of operating band (in 100 kHz Resolution Bandwidth).

4.6.2 Test Setup

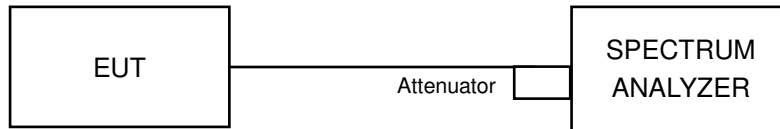

4.6.3 Test Instruments

Refer to section 4.1.2 to get information of above instrument.

4.6.4 Test Procedure

MEASUREMENT PROCEDURE REF

1. Set the RBW = 100 kHz.
2. Set the VBW \geq 300 kHz.
3. Detector = peak.
4. Sweep time = auto couple.
5. Trace mode = max hold.
6. Allow trace to fully stabilize.
7. Use the peak marker function to determine the maximum power level in any 100 kHz band segment within the fundamental EBW.

MEASUREMENT PROCEDURE OOB

1. Set RBW = 100 kHz.
2. Set VBW \geq 300 kHz.
3. Detector = peak.
4. Sweep = auto couple.
5. Trace Mode = max hold.
6. Allow trace to fully stabilize.
7. Use the peak marker function to determine the maximum amplitude level.

4.6.5 Deviation from Test Standard

No deviation.

4.6.6 EUT Operating Condition

The software provided by client to enable the EUT under transmission condition continuously at lowest, middle and highest channel frequencies individually.

4.6.7 Test Results

The spectrum plots are attached on the following images. D1 line indicates the highest level, and D2 line indicates the 20 dB offset below D1. It shows compliance with the requirement.

802.11b

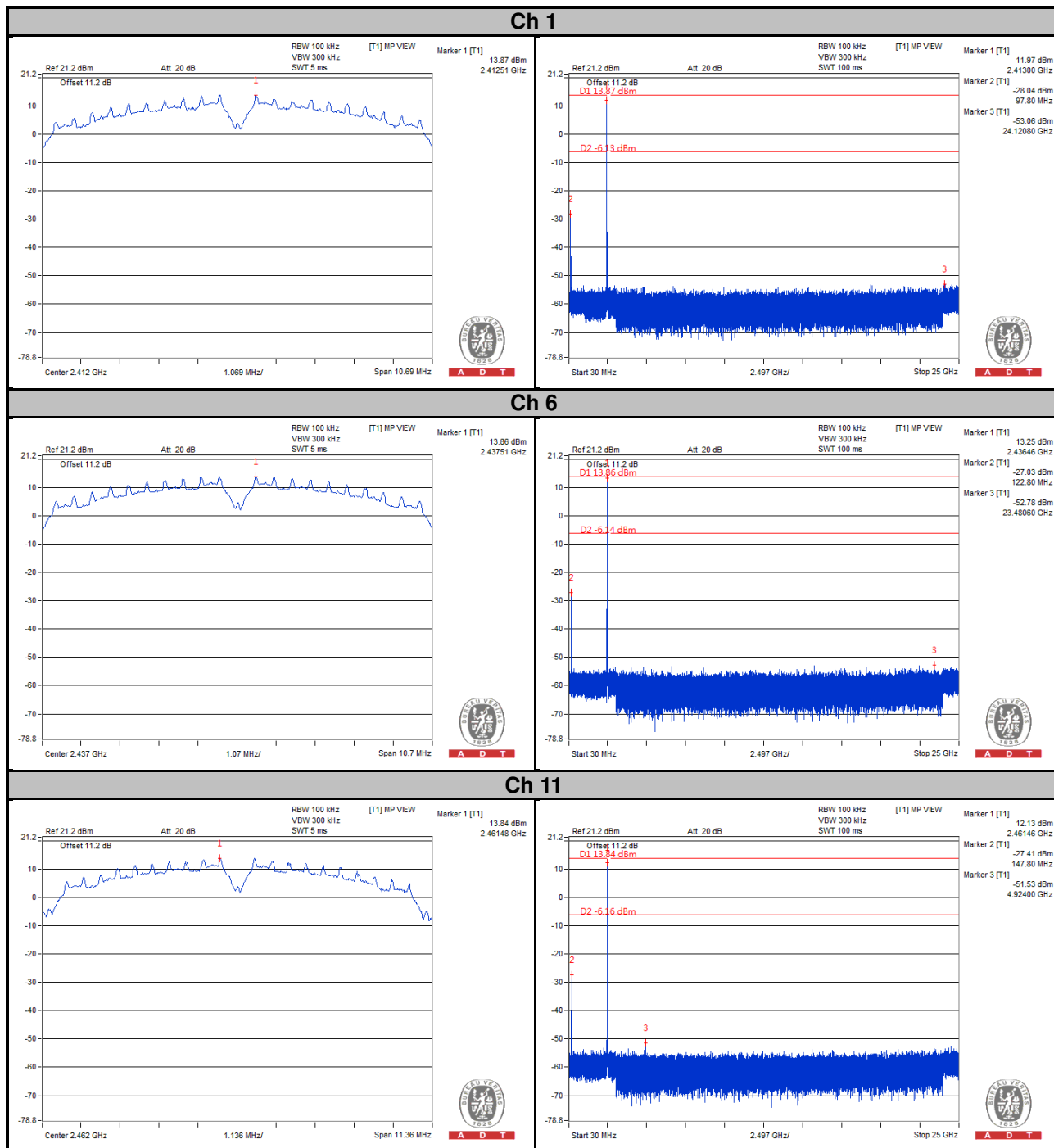

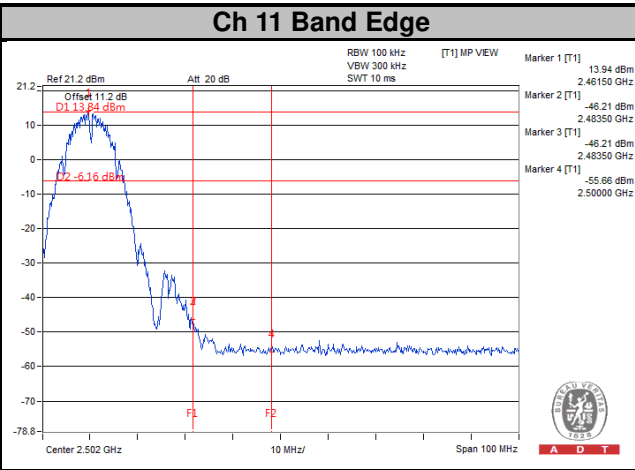
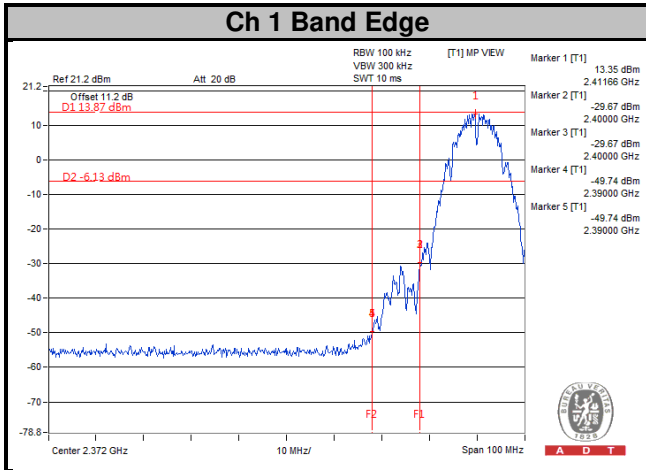

802.11g

Ch 1

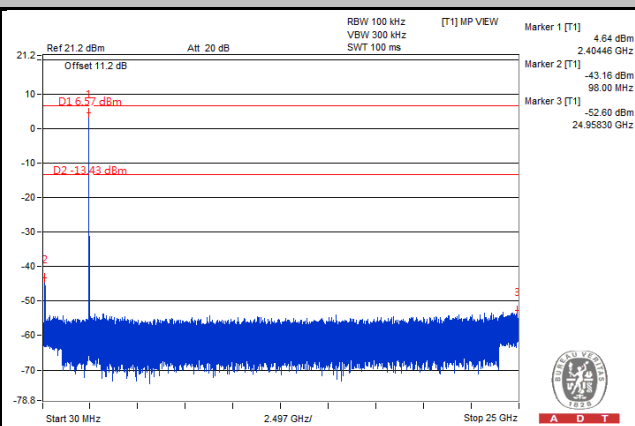
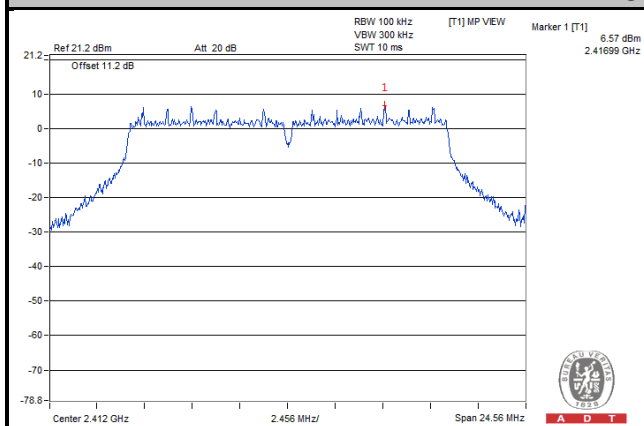

Ch 6

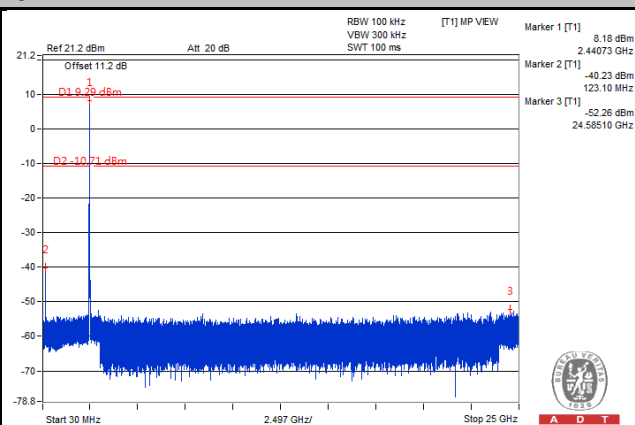
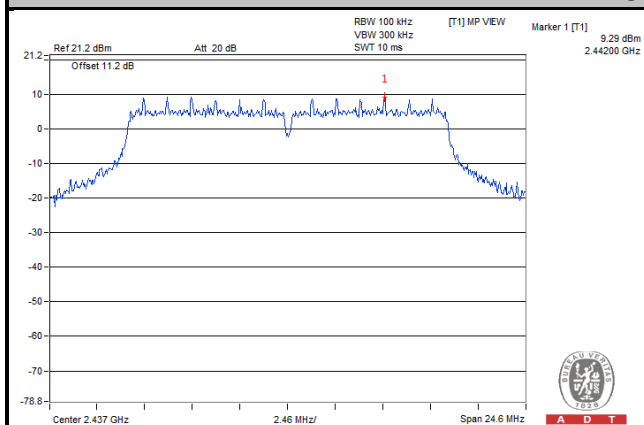

Ch 11

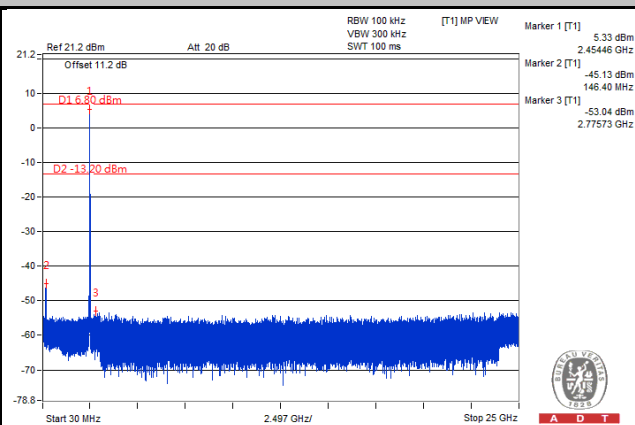
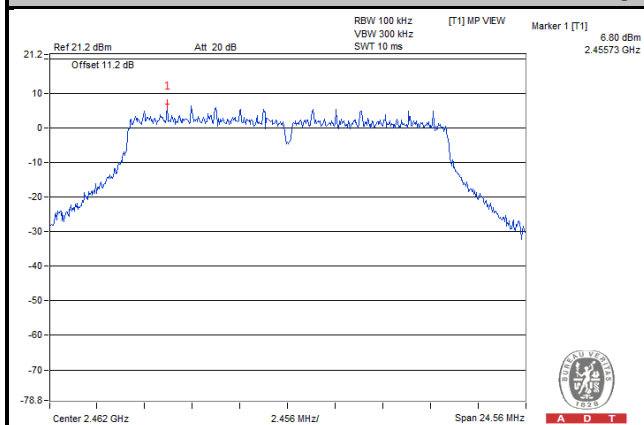

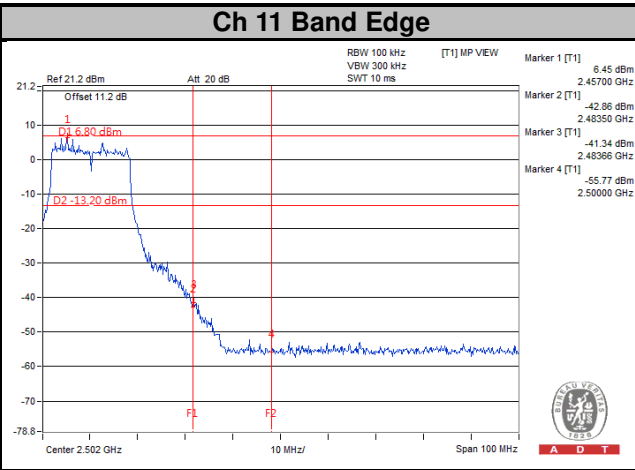
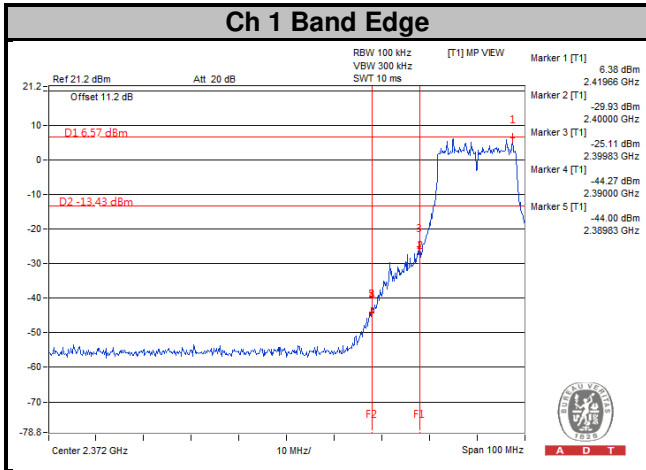

802.11n (HT20)

Ch 1

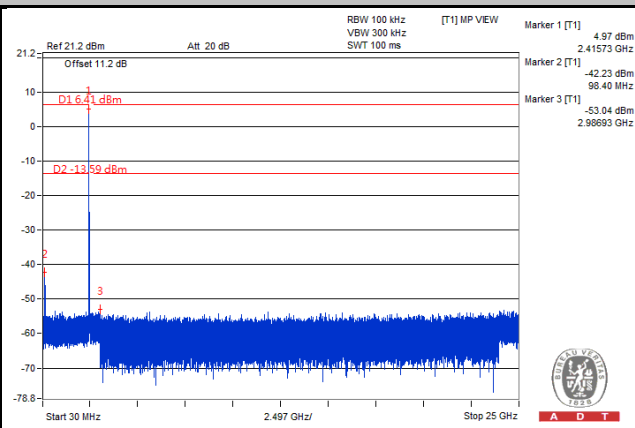
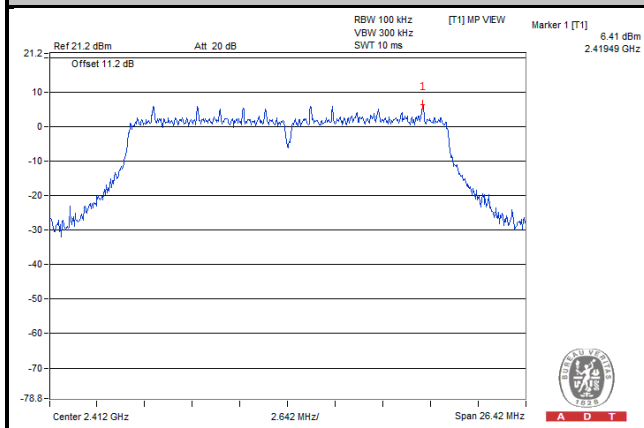

Ch 6

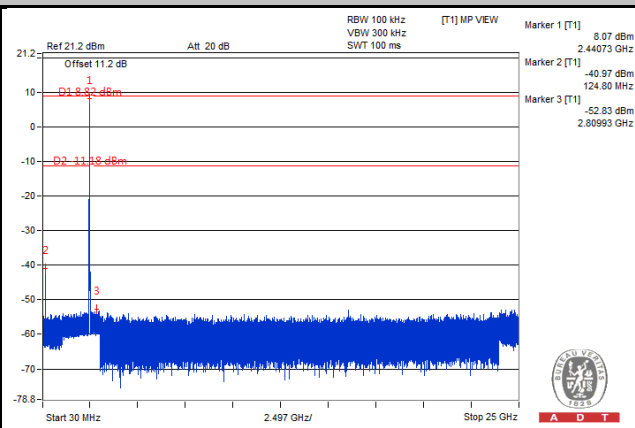
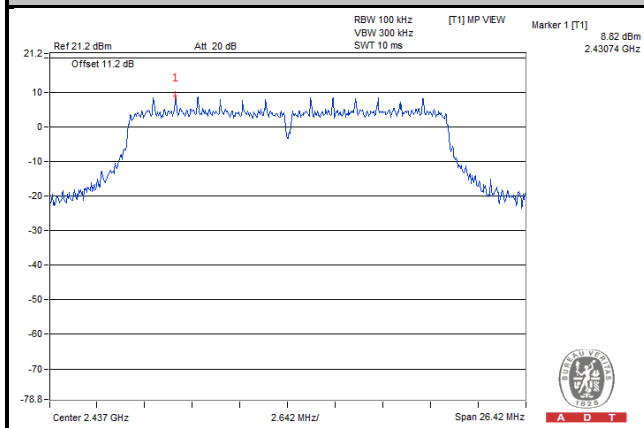

Ch 11

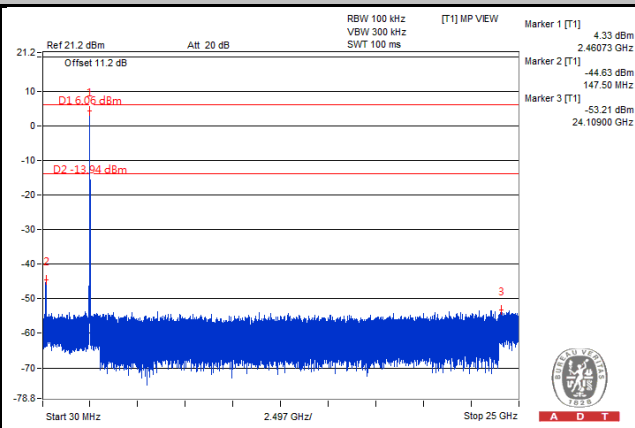
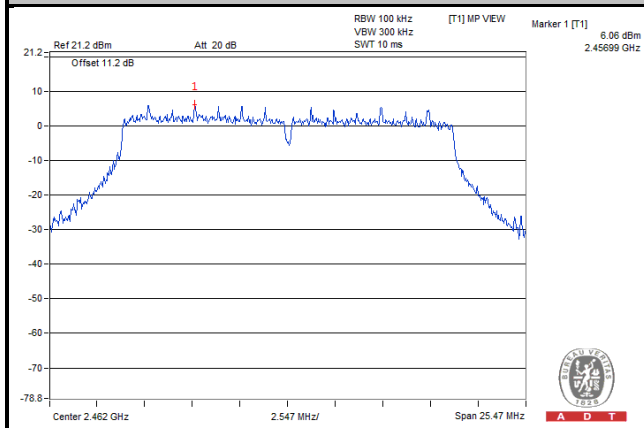

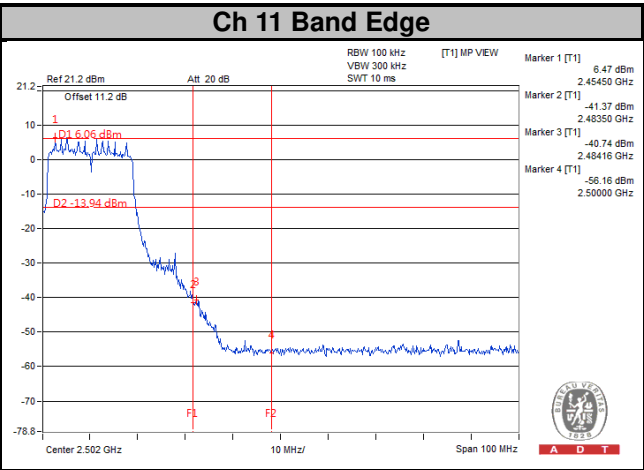
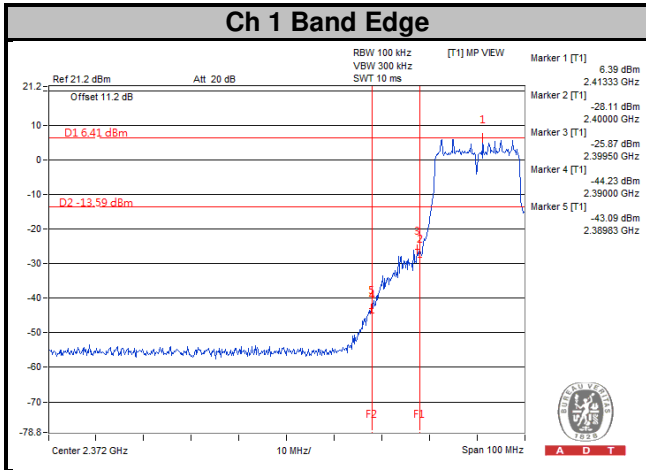

5 Pictures of Test Arrangements

Please refer to the attached file (Test Setup Photo).

Appendix – Information on the Testing Laboratories

We, Bureau Veritas Consumer Products Services (H.K.) Ltd., Taoyuan Branch, were founded in 1988 to provide our best service in EMC, Radio, Telecom and Safety consultation. Our laboratories are accredited and approved according to ISO/IEC 17025.

If you have any comments, please feel free to contact us at the following:

Linko EMC/RF Lab

Tel: 886-2-26052180

Fax: 886-2-26051924

Hsin Chu EMC/RF/Telecom Lab

Tel: 886-3-6668565

Fax: 886-3-6668323

Hwa Ya EMC/RF/Safety Lab

Tel: 886-3-3183232

Fax: 886-3-3270892

Email: service.adt@tw.bureauveritas.com

Web Site: www.bureauveritas-adt.com

The address and road map of all our labs can be found in our web site also.

--- END ---