



FCC TEST REPORT (PART 27)

REPORT NO.: RF150617C06-2

MODEL NO.: E6790

FCC ID: V65E6790

RECEIVED: Jun. 17, 2015

TESTED: Jun. 29, 2015 ~ Jul. 04, 2015

ISSUED: Jul. 14, 2015

APPLICANT: Kyocera Corporation c/o Kyocera Communications, Inc.

ADDRESS: 9520 Town Center Drive, Suite #200, San Diego, CA 92121

ISSUED BY: Bureau Veritas Consumer Products Services (H.K.) Ltd., Taoyuan Branch

LAB ADDRESS: No. 47-2, 14th Ling, Chia Pau Vil., Lin Kou Dist., New Taipei City, Taiwan, R.O.C.

TEST LOCATION: No. 19, Hwa Ya 2nd Rd, Wen Hwa Vil., Kwei Shan Dist., Taoyuan City 333, Taiwan, R.O.C.

This report should not be used by the client to claim product certification, approval, or endorsement by TAF or any government agencies.



This report is for your exclusive use. Any copying or replication of this report to or for any other person or entity, or use of our name or trademark, is permitted only with our prior written permission. This report sets forth our findings solely with respect to the test samples identified herein. The results set forth in this report are not indicative or representative of the quality or characteristics of the lot from which a test sample was taken or any similar or identical product unless specifically and expressly noted. Our report includes all of the tests requested by you and the results thereof based upon the information that you provided to us. You have 60 days from date of issuance of this report to notify us of any material error or omission caused by our negligence, provided, however, that such notice shall be in writing and shall specifically address the issue you wish to raise. A failure to raise such issue within the prescribed time shall constitute your unqualified acceptance of the completeness of this report, the tests conducted and the correctness of the report contents. Unless specific mention, the uncertainty of measurement has been explicitly taken into account to declare the compliance or non-compliance to the specification



TABLE OF CONTENTS

RELEASE CONTROL RECORD.....	3
1 CERTIFICATION	4
2 SUMMARY OF TEST RESULTS.....	5
2.1 MEASUREMENT UNCERTAINTY	6
2.2 TEST SITE AND INSTRUMENTS	7
3 GENERAL INFORMATION	8
3.1 GENERAL DESCRIPTION OF EUT.....	8
3.2 CONFIGURATION OF SYSTEM UNDER TEST	11
3.3 DESCRIPTION OF SUPPORT UNITS.....	11
3.4 DESCRIPTION OF TEST MODES.....	12
3.5 GENERAL DESCRIPTION OF APPLIED STANDARDS	16
4 TEST TYPES AND RESULTS.....	17
4.1 OUTPUT POWER MEASUREMENT	17
4.1.1 LIMITS OF OUTPUT POWER MEASUREMENT	17
4.1.2 TEST PROCEDURES.....	17
4.1.3 TEST SETUP	18
4.1.4 TEST RESULTS	19
4.2 FREQUENCY STABILITY MEASUREMENT	30
4.2.1 LIMITS OF FREQUENCY STABILITY MEASUREMENT	30
4.2.2 TEST PROCEDURE	30
4.2.3 TEST SETUP	30
4.2.4 TEST RESULTS.....	31
4.3 OCCUPIED BANDWIDTH MEASUREMENT.....	33
4.3.1 LIMITS OF OCCUPIED BANDWIDTH MEASUREMENT.....	33
4.3.2 TEST SETUP	33
4.3.3 TEST PROCEDURES.....	33
4.3.4 TEST RESULTS	34
4.4 PEAK TO AVERAGE RATIO.....	40
4.4.1 LIMITS OF PEAK TO AVERAGE RATIO MEASUREMENT	40
4.4.2 TEST SETUP	40
4.4.3 TEST PROCEDURES.....	40
4.4.4 TEST RESULTS	41
4.5 BAND EDGE MEASUREMENT	47
4.5.1 LIMITS OF BAND EDGE MEASUREMENT	47
4.5.2 TEST SETUP	47
4.5.3 TEST PROCEDURES.....	48
4.5.4 TEST RESULTS	49
4.6 CONDUCTED SPURIOUS EMISSIONS.....	61
4.6.1 LIMITS OF CONDUCTED SPURIOUS EMISSIONS MEASUREMENT.....	61
4.6.2 TEST PROCEDURE	61
4.6.3 TEST SETUP	61
4.6.4 TEST RESULTS	62
4.7 RADIATED EMISSION MEASUREMENT	64
4.7.1 LIMITS OF RADIATED EMISSION MEASUREMENT	64
4.7.2 TEST PROCEDURES.....	64
4.7.3 DEVIATION FROM TEST STANDARD.....	64
4.7.4 TEST SETUP	65
4.7.5 TEST RESULTS	66
5 INFORMATION ON THE TESTING LABORATORIES	72
6 APPENDIX A – MODIFICATIONS RECORDERS FOR ENGINEERING CHANGES TO THE EUT BY THE LAB.....	73



A D T

RELEASE CONTROL RECORD

ISSUE NO.	REASON FOR CHANGE	DATE ISSUED
RF150617C06-2	Original release	Jul. 14, 2015



A D T

1 CERTIFICATION

PRODUCT: PDA Phone
MODEL NO.: E6790
BRAND: Kyocera
APPLICANT: Kyocera Corporation c/o Kyocera Communications, Inc.
TESTED: Jun. 29, 2015 ~ Jul. 04, 2015
TEST SAMPLE: Identical Prototype
TEST STANDARDS: **FCC Part 27, Subpart C, L**
FCC Part 2

The above equipment (model: E6790) has been tested by **Bureau Veritas Consumer Products Services (H.K.) Ltd., Taoyuan Branch**, and found compliance with the requirement of the above standards. The test record, data evaluation & Equipment Under Test (EUT) configurations represented herein are true and accurate accounts of the measurements of the sample's EMC characteristics under the conditions specified in this report.

PREPARED BY : Ivonne Wu , **DATE:** Jul. 14, 2015
Ivonne Wu / Supervisor

APPROVED BY : Kay Wu , **DATE:** Jul. 14, 2015
Kay Wu / Supervisor



2 SUMMARY OF TEST RESULTS

The EUT has been tested according to the following specifications:

LTE Band 4			
STANDARD SECTION	TEST TYPE AND LIMIT	RESULT	REMARK
2.1046 27.50(d)(4)	Maximum Peak Output Power	PASS	Meet the requirement of limit.
2.1055 27.54	Frequency Stability	PASS	Meet the requirement of limit.
2.1049 27.53(h)	Occupied Bandwidth	PASS	Meet the requirement of limit.
27.50(d)(5)	Peak to Average Ratio	PASS	Meet the requirement of limit.
27.53(h)	Band Edge Measurements	PASS	Meet the requirement of limit.
2.1051 27.53(h)	Conducted Spurious Emissions	PASS	Meet the requirement of limit.
2.1053 27.53(h)	Radiated Spurious Emissions	PASS	Meet the requirement of limit. Minimum passing margin is -22.23dB at 5197.50MHz.

LTE BAND 12			
STANDARD SECTION	TEST TYPE AND LIMIT	RESULT	REMARK
2.1046 27.50(C)(10)	Maximum Peak Output Power	PASS	Meet the requirement of limit.
2.1055 27.54	Frequency Stability	PASS	Meet the requirement of limit.
2.1049 27.53(g)	Occupied Bandwidth	PASS	Meet the requirement of limit.
27.50(d)(5)	Peak to Average Ratio	PASS	Meet the requirement of limit.
27.53(g)	Band Edge Measurements	PASS	Meet the requirement of limit.
2.1051 27.53(g)	Conducted Spurious Emissions	PASS	Meet the requirement of limit.
2.1053 27.53(g)	Radiated Spurious Emissions	PASS	Meet the requirement of limit. Minimum passing margin is -36.84dB at 2122.50MHz.

LTE Band 17			
STANDARD SECTION	TEST TYPE AND LIMIT	RESULT	REMARK
2.1046 27.50(C)(10)	Maximum Peak Output Power	PASS	Meet the requirement of limit.
2.1055 27.54	Frequency Stability	PASS	Meet the requirement of limit.
2.1049 27.53(g)	Occupied Bandwidth	PASS	Meet the requirement of limit.
27.50(d)(5)	Peak to Average Ratio	PASS	Meet the requirement of limit.
27.53(g)	Band Edge Measurements	PASS	Meet the requirement of limit.
2.1051 27.53(g)	Conducted Spurious Emissions	PASS	Meet the requirement of limit.
2.1053 27.53(g)	Radiated Spurious Emissions	PASS	Meet the requirement of limit. Minimum passing margin is -33.30dB at 2130.00MHz.

2.1 MEASUREMENT UNCERTAINTY

Where relevant, the following measurement uncertainty levels have been estimated for tests performed on the EUT as specified in CISPR 16-4-2:

MEASUREMENT	FREQUENCY	UNCERTAINTY
Conducted emissions	9kHz~30MHz	2.44 dB
Radiated emissions	30MHz ~ 200MHz	2.93 dB
	200MHz ~1000MHz	2.95 dB
	1GHz ~ 18GHz	2.26 dB
	18GHz ~ 40GHz	1.94 dB

This uncertainty represents an expanded uncertainty expressed at approximately the 95% confidence level using a coverage factor of $k=2$.



A D T

2.2 TEST SITE AND INSTRUMENTS

DESCRIPTION & MANUFACTURER	MODEL NO.	SERIAL NO.	DATE OF CALIBRATION	DUE DATE OF CALIBRATION
Test Receiver Agilent	N9038A	MY51210203	Jan. 21, 2015	Jan. 21, 2016
Spectrum Analyzer Agilent	N9010A	MY52220314	Sep. 03, 2014	Sep. 02, 2015
Spectrum Analyzer ROHDE & SCHWARZ	FSU43	101261	Dec. 10, 2014	Dec. 09, 2015
BILOG Antenna SCHWARZBECK	VULB9168	9168-472	Feb. 04, 2015	Feb. 04, 2016
HORN Antenna SCHWARZBECK	BBHA 9120 D	9120D-969	Feb. 09, 2015	Feb. 09, 2016
HORN Antenna SCHWARZBECK	BBHA 9170	9170-480	Feb. 04, 2015	Feb. 04, 2016
Loop Antenna	EM-6879	269	Aug. 13, 2014	Aug. 12, 2015
Preamplifier EMCI	EMC 012645	980115	Dec. 12, 2014	Dec. 11, 2015
Preamplifier EMCI	EMC 184045	980116	Jan. 09, 2015	Jan. 08, 2016
Preamplifier EMCI	EMC 330H	980112	Dec. 27, 2014	Dec. 26, 2015
Power Meter Anritsu	ML2495A	1232002	Sep. 17, 2014	Sep. 16, 2015
Power Sensor Anritsu	MA2411B	1207325	Sep. 17, 2014	Sep. 16, 2015
RF signal cable HUBER+SUHNNER	SUCOFLEX 104	309219/4 2950114	Oct. 18, 2014	Oct. 17, 2015
RF signal cable HUBER+SUHNNER	SUCOFLEX 104	250130/4	Oct. 18, 2014	Oct. 17, 2015
RF Coaxial Cable Worken	8D-FB	Cable-Ch10-01	Nov. 07, 2014	Nov. 06, 2015
Software BV ADT	E3 6.120103	NA	NA	NA
Antenna Tower MF	MFA-440H	NA	NA	NA
Turn Table MF	MFT-201SS	NA	NA	NA
Antenna Tower & Turn Table Controller MF	MF-7802	NA	NA	NA
Radio Communication Analyzer	MT8820C	6201300640	Aug. 01, 2013	Jul. 31, 2015

- NOTE:**
1. The calibration interval of the above test instruments is 12 / 24 months and the calibrations are traceable to NML/ROC and NIST/USA.
 2. The test was performed in HwaYa Chamber 10.
 3. The horn antenna and HP preamplifier (model: 8449B) are used only for the measurement of emission frequency above 1GHz if tested.
 4. The FCC Site Registration No. is 690701.
 5. The IC Site Registration No. is IC 7450F-10.



3 GENERAL INFORMATION

3.1 GENERAL DESCRIPTION OF EUT

PRODUCT	PDA Phone	
MODEL NO.	E6790	
POWER SUPPLY	5Vdc (adapter or host equipment) 3.55Vdc (battery)	
MODULATION TECHNOLOGY	LTE Band 4	QPSK, 16QAM
	LTE Band 12	QPSK, 16QAM
	LTE Band 17	QPSK, 16QAM
FREQUENCY RANGE	LTE Band 4 Channel Bandwidth: 1.4MHz	1710.7MHz ~1754.3MHz
	LTE Band 4 Channel Bandwidth: 3MHz	1711.5MHz ~1753.5MHz
	LTE Band 4 Channel Bandwidth: 5MHz	1712.5MHz ~1752.5MHz
	LTE Band 4 Channel Bandwidth: 10MHz	1715.0MHz ~1750.0MHz
	LTE Band 4 Channel Bandwidth: 15MHz	1717.5MHz ~1747.5MHz
	LTE Band 4 Channel Bandwidth: 20MHz	1720.0MHz ~1745.0MHz
	LTE Band 12 Channel Bandwidth: 1.4MHz	699.7MHz ~ 715.3MHz
	LTE Band 12 Channel Bandwidth: 3MHz	700.5MHz ~ 714.5MHz
	LTE Band 12 Channel Bandwidth: 5MHz	701.5MHz ~ 713.5MHz
	LTE Band 12 Channel Bandwidth: 10MHz	704.0MHz ~ 711.0MHz
	LTE Band 17 Channel Bandwidth: 5MHz	706.5MHz ~ 713.5MHz
	LTE Band 17 Channel Bandwidth: 10MHz	709MHz ~ 711MHz



A D T

EMISSION DESIGNATOR	LTE Band 4 Channel Bandwidth: 1.4MHz	1M09G7D	
	LTE Band 4 Channel Bandwidth: 3MHz	2M70G7D	
	LTE Band 4 Channel Bandwidth: 5MHz	4M49G7D	
	LTE Band 4 Channel Bandwidth: 10MHz	8M97W7D	
	LTE Band 4 Channel Bandwidth: 15MHz	13M4G7D	
	LTE Band 4 Channel Bandwidth: 20MHz	17M9W7D	
	LTE Band 12 Channel Bandwidth: 1.4MHz	1M09G7D	
	LTE Band 12 Channel Bandwidth: 3MHz	2M70G7D	
	LTE Band 12 Channel Bandwidth: 5MHz	4M50G7D	
	LTE Band 12 Channel Bandwidth: 10MHz	8M98W7D	
	LTE Band 17 Channel Bandwidth: 5MHz	4M50G7D	
	LTE Band 17 Channel Bandwidth: 10MHz	8M99W7D	
	MAX. ERP POWER	LTE Band 12 Channel Bandwidth: 1.4MHz	122.07mW
		LTE Band 12 Channel Bandwidth: 3MHz	118.47mW
LTE Band 12 Channel Bandwidth: 5MHz		119.01mW	
LTE Band 12 Channel Bandwidth: 10MHz		122.38mW	
LTE Band 17 Channel Bandwidth: 5MHz		118.82mW	
LTE Band 17 Channel Bandwidth: 10MHz		121.53mW	
MAX. EIRP POWER	LTE Band 4 Channel Bandwidth: 1.4MHz	235.34mW	
	LTE Band 4 Channel Bandwidth: 3MHz	234.80mW	
	LTE Band 4 Channel Bandwidth: 5MHz	235.88mW	
	LTE Band 4 Channel Bandwidth: 10MHz	236.97mW	
	LTE Band 4 Channel Bandwidth: 15MHz	237.14mW	
	LTE Band 4 Channel Bandwidth: 20MHz	248.31mW	



A D T

ANTENNA TYPE	Fixed Internal Antenna
DATA CABLE	Refer to Note as below
I/O PORTS	Refer to users' manual
ACCESSORY DEVICES	Refer to Note as below

NOTE:

1. The EUT contains following accessory devices.

Product	Brand	Model	Description
Adapter	KYOCERA	SCP-46ADT	I/P: 100-240Vac, 50/60Hz, 0.2A O/P: 5Vdc, 1.5A
Battery	KYOCERA	SCP-65LBPS	3.55Vdc, 3700mAh
Earphone	GALIEN	HF-HB05D	1.3m non-shielded cable w/o core
USB Cable	KYOCERA	SCP-17SDC	1.0m shielded cable w/o core

2. The above EUT information is declared by manufacturer and for more detailed features description, please refer to the manufacturer's specifications or User's Manual.

3.2 CONFIGURATION OF SYSTEM UNDER TEST FOR RADIATION EMISSION TEST

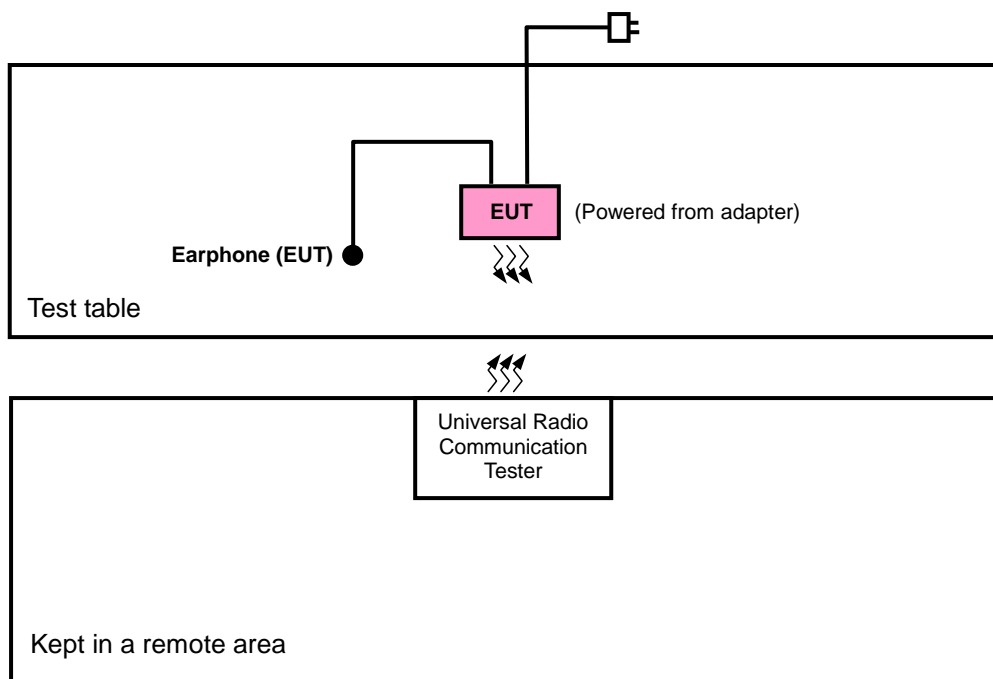

FOR E.R.P. / E.I.R.P. TEST

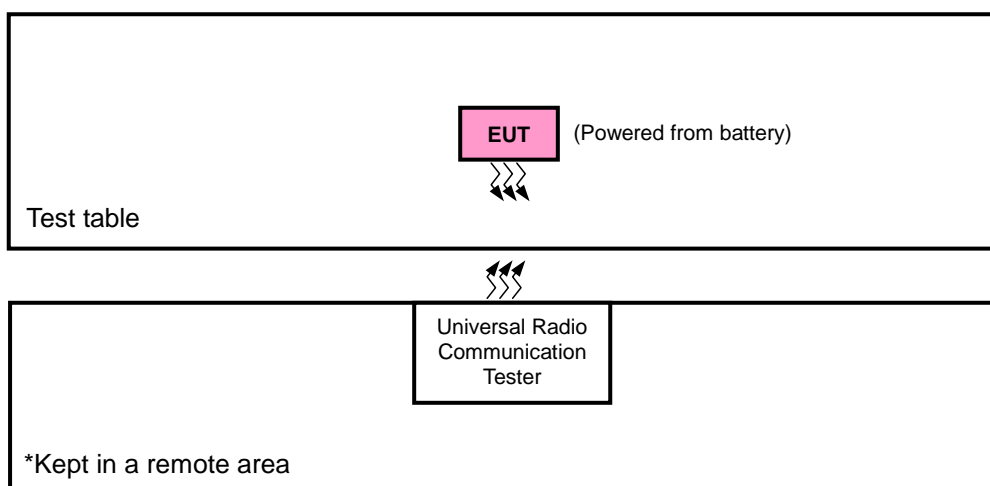

3.3 DESCRIPTION OF SUPPORT UNITS

The EUT has been tested as an independent unit together with other necessary accessories or support units.

3.4 DESCRIPTION OF TEST MODES

Pre-Scan has been conducted to determine the worst-case mode from all possible combinations between available modulations, data rates, XYZ axis and antenna ports. The worst case was found as the table below. Following channel(s) was (were) selected for the final test as listed below:

BAND	ERP / EIRP	RADIATED EMISSION
LTE Band 4	X-plane	Z-axis
LTE Band 12	Y-plane	Y-axis
LTE Band 17	Y-plane	Y-axis

LTE Band 4

EUT CONFIGURE MODE	TEST ITEM	AVAILABLE CHANNEL	TESTED CHANNEL	CHANNEL BANDWIDTH	MODULATION	MODE
-	EIRP	19957 to 20393	19957, 20175, 20393	1.4MHz	QPSK, 16QAM	1 RB / 0 RB Offset
		19965 to 20385	19965, 20175, 20385	3MHz	QPSK, 16QAM	1 RB / 0 RB Offset
		19975 to 20375	19975, 20175, 20375	5MHz	QPSK, 16QAM	1 RB / 0 RB Offset
		20000 to 20350	20000, 20175, 20350	10MHz	QPSK, 16QAM	1 RB / 0 RB Offset
		20025 to 20325	20025, 20175, 20325	15MHz	QPSK, 16QAM	1 RB / 0 RB Offset
		20050 to 20300	20050, 20175, 20300	20MHz	QPSK, 16QAM	1 RB / 0 RB Offset
-	FREQUENCY STABILITY	19957 to 20393	20175	1.4MHz	QPSK	1 RB / 0 RB Offset
		19965 to 20385	20175	3MHz	QPSK	1 RB / 0 RB Offset
		19975 to 20375	20175	5MHz	QPSK	1 RB / 0 RB Offset
		20000 to 20350	20175	10MHz	QPSK	1 RB / 0 RB Offset
		20025 to 20325	20175	15MHz	QPSK	1 RB / 0 RB Offset
		20050 to 20300	20175	20MHz	QPSK	1 RB / 0 RB Offset
-	OCCUPIED BANDWIDTH	19957 to 20393	19957, 20175, 20393	1.4MHz	QPSK, 16QAM	6 RB / 0 RB Offset
		19965 to 20385	19965, 20175, 20385	3MHz	QPSK, 16QAM	15 RB / 0 RB Offset
		19975 to 20375	19975, 20175, 20375	5MHz	QPSK, 16QAM	25 RB / 0 RB Offset
		20000 to 20350	20000, 20175, 20350	10MHz	QPSK, 16QAM	50 RB / 0 RB Offset
		20025 to 20325	20025, 20175, 20325	15MHz	QPSK, 16QAM	75 RB / 0 RB Offset
		20050 to 20300	20050, 20175, 20300	20MHz	QPSK, 16QAM	100 RB / 0 RB Offset
-	PEAK TO AVERAGE RATIO	19957 to 20393	19957, 20175, 20393	1.4MHz	QPSK, 16QAM	1 RB / 0 RB Offset
		19965 to 20385	19965, 20175, 20385	3MHz	QPSK, 16QAM	1 RB / 0 RB Offset
		19975 to 20375	19975, 20175, 20375	5MHz	QPSK, 16QAM	12 RB / 0 RB Offset
		20000 to 20350	20000, 20175, 20350	10MHz	QPSK, 16QAM	1 RB / 0 RB Offset
		20025 to 20325	20025, 20175, 20325	15MHz	QPSK, 16QAM	1 RB / 0 RB Offset
		20050 to 20300	20050, 20175, 20300	20MHz	QPSK, 16QAM	1 RB / 0 RB Offset



EUT CONFIGURE MODE	TEST ITEM	AVAILABLE CHANNEL	TESTED CHANNEL	CHANNEL BANDWIDTH	MODULATION	MODE		
-	BAND EDGE	19957 to 20393	19957	1.4MHz	QPSK	1 RB / 0 RB Offset 6 RB / 0 RB Offset		
			20393	1.4MHz	QPSK	1 RB / 5 RB Offset 6 RB / 0 RB Offset		
		19965 to 20385	19965	3MHz	QPSK	1 RB / 0 RB Offset 15 RB / 0 RB Offset		
			20385	3MHz	QPSK	1 RB / 14 RB Offset 15 RB / 0 RB Offset		
		19975 to 20375	19975	5MHz	QPSK	1 RB / 0 RB Offset 25 RB / 0 RB Offset		
			20375	5MHz	QPSK	1 RB / 24 RB Offset 25 RB / 0 RB Offset		
		20000 to 20350	20000	10MHz	QPSK	1 RB / 0 RB Offset 50 RB / 0 RB Offset		
			20350	10MHz	QPSK	1 RB / 49 RB Offset 50 RB / 0 RB Offset		
		20025 to 20325	20025	15MHz	QPSK	1 RB / 0 RB Offset 75 RB / 0 RB Offset		
			20325	15MHz	QPSK	1 RB / 74 RB Offset 75 RB / 0 RB Offset		
		20050 to 20300	20050	20MHz	QPSK	1 RB / 0 RB Offset 100 RB / 0 RB Offset		
			20300	20MHz	QPSK	1 RB / 99 RB Offset 100 RB / 0 RB Offset		
		-	CONDUCTED EMISSION	19957 to 20393	20175	1.4MHz	QPSK	1 RB / 0 RB Offset
				19965 to 20385	20175	3MHz	QPSK	1 RB / 0 RB Offset
				19975 to 20375	20175	5MHz	QPSK	12 RB / 0 RB Offset
				20000 to 20350	20175	10MHz	QPSK	50 RB / 0 RB Offset
20025 to 20325	20175			15MHz	QPSK	1 RB / 0 RB Offset		
20050 to 20300	20175			20MHz	QPSK	1 RB / 0 RB Offset		
-	RADIATED EMISSION	20050 to 20300	20175	20MHz	QPSK	1 RB / 0 RB Offset		

Note: This device was tested under all bandwidths, RB configurations and modulations. The worst case was found in QPSK modulation.



LTE Band 12

EUT CONFIGURE MODE	TEST ITEM	AVAILABLE CHANNEL	TESTED CHANNEL	CHANNEL BANDWIDTH	MODULATION	MODE		
-	ERP	23017 to 23173	23017, 23095, 23173	1.4MHz	QPSK, 16QAM	1 RB / 5 RB Offset		
		23025 to 23165	23025, 23095, 23165	3MHz	QPSK, 16QAM	1 RB / 14 RB Offset		
		23035 to 23155	23035, 23095, 23155	5MHz	QPSK, 16QAM	1 RB / 24 RB Offset		
		23060 to 23130	23060, 23095, 23130	10MHz	QPSK, 16QAM	1 RB / 49 RB Offset		
-	FREQUENCY STABILITY	23017 to 23173	23095	1.4MHz	QPSK	1 RB / 5 RB Offset		
		23025 to 23165	23095	3MHz	QPSK	1 RB / 14 RB Offset		
		23035 to 23155	23095	5MHz	QPSK	1 RB / 24 RB Offset		
		23060 to 23130	23095	10MHz	QPSK	1 RB / 49 RB Offset		
-	OCCUPIED BANDWIDTH	23017 to 23173	23017, 23095, 23173	1.4MHz	QPSK, 16QAM	6 RB / 0 RB Offset		
		23025 to 23165	23025, 23095, 23165	3MHz	QPSK, 16QAM	15 RB / 0 RB Offset		
		23035 to 23155	23035, 23095, 23155	5MHz	QPSK, 16QAM	25 RB / 0 RB Offset		
		23060 to 23130	23060, 23095, 23130	10MHz	QPSK, 16QAM	50 RB / 0 RB Offset		
-	PEAK TO AVERAGE RATIO	23017 to 23173	23017, 23095, 23173	1.4MHz	QPSK, 16QAM	1 RB / 5 RB Offset		
		23025 to 23165	23025, 23095, 23165	3MHz	QPSK, 16QAM	1 RB / 14 RB Offset		
		23035 to 23155	23035, 23095, 23155	5MHz	QPSK, 16QAM	1 RB / 24 RB Offset		
		23060 to 23130	23060, 23095, 23130	10MHz	QPSK, 16QAM	1 RB / 49 RB Offset		
-	BAND EDGE	23017 to 23173	23017	1.4MHz	QPSK	1 RB / 0 RB Offset 6 RB / 0 RB Offset		
			23173	1.4MHz	QPSK	1 RB / 5 RB Offset 6 RB / 0 RB Offset		
		23025 to 23165	23025	3MHz	QPSK	1 RB / 0 RB Offset 15 RB / 0 RB Offset		
			23165	3MHz	QPSK	1 RB / 14 RB Offset 15 RB / 0 RB Offset		
		23035 to 23155	23035	5MHz	QPSK	1 RB / 0 RB Offset 25 RB / 0 RB Offset		
			23155	5MHz	QPSK	1 RB / 24 RB Offset 25 RB / 0 RB Offset		
		23060 to 23130	23060	10MHz	QPSK	1 RB / 0 RB Offset 50 RB / 0 RB Offset		
			23130	10MHz	QPSK	1 RB / 49 RB Offset 50 RB / 0 RB Offset		
		-	CONDUCTED EMISSION	23017 to 23173	23095	1.4MHz	QPSK	1 RB / 5 RB Offset
				23025 to 23165	23095	3MHz	QPSK	1 RB / 14 RB Offset
				23035 to 23155	23095	5MHz	QPSK	1 RB / 24 RB Offset
				23060 to 23130	23095	10MHz	QPSK	1 RB / 49 RB Offset
-	RADIATED EMISSION	23060 to 23130	23095	10MHz	QPSK	1 RB / 49 RB Offset		

Note: This device was tested under all bandwidths, RB configurations and modulations. The worst case was found in QPSK modulation.



LTE Band 17

EUT CONFIGURE MODE	TEST ITEM	AVAILABLE CHANNEL	TESTED CHANNEL	CHANNEL BANDWIDTH	MODULATION	MODE		
-	ERP	23755 to 23825	23755, 23790, 23825	5MHz	QPSK, 16QAM	1 RB / 0 RB Offset		
		23780 to 23800	23780, 23790, 23800	10MHz	QPSK, 16QAM	1 RB / 0 RB Offset		
-	FREQUENCY STABILITY	23755 to 23825	23790	5MHz	QPSK	1 RB / 0 RB Offset		
		23780 to 23800	23790	10MHz	QPSK	1 RB / 0 RB Offset		
-	OCCUPIED BANDWIDTH	23755 to 23825	23755, 23790, 23825	5MHz	QPSK, 16QAM	25 RB / 0 RB Offset		
		23780 to 23800	23780, 23790, 23800	10MHz	QPSK, 16QAM	50 RB / 0 RB Offset		
-	PEAK TO AVERAGE RATIO	23755 to 23825	23755, 23790, 23825	5MHz	QPSK, 16QAM	1 RB / 12 RB Offset		
		23780 to 23800	23780, 23790, 23800	10MHz	QPSK, 16QAM	1 RB / 24 RB Offset		
-	BAND EDGE	23755 to 23825	23755	5MHz	QPSK	1 RB / 0 RB Offset 25 RB / 0 RB Offset		
			23825	5MHz	QPSK	1 RB / 24 RB Offset 25 RB / 0 RB Offset		
		23780 to 23800	23780	10MHz	QPSK	1 RB / 0 RB Offset 50 RB / 0 RB Offset		
			23800	10MHz	QPSK	1 RB / 49 RB Offset 50 RB / 0 RB Offset		
		-	CONDUCTED EMISSION	23755 to 23825	23790	5MHz	QPSK	1 RB / 12 RB Offset
				23780 to 23800	23790	10MHz	QPSK	1 RB / 24 RB Offset
-	RADIATED EMISSION	23780 to 23800	23790	10MHz	QPSK	1 RB / 0 RB Offset		

Note: This device was tested under all bandwidths, RB configurations and modulations. The worst case was found in QPSK modulation.



A D T

TEST CONDITION:

TEST ITEM	ENVIRONMENTAL CONDITIONS	INPUT POWER	TESTED BY
ERP/EIRP	26deg. C, 58%RH	3.55Vdc	Harry Hsueh
FREQUENCY STABILITY	26deg. C, 58%RH	3.55Vdc	Wayne Lin
OCCUPIED BANDWIDTH	26deg. C, 58%RH	3.55Vdc	Wayne Lin
PEAK TO AVERAGE RATIO	26deg. C, 58%RH	3.55Vdc	Wayne Lin
BAND EDGE	26deg. C, 58%RH	3.55Vdc	Wayne Lin
CONDUCTED EMISSION	26deg. C, 58%RH	3.55Vdc	Wayne Lin
RADIATED EMISSION	25deg. C, 65%RH	120Vac, 60Hz	Charles Hsiao / Harry Hsueh

3.5 GENERAL DESCRIPTION OF APPLIED STANDARDS

The EUT is a RF product. According to the specifications of the manufacturer, it must comply with the requirements of the following standards:

FCC 47 CFR Part 2

FCC 47 CFR Part 27

ANSI/TIA/EIA-603-C 2004

NOTE: All test items have been performed and recorded as per the above standards.

4 TEST TYPES AND RESULTS

4.1 OUTPUT POWER MEASUREMENT

4.1.1 LIMITS OF OUTPUT POWER MEASUREMENT

Fixed, mobile, and portable (hand-held) stations operating in the 1710–1755 MHz band are limited to 1 watt EIRP.

Portable stations (hand-held devices) operating in the 699-716 MHz band are limited to 3 watts ERP

4.1.2 TEST PROCEDURES

EIRP MEASUREMENT:

- a. All measurements were done at low, middle and high operational frequency range. RBW and VBW is 10MHz for LTE mode.
- b. Substitution method is used for E.I.R.P measurement. In the semi-anechoic chamber, EUT placed on the 0.8m height of Turn Table, rotated the table around 360 degrees to search the maximum radiation power and receiver antenna shall be rotated vertical and horizontal polarization and moved height from 1m to 4m to find the maximum polar radiated power. The “Read Value” is the spectrum reading the maximum power value.
- c. The substitution horn antenna is substituted for EUT at the same position and signals generator export the CW signal to the substitution antenna via a tx cable. Rotated the Turn Table and moved receiving antenna to find the maximum radiation power. Adjust output power level of S.G to get a Value of spectrum reading equal to “Read Value” of step b. Record the power level of S.G
- d. $EIRP = \text{Output power level of S.G} - \text{TX cable loss} + \text{Antenna gain of substitution horn}.$

CONDUCTED POWER MEASUREMENT:

- a. The EUT was set up for the maximum power with LTE link data modulation and link up with simulator.
- b. Set the EUT to transmit under low, middle and high channel and record the power level shown on simulator.

4.1.3 TEST SETUP

EIRP / ERP MEASUREMENT:

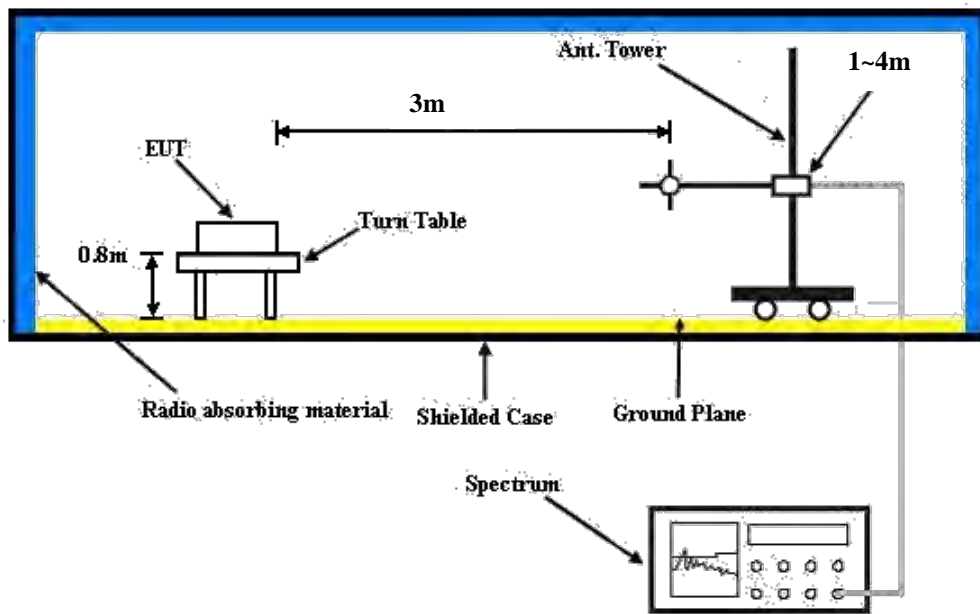

CONDUCTED POWER MEASUREMENT:





4.1.4 TEST RESULTS

Average Conducted Output Power (dBm)

Band / BW	RB Size	RB Offset	QPSK			3GPP MPR (dB)	16QAM			3GPP MPR (dB)
			Low CH 19957	Mid CH 20175	High CH 20393		Low CH 19957	Mid CH 20175	High CH 20393	
			1710.7 MHz	1732.5 MHz	1754.3 MHz		1710.7 MHz	1732.5 MHz	1754.3 MHz	
4 / 1.4M	1	0	22.81	22.93	22.87	0	21.78	21.90	21.84	1
	1	2	22.75	22.87	22.81	0	21.72	21.84	21.78	1
	1	5	22.65	22.77	22.71	0	21.62	21.74	21.68	1
	3	0	21.98	22.10	22.04	0	20.95	21.07	21.01	1
	3	1	21.95	22.07	22.01	0	20.92	21.04	20.98	1
	3	3	21.96	22.08	22.02	0	20.93	21.05	20.99	1
	6	0	21.92	22.04	21.98	1	20.89	21.01	20.95	2

Band / BW	RB Size	RB Offset	QPSK			3GPP MPR (dB)	16QAM			3GPP MPR (dB)
			Low CH 19965	Mid CH 20175	High CH 20385		Low CH 19965	Mid CH 20175	High CH 20385	
			1711.5 MHz	1732.5 MHz	1753.5 MHz		1711.5 MHz	1732.5 MHz	1753.5 MHz	
4 / 3M	1	0	22.88	23.00	22.94	0	21.85	21.97	21.91	1
	1	7	22.82	22.94	22.88	0	21.79	21.91	21.85	1
	1	14	22.72	22.84	22.78	0	21.69	21.81	21.75	1
	8	0	22.05	22.17	22.11	1	21.02	21.14	21.08	2
	8	3	22.02	22.14	22.08	1	20.99	21.11	21.05	2
	8	7	22.03	22.15	22.09	1	21.00	21.12	21.06	2
	15	0	21.99	22.11	22.05	1	20.96	21.08	21.02	2

Band / BW	RB Size	RB Offset	QPSK			3GPP MPR (dB)	16QAM			3GPP MPR (dB)
			Low CH 19975	Mid CH 20175	High CH 20375		Low CH 19975	Mid CH 20175	High CH 20375	
			1712.5 MHz	1732.5 MHz	1752.5 MHz		1712.5 MHz	1732.5 MHz	1752.5 MHz	
4 / 5M	1	0	22.94	23.06	23.00	0	21.91	22.03	21.97	1
	1	12	22.88	23.00	22.94	0	21.85	21.97	21.91	1
	1	24	22.78	22.90	22.84	0	21.75	21.87	21.81	1
	12	0	22.11	22.23	22.17	1	21.08	21.20	21.14	2
	12	6	22.08	22.20	22.14	1	21.05	21.17	21.11	2
	12	13	22.09	22.21	22.15	1	21.06	21.18	21.12	2
	25	0	22.05	22.17	22.11	1	21.02	21.14	21.08	2

Band / BW	RB Size	RB Offset	QPSK			3GPP MPR (dB)	16QAM			3GPP MPR (dB)
			Low CH 20000	Mid CH 20175	High CH 20350		Low CH 20000	Mid CH 20175	High CH 20350	
			1715.0 MHz	1732.5 MHz	1750.0 MHz		1715.0 MHz	1732.5 MHz	1750.0 MHz	
4 / 10M	1	0	23.01	23.13	23.07	0	21.98	22.10	22.04	1
	1	24	22.95	23.07	23.01	0	21.92	22.04	21.98	1
	1	49	22.85	22.97	22.91	0	21.82	21.94	21.88	1
	25	0	22.18	22.30	22.24	1	21.15	21.27	21.21	2
	25	12	22.15	22.27	22.21	1	21.12	21.24	21.18	2
	25	25	22.16	22.28	22.22	1	21.13	21.25	21.19	2
	50	0	22.12	22.24	22.18	1	21.09	21.21	21.15	2



A D T

Band / BW	RB Size	RB Offset	QPSK			3GPP MPR (dB)	16QAM			3GPP MPR (dB)
			Low CH 20025	Mid CH 20175	High CH 20325		Low CH 20025	Mid CH 20175	High CH 20325	
			1717.5 MHz	1732.5 MHz	1747.5 MHz		1717.5 MHz	1732.5 MHz	1747.5 MHz	
4 / 15M	1	0	23.09	23.21	23.15	0	22.06	22.18	22.12	1
	1	37	23.03	23.15	23.09	0	22.00	22.12	22.06	1
	1	74	22.93	23.05	22.99	0	21.90	22.02	21.96	1
	36	0	22.26	22.38	22.32	1	21.23	21.35	21.29	2
	36	19	22.23	22.35	22.29	1	21.20	21.32	21.26	2
	36	39	22.24	22.36	22.30	1	21.21	21.33	21.27	2
	75	0	22.20	22.32	22.26	1	21.17	21.29	21.23	2

Band / BW	RB Size	RB Offset	QPSK			3GPP MPR (dB)	16QAM			3GPP MPR (dB)
			Low CH 20050	Mid CH 20175	High CH 20300		Low CH 20050	Mid CH 20175	High CH 20300	
			1720.0 MHz	1732.5 MHz	1745.0 MHz		1720.0 MHz	1732.5 MHz	1745.0 MHz	
4 / 20M	1	0	23.15	23.27	23.21	0	22.12	22.24	22.18	1
	1	50	23.09	23.21	23.15	0	22.06	22.18	22.12	1
	1	99	22.99	23.11	23.05	0	21.96	22.08	22.02	1
	50	0	22.32	22.44	22.38	1	21.29	21.41	21.35	2
	50	25	22.29	22.41	22.35	1	21.26	21.38	21.32	2
	50	50	22.30	22.42	22.36	1	21.27	21.39	21.33	2
	100	0	22.26	22.38	22.32	1	21.23	21.35	21.29	2

Band / BW	RB Size	RB Offset	QPSK			3GPP MPR (dB)	16QAM			3GPP MPR (dB)
			Low CH 23017	Mid CH 23095	High CH 23173		Low CH 23017	Mid CH 23095	High CH 23173	
			699.7 MHz	707.5 MHz	715.3 MHz		699.7 MHz	707.5 MHz	715.3 MHz	
12 / 1.4M	1	0	22.60	22.67	22.62	0	21.59	21.66	21.61	1
	1	2	22.58	22.65	22.60	0	21.57	21.64	21.59	1
	1	5	22.61	22.68	22.63	0	21.60	21.67	21.62	1
	3	0	21.68	21.75	21.70	0	20.67	20.74	20.69	1
	3	1	21.62	21.69	21.64	0	20.61	20.68	20.63	1
	3	3	21.59	21.66	21.61	0	20.58	20.65	20.60	1
	6	0	21.74	21.81	21.76	1	20.73	20.80	20.75	2

Band / BW	RB Size	RB Offset	QPSK			3GPP MPR (dB)	16QAM			3GPP MPR (dB)
			Low CH 23025	Mid CH 23095	High CH 23165		Low CH 23025	Mid CH 23095	High CH 23165	
			700.5 MHz	707.5 MHz	714.5 MHz		700.5 MHz	707.5 MHz	714.5 MHz	
12 / 3M	1	0	22.67	22.74	22.69	0	21.66	21.73	21.68	1
	1	7	22.65	22.72	22.67	0	21.64	21.71	21.66	1
	1	14	22.68	22.75	22.70	0	21.67	21.74	21.69	1
	8	0	21.75	21.82	21.77	1	20.74	20.81	20.76	2
	8	3	21.69	21.76	21.71	1	20.68	20.75	20.70	2
	8	7	21.66	21.73	21.68	1	20.65	20.72	20.67	2
	15	0	21.81	21.88	21.83	1	20.80	20.87	20.82	2



A D T

Band / BW	RB Size	RB Offset	QPSK			3GPP MPR (dB)	16QAM			3GPP MPR (dB)
			Low CH 23035	Mid CH 23095	High CH 23155		Low CH 23035	Mid CH 23095	High CH 23155	
			701.5 MHz	707.5 MHz	713.5 MHz		701.5 MHz	707.5 MHz	713.5 MHz	
12 / 5M	1	0	22.73	22.80	22.75	0	21.72	21.79	21.74	1
	1	12	22.71	22.78	22.73	0	21.70	21.77	21.72	1
	1	24	22.74	22.81	22.76	0	21.73	21.80	21.75	1
	12	0	21.81	21.88	21.83	1	20.80	20.87	20.82	2
	12	6	21.75	21.82	21.77	1	20.74	20.81	20.76	2
	12	13	21.72	21.79	21.74	1	20.71	20.78	20.73	2
	25	0	21.87	21.94	21.89	1	20.86	20.93	20.88	2

Band / BW	RB Size	RB Offset	QPSK			3GPP MPR (dB)	16QAM			3GPP MPR (dB)
			Low CH 23060	Mid CH 23095	High CH 23130		Low CH 23060	Mid CH 23095	High CH 23130	
			704.0 MHz	707.5 MHz	711.0 MHz		704.0 MHz	707.5 MHz	711.0 MHz	
12 / 10M	1	0	22.78	22.85	22.80	0	21.77	21.84	21.79	1
	1	24	22.76	22.83	22.78	0	21.75	21.82	21.77	1
	1	49	22.79	22.86	22.81	0	21.78	21.85	21.80	1
	25	0	21.86	21.93	21.88	1	20.85	20.92	20.87	2
	25	12	21.80	21.87	21.82	1	20.79	20.86	20.81	2
	25	25	21.77	21.84	21.79	1	20.76	20.83	20.78	2
	50	0	21.92	21.99	21.94	1	20.91	20.98	20.93	2

Band / BW	RB Size	RB Offset	QPSK			3GPP MPR (dB)	16QAM			3GPP MPR (dB)
			Low CH 23755	Mid CH 23790	High CH 23825		Low CH 23755	Mid CH 23790	High CH 23825	
			706.5 MHz	710.0 MHz	713.5 MHz		706.5 MHz	710.0 MHz	713.5 MHz	
17 / 5M	1	0	22.91	22.97	22.95	0	21.89	21.95	21.93	1
	1	12	22.74	22.80	22.78	0	21.72	21.78	21.76	1
	1	24	22.86	22.92	22.90	0	21.84	21.90	21.88	1
	12	0	22.08	22.14	22.12	1	21.06	21.12	21.10	2
	12	6	21.92	21.98	21.96	1	20.90	20.96	20.94	2
	12	13	21.72	21.78	21.76	1	20.70	20.76	20.74	2
	25	0	21.99	22.05	22.03	1	20.97	21.03	21.01	2

Band / BW	RB Size	RB Offset	QPSK			3GPP MPR (dB)	16QAM			3GPP MPR (dB)
			Low CH 23780	Mid CH 23790	High CH 23800		Low CH 23780	Mid CH 23790	High CH 23800	
			709.0 MHz	710.0 MHz	711.0 MHz		709.0 MHz	710.0 MHz	711.0 MHz	
17 / 10M	1	0	22.97	23.03	23.01	0	21.95	22.01	21.99	1
	1	24	22.80	22.86	22.84	0	21.78	21.84	21.82	1
	1	49	22.92	22.98	22.96	0	21.90	21.96	21.94	1
	25	0	22.14	22.20	22.18	1	21.12	21.18	21.16	2
	25	12	21.98	22.04	22.02	1	20.96	21.02	21.00	2
	25	25	21.78	21.84	21.82	1	20.76	20.82	20.80	2
	50	0	22.05	22.11	22.09	1	21.03	21.09	21.07	2



A D T

AVERAGE ERP (dBm)

LTE Band 12							
Channel Bandwidth: 1.4MHz / QPSK							
Plane	Channel	Frequency (MHz)	LVL (dBm)	Correction Factor(dB)	ERP(dBm)	ERP(mW)	Polarization (H/V)
Y	23017	699.7	-10.01	32.719	20.56	113.74	H
	23095	707.5	-9.72	32.736	20.87	122.07	
	23173	715.3	-10.40	32.591	20.04	100.95	
	23017	699.7	-16.20	32.69	14.34	27.16	V
	23095	707.5	-16.40	32.81	14.26	26.67	
	23173	715.3	-15.89	32.74	14.70	29.51	

LTE Band 12							
Channel Bandwidth: 1.4MHz / 16QAM							
Plane	Channel	Frequency (MHz)	LVL (dBm)	Correction Factor(dB)	ERP(dBm)	ERP(mW)	Polarization (H/V)
Y	23017	699.7	-10.88	32.719	19.69	93.09	H
	23095	707.5	-10.69	32.736	19.90	97.63	
	23173	715.3	-11.06	32.591	19.38	86.72	
	23017	699.7	-17.14	32.69	13.40	21.88	V
	23095	707.5	-17.41	32.81	13.25	21.13	
	23173	715.3	-16.68	32.74	13.91	24.60	

LTE Band 12							
Channel Bandwidth: 3MHz / QPSK							
Plane	Channel	Frequency (MHz)	LVL (dBm)	Correction Factor(dB)	ERP(dBm)	ERP(mW)	Polarization (H/V)
Y	23025	700.5	-9.90	32.719	20.67	116.65	H
	23095	707.5	-9.85	32.736	20.74	118.47	
	23165	714.5	-10.29	32.591	20.15	103.54	
	23025	700.5	-16.07	32.69	14.47	27.99	V
	23095	707.5	-16.63	32.81	14.03	25.29	
	23165	714.5	-15.96	32.74	14.63	29.04	



LTE Band 12							
Channel Bandwidth: 3MHz / 16QAM							
Plane	Channel	Frequency (MHz)	LVL (dBm)	Correction Factor(dB)	ERP(dBm)	ERP(mW)	Polarization (H/V)
Y	23025	700.5	-10.84	32.719	19.73	93.95	H
	23095	707.5	-11.06	32.736	19.53	89.66	
	23165	714.5	-10.77	32.591	19.67	92.70	
	23025	700.5	-17.02	32.69	13.52	22.49	V
	23095	707.5	-16.77	32.81	13.89	24.49	
	23165	714.5	-17.41	32.74	13.18	20.80	

LTE Band 12							
Channel Bandwidth: 5MHz / QPSK							
Plane	Channel	Frequency (MHz)	LVL (dBm)	Correction Factor(dB)	ERP(dBm)	ERP(mW)	Polarization (H/V)
Y	23035	701.5	-9.84	32.719	20.73	118.28	H
	23095	707.5	-9.83	32.736	20.76	119.01	
	23155	713.5	-10.31	32.591	20.13	103.06	
	23035	701.5	-16.07	32.69	14.47	27.99	V
	23095	707.5	-16.41	32.81	14.25	26.61	
	23155	713.5	-15.86	32.74	14.73	29.72	

LTE Band 12							
Channel Bandwidth: 5MHz / 16QAM							
Plane	Channel	Frequency (MHz)	LVL (dBm)	Correction Factor(dB)	ERP(dBm)	ERP(mW)	Polarization (H/V)
Y	23035	701.5	-11.01	32.719	19.56	90.34	H
	23095	707.5	-10.80	32.736	19.79	95.19	
	23155	713.5	-11.16	32.591	19.28	84.74	
	23035	701.5	-16.95	32.69	13.59	22.86	V
	23095	707.5	-17.59	32.81	13.07	20.28	
	23155	713.5	-16.86	32.74	13.73	23.60	



A D T

LTE Band 12							
Channel Bandwidth: 10MHz / QPSK							
Plane	Channel	Frequency (MHz)	LVL (dBm)	Correction Factor(dB)	ERP(dBm)	ERP(mW)	Polarization (H/V)
Y	23060	704.0	-9.70	32.727	20.88	122.38	H
	23095	707.5	-9.78	32.739	20.81	120.48	
	23130	711.0	-9.90	32.728	20.68	116.90	
	23060	704.0	-16.29	32.75	14.31	26.98	V
	23095	707.5	-16.57	32.81	14.09	25.64	
	23130	711.0	-16.19	32.84	14.50	28.18	

LTE Band 12							
Channel Bandwidth: 10MHz / 16QAM							
Plane	Channel	Frequency (MHz)	LVL (dBm)	Correction Factor(dB)	ERP(dBm)	ERP(mW)	Polarization (H/V)
Y	23060	704.0	-11.56	32.727	19.02	79.74	H
	23095	707.5	-10.74	32.739	19.85	96.58	
	23130	711.0	-10.64	32.728	19.94	98.58	
	23060	704.0	-16.92	32.75	13.68	23.33	V
	23095	707.5	-17.63	32.81	13.03	20.09	
	23130	711.0	-17.00	32.84	13.69	23.39	

LTE Band 17							
Channel Bandwidth: 5MHz / QPSK							
Plane	Channel	Frequency (MHz)	LVL (dBm)	Correction Factor(dB)	ERP(dBm)	ERP(mW)	Polarization (H/V)
Y	23755	706.5	-9.82	32.719	20.75	118.82	H
	23790	710.0	-10.57	32.736	20.02	100.37	
	23825	713.5	-9.98	32.591	20.46	111.20	
	23755	706.5	-16.57	32.69	13.97	24.95	V
	23790	710.0	-16.51	32.81	14.15	26.00	
	23825	713.5	-16.68	32.74	13.91	24.60	



A D T

LTE Band 17							
Channel Bandwidth: 5MHz / 16QAM							
Plane	Channel	Frequency (MHz)	LVL (dBm)	Correction Factor(dB)	ERP(dBm)	ERP(mW)	Polarization (H/V)
Y	23755	706.5	-10.67	32.719	19.90	97.70	H
	23790	710.0	-11.44	32.736	19.15	82.15	
	23825	713.5	-10.94	32.591	19.50	89.15	
	23755	706.5	-17.45	32.69	13.09	20.37	V
	23790	710.0	-17.49	32.81	13.17	20.75	
	23825	713.5	-17.39	32.74	13.20	20.89	

LTE Band 17							
Channel Bandwidth: 10MHz / QPSK							
Plane	Channel	Frequency (MHz)	LVL (dBm)	Correction Factor(dB)	ERP(dBm)	ERP(mW)	Polarization (H/V)
Y	23780	709.0	-9.73	32.727	20.85	121.53	H
	23790	710.0	-10.52	32.739	20.07	101.60	
	23800	711.0	-10.57	32.728	20.01	100.18	
	23780	709.0	-16.67	32.75	13.93	24.72	V
	23790	710.0	-16.60	32.81	14.06	25.47	
	23800	711.0	-16.79	32.84	13.90	24.55	

LTE Band 17							
Channel Bandwidth: 10MHz / 16QAM							
Plane	Channel	Frequency (MHz)	LVL (dBm)	Correction Factor(dB)	ERP(dBm)	ERP(mW)	Polarization (H/V)
Y	23780	709.0	-11.58	32.727	19.00	79.38	H
	23790	710.0	-11.43	32.739	19.16	82.39	
	23800	711.0	-11.44	32.728	19.14	82.00	
	23780	709.0	-17.54	32.75	13.06	20.23	V
	23790	710.0	-17.39	32.81	13.27	21.23	
	23800	711.0	-17.50	32.84	13.19	20.84	



A D T

AVERAGE EIRP (dBm)

LTE Band 4							
Channel Bandwidth: 1.4MHz / QPSK							
Plane	Channel	Frequency (MHz)	LVL (dBm)	Correction Factor(dB)	EIRP(dBm)	EIRP(mW)	Polarization (H/V)
X	19957	1710.7	-19.07	42.49	23.42	219.53	H
	20175	1732.5	-18.61	42.33	23.72	235.34	
	20393	1754.3	-19.03	42.10	23.07	202.77	
	19957	1710.7	-21.10	42.99	21.89	154.53	V
	20175	1732.5	-21.53	42.74	21.21	132.13	
	20393	1754.3	-20.79	42.21	21.42	138.68	

LTE Band 4							
Channel Bandwidth: 1.4MHz / 16QAM							
Plane	Channel	Frequency (MHz)	LVL (dBm)	Correction Factor(dB)	EIRP(dBm)	EIRP(mW)	Polarization (H/V)
X	19957	1710.7	-20.08	42.49	22.41	173.98	H
	20175	1732.5	-20.32	42.33	22.01	158.74	
	20393	1754.3	-19.18	42.10	22.92	195.88	
	19957	1710.7	-22.20	42.99	20.79	119.95	V
	20175	1732.5	-22.41	42.74	20.33	107.89	
	20393	1754.3	-21.98	42.21	20.23	105.44	

LTE Band 4							
Channel Bandwidth: 3MHz / QPSK							
Plane	Channel	Frequency (MHz)	LVL (dBm)	Correction Factor(dB)	EIRP(dBm)	EIRP(mW)	Polarization (H/V)
X	19965	1711.5	-19.24	42.49	23.25	211.11	H
	20175	1732.5	-18.62	42.33	23.71	234.80	
	20385	1753.5	-18.91	42.10	23.19	208.45	
	19965	1711.5	-21.18	42.99	21.81	151.71	V
	20175	1732.5	-21.55	42.74	21.19	131.52	
	20385	1753.5	-20.93	42.21	21.28	134.28	



A D T

LTE Band 4							
Channel Bandwidth: 3MHz / 16QAM							
Plane	Channel	Frequency (MHz)	LVL (dBm)	Correction Factor(dB)	EIRP(dBm)	EIRP(mW)	Polarization (H/V)
X	19965	1711.5	-20.37	42.49	22.12	162.74	H
	20175	1732.5	-19.50	42.33	22.83	191.73	
	20385	1753.5	-19.24	42.10	22.86	193.20	
	19965	1711.5	-22.21	42.99	20.78	119.67	V
	20175	1732.5	-22.62	42.74	20.12	102.80	
	20385	1753.5	-22.02	42.21	20.19	104.47	

LTE Band 4							
Channel Bandwidth: 5MHz / QPSK							
Plane	Channel	Frequency (MHz)	LVL (dBm)	Correction Factor(dB)	EIRP(dBm)	EIRP(mW)	Polarization (H/V)
X	19975	1712.5	-19.15	42.49	23.34	215.53	H
	20175	1732.5	-18.60	42.33	23.73	235.88	
	20375	1752.5	-18.83	42.10	23.27	212.32	
	19975	1712.5	-21.04	42.99	21.95	156.68	V
	20175	1732.5	-21.51	42.74	21.23	132.74	
	20375	1752.5	-21.01	42.21	21.20	131.83	

LTE Band 4							
Channel Bandwidth: 5MHz / 16QAM							
Plane	Channel	Frequency (MHz)	LVL (dBm)	Correction Factor(dB)	EIRP(dBm)	EIRP(mW)	Polarization (H/V)
X	19975	1712.5	-20.38	42.49	22.11	162.37	H
	20175	1732.5	-19.50	42.33	22.83	191.73	
	20375	1752.5	-19.35	42.10	22.75	188.36	
	19975	1712.5	-22.21	42.99	20.78	119.67	V
	20175	1732.5	-22.50	42.74	20.24	105.68	
	20375	1752.5	-22.29	42.21	19.92	98.17	



A D T

LTE Band 4							
Channel Bandwidth: 10MHz / QPSK							
Plane	Channel	Frequency (MHz)	LVL (dBm)	Correction Factor(dB)	EIRP(dBm)	EIRP(mW)	Polarization (H/V)
X	20000	1715.0	-19.06	42.49	23.43	220.04	H
	20175	1732.5	-18.58	42.33	23.75	236.97	
	20350	1750.0	-18.69	42.10	23.41	219.28	
	20000	1715.0	-21.13	42.99	21.86	153.46	V
	20175	1732.5	-21.64	42.74	21.10	128.82	
	20350	1750.0	-20.56	42.21	21.65	146.22	

LTE Band 4							
Channel Bandwidth: 10MHz / 16QAM							
Plane	Channel	Frequency (MHz)	LVL (dBm)	Correction Factor(dB)	EIRP(dBm)	EIRP(mW)	Polarization (H/V)
X	20000	1715.0	-19.68	42.49	22.81	190.77	H
	20175	1732.5	-19.53	42.33	22.80	190.41	
	20350	1750.0	-19.78	42.10	22.32	170.61	
	20000	1715.0	-22.26	42.99	20.73	118.30	V
	20175	1732.5	-22.32	42.74	20.42	110.15	
	20350	1750.0	-21.58	42.21	20.63	115.61	

LTE Band 4							
Channel Bandwidth: 15MHz / QPSK							
Plane	Channel	Frequency (MHz)	LVL (dBm)	Correction Factor(dB)	EIRP(dBm)	EIRP(mW)	Polarization (H/V)
X	20025	1717.5	-19.14	42.49	23.35	216.02	H
	20175	1732.5	-18.65	42.33	23.68	233.18	
	20325	1747.5	-18.35	42.10	23.75	237.14	
	20025	1717.5	-21.36	42.99	21.63	145.55	V
	20175	1732.5	-20.85	42.74	21.89	154.53	
	20325	1747.5	-20.74	42.21	21.47	140.28	



A D T

LTE Band 4							
Channel Bandwidth: 15MHz / 16QAM							
Plane	Channel	Frequency (MHz)	LVL (dBm)	Correction Factor(dB)	EIRP(dBm)	EIRP(mW)	Polarization (H/V)
X	20025	1717.5	-20.20	42.49	22.29	169.24	H
	20175	1732.5	-19.44	42.33	22.89	194.40	
	20325	1747.5	-19.72	42.10	22.38	172.98	
	20025	1717.5	-22.45	42.99	20.54	113.24	V
	20175	1732.5	-22.70	42.74	20.04	100.93	
	20325	1747.5	-22.07	42.21	20.14	103.28	

LTE Band 4							
Channel Bandwidth: 20MHz / QPSK							
Plane	Channel	Frequency (MHz)	LVL (dBm)	Correction Factor(dB)	EIRP(dBm)	EIRP(mW)	Polarization (H/V)
X	20050	1720.0	-18.97	42.49	23.52	224.65	H
	20175	1732.5	-18.93	42.33	23.40	218.63	
	20300	1745.0	-18.15	42.10	23.95	248.31	
	20050	1720.0	-21.71	42.99	21.28	134.28	V
	20175	1732.5	-21.62	42.74	21.12	129.42	
	20300	1745.0	-20.42	42.21	21.79	151.01	

LTE Band 4							
Channel Bandwidth: 20MHz / 16QAM							
Plane	Channel	Frequency (MHz)	LVL (dBm)	Correction Factor(dB)	EIRP(dBm)	EIRP(mW)	Polarization (H/V)
X	20050	1720.0	-19.95	42.49	22.54	179.27	H
	20175	1732.5	-19.67	42.33	22.66	184.37	
	20300	1745.0	-19.35	42.10	22.75	188.36	
	20050	1720.0	-22.81	42.99	20.18	104.23	V
	20175	1732.5	-21.78	42.74	20.96	124.74	
	20300	1745.0	-21.81	42.21	20.40	109.65	

4.2 FREQUENCY STABILITY MEASUREMENT

4.2.1 LIMITS OF FREQUENCY STABILITY MEASUREMENT

The frequency stability shall be sufficient to ensure that the fundamental emissions stay within the authorized bands of operation.

4.2.2 TEST PROCEDURE

- a. Device is placed at the oven room. The oven room could control the temperatures and humidity. Power warm up is at least 15 min and power applied should perform before recording frequency error.
- b. EUT is connected the external power supply to control the DC input power. The test voltage range is from minimum to maximum working voltage. Each step shall be record the frequency error rate.
- c. The temperature range step is 10 degrees in this test items. All temperature levels shall be hold the $\pm 0.5^{\circ}\text{C}$ during the measurement testing. The each temperature step shall be at least 0.5 hours, consider the EUT could be test under the stability condition.

NOTE: The frequency error was recorded frequency error from the communication simulator.

4.2.3 TEST SETUP

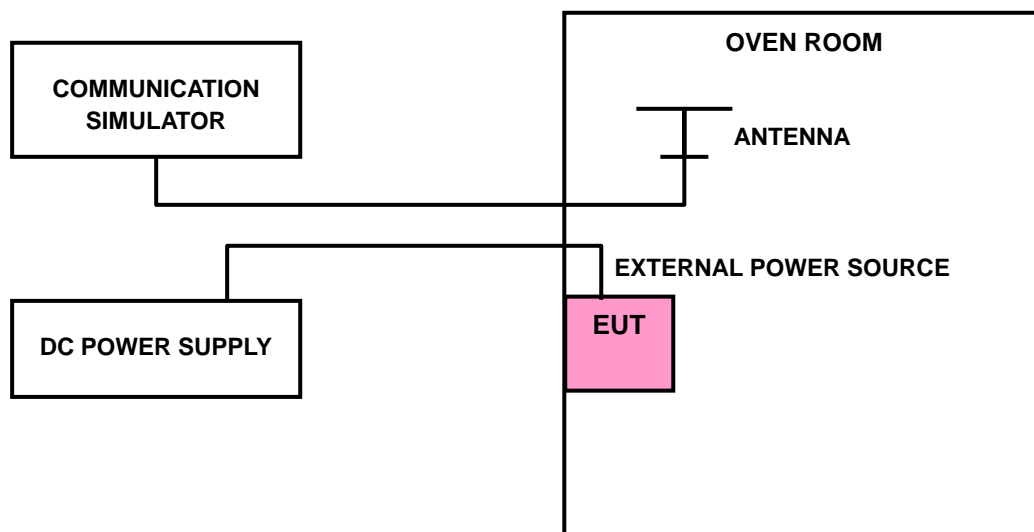



4.2.4 TEST RESULTS

FREQUENCY ERROR vs. VOLTAGE

VOLTAGE (Volts)	FREQUENCY ERROR (ppm)						LIMIT (ppm)
	LTE BAND 4						
	1.4MHz	3MHz	5MHz	10MHz	15MHz	20MHz	
3.55	-0.0002	0.0018	0.0002	0.0012	0.0007	0.0007	2.5
3.0	0.0012	0.0003	0.0012	0.0018	0.0018	0.0014	2.5
4.0	0.0007	0.0010	0.0018	0.0003	0.0023	0.0001	2.5

NOTE: The applicant defined the normal working voltage of the battery is from 3.0Vdc to 4.0Vdc.

FREQUENCY ERROR vs. TEMPERATURE

TEMP. (°C)	FREQUENCY ERROR (ppm)						LIMIT (ppm)
	LTE BAND 4						
	1.4MHz	3MHz	5MHz	10MHz	15MHz	20MHz	
-30	0.0014	0.0018	0.0021	0.0002	0.0022	0.0007	2.5
-20	0.0009	0.0008	0.0024	0.0018	0.0012	0.0018	2.5
-10	-0.0007	0.0003	0.0012	0.0007	0.0009	0.0002	2.5
0	-0.0018	-0.0018	0.0003	-0.0007	0.0001	-0.0007	2.5
10	0.0005	0.0013	-0.0018	-0.0018	-0.0012	-0.0012	2.5
20	0.0014	0.0008	-0.0014	0.0001	-0.0006	0.0007	2.5
30	0.0010	0.0003	0.0001	0.0007	0.0003	-0.0018	2.5
40	0.0002	0.0012	0.0012	0.0014	0.0016	-0.0009	2.5
50	0.0007	0.0009	0.0007	0.0002	0.0008	0.0003	2.5



A D T

FREQUENCY ERROR vs. VOLTAGE

VOLTAGE (Volts)	FREQUENCY ERROR (ppm)						LIMIT (ppm)
	LTE BAND 12				LTE BAND 17		
	1.4MHz	3MHz	5MHz	10MHz	5MHz	10MHz	
3.55	0.0045	0.0041	0.0010	0.0045	0.0011	0.0013	2.5
3.0	0.0023	0.0021	0.0020	0.0023	0.0054	0.0054	2.5
4.0	0.0004	0.0006	0.0045	0.0011	0.0050	0.0017	2.5

NOTE: The applicant defined the normal working voltage of the battery is from 3.0Vdc to 4.0Vdc.

FREQUENCY ERROR vs. TEMPERATURE

TEMP. (°C)	FREQUENCY ERROR (ppm)						LIMIT (ppm)
	LTE BAND 12				LTE BAND 17		
	1.4MHz	3MHz	5MHz	10MHz	5MHz	10MHz	
-30	0.0034	0.0057	0.0030	0.0034	0.0004	0.0050	2.5
-20	0.0023	0.0020	0.0045	0.0017	0.0012	0.0008	2.5
-10	0.0004	0.0037	0.0010	0.0007	0.0044	0.0039	2.5
0	-0.0042	0.0003	-0.0045	-0.0045	0.0014	0.0032	2.5
10	-0.0021	-0.0033	-0.0037	-0.0016	0.0026	0.0010	2.5
20	0.0035	-0.0023	0.0004	0.0034	-0.0038	-0.0054	2.5
30	0.0055	0.0004	0.0037	0.0030	-0.0025	-0.0039	2.5
40	0.0020	0.0044	0.0016	0.0007	-0.0055	-0.0010	2.5
50	0.0044	0.0035	0.0038	-0.0035	-0.0014	-0.0047	2.5

4.3 OCCUPIED BANDWIDTH MEASUREMENT

4.3.1 LIMITS OF OCCUPIED BANDWIDTH MEASUREMENT

The width of a frequency band such that, below the lower and above the upper frequency limits, the mean powers emitted are each equal to a specified percentage 0.5 %of the total mean power of a given emission.

4.3.2 TEST SETUP

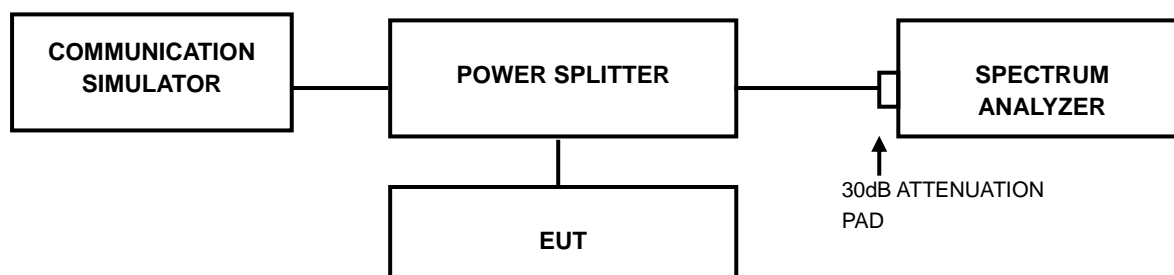

4.3.3 TEST PROCEDURES

- a. The conducted occupied bandwidth used the power splitter via EUT RF power connector between simulation base station and spectrum analyzer.
- b. Use OBW measurement function of Spectrum analyzer to measure 99 % occupied bandwidth.

4.3.4 TEST RESULTS

LTE BAND 4							
CHANNEL BANDWIDTH: 1.4MHz				CHANNEL BANDWIDTH: 3MHz			
CHANNEL	FREQUENCY (MHz)	99% OCCUPIED BANDWIDTH (MHz)		CHANNEL	FREQUENCY (MHz)	99% OCCUPIED BANDWIDTH (MHz)	
		QPSK	16QAM			QPSK	16QAM
19957	1710.7	1.0913	1.0907	19965	1711.5	2.6979	2.6963
20175	1732.5	1.0899	1.0880	20175	1732.5	2.6961	2.6951
20393	1754.3	1.0908	1.0905	20385	1753.5	2.6969	2.6962

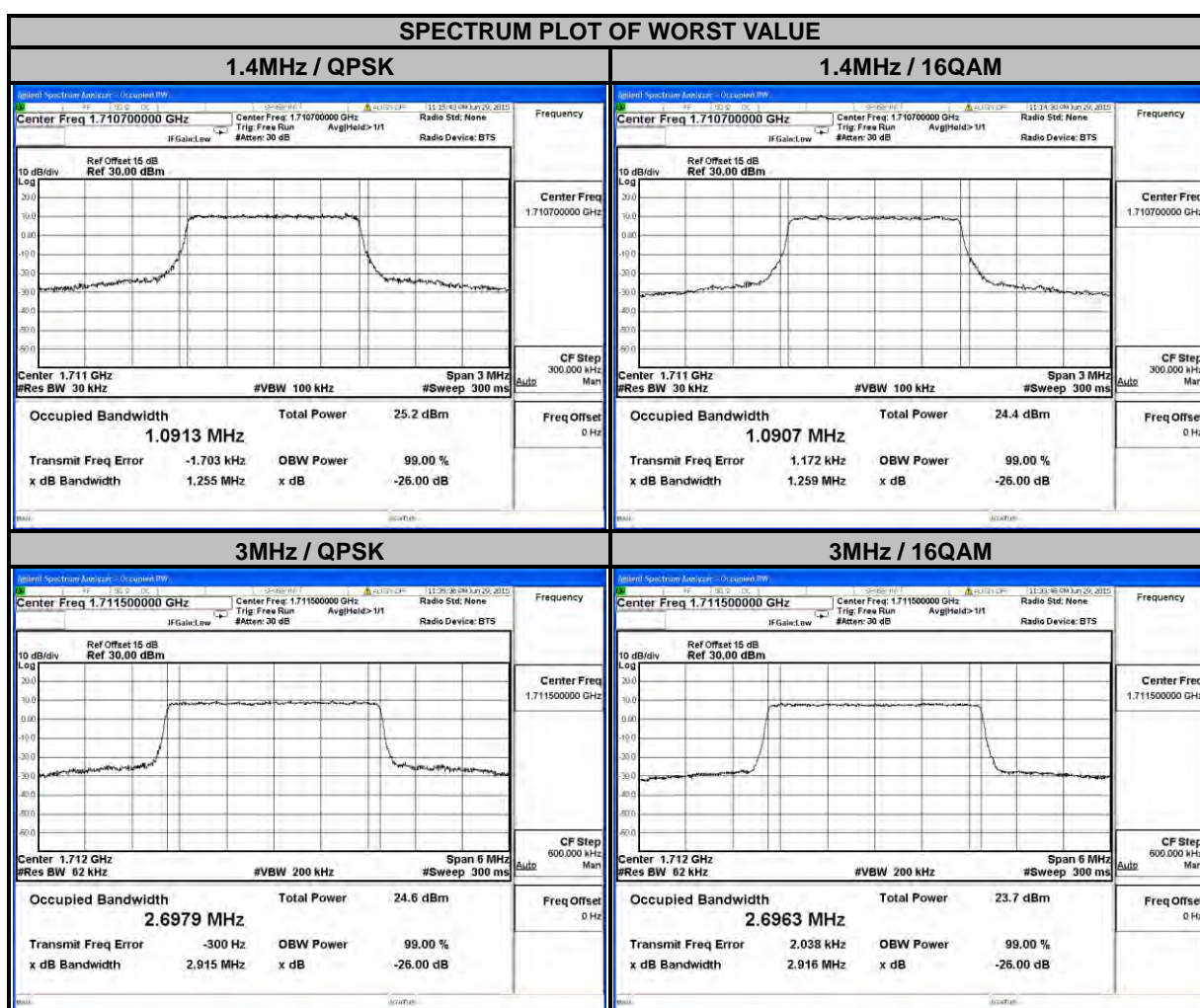



A D T

LTE BAND 4							
CHANNEL BANDWIDTH: 5MHz				CHANNEL BANDWIDTH: 10MHz			
CHANNEL	FREQUENCY (MHz)	99% OCCUPIED BANDWIDTH (MHz)		CHANNEL	FREQUENCY (MHz)	99% OCCUPIED BANDWIDTH (MHz)	
		QPSK	16QAM			QPSK	16QAM
19975	1712.5	4.4909	4.4891	20000	1715.0	8.9680	8.9645
20175	1732.5	4.4927	4.4872	20175	1732.5	8.9701	8.9716
20375	1752.5	4.4920	4.4874	20350	1750.0	8.9670	8.9655

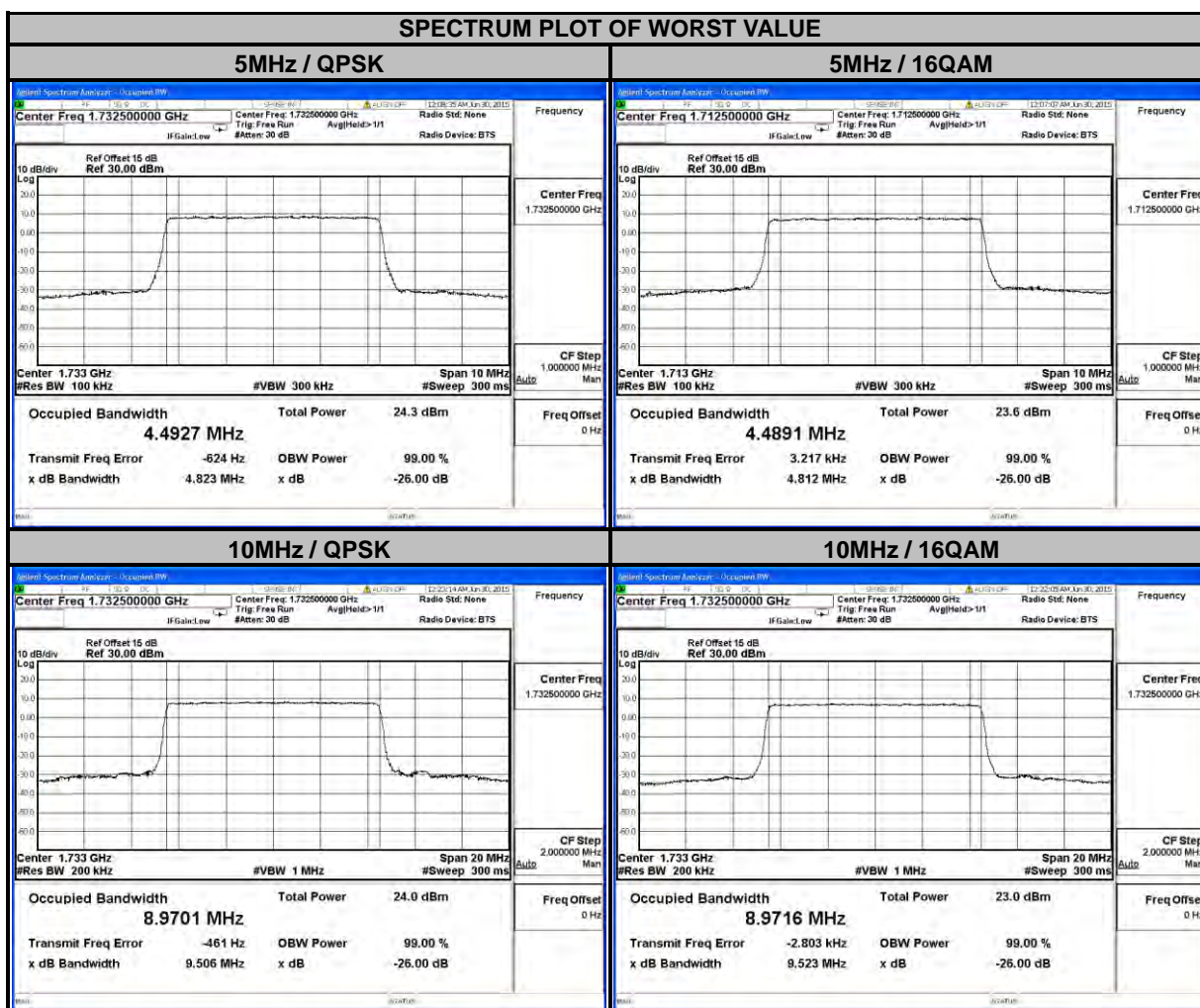



A D T

LTE BAND 4							
CHANNEL BANDWIDTH: 15MHz				CHANNEL BANDWIDTH: 20MHz			
CHANNEL	FREQUENCY (MHz)	99% OCCUPIED BANDWIDTH (MHz)		CHANNEL	FREQUENCY (MHz)	99% OCCUPIED BANDWIDTH (MHz)	
		QPSK	16QAM			QPSK	16QAM
20025	1717.5	13.440	13.428	20050	1720.0	17.887	17.910
20175	1732.5	13.437	13.435	20175	1732.5	17.891	17.907
20325	1747.5	13.444	13.434	20300	1745.0	17.900	17.922

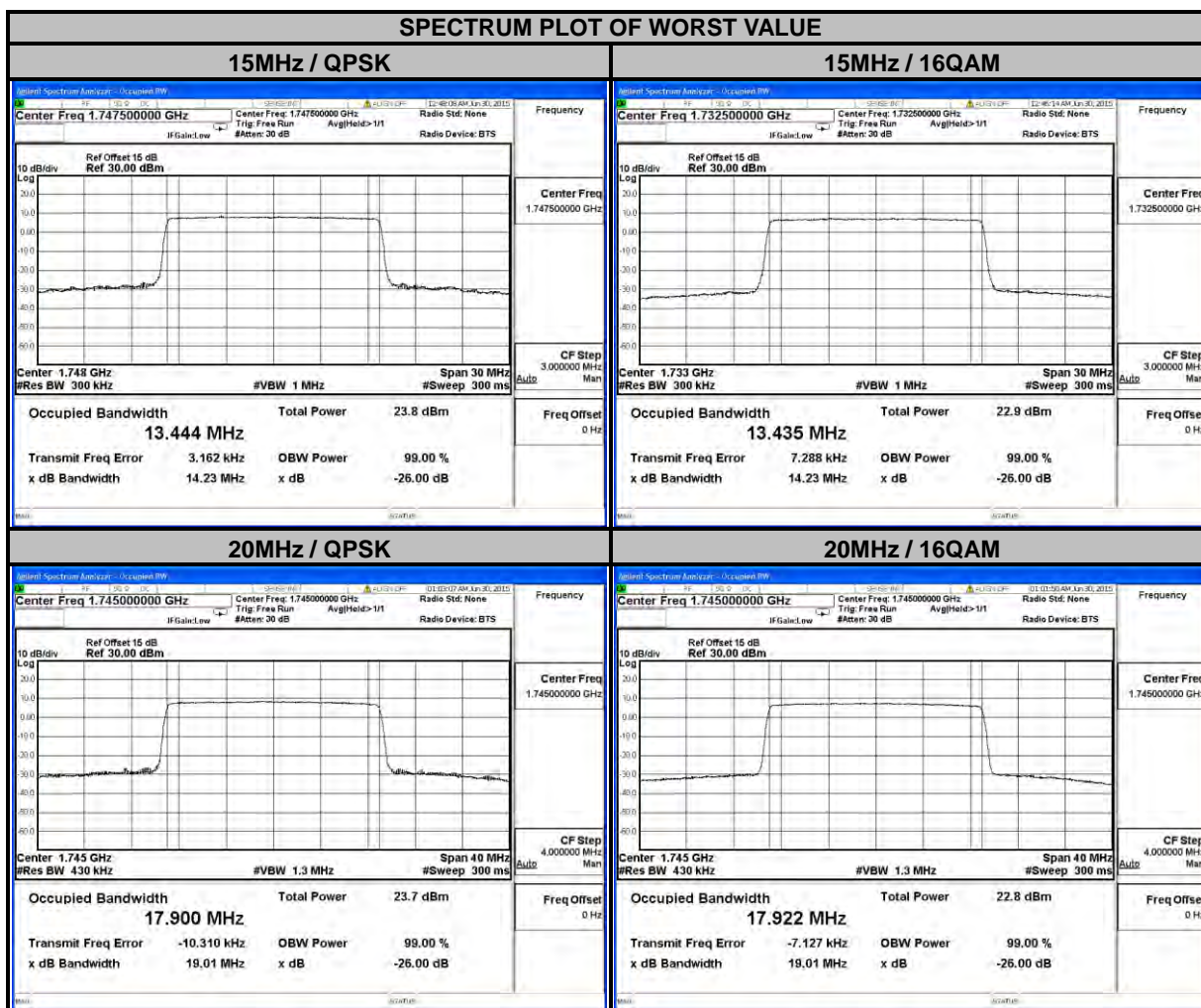



A D T

LTE BAND 12							
CHANNEL BANDWIDTH: 1.4MHz				CHANNEL BANDWIDTH: 3MHz			
CHANNEL	FREQUENCY (MHz)	99% OCCUPIED BANDWIDTH (MHz)		CHANNEL	FREQUENCY (MHz)	99% OCCUPIED BANDWIDTH (MHz)	
		QPSK	16QAM			QPSK	16QAM
23017	699.7	1.0917	1.0892	23025	700.5	2.6981	2.6972
23095	707.5	1.0888	1.0895	23095	707.5	2.6970	2.6967
23173	715.3	1.0910	1.0884	23165	714.5	2.7002	2.6993

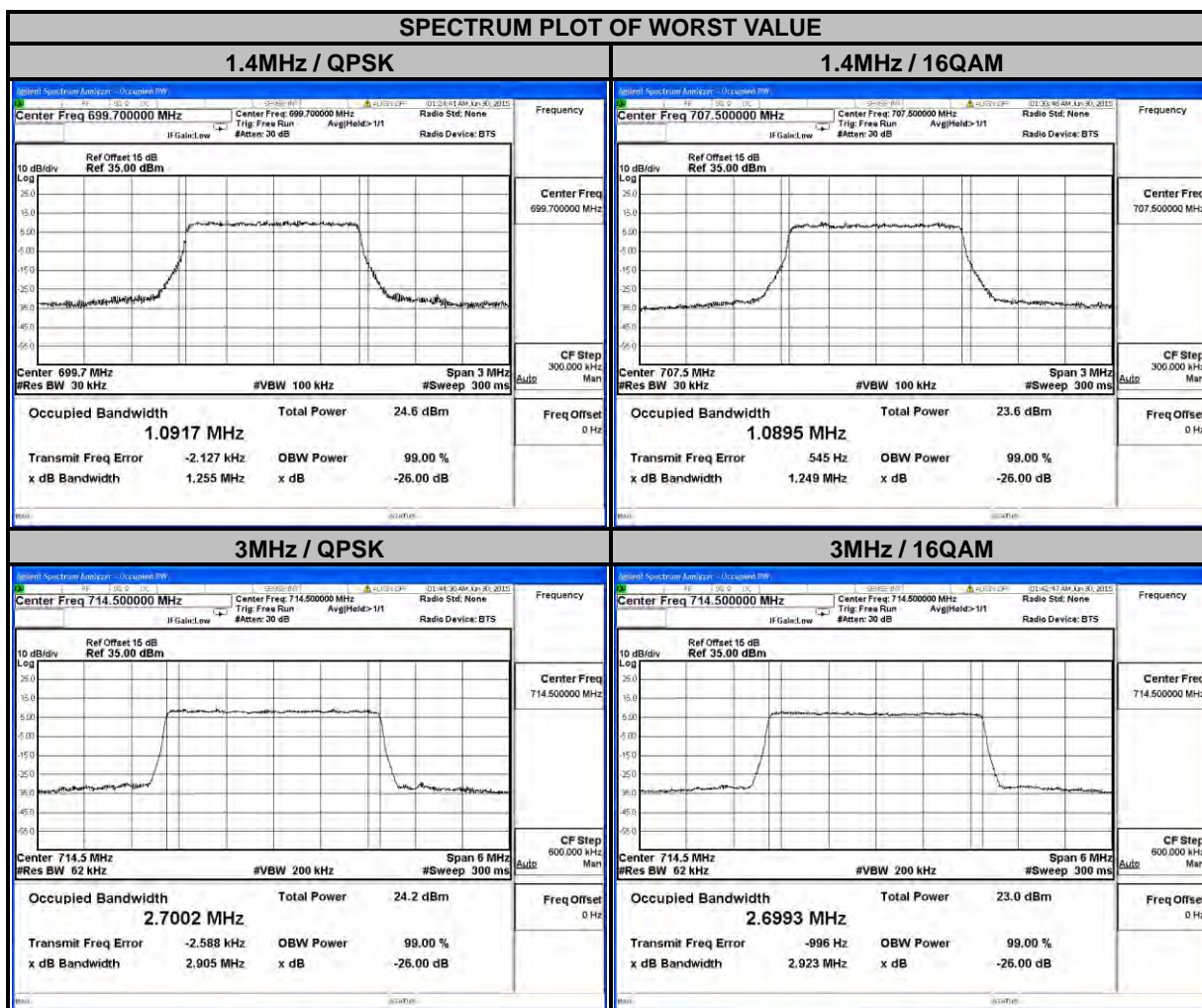



A D T

LTE BAND 12							
CHANNEL BANDWIDTH: 5MHz				CHANNEL BANDWIDTH: 10MHz			
CHANNEL	FREQUENCY (MHz)	99% OCCUPIED BANDWIDTH (MHz)		CHANNEL	FREQUENCY (MHz)	99% OCCUPIED BANDWIDTH (MHz)	
		QPSK	16QAM			QPSK	16QAM
23035	701.5	4.4941	4.4918	23060	704.0	8.9761	8.9812
23095	707.5	4.4965	4.4930	23095	707.5	8.9764	8.9765
23155	713.5	4.4964	4.4952	23130	711.0	8.9580	8.9578

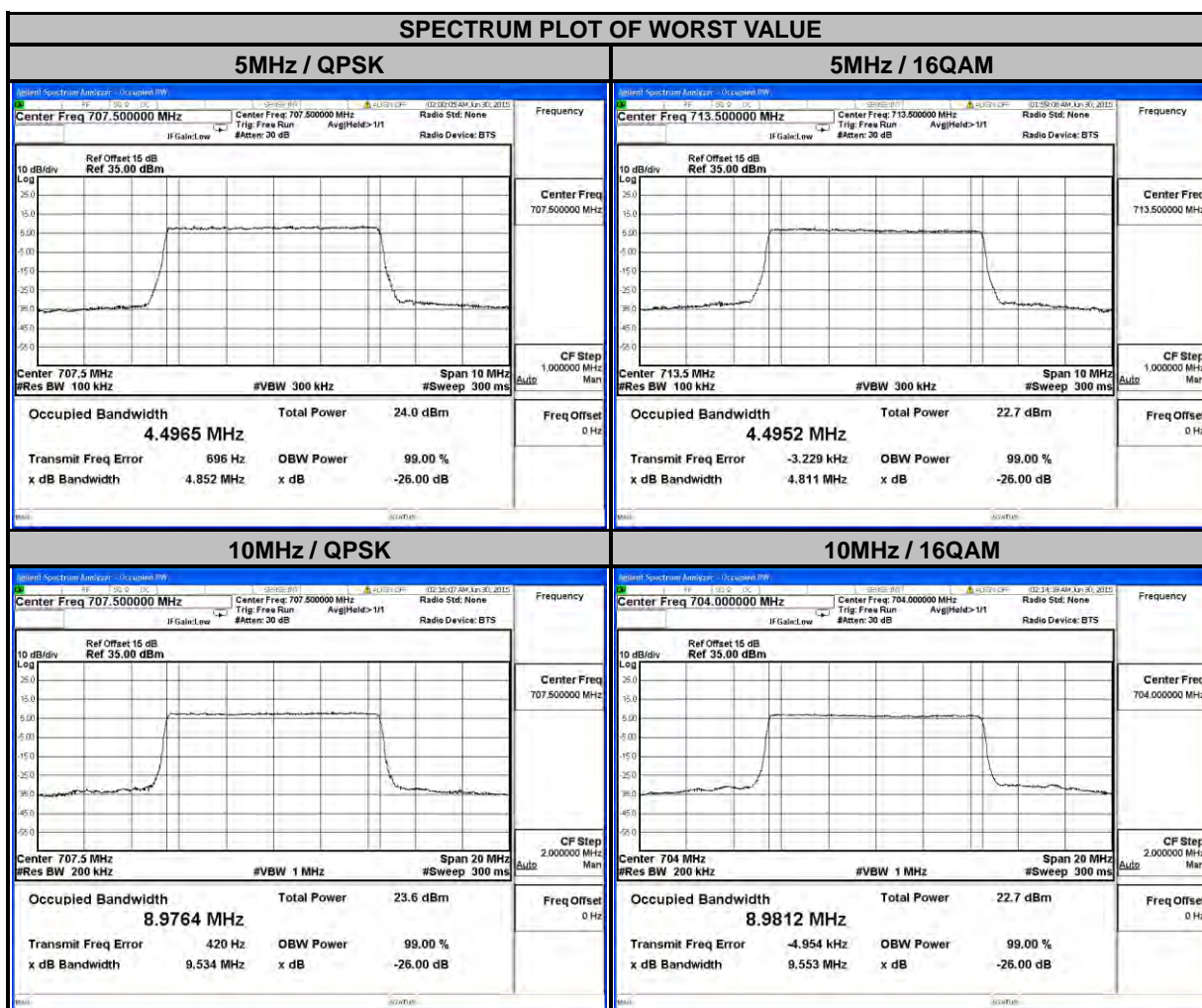



A D T

LTE BAND 17							
CHANNEL BANDWIDTH: 5MHz				CHANNEL BANDWIDTH: 10MHz			
CHANNEL	FREQUENCY (MHz)	99% OCCUPIED BANDWIDTH (MHz)		CHANNEL	FREQUENCY (MHz)	99% OCCUPIED BANDWIDTH (MHz)	
		QPSK	16QAM			QPSK	16QAM
23755	706.5	4.4981	4.4966	23780	709.0	8.9833	8.9869
23790	710.0	4.4999	4.4925	23790	710.0	8.9775	8.9651
23825	713.5	4.4951	4.4922	23800	711.0	8.9649	8.9600

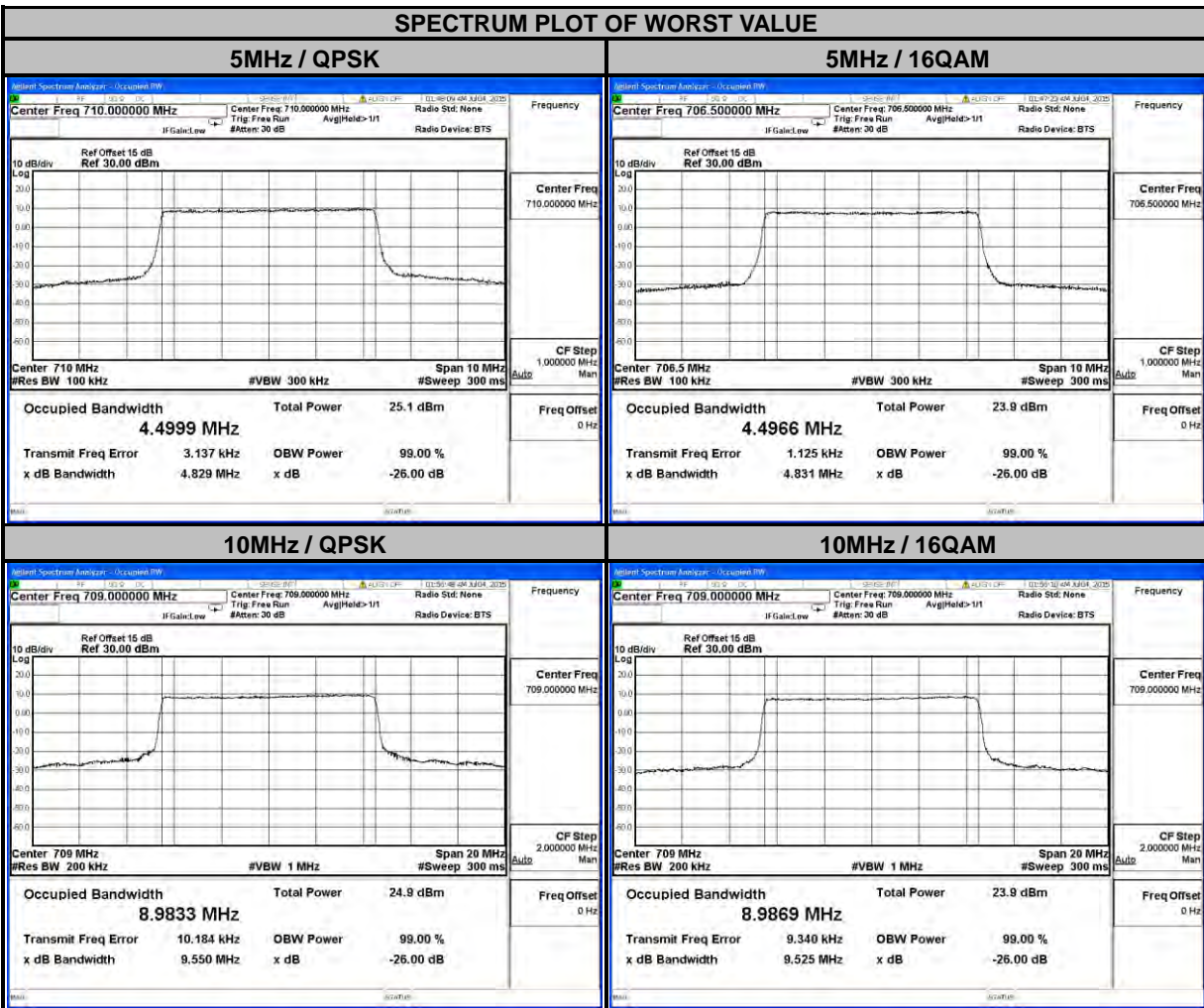

4.4 PEAK TO AVERAGE RATIO

4.4.1 LIMITS OF PEAK TO AVERAGE RATIO MEASUREMENT

In measuring transmissions in this band using an average power technique, the peak to-average ratio (PAR) of the transmission may not exceed 13 dB.

4.4.2 TEST SETUP

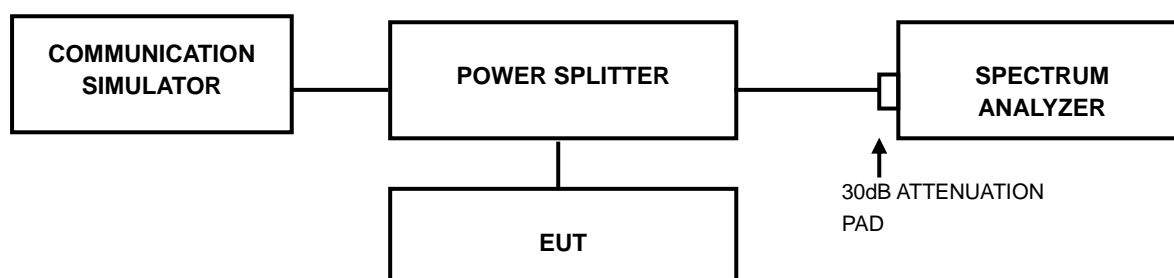

4.4.3 TEST PROCEDURES

1. Set resolution/measurement bandwidth \geq signal's occupied bandwidth;
2. Set the number of counts to a value that stabilizes the measured CCDF curve;
3. Record the maximum PAPR level associated with a probability of 0.1%.

4.4.4 TEST RESULTS

LTE BAND 4							
CHANNEL BANDWIDTH: 1.4MHz				CHANNEL BANDWIDTH: 3MHz			
CHANNEL	FREQUENCY (MHz)	PEAK TO AVERAGE RATIO (dB)		CHANNEL	FREQUENCY (MHz)	PEAK TO AVERAGE RATIO (dB)	
		QPSK	16QAM			QPSK	16QAM
19957	1710.7	3.69	4.83	19965	1711.5	3.51	4.81
20175	1732.5	4.34	5.50	20175	1732.5	4.23	5.53
20393	1754.3	3.74	4.92	20385	1753.5	3.61	4.90

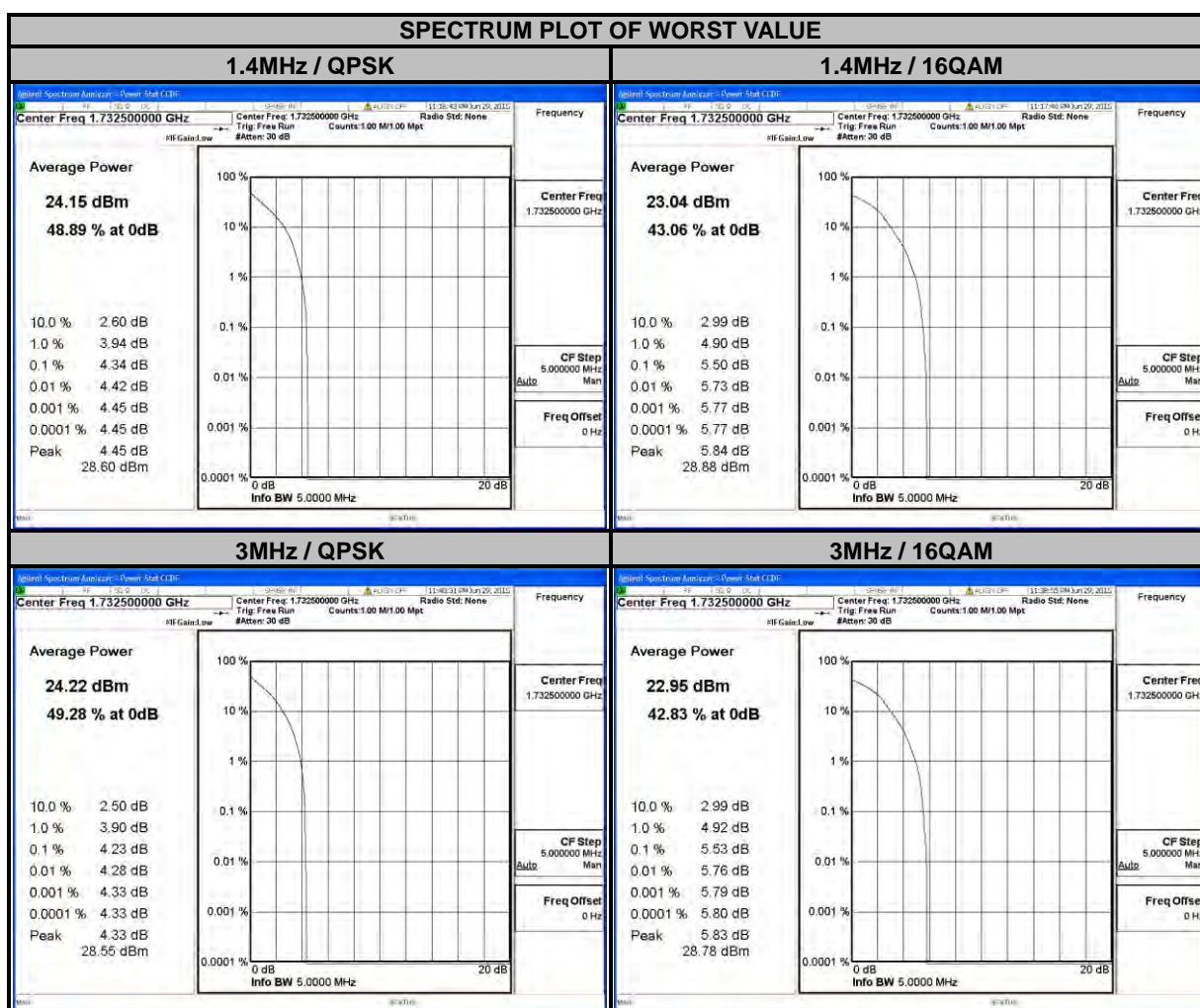



LTE BAND 4							
CHANNEL BANDWIDTH: 5MHz				CHANNEL BANDWIDTH: 10MHz			
CHANNEL	FREQUENCY (MHz)	PEAK TO AVERAGE RATIO (dB)		CHANNEL	FREQUENCY (MHz)	PEAK TO AVERAGE RATIO (dB)	
		QPSK	16QAM			QPSK	16QAM
19975	1712.5	4.63	5.41	20000	1715.0	3.66	4.85
20175	1732.5	5.11	5.92	20175	1732.5	4.12	5.34
20375	1752.5	4.78	5.61	20350	1750.0	3.82	5.12

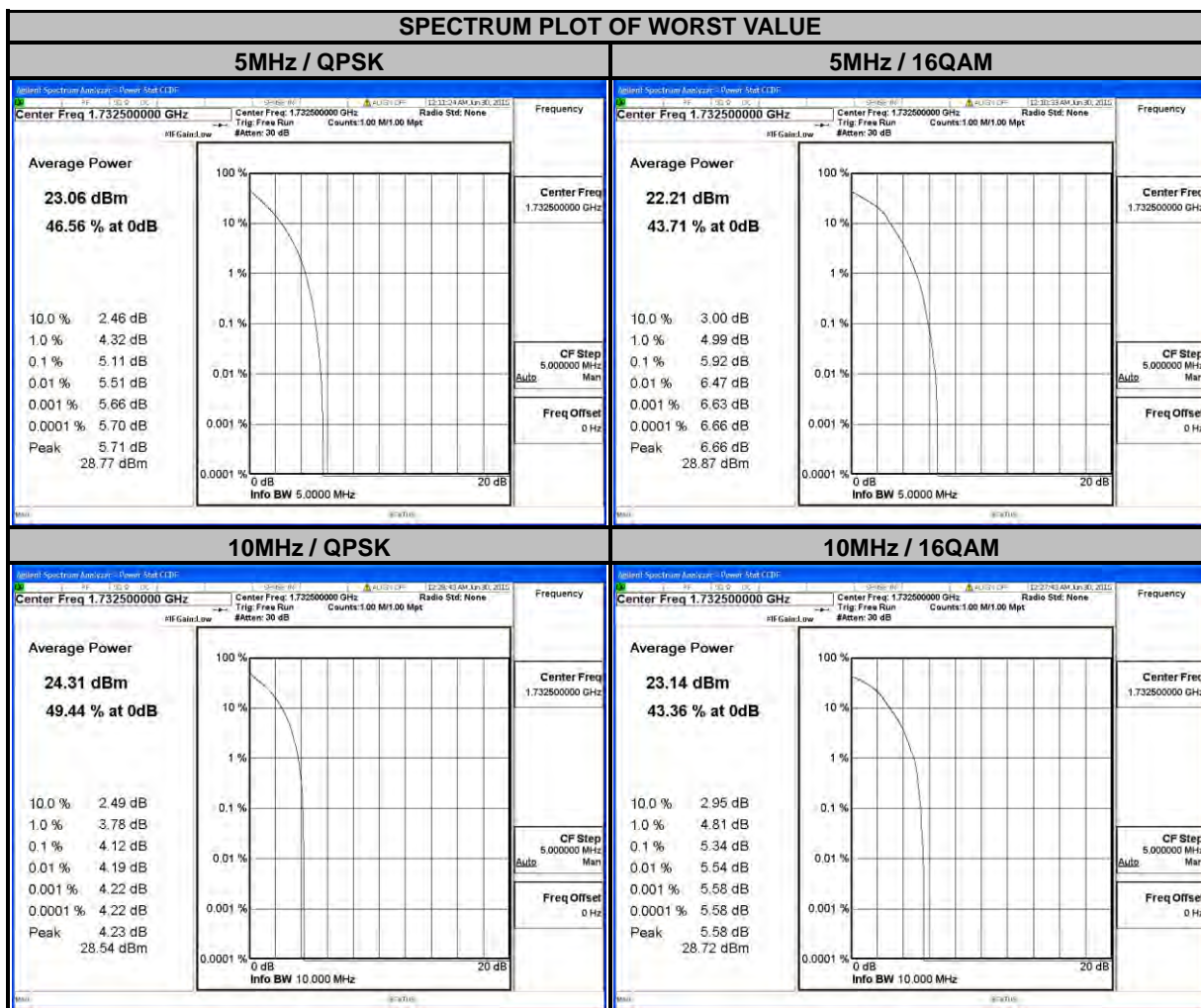



A D T

LTE BAND 4							
CHANNEL BANDWIDTH: 15MHz				CHANNEL BANDWIDTH: 20MHz			
CHANNEL	FREQUENCY (MHz)	PEAK TO AVERAGE RATIO (dB)		CHANNEL	FREQUENCY (MHz)	PEAK TO AVERAGE RATIO (dB)	
		QPSK	16QAM			QPSK	16QAM
20025	1717.5	4.38	5.24	20050	1720	4.39	5.31
20175	1732.5	4.90	5.69	20175	1732.5	4.77	5.68
20325	1747.5	4.69	5.59	20300	1745	4.79	5.63

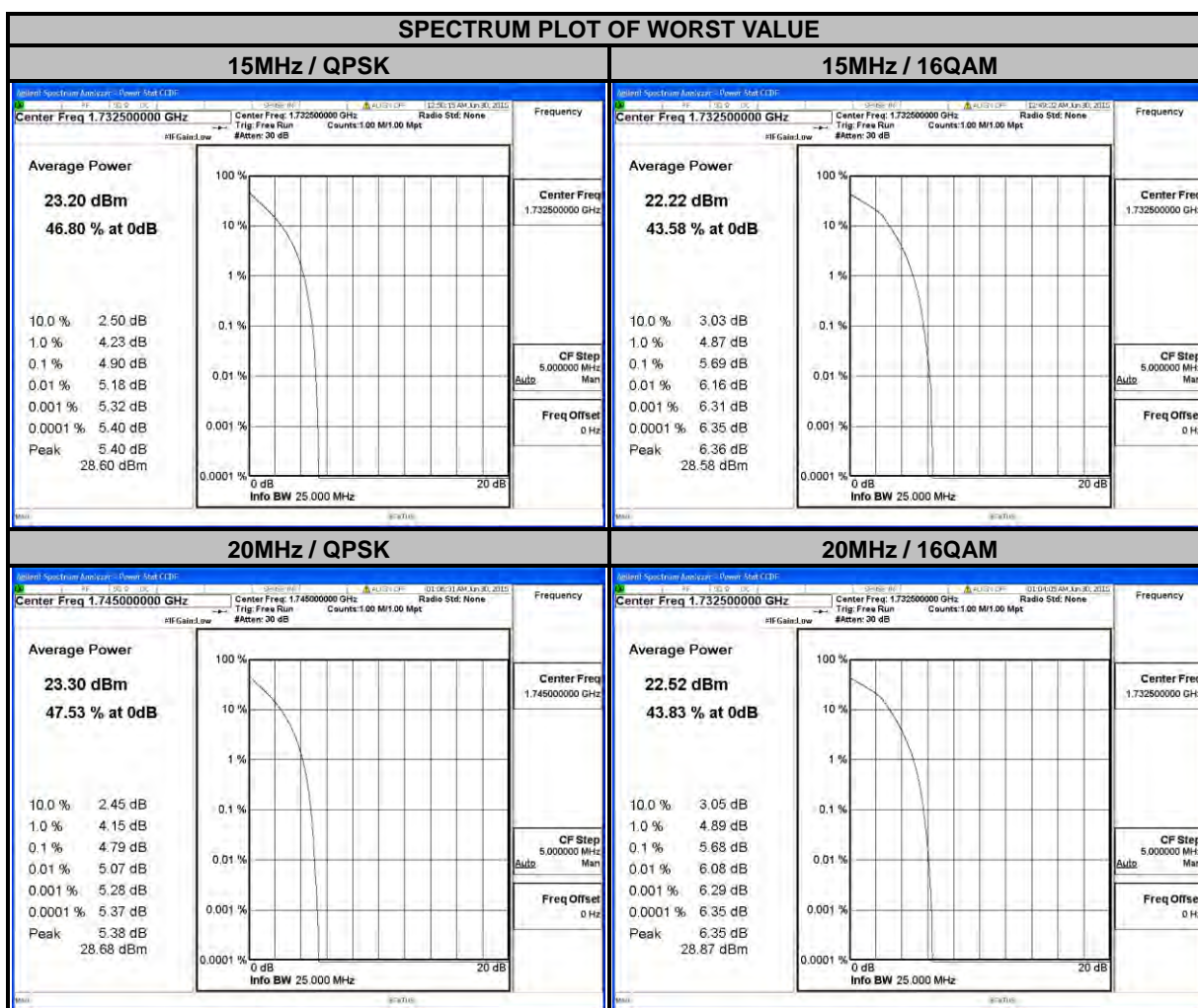



A D T

LTE BAND 12							
CHANNEL BANDWIDTH: 1.4MHz				CHANNEL BANDWIDTH: 3MHz			
CHANNEL	FREQUENCY (MHz)	PEAK TO AVERAGE RATIO (dB)		CHANNEL	FREQUENCY (MHz)	PEAK TO AVERAGE RATIO (dB)	
		QPSK	16QAM			QPSK	16QAM
23017	699.7	4.62	5.76	23025	700.5	4.49	5.69
23095	707.5	4.98	6.18	23095	707.5	4.89	6.22
23173	715.3	5.02	6.22	23165	714.5	5.09	6.30

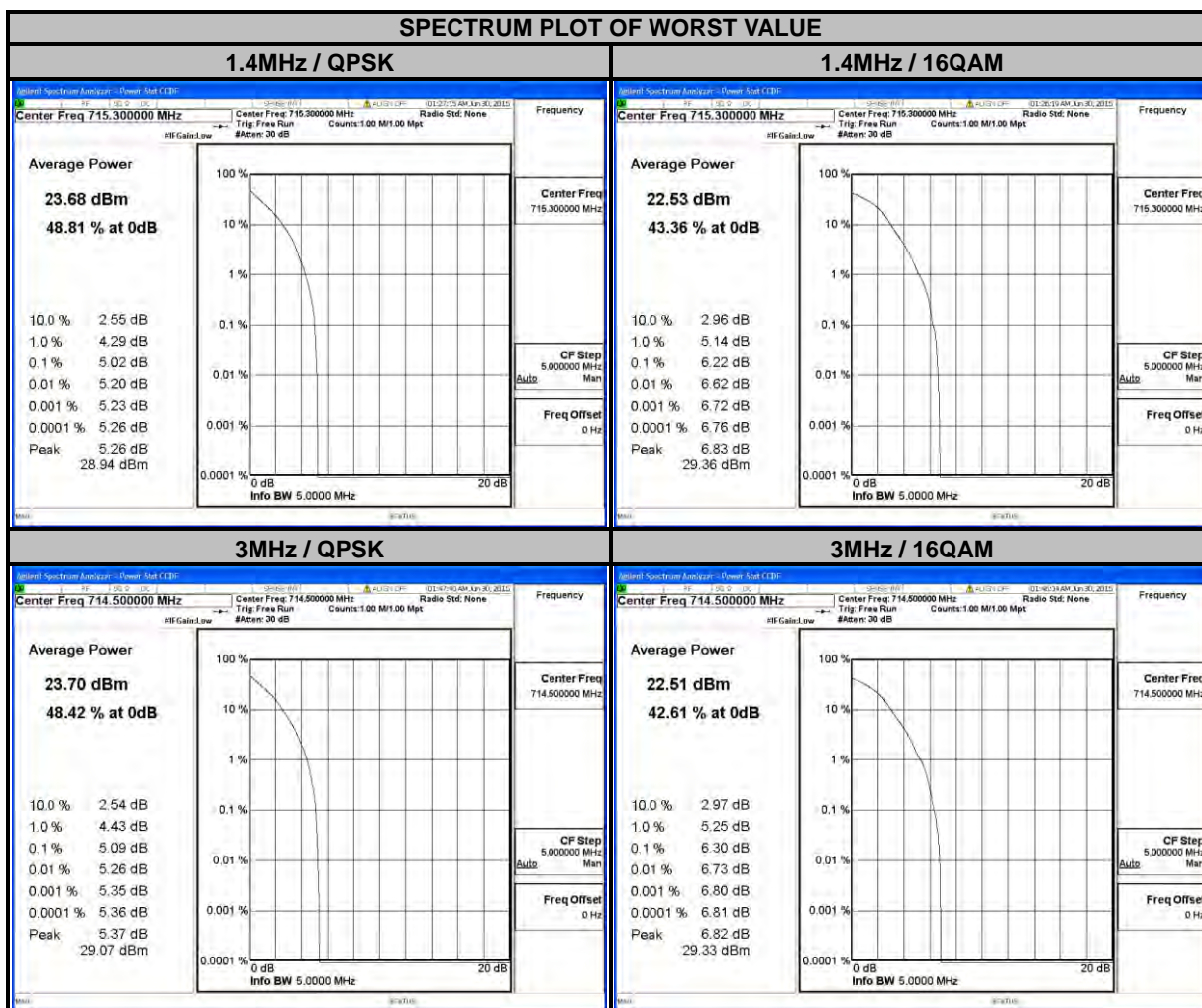



A D T

LTE BAND 12							
CHANNEL BANDWIDTH: 5MHz				CHANNEL BANDWIDTH: 10MHz			
CHANNEL	FREQUENCY (MHz)	PEAK TO AVERAGE RATIO (dB)		CHANNEL	FREQUENCY (MHz)	PEAK TO AVERAGE RATIO (dB)	
		QPSK	16QAM			QPSK	16QAM
23035	701.5	4.47	5.54	23060	704.0	4.44	5.69
23095	707.5	4.90	6.04	23095	707.5	4.91	6.14
23155	713.5	4.94	6.06	23130	711.0	4.86	6.06

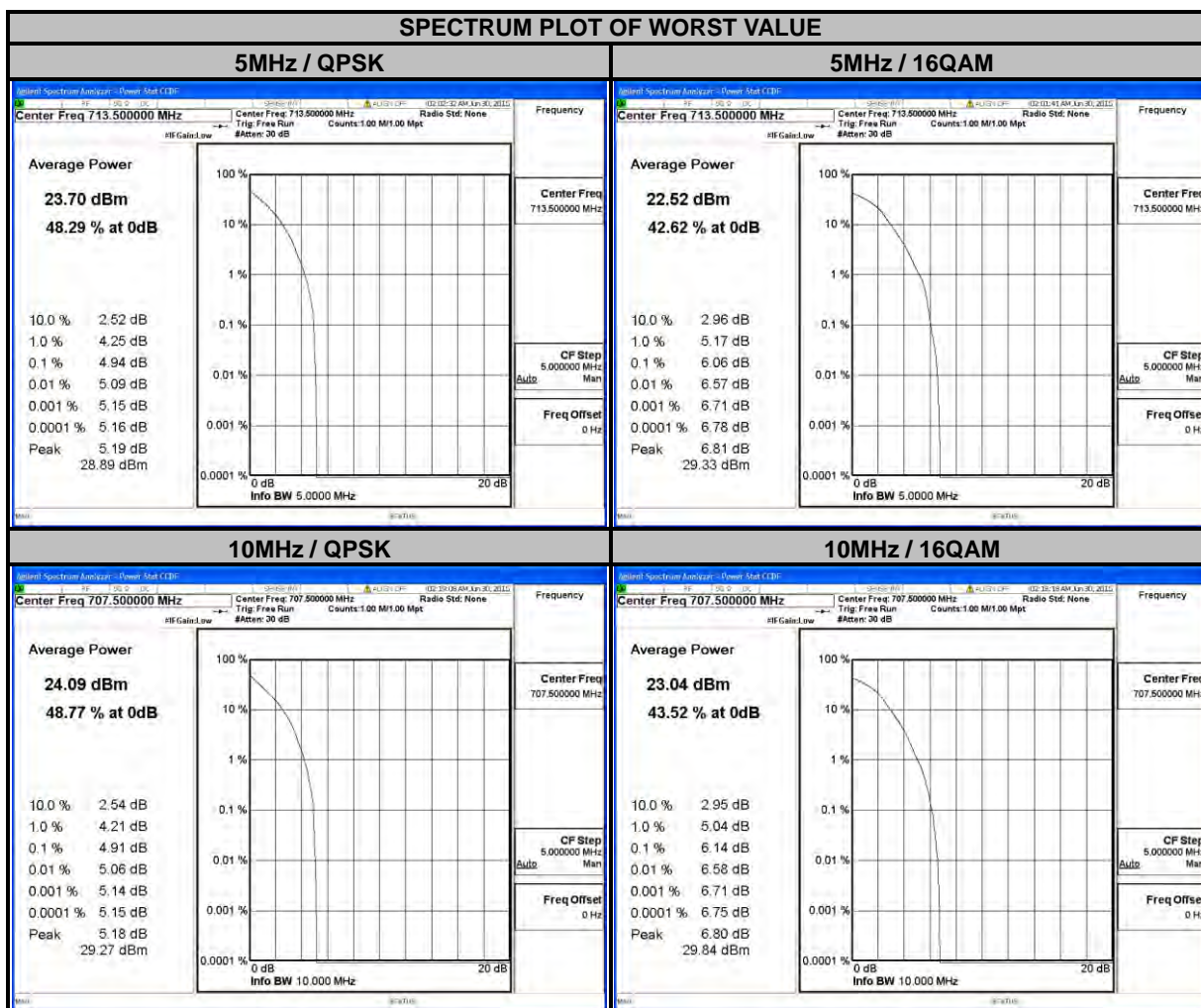



A D T

LTE BAND 17							
CHANNEL BANDWIDTH: 5MHz				CHANNEL BANDWIDTH: 10MHz			
CHANNEL	FREQUENCY (MHz)	PEAK TO AVERAGE RATIO (dB)		CHANNEL	FREQUENCY (MHz)	PEAK TO AVERAGE RATIO (dB)	
		QPSK	16QAM			QPSK	16QAM
23755	706.5	3.28	4.02	23780	709.0	2.99	3.93
23790	710.0	3.50	4.27	23790	710.0	3.17	4.03
23825	713.5	3.13	3.99	23800	711.0	3.36	4.14

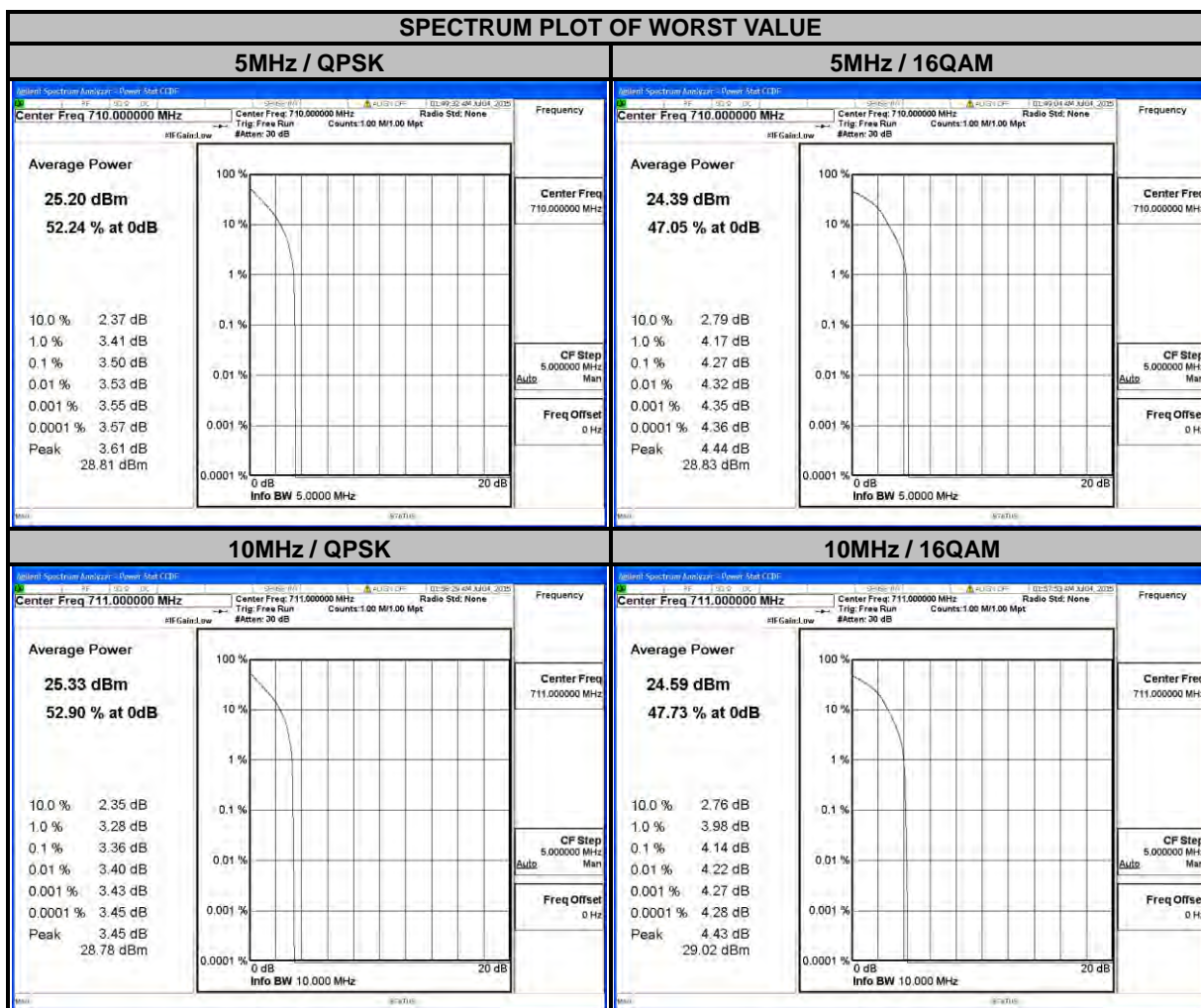

4.5 BAND EDGE MEASUREMENT

4.5.1 LIMITS OF BAND EDGE MEASUREMENT

For operations in the 699-716 MHz band, the power of any emission outside a licensee's frequency band(s) of operation shall be attenuated below the transmitter power (P) within the licensed band(s) of operation, measured in watts, by at least $43 + 10 \log(P)$ dB. Compliance with this provision is based on the use of measurement instrumentation employing a resolution bandwidth of 100 kilohertz or greater. However, in the 100 kilohertz bands immediately outside and adjacent to a licensee's frequency block, a resolution bandwidth of at least 30 kHz may be employed.

For operations in the 1710–1755 MHz bands, the power of any emission outside a licensee's frequency block shall be attenuated below the transmitter power (P) by at least $43 + 10 \log_{10}(P)$ dB.

4.5.2 TEST SETUP

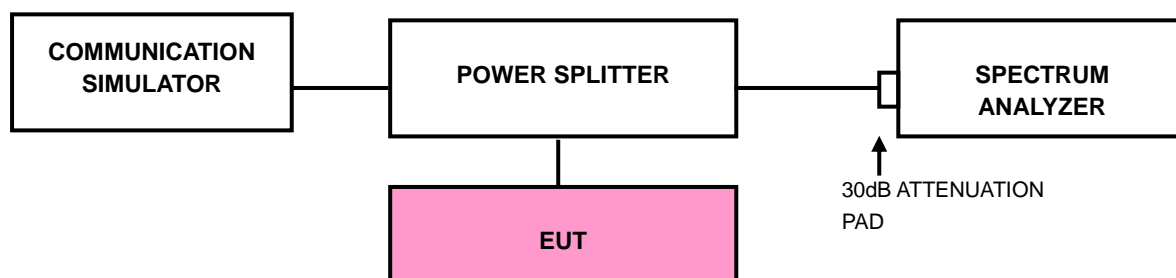

4.5.3 TEST PROCEDURES

- a. The EUT was set up for the maximum peak power with LTE link data modulation. The power was measured with R&S Spectrum Analyzer. All measurements were done at 2 channels (low and high operational frequency range.).
- b. The band edge measurement used the power splitter via EUT RF power connector between simulation base station and spectrum analyzer.
- c. The center frequency of spectrum is the band edge frequency and span is 1 MHz. RB of the spectrum is 13kHz and VB of the spectrum is 51kHz (Channel Bandwidth 1.4MHz).
- d. The center frequency of spectrum is the band edge frequency and span is 1 MHz. RB of the spectrum is 30kHz and VB of the spectrum is 100kHz (Channel Bandwidth 3MHz).
- e. The center frequency of spectrum is the band edge frequency and span is 1 MHz. RB of the spectrum is 100kHz and VB of the spectrum is 300kHz (Channel Bandwidth 5MHz/10MHz).
- f. The center frequency of spectrum is the band edge frequency and span is 1 MHz. RB of the spectrum is 150kHz and VB of the spectrum is 470kHz (Channel Bandwidth 15MHz).
- g. The center frequency of spectrum is the band edge frequency and span is 1 MHz. RB of the spectrum is 180kHz and VB of the spectrum is 560kHz (Channel Bandwidth 20MHz).
- h. Record the max trace plot into the test report.

4.5.4 TEST RESULTS

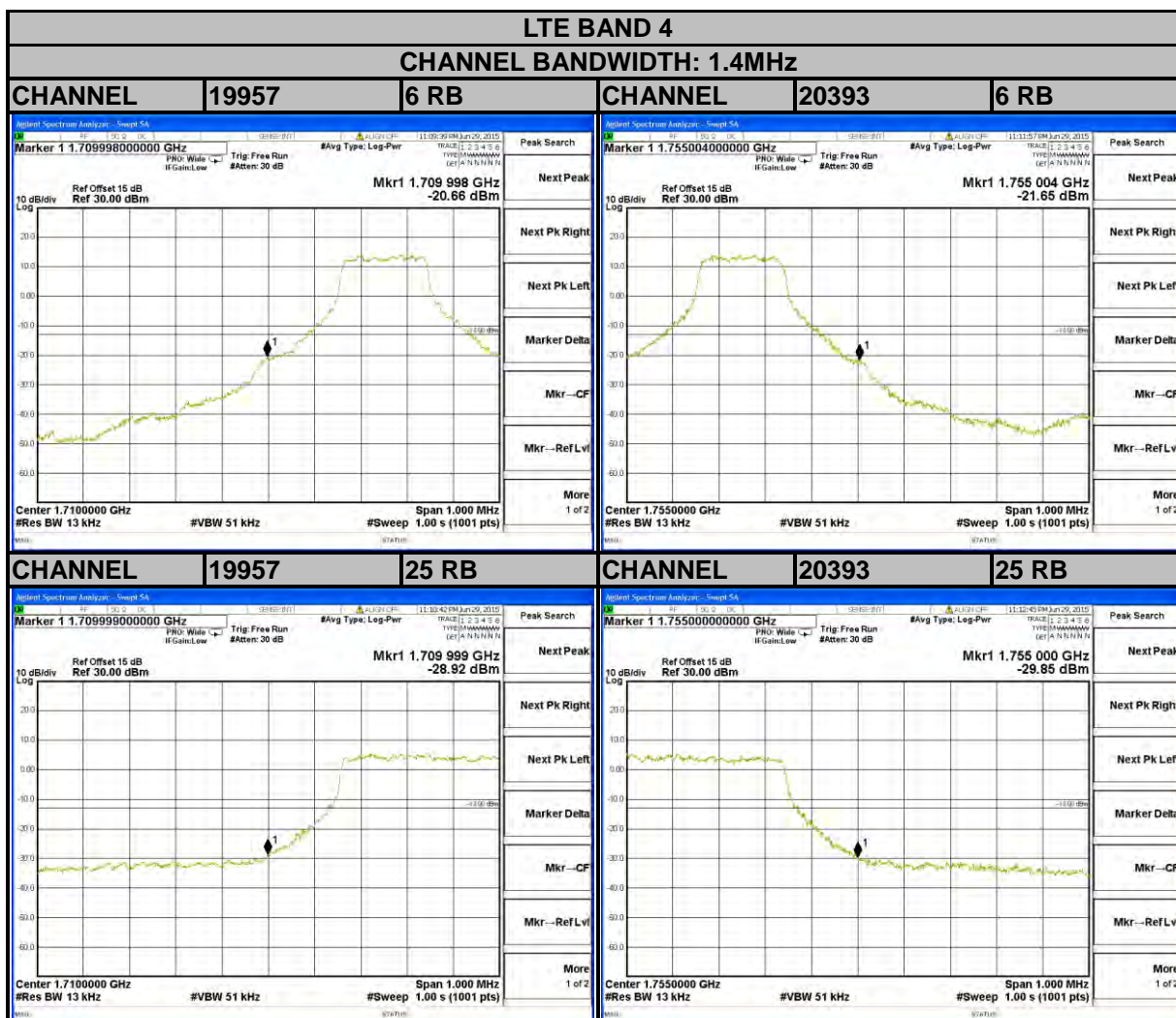



A D T

LTE BAND 4

CHANNEL BANDWIDTH: 3MHz

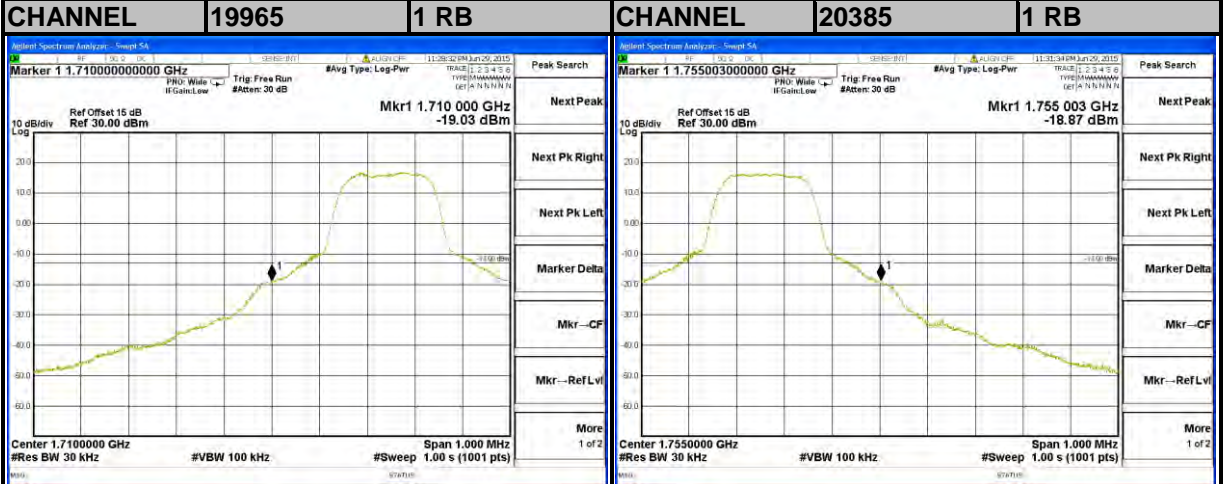

CHANNEL	19965	15 RB	CHANNEL	20385	15 RB
---------	-------	-------	---------	-------	-------





A D T

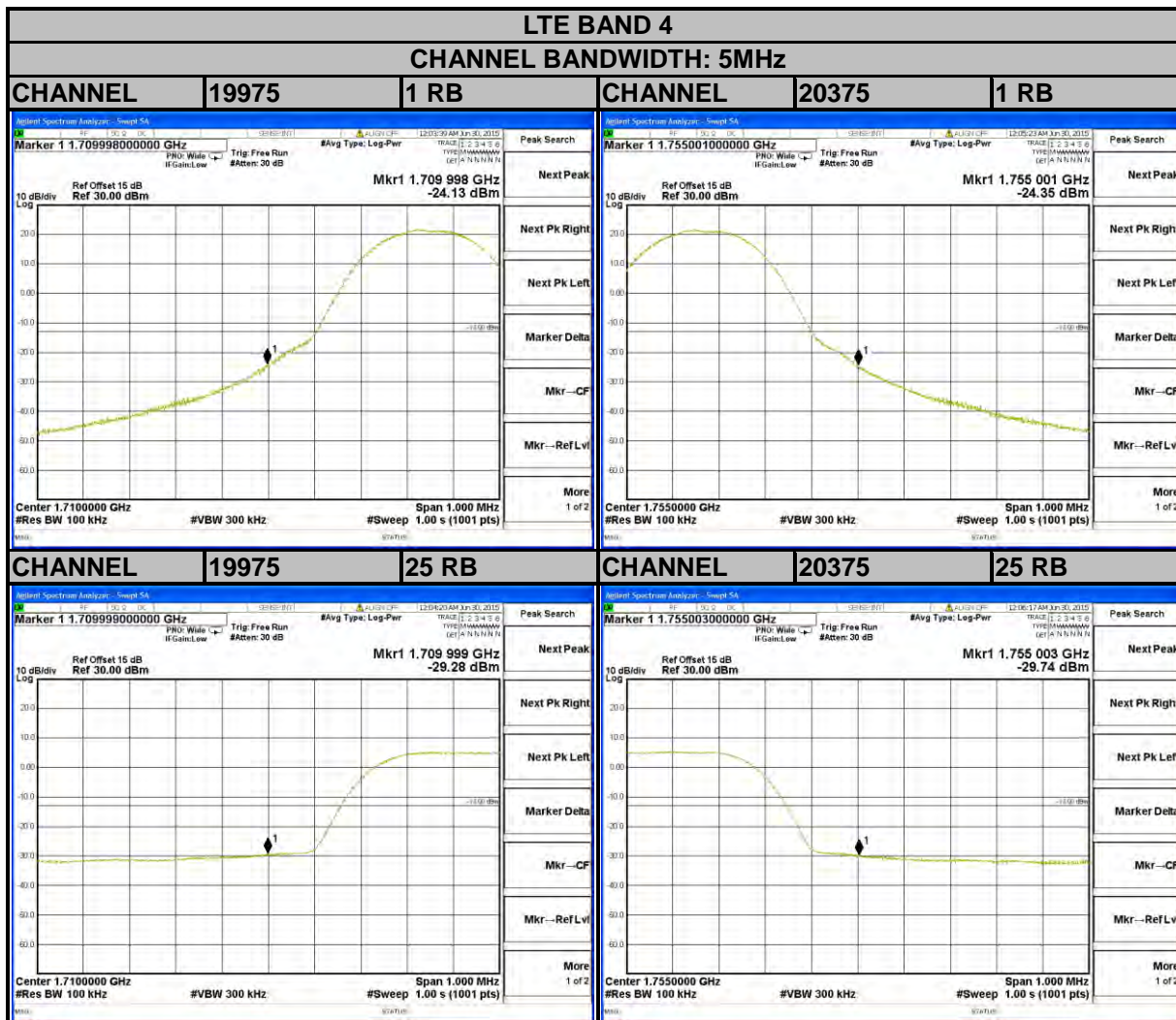



A D T

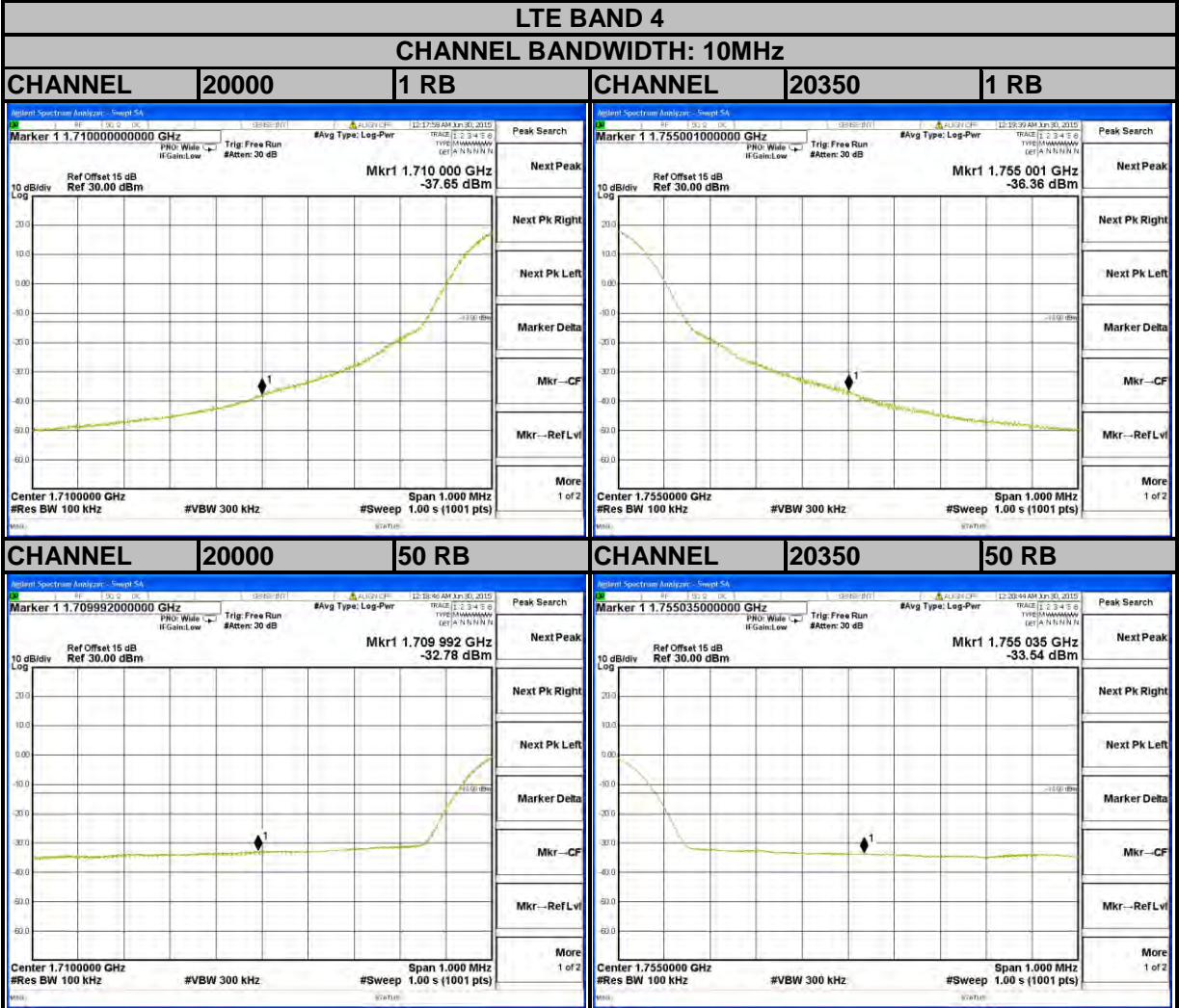



A D T

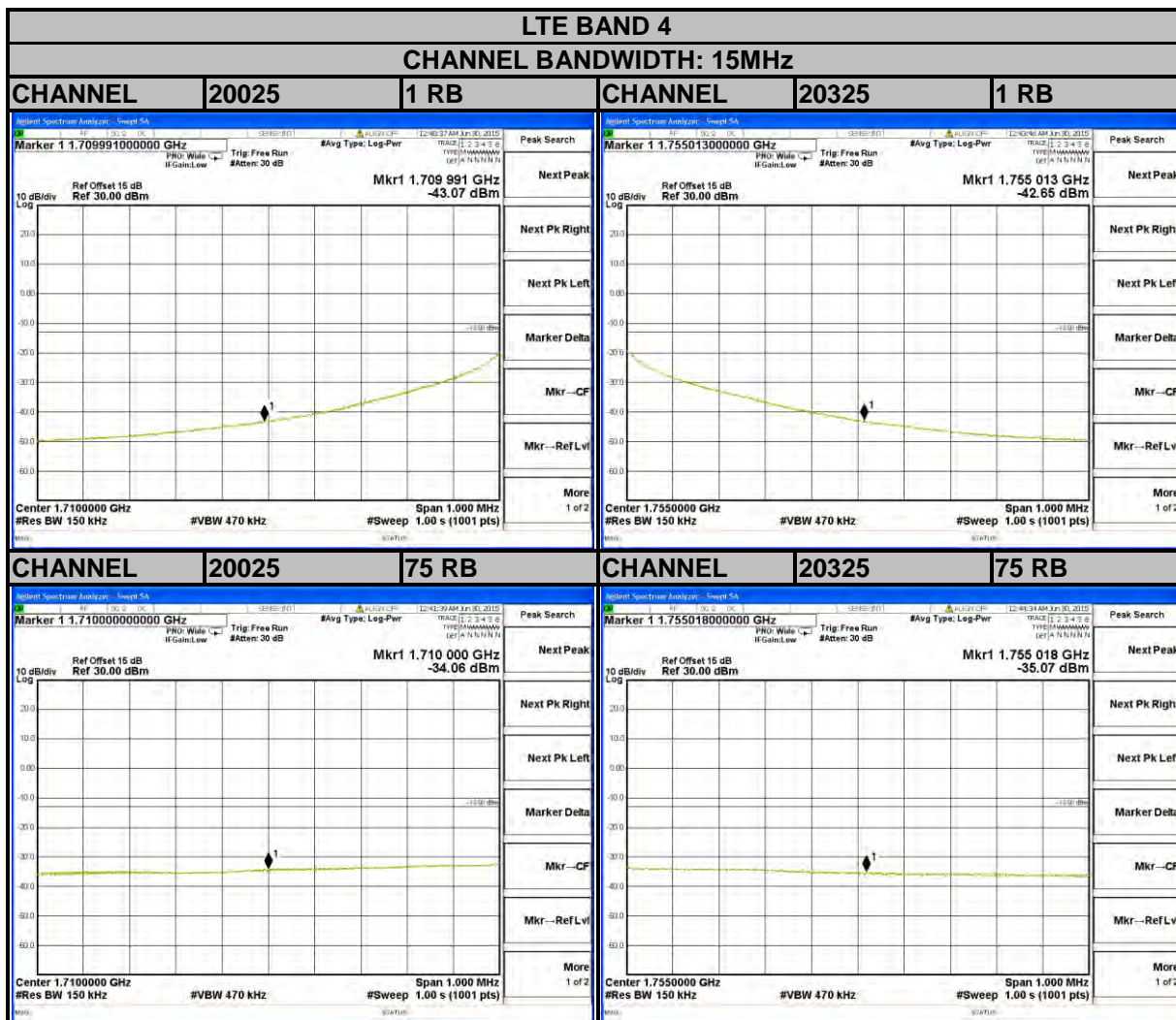



A D T

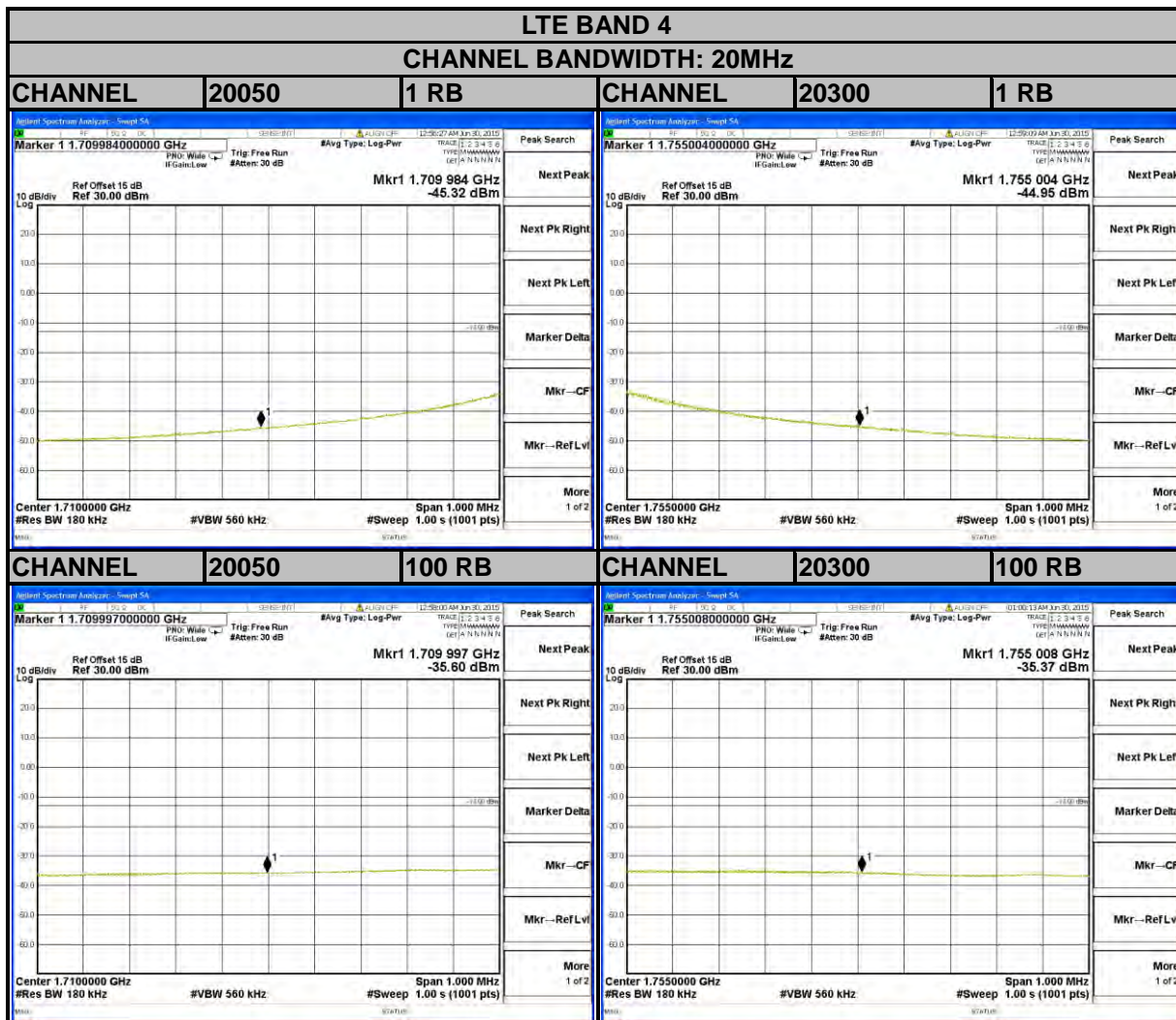



A D T

LTE BAND 12

CHANNEL BANDWIDTH: 1.4MHz

CHANNEL	23017	1 RB	CHANNEL	23173	1 RB
----------------	--------------	-------------	----------------	--------------	-------------

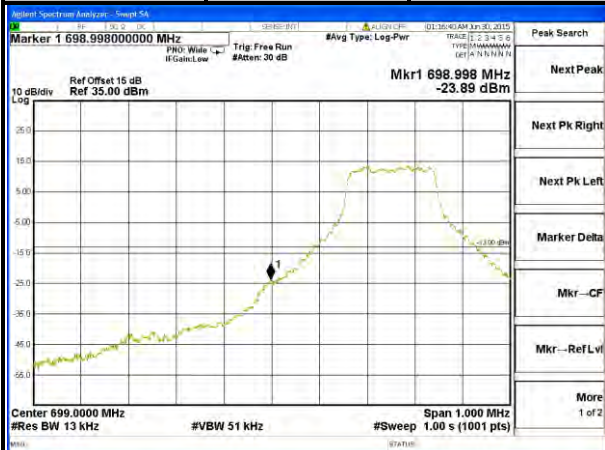

CHANNEL	23017	6 RB
----------------	--------------	-------------

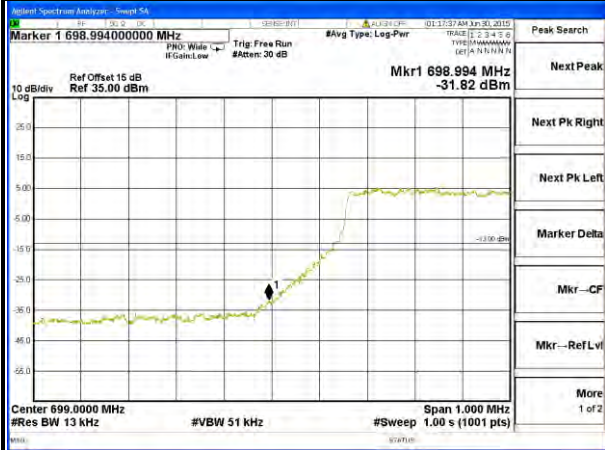

CHANNEL	23173	6 RB
----------------	--------------	-------------





A D T

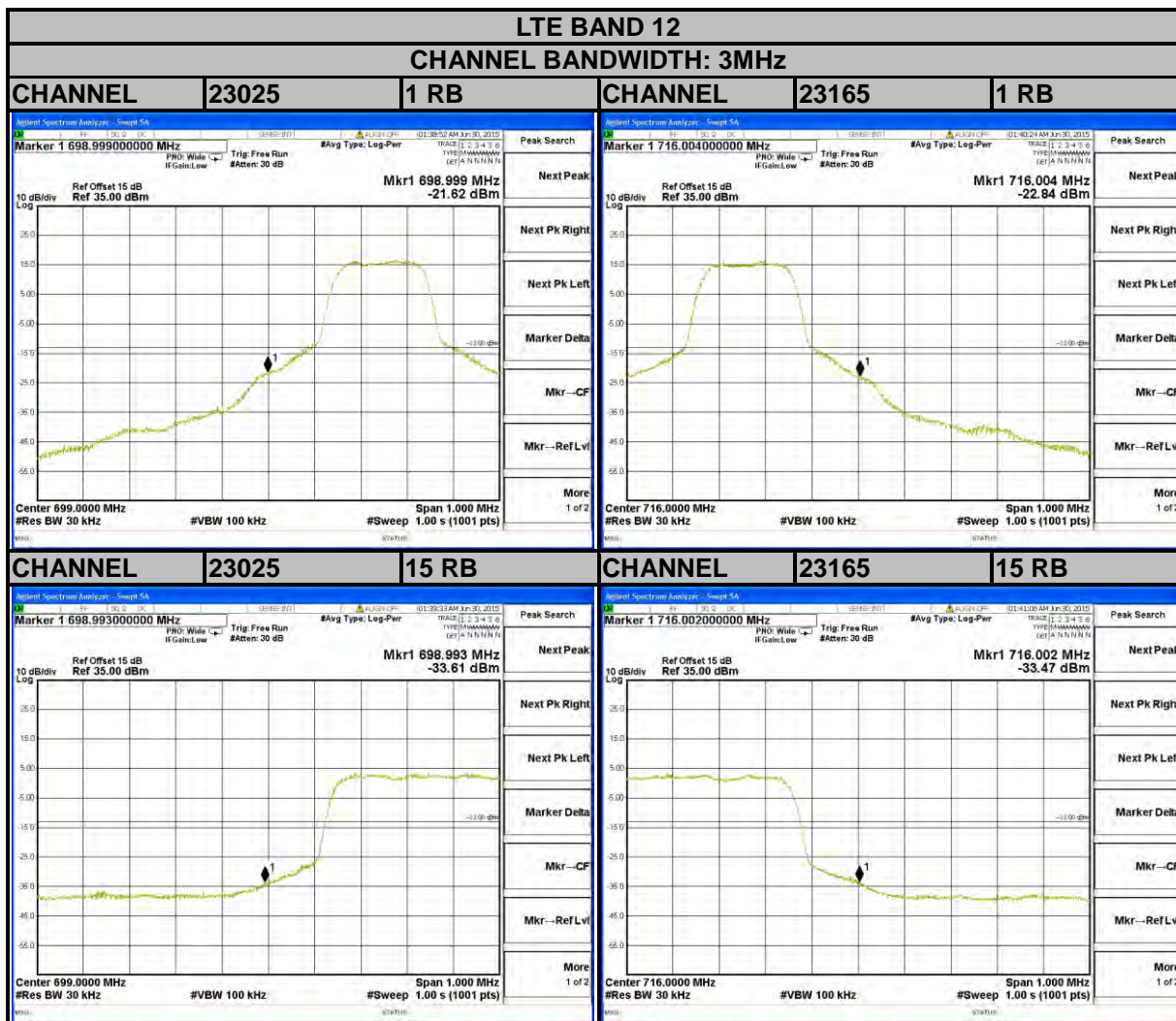



A D T

LTE BAND 12

CHANNEL BANDWIDTH: 5MHz

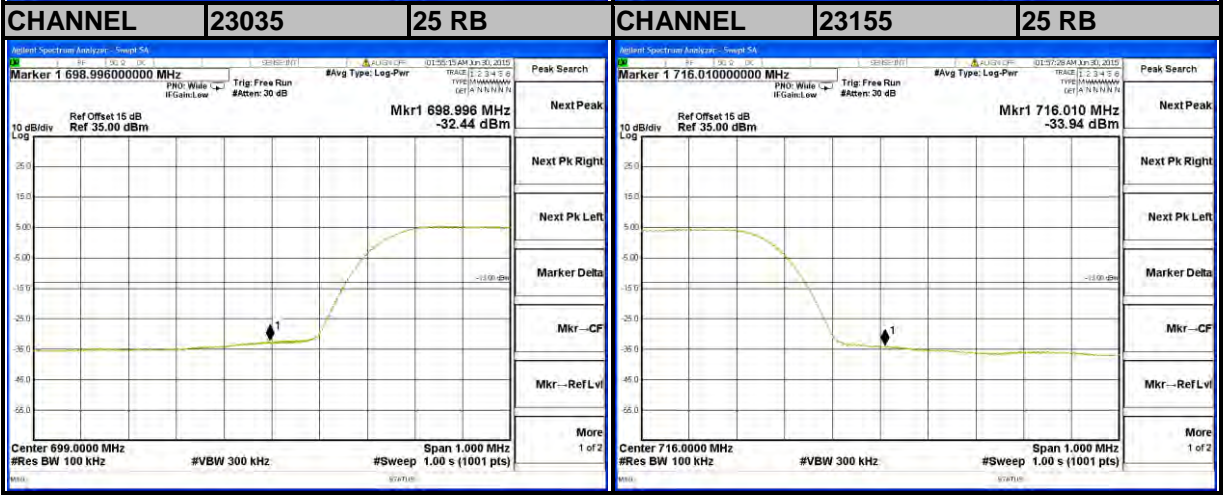
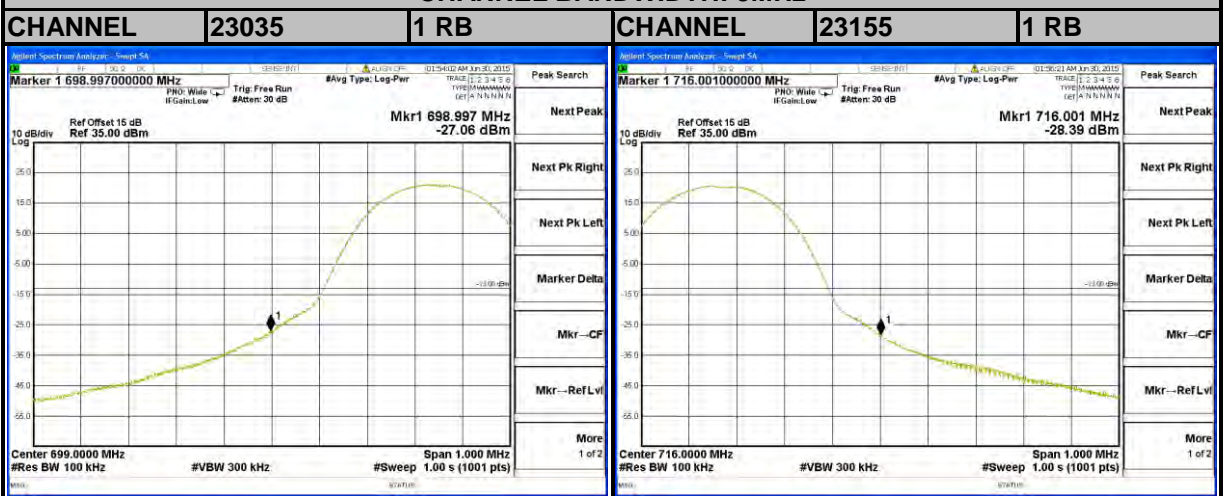



A D T

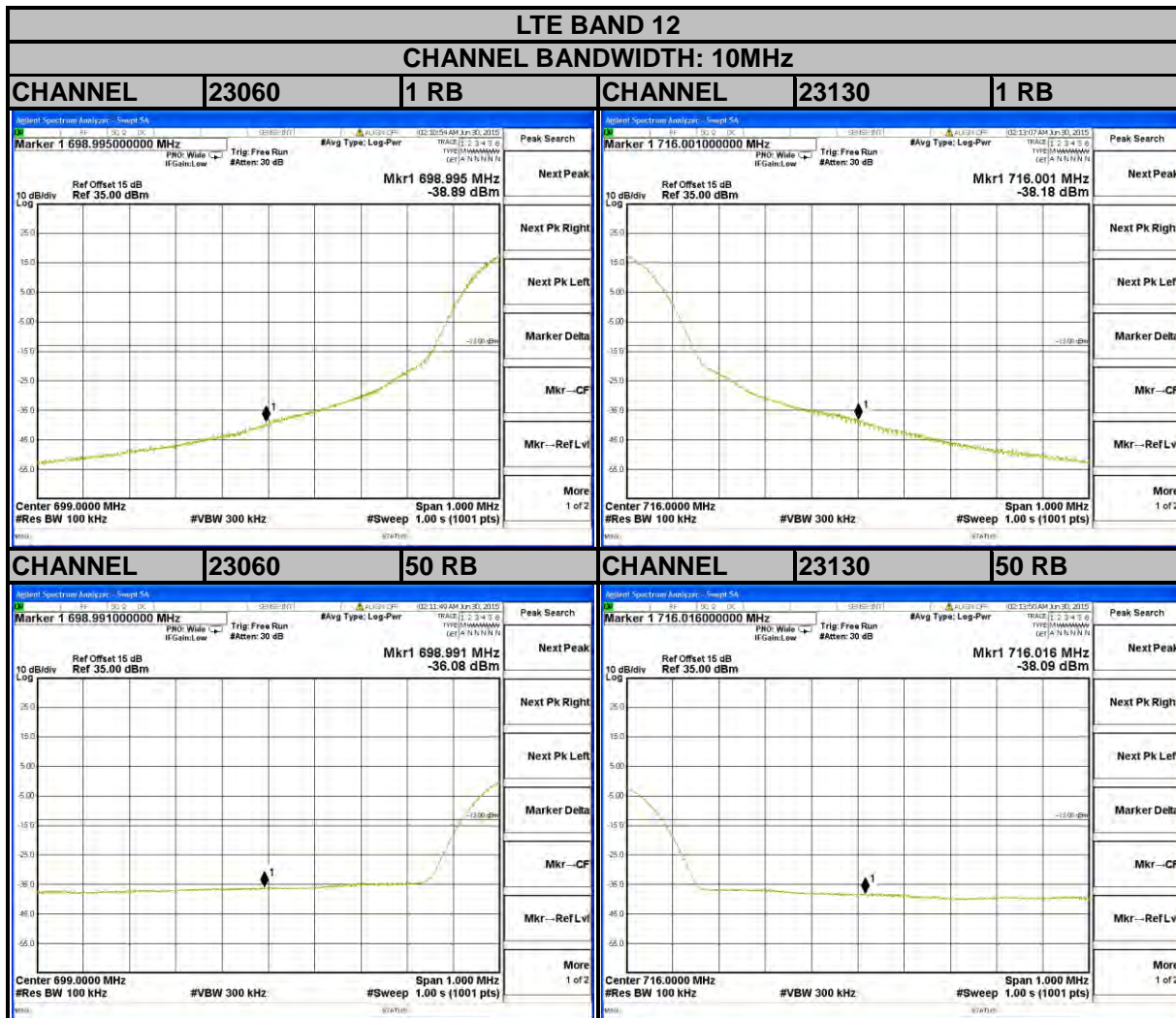



A D T

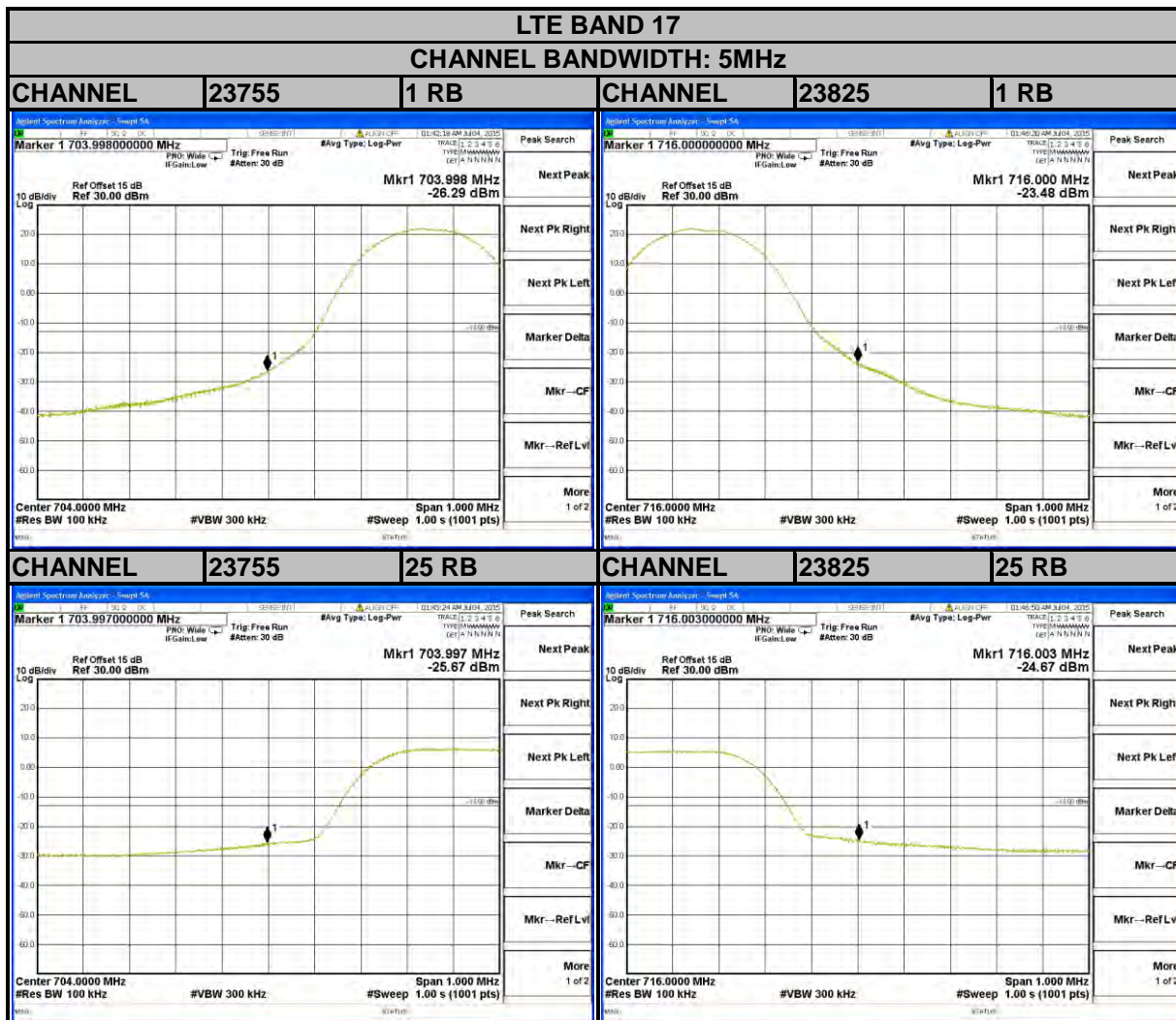



A D T

LTE BAND 17

CHANNEL BANDWIDTH: 10MHz

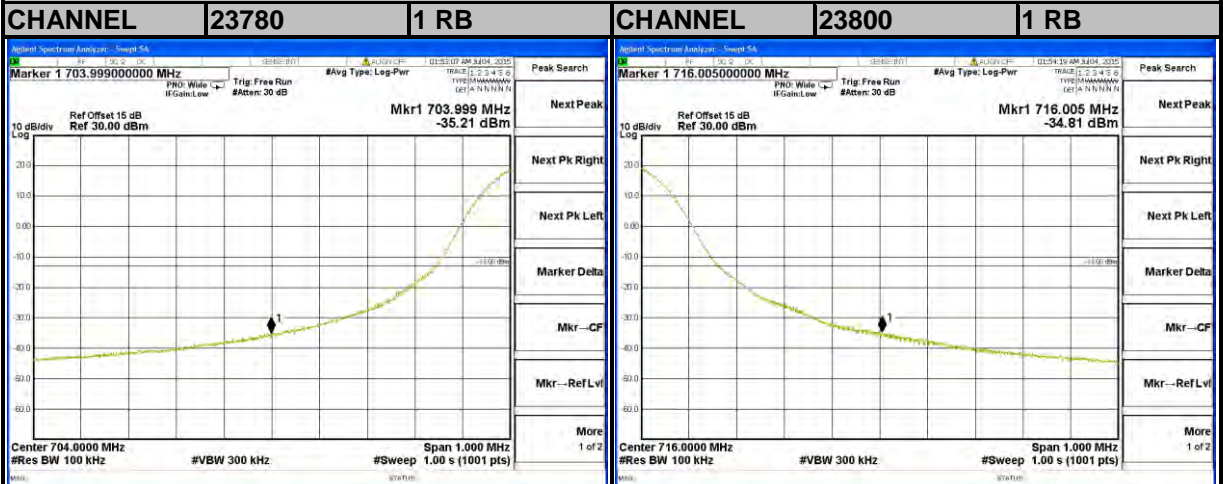

CHANNEL BANDWIDTH: 50 RB

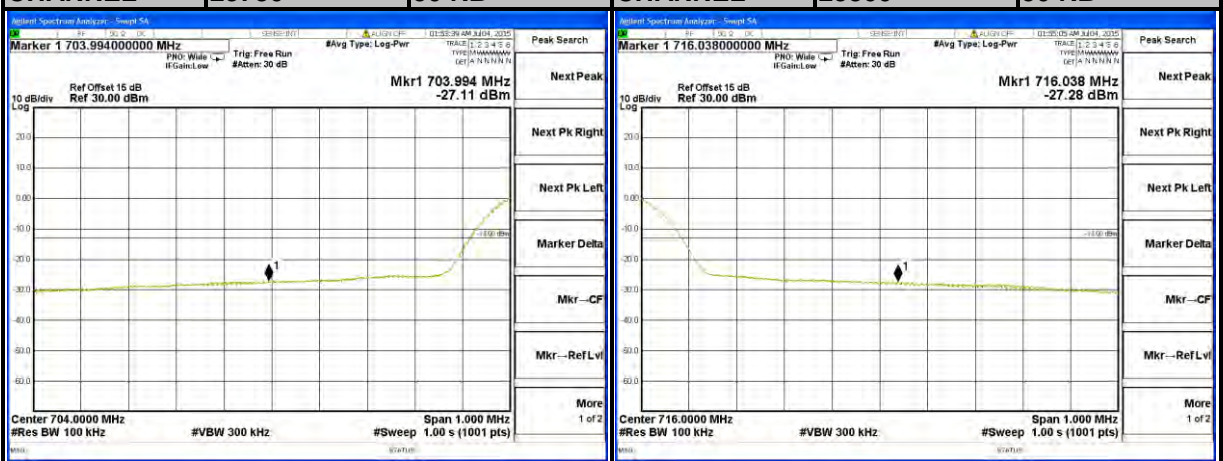

4.6 CONDUCTED SPURIOUS EMISSIONS

4.6.1 LIMITS OF CONDUCTED SPURIOUS EMISSIONS MEASUREMENT

The power of any emission outside a licensee's frequency block shall be attenuated below the transmitter power (P) by at least $43 + 10 \log_{10}(P)$ dB. The limit of emission is equal to -13dBm.

4.6.2 TEST PROCEDURE

- a. The EUT makes a phone call to the communication simulator. All measurements were done at low, middle and high operational frequency range.
- b. Measuring frequency range is from 30 MHz to 8GHz for LTE Band 12 and Band 17 and from 30MHz to 18GHz for LTE Band 4. 10dB attenuation pad is connected with spectrum. RBW=1MHz and VBW=3MHz are used for conducted emission measurement.

4.6.3 TEST SETUP

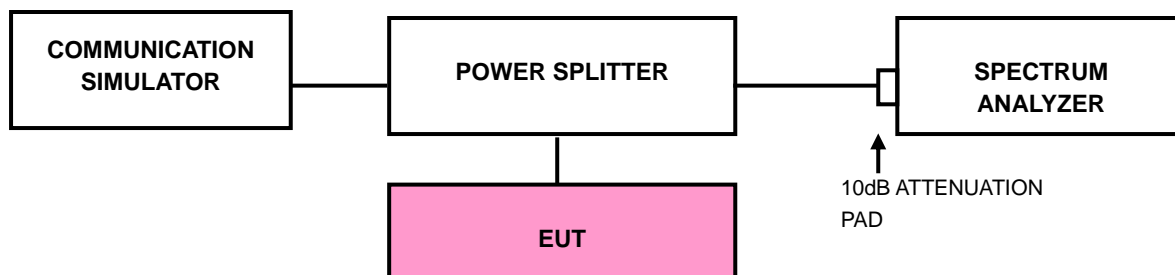



A D T

4.6.4 TEST RESULTS

FREQUENCY RANGE: 30MHz~8GHz

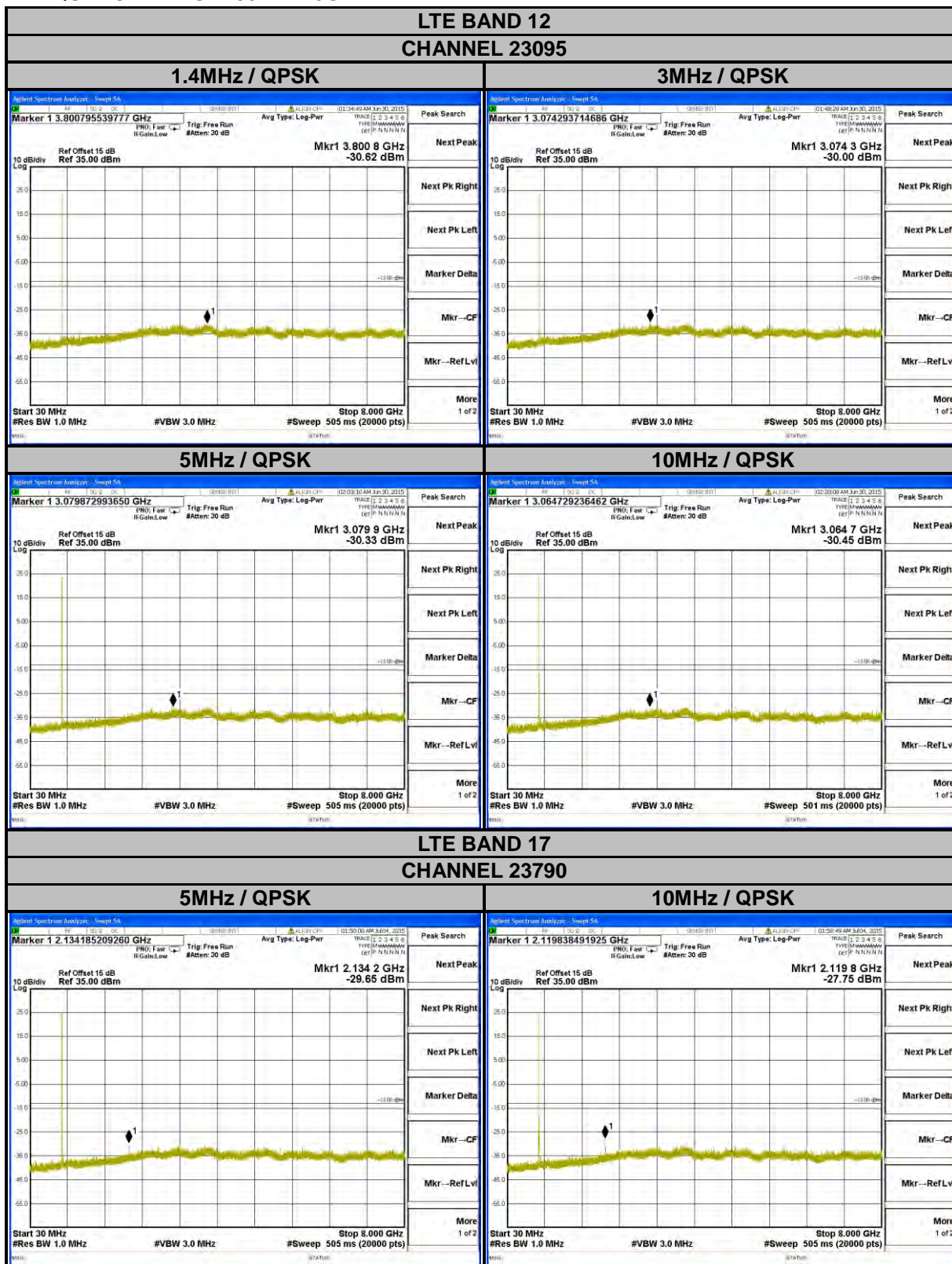



A D T

FREQUENCY RANGE: 30MHz~18GHz

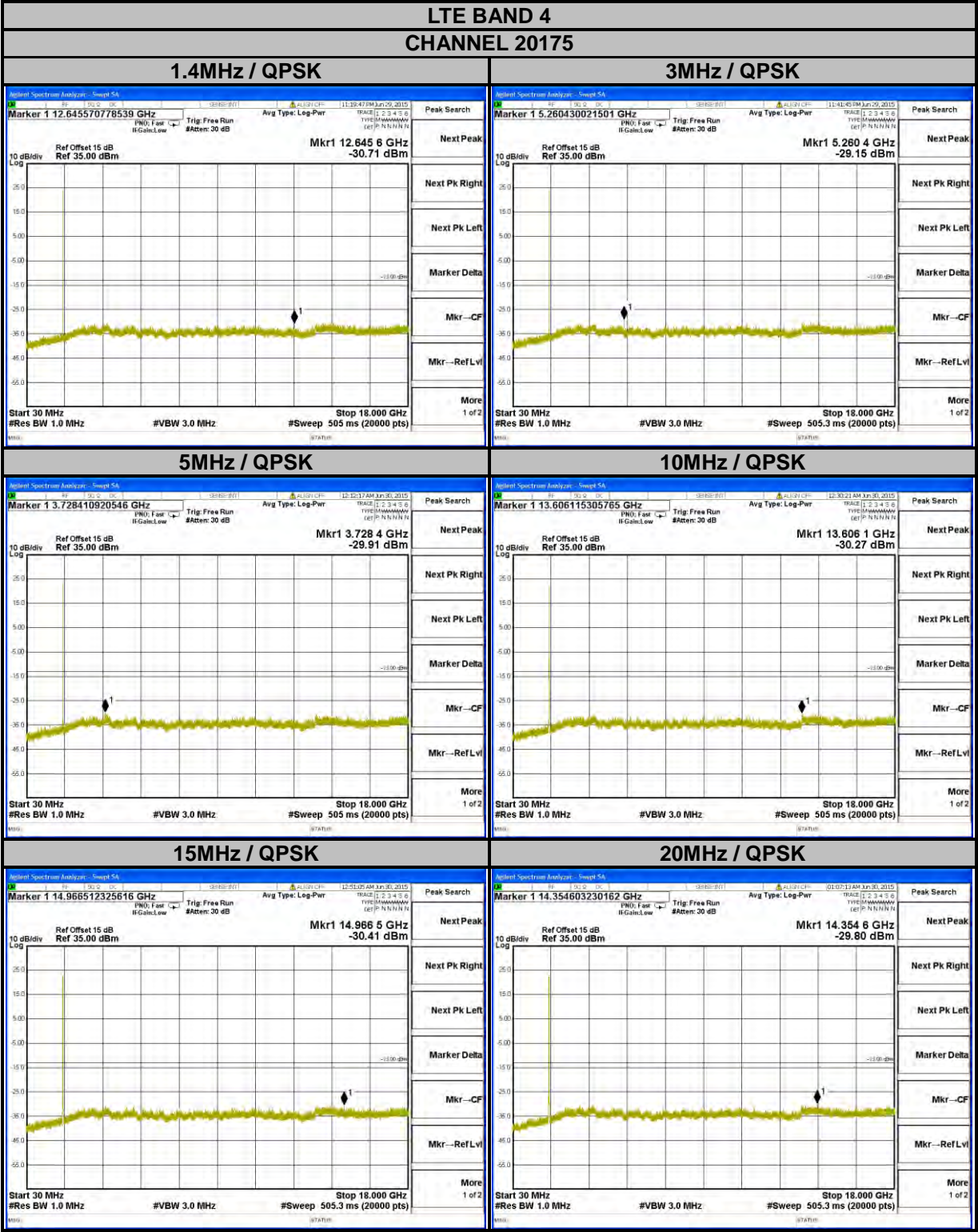

4.7 RADIATED EMISSION MEASUREMENT

4.7.1 LIMITS OF RADIATED EMISSION MEASUREMENT

The power of any emission outside a licensee's frequency block shall be attenuated below the transmitter power (P) by at least $43 + 10 \log_{10}(P)$ dB. The limit of emission equal to -13dBm

4.7.2 TEST PROCEDURES

- a. Substitution method is used for E.I.R.P measurement. In the semi-anechoic chamber, EUT placed on the 0.8m height of Turn Table, rotated the table around 360 degrees to search the maximum radiation power and receiver antenna shall be rotated vertical and horizontal polarization and moved height from 1m to 4m to find the maximum polar radiated power. The "Read Value" is the spectrum reading the maximum power value.
- b. The substitution horn antenna is substituted for EUT at the same position and signals generator export the CW signal to the substitution antenna via a TX cable. Rotated the Turn Table and moved receiving antenna to find the maximum radiation power. Adjust output power level of S.G to get a Value of spectrum reading equal to "Read Value " of step a. Record the power level of S.G
- c. $\text{EIRP} = \text{Output power level of S.G} - \text{TX cable loss} + \text{Antenna gain of substitution horn.}$
- d. E.R.P power can be calculated form E.I.R.P power by subtracting the gain of dipole, $\text{E.R.P power} = \text{E.I.P.R power} - 2.15\text{dBi.}$

NOTE: The resolution bandwidth of spectrum analyzer is 1 MHz and the video bandwidth is 3 MHz.

4.7.3 DEVIATION FROM TEST STANDARD

No deviation

4.7.4 TEST SETUP

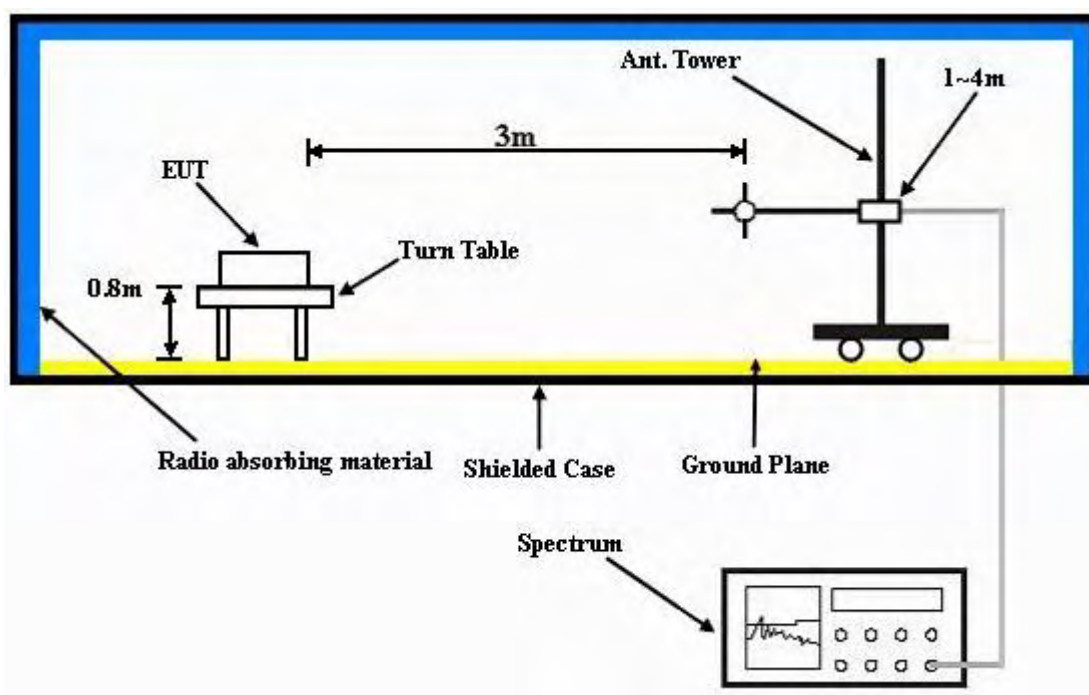

For the actual test configuration, please refer to the attached file (Test Setup Photo).



A D T

4.7.5 TEST RESULTS

LTE BAND 4

CHANNEL BANDWIDTH: 20MHz / QPSK



Bureau Veritas Consumer Products Services Ltd., Taoyuan Branch

A D T

Data: 13

Date: 2015-07-02

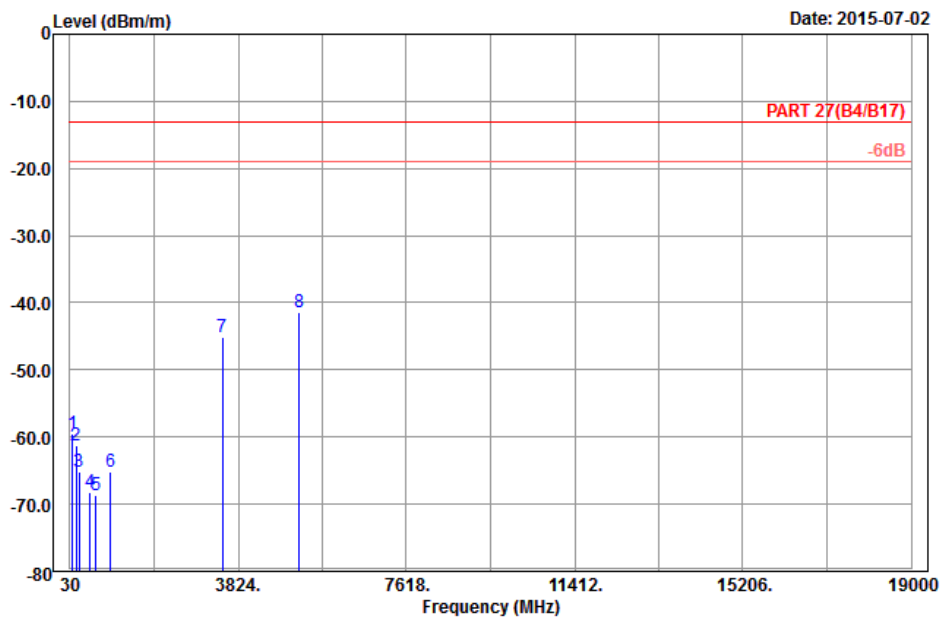

Site : 966 chamber 1
 Condition: PART 27(B4/B17) 3m Horizontal
 Remark : LTE_Band 4_QPSK(1,0)_20M_CH20175
 Tested by: Charles Hsiao
 Plane : Z

	Read	Limit	Over			
Freq	Level	Level	Line	Limit	Factor	Remark
MHz	dBm/m	dBm	dBm/m	dB	dB/m	
1	93.18	-59.51	-49.00	-13.00	-46.51	-10.51 Peak
2	166.89	-61.20	-54.21	-13.00	-48.20	-6.99 Peak
3	229.26	-65.26	-59.47	-13.00	-52.26	-5.79 Peak
4	486.20	-68.28	-63.41	-13.00	-55.28	-4.87 Peak
5	621.30	-68.60	-68.78	-13.00	-55.60	0.18 Peak
6	949.60	-65.09	-70.20	-13.00	-52.09	5.11 Peak
7	3465.00	-45.12	-59.46	-13.00	-32.12	14.34 Peak
8 pp	5197.50	-41.50	-61.62	-13.00	-28.50	20.12 Peak



A D T



Bureau Veritas Consumer Products Services Ltd., Taoyuan Branch

A D T

Data: 14

Date: 2015-07-02

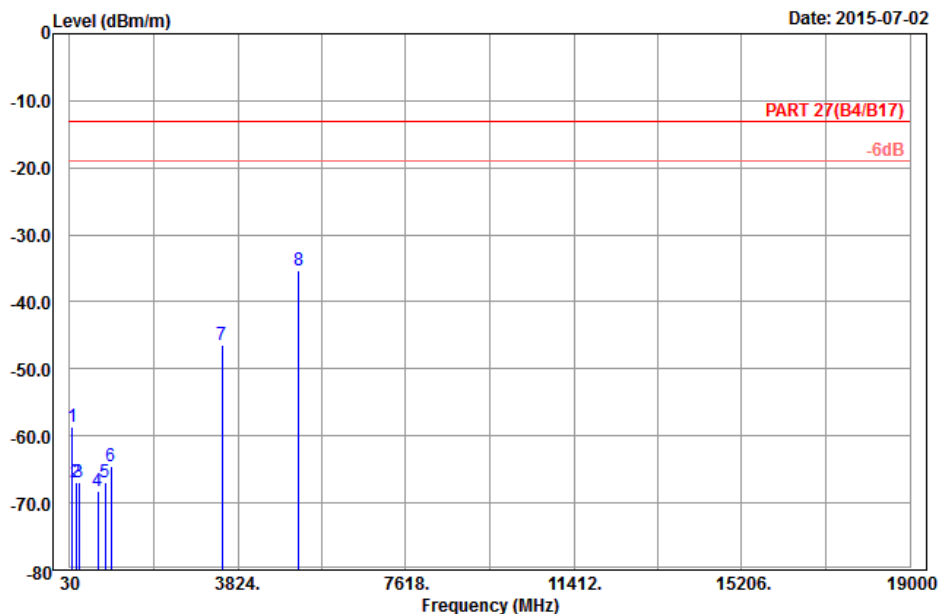

Site : 966 chamber 1
 Condition: PART 27(B4/B17) 3m Vertical
 Remark : LTE_Band 4_QPSK(1,0)_20M_CH20175
 Tested by: Charles Hsiao
 Plane : Z

	Freq	Level	Read Level	Limit	Over	Factor	Remark
	MHz	dBm/m	dBm	dBm/m	dB	dB/m	
1	83.73	-58.73	-47.29	-13.00	-45.73	-11.44	Peak
2	165.81	-66.88	-59.79	-13.00	-53.88	-7.09	Peak
3	231.69	-67.02	-61.27	-13.00	-54.02	-5.75	Peak
4	660.50	-68.18	-67.99	-13.00	-55.18	-0.19	Peak
5	827.10	-66.84	-68.54	-13.00	-53.84	1.70	Peak
6	958.00	-64.49	-69.62	-13.00	-51.49	5.13	Peak
7	3465.00	-46.49	-60.83	-13.00	-33.49	14.34	Peak
8 pp	5197.50	-35.23	-55.35	-13.00	-22.23	20.12	Peak



A D T

LTE BAND 12
CHANNEL BANDWIDTH: 10MHz / QPSK



Bureau Veritas Consumer Products Services Ltd., Taoyuan Branch

A D T

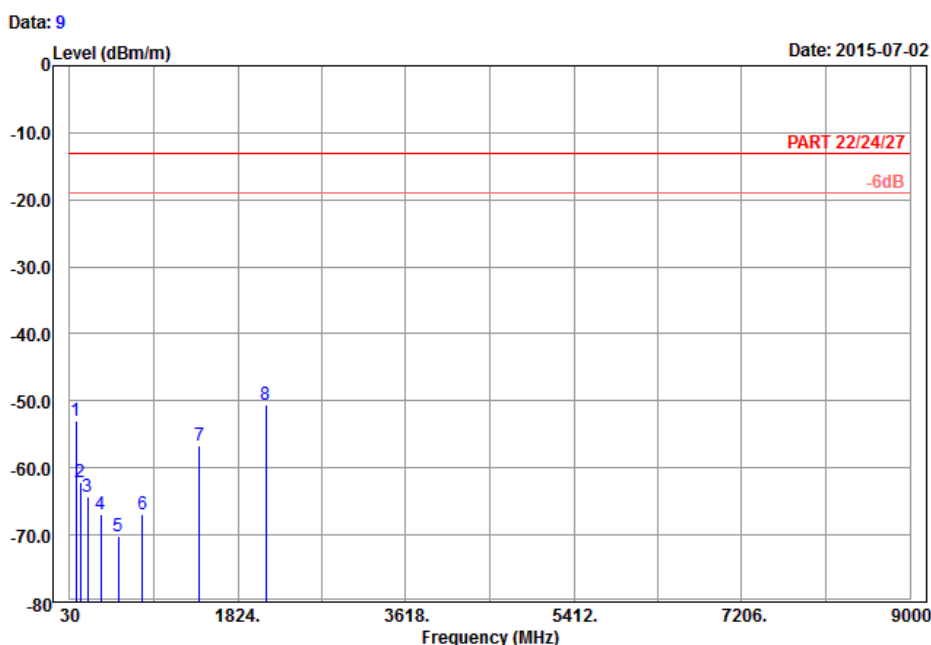

Site : 966 chamber 1
 Condition: PART 22/24/27 3m Horizontal
 Remark : LTE_Band 12_QPSK(1,49)_10M_CH23095
 Tested by: Harry Hsueh
 Plane : Y

	Read	Limit	Over				
Freq	Level	Level	Line	Limit	Factor	Remark	
MHz	dBm/m	dBm	dBm/m	dB	dB/m		
1	94.80	-52.97	-42.57	-13.00	-39.97	-10.40	Peak
2	145.83	-62.04	-54.21	-13.00	-49.04	-7.83	Peak
3	222.51	-64.31	-58.43	-13.00	-51.31	-5.88	Peak
4	360.90	-66.92	-62.11	-13.00	-53.92	-4.81	Peak
5	545.70	-70.24	-68.29	-13.00	-57.24	-1.95	Peak
6	804.70	-66.92	-68.88	-13.00	-53.92	1.96	Peak
7	1415.00	-56.67	-63.03	-13.00	-43.67	6.36	Peak
8 pp	2122.50	-50.64	-61.75	-13.00	-37.64	11.11	Peak



A D T



Bureau Veritas Consumer Products Services Ltd., Taoyuan Branch

A D T

Data: 10

Date: 2015-07-02

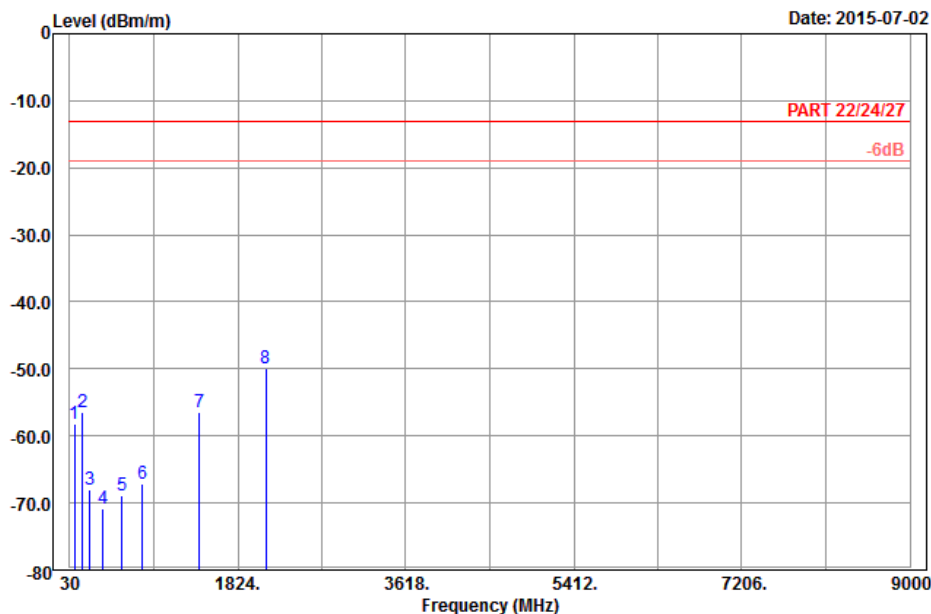

Site : 966 chamber 1
 Condition: PART 22/24/27 3m Vertical
 Remark : LTE_Band 12_QPSK(1,49)_10M_CH23095
 Tested by: Harry Hsueh
 Plane : Y

	Freq	Level	Read Level	Limit	Over		
	MHz	dBm/m	dBm	dBm/m	dB	dB/m	Remark
1	83.46	-58.21	-46.77	-13.00	-45.21	-11.44	Peak
2	163.65	-56.42	-49.14	-13.00	-43.42	-7.28	Peak
3	246.81	-68.05	-62.50	-13.00	-55.05	-5.55	Peak
4	387.50	-70.80	-67.44	-13.00	-57.80	-3.36	Peak
5	588.40	-68.83	-68.78	-13.00	-55.83	-0.05	Peak
6	806.80	-67.06	-68.99	-13.00	-54.06	1.93	Peak
7	1415.00	-56.56	-62.92	-13.00	-43.56	6.36	Peak
8 pp	2122.50	-49.84	-60.95	-13.00	-36.84	11.11	Peak



A D T

LTE BAND 17
CHANNEL BANDWIDTH: 10MHz / QPSK



Bureau Veritas Consumer Products Services Ltd., Taoyuan Branch

A D T

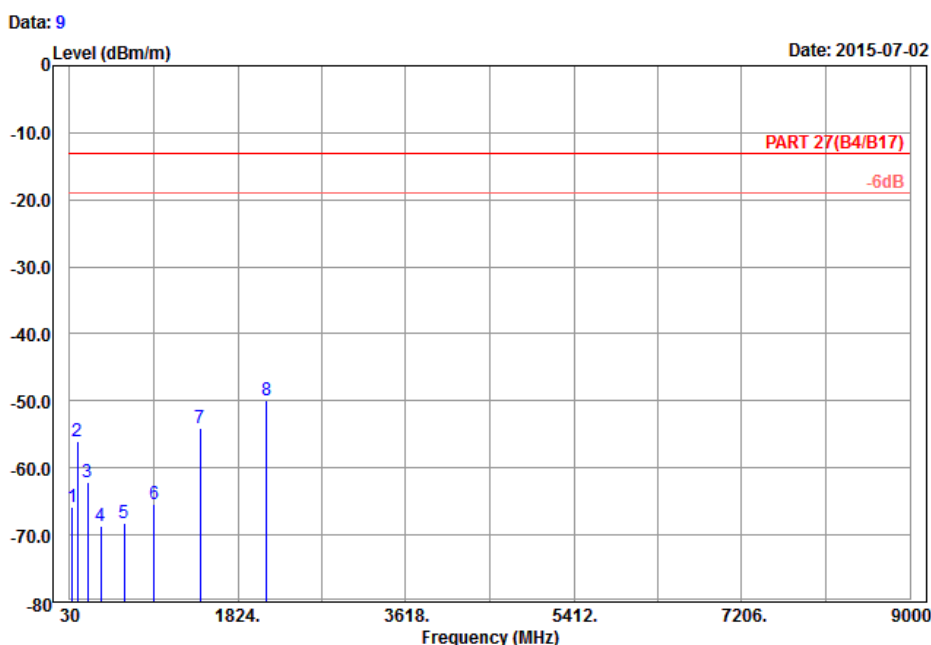

Site : 966 chamber 1
 Condition: PART 27(B4/B17) 3m Horizontal
 Remark : LTE_Band 17_QPSK(1,0)_10M_CH23790
 Tested by: Harry Hsueh
 Plane : Y

	Read	Limit	Over			
Freq	Level	Level	Line	Limit	Factor	Remark
MHz	dBm/m	dBm	dBm/m	dB	dB/m	
1	59.97 -65.91	-51.84	-13.00	-52.91	-14.07	Peak
2	110.73 -56.06	-47.18	-13.00	-43.06	-8.88	Peak
3	218.19 -62.05	-56.11	-13.00	-49.05	-5.94	Peak
4	358.10 -68.62	-63.66	-13.00	-55.62	-4.96	Peak
5	614.30 -68.31	-68.58	-13.00	-55.31	0.27	Peak
6	927.20 -65.43	-69.54	-13.00	-52.43	4.11	Peak
7	1420.00 -54.12	-60.48	-13.00	-41.12	6.36	Peak
8 pp	2130.00 -49.88	-61.16	-13.00	-36.88	11.28	Peak



A D T



Bureau Veritas Consumer Products Services Ltd., Taoyuan Branch

A D T

Data: 10

Date: 2015-07-02

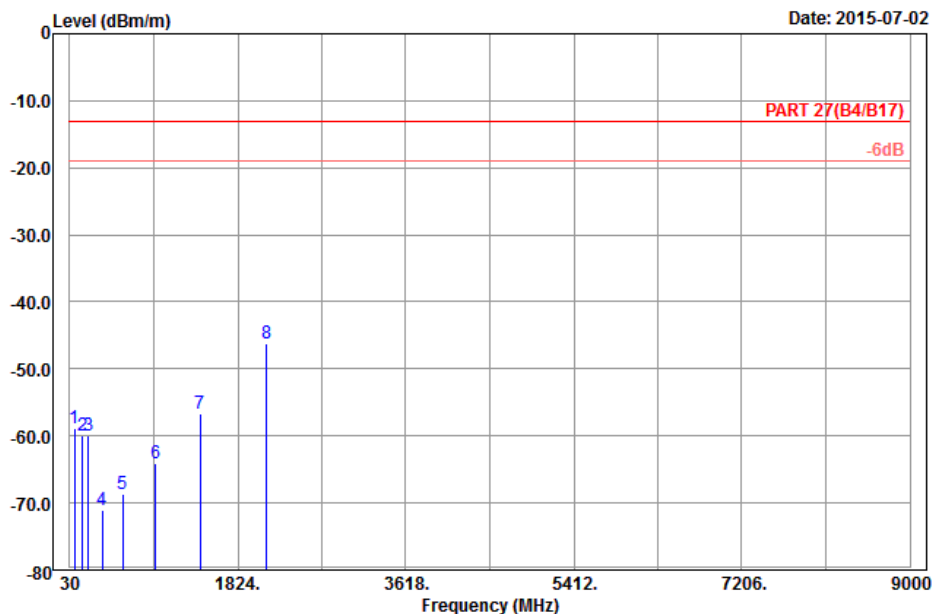

Site : 966 chamber 1
 Condition: PART 27(B4/B17) 3m Vertical
 Remark : LTE_Band 17_QPSK(1,0)_10M_CH23790
 Tested by: Harry Hsueh
 Plane : Y

	Freq	Level	Read Level	Limit Line	Over Limit	Factor	Remark
	MHz	dBm/m	dBm	dBm/m	dB	dB/m	
1	83.73	-58.78	-47.34	-13.00	-45.78	-11.44	Peak
2	163.38	-59.86	-52.58	-13.00	-46.86	-7.28	Peak
3	225.48	-59.98	-54.15	-13.00	-46.98	-5.83	Peak
4	377.00	-71.09	-67.16	-13.00	-58.09	-3.93	Peak
5	591.90	-68.58	-68.65	-13.00	-55.58	0.07	Peak
6	945.40	-64.18	-69.11	-13.00	-51.18	4.93	Peak
7	1420.00	-56.58	-62.94	-13.00	-43.58	6.36	Peak
8 pp	2130.00	-46.30	-57.58	-13.00	-33.30	11.28	Peak



5 INFORMATION ON THE TESTING LABORATORIES

We, Bureau Veritas Consumer Products Services (H.K.) Ltd., Taoyuan Branch, were founded in 1988 to provide our best service in EMC, Radio, Telecom and Safety consultation. Our laboratories are accredited and approved according to ISO/IEC 17025.

If you have any comments, please feel free to contact us at the following:

Linko EMC/RF Lab:

Tel: 886-2-26052180

Fax: 886-2-26051924

Hsin Chu EMC/RF/Telecom Lab:

Tel: 886-3-5935343

Fax: 886-3-5935342

Hwa Ya EMC/RF/Safety Lab:

Tel: 886-3-3183232

Fax: 886-3-3270892

Email: service.adt@tw.bureauveritas.com

Web Site: www.adt.com.tw

The address and road map of all our labs can be found in our web site also.



A D T

6 APPENDIX A – MODIFICATIONS RECORDERS FOR ENGINEERING CHANGES TO THE EUT BY THE LAB

No modifications were made to the EUT by the lab during the test.

---END---