



FCC TEST REPORT (PART 27)

REPORT NO.: RF140221C18-2
MODEL NO.: E6782
FCC ID: V65E6782
RECEIVED: Feb. 21, 2014
TESTED: Mar. 10, 2014 ~ Mar. 13, 2014
ISSUED: Mar. 20, 2014

APPLICANT: Kyocera Corporation c/o Kyocera Communications, Inc.

ADDRESS: 9520 Towne Centre Drive, Suite #200, San Diego, CA 92121

ISSUED BY: Bureau Veritas Consumer Products Services
(H.K.) Ltd., Taoyuan Branch

LAB ADDRESS: No. 47, 14th Ling, Chia Pau Vil., Lin Kou Dist.,
New Taipei City, Taiwan, R.O.C.

TEST LOCATION: No. 19, Hwa Ya 2nd Rd, Wen Hwa Tsuen, Kwei
Shan Hsiang, Taoyuan Hsien 333, Taiwan, R.O.C.

This report should not be used by the client to claim product certification, approval, or endorsement by TAF or any government agencies.



This report is for your exclusive use. Any copying or replication of this report to or for any other person or entity, or use of our name or trademark, is permitted only with our prior written permission. This report sets forth our findings solely with respect to the test samples identified herein. The results set forth in this report are not indicative or representative of the quality or characteristics of the lot from which a test sample was taken or any similar or identical product unless specifically and expressly noted. Our report includes all of the tests requested by you and the results thereof based upon the information that you provided to us. You have 60 days from date of issuance of this report to notify us of any material error or omission caused by our negligence, provided, however, that such notice shall be in writing and shall specifically address the issue you wish to raise. A failure to raise such issue within the prescribed time shall constitute your unqualified acceptance of the completeness of this report, the tests conducted and the correctness of the report contents. Unless specifically mentioned, the uncertainty of measurement has been explicitly taken into account to declare the compliance or non-compliance to the specification.



TABLE OF CONTENTS

RELEASE CONTROL RECORD.....	3
1 CERTIFICATION	4
2 SUMMARY OF TEST RESULTS.....	5
2.1 MEASUREMENT UNCERTAINTY	6
2.2 TEST SITE AND INSTRUMENTS	7
3 GENERAL INFORMATION	8
3.1 GENERAL DESCRIPTION OF EUT.....	8
3.2 CONFIGURATION OF SYSTEM UNDER TEST	9
3.3 DESCRIPTION OF SUPPORT UNITS.....	9
3.4 DESCRIPTION OF TEST MODES.....	10
3.5 GENERAL DESCRIPTION OF APPLIED STANDARDS	12
4 TEST TYPES AND RESULTS.....	13
4.1 OUTPUT POWER MEASUREMENT	13
4.1.1 LIMITS OF OUTPUT POWER MEASUREMENT	13
4.1.2 TEST PROCEDURES.....	13
4.1.3 TEST SETUP	14
4.1.4 TEST RESULTS	15
4.2 FREQUENCY STABILITY MEASUREMENT	20
4.2.1 LIMITS OF FREQUENCY STABILITY MEASUREMENT	20
4.2.2 TEST PROCEDURE	20
4.2.3 TEST SETUP	20
4.2.4 TEST RESULTS	21
4.3 OCCUPIED BANDWIDTH MEASUREMENT.....	22
4.3.1 LIMITS OF OCCUPIED BANDWIDTH MEASUREMENT.....	22
4.3.2 TEST SETUP	22
4.3.3 TEST PROCEDURES.....	22
4.3.4 TEST RESULTS	23
4.4 PEAK TO AVERAGE RATIO.....	26
4.4.1 LIMITS OF PEAK TO AVERAGE RATIO MEASUREMENT	26
4.4.2 TEST SETUP	26
4.4.3 TEST PROCEDURES.....	26
4.4.4 TEST RESULTS	27
4.5 BAND EDGE MEASUREMENT	30
4.5.1 LIMITS OF BAND EDGE MEASUREMENT	30
4.5.2 TEST SETUP	30
4.5.3 TEST PROCEDURES.....	30
4.5.4 TEST RESULTS	31
4.6 CONDUCTED SPURIOUS EMISSIONS.....	36
4.6.1 LIMITS OF CONDUCTED SPURIOUS EMISSIONS MEASUREMENT.....	36
4.6.2 TEST PROCEDURE	36
4.6.3 TEST SETUP	36
4.6.4 TEST RESULTS	36
4.7 RADIATED EMISSION MEASUREMENT	38
4.7.1 LIMITS OF RADIATED EMISSION MEASUREMENT	38
4.7.2 TEST PROCEDURES.....	38
4.7.3 DEVIATION FROM TEST STANDARD.....	38
4.7.4 TEST SETUP	39
4.7.5 TEST RESULTS	40
5 INFORMATION ON THE TESTING LABORATORIES	52
6 APPENDIX A – MODIFICATIONS RECORDERS FOR ENGINEERING CHANGES TO THE EUT BY THE LAB.....	53



A D T

RELEASE CONTROL RECORD

ISSUE NO.	REASON FOR CHANGE	DATE ISSUED
RF140221C18-2	Original release	Mar. 20, 2014



1 CERTIFICATION

PRODUCT: PDA Phone
MODEL NO.: E6782
BRAND: KYOCERA
APPLICANT: Kyocera Corporation c/o Kyocera Communications, Inc.
TESTED: Mar. 10, 2014 ~ Mar. 13, 2014
TEST SAMPLE: Identical Prototype
TEST STANDARDS: **FCC Part 27, Subpart C, L**
FCC Part 2
ANSI C63.4-2003

The above equipment (model: E6782) has been tested by **Bureau Veritas Consumer Products Services (H.K.) Ltd., Taoyuan Branch**, and found compliance with the requirement of the above standards. The test record, data evaluation & Equipment Under Test (EUT) configurations represented herein are true and accurate accounts of the measurements of the sample's EMC characteristics under the conditions specified in this report.

PREPARED BY : Vera Huang , **DATE:** Mar. 20, 2014
Vera Huang / Specialist
APPROVED BY : Sam chen , **DATE:** Mar. 20, 2014
Sam Chen / Senior Project Engineer

2 SUMMARY OF TEST RESULTS

The EUT has been tested according to the following specifications:

LTE BAND 13			
STANDARD SECTION	TEST TYPE AND LIMIT	RESULT	REMARK
2.1046 27.50(C)(10)	Maximum Peak Output Power	PASS	Meet the requirement of limit.
2.1055 27.54	Frequency Stability	PASS	Meet the requirement of limit.
2.1049 27.53(g)	Occupied Bandwidth	PASS	Meet the requirement of limit.
27.50(d)(5)	Peak to Average Ratio	PASS	Meet the requirement of limit.
27.53(g)	Band Edge Measurements	PASS	Meet the requirement of limit.
2.1051 27.53(g)	Conducted Spurious Emissions	PASS	Meet the requirement of limit.
2.1053 27.53(g)	Radiated Spurious Emissions	PASS	Meet the requirement of limit. Minimum passing margin is -15.36dB at 1564.00MHz.

LTE Band 4			
STANDARD SECTION	TEST TYPE AND LIMIT	RESULT	REMARK
2.1046 27.50(d)(4)	Maximum Peak Output Power	PASS	Meet the requirement of limit.
2.1055 27.54	Frequency Stability	PASS	Meet the requirement of limit.
2.1049 27.53(h)	Occupied Bandwidth	PASS	Meet the requirement of limit.
27.50(d)(5)	Peak to Average Ratio	PASS	Meet the requirement of limit.
27.53(h)	Band Edge Measurements	PASS	Meet the requirement of limit.
2.1051 27.53(h)	Conducted Spurious Emissions	PASS	Meet the requirement of limit.
2.1053 27.53(h)	Radiated Spurious Emissions	PASS	Meet the requirement of limit. Minimum passing margin is -18.89dB at 3465.00MHz.

2.1 MEASUREMENT UNCERTAINTY

Where relevant, the following measurement uncertainty levels have been estimated for tests performed on the EUT as specified in CISPR 16-4-2:

MEASUREMENT	FREQUENCY	UNCERTAINTY
Conducted emissions	150kHz~30MHz	2.44 dB
Radiated emissions	30MHz ~ 200MHz	2.93 dB
	200MHz ~1000MHz	2.95 dB
	1GHz ~ 18GHz	2.26 dB
	18GHz ~ 40GHz	1.94 dB

This uncertainty represents an expanded uncertainty expressed at approximately the 95% confidence level using a coverage factor of $k=2$.



2.2 TEST SITE AND INSTRUMENTS

DESCRIPTION & MANUFACTURER	MODEL NO.	SERIAL NO.	DATE OF CALIBRATION	DUE DATE OF CALIBRATION
Test Receiver ROHDE & SCHWARZ	ESCI	100744	Apr. 15, 2013	Apr. 14, 2014
Spectrum Analyzer ROHDE & SCHWARZ	FSU43	101261	Dec. 21, 2013	Dec. 20, 2014
BILOG Antenna SCHWARZBECK	VULB9168	9168-472	Mar. 25, 2013	Mar. 24, 2014
HORN Antenna SCHWARZBECK	BBHA 9120 D	9120D- 209	Sep. 12, 2013	Sep. 11, 2014
HORN Antenna SCHWARZBECK	BBHA 9170	9170-480	Dec. 18, 2013	Dec. 17, 2014
Loop Antenna	3127-836	00099258	Aug. 09, 2013	Aug. 08, 2014
Preamplifier EMCI	EMC 012645	980115	Dec. 26, 2013	Dec. 25, 2014
Preamplifier EMCI	EMC 184045	980116	Jan. 13, 2014	Jan. 12, 2015
Preamplifier EMCI	EMC 330H	980112	Dec. 27, 2013	Dec. 26, 2014
RF signal cable HUBER+SUHNNER	SUCOFLEX 104	309219/4 2950114	Oct. 18, 2013	Oct. 17, 2014
RF signal cable HUBER+SUHNNER	SUCOFLEX 104	250130/4	Oct. 18, 2013	Oct. 17, 2014
RF signal cable Worken	RG-213	NA	Nov. 07, 2013	Nov. 06, 2014
Software BV ADT	E3 6.120103	NA	NA	NA
Antenna Tower MF	MFA-440H	NA	NA	NA
Turn Table MF	MFT-201SS	NA	NA	NA
Antenna Tower & Turn Table Controller MF	MF-7802	NA	NA	NA
Mini-Circuits Power Splitter	ZN2PD-9G	NA	Jul. 18, 2013	Jul. 17, 2014
JFW 20dB attenuation	50HF-020-SMA	NA	NA	NA
Communications Tester-Wireless	E5515C	MY52102544	Sep. 05, 2012	Sep. 04, 2014
Radio Communication Analyzer	MT8820C	6201300640	Aug. 01, 2013	Jul. 31, 2014

- NOTE:** 1. The calibration interval of the above test instruments is 12 months and the calibrations are traceable to NML/ROC and NIST/USA.
2. The test was performed in HwaYa Chamber 10.
3. The horn antenna and HP preamplifier (model: 8449B) are used only for the measurement of emission frequency above 1GHz if tested.
4. The FCC Site Registration No. is 690701.
5. The IC Site Registration No. is IC 7450F-10.



3 GENERAL INFORMATION

3.1 GENERAL DESCRIPTION OF EUT

PRODUCT	PDA Phone	
MODEL NO.	E6782	
POWER SUPPLY	5Vdc (adapter or host equipment) 3.8Vdc (battery)	
MODULATION TECHNOLOGY	LTE Band 13	QPSK, 16QAM
	LTE Band 4	QPSK, 16QAM
FREQUENCY RANGE	LTE Band 13 Channel Bandwidth: 10MHz	782.0MHz
	LTE Band 4 Channel Bandwidth: 5MHz	1712.5MHz ~1752.5MHz
	LTE Band 4 Channel Bandwidth: 10MHz	1715.0MHz ~1750.0MHz
	LTE Band 4 Channel Bandwidth: 15MHz	1717.5MHz ~1747.5MHz
	LTE Band 4 Channel Bandwidth: 20MHz	1720.0MHz ~1745.0MHz
EMISSION DESIGNATOR	LTE Band 13 Channel Bandwidth: 10MHz	8M88G7D
	LTE Band 4 Channel Bandwidth: 5MHz	4M49G7D
	LTE Band 4 Channel Bandwidth: 10MHz	8M92G7D
	LTE Band 4 Channel Bandwidth: 15MHz	13M4G7D
	LTE Band 4 Channel Bandwidth: 20MHz	17M8W7D
MAX. ERP POWER	LTE Band 13 Channel Bandwidth: 10MHz	87.64mW
MAX. EIRP POWER	LTE Band 4 Channel Bandwidth: 5MHz	309.88mW
	LTE Band 4 Channel Bandwidth: 10MHz	306.90mW
	LTE Band 4 Channel Bandwidth: 15MHz	319.23mW
	LTE Band 4 Channel Bandwidth: 20MHz	313.33mW
ANTENNA TYPE	Fixed Internal Antenna	
DATA CABLE	Refer to Note as below	
I/O PORTS	Refer to users' manual	
ACCESSORY DEVICES	Refer to Note as below	

NOTE:

1. The EUT contains following accessory devices.

ITEM	BRAND	MODEL	SPECIFICATION
Adapter	Kyocera	SCP-43ADT	I/P: 100-240Vac, 50/60Hz, 300mA O/P: 5Vdc, 1500mA
Battery	Kyocera	SCP-60LBPS	3.8Vdc, 3000Ah
USB Cable	Kyocera	SCP-15SDC	1.2m cable

2. The above EUT information was declared by manufacturer and for more detailed features description, please refer to the manufacturer's specifications or User's Manual.

3.2 CONFIGURATION OF SYSTEM UNDER TEST

FOR RADIATION EMISSION TEST

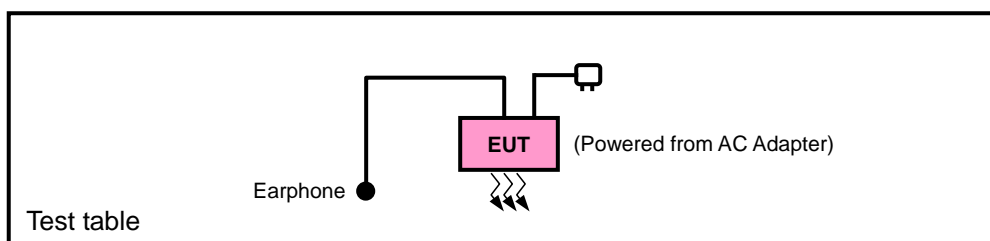

FOR E.R.P. / E.I.R.P. TEST

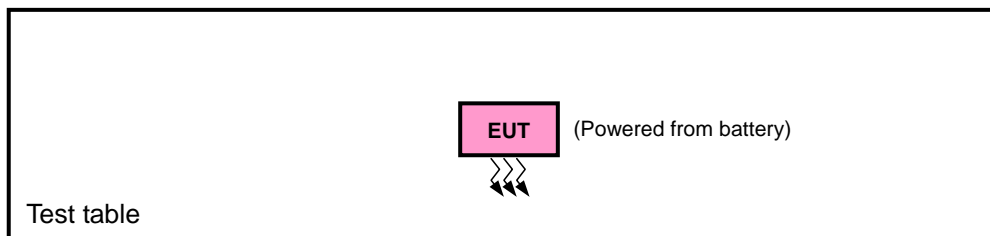

3.3 DESCRIPTION OF SUPPORT UNITS

The EUT has been tested as an independent unit together with other necessary accessories or support units. The following support units or accessories were used to form a representative test configuration during the tests.

NO.	PRODUCT	BRAND	MODEL NO.	SERIAL NO.	FCC ID
1	Earphone	N/A	N/A	N/A	N/A

NO.	SIGNAL CABLE DESCRIPTION OF THE ABOVE SUPPORT UNITS
1	N/A

NOTE:

1. All power cords of the above support units are non shielded (1.8m).



3.4 DESCRIPTION OF TEST MODES

Pre-Scan has been conducted to determine the worst-case mode from all possible combinations between available modulations, data rates, XYZ axis and antenna ports. The worst case for ERP/EIRP and radiated emission were listed as below. Following channel(s) was (were) selected for the final test as listed below:

	BAND	AXIS FOR RADIATED EMISSION
ERP	LTE Band 13	X
EIRP	LTE Band 4	X
RADIATED EMISSION	LTE Band 13	Z
	LTE Band 4	Y

LTE Band 13

EUT CONFIGURE MODE	TEST ITEM	AVAILABLE CHANNEL	TESTED CHANNEL	CHANNEL BANDWIDTH	MODULATION	MODE
-	ERP	23230	23230	10MHz	QPSK, 16QAM	1 RB / 24 RB Offset
-	FREQUENCY STABILITY	23230	23230	10MHz	QPSK	1 RB / 24 RB Offset
-	OCCUPIED BANDWIDTH	23230	23230	10MHz	QPSK, 16QAM	25 RB / 0 RB Offset
-	PEAK TO AVERAGE RATIO	23230	23230	10MHz	QPSK, 16QAM	1 RB / 0 RB Offset
-	BAND EDGE	23230	23230	10MHz	QPSK	1 RB / 0 RB Offset
			23230	10MHz	QPSK	50 RB / 0 RB Offset
			23230	10MHz	QPSK	1 RB / 49 RB Offset
-	CONDCUDETED EMISSION	23230	23230	10MHz	QPSK	50 RB / 0 RB Offset
-	RADIATED EMISSION	23230	23230	10MHz	QPSK	1 RB / 0 RB Offset
						24 RB / 0 RB Offset
						50 RB / 0 RB Offset

Note: This device was tested under all bandwidths, RB configurations and modulations. The worst case was found in QPSK modulation.



LTE Band 4

EUT CONFIGURE MODE	TEST ITEM	AVAILABLE CHANNEL	TESTED CHANNEL	CHANNEL BANDWIDTH	MODULATION	MODE
-	EIRP	19975 to 20375	19975, 20175, 20375	5MHz	QPSK, 16QAM	1 RB / 12 RB Offset
		20000 to 20350	20000, 20175, 20350	10MHz	QPSK, 16QAM	1 RB / 24 RB Offset
		20025 to 20325	20025, 20175, 20325	15MHz	QPSK, 16QAM	1 RB / 37 RB Offset
		20050 to 20300	20050, 20175, 20300	20MHz	QPSK, 16QAM	1 RB / 50 RB Offset
-	FREQUENCY STABILITY	19975 to 20375	20175	5MHz	QPSK	1 RB / 12 RB Offset
		20000 to 20350	20175	10MHz	QPSK	1 RB / 24 RB Offset
		20025 to 20325	20175	15MHz	QPSK	1 RB / 37 RB Offset
		20050 to 20300	20175	20MHz	QPSK	1 RB / 50 RB Offset
-	OCCUPIED BANDWIDTH	19975 to 20375	19975, 20175, 20375	5MHz	QPSK, 16QAM	25 RB / 0 RB Offset
		20000 to 20350	20000, 20175, 20350	10MHz	QPSK, 16QAM	50 RB / 0 RB Offset
		20025 to 20325	20025, 20175, 20325	15MHz	QPSK, 16QAM	75 RB / 0 RB Offset
		20050 to 20300	20050, 20175, 20300	20MHz	QPSK, 16QAM	100 RB / 0 RB Offset
-	PEAK TO AVERAGE RATIO	19975 to 20375	19975, 20175, 20375	5MHz	QPSK, 16QAM	1 RB / 0 RB Offset
		20000 to 20350	20000, 20175, 20350	10MHz	QPSK, 16QAM	1 RB / 0 RB Offset
		20025 to 20325	20025, 20175, 20325	15MHz	QPSK, 16QAM	1 RB / 0 RB Offset
		20050 to 20300	20050, 20175, 20300	20MHz	QPSK, 16QAM	1 RB / 0 RB Offset
-	BAND EDGE	19975 to 20375	19975	5MHz	QPSK	1 RB / 0 RB Offset
			20375	5MHz	QPSK	25 RB / 0 RB Offset
		20000 to 20350	20000	10MHz	QPSK	1 RB / 24 RB Offset
			20350	10MHz	QPSK	25 RB / 0 RB Offset
		20025 to 20325	20025	15MHz	QPSK	1 RB / 0 RB Offset
			20325	15MHz	QPSK	50 RB / 0 RB Offset
		20050 to 20300	20025	15MHz	QPSK	1 RB / 49 RB Offset
			20325	15MHz	QPSK	50 RB / 0 RB Offset
		20050 to 20300	20025	15MHz	QPSK	1 RB / 0 RB Offset
			20325	15MHz	QPSK	75 RB / 0 RB Offset
			20050	20MHz	QPSK	1 RB / 74 RB Offset
			20300	20MHz	QPSK	75 RB / 0 RB Offset
-	CONDCUDED EMISSION	19975 to 20375	20175	5MHz	QPSK	1 RB / 0 RB Offset
		20000 to 20350	20175	10MHz	QPSK	1 RB / 0 RB Offset
		20025 to 20325	20175	15MHz	QPSK	1 RB / 0 RB Offset
		20050 to 20300	20175	20MHz	QPSK	1 RB / 0 RB Offset
-	RADIATED EMISSION	19975 to 20375	20175	5MHz	QPSK	1 RB / 12 RB Offset
		20000 to 20350	20175	10MHz	QPSK	1 RB / 24 RB Offset
		20025 to 20325	20175	15MHz	QPSK	1 RB / 37 RB Offset
		20050 to 20300	20175	20MHz	QPSK	1 RB / 50 RB Offset

Note: This device was tested under all bandwidths, RB configurations and modulations. The worst case was found in QPSK modulation.



A D T

TEST CONDITION:

TEST ITEM	ENVIRONMENTAL CONDITIONS	INPUT POWER	TESTED BY
ERP/EIRP	26deg. C, 58%RH	3.8Vdc	Howard Kao
FREQUENCY STABILITY	26deg. C, 58%RH	3.8Vdc	Howard Kao
OCCUPIED BANDWIDTH	26deg. C, 58%RH	3.8Vdc	Howard Kao
PEAK TO AVERAGE RATIO	26deg. C, 58%RH	3.8Vdc	Howard Kao
BAND EDGE	26deg. C, 58%RH	3.8Vdc	Howard Kao
CONDCUDED EMISSION	26deg. C, 58%RH	3.8Vdc	Howard Kao
RADIATED EMISSION	25deg. C, 65%RH	120Vac, 60Hz	Kay Wu

3.5 GENERAL DESCRIPTION OF APPLIED STANDARDS

The EUT is a RF product. According to the specifications of the manufacturer, it must comply with the requirements of the following standards:

FCC 47 CFR Part 2

FCC 47 CFR Part 27

ANSI C63.4-2003

ANSI/TIA/EIA-603-C 2004

NOTE: All test items have been performed and recorded as per the above standards.

4 TEST TYPES AND RESULTS

4.1 OUTPUT POWER MEASUREMENT

4.1.1 LIMITS OF OUTPUT POWER MEASUREMENT

Fixed, mobile, and portable (hand-held) stations operating in the 1710–1755 MHz band are limited to 1 watt EIRP.

Portable stations (hand-held devices) operating in the 777-787 MHz band are limited to 3 watts ERP

4.1.2 TEST PROCEDURES

EIRP MEASUREMENT:

- a. All measurements were done at low, middle and high operational frequency range. RBW and VBW is 1MHz for GSM, GPRS & EDGE, 5MHz for CDMA & WCDMA, and 10MHz for LTE mode.
- b. Substitution method is used for E.I.R.P measurement. In the semi-anechoic chamber, EUT placed on the 0.8m height of Turn Table, rotated the table around 360 degrees to search the maximum radiation power and receiver antenna shall be rotated vertical and horizontal polarization and moved height from 1m to 4m to find the maximum polar radiated power. The “Read Value” is the spectrum reading the maximum power value.
- c. The substitution horn antenna is substituted for EUT at the same position and signals generator export the CW signal to the substitution antenna via a tx cable. Rotated the Turn Table and moved receiving antenna to find the maximum radiation power. Adjust output power level of S.G to get a Value of spectrum reading equal to “Read Value” of step b. Record the power level of S.G
- d. $EIRP = \text{Output power level of S.G} - \text{TX cable loss} + \text{Antenna gain of substitution horn}.$

CONDUCTED POWER MEASUREMENT:

- a. The EUT was set up for the maximum power with LTE link data modulation and link up with simulator.
- b. Set the EUT to transmit under low, middle and high channel and record the power level shown on simulator.

4.1.3 TEST SETUP

EIRP / ERP MEASUREMENT:

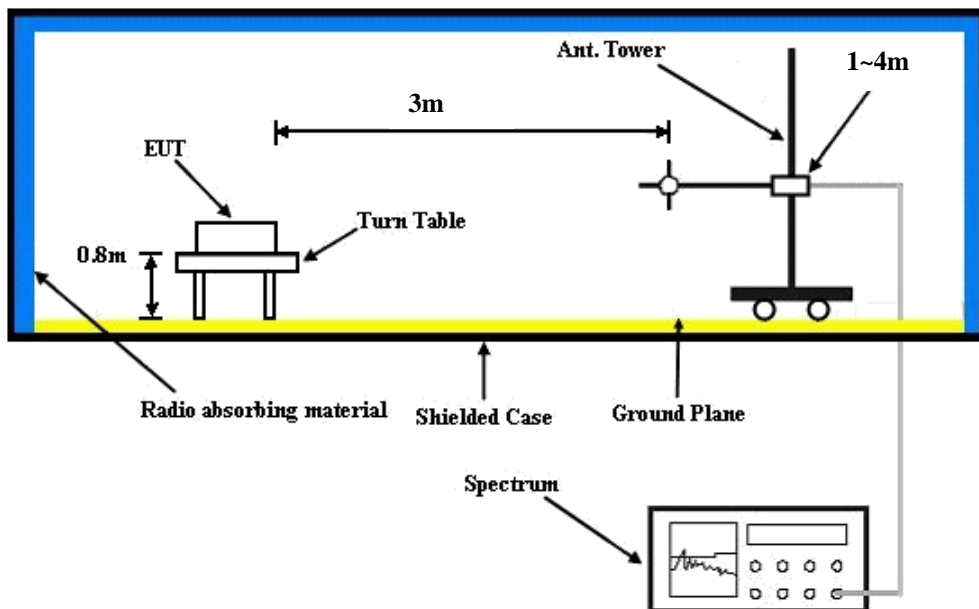

CONDUCTED POWER MEASUREMENT:





4.1.4 TEST RESULTS

Average Conducted Output Power (dBm)

Band / BW	RB Size	RB Offset	QPSK		3GPP MPR (dB)	16QAM		3GPP MPR (dB)
			Mid CH 23230			Mid CH 23230		
			782.0 MHz			782.0 MHz		
13 / 10M	1	0	23.93		0	22.90		1
	1	24	24.05		0	23.02		1
	1	49	23.90		0	22.87		1
	25	0	23.09		1	22.01		2
	25	12	23.07		1	22.09		2
	25	25	23.10		1	22.07		2
	50	0	23.02		1	22.09		2

Band / BW	RB Size	RB Offset	QPSK			3GPP MPR (dB)	16QAM			3GPP MPR (dB)
			Low CH 19975	Mid CH 20175	High CH 20375		Low CH 19975	Mid CH 20175	High CH 20375	
			1712.5 MHz	1732.5 MHz	1752.5 MHz		1712.5 MHz	1732.5 MHz	1752.5 MHz	
4 / 5M	1	0	24.09	24.12	24.05	0	23.07	23.10	23.03	1
	1	12	24.04	24.22	23.94	0	23.02	23.20	22.92	1
	1	24	23.91	24.07	23.89	0	22.89	23.05	22.87	1
	12	0	23.23	23.26	23.17	1	22.21	22.24	22.15	2
	12	6	23.27	23.28	23.12	1	22.25	22.21	22.10	2
	12	13	23.19	23.24	23.16	1	22.17	22.22	22.14	2
	25	0	23.19	23.26	23.17	1	22.17	22.24	22.15	2

Band / BW	RB Size	RB Offset	QPSK			3GPP MPR (dB)	16QAM			3GPP MPR (dB)
			Low CH 20000	Mid CH 20175	High CH 20350		Low CH 20000	Mid CH 20175	High CH 20350	
			1715.0 MHz	1732.5 MHz	1750.0 MHz		1715.0 MHz	1732.5 MHz	1750.0 MHz	
4 / 10M	1	0	24.10	24.13	24.06	0	23.08	23.11	23.04	1
	1	24	24.05	24.23	23.95	0	23.03	23.21	22.93	1
	1	49	23.92	24.08	23.90	0	22.90	23.06	22.88	1
	25	0	23.24	23.27	23.18	1	22.22	22.25	22.16	2
	25	12	23.28	23.22	23.13	1	22.26	22.27	22.11	2
	25	25	23.20	23.25	23.17	1	22.18	22.23	22.15	2
	50	0	23.20	23.27	23.18	1	22.18	22.25	22.16	2



A D T

Band / BW	RB Size	RB Offset	QPSK			3GPP MPR (dB)	16QAM			3GPP MPR (dB)
			Low CH 20025	Mid CH 20175	High CH 20325		Low CH 20025	Mid CH 20175	High CH 20325	
			1717.5 MHz	1732.5 MHz	1747.5 MHz		1717.5 MHz	1732.5 MHz	1747.5 MHz	
4 / 15M	1	0	24.14	24.17	24.10	0	23.12	23.15	23.08	1
	1	37	24.09	24.27	23.99	0	23.07	23.25	22.97	1
	1	74	23.96	24.12	23.94	0	22.94	23.10	22.92	1
	36	0	23.28	23.24	23.22	1	22.26	22.29	22.20	2
	36	19	23.26	23.22	23.17	1	22.30	22.22	22.15	2
	36	39	23.24	23.29	23.21	1	22.22	22.27	22.19	2
	75	0	23.24	23.21	23.22	1	22.22	22.29	22.20	2

Band / BW	RB Size	RB Offset	QPSK			3GPP MPR (dB)	16QAM			3GPP MPR (dB)
			Low CH 20050	Mid CH 20175	High CH 20300		Low CH 20050	Mid CH 20175	High CH 20300	
			1720.0 MHz	1732.5 MHz	1745.0 MHz		1720.0 MHz	1732.5 MHz	1745.0 MHz	
4 / 20M	1	0	24.16	24.19	24.12	0	23.14	23.17	23.10	1
	1	50	24.11	24.29	24.01	0	23.09	23.27	22.99	1
	1	99	23.98	24.14	23.96	0	22.96	23.12	22.94	1
	50	0	23.25	23.27	23.24	1	22.28	22.24	22.22	2
	50	25	23.20	23.12	23.19	1	22.27	22.28	22.17	2
	50	50	23.26	23.22	23.23	1	22.24	22.29	22.21	2
	100	0	23.26	23.26	23.24	1	22.24	22.29	22.22	2



A D T

AVERAGE ERP (dBm)

LTE Band 13							
Channel Bandwidth: 10MHz / QPSK							
Plane	Channel	Frequency (MHz)	LVL (dBm)	Correction Factor(dB)	ERP(dBm)	ERP(mW)	Polarization (H/V)
X	23230	782.0	-11.16	32.737	19.43	87.64	H
	23230	782.0	-16.55	32.52	13.82	24.10	V

LTE Band 13							
Channel Bandwidth: 10MHz / 16QAM							
Plane	Channel	Frequency (MHz)	LVL (dBm)	Correction Factor(dB)	ERP(dBm)	ERP(mW)	Polarization (H/V)
X	23230	782.0	-11.95	32.737	18.64	73.06	H
	23230	782.0	-17.36	32.52	13.01	20.00	V

AVERAGE EIRP (dBm)

LTE Band 4							
Channel Bandwidth: 5MHz / QPSK							
Plane	Channel	Frequency (MHz)	LVL (dBm)	Correction Factor(dB)	EIRP(dBm)	EIRP(mW)	Polarization (H/V)
X	19975	1712.5	-17.75	42.46	24.71	295.67	H
	20175	1732.5	-17.38	42.29	24.91	309.88	
	20375	1752.5	-18.72	42.96	24.24	265.64	
	19975	1712.5	-21.65	42.73	21.08	128.17	V
	20175	1732.5	-21.94	42.74	20.80	120.23	
	20375	1752.5	-21.86	42.30	20.44	110.66	

LTE Band 4							
Channel Bandwidth: 5MHz / 16QAM							
Plane	Channel	Frequency (MHz)	LVL (dBm)	Correction Factor(dB)	EIRP(dBm)	EIRP(mW)	Polarization (H/V)
X	19975	1712.5	-18.96	42.46	23.50	223.77	H
	20175	1732.5	-18.42	42.29	23.87	243.89	
	20375	1752.5	-19.69	42.96	23.27	212.47	
	19975	1712.5	-21.78	42.73	20.95	124.39	V
	20175	1732.5	-22.21	42.74	20.53	112.98	
	20375	1752.5	-22.76	42.30	19.54	89.95	



A D T

LTE Band 4							
Channel Bandwidth: 10MHz / QPSK							
Plane	Channel	Frequency (MHz)	LVL (dBm)	Correction Factor(dB)	EIRP(dBm)	EIRP(mW)	Polarization (H/V)
X	20000	1715.0	-18.03	42.69	24.66	292.48	H
	20175	1732.5	-17.42	42.29	24.87	306.90	
	20350	1750.0	-17.60	42.01	24.41	276.18	
	20000	1715.0	-20.71	42.09	21.38	137.40	V
	20175	1732.5	-21.13	42.74	21.61	144.88	
	20350	1750.0	-21.35	42.09	20.74	118.58	

LTE Band 4							
Channel Bandwidth: 10MHz / 16QAM							
Plane	Channel	Frequency (MHz)	LVL (dBm)	Correction Factor(dB)	EIRP(dBm)	EIRP(mW)	Polarization (H/V)
X	20000	1715.0	-18.92	42.69	23.77	238.29	H
	20175	1732.5	-18.90	42.29	23.39	218.27	
	20350	1750.0	-18.68	42.01	23.33	215.38	
	20000	1715.0	-21.54	42.09	20.55	113.50	V
	20175	1732.5	-22.14	42.74	20.60	114.82	
	20350	1750.0	-22.46	42.09	19.63	91.83	

LTE Band 4							
Channel Bandwidth: 15MHz / QPSK							
Plane	Channel	Frequency (MHz)	LVL (dBm)	Correction Factor(dB)	EIRP(dBm)	EIRP(mW)	Polarization (H/V)
X	20025	1717.5	-17.65	42.69	25.04	319.23	H
	20175	1732.5	-17.26	42.29	25.03	318.42	
	20325	1747.5	-17.45	42.01	24.56	285.89	
	20025	1717.5	-20.54	42.09	21.55	142.89	V
	20175	1732.5	-21.26	42.74	21.48	140.60	
	20325	1747.5	-20.67	42.09	21.42	138.68	



LTE Band 4							
Channel Bandwidth: 15MHz / 16QAM							
Plane	Channel	Frequency (MHz)	LVL (dBm)	Correction Factor(dB)	EIRP(dBm)	EIRP(mW)	Polarization (H/V)
X	20025	1717.5	-18.86	42.69	23.83	241.60	H
	20175	1732.5	-18.57	42.29	23.72	235.50	
	20325	1747.5	-18.69	42.01	23.32	214.88	
	20025	1717.5	-21.50	42.09	20.59	114.55	V
	20175	1732.5	-22.31	42.74	20.43	110.41	
	20325	1747.5	-21.79	42.09	20.30	107.15	

LTE Band 4							
Channel Bandwidth: 20MHz / QPSK							
Plane	Channel	Frequency (MHz)	LVL (dBm)	Correction Factor(dB)	EIRP(dBm)	EIRP(mW)	Polarization (H/V)
X	20050	1720.0	-17.84	42.69	24.85	305.56	H
	20175	1732.5	-17.33	42.29	24.96	313.33	
	20300	1745.0	-17.88	42.01	24.13	258.94	
	20050	1720.0	-20.28	42.09	21.81	151.71	V
	20175	1732.5	-21.37	42.74	21.37	137.09	
	20300	1745.0	-20.38	42.09	21.71	148.25	

LTE Band 4							
Channel Bandwidth: 20MHz / 16QAM							
Plane	Channel	Frequency (MHz)	LVL (dBm)	Correction Factor(dB)	EIRP(dBm)	EIRP(mW)	Polarization (H/V)
X	20050	1720.0	-18.92	42.69	23.77	238.29	H
	20175	1732.5	-18.66	42.29	23.63	230.67	
	20300	1745.0	-18.88	42.01	23.13	205.68	
	20050	1720.0	-21.17	42.09	20.92	123.59	V
	20175	1732.5	-22.26	42.74	20.48	111.69	
	20300	1745.0	-21.66	42.09	20.43	110.41	

4.2 FREQUENCY STABILITY MEASUREMENT

4.2.1 LIMITS OF FREQUENCY STABILITY MEASUREMENT

The frequency stability shall be sufficient to ensure that the fundamental emissions stay within the authorized bands of operation.

4.2.2 TEST PROCEDURE

- a. Device is placed at the oven room. The oven room could control the temperatures and humidity. Power warm up is at least 15 min and power applied should perform before recording frequency error.
- b. EUT is connected the external power supply to control the DC input power. The test voltage range is from minimum to maximum working voltage. Each step shall be record the frequency error rate.
- c. The temperature range step is 10 degrees in this test items. All temperature levels shall be hold the $\pm 0.5^{\circ}\text{C}$ during the measurement testing. The each temperature step shall be at least 0.5 hours, consider the EUT could be test under the stability condition.

NOTE: The frequency error was recorded frequency error from the communication simulator.

4.2.3 TEST SETUP

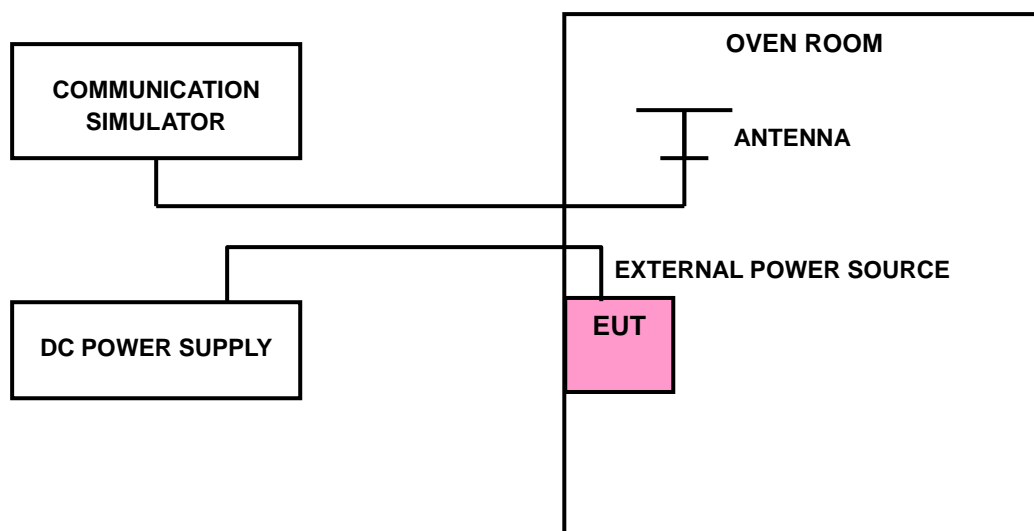



4.2.4 TEST RESULTS

FREQUENCY ERROR vs. VOLTAGE

VOLTAGE (Volts)	FREQUENCY ERROR (ppm)					LIMIT (ppm)
	LTE BAND 13	LTE BAND 4				
	10MHz	5MHz	10MHz	15MHz	20MHz	
3.8	-0.003	-0.0050	0.0035	-0.0032	-0.0020	2.5
3.4	-0.003	-0.0062	0.0024	-0.0018	-0.0003	2.5
4.35	0.002	-0.0077	0.0034	-0.0027	-0.0015	2.5

NOTE: The applicant defined the normal working voltage of the battery is from 3.4Vdc to 4.35Vdc.

FREQUENCY ERROR vs. TEMPERATURE

TEMP. (°C)	FREQUENCY ERROR (ppm)					LIMIT (ppm)
	LTE BAND 13	LTE BAND 4				
	10MHz	5MHz	10MHz	15MHz	20MHz	
-30	-0.002	-0.0094	0.0035	-0.0016	-0.0012	2.5
-20	-0.002	-0.0090	0.0025	0.0023	0.0014	2.5
-10	-0.004	-0.0054	0.0061	-0.0045	-0.0025	2.5
0	-0.002	-0.0061	0.0032	-0.0018	-0.0030	2.5
10	0.006	-0.0059	0.0024	-0.0031	-0.0023	2.5
20	0.005	-0.0101	0.0038	-0.0029	0.0013	2.5
30	-0.002	-0.0091	0.0055	0.0048	-0.0031	2.5
40	-0.001	-0.0076	0.0054	-0.0011	0.0014	2.5
50	-0.010	-0.0093	0.0038	-0.0068	0.0012	2.5

4.3 OCCUPIED BANDWIDTH MEASUREMENT

4.3.1 LIMITS OF OCCUPIED BANDWIDTH MEASUREMENT

The width of a frequency band such that, below the lower and above the upper frequency limits, the mean powers emitted are each equal to a specified percentage 0.5 %of the total mean power of a given emission.

4.3.2 TEST SETUP

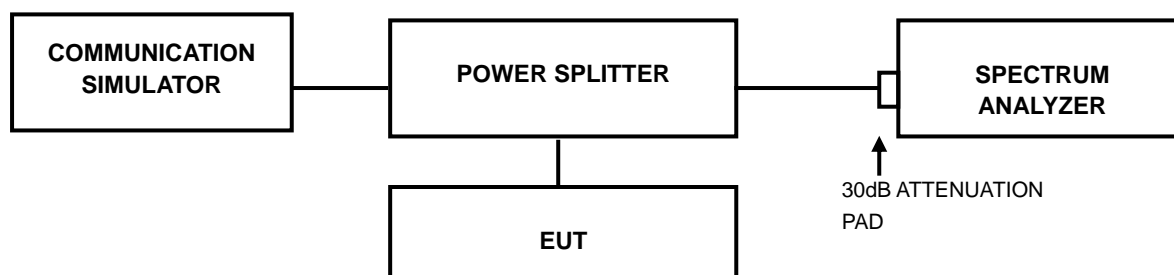

4.3.3 TEST PROCEDURES

- a. The conducted occupied bandwidth used the power splitter via EUT RF power connector between simulation base station and spectrum analyzer.
- b. Use OBW measurement function of Spectrum analyzer to measure 99 % occupied bandwidth.

4.3.4 TEST RESULTS

LTE BAND 13			
CHANNEL BANDWIDTH: 10MHz			
CHANNEL	FREQUENCY (MHz)	99% OCCUPIED BANDWIDTH (MHz)	
		QPSK	16QAM
23230	782.0	8.8848	8.8832

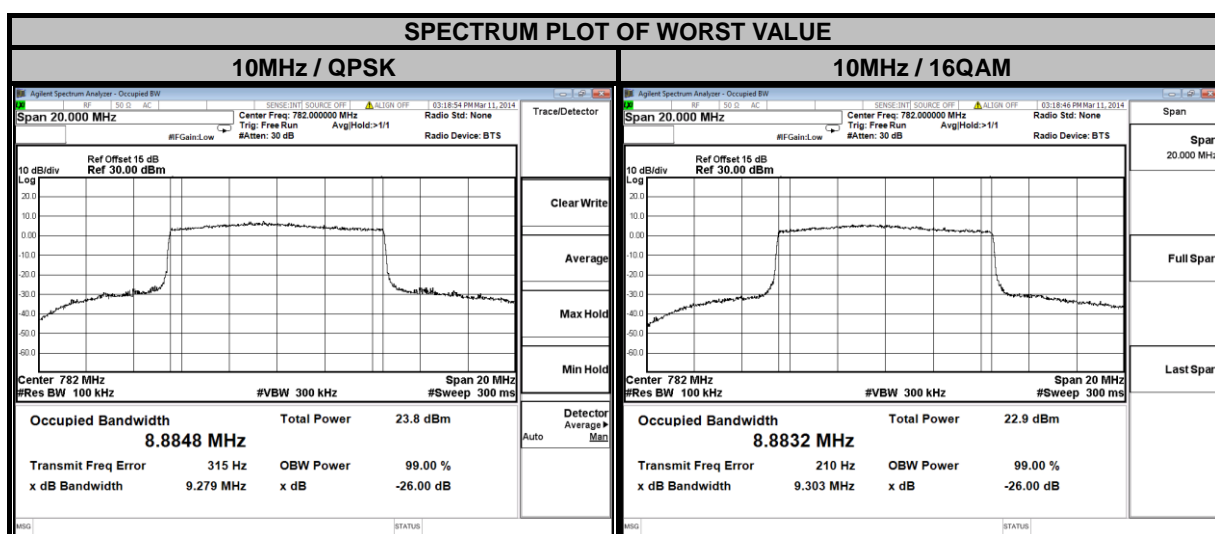



A D T

LTE BAND 4							
CHANNEL BANDWIDTH: 5MHz				CHANNEL BANDWIDTH: 10MHz			
CHANNEL	FREQUENCY (MHz)	99% OCCUPIED BANDWIDTH (MHz)		CHANNEL	FREQUENCY (MHz)	99% OCCUPIED BANDWIDTH (MHz)	
		QPSK	16QAM			QPSK	16QAM
19975	1712.5	4.4870	4.4877	20000	1715.0	8.9180	8.9110
20175	1732.5	4.4910	4.4910	20175	1732.5	8.9226	8.9145
20375	1752.5	4.4902	4.4891	20350	1750.0	8.9174	8.9101

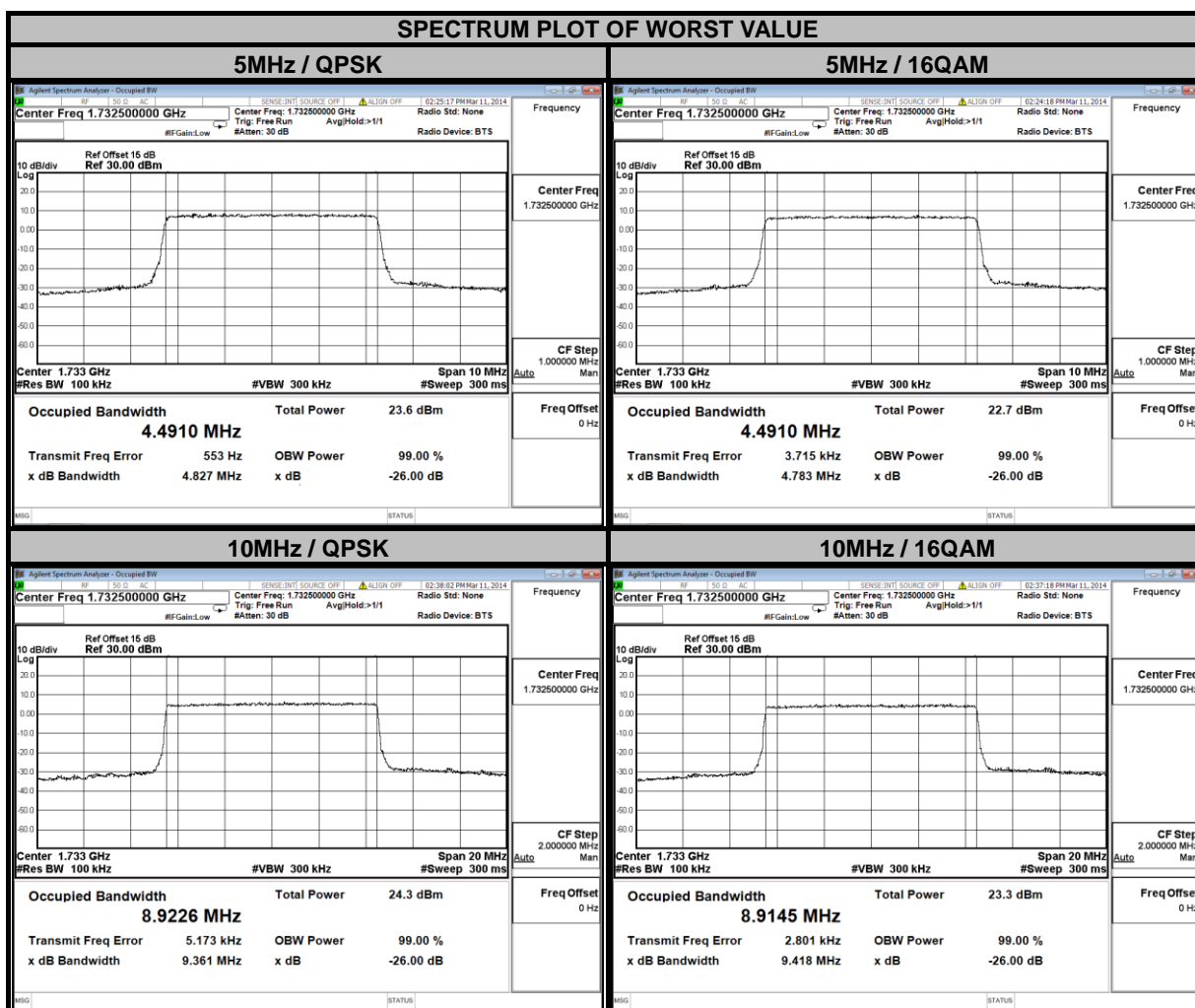



A D T

LTE BAND 4							
CHANNEL BANDWIDTH: 15MHz				CHANNEL BANDWIDTH: 20MHz			
CHANNEL	FREQUENCY (MHz)	99% OCCUPIED BANDWIDTH (MHz)		CHANNEL	FREQUENCY (MHz)	99% OCCUPIED BANDWIDTH (MHz)	
		QPSK	16QAM			QPSK	16QAM
20025	1717.5	13.370	13.362	20050	1720.0	17.779	17.795
20175	1732.5	13.380	13.372	20175	1732.5	17.803	17.811
20325	1747.5	13.356	13.356	20300	1745.0	17.764	17.762

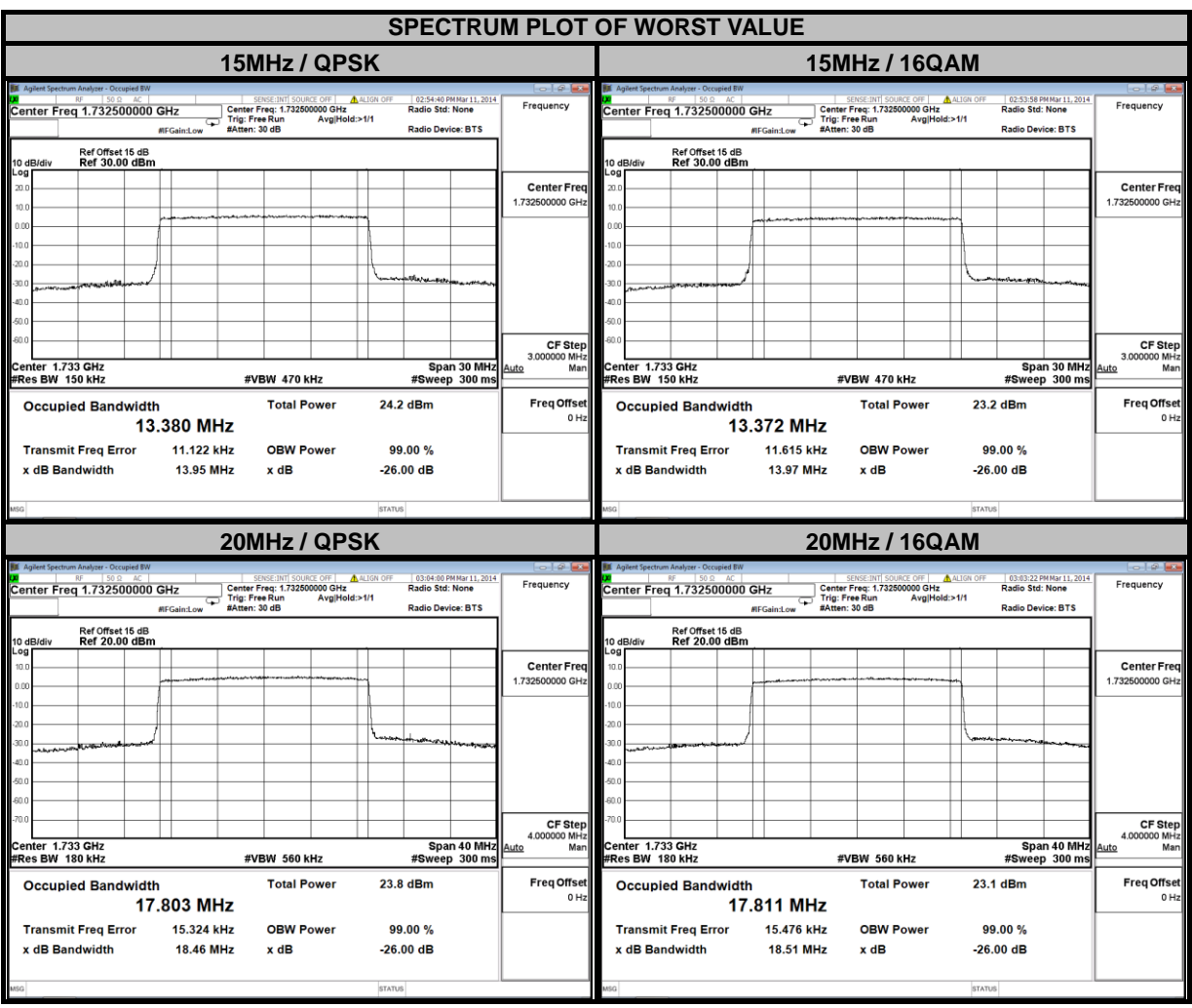

4.4 PEAK TO AVERAGE RATIO

4.4.1 LIMITS OF PEAK TO AVERAGE RATIO MEASUREMENT

In measuring transmissions in this band using an average power technique, the peak to-average ratio (PAR) of the transmission may not exceed 13 dB.

4.4.2 TEST SETUP

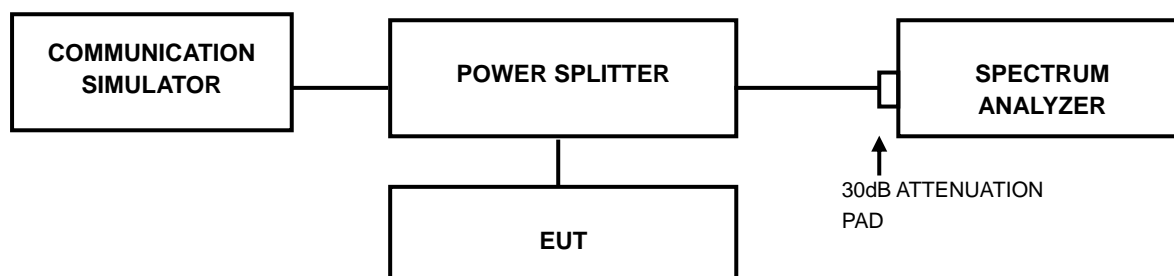

4.4.3 TEST PROCEDURES

1. Set resolution/measurement bandwidth \geq signal's occupied bandwidth;
2. Set the number of counts to a value that stabilizes the measured CCDF curve;
3. Record the maximum PAPR level associated with a probability of 0.1%.



A D T

4.4.4 TEST RESULTS

LTE BAND 13			
CHANNEL BANDWIDTH: 10MHz			
CHANNEL	FREQUENCY (MHz)	PEAK TO AVERAGE RATIO (dB)	
		QPSK	16QAM
23230	782.0	3.57	4.77

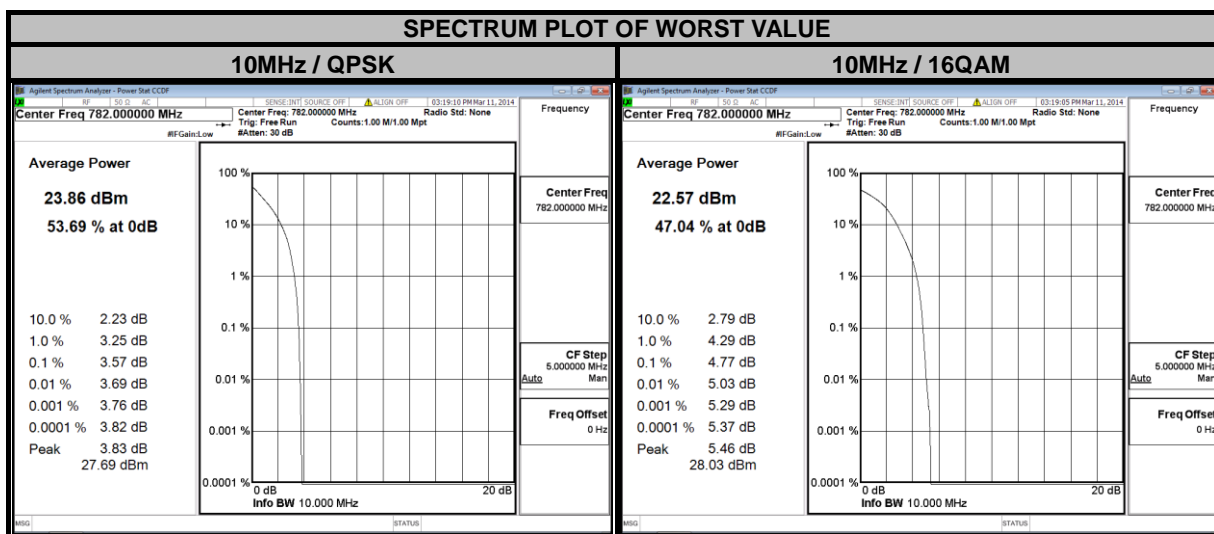



A D T

LTE BAND 4							
CHANNEL BANDWIDTH: 5MHz				CHANNEL BANDWIDTH: 10MHz			
CHANNEL	FREQUENCY (MHz)	PEAK TO AVERAGE RATIO (dB)		CHANNEL	FREQUENCY (MHz)	PEAK TO AVERAGE RATIO (dB)	
		QPSK	16QAM			QPSK	16QAM
19975	1712.5	4.30	5.54	20000	1715.0	4.24	5.48
20175	1732.5	4.61	5.89	20175	1732.5	4.53	5.77
20375	1752.5	3.50	4.76	20350	1750.0	3.71	4.93

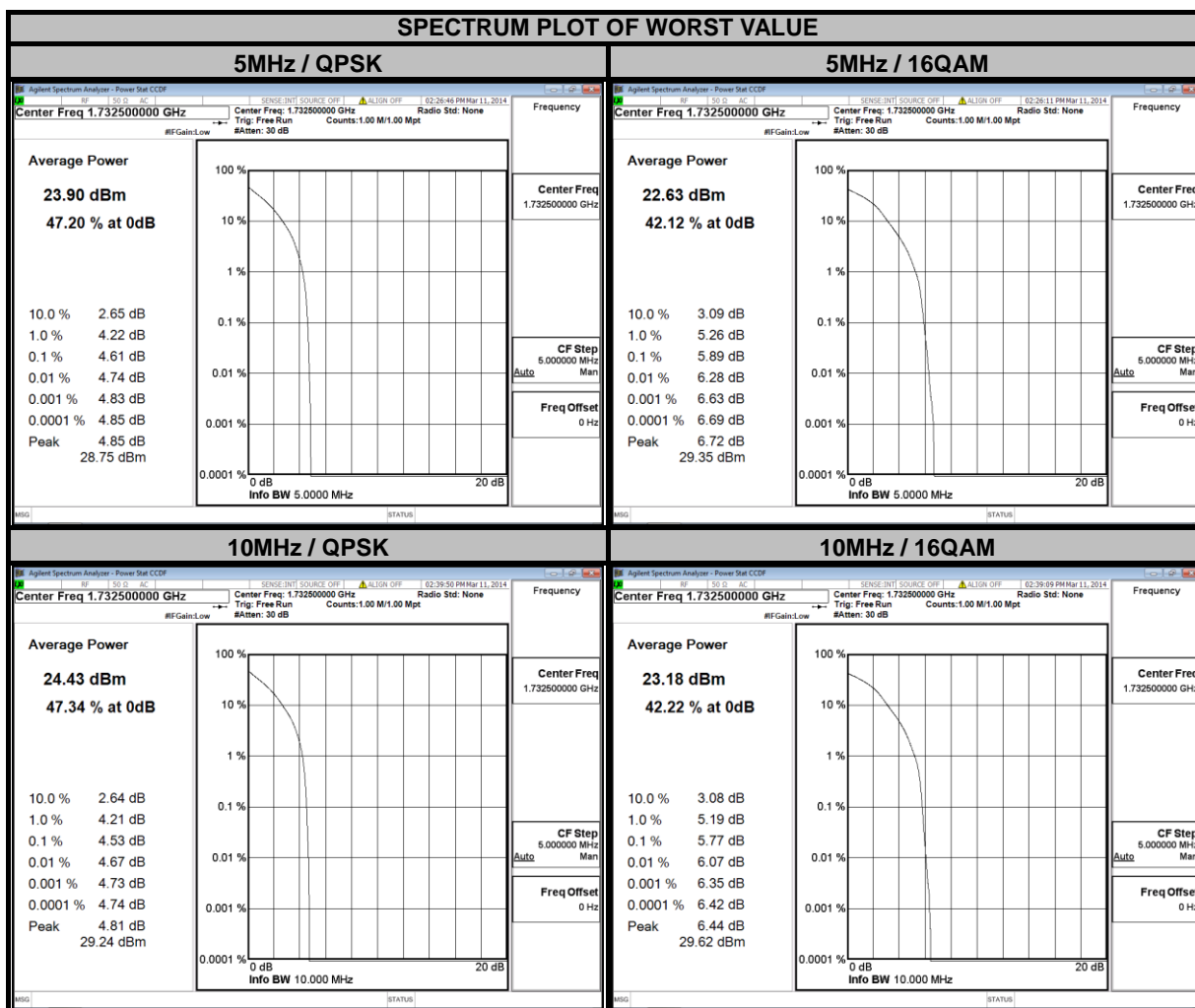



A D T

LTE BAND 4							
CHANNEL BANDWIDTH: 15MHz				CHANNEL BANDWIDTH: 20MHz			
CHANNEL	FREQUENCY (MHz)	PEAK TO AVERAGE RATIO (dB)		CHANNEL	FREQUENCY (MHz)	PEAK TO AVERAGE RATIO (dB)	
		QPSK	16QAM			QPSK	16QAM
20025	1717.5	5.34	6.13	20050	1720	4.20	5.49
20175	1732.5	5.46	6.24	20175	1732.5	4.34	5.56
20325	1747.5	4.88	5.61	20300	1745	4.26	5.42

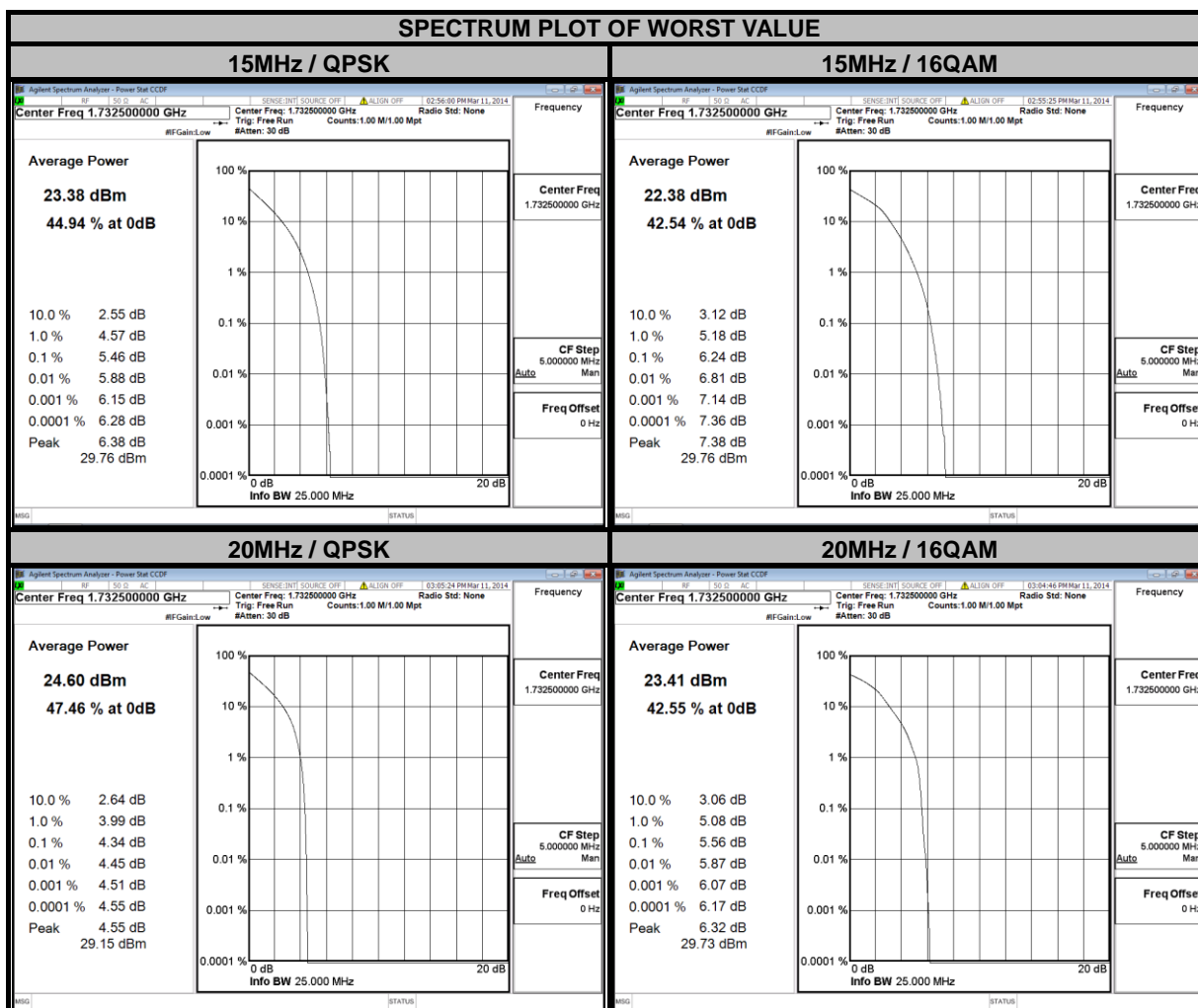

4.5 BAND EDGE MEASUREMENT

4.5.1 LIMITS OF BAND EDGE MEASUREMENT

For operations in the 777-787 MHz band, the power of any emission outside a licensee's frequency band(s) of operation shall be attenuated below the transmitter power (P) within the licensed band(s) of operation, measured in watts, by at least $43 + 10 \log(P)$ dB. Compliance with this provision is based on the use of measurement instrumentation employing a resolution bandwidth of 100 kilohertz or greater. However, in the 100 kilohertz bands immediately outside and adjacent to a licensee's frequency block, a resolution bandwidth of at least 30 kHz may be employed.

For operations in the 1710–1755 MHz bands, the power of any emission outside a licensee's frequency block shall be attenuated below the transmitter power (P) by at least $43 + 10 \log_{10}(P)$ dB.

4.5.2 TEST SETUP

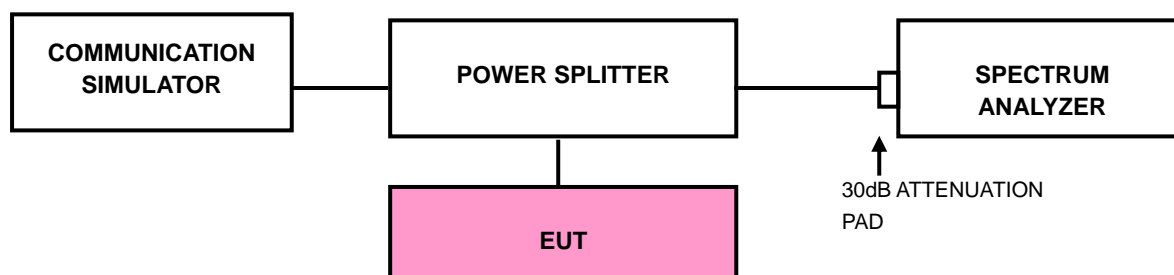

4.5.3 TEST PROCEDURES

- The EUT was set up for the maximum peak power with LTE link data modulation. The power was measured with R&S Spectrum Analyzer. All measurements were done at 2 channels (low and high operational frequency range.).
- The band edge measurement used the power splitter via EUT RF power connector between simulation base station and spectrum analyzer.
- The center frequency of spectrum is the band edge frequency and span is 2 MHz. RB of the spectrum is 100kHz and VB of the spectrum is 300kHz.
- The center frequency of spectrum is the band edge frequency and span is 1 MHz. RB of the spectrum is 91kHz and VB of the spectrum is 300kHz (LTE Band 4 Bandwidth 5MHz).
- Record the max trace plot into the test report.



A D T

4.5.4 TEST RESULTS

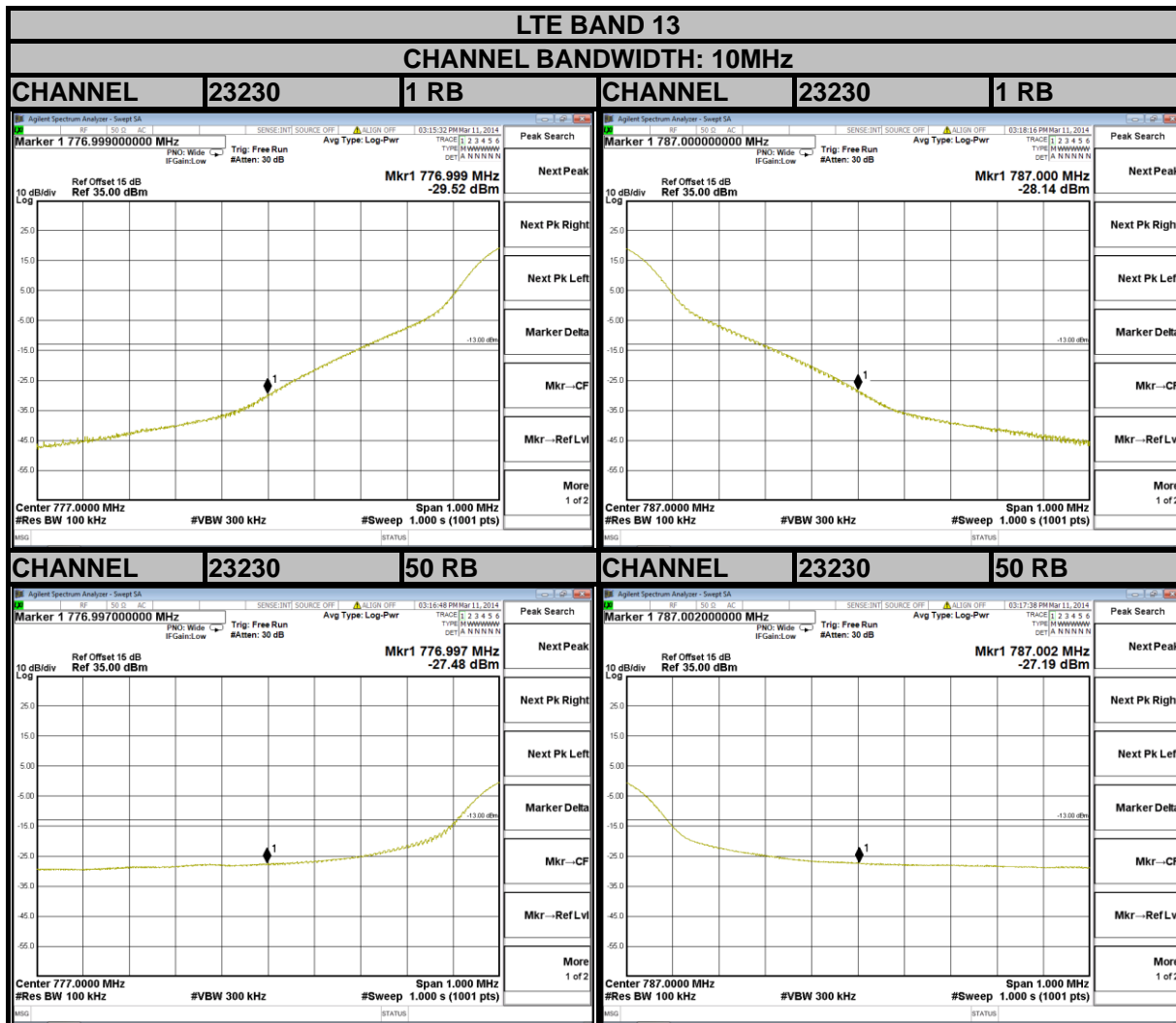



A D T

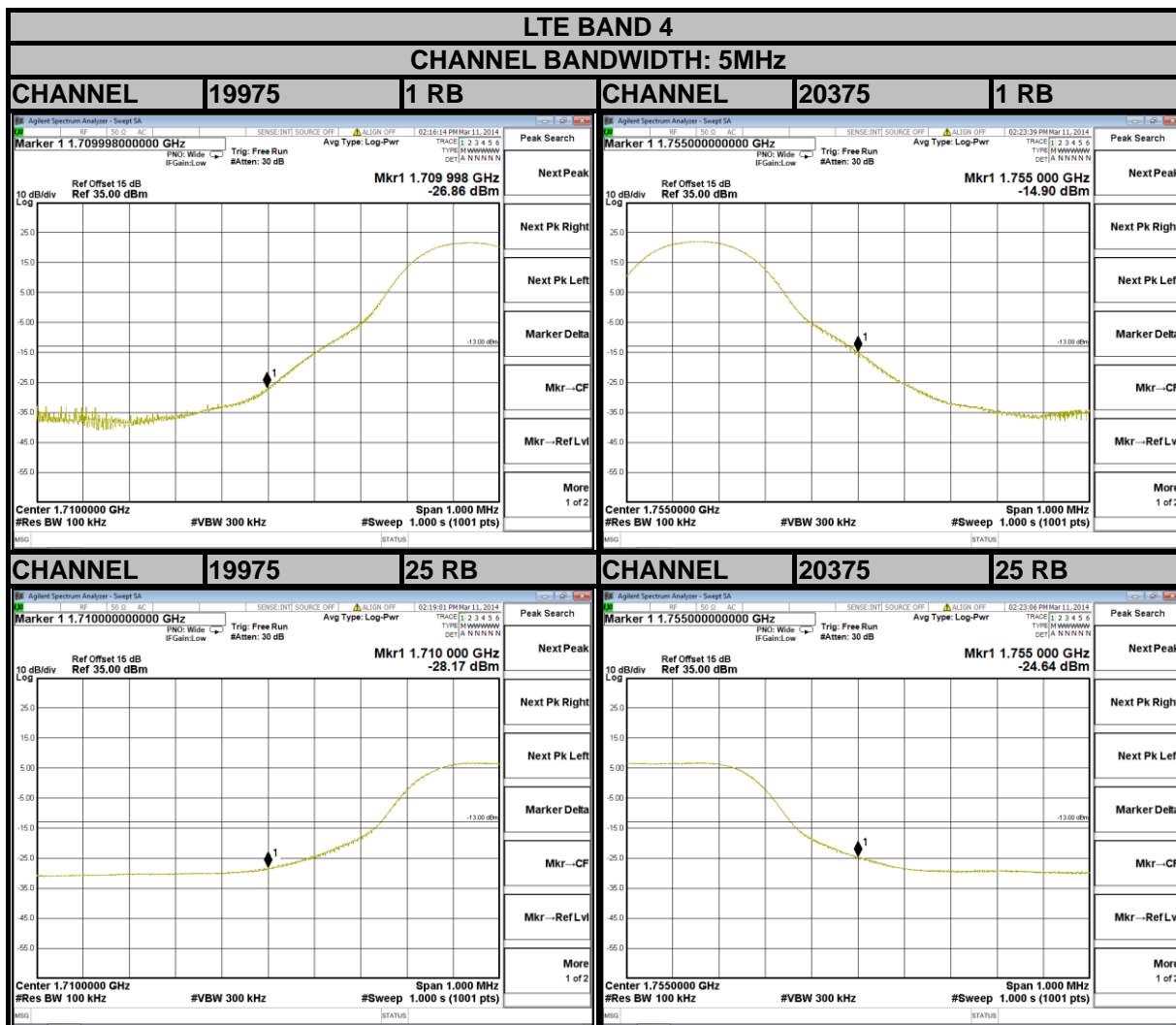



A D T

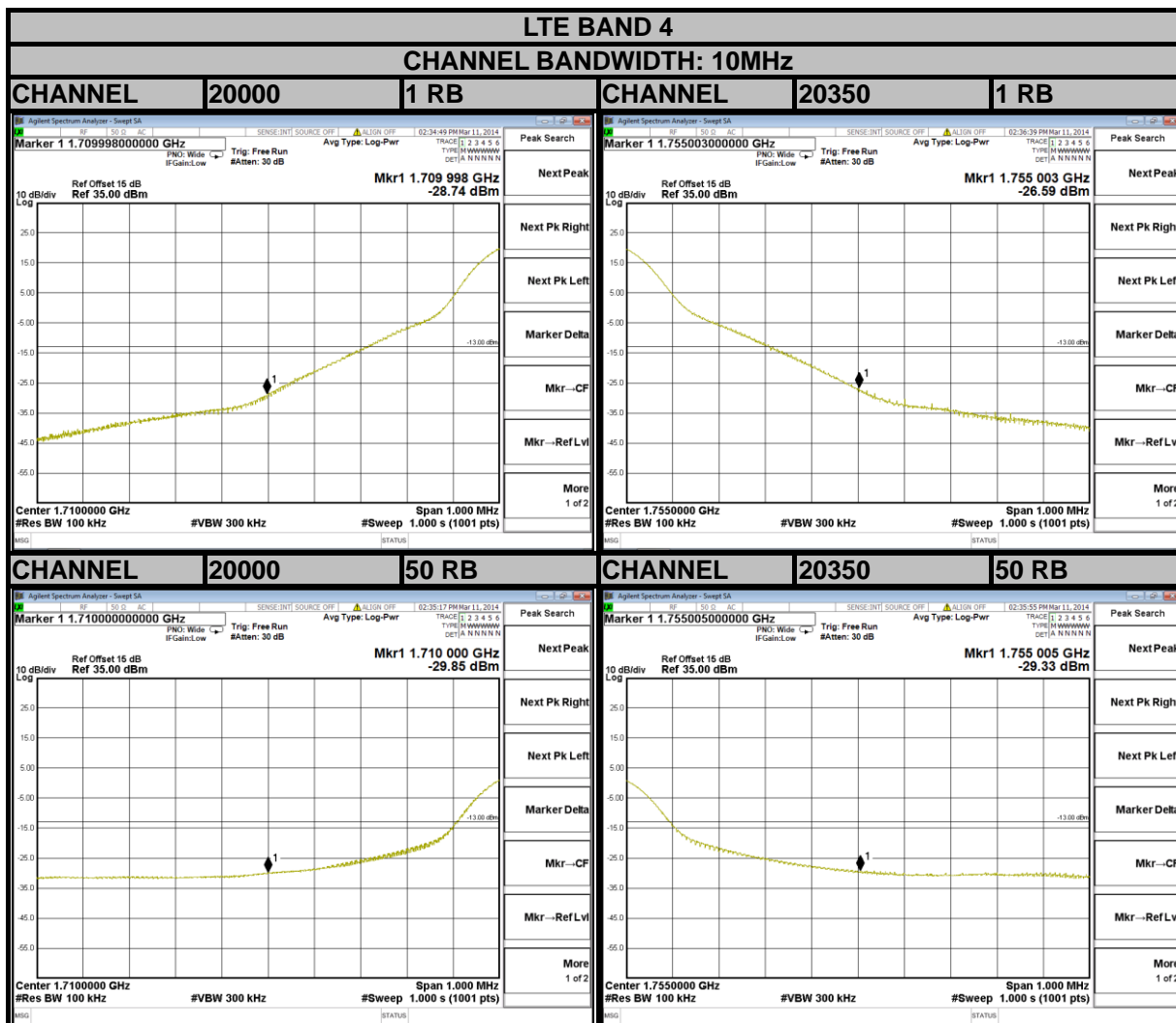



A D T

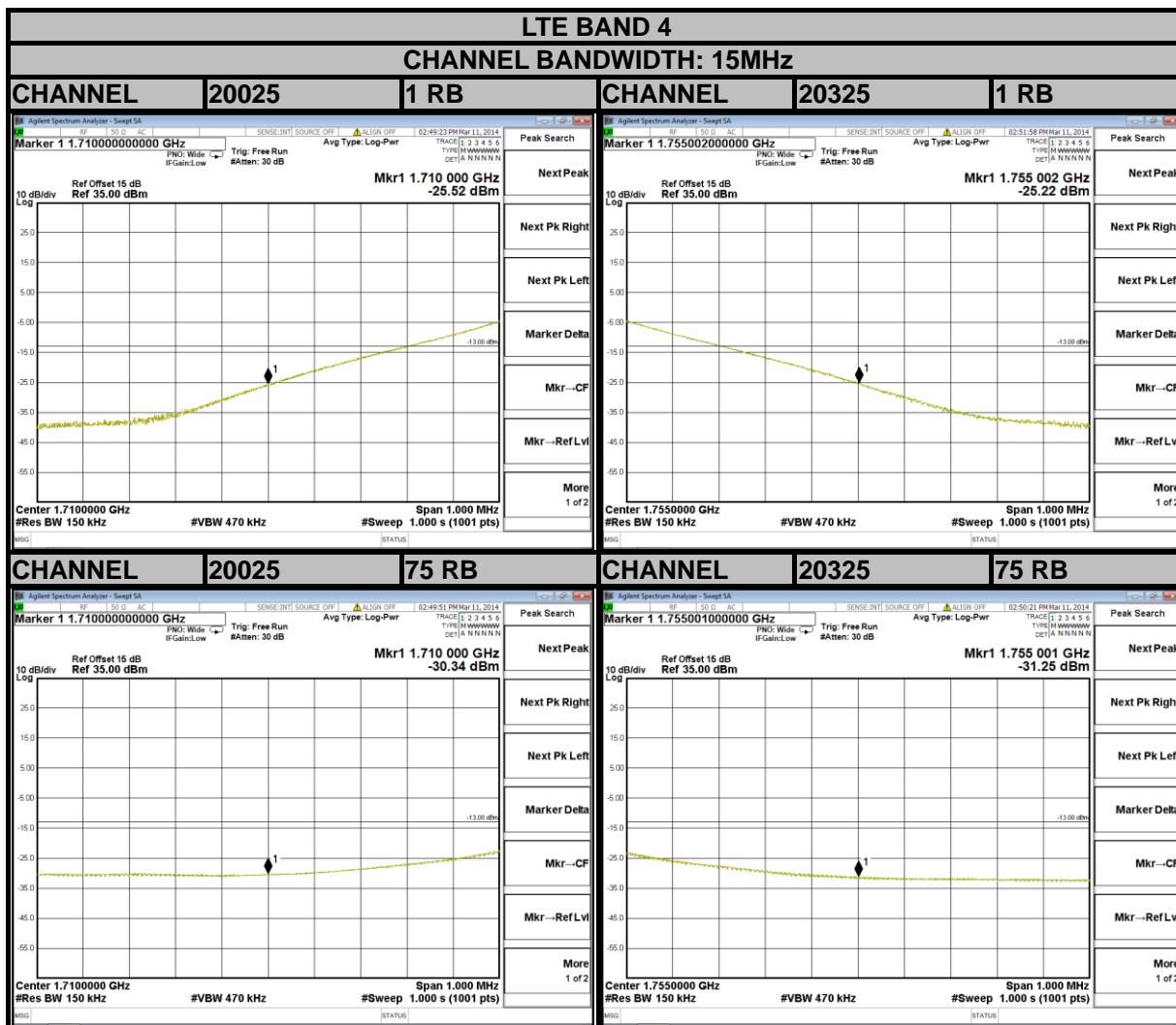



A D T

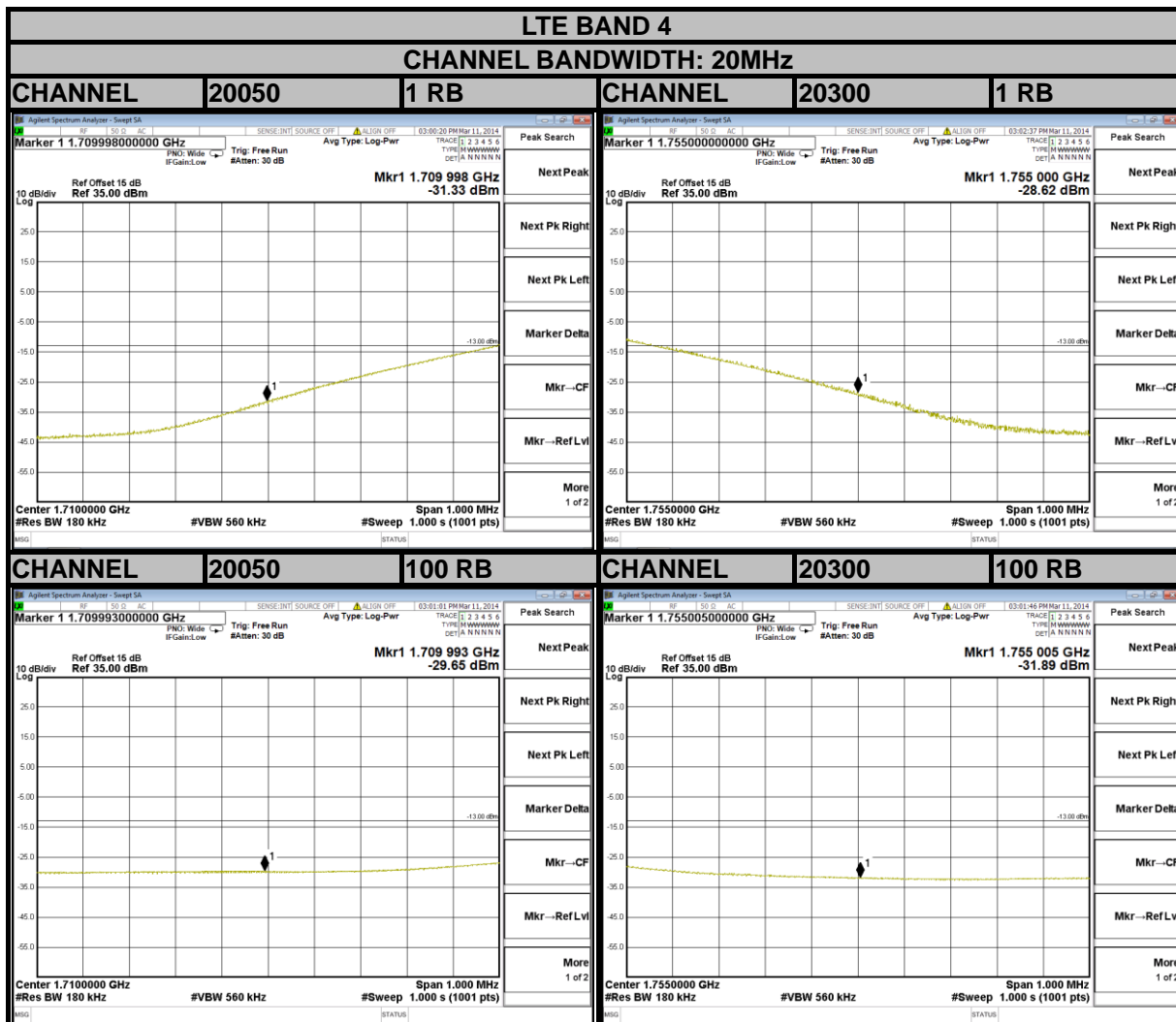

4.6 CONDUCTED SPURIOUS EMISSIONS

4.6.1 LIMITS OF CONDUCTED SPURIOUS EMISSIONS MEASUREMENT

The power of any emission outside a licensee's frequency block shall be attenuated below the transmitter power (P) by at least $43 + 10 \log_{10}(P)$ dB. The limit of emission is equal to -13dBm.

4.6.2 TEST PROCEDURE

- The EUT makes a phone call to the communication simulator. All measurements were done at low, middle and high operational frequency range.
- Measuring frequency range is from 30 MHz to 8GHz for LTE Band 17 and from 30MHz to 18GHz for LTE Band 4. 10dB attenuation pad is connected with spectrum. RBW=1MHz and VBW=3MHz are used for conducted emission measurement.

4.6.3 TEST SETUP

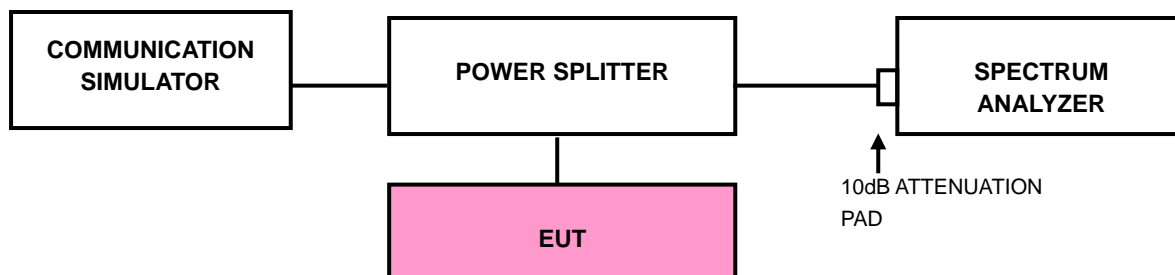

4.6.4 TEST RESULTS

FREQUENCY RANGE: 30MHz~8GHz

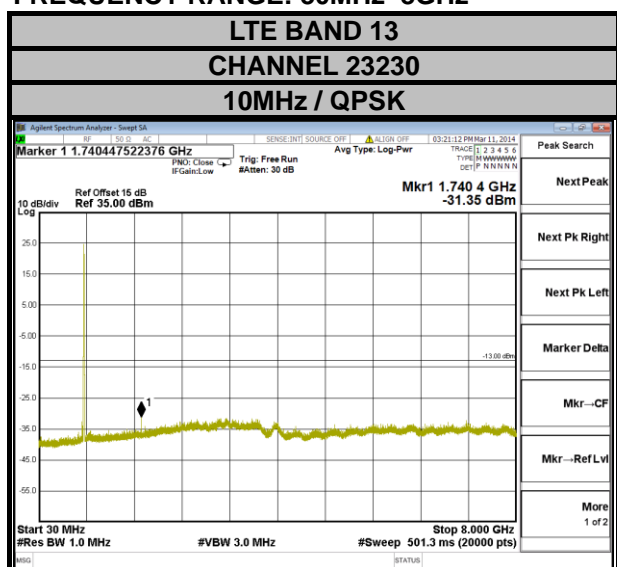



A D T

FREQUENCY RANGE: 30MHz~18GHz

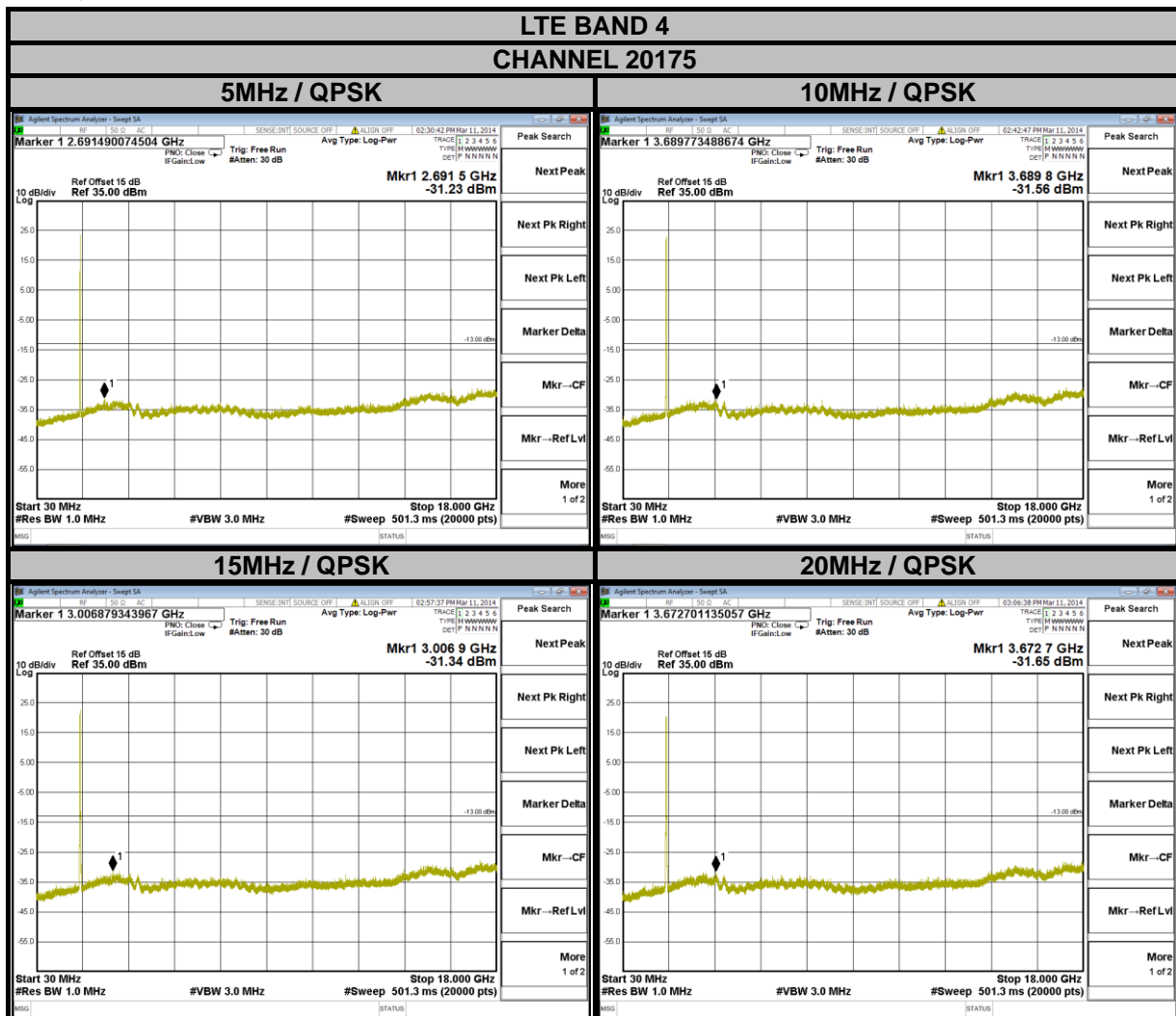

4.7 RADIATED EMISSION MEASUREMENT

4.7.1 LIMITS OF RADIATED EMISSION MEASUREMENT

The power of any emission outside a licensee's frequency block shall be attenuated below the transmitter power (P) by at least $43 + 10 \log_{10}(P)$ dB. The limit of emission equal to -13dBm

4.7.2 TEST PROCEDURES

- a. Substitution method is used for E.I.R.P measurement. In the semi-anechoic chamber, EUT placed on the 0.8m height of Turn Table, rotated the table around 360 degrees to search the maximum radiation power and receiver antenna shall be rotated vertical and horizontal polarization and moved height from 1m to 4m to find the maximum polar radiated power. The "Read Value" is the spectrum reading the maximum power value.
- b. The substitution horn antenna is substituted for EUT at the same position and signals generator export the CW signal to the substitution antenna via a TX cable. Rotated the Turn Table and moved receiving antenna to find the maximum radiation power. Adjust output power level of S.G to get a Value of spectrum reading equal to "Read Value " of step a. Record the power level of S.G
- c. $\text{EIRP} = \text{Output power level of S.G} - \text{TX cable loss} + \text{Antenna gain of substitution horn.}$
- d. E.R.P power can be calculated form E.I.R.P power by subtracting the gain of dipole, $\text{E.R.P power} = \text{E.I.P.R power} - 2.15\text{dBi.}$

NOTE: The resolution bandwidth of spectrum analyzer is 1 MHz and the video bandwidth is 3 MHz.

4.7.3 DEVIATION FROM TEST STANDARD

No deviation

4.7.4 TEST SETUP

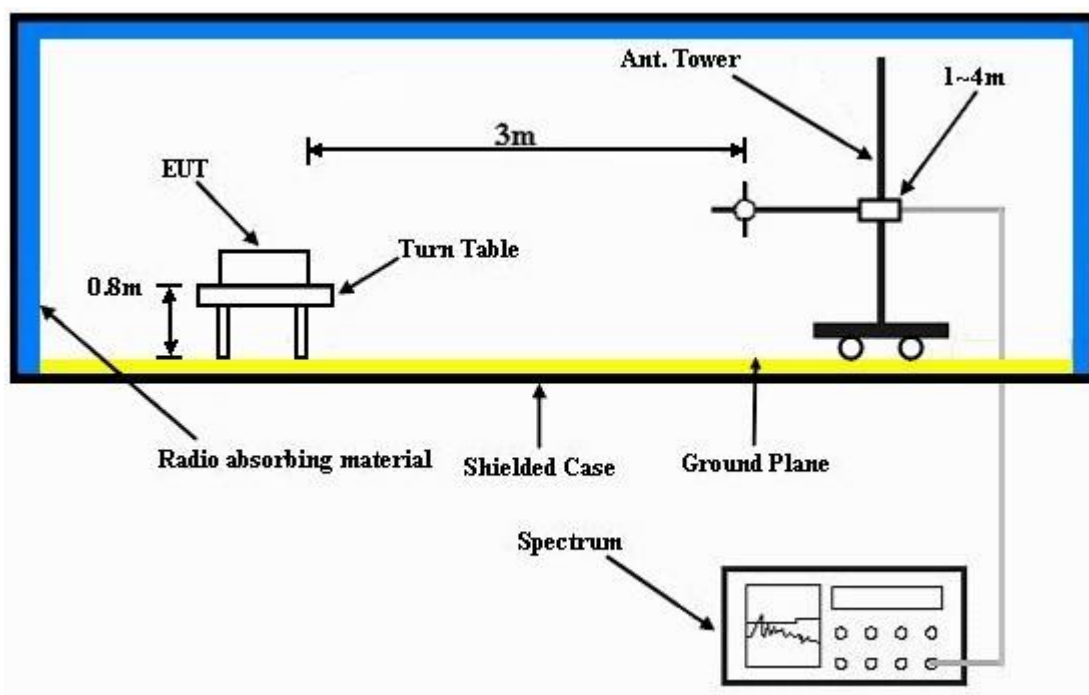

For the actual test configuration, please refer to the attached file (Test Setup Photo).



A D T

4.7.5 TEST RESULTS

LTE BAND 13

CHANNEL BANDWIDTH: 10MHz / QPSK (1 RB / 24 RB OFFSET)



Bureau Veritas Consumer Products Services Ltd., Taoyuan Branch

A D T

Data: 9

Date: 2014-03-11

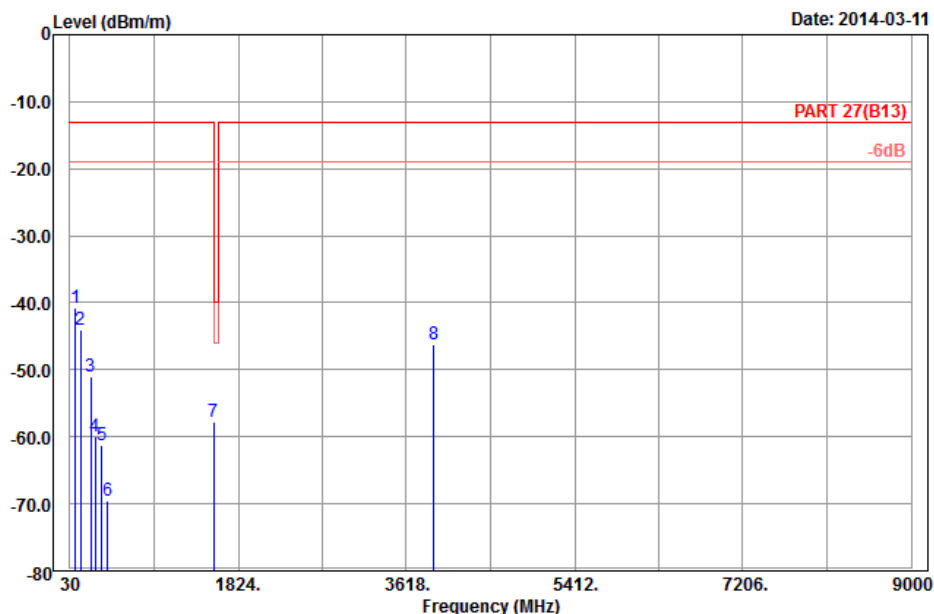

Site : 966 chamber 5
 Condition : PART 27(B13) 3m Horizontal
 Brand/Model: E6782
 Remark : LTE_Band 13_QPSK(1,24)_10M_CH23230
 Tested by : Kay Wu
 Plane : Z

	Freq	Level	Read Level	Limit Line	Over Limit	Factor	Remark
	MHz	dBm/m	dBm	dBm/m	dB	dB/m	
1	84.81	-40.80	-29.58	-13.00	-27.80	-11.22	Peak
2	141.24	-44.04	-36.30	-13.00	-31.04	-7.74	Peak
3	249.51	-51.09	-45.57	-13.00	-38.09	-5.52	Peak
4	300.70	-60.00	-54.05	-13.00	-47.00	-5.95	Peak
5	367.90	-61.15	-56.70	-13.00	-48.15	-4.45	Peak
6	431.60	-69.54	-66.10	-13.00	-56.54	-3.44	Peak
7 pp	1564.00	-57.66	-64.52	-40.00	-17.66	6.86	Peak
8	3910.00	-46.16	-63.10	-13.00	-33.16	16.94	Peak



A D T



Bureau Veritas Consumer Products Services Ltd., Taoyuan Branch

A D T

Data: 10

Date: 2014-03-11

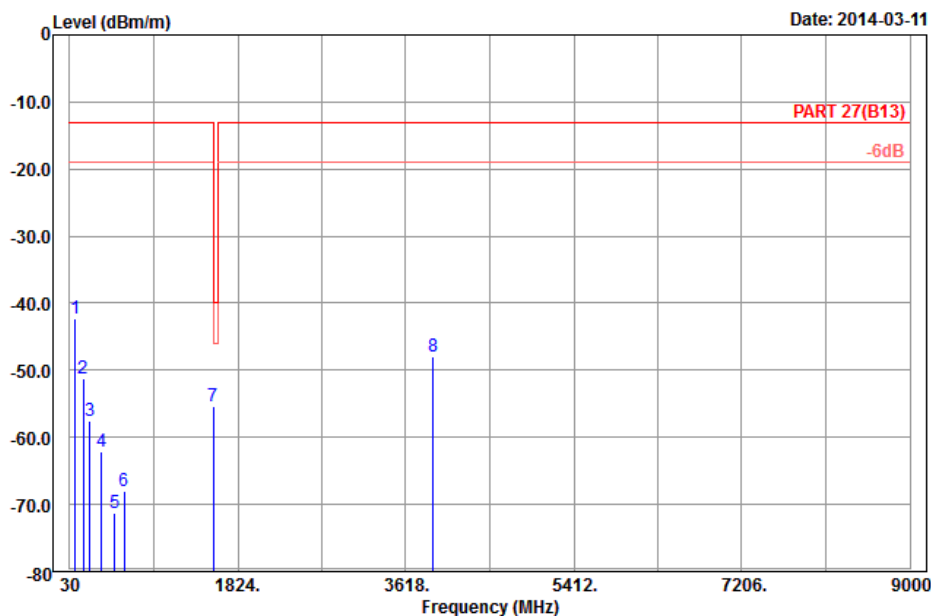

Site : 966 chamber 5
 Condition : PART 27(B13) 3m Vertical
 Brand/Model: E6782
 Remark : LTE_Band 13_QPSK(1,24)_10M_CH23230
 Tested by : Kay Wu
 Plane : Z

	Read	Limit	Over			
Freq	Level	Level	Line	Limit	Factor	Remark
MHz	dBm/m	dBm	dBm/m	dB	dB/m	
1	85.35	-42.31	-31.09	-13.00	-29.31	-11.22 Peak
2	176.61	-51.26	-45.27	-13.00	-38.26	-5.99 Peak
3	247.08	-57.46	-51.91	-13.00	-44.46	-5.55 Peak
4	368.60	-62.15	-57.75	-13.00	-49.15	-4.40 Peak
5	512.10	-71.18	-66.75	-13.00	-58.18	-4.43 Peak
6	615.00	-68.10	-68.36	-13.00	-55.10	0.26 Peak
7 pp	1564.00	-55.36	-62.22	-40.00	-15.36	6.86 Peak
8	3910.00	-47.95	-64.89	-13.00	-34.95	16.94 Peak



A D T

LTE BAND 13
CHANNEL BANDWIDTH: 10MHz / QPSK (50 RB / 0 RB OFFSET)



Bureau Veritas Consumer Products Services Ltd., Taoyuan Branch

A D T

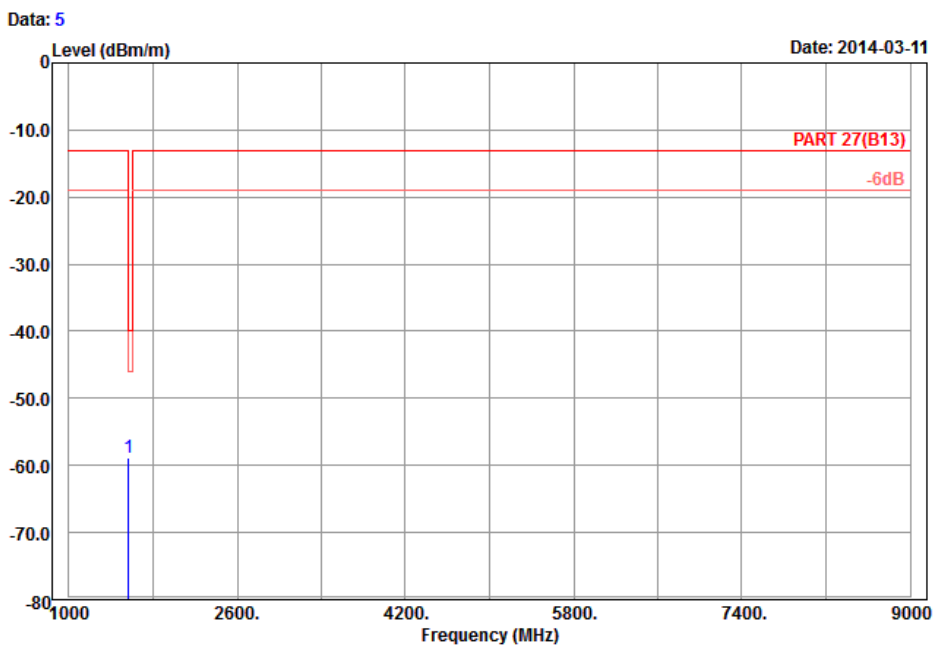

Site : 966 chamber 5
 Condition : PART 27(B13) 3m Horizontal
 Brand/Model: E6782
 Remark : LTE_Band 13_QPSK(50,0)_10M_CH23230
 Tested by : Kay Wu
 Plane : Z

	Read	Limit	Over		
Freq	Level	Level	Line	Limit	Factor Remark
MHz	dBm/m	dBm	dBm/m	dB	dB/m
1 pp 1564.00	-58.86	-65.72	-40.00	-18.86	6.86 Peak



A D T



Bureau Veritas Consumer Products Services Ltd., Taoyuan Branch

A D T

Data: 6

Date: 2014-03-11

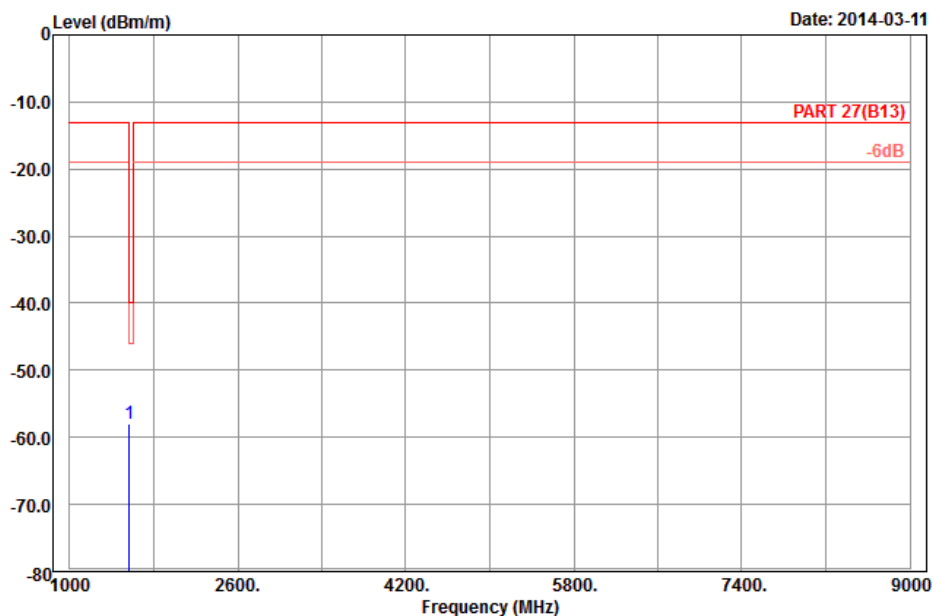

Site : 966 chamber 5
 Condition : PART 27(B13) 3m Vertical
 Brand/Model: E6782
 Remark : LTE_Band 13_QPSK(50,0)_10M_CH23230
 Tested by : Kay Wu
 Plane : Z

	Read	Limit	Over		
Freq	Level	Level	Line	Limit	Factor Remark
MHz	dBm/m	dBm	dBm/m	dB	dB/m
1 pp 1564.00	-57.93	-64.79	-40.00	-17.93	6.86 Peak



A D T

LTE BAND 4
CHANNEL BANDWIDTH: 5MHz / QPSK



Bureau Veritas Consumer Products Services Ltd., Taoyuan Branch

A D T

Data: 11

Date: 2014-03-11

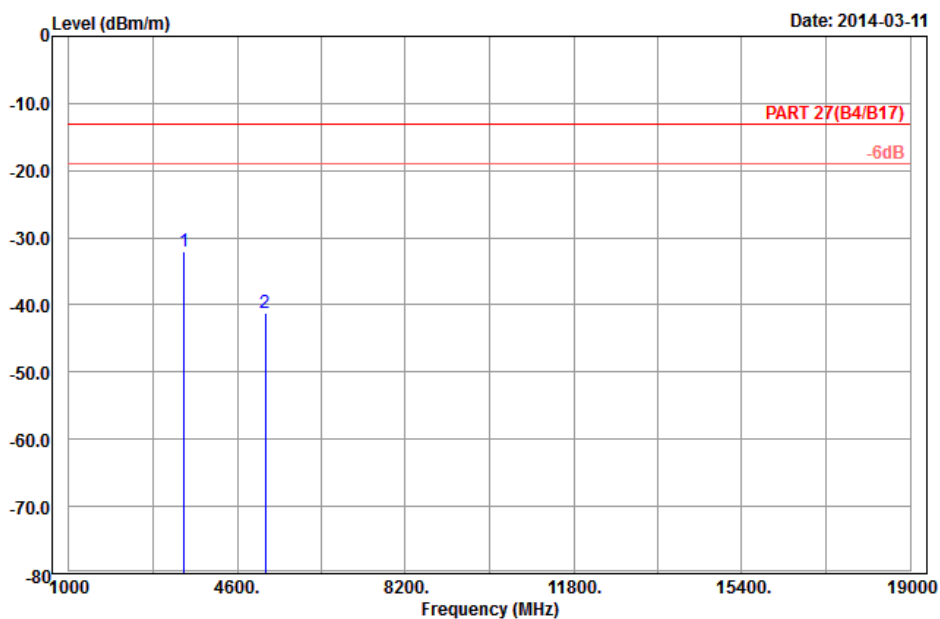

Site : 966 chamber 5
 Condition : PART 27(B4/B17) 3m Horizontal
 Brand/Model: E6782
 Remark : LTE_Band 4_QPSK(1,12)_5M_CH20175
 Tested by : Kay Wu
 Plane : Y

	Freq	Level	Read Level	Limit Line	Over Limit	Factor	Remark
	MHz	dBm/m	dBm	dBm/m	dB	dB/m	
1 pp	3465.00	-32.15	-46.49	-13.00	-19.15	14.34	Peak
2	5197.50	-41.16	-61.28	-13.00	-28.16	20.12	Peak



A D T



Bureau Veritas Consumer Products Services Ltd., Taoyuan Branch

A D T

Data: 12

Date: 2014-03-11

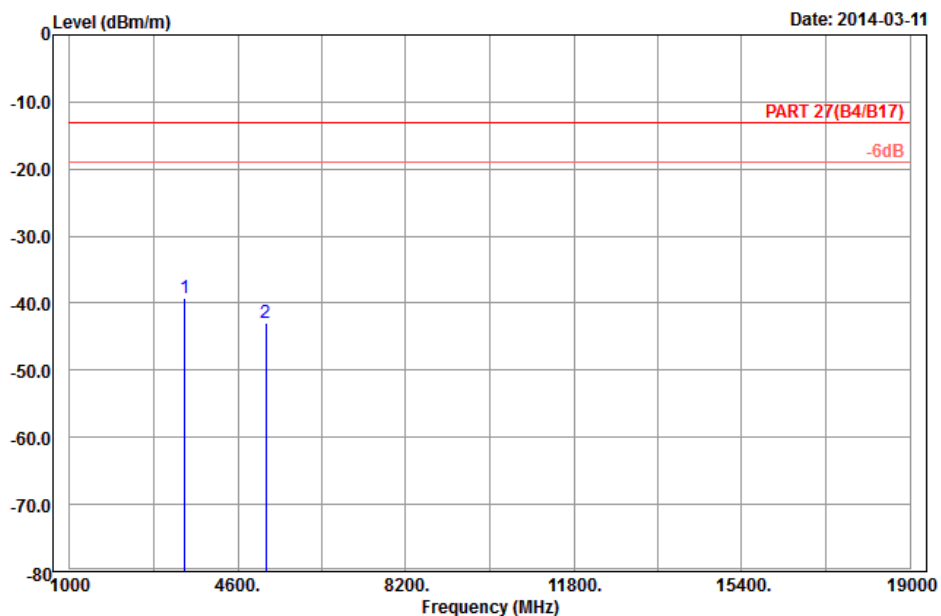

Site : 966 chamber 5
 Condition : PART 27(B4/B17) 3m Vertical
 Brand/Model: E6782
 Remark : LTE_Band 4_QPSK(1,12)_5M_CH20175
 Tested by : Kay Wu
 Plane : Y

	Read	Limit	Over			
Freq	Level	Level	Line	Limit	Factor	Remark
MHz	dBm/m	dBm	dBm/m	dB	dB/m	
1 pp	3465.00	-39.25	-53.59	-13.00	-26.25	14.34 Peak
2	5197.50	-42.89	-63.01	-13.00	-29.89	20.12 Peak



A D T

LTE BAND 4
CHANNEL BANDWIDTH: 10MHz / QPSK



Bureau Veritas Consumer Products Services Ltd., Taoyuan Branch

A D T

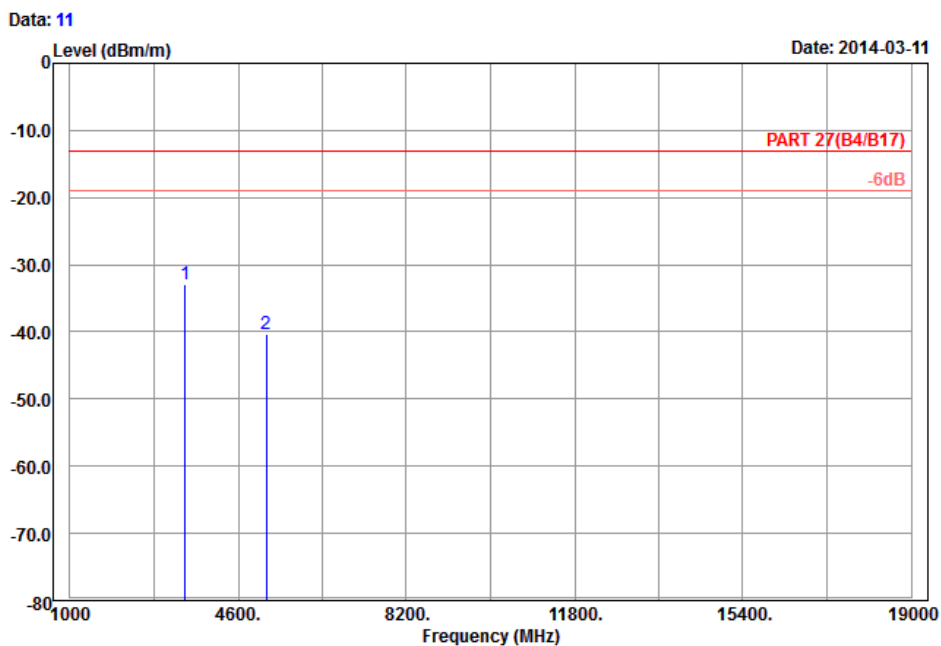

Site : 966 chamber 5
 Condition : PART 27(B4/B17) 3m Horizontal
 Brand/Model: E6782
 Remark : LTE_Band 4_QPSK(1,24)_10M_CH20175
 Tested by : Kay Wu
 Plane : Y

	Freq	Level	Read Level	Limit Line	Over Limit	Factor	Remark
	MHz	dBm/m	dBm	dBm/m	dB	dB/m	
1 pp	3465.00	-32.96	-47.30	-13.00	-19.96	14.34	Peak
2	5197.50	-40.25	-60.37	-13.00	-27.25	20.12	Peak



A D T



Bureau Veritas Consumer Products Services Ltd., Taoyuan Branch

A D T

Data: 12

Date: 2014-03-11

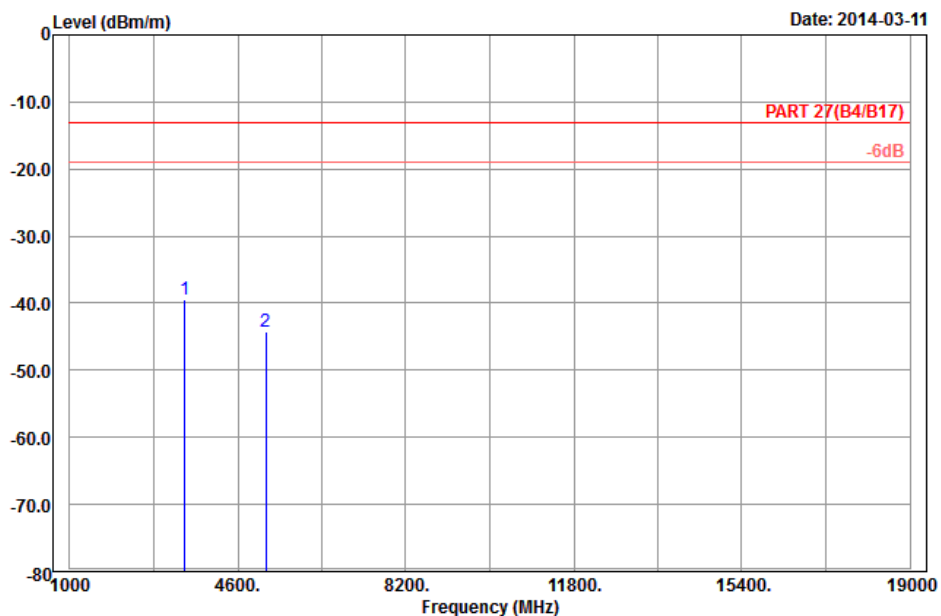

Site : 966 chamber 5
 Condition : PART 27(B4/B17) 3m Vertical
 Brand/Model: E6782
 Remark : LTE_Band 4_QPSK(1,24)_10M_CH20175
 Tested by : Kay Wu
 Plane : Y

	Freq	Level	Read Level	Limit Line	Over Limit	Factor	Remark
	MHz	dBm/m	dBm	dBm/m	dB	dB/m	
1	pp 3465.00	-39.43	-53.77	-13.00	-26.43	14.34	Peak
2	5197.50	-44.29	-64.41	-13.00	-31.29	20.12	Peak



A D T

LTE BAND 4
CHANNEL BANDWIDTH: 15MHz / QPSK



Bureau Veritas Consumer Products Services Ltd., Taoyuan Branch

A D T

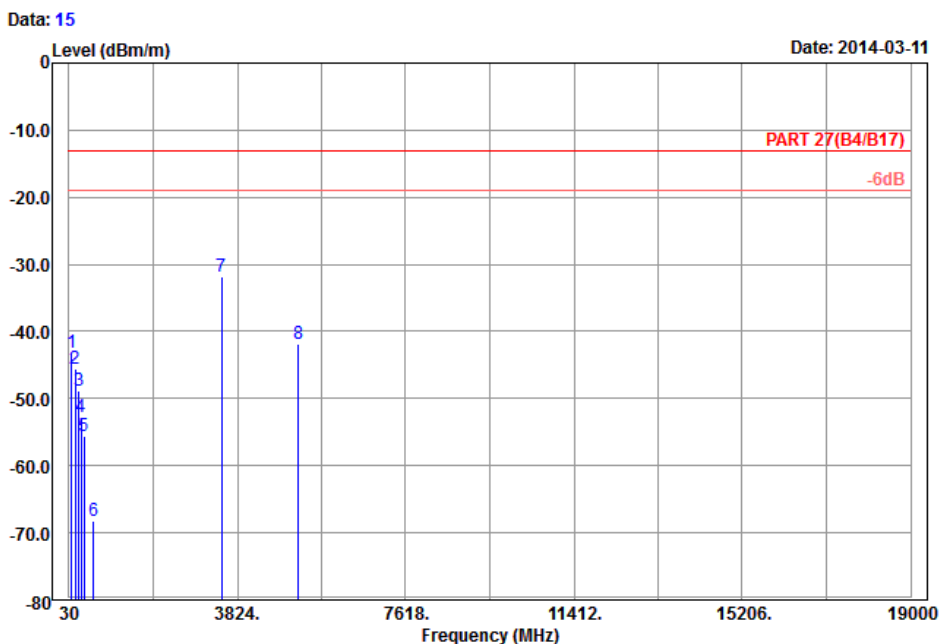

Site : 966 chamber 5
 Condition : PART 27(B4/B17) 3m Horizontal
 Brand/Model: E6782
 Remark : LTE_Band 4_QPSK(1,37)_15M_CH20175
 Tested by : Kay Wu
 Plane : Y

	Freq	Level	Read Level	Limit Line	Over Limit	Factor	Remark
	MHz	dBm/m	dBm	dBm/m	dB	dB/m	
1	85.08	-43.18	-31.96	-13.00	-30.18	-11.22	Peak
2	166.08	-45.49	-38.40	-13.00	-32.49	-7.09	Peak
3	245.19	-48.83	-43.26	-13.00	-35.83	-5.57	Peak
4	300.70	-52.65	-46.70	-13.00	-39.65	-5.95	Peak
5	374.20	-55.62	-51.54	-13.00	-42.62	-4.08	Peak
6	586.30	-68.28	-68.14	-13.00	-55.28	-0.14	Peak
7 pp	3465.00	-31.89	-46.23	-13.00	-18.89	14.34	Peak
8	5197.50	-41.89	-62.01	-13.00	-28.89	20.12	Peak



A D T



Bureau Veritas Consumer Products Services Ltd., Taoyuan Branch

A D T

Data: 16

Date: 2014-03-11

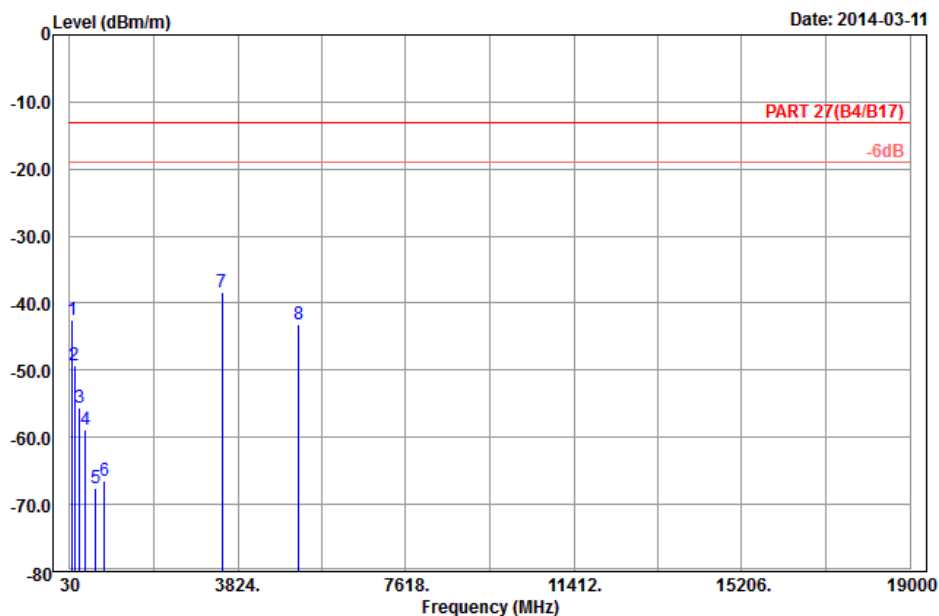

Site : 966 chamber 5
 Condition : PART 27(B4/B17) 3m Vertical
 Brand/Model: E6782
 Remark : LTE_Band 4_QPSK(1,37)_15M_CH20175
 Tested by : Kay Wu
 Plane : Y

	Read	Limit	Over			
Freq	Level	Level	Line	Limit	Factor	Remark
MHz	dBm/m	dBm	dBm/m	dB	dB/m	
1	83.73	-42.52	-31.08	-13.00	-29.52	-11.44 Peak
2	145.02	-49.16	-41.33	-13.00	-36.16	-7.83 Peak
3	246.00	-55.54	-49.98	-13.00	-42.54	-5.56 Peak
4	377.70	-58.84	-54.91	-13.00	-45.84	-3.93 Peak
5	619.20	-67.48	-67.70	-13.00	-54.48	0.22 Peak
6	808.90	-66.52	-68.43	-13.00	-53.52	1.91 Peak
7 pp	3465.00	-38.44	-52.78	-13.00	-25.44	14.34 Peak
8	5197.50	-43.19	-63.31	-13.00	-30.19	20.12 Peak



A D T

LTE BAND 4
CHANNEL BANDWIDTH: 20MHz / QPSK



Bureau Veritas Consumer Products Services Ltd., Taoyuan Branch

A D T

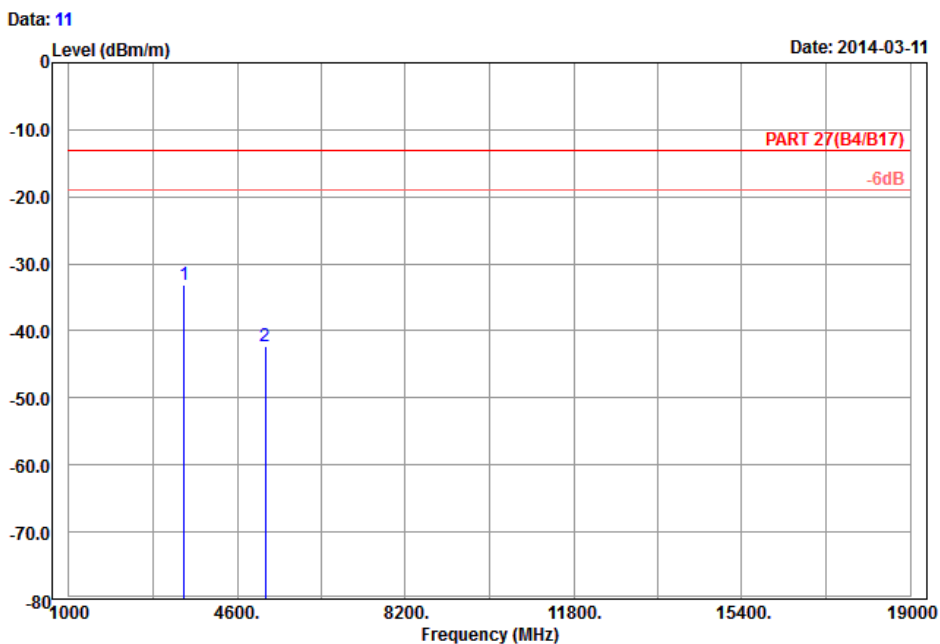

Site : 966 chamber 5
 Condition : PART 27(B4/B17) 3m Horizontal
 Brand/Model: E6782
 Remark : LTE_Band 4_QPSK(1,50)_20M_CH20175
 Tested by : Kay Wu
 Plane : Y

	Freq	Level	Read Level	Limit Line	Over Limit	Factor	Remark
	MHz	dBm/m	dBm	dBm/m	dB	dB/m	
1 pp	3465.00	-33.23	-47.57	-13.00	-20.23	14.34	Peak
2	5197.50	-42.18	-62.30	-13.00	-29.18	20.12	Peak



A D T



Bureau Veritas Consumer Products Services Ltd., Taoyuan Branch

A D T

Data: 12

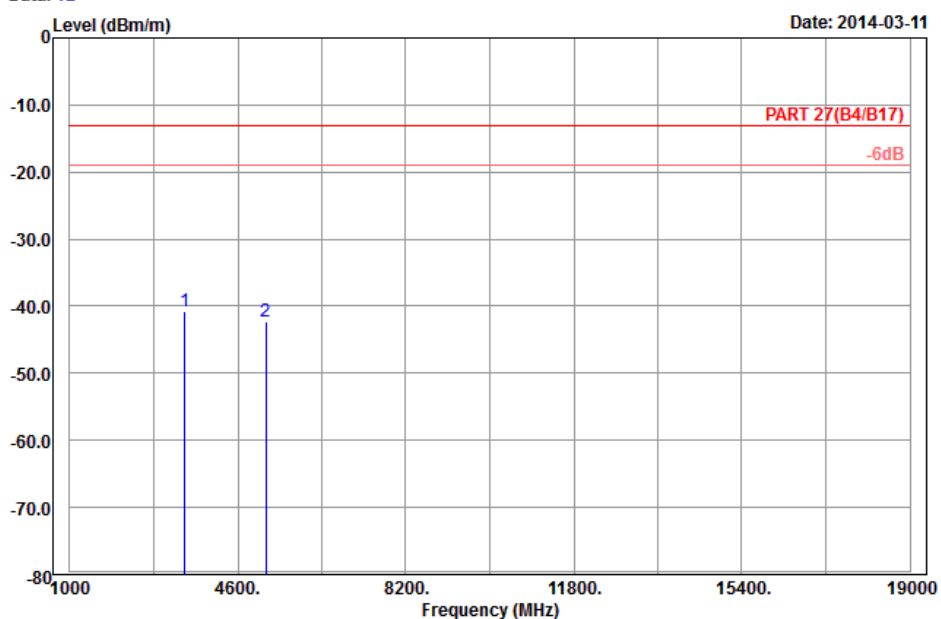

Date: 2014-03-11

Site : 966 chamber 5
 Condition : PART 27(B4/B17) 3m Vertical
 Brand/Model: E6782
 Remark : LTE_Band 4_QPSK(1,50)_20M_CH20175
 Tested by : Kay Wu
 Plane : Y

	Freq	Level	Read Level	Limit Line	Over Limit	Factor	Remark
	MHz	dBm/m	dBm	dBm/m	dB	dB/m	
1	pp 3465.00	-40.70	-55.04	-13.00	-27.70	14.34	Peak
2	5197.50	-42.28	-62.40	-13.00	-29.28	20.12	Peak



5 INFORMATION ON THE TESTING LABORATORIES

We, Bureau Veritas Consumer Products Services (H.K.) Ltd., Taoyuan Branch, were founded in 1988 to provide our best service in EMC, Radio, Telecom and Safety consultation. Our laboratories are accredited and approved according to ISO/IEC 17025.

If you have any comments, please feel free to contact us at the following:

Linko EMC/RF Lab:

Tel: 886-2-26052180

Fax: 886-2-26051924

Hsin Chu EMC/RF Lab:

Tel: 886-3-5935343

Fax: 886-3-5935342

Hwa Ya EMC/RF/Safety/Telecom Lab:

Tel: 886-3-3183232

Fax: 886-3-3270892

Email: service.adt@tw.bureauveritas.com

Web Site: www.adt.com.tw

The address and road map of all our labs can be found in our web site also.



A D T

6 APPENDIX A – MODIFICATIONS RECORDERS FOR ENGINEERING CHANGES TO THE EUT BY THE LAB

No modifications were made to the EUT by the lab during the test.

---END---