



FCC TEST REPORT (15.407)

REPORT NO.: RF140707C19-5
MODEL NO.: E6762
FCC ID: V65E6762
RECEIVED: Jul. 07, 2014
TESTED: Jul. 18, 2014 ~ Aug. 07, 2014
ISSUED: Aug. 19, 2014

APPLICANT: Kyocera Corporation c/o Kyocera Communications, Inc.

ADDRESS: 9520 Towne Centre Drive, Suite 200 San Diego, CA 92121

ISSUED BY: Bureau Veritas Consumer Products Services (H.K.) Ltd., Taoyuan Branch

LAB ADDRESS: No. 47, 14th Ling, Chia Pau Vil., Lin Kou Dist., New Taipei City, Taiwan (R.O.C)

TEST LOCATION: No. 19, Hwa Ya 2nd Rd, Wen Hwa Tsuen, Kwei Shan Hsiang, Taoyuan Hsien 333, Taiwan, R.O.C.

This report should not be used by the client to claim product certification, approval, or endorsement by TAF or any government agencies.



This report is for your exclusive use. Any copying or replication of this report to or for any other person or entity, or use of our name or trademark, is permitted only with our prior written permission. This report sets forth our findings solely with respect to the test samples identified herein. The results set forth in this report are not indicative or representative of the quality or characteristics of the lot from which a test sample was taken or any similar or identical product unless specifically and expressly noted. Our report includes all of the tests requested by you and the results thereof based upon the information that you provided to us. You have 60 days from date of issuance of this report to notify us of any material error or omission caused by our negligence, provided, however, that such notice shall be in writing and shall specifically address the issue you wish to raise. A failure to raise such issue within the prescribed time shall constitute your unqualified acceptance of the completeness of this report, the tests conducted and the correctness of the report contents. Unless specific mention, the uncertainty of measurement has been explicitly taken into account to declare the compliance or non-compliance to the specification.



TABLE OF CONTENTS

RELEASE CONTROL RECORD	4
1. CERTIFICATION.....	5
2. SUMMARY OF TEST RESULTS	6
2.1 MEASUREMENT UNCERTAINTY.....	6
3. GENERAL INFORMATION	7
3.1 GENERAL DESCRIPTION OF EUT	7
3.2 DESCRIPTION OF TEST MODES	8
3.2.1 TEST MODE APPLICABILITY AND TESTED CHANNEL DETAIL.....	10
3.3 DESCRIPTION OF SUPPORT UNITS	13
3.3.1 CONFIGURATION OF SYSTEM UNDER TEST	13
3.4 DUTY CYCLE TEST SIGNAL.....	14
3.5 GENERAL DESCRIPTION OF APPLIED STANDARDS	15
4. TEST TYPES AND RESULTS	16
4.1 RADIATED EMISSION AND BANDEDGE MEASUREMENT	16
4.1.1 LIMITS OF RADIATED EMISSION AND BANDEDGE MEASUREMENT	16
4.1.2 LIMITS OF UNWANTED EMISSION OUT OF THE RESTRICTED BANDS	16
4.1.3 TEST INSTRUMENTS.....	17
4.1.4 TEST PROCEDURES	18
4.1.5 DEVIATION FROM TEST STANDARD	18
4.1.6 TEST SETUP	19
4.1.7 EUT OPERATING CONDITIONS	20
4.1.8 TEST RESULTS.....	21
4.2 CONDUCTED EMISSION MEASUREMENT	58
4.2.1 LIMITS OF CONDUCTED EMISSION MEASUREMENT	58
4.2.2 TEST INSTRUMENTS.....	58
4.2.3 TEST PROCEDURES	59
4.2.4 DEVIATION FROM TEST STANDARD	59
4.2.5 TEST SETUP	60
4.2.6 EUT OPERATING CONDITIONS	60
4.2.7 TEST RESULTS.....	61
4.3 TRANSMIT POWER MEASUREMENT	63
4.3.1 LIMITS OF TRANSMIT POWER MEASUREMENT	63
4.3.2 TEST SETUP	63
4.3.3 TEST INSTRUMENTS.....	63
4.3.4 TEST PROCEDURE	64
4.3.5 DEVIATION FROM TEST STANDARD	64
4.3.6 EUT OPERATING CONDITIONS	64
4.3.7 TEST RESULTS.....	65
4.4 PEAK POWER SPECTRAL DENSITY MEASUREMENT	70
4.4.1 LIMITS OF PEAK POWER SPECTRAL DENSITY MEASUREMENT	70
4.4.2 TEST SETUP	70
4.4.3 TEST INSTRUMENTS.....	70
4.4.4 TEST PROCEDURES	70
4.4.5 DEVIATION FROM TEST STANDARD	71
4.4.6 EUT OPERATING CONDITIONS	71
4.4.7 TEST RESULTS.....	72
4.5 FREQUENCY STABILITY	74
4.5.1 LIMITS OF FREQUENCY STABILITY MEASUREMENT	74
4.5.2 TEST SETUP	74
4.5.3 TEST INSTRUMENTS.....	74
4.5.4 TEST PROCEDURE	75
4.5.5 DEVIATION FROM TEST STANDARD	75



A D T

4.5.6	EUT OPERATING CONDITION.....	75
4.5.7	TEST RESULTS.....	76
4.6	6dB BANDWIDTH MEASUREMENT	77
4.6.1	LIMITS OF 6dB BANDWIDTH MEASUREMENT	77
4.6.2	TEST SETUP	77
4.6.3	TEST INSTRUMENTS	77
4.6.4	TEST PROCEDURE	77
4.6.5	DEVIATION FROM TEST STANDARD	77
4.6.6	EUT OPERATING CONDITIONS	77
4.6.7	TEST RESULTS.....	78
5.	PHOTOGRAPHS OF THE TEST CONFIGURATION.....	80
6.	INFORMATION ON THE TESTING LABORATORIES	81
7.	APPENDIX A - MODIFICATIONS RECORDERS FOR ENGINEERING CHANGES TO THE EUT BY THE LAB	82



A D T

RELEASE CONTROL RECORD

ISSUE NO.	REASON FOR CHANGE	DATE ISSUED
RF140707C19-5	Original release	Aug. 19, 2014



1. CERTIFICATION

PRODUCT: PDA Phone
MODEL NO.: E6762
BRAND: Kyocera
APPLICANT: Kyocera Corporation c/o Kyocera Communications, Inc.
TESTED: Jul. 18, 2014 ~ Aug. 07, 2014
TEST SAMPLE: Identical Prototype
STANDARDS: **FCC Part 15, Subpart E (Section 15.407)**
ANSI C63.10-2009

The above equipment (model: E6762) has been tested by **Bureau Veritas Consumer Products Services (H.K.) Ltd., Taoyuan Branch**, and found compliance with the requirement of the above standards. The test record, data evaluation & Equipment Under Test (EUT) configurations represented herein are true and accurate accounts of the measurements of the sample's EMC characteristics under the conditions specified in this report.

PREPARED BY : Gina Liu , **DATE** : Aug. 19, 2014
Gina Liu / Specialist

APPROVED BY : Sam Chen , **DATE** : Aug. 19, 2014
Sam Chen / Senior Project Engineer

2. SUMMARY OF TEST RESULTS

The EUT has been tested according to the following specifications:

APPLIED STANDARD: FCC PART 15, SUBPART E (SECTION 15.407)			
STANDARD SECTION	TEST TYPE	RESULT	REMARK
15.407(b)(6)	AC Power Conducted Emission	PASS	Meet the requirement of limit. Minimum passing margin is -10.92dB at 0.48626MHz.
15.407(b/1/2/3) (b)(6)	Radiated Emissions	PASS	Meet the requirement of limit. Minimum passing margin is -5.49dB at 5725MHz.
15.407(a/1/2/3)	Max Average Transmit Power	PASS	Meet the requirement of limit.
15.407(a)(6)	Peak Power Excursion	PASS	Meet the requirement of limit.
15.407(a/1/2/3)	Peak Power Spectral Density	PASS	Meet the requirement of limit.
15.407(e)	6dB bandwidth	PASS	Meet the requirement of limit. (U-NII-3 Band only)
15.407(g)	Frequency Stability	PASS	Meet the requirement of limit.
15.203	Antenna Requirement	PASS	No antenna connector is used.

2.1 MEASUREMENT UNCERTAINTY

Where relevant, the following measurement uncertainty levels have been estimated for tests performed on the EUT as specified in CISPR 16-4-2:

MEASUREMENT	FREQUENCY	UNCERTAINTY
Conducted emissions	9kHz~30MHz	2.44 dB
Radiated emissions	30MHz ~ 200MHz	2.93 dB
	200MHz ~1000MHz	2.95 dB
	1GHz ~ 18GHz	2.26 dB
	18GHz ~ 40GHz	1.94 dB

This uncertainty represents an expanded uncertainty expressed at approximately the 95% confidence level using a coverage factor of $k = 2$.

3. GENERAL INFORMATION

3.1 GENERAL DESCRIPTION OF EUT

EUT	PDA Phone
MODEL NO.	E6762
POWER SUPPLY	5.0Vdc (adapter or host equipment) 3.8Vdc (Li-ion battery)
MODULATION TYPE	64QAM, 16QAM, QPSK, BPSK
MODULATION TECHNOLOGY	OFDM
TRANSFER RATE	802.11a: 54.0/ 48.0/ 36.0/ 24.0/ 18.0/ 12.0/ 9.0/ 6.0Mbps 802.11n: up to MCS7
OPERATING FREQUENCY	5180 ~ 5240MHz, 5260 ~ 5320MHz & 5500 ~ 5700MHz, 5745 ~ 5825MHz
NUMBER OF CHANNEL	5180 ~ 5240MHz: 4 for 802.11a, 802.11n (20MHz) 2 for 802.11n (40MHz) 5260 ~ 5320MHz: 4 for 802.11a, 802.11n (20MHz) 2 for 802.11n (40MHz) 5500 ~ 5700MHz: 8 for 802.11a, 802.11n (20MHz) 3 for 802.11n (40MHz) 5745 ~ 5825MHz: 5 for 802.11a, 802.11n (20MHz) 2 for 802.11n (40MHz)
OUTPUT POWER	23.23mW for 5180 ~ 5240MHz 24.43mW for 5260 ~ 5320MHz 20.04mW for 5500 ~ 5700MHz 108.89mW for 5745 ~ 5825MHz
ANTENNA TYPE	Monopole antenna with -0.7dBi gain (5180 ~ 5240MHz) Monopole antenna with -1.1dBi gain (5260 ~ 5320MHz) Monopole antenna with -0.8dBi gain (5500 ~ 5700MHz) Monopole antenna with -0.6dBi gain (5745 ~ 5825MHz)
ANTENNA CONNECTOR	NA
DATA CABLE	Refer to Note as below
I/O PORTS	Refer to user's manual
ACCESSORY DEVICES	Refer to Note as below

NOTE:

- The EUT contains following accessory devices.

ITEM	BRAND	MODEL	SPECIFICATION
Adapter	Kyocera	SCP-44ADT	I/P: 100-240Vac, 50/60Hz, 0.25A O/P: 5Vdc, 1.5A
Battery	Sanyo	SCP-60LBPS	3.8Vdc, 3000mAh
Earphone	GALIEN	HF-HB04D	1.2m non-shielded cable w/o core
USB Cable	Kyocera	SCP-17SDC	1.0m non-shielded cable w/o core
Wireless charging	LG	WCP-300.	--

- The above EUT information is declared by the manufacturer and for more detailed features description, please refer to the manufacturer's specifications or User's Manual.

3.2 DESCRIPTION OF TEST MODES

WLAN 5180 ~ 5240MHz

4 channels are provided for 802.11a, 802.11n (20MHz):

CHANNEL	FREQUENCY	CHANNEL	FREQUENCY
36	5180 MHz	44	5220 MHz
40	5200 MHz	48	5240 MHz

2 channels are provided for 802.11n (40MHz):

CHANNEL	FREQUENCY	CHANNEL	FREQUENCY
38	5190 MHz	46	5230 MHz

FOR 5260 ~ 5320MHz

4 channels are provided for 802.11a, 802.11n (20MHz):

CHANNEL	FREQUENCY	CHANNEL	FREQUENCY
52	5260 MHz	60	5300 MHz
56	5280 MHz	64	5320 MHz

2 channels are provided for 802.11n (40MHz):

CHANNEL	FREQUENCY	CHANNEL	FREQUENCY
54	5270 MHz	62	5310 MHz

WLAN 5500 ~ 5700MHz

8 channels are provided for 802.11a, 802.11n (20MHz):

CHANNEL	FREQUENCY	CHANNEL	FREQUENCY
100	5500MHz	116	5580MHz
104	5520MHz	132	5660MHz
108	5540MHz	136	5680MHz
112	5560MHz	140	5700MHz

3 channels are provided for 802.11n (40MHz):

CHANNEL	FREQUENCY	CHANNEL	FREQUENCY
102	5510MHz	134	5670MHz
110	5550MHz		

FOR 5.0GHz (5745 ~ 5825MHz):

5 channels are provided for 802.11a, 802.11n (20MHz):

CHANNEL	FREQUENCY	CHANNEL	FREQUENCY
149	5745MHz	161	5805MHz
153	5765MHz	165	5825MHz
157	5785MHz		

2 channels are provided for 802.11n (40MHz):

CHANNEL	FREQUENCY	CHANNEL	FREQUENCY
151	5755MHz	159	5795MHz



A D T

3.2.1 TEST MODE APPLICABILITY AND TESTED CHANNEL DETAIL

EUT CONFIGURE MODE	APPLICABLE TO				DESCRIPTION
	RE≥1G	RE<1G	PLC	APCM	
-	√	√	√	√	-

Where **RE≥1G**: Radiated Emission above 1GHz **RE<1G**: Radiated Emission below 1GHz
PLC: Power Line Conducted Emission **APCM**: Antenna Port Conducted Measurement

NOTE: The EUT had been pre-tested on the positioned of each 3 axis. The worst case was found when positioned on **Z-plane** for Band 1~3 and **Y-plane** for Band 4.

RADIATED EMISSION TEST (ABOVE 1GHz):

Pre-Scan has been conducted to determine the worst-case mode from all possible combinations between available modulations, data rates and antenna ports (if EUT with antenna diversity architecture).

Following channel(s) was (were) selected for the final test as listed below.

EUT CONFIGURE MODE	MODE	FREQ. BAND (MHz)	AVAILABLE CHANNEL	TESTED CHANNEL	MODULATION TECHNOLOGY	MODULATION TYPE	DATA RATE (Mbps)
-	802.11a	5180-5240	36 to 48	36, 44, 48	OFDM	BPSK	6.0
	802.11n (20MHz)		36 to 48	36, 44, 48	OFDM	BPSK	MCS0
	802.11n (40MHz)		38 to 46	38, 46	OFDM	BPSK	MCS0
-	802.11a	5260-5320	52 to 64	52, 60, 64	OFDM	BPSK	6.0
	802.11n (20MHz)		52 to 64	52, 60, 64	OFDM	BPSK	MCS0
	802.11n (40MHz)		54 to 62	54, 62	OFDM	BPSK	MCS0
-	802.11a	5500-5700	100 to 140	100, 116, 140	OFDM	BPSK	6.0
	802.11n (20MHz)		100 to 140	100, 116, 140	OFDM	BPSK	MCS0
	802.11n (40MHz)		102 to 134	102, 110, 134	OFDM	BPSK	MCS0
-	802.11a	5745-5825	149 to 161	149, 157, 165	OFDM	BPSK	6.0
	802.11n (20MHz)		149 to 161	149, 157, 165	OFDM	BPSK	MCS0
	802.11n (40MHz)		151 to 159	151, 159	OFDM	BPSK	MCS0

RADIATED EMISSION TEST (BELOW 1GHz):

Pre-Scan has been conducted to determine the worst-case mode from all possible combinations between available modulations, data rates and antenna ports (if EUT with antenna diversity architecture).

Following channel(s) was (were) selected for the final test as listed below.

EUT CONFIGURE MODE	MODE	FREQ. BAND (MHz)	AVAILABLE CHANNEL	TESTED CHANNEL	MODULATION TECHNOLOGY	MODULATION TYPE	DATA RATE (Mbps)
-	802.11a	5180-5240	36 to 48	48	OFDM	BPSK	MCS0
-	802.11a	5260-5320	52 to 64	60	OFDM	BPSK	6.0
-	802.11a	5500-5700	100 to 140	116	OFDM	BPSK	MCS0
-	802.11n (20MHz)	5745-5825	149 to 161	157	OFDM	BPSK	MCS0



POWER LINE CONDUCTED EMISSION TEST:

EUT CONFIGURE MODE	MODE	FREQ. BAND (MHz)	AVAILABLE CHANNEL	TESTED CHANNEL	MODULATION TECHNOLOGY	MODULATION TYPE	DATA RATE (Mbps)
-	802.11n (20MHz)	5745-5825	149 to 161	157	OFDM	BPSK	MCS0

BANDEDGE MEASUREMENT:

Pre-Scan has been conducted to determine the worst-case mode from all possible combinations between available modulations, data rates and antenna ports (if EUT with antenna diversity architecture).

Following channel(s) was (were) selected for the final test as listed below.

EUT CONFIGURE MODE	MODE	FREQ. BAND (MHz)	AVAILABLE CHANNEL	TESTED CHANNEL	MODULATION TECHNOLOGY	MODULATION TYPE	DATA RATE (Mbps)
-	802.11a	5180-5240	36 to 48	36, 44, 48	OFDM	BPSK	6.0
	802.11n (20MHz)		36 to 48	36, 44, 48	OFDM	BPSK	MCS0
	802.11n (40MHz)		38 to 46	38, 46	OFDM	BPSK	MCS0
-	802.11a	5260-5320	52 to 64	52, 60, 64	OFDM	BPSK	6.0
	802.11n (20MHz)		52 to 64	52, 60, 64	OFDM	BPSK	MCS0
	802.11n (40MHz)		54 to 62	54, 62	OFDM	BPSK	MCS0
-	802.11a	5500-5700	100 to 140	100, 116, 140	OFDM	BPSK	6.0
	802.11n (20MHz)		100 to 140	100, 116, 140	OFDM	BPSK	MCS0
	802.11n (40MHz)		102 to 134	102, 110, 134	OFDM	BPSK	MCS0
-	802.11a	5745-5825	149 to 161	149, 157, 165	OFDM	BPSK	6.0
	802.11n (20MHz)		149 to 161	149, 157, 165	OFDM	BPSK	MCS0
	802.11n (40MHz)		151 to 159	151, 159	OFDM	BPSK	MCS0



A D T

ANTENNA PORT CONDUCTED MEASUREMENT:

- This item includes all test value of each mode, but only includes spectrum plot of worst value of each mode.
- Pre-Scan has been conducted to determine the worst-case mode from all possible combinations between available modulations, data rates and antenna ports (if EUT with antenna diversity architecture).
- Following channel(s) was (were) selected for the final test as listed below.

EUT CONFIGURE MODE	MODE	FREQ. BAND (MHz)	AVAILABLE CHANNEL	TESTED CHANNEL	MODULATION TECHNOLOGY	MODULATION TYPE	DATA RATE (Mbps)
-	802.11a	5180-5240	36 to 48	36, 44, 48	OFDM	BPSK	6.0
	802.11n (20MHz)		36 to 48	36, 44, 48	OFDM	BPSK	MCS0
	802.11n (40MHz)		38 to 46	38, 46	OFDM	BPSK	MCS0
-	802.11a	5260-5320	52 to 64	52, 60, 64	OFDM	BPSK	6.0
	802.11n (20MHz)		52 to 64	52, 60, 64	OFDM	BPSK	MCS0
	802.11n (40MHz)		54 to 62	54, 62	OFDM	BPSK	MCS0
-	802.11a	5500-5700	100 to 140	100, 116, 140	OFDM	BPSK	6.0
	802.11n (20MHz)		100 to 140	100, 116, 140	OFDM	BPSK	MCS0
	802.11n (40MHz)		102 to 134	102, 110, 134	OFDM	BPSK	MCS0
-	802.11a	5745-5825	149 to 161	149, 157, 165	OFDM	BPSK	6.0
	802.11n (20MHz)		149 to 161	149, 157, 165	OFDM	BPSK	MCS0
	802.11n (40MHz)		151 to 159	151, 159	OFDM	BPSK	MCS0

Test CONDITION:

APPLICABLE TO	ENVIRONMENTAL CONDITIONS	INPUT POWER	TESTED BY
RE≥1G	25deg. C, 65%RH	120Vac, 60Hz	Anson Lin
RE<1G	25deg. C, 65%RH	120Vac, 60Hz	Anson Lin
PLC	25deg. C, 65%RH	120Vac, 60Hz	Gavin Wu
APCM	25deg. C, 65%RH	120Vac, 60Hz	Howard Huang

3.3 DESCRIPTION OF SUPPORT UNITS

The EUT has been tested as an independent unit together with other necessary accessories or support units.

3.3.1 CONFIGURATION OF SYSTEM UNDER TEST

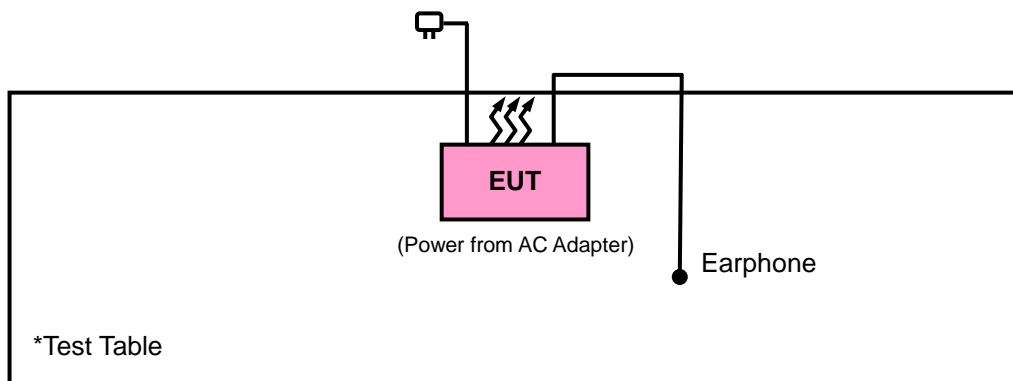



A D T

3.4 DUTY CYCLE TEST SIGNAL

MODULATION TYPE: BPSK

802.11a: Duty cycle = $2.019/2.532 = 0.797$, Duty factor = $10 * \log(1/0.797) = 0.98$

802.11n (20MHz): Duty cycle = $1.88/2.395 = 0.785$, Duty factor = $10 * \log(1/0.785) = 1.05$

802.11n (40MHz): Duty cycle = $0.897/1.426 = 0.629$, Duty factor = $10 * \log(1/0.629) = 2.01$

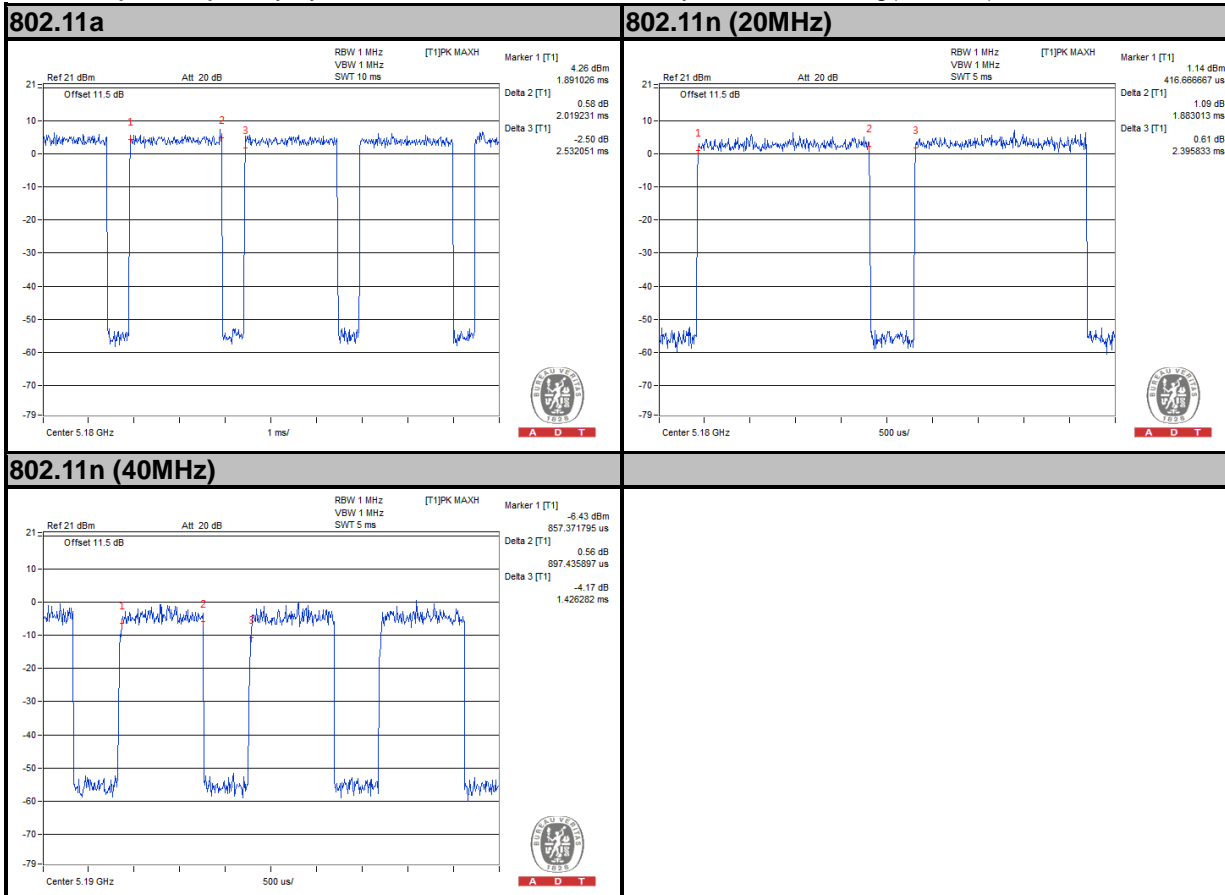



3.5 GENERAL DESCRIPTION OF APPLIED STANDARDS

The EUT is a RF Product. According to the specifications of the manufacturer, it must comply with the requirements of the following standards:

FCC Part 15, Subpart E (15.407)

789033 D02 General UNII Test Procedures New Rules v01

ANSI C63.10-2009

All test items have been performed and recorded as per the above standards.

NOTE: The EUT has been verified to comply with the requirements of FCC Part 15, Subpart B, Class B (DoC). The test report has been issued separately.

4. TEST TYPES AND RESULTS

4.1 RADIATED EMISSION AND BANDEDGE MEASUREMENT

4.1.1 LIMITS OF RADIATED EMISSION AND BANDEDGE MEASUREMENT

Radiated emissions which fall in the restricted bands must comply with the radiated emission limits specified as below table:

FREQUENCIES (MHz)	FIELD STRENGTH (microvolts/meter)	MEASUREMENT DISTANCE (meters)
0.009 ~ 0.490	2400/F(kHz)	300
0.490 ~ 1.705	24000/F(kHz)	30
1.705 ~ 30.0	30	30
30 ~ 88	100	3
88 ~ 216	150	3
216 ~ 960	200	3
Above 960	500	3

NOTE:

1. The lower limit shall apply at the transition frequencies.
2. Emission level (dBuV/m) = 20 log Emission level (uV/m).
3. For frequencies above 1000MHz, the field strength limits are based on average detector, however, the peak field strength of any emission shall not exceed the maximum permitted average limits, specified above by more than 20dB under any condition of modulation.

4.1.2 LIMITS OF UNWANTED EMISSION OUT OF THE RESTRICTED BANDS

APPLICABLE TO	LIMIT	
789033 D02 General UNII Test Procedures New Rules v01	FIELD STRENGTH AT 3m	
	PK: 74 (dBµV/m)	AV: 54 (dBµV/m)
APPLICABLE TO	EIRP LIMIT	EQUIVALENT FIELD STRENGTH AT 3m
15.407(b)(1)	PK: -27 (dBm/MHz)	PK: 68.3 (dBµV/m)
15.407(b)(2)		
15.407(b)(3)		
15.407(b)(4)	PK: -27 (dBm/MHz) ^{*1} PK: -17 (dBm/MHz) ^{*2}	PK: 68.3 (dBµV/m) ^{*1} PK: 78.3 (dBµV/m) ^{*2}

NOTE: ^{*1} beyond 10MHz of the band edge ^{*2} within 10 MHz of band edge

The following formula is used to convert the equipment isotropic radiated power (eirp) to field strength:

$$E = \frac{1000000\sqrt{30P}}{3} \mu\text{V/m, where P is the eirp (Watts).}$$



A D T

4.1.3 TEST INSTRUMENTS

DESCRIPTION & MANUFACTURER	MODEL NO.	SERIAL NO.	DATE OF CALIBRATION	DUE DATE OF CALIBRATION
Test Receiver AGILENT	N9038A	MY51210203	Jan. 17, 2014	Jan. 16, 2015
Spectrum Analyzer ROHDE & SCHWARZ	FSU43	101261	Dec. 21, 2013	Dec. 20, 2014
BILOG Antenna SCHWARZBECK	VULB9168	9168-472	Feb. 27, 2014	Feb. 26, 2015
HORN Antenna SCHWARZBECK	BBHA 9120 D	9120D-969	Feb. 19, 2014	Feb. 18, 2015
HORN Antenna SCHWARZBECK	BBHA 9170	9170-480	Dec. 18, 2013	Dec. 17, 2014
Loop Antenna	HFH2-Z2	100070	Mar. 06, 2014	Mar. 05, 2016
Preamplifier EMCI	EMC 012645	980115	Dec. 26, 2013	Dec. 25, 2014
Preamplifier EMCI	EMC 184045	980116	Jan. 13, 2014	Jan. 12, 2015
Preamplifier EMCI	EMC 330H	980112	Dec. 27, 2013	Dec. 26, 2014
RF signal cable HUBER+SUHNNER	SUCOFLEX 104	309219/4 2950114	Oct. 18, 2013	Oct. 17, 2014
RF signal cable HUBER+SUHNNER	SUCOFLEX 104	250130/4	Oct. 18, 2013	Oct. 17, 2014
RF signal cable Worken	RG-213	NA	Nov. 07, 2013	Nov. 06, 2014
Software BV ADT	E3 6.120103	NA	NA	NA
Antenna Tower MF	MFA-440H	NA	NA	NA
Turn Table MF	MFT-201SS	NA	NA	NA
Antenna Tower & Turn Table Controller MF	MF-7802	NA	NA	NA
Power Meter	ML2495A	1232002	Aug. 23, 2013	Aug. 22, 2014
Power Sensor	MA2411B	1207325	Aug. 23, 2013	Aug. 22, 2014

- NOTE:**
1. The calibration interval of the above test instruments is 12 months and the calibrations are traceable to NML/ROC and NIST/USA.
 2. The calibration interval of the loop antenna is 24 months and the calibrations are traceable to NML/ROC and NIST/USA.
 3. The test was performed in HwaYa Chamber 10.
 4. The horn antenna and HP preamplifier (model: 8449B) are used only for the measurement of emission frequency above 1GHz if tested.
 5. The FCC Site Registration No. is 690701.
 6. The IC Site Registration No. is IC 7450F-10.

4.1.4 TEST PROCEDURES

- a. The EUT was placed on the top of a rotating table 0.8 meters above the ground at a 3 meters semi-anechoic chamber. The table was rotated 360 degrees to determine the position of the highest radiation.
- b. The EUT was set 3 meters away from the interference-receiving antenna, which was mounted on the top of a variable-height antenna tower.
- c. The antenna is a broadband antenna, and its height is varied from one meter to four meters above the ground to determine the maximum value of the field strength. Both horizontal and vertical polarizations of the antenna are set to make the measurement.
- d. For each suspected emission, the EUT was arranged to its worst case and then the antenna was tuned to heights from 1 meter to 4 meters and the rotatable table was turned from 0 degrees to 360 degrees to find the maximum reading.
- e. The test-receiver system was set to Peak Detect Function and Specified Bandwidth with Maximum Hold Mode.
- f. If the emission level of the EUT in peak mode was 10dB lower than the limit specified, then testing could be stopped and the peak values of the EUT would be reported. Otherwise the emissions that did not have 10dB margin would be re-tested one by one using peak, quasi-peak or average method as specified and then reported in a data sheet.

NOTE:

1. The resolution bandwidth and video bandwidth of test receiver/spectrum analyzer is 120kHz for Peak detection (PK) and Quasi-peak detection (QP) at frequency below 1GHz.
2. The resolution bandwidth of test receiver/spectrum analyzer is 1MHz and video bandwidth is 3MHz for Peak detection at frequency above 1GHz.
3. The resolution bandwidth of test receiver/spectrum analyzer is 1MHz and the video bandwidth is 1kHz (Duty cycle < 98%) or 10Hz (Duty cycle > 98%) for Average detection (AV) at frequency above 1GHz.
4. All modes of operation were investigated and the worst-case emissions are reported.

4.1.5 DEVIATION FROM TEST STANDARD

No deviation.

4.1.6 TEST SETUP

Frequency Range 30MHz ~ 1GHz

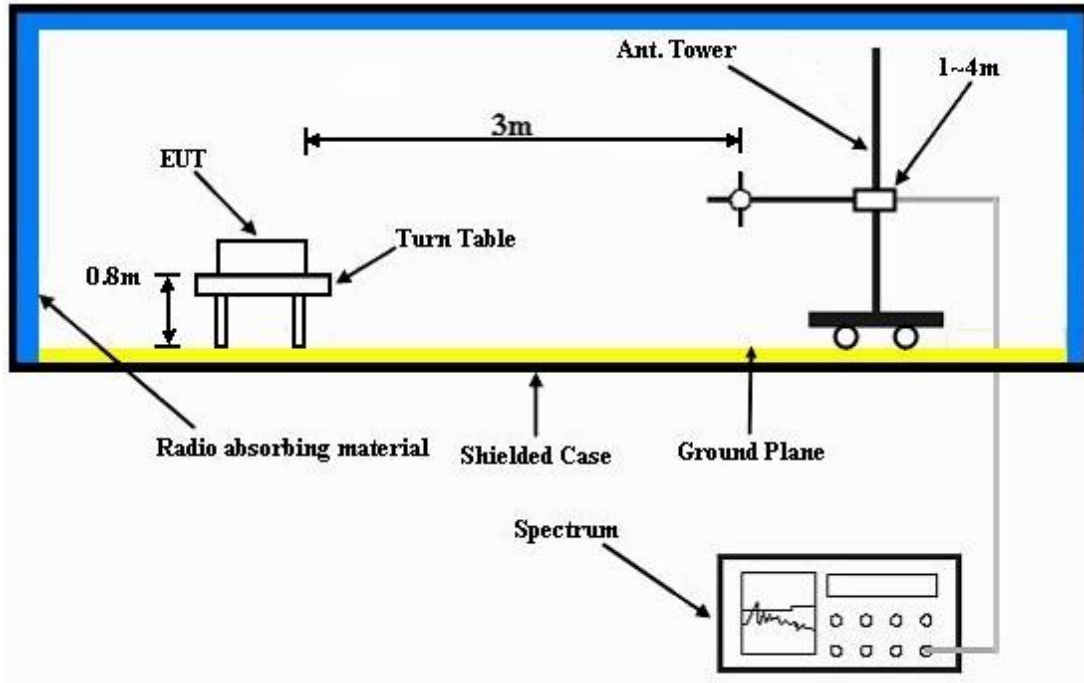

Frequency Range above 1GHz

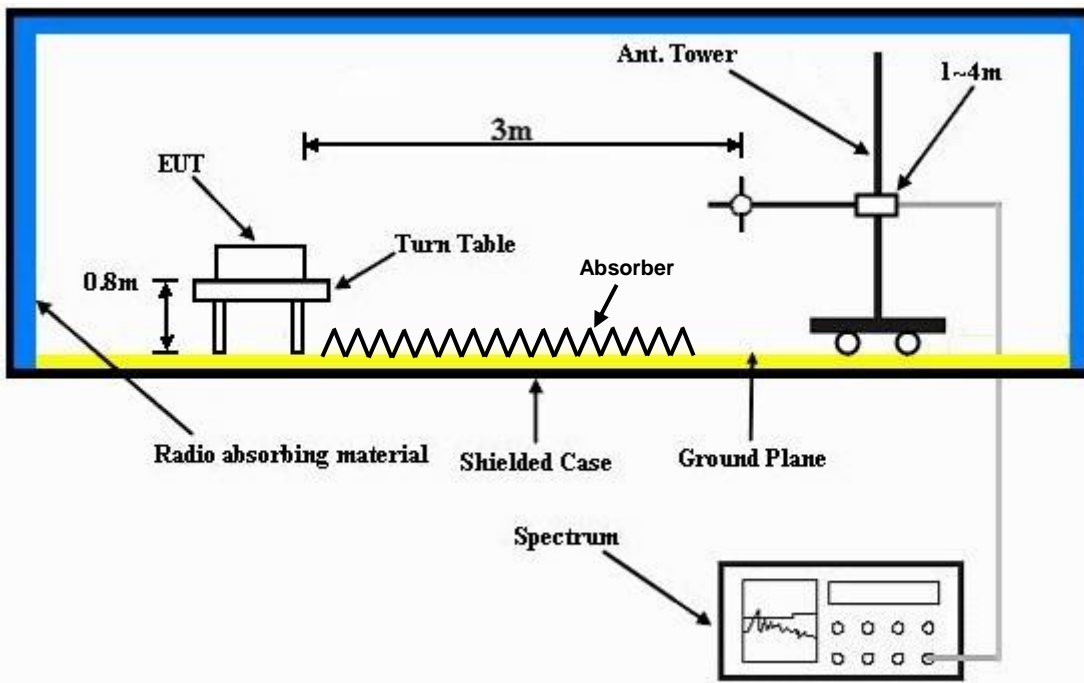

For the actual test configuration, please refer to the attached file (Test Setup Photo).



A D T

4.1.7 EUT OPERATING CONDITIONS

- a. Placed the EUT on a testing table.
- b. Use the software to control the EUT under transmission condition continuously at specific channel frequency.



A D T

4.1.8 TEST RESULTS

ABOVE 1GHz WORST-CASE DATA

802.11a

EUT TEST CONDITION		MEASUREMENT DETAIL	
CHANNEL	Channel 36	FREQUENCY RANGE	1GHz ~ 40GHz
INPUT POWER	120Vac, 60 Hz	DETECTOR FUNCTION	Peak (PK) Average (AV)
ENVIRONMENTAL CONDITIONS	25deg. C, 65%RH	TESTED BY	Anson Lin

ANTENNA POLARITY & TEST DISTANCE: HORIZONTAL AT 3 M

FREQ. (MHz)	EMISSION LEVEL (dBuV/m)	READ LEVEL (dBuV)	LIMIT (dBuV/m)	MARGIN (dB)	ANTENNA FACTOR (dB/m)	CABLE LOSS (dB)	PREAMP FACTOR (dB)	ANTENNA HEIGHT (cm)	TABLE ANGLE (Degree)	REMARK
5148	43.7	44.41	54	-10.3	31.32	5.29	37.32	108	193	Average
5148	59.79	60.5	74	-14.21	31.32	5.29	37.32	108	193	Peak
5180	96.9	97.58			31.35	5.31	37.34	108	193	Average
5180	106.41	107.09			31.35	5.31	37.34	108	193	Peak
5372	37.9	38.19	54	-16.1	31.49	5.4	37.18	108	193	Average
5372	60.43	60.72	74	-13.57	31.49	5.4	37.18	108	193	Peak

ANTENNA POLARITY & TEST DISTANCE: VERTICAL AT 3 M

FREQ. (MHz)	EMISSION LEVEL (dBuV/m)	READ LEVEL (dBuV)	LIMIT (dBuV/m)	MARGIN (dB)	ANTENNA FACTOR (dB/m)	CABLE LOSS (dB)	PREAMP FACTOR (dB)	ANTENNA HEIGHT (cm)	TABLE ANGLE (Degree)	REMARK
5058	39.37	40.12	54	-14.63	31.25	5.25	37.25	114	354	Average
5058	59.47	60.22	74	-14.53	31.25	5.25	37.25	114	354	Peak
5180	87.5	88.18			31.35	5.31	37.34	114	354	Average
5180	98.76	99.44			31.35	5.31	37.34	114	354	Peak
5356	37.65	37.96	54	-16.35	31.48	5.39	37.18	114	354	Average
5356	59.18	59.49	74	-14.82	31.48	5.39	37.18	114	354	Peak

REMARKS:

- Emission Level = Read Level + Antenna Factor + Cable Loss - Preamp Factor
Margin value = Emission level – Limit value
- 5180MHz: Fundamental frequency.



A D T

EUT TEST CONDITION		MEASUREMENT DETAIL	
CHANNEL	Channel 44	FREQUENCY RANGE	1GHz ~ 40GHz
INPUT POWER	120Vac, 60 Hz	DETECTOR FUNCTION	Peak (PK) Average (AV)
ENVIRONMENTAL CONDITIONS	25deg. C, 65%RH	TESTED BY	Anson Lin

ANTENNA POLARITY & TEST DISTANCE: HORIZONTAL AT 3 M										
FREQ. (MHz)	EMISSION LEVEL (dBuV/m)	READ LEVEL (dBuV)	LIMIT (dBuV/m)	MARGIN (dB)	ANTENNA FACTOR (dB/m)	CABLE LOSS (dB)	PREAMP FACTOR (dB)	ANTENNA HEIGHT (cm)	TABLE ANGLE (Degree)	REMARK
5100	37.79	38.52	54	-16.21	31.28	5.27	37.28	107	194	Average
5100	59.87	60.6	74	-14.13	31.28	5.27	37.28	107	194	Peak
5220	96.88	97.54			31.37	5.33	37.36	107	194	Average
5220	106.11	106.77			31.37	5.33	37.36	107	194	Peak
5438	38.13	38.27	54	-15.87	31.55	5.44	37.13	107	194	Average
5438	59.66	59.8	74	-14.34	31.55	5.44	37.13	107	194	Peak

ANTENNA POLARITY & TEST DISTANCE: VERTICAL AT 3 M										
FREQ. (MHz)	EMISSION LEVEL (dBuV/m)	READ LEVEL (dBuV)	LIMIT (dBuV/m)	MARGIN (dB)	ANTENNA FACTOR (dB/m)	CABLE LOSS (dB)	PREAMP FACTOR (dB)	ANTENNA HEIGHT (cm)	TABLE ANGLE (Degree)	REMARK
5150	37.79	38.5	54	-16.21	31.32	5.29	37.32	114	354	Average
5150	58.69	59.4	74	-15.31	31.32	5.29	37.32	114	354	Peak
5220	88.71	89.37			31.37	5.33	37.36	114	354	Average
5220	98.21	98.87			31.37	5.33	37.36	114	354	Peak
5424	37.53	37.76	54	-16.47	31.53	5.42	37.18	114	354	Average
5424	59.66	59.89	74	-14.34	31.53	5.42	37.18	114	354	Peak

REMARKS:

- Emission Level = Read Level + Antenna Factor + Cable Loss - Preamp Factor
Margin value = Emission level – Limit value
- 5220MHz: Fundamental frequency.



A D T

EUT TEST CONDITION		MEASUREMENT DETAIL	
CHANNEL	Channel 48	FREQUENCY RANGE	1GHz ~ 40GHz
INPUT POWER	120Vac, 60 Hz	DETECTOR FUNCTION	Peak (PK) Average (AV)
ENVIRONMENTAL CONDITIONS	25deg. C, 65%RH	TESTED BY	Anson Lin

ANTENNA POLARITY & TEST DISTANCE: HORIZONTAL AT 3 M										
FREQ. (MHz)	EMISSION LEVEL (dBuV/m)	READ LEVEL (dBuV)	LIMIT (dBuV/m)	MARGIN (dB)	ANTENNA FACTOR (dB/m)	CABLE LOSS (dB)	PREAMP FACTOR (dB)	ANTENNA HEIGHT (cm)	TABLE ANGLE (Degree)	REMARK
5016	37.46	38.24	54	-16.54	31.21	5.24	37.23	107	194	Average
5016	58.77	59.55	74	-15.23	31.21	5.24	37.23	107	194	Peak
5240	97.26	97.85			31.39	5.34	37.32	107	194	Average
5240	106.25	106.84			31.39	5.34	37.32	107	194	Peak
5430	38.26	38.42	54	-15.74	31.55	5.42	37.13	107	194	Average
5430	59.54	59.7	74	-14.46	31.55	5.42	37.13	107	194	Peak

ANTENNA POLARITY & TEST DISTANCE: VERTICAL AT 3 M										
FREQ. (MHz)	EMISSION LEVEL (dBuV/m)	READ LEVEL (dBuV)	LIMIT (dBuV/m)	MARGIN (dB)	ANTENNA FACTOR (dB/m)	CABLE LOSS (dB)	PREAMP FACTOR (dB)	ANTENNA HEIGHT (cm)	TABLE ANGLE (Degree)	REMARK
5144	37.54	38.25	54	-16.46	31.32	5.29	37.32	100	357	Average
5144	59.2	59.91	74	-14.8	31.32	5.29	37.32	100	357	Peak
5240	88.9	89.49			31.39	5.34	37.32	100	357	Average
5240	98.26	98.85			31.39	5.34	37.32	100	357	Peak
5392	37.76	38.02	54	-16.24	31.51	5.41	37.18	100	357	Average
5392	59.84	60.1	74	-14.16	31.51	5.41	37.18	100	357	Peak

REMARKS:

- Emission Level = Read Level + Antenna Factor + Cable Loss - Preamp Factor
Margin value = Emission level – Limit value
- 5240MHz: Fundamental frequency.



A D T

EUT TEST CONDITION		MEASUREMENT DETAIL	
CHANNEL	Channel 52	FREQUENCY RANGE	1GHz ~ 40GHz
INPUT POWER	120Vac, 60 Hz	DETECTOR FUNCTION	Peak (PK) Average (AV)
ENVIRONMENTAL CONDITIONS	25deg. C, 65%RH	TESTED BY	Anson Lin

ANTENNA POLARITY & TEST DISTANCE: HORIZONTAL AT 3 M										
FREQ. (MHz)	EMISSION LEVEL (dBuV/m)	READ LEVEL (dBuV)	LIMIT (dBuV/m)	MARGIN (dB)	ANTENNA FACTOR (dB/m)	CABLE LOSS (dB)	PREAMP FACTOR (dB)	ANTENNA HEIGHT (cm)	TABLE ANGLE (Degree)	REMARK
5058	37.55	38.3	54	-16.45	31.25	5.25	37.25	102	228	Average
5058	59.27	60.02	74	-14.73	31.25	5.25	37.25	102	228	Peak
5260	94.38	94.9			31.41	5.34	37.27	102	228	Average
5260	104.21	104.73			31.41	5.34	37.27	102	228	Peak
5440	37.99	38.13	54	-16.01	31.55	5.44	37.13	102	228	Average
5440	60.32	60.46	74	-13.68	31.55	5.44	37.13	102	228	Peak

ANTENNA POLARITY & TEST DISTANCE: VERTICAL AT 3 M										
FREQ. (MHz)	EMISSION LEVEL (dBuV/m)	READ LEVEL (dBuV)	LIMIT (dBuV/m)	MARGIN (dB)	ANTENNA FACTOR (dB/m)	CABLE LOSS (dB)	PREAMP FACTOR (dB)	ANTENNA HEIGHT (cm)	TABLE ANGLE (Degree)	REMARK
5094	37.61	38.34	54	-16.39	31.28	5.27	37.28	111	0	Average
5094	58.98	59.71	74	-15.02	31.28	5.27	37.28	111	0	Peak
5260	89.49	90.01			31.41	5.34	37.27	111	0	Average
5260	98.43	98.95			31.41	5.34	37.27	111	0	Peak
5392	37.68	37.94	54	-16.32	31.51	5.41	37.18	111	0	Average
5392	59.17	59.43	74	-14.83	31.51	5.41	37.18	111	0	Peak

REMARKS:

- Emission Level = Read Level + Antenna Factor + Cable Loss - Preamp Factor
Margin value = Emission level – Limit value
- 5260MHz: Fundamental frequency.



A D T

EUT TEST CONDITION		MEASUREMENT DETAIL	
CHANNEL	Channel 60	FREQUENCY RANGE	1GHz ~ 40GHz
INPUT POWER	120Vac, 60 Hz	DETECTOR FUNCTION	Peak (PK) Average (AV)
ENVIRONMENTAL CONDITIONS	25deg. C, 65%RH	TESTED BY	Anson Lin

ANTENNA POLARITY & TEST DISTANCE: HORIZONTAL AT 3 M										
FREQ. (MHz)	EMISSION LEVEL (dBuV/m)	READ LEVEL (dBuV)	LIMIT (dBuV/m)	MARGIN (dB)	ANTENNA FACTOR (dB/m)	CABLE LOSS (dB)	PREAMP FACTOR (dB)	ANTENNA HEIGHT (cm)	TABLE ANGLE (Degree)	REMARK
5120	37.67	38.4	54	-16.33	31.29	5.28	37.3	102	229	Average
5120	58.76	59.49	74	-15.24	31.29	5.28	37.3	102	229	Peak
5300	95.03	95.41			31.44	5.37	37.19	102	229	Average
5300	105.05	105.43			31.44	5.37	37.19	102	229	Peak
5446	42.87	43	54	-11.13	31.56	5.44	37.13	102	229	Average
5446	59.6	59.73	74	-14.4	31.56	5.44	37.13	102	229	Peak

ANTENNA POLARITY & TEST DISTANCE: VERTICAL AT 3 M										
FREQ. (MHz)	EMISSION LEVEL (dBuV/m)	READ LEVEL (dBuV)	LIMIT (dBuV/m)	MARGIN (dB)	ANTENNA FACTOR (dB/m)	CABLE LOSS (dB)	PREAMP FACTOR (dB)	ANTENNA HEIGHT (cm)	TABLE ANGLE (Degree)	REMARK
5080	39.3	40.04	54	-14.7	31.27	5.26	37.27	111	0	Average
5080	58.99	59.73	74	-15.01	31.27	5.26	37.27	111	0	Peak
5300	89.48	89.86			31.44	5.37	37.19	111	0	Average
5300	98.45	98.83			31.44	5.37	37.19	111	0	Peak
5356	40.41	40.72	54	-13.59	31.48	5.39	37.18	111	0	Average
5356	58.82	59.13	74	-15.18	31.48	5.39	37.18	111	0	Peak

REMARKS:

- Emission Level = Read Level + Antenna Factor + Cable Loss - Preamp Factor
Margin value = Emission level – Limit value
- 5300MHz: Fundamental frequency.



A D T

EUT TEST CONDITION		MEASUREMENT DETAIL	
CHANNEL	Channel 64	FREQUENCY RANGE	1GHz ~ 40GHz
INPUT POWER	120Vac, 60 Hz	DETECTOR FUNCTION	Peak (PK) Average (AV)
ENVIRONMENTAL CONDITIONS	25deg. C, 65%RH	TESTED BY	Anson Lin

ANTENNA POLARITY & TEST DISTANCE: HORIZONTAL AT 3 M										
FREQ. (MHz)	EMISSION LEVEL (dBuV/m)	READ LEVEL (dBuV)	LIMIT (dBuV/m)	MARGIN (dB)	ANTENNA FACTOR (dB/m)	CABLE LOSS (dB)	PREAMP FACTOR (dB)	ANTENNA HEIGHT (cm)	TABLE ANGLE (Degree)	REMARK
5112	37.79	38.51	54	-16.21	31.29	5.27	37.28	102	229	Average
5112	59.69	60.41	74	-14.31	31.29	5.27	37.28	102	229	Peak
5320	95.61	95.97			31.45	5.38	37.19	102	229	Average
5320	104.66	105.02			31.45	5.38	37.19	102	229	Peak
5376	43	43.29	54	-11	31.49	5.4	37.18	102	229	Average
5376	59.87	60.16	74	-14.13	31.49	5.4	37.18	102	229	Peak
ANTENNA POLARITY & TEST DISTANCE: VERTICAL AT 3 M										
FREQ. (MHz)	EMISSION LEVEL (dBuV/m)	READ LEVEL (dBuV)	LIMIT (dBuV/m)	MARGIN (dB)	ANTENNA FACTOR (dB/m)	CABLE LOSS (dB)	PREAMP FACTOR (dB)	ANTENNA HEIGHT (cm)	TABLE ANGLE (Degree)	REMARK
5116	37.5	38.21	54	-16.5	31.29	5.28	37.28	100	6	Average
5116	59.49	60.2	74	-14.51	31.29	5.28	37.28	100	6	Peak
5320	89.42	89.78			31.45	5.38	37.19	100	6	Average
5320	98.3	98.66			31.45	5.38	37.19	100	6	Peak
5444	39.61	39.75	54	-14.39	31.55	5.44	37.13	100	6	Average
5444	59.58	59.72	74	-14.42	31.55	5.44	37.13	100	6	Peak

REMARKS:

- Emission Level = Read Level + Antenna Factor + Cable Loss - Preamp Factor
Margin value = Emission level – Limit value
- 5320MHz: Fundamental frequency.



A D T

EUT TEST CONDITION		MEASUREMENT DETAIL	
CHANNEL	Channel 100	FREQUENCY RANGE	1GHz ~ 40GHz
INPUT POWER	120Vac, 60 Hz	DETECTOR FUNCTION	Peak (PK) Average (AV)
ENVIRONMENTAL CONDITIONS	25deg. C, 65%RH	TESTED BY	Anson Lin

ANTENNA POLARITY & TEST DISTANCE: HORIZONTAL AT 3 M										
FREQ. (MHz)	EMISSION LEVEL (dBuV/m)	READ LEVEL (dBuV)	LIMIT (dBuV/m)	MARGIN (dB)	ANTENNA FACTOR (dB/m)	CABLE LOSS (dB)	PREAMP FACTOR (dB)	ANTENNA HEIGHT (cm)	TABLE ANGLE (Degree)	REMARK
5456	40.49	40.57	54	-13.51	31.56	5.44	37.08	100	199	Average
5456	60.32	60.4	74	-13.68	31.56	5.44	37.08	100	199	Peak
5470	59.66	59.72	68.3	-8.64	31.57	5.45	37.08	100	199	Peak
5500	96.93	96.9			31.6	5.46	37.03	100	199	Average
5500	106.08	106.05			31.6	5.46	37.03	100	199	Peak
5725	58.84	58.72	68.3	-9.46	31.96	5.59	37.43	100	199	Peak

ANTENNA POLARITY & TEST DISTANCE: VERTICAL AT 3 M										
FREQ. (MHz)	EMISSION LEVEL (dBuV/m)	READ LEVEL (dBuV)	LIMIT (dBuV/m)	MARGIN (dB)	ANTENNA FACTOR (dB/m)	CABLE LOSS (dB)	PREAMP FACTOR (dB)	ANTENNA HEIGHT (cm)	TABLE ANGLE (Degree)	REMARK
5424	37.71	37.94	54	-16.29	31.53	5.42	37.18	122	262	Average
5424	60.27	60.5	74	-13.73	31.53	5.42	37.18	122	262	Peak
5470	60.34	60.4	68.3	-7.96	31.57	5.45	37.08	122	262	Peak
5500	88.79	88.76			31.6	5.46	37.03	122	262	Average
5500	98.02	97.99			31.6	5.46	37.03	122	262	Peak
5725	58.55	58.43	68.3	-9.75	31.96	5.59	37.43	122	262	Peak

REMARKS:

- Emission Level = Read Level + Antenna Factor + Cable Loss - Preamp Factor
Margin value = Emission level – Limit value
- 5500MHz: Fundamental frequency.
- 5470MHz & 5725MHz: Out of restricted band



A D T

EUT TEST CONDITION		MEASUREMENT DETAIL	
CHANNEL	Channel 116	FREQUENCY RANGE	1GHz ~ 40GHz
INPUT POWER	120Vac, 60 Hz	DETECTOR FUNCTION	Peak (PK) Average (AV)
ENVIRONMENTAL CONDITIONS	25deg. C, 65%RH	TESTED BY	Anson Lin

ANTENNA POLARITY & TEST DISTANCE: HORIZONTAL AT 3 M										
FREQ. (MHz)	EMISSION LEVEL (dBuV/m)	READ LEVEL (dBuV)	LIMIT (dBuV/m)	MARGIN (dB)	ANTENNA FACTOR (dB/m)	CABLE LOSS (dB)	PREAMP FACTOR (dB)	ANTENNA HEIGHT (cm)	TABLE ANGLE (Degree)	REMARK
5388	37.59	37.85	54	-16.41	31.51	5.41	37.18	100	199	Average
5388	59.12	59.38	74	-14.88	31.51	5.41	37.18	100	199	Peak
5470	57.9	57.96	68.3	-10.4	31.57	5.45	37.08	100	199	Peak
5580	97.68	97.63			31.71	5.5	37.16	100	199	Average
5580	106.93	106.88			31.71	5.5	37.16	100	199	Peak
5724	58.3	58.18	68.3	-10	31.96	5.59	37.43	100	199	Peak
ANTENNA POLARITY & TEST DISTANCE: VERTICAL AT 3 M										
FREQ. (MHz)	EMISSION LEVEL (dBuV/m)	READ LEVEL (dBuV)	LIMIT (dBuV/m)	MARGIN (dB)	ANTENNA FACTOR (dB/m)	CABLE LOSS (dB)	PREAMP FACTOR (dB)	ANTENNA HEIGHT (cm)	TABLE ANGLE (Degree)	REMARK
5444	37.11	37.25	54	-16.89	31.55	5.44	37.13	122	262	Average
5444	58.96	59.1	74	-15.04	31.55	5.44	37.13	122	262	Peak
5470	57.51	57.57	68.3	-10.79	31.57	5.45	37.08	122	262	Peak
5580	89.38	89.33			31.71	5.5	37.16	122	262	Average
5580	98.58	98.53			31.71	5.5	37.16	122	262	Peak
5725	59.23	59.11	68.3	-9.07	31.96	5.59	37.43	122	262	Peak

REMARKS:

- Emission Level = Read Level + Antenna Factor + Cable Loss - Preamp Factor
Margin value = Emission level – Limit value
- 5580MHz: Fundamental frequency.
- 5470MHz & 5725MHz: Out of restricted band



A D T

EUT TEST CONDITION		MEASUREMENT DETAIL	
CHANNEL	Channel 140	FREQUENCY RANGE	1GHz ~ 40GHz
INPUT POWER	120Vac, 60 Hz	DETECTOR FUNCTION	Peak (PK) Average (AV)
ENVIRONMENTAL CONDITIONS	25deg. C, 65%RH	TESTED BY	Anson Lin

ANTENNA POLARITY & TEST DISTANCE: HORIZONTAL AT 3 M										
FREQ. (MHz)	EMISSION LEVEL (dBuV/m)	READ LEVEL (dBuV)	LIMIT (dBuV/m)	MARGIN (dB)	ANTENNA FACTOR (dB/m)	CABLE LOSS (dB)	PREAMP FACTOR (dB)	ANTENNA HEIGHT (cm)	TABLE ANGLE (Degree)	REMARK
5428	37.42	37.6	54	-16.58	31.53	5.42	37.13	100	174	Average
5428	59.51	59.69	74	-14.49	31.53	5.42	37.13	100	174	Peak
5470	58.11	58.17	68.3	-10.19	31.57	5.45	37.08	100	174	Peak
5700	95.56	95.49			31.9	5.57	37.4	100	174	Average
5700	104.96	104.89			31.9	5.57	37.4	100	174	Peak
5725	62.81	62.69	68.3	-5.49	31.96	5.59	37.43	100	174	Peak
ANTENNA POLARITY & TEST DISTANCE: VERTICAL AT 3 M										
FREQ. (MHz)	EMISSION LEVEL (dBuV/m)	READ LEVEL (dBuV)	LIMIT (dBuV/m)	MARGIN (dB)	ANTENNA FACTOR (dB/m)	CABLE LOSS (dB)	PREAMP FACTOR (dB)	ANTENNA HEIGHT (cm)	TABLE ANGLE (Degree)	REMARK
5442	37.14	37.28	54	-16.86	31.55	5.44	37.13	128	258	Average
5442	59.33	59.47	74	-14.67	31.55	5.44	37.13	128	258	Peak
5470	57.09	57.15	68.3	-11.21	31.57	5.45	37.08	128	258	Peak
5700	88.41	88.34			31.9	5.57	37.4	128	258	Average
5700	98.18	98.11			31.9	5.57	37.4	128	258	Peak
5725	58.17	58.05	68.3	-10.13	31.96	5.59	37.43	128	258	Peak

REMARKS:

- Emission Level = Read Level + Antenna Factor + Cable Loss - Preamp Factor
Margin value = Emission level – Limit value
- 5700MHz: Fundamental frequency.
- 5470MHz & 5725MHz: Out of restricted band



A D T

EUT TEST CONDITION		MEASUREMENT DETAIL	
CHANNEL	Channel 149	FREQUENCY RANGE	1GHz ~ 40GHz
INPUT POWER	120Vac, 60 Hz	DETECTOR FUNCTION	Peak (PK) Average (AV)
ENVIRONMENTAL CONDITIONS	25deg. C, 65%RH	TESTED BY	Anson Lin

ANTENNA POLARITY & TEST DISTANCE: HORIZONTAL AT 3 M										
FREQ. (MHz)	EMISSION LEVEL (dBuV/m)	READ LEVEL (dBuV)	LIMIT (dBuV/m)	MARGIN (dB)	ANTENNA FACTOR (dB/m)	CABLE LOSS (dB)	PREAMP FACTOR (dB)	ANTENNA HEIGHT (cm)	TABLE ANGLE (Degree)	REMARK
5714	59.73	59.64	68.3	-8.57	31.93	5.59	37.43	122	233	Peak
5725	63.5	63.38	78.3	-14.8	31.96	5.59	37.43	122	233	Peak
5745	89.29	89.17			31.99	5.6	37.47	122	233	Average
5745	98.37	98.25			31.99	5.6	37.47	122	233	Peak
5850	58.51	58.21	78.3	-19.79	32.15	5.66	37.51	122	233	Peak
5861	57.55	57.21	68.3	-10.75	32.18	5.66	37.5	122	233	Peak

ANTENNA POLARITY & TEST DISTANCE: VERTICAL AT 3 M										
FREQ. (MHz)	EMISSION LEVEL (dBuV/m)	READ LEVEL (dBuV)	LIMIT (dBuV/m)	MARGIN (dB)	ANTENNA FACTOR (dB/m)	CABLE LOSS (dB)	PREAMP FACTOR (dB)	ANTENNA HEIGHT (cm)	TABLE ANGLE (Degree)	REMARK
5714	60.01	59.92	68.3	-8.29	31.93	5.59	37.43	108	171	Peak
5725	69.35	69.23	78.3	-8.95	31.96	5.59	37.43	108	171	Peak
5745	95.86	95.74			31.99	5.6	37.47	108	171	Average
5745	104.92	104.8			31.99	5.6	37.47	108	171	Peak
5850	59.24	58.94	78.3	-19.06	32.15	5.66	37.51	108	171	Peak
5861	60.69	60.35	68.3	-7.61	32.18	5.66	37.5	108	171	Peak

REMARKS:

- Emission Level = Read Level + Antenna Factor + Cable Loss - Preamp Factor
Margin value = Emission level – Limit value
- 5745MHz: Fundamental frequency.
- 5725MHz & 5850MHz: Out of restricted band



A D T

EUT TEST CONDITION		MEASUREMENT DETAIL	
CHANNEL	Channel 157	FREQUENCY RANGE	1GHz ~ 40GHz
INPUT POWER	120Vac, 60 Hz	DETECTOR FUNCTION	Peak (PK) Average (AV)
ENVIRONMENTAL CONDITIONS	25deg. C, 65%RH	TESTED BY	Anson Lin

ANTENNA POLARITY & TEST DISTANCE: HORIZONTAL AT 3 M										
FREQ. (MHz)	EMISSION LEVEL (dBuV/m)	READ LEVEL (dBuV)	LIMIT (dBuV/m)	MARGIN (dB)	ANTENNA FACTOR (dB/m)	CABLE LOSS (dB)	PREAMP FACTOR (dB)	ANTENNA HEIGHT (cm)	TABLE ANGLE (Degree)	REMARK
5714	57.21	57.12	68.3	-11.09	31.93	5.59	37.43	129	220	Peak
5725	58.08	57.96	78.3	-20.22	31.96	5.59	37.43	129	220	Peak
5785	90.46	90.34			32.04	5.62	37.54	129	220	Average
5785	99.55	99.43			32.04	5.62	37.54	129	220	Peak
5850	60.15	59.85	78.3	-18.15	32.15	5.66	37.51	129	220	Peak
5860	57.31	56.97	68.3	-10.99	32.18	5.66	37.5	129	220	Peak
ANTENNA POLARITY & TEST DISTANCE: VERTICAL AT 3 M										
FREQ. (MHz)	EMISSION LEVEL (dBuV/m)	READ LEVEL (dBuV)	LIMIT (dBuV/m)	MARGIN (dB)	ANTENNA FACTOR (dB/m)	CABLE LOSS (dB)	PREAMP FACTOR (dB)	ANTENNA HEIGHT (cm)	TABLE ANGLE (Degree)	REMARK
5714	58.08	57.99	68.3	-10.22	31.93	5.59	37.43	108	171	Peak
5725	59.26	59.14	78.3	-19.04	31.96	5.59	37.43	108	171	Peak
5785	96.78	96.66			32.04	5.62	37.54	108	171	Average
5785	106.22	106.1			32.04	5.62	37.54	108	171	Peak
5850	58.63	58.33	78.3	-19.67	32.15	5.66	37.51	108	171	Peak
5860	58.43	58.09	68.3	-9.87	32.18	5.66	37.5	108	171	Peak

REMARKS:

- Emission Level = Read Level + Antenna Factor + Cable Loss - Preamp Factor
Margin value = Emission level – Limit value
- 5785MHz: Fundamental frequency.
- 5725MHz & 5850MHz: Out of restricted band



A D T

EUT TEST CONDITION		MEASUREMENT DETAIL	
CHANNEL	Channel 165	FREQUENCY RANGE	1GHz ~ 40GHz
INPUT POWER	120Vac, 60 Hz	DETECTOR FUNCTION	Peak (PK) Average (AV)
ENVIRONMENTAL CONDITIONS	25deg. C, 65%RH	TESTED BY	Anson Lin

ANTENNA POLARITY & TEST DISTANCE: HORIZONTAL AT 3 M										
FREQ. (MHz)	EMISSION LEVEL (dBuV/m)	READ LEVEL (dBuV)	LIMIT (dBuV/m)	MARGIN (dB)	ANTENNA FACTOR (dB/m)	CABLE LOSS (dB)	PREAMP FACTOR (dB)	ANTENNA HEIGHT (cm)	TABLE ANGLE (Degree)	REMARK
5714	58.12	58.03	68.3	-10.18	31.93	5.59	37.43	129	220	Peak
5725	58.79	58.67	78.3	-19.51	31.96	5.59	37.43	129	220	Peak
5825	90.28	90.05			32.12	5.64	37.53	129	220	Average
5825	99.64	99.41			32.12	5.64	37.53	129	220	Peak
5850	59.1	58.8	78.3	-19.2	32.15	5.66	37.51	129	220	Peak
5860	58.03	57.69	68.3	-10.27	32.18	5.66	37.5	129	220	Peak
ANTENNA POLARITY & TEST DISTANCE: VERTICAL AT 3 M										
FREQ. (MHz)	EMISSION LEVEL (dBuV/m)	READ LEVEL (dBuV)	LIMIT (dBuV/m)	MARGIN (dB)	ANTENNA FACTOR (dB/m)	CABLE LOSS (dB)	PREAMP FACTOR (dB)	ANTENNA HEIGHT (cm)	TABLE ANGLE (Degree)	REMARK
5714	60.18	60.09	68.3	-8.12	31.93	5.59	37.43	108	170	Peak
5725	58.48	58.36	78.3	-19.82	31.96	5.59	37.43	108	170	Peak
5825	96.39	96.16			32.12	5.64	37.53	108	170	Average
5825	104.19	103.96			32.12	5.64	37.53	108	170	Peak
5850	62.8	62.5	78.3	-15.5	32.15	5.66	37.51	108	170	Peak
5860	58.73	58.39	68.3	-9.57	32.18	5.66	37.5	108	170	Peak

REMARKS:

- Emission Level = Read Level + Antenna Factor + Cable Loss - Preamp Factor
Margin value = Emission level – Limit value
- 5825MHz: Fundamental frequency.
- 5725MHz & 5850MHz: Out of restricted band



A D T

802.11n (20MHz)

EUT TEST CONDITION		MEASUREMENT DETAIL	
CHANNEL	Channel 36	FREQUENCY RANGE	1GHz ~ 40GHz
INPUT POWER	120Vac, 60 Hz	DETECTOR FUNCTION	Peak (PK) Average (AV)
ENVIRONMENTAL CONDITIONS	25deg. C, 65%RH	TESTED BY	Anson Lin

ANTENNA POLARITY & TEST DISTANCE: HORIZONTAL AT 3 M										
FREQ. (MHz)	EMISSION LEVEL (dBuV/m)	READ LEVEL (dBuV)	LIMIT (dBuV/m)	MARGIN (dB)	ANTENNA FACTOR (dB/m)	CABLE LOSS (dB)	PREAMP FACTOR (dB)	ANTENNA HEIGHT (cm)	TABLE ANGLE (Degree)	REMARK
5150	44.34	45.05	54	-9.66	31.32	5.29	37.32	109	202	Average
5150	61.13	61.84	74	-12.87	31.32	5.29	37.32	109	202	Peak
5180	96.61	97.29			31.35	5.31	37.34	109	202	Average
5180	105.55	106.23			31.35	5.31	37.34	109	202	Peak
5352	37.83	38.14	54	-16.17	31.48	5.39	37.18	109	202	Average
5352	58.55	58.86	74	-15.45	31.48	5.39	37.18	109	202	Peak
ANTENNA POLARITY & TEST DISTANCE: VERTICAL AT 3 M										
FREQ. (MHz)	EMISSION LEVEL (dBuV/m)	READ LEVEL (dBuV)	LIMIT (dBuV/m)	MARGIN (dB)	ANTENNA FACTOR (dB/m)	CABLE LOSS (dB)	PREAMP FACTOR (dB)	ANTENNA HEIGHT (cm)	TABLE ANGLE (Degree)	REMARK
5150	39.27	39.98	54	-14.73	31.32	5.29	37.32	100	350	Average
5150	59.66	60.37	74	-14.34	31.32	5.29	37.32	100	350	Peak
5180	88.84	89.52			31.35	5.31	37.34	100	350	Average
5180	97.7	98.38			31.35	5.31	37.34	100	350	Peak
5376	37.81	38.1	54	-16.19	31.49	5.4	37.18	100	350	Average
5376	59.82	60.11	74	-14.18	31.49	5.4	37.18	100	350	Peak

REMARKS:

- Emission Level = Read Level + Antenna Factor + Cable Loss - Preamp Factor
Margin value = Emission level – Limit value
- 5180MHz: Fundamental frequency.



A D T

EUT TEST CONDITION		MEASUREMENT DETAIL	
CHANNEL	Channel 44	FREQUENCY RANGE	1GHz ~ 40GHz
INPUT POWER	120Vac, 60 Hz	DETECTOR FUNCTION	Peak (PK) Average (AV)
ENVIRONMENTAL CONDITIONS	25deg. C, 65%RH	TESTED BY	Anson Lin

ANTENNA POLARITY & TEST DISTANCE: HORIZONTAL AT 3 M										
FREQ. (MHz)	EMISSION LEVEL (dBuV/m)	READ LEVEL (dBuV)	LIMIT (dBuV/m)	MARGIN (dB)	ANTENNA FACTOR (dB/m)	CABLE LOSS (dB)	PREAMP FACTOR (dB)	ANTENNA HEIGHT (cm)	TABLE ANGLE (Degree)	REMARK
5002	37.93	38.74	54	-16.07	31.2	5.22	37.23	108	203	Average
5002	59.17	59.98	74	-14.83	31.2	5.22	37.23	108	203	Peak
5220	96.59	97.25			31.37	5.33	37.36	108	203	Average
5220	106.18	106.84			31.37	5.33	37.36	108	203	Peak
5434	37.84	38	54	-16.16	31.55	5.42	37.13	108	203	Average
5434	59.77	59.93	74	-14.23	31.55	5.42	37.13	108	203	Peak
ANTENNA POLARITY & TEST DISTANCE: VERTICAL AT 3 M										
FREQ. (MHz)	EMISSION LEVEL (dBuV/m)	READ LEVEL (dBuV)	LIMIT (dBuV/m)	MARGIN (dB)	ANTENNA FACTOR (dB/m)	CABLE LOSS (dB)	PREAMP FACTOR (dB)	ANTENNA HEIGHT (cm)	TABLE ANGLE (Degree)	REMARK
5032	37.32	38.09	54	-16.68	31.23	5.24	37.24	100	350	Average
5032	59.24	60.01	74	-14.76	31.23	5.24	37.24	100	350	Peak
5220	88.93	89.59			31.37	5.33	37.36	100	350	Average
5220	97.68	98.34			31.37	5.33	37.36	100	350	Peak
5436	37.74	37.9	54	-16.26	31.55	5.42	37.13	100	350	Average
5436	58.95	59.11	74	-15.05	31.55	5.42	37.13	100	350	Peak

REMARKS:

- Emission Level = Read Level + Antenna Factor + Cable Loss - Preamp Factor
Margin value = Emission level – Limit value
- 5220MHz: Fundamental frequency.



A D T

EUT TEST CONDITION		MEASUREMENT DETAIL	
CHANNEL	Channel 48	FREQUENCY RANGE	1GHz ~ 40GHz
INPUT POWER	120Vac, 60 Hz	DETECTOR FUNCTION	Peak (PK) Average (AV)
ENVIRONMENTAL CONDITIONS	25deg. C, 65%RH	TESTED BY	Anson Lin

ANTENNA POLARITY & TEST DISTANCE: HORIZONTAL AT 3 M										
FREQ. (MHz)	EMISSION LEVEL (dBuV/m)	READ LEVEL (dBuV)	LIMIT (dBuV/m)	MARGIN (dB)	ANTENNA FACTOR (dB/m)	CABLE LOSS (dB)	PREAMP FACTOR (dB)	ANTENNA HEIGHT (cm)	TABLE ANGLE (Degree)	REMARK
5008	37.47	38.27	54	-16.53	31.21	5.22	37.23	108	203	Average
5008	60.57	61.37	74	-13.43	31.21	5.22	37.23	108	203	Peak
5240	96.5	97.09			31.39	5.34	37.32	108	203	Average
5240	105.98	106.57			31.39	5.34	37.32	108	203	Peak
5452	38.26	38.34	54	-15.74	31.56	5.44	37.08	108	203	Average
5452	60.46	60.54	74	-13.54	31.56	5.44	37.08	108	203	Peak

ANTENNA POLARITY & TEST DISTANCE: VERTICAL AT 3 M										
FREQ. (MHz)	EMISSION LEVEL (dBuV/m)	READ LEVEL (dBuV)	LIMIT (dBuV/m)	MARGIN (dB)	ANTENNA FACTOR (dB/m)	CABLE LOSS (dB)	PREAMP FACTOR (dB)	ANTENNA HEIGHT (cm)	TABLE ANGLE (Degree)	REMARK
5094	37.61	38.34	54	-16.39	31.28	5.27	37.28	110	349	Average
5094	59.51	60.24	74	-14.49	31.28	5.27	37.28	110	349	Peak
5240	89	89.59			31.39	5.34	37.32	110	349	Average
5240	98.44	99.03			31.39	5.34	37.32	110	349	Peak
5382	37.75	38.02	54	-16.25	31.51	5.4	37.18	110	349	Average
5382	59.59	59.86	74	-14.41	31.51	5.4	37.18	110	349	Peak

REMARKS:

- Emission Level = Read Level + Antenna Factor + Cable Loss - Preamp Factor
Margin value = Emission level – Limit value
- 5240MHz: Fundamental frequency.



A D T

EUT TEST CONDITION		MEASUREMENT DETAIL	
CHANNEL	Channel 52	FREQUENCY RANGE	1GHz ~ 40GHz
INPUT POWER	120Vac, 60 Hz	DETECTOR FUNCTION	Peak (PK) Average (AV)
ENVIRONMENTAL CONDITIONS	25deg. C, 65%RH	TESTED BY	Anson Lin

ANTENNA POLARITY & TEST DISTANCE: HORIZONTAL AT 3 M										
FREQ. (MHz)	EMISSION LEVEL (dBuV/m)	READ LEVEL (dBuV)	LIMIT (dBuV/m)	MARGIN (dB)	ANTENNA FACTOR (dB/m)	CABLE LOSS (dB)	PREAMP FACTOR (dB)	ANTENNA HEIGHT (cm)	TABLE ANGLE (Degree)	REMARK
5058	37.55	38.3	54	-16.45	31.25	5.25	37.25	102	228	Average
5058	59.27	60.02	74	-14.73	31.25	5.25	37.25	102	228	Peak
5260	94.38	94.9			31.41	5.34	37.27	102	228	Average
5260	104.21	104.73			31.41	5.34	37.27	102	228	Peak
5440	37.99	38.13	54	-16.01	31.55	5.44	37.13	102	228	Average
5440	60.32	60.46	74	-13.68	31.55	5.44	37.13	102	228	Peak

ANTENNA POLARITY & TEST DISTANCE: VERTICAL AT 3 M										
FREQ. (MHz)	EMISSION LEVEL (dBuV/m)	READ LEVEL (dBuV)	LIMIT (dBuV/m)	MARGIN (dB)	ANTENNA FACTOR (dB/m)	CABLE LOSS (dB)	PREAMP FACTOR (dB)	ANTENNA HEIGHT (cm)	TABLE ANGLE (Degree)	REMARK
5094	37.61	38.34	54	-16.39	31.28	5.27	37.28	111	0	Average
5094	58.98	59.71	74	-15.02	31.28	5.27	37.28	111	0	Peak
5260	89.49	90.01			31.41	5.34	37.27	111	0	Average
5260	98.43	98.95			31.41	5.34	37.27	111	0	Peak
5392	37.68	37.94	54	-16.32	31.51	5.41	37.18	111	0	Average
5392	59.17	59.43	74	-14.83	31.51	5.41	37.18	111	0	Peak

REMARKS:

- Emission Level = Read Level + Antenna Factor + Cable Loss - Preamp Factor
Margin value = Emission level – Limit value
- 5260MHz: Fundamental frequency.



A D T

EUT TEST CONDITION		MEASUREMENT DETAIL	
CHANNEL	Channel 60	FREQUENCY RANGE	1GHz ~ 40GHz
INPUT POWER	120Vac, 60 Hz	DETECTOR FUNCTION	Peak (PK) Average (AV)
ENVIRONMENTAL CONDITIONS	25deg. C, 65%RH	TESTED BY	Anson Lin

ANTENNA POLARITY & TEST DISTANCE: HORIZONTAL AT 3 M										
FREQ. (MHz)	EMISSION LEVEL (dBuV/m)	READ LEVEL (dBuV)	LIMIT (dBuV/m)	MARGIN (dB)	ANTENNA FACTOR (dB/m)	CABLE LOSS (dB)	PREAMP FACTOR (dB)	ANTENNA HEIGHT (cm)	TABLE ANGLE (Degree)	REMARK
5120	37.67	38.4	54	-16.33	31.29	5.28	37.3	102	229	Average
5120	58.76	59.49	74	-15.24	31.29	5.28	37.3	102	229	Peak
5300	95.03	95.41			31.44	5.37	37.19	102	229	Average
5300	105.05	105.43			31.44	5.37	37.19	102	229	Peak
5446	42.87	43	54	-11.13	31.56	5.44	37.13	102	229	Average
5446	59.6	59.73	74	-14.4	31.56	5.44	37.13	102	229	Peak
ANTENNA POLARITY & TEST DISTANCE: VERTICAL AT 3 M										
FREQ. (MHz)	EMISSION LEVEL (dBuV/m)	READ LEVEL (dBuV)	LIMIT (dBuV/m)	MARGIN (dB)	ANTENNA FACTOR (dB/m)	CABLE LOSS (dB)	PREAMP FACTOR (dB)	ANTENNA HEIGHT (cm)	TABLE ANGLE (Degree)	REMARK
5080	39.3	40.04	54	-14.7	31.27	5.26	37.27	111	0	Average
5080	58.99	59.73	74	-15.01	31.27	5.26	37.27	111	0	Peak
5300	89.48	89.86			31.44	5.37	37.19	111	0	Average
5300	98.45	98.83			31.44	5.37	37.19	111	0	Peak
5356	40.41	40.72	54	-13.59	31.48	5.39	37.18	111	0	Average
5356	58.82	59.13	74	-15.18	31.48	5.39	37.18	111	0	Peak

REMARKS:

- Emission Level = Read Level + Antenna Factor + Cable Loss - Preamp Factor
Margin value = Emission level – Limit value
- 5300MHz: Fundamental frequency.



A D T

EUT TEST CONDITION		MEASUREMENT DETAIL	
CHANNEL	Channel 64	FREQUENCY RANGE	1GHz ~ 40GHz
INPUT POWER	120Vac, 60 Hz	DETECTOR FUNCTION	Peak (PK) Average (AV)
ENVIRONMENTAL CONDITIONS	25deg. C, 65%RH	TESTED BY	Anson Lin

ANTENNA POLARITY & TEST DISTANCE: HORIZONTAL AT 3 M										
FREQ. (MHz)	EMISSION LEVEL (dBuV/m)	READ LEVEL (dBuV)	LIMIT (dBuV/m)	MARGIN (dB)	ANTENNA FACTOR (dB/m)	CABLE LOSS (dB)	PREAMP FACTOR (dB)	ANTENNA HEIGHT (cm)	TABLE ANGLE (Degree)	REMARK
5112	37.79	38.51	54	-16.21	31.29	5.27	37.28	102	229	Average
5112	59.69	60.41	74	-14.31	31.29	5.27	37.28	102	229	Peak
5320	95.61	95.97			31.45	5.38	37.19	102	229	Average
5320	104.66	105.02			31.45	5.38	37.19	102	229	Peak
5376	43	43.29	54	-11	31.49	5.4	37.18	102	229	Average
5376	59.87	60.16	74	-14.13	31.49	5.4	37.18	102	229	Peak
ANTENNA POLARITY & TEST DISTANCE: VERTICAL AT 3 M										
FREQ. (MHz)	EMISSION LEVEL (dBuV/m)	READ LEVEL (dBuV)	LIMIT (dBuV/m)	MARGIN (dB)	ANTENNA FACTOR (dB/m)	CABLE LOSS (dB)	PREAMP FACTOR (dB)	ANTENNA HEIGHT (cm)	TABLE ANGLE (Degree)	REMARK
5116	37.5	38.21	54	-16.5	31.29	5.28	37.28	100	6	Average
5116	59.49	60.2	74	-14.51	31.29	5.28	37.28	100	6	Peak
5320	89.42	89.78			31.45	5.38	37.19	100	6	Average
5320	98.3	98.66			31.45	5.38	37.19	100	6	Peak
5444	39.61	39.75	54	-14.39	31.55	5.44	37.13	100	6	Average
5444	59.58	59.72	74	-14.42	31.55	5.44	37.13	100	6	Peak

REMARKS:

1. Emission Level = Read Level + Antenna Factor + Cable Loss - Preamp Factor
Margin value = Emission level – Limit value
2. 5320MHz: Fundamental frequency.



A D T

EUT TEST CONDITION		MEASUREMENT DETAIL	
CHANNEL	Channel 100	FREQUENCY RANGE	1GHz ~ 40GHz
INPUT POWER	120Vac, 60 Hz	DETECTOR FUNCTION	Peak (PK) Average (AV)
ENVIRONMENTAL CONDITIONS	25deg. C, 65%RH	TESTED BY	Anson Lin

ANTENNA POLARITY & TEST DISTANCE: HORIZONTAL AT 3 M										
FREQ. (MHz)	EMISSION LEVEL (dBuV/m)	READ LEVEL (dBuV)	LIMIT (dBuV/m)	MARGIN (dB)	ANTENNA FACTOR (dB/m)	CABLE LOSS (dB)	PREAMP FACTOR (dB)	ANTENNA HEIGHT (cm)	TABLE ANGLE (Degree)	REMARK
5418	41.17	41.4	54	-12.83	31.53	5.42	37.18	101	196	Average
5418	59.32	59.55	74	-14.68	31.53	5.42	37.18	101	196	Peak
5470	59.79	59.85	68.3	-8.51	31.57	5.45	37.08	101	196	Peak
5500	97.08	97.05			31.6	5.46	37.03	101	196	Average
5500	106.43	106.4			31.6	5.46	37.03	101	196	Peak
5725	59.55	59.43	68.3	-8.75	31.96	5.59	37.43	101	196	Peak
ANTENNA POLARITY & TEST DISTANCE: VERTICAL AT 3 M										
FREQ. (MHz)	EMISSION LEVEL (dBuV/m)	READ LEVEL (dBuV)	LIMIT (dBuV/m)	MARGIN (dB)	ANTENNA FACTOR (dB/m)	CABLE LOSS (dB)	PREAMP FACTOR (dB)	ANTENNA HEIGHT (cm)	TABLE ANGLE (Degree)	REMARK
5398	37.66	37.91	54	-16.34	31.52	5.41	37.18	132	257	Average
5398	59.96	60.21	74	-14.04	31.52	5.41	37.18	132	257	Peak
5470	57.09	57.15	68.3	-11.21	31.57	5.45	37.08	132	257	Peak
5500	88.27	88.24			31.6	5.46	37.03	132	257	Average
5500	98.19	98.16			31.6	5.46	37.03	132	257	Peak
5725	57.87	57.75	68.3	-10.43	31.96	5.59	37.43	132	257	Peak

REMARKS:

- Emission Level = Read Level + Antenna Factor + Cable Loss - Preamp Factor
Margin value = Emission level – Limit value
- 5500MHz: Fundamental frequency.
- 5470MHz & 5725MHz: Out of restricted band



A D T

EUT TEST CONDITION		MEASUREMENT DETAIL	
CHANNEL	Channel 116	FREQUENCY RANGE	1GHz ~ 40GHz
INPUT POWER	120Vac, 60 Hz	DETECTOR FUNCTION	Peak (PK) Average (AV)
ENVIRONMENTAL CONDITIONS	25deg. C, 65%RH	TESTED BY	Anson Lin

ANTENNA POLARITY & TEST DISTANCE: HORIZONTAL AT 3 M										
FREQ. (MHz)	EMISSION LEVEL (dBuV/m)	READ LEVEL (dBuV)	LIMIT (dBuV/m)	MARGIN (dB)	ANTENNA FACTOR (dB/m)	CABLE LOSS (dB)	PREAMP FACTOR (dB)	ANTENNA HEIGHT (cm)	TABLE ANGLE (Degree)	REMARK
5410	37.62	37.87	54	-16.38	31.52	5.41	37.18	100	195	Average
5410	59.96	60.21	74	-14.04	31.52	5.41	37.18	100	195	Peak
5470	57.91	57.97	68.3	-10.39	31.57	5.45	37.08	100	195	Peak
5580	97.83	97.78			31.71	5.5	37.16	100	195	Average
5580	106.55	106.5			31.71	5.5	37.16	100	195	Peak
5725	58.31	58.19	68.3	-9.99	31.96	5.59	37.43	100	195	Peak
ANTENNA POLARITY & TEST DISTANCE: VERTICAL AT 3 M										
FREQ. (MHz)	EMISSION LEVEL (dBuV/m)	READ LEVEL (dBuV)	LIMIT (dBuV/m)	MARGIN (dB)	ANTENNA FACTOR (dB/m)	CABLE LOSS (dB)	PREAMP FACTOR (dB)	ANTENNA HEIGHT (cm)	TABLE ANGLE (Degree)	REMARK
5362	37.35	37.65	54	-16.65	31.49	5.39	37.18	132	257	Average
5362	59.39	59.69	74	-14.61	31.49	5.39	37.18	132	257	Peak
5470	57.82	57.88	68.3	-10.48	31.57	5.45	37.08	132	257	Peak
5580	89.56	89.51			31.71	5.5	37.16	132	257	Average
5580	98.83	98.78			31.71	5.5	37.16	132	257	Peak
5725	57.78	57.66	68.3	-10.52	31.96	5.59	37.43	132	257	Peak

REMARKS:

- Emission Level = Read Level + Antenna Factor + Cable Loss - Preamp Factor
Margin value = Emission level – Limit value
- 5580MHz: Fundamental frequency.
- 5470MHz & 5725MHz: Out of restricted band



A D T

EUT TEST CONDITION		MEASUREMENT DETAIL	
CHANNEL	Channel 140	FREQUENCY RANGE	1GHz ~ 40GHz
INPUT POWER	120Vac, 60 Hz	DETECTOR FUNCTION	Peak (PK) Average (AV)
ENVIRONMENTAL CONDITIONS	25deg. C, 65%RH	TESTED BY	Anson Lin

ANTENNA POLARITY & TEST DISTANCE: HORIZONTAL AT 3 M										
FREQ. (MHz)	EMISSION LEVEL (dBuV/m)	READ LEVEL (dBuV)	LIMIT (dBuV/m)	MARGIN (dB)	ANTENNA FACTOR (dB/m)	CABLE LOSS (dB)	PREAMP FACTOR (dB)	ANTENNA HEIGHT (cm)	TABLE ANGLE (Degree)	REMARK
5386	37.59	37.86	54	-16.41	31.51	5.4	37.18	100	195	Average
5386	60.17	60.44	74	-13.83	31.51	5.4	37.18	100	195	Peak
5470	58.46	58.52	68.3	-9.84	31.57	5.45	37.08	100	195	Peak
5700	95.62	95.55			31.9	5.57	37.4	100	195	Average
5700	105.06	104.99			31.9	5.57	37.4	100	195	Peak
5725	60.83	60.71	68.3	-7.47	31.96	5.59	37.43	100	195	Peak
ANTENNA POLARITY & TEST DISTANCE: VERTICAL AT 3 M										
FREQ. (MHz)	EMISSION LEVEL (dBuV/m)	READ LEVEL (dBuV)	LIMIT (dBuV/m)	MARGIN (dB)	ANTENNA FACTOR (dB/m)	CABLE LOSS (dB)	PREAMP FACTOR (dB)	ANTENNA HEIGHT (cm)	TABLE ANGLE (Degree)	REMARK
5354	37.55	37.86	54	-16.45	31.48	5.39	37.18	108	278	Average
5354	59.98	60.29	74	-14.02	31.48	5.39	37.18	108	278	Peak
5470	59.07	59.13	68.3	-9.23	31.57	5.45	37.08	108	278	Peak
5700	87.8	87.73			31.9	5.57	37.4	108	278	Average
5700	97.85	97.78			31.9	5.57	37.4	108	278	Peak
5725	58.79	58.67	68.3	-9.51	31.96	5.59	37.43	108	278	Peak

REMARKS:

- Emission Level = Read Level + Antenna Factor + Cable Loss - Preamp Factor
Margin value = Emission level – Limit value
- 5700MHz: Fundamental frequency.
- 5470MHz & 5725MHz: Out of restricted band



A D T

EUT TEST CONDITION		MEASUREMENT DETAIL	
CHANNEL	Channel 149	FREQUENCY RANGE	1GHz ~ 40GHz
INPUT POWER	120Vac, 60 Hz	DETECTOR FUNCTION	Peak (PK) Average (AV)
ENVIRONMENTAL CONDITIONS	25deg. C, 65%RH	TESTED BY	Anson Lin

ANTENNA POLARITY & TEST DISTANCE: HORIZONTAL AT 3 M										
FREQ. (MHz)	EMISSION LEVEL (dBuV/m)	READ LEVEL (dBuV)	LIMIT (dBuV/m)	MARGIN (dB)	ANTENNA FACTOR (dB/m)	CABLE LOSS (dB)	PREAMP FACTOR (dB)	ANTENNA HEIGHT (cm)	TABLE ANGLE (Degree)	REMARK
5714	59.43	59.34	68.3	-8.87	31.93	5.59	37.43	129	220	Peak
5725	64.4	64.28	78.3	-13.9	31.96	5.59	37.43	129	220	Peak
5745	88.8	88.68			31.99	5.6	37.47	129	220	Average
5745	98.65	98.53			31.99	5.6	37.47	129	220	Peak
5850	59.7	59.4	78.3	-18.6	32.15	5.66	37.51	129	220	Peak
5860	59.25	58.91	68.3	-9.05	32.18	5.66	37.5	129	220	Peak
ANTENNA POLARITY & TEST DISTANCE: VERTICAL AT 3 M										
FREQ. (MHz)	EMISSION LEVEL (dBuV/m)	READ LEVEL (dBuV)	LIMIT (dBuV/m)	MARGIN (dB)	ANTENNA FACTOR (dB/m)	CABLE LOSS (dB)	PREAMP FACTOR (dB)	ANTENNA HEIGHT (cm)	TABLE ANGLE (Degree)	REMARK
5714	62.55	62.46	68.3	-5.75	31.93	5.59	37.43	108	170	Peak
5725	74.58	74.46	78.3	-3.72	31.96	5.59	37.43	108	170	Peak
5745	95.66	95.54			31.99	5.6	37.47	108	170	Average
5745	105.64	105.52			31.99	5.6	37.47	108	170	Peak
5850	57.81	57.51	78.3	-20.49	32.15	5.66	37.51	108	170	Peak
5860	58.02	57.68	68.3	-10.28	32.18	5.66	37.5	108	170	Peak

REMARKS:

- Emission Level = Read Level + Antenna Factor + Cable Loss - Preamp Factor
Margin value = Emission level – Limit value
- 5745MHz: Fundamental frequency.
- 5725MHz & 5850MHz: Out of restricted band



A D T

EUT TEST CONDITION		MEASUREMENT DETAIL	
CHANNEL	Channel 157	FREQUENCY RANGE	1GHz ~ 40GHz
INPUT POWER	120Vac, 60 Hz	DETECTOR FUNCTION	Peak (PK) Average (AV)
ENVIRONMENTAL CONDITIONS	25deg. C, 65%RH	TESTED BY	Anson Lin

ANTENNA POLARITY & TEST DISTANCE: HORIZONTAL AT 3 M										
FREQ. (MHz)	EMISSION LEVEL (dBuV/m)	READ LEVEL (dBuV)	LIMIT (dBuV/m)	MARGIN (dB)	ANTENNA FACTOR (dB/m)	CABLE LOSS (dB)	PREAMP FACTOR (dB)	ANTENNA HEIGHT (cm)	TABLE ANGLE (Degree)	REMARK
5714	57.73	57.64	68.3	-10.57	31.93	5.59	37.43	129	220	Peak
5725	58.05	57.93	78.3	-20.25	31.96	5.59	37.43	129	220	Peak
5785	89.81	89.69			32.04	5.62	37.54	129	220	Average
5785	99.49	99.37			32.04	5.62	37.54	129	220	Peak
5850	58.77	58.47	78.3	-19.53	32.15	5.66	37.51	129	220	Peak
5860	58.96	58.62	68.3	-9.34	32.18	5.66	37.5	129	220	Peak
ANTENNA POLARITY & TEST DISTANCE: VERTICAL AT 3 M										
FREQ. (MHz)	EMISSION LEVEL (dBuV/m)	READ LEVEL (dBuV)	LIMIT (dBuV/m)	MARGIN (dB)	ANTENNA FACTOR (dB/m)	CABLE LOSS (dB)	PREAMP FACTOR (dB)	ANTENNA HEIGHT (cm)	TABLE ANGLE (Degree)	REMARK
5714	57.97	57.88	68.3	-10.33	31.93	5.59	37.43	108	170	Peak
5725	57.98	57.86	78.3	-20.32	31.96	5.59	37.43	108	170	Peak
5785	96.65	96.53			32.04	5.62	37.54	108	170	Average
5785	106.24	106.12			32.04	5.62	37.54	108	170	Peak
5850	58.04	57.74	78.3	-20.26	32.15	5.66	37.51	108	170	Peak
5860	58.35	58.01	68.3	-9.95	32.18	5.66	37.5	108	170	Peak

REMARKS:

- Emission Level = Read Level + Antenna Factor + Cable Loss - Preamp Factor
Margin value = Emission level – Limit value
- 5785MHz: Fundamental frequency.
- 5725MHz & 5850MHz: Out of restricted band



A D T

EUT TEST CONDITION		MEASUREMENT DETAIL	
CHANNEL	Channel 165	FREQUENCY RANGE	1GHz ~ 40GHz
INPUT POWER	120Vac, 60 Hz	DETECTOR FUNCTION	Peak (PK) Average (AV)
ENVIRONMENTAL CONDITIONS	25deg. C, 65%RH	TESTED BY	Anson Lin

ANTENNA POLARITY & TEST DISTANCE: HORIZONTAL AT 3 M										
FREQ. (MHz)	EMISSION LEVEL (dBuV/m)	READ LEVEL (dBuV)	LIMIT (dBuV/m)	MARGIN (dB)	ANTENNA FACTOR (dB/m)	CABLE LOSS (dB)	PREAMP FACTOR (dB)	ANTENNA HEIGHT (cm)	TABLE ANGLE (Degree)	REMARK
5714	58.56	58.47	68.3	-9.74	31.93	5.59	37.43	129	220	Peak
5725	57.98	57.86	78.3	-20.32	31.96	5.59	37.43	129	220	Peak
5825	89.72	89.49			32.12	5.64	37.53	129	220	Average
5825	98.84	98.61			32.12	5.64	37.53	129	220	Peak
5850	61.36	61.06	78.3	-16.94	32.15	5.66	37.51	129	220	Peak
5860	58.57	58.23	68.3	-9.73	32.18	5.66	37.5	129	220	Peak
ANTENNA POLARITY & TEST DISTANCE: VERTICAL AT 3 M										
FREQ. (MHz)	EMISSION LEVEL (dBuV/m)	READ LEVEL (dBuV)	LIMIT (dBuV/m)	MARGIN (dB)	ANTENNA FACTOR (dB/m)	CABLE LOSS (dB)	PREAMP FACTOR (dB)	ANTENNA HEIGHT (cm)	TABLE ANGLE (Degree)	REMARK
5714	58.35	58.26	68.3	-9.95	31.93	5.59	37.43	108	170	Peak
5725	58.47	58.35	78.3	-19.83	31.96	5.59	37.43	108	170	Peak
5825	95.96	95.73			32.12	5.64	37.53	108	170	Average
5825	104.23	104			32.12	5.64	37.53	108	170	Peak
5850	63.46	63.16	78.3	-14.84	32.15	5.66	37.51	108	170	Peak
5860	58.04	57.7	68.3	-10.26	32.18	5.66	37.5	108	170	Peak

REMARKS:

- Emission Level = Read Level + Antenna Factor + Cable Loss - Preamp Factor
Margin value = Emission level – Limit value
- 5825MHz: Fundamental frequency.
- 5725MHz & 5850MHz: Out of restricted band



A D T

802.11n (40MHz)

EUT TEST CONDITION		MEASUREMENT DETAIL	
CHANNEL	Channel 38	FREQUENCY RANGE	1GHz ~ 40GHz
INPUT POWER	120Vac, 60 Hz	DETECTOR FUNCTION	Peak (PK) Average (AV)
ENVIRONMENTAL CONDITIONS	25deg. C, 65%RH	TESTED BY	Anson Lin

ANTENNA POLARITY & TEST DISTANCE: HORIZONTAL AT 3 M										
FREQ. (MHz)	EMISSION LEVEL (dBuV/m)	READ LEVEL (dBuV)	LIMIT (dBuV/m)	MARGIN (dB)	ANTENNA FACTOR (dB/m)	CABLE LOSS (dB)	PREAMP FACTOR (dB)	ANTENNA HEIGHT (cm)	TABLE ANGLE (Degree)	REMARK
5148	49.29	50	54	-4.71	31.32	5.29	37.32	108	200	Average
5148	64.27	64.98	74	-9.73	31.32	5.29	37.32	108	200	Peak
5190	92.26	92.93			31.35	5.32	37.34	108	200	Average
5190	102.05	102.72			31.35	5.32	37.34	108	200	Peak
5380	37.58	37.85	54	-16.42	31.51	5.4	37.18	108	200	Average
5380	58.79	59.06	74	-15.21	31.51	5.4	37.18	108	200	Peak

ANTENNA POLARITY & TEST DISTANCE: VERTICAL AT 3 M										
FREQ. (MHz)	EMISSION LEVEL (dBuV/m)	READ LEVEL (dBuV)	LIMIT (dBuV/m)	MARGIN (dB)	ANTENNA FACTOR (dB/m)	CABLE LOSS (dB)	PREAMP FACTOR (dB)	ANTENNA HEIGHT (cm)	TABLE ANGLE (Degree)	REMARK
5102	42.64	43.37	54	-11.36	31.28	5.27	37.28	101	8	Average
5102	59.35	60.08	74	-14.65	31.28	5.27	37.28	101	8	Peak
5190	84.56	85.23			31.35	5.32	37.34	101	8	Average
5190	94.39	95.06			31.35	5.32	37.34	101	8	Peak
5418	37.73	37.96	54	-16.27	31.53	5.42	37.18	101	8	Average
5418	59.89	60.12	74	-14.11	31.53	5.42	37.18	101	8	Peak

REMARKS:

- Emission Level = Read Level + Antenna Factor + Cable Loss - Preamp Factor
Margin value = Emission level – Limit value
- 5190MHz: Fundamental frequency.



A D T

EUT TEST CONDITION		MEASUREMENT DETAIL	
CHANNEL	Channel 46	FREQUENCY RANGE	1GHz ~ 40GHz
INPUT POWER	120Vac, 60 Hz	DETECTOR FUNCTION	Peak (PK) Average (AV)
ENVIRONMENTAL CONDITIONS	25deg. C, 65%RH	TESTED BY	Anson Lin

ANTENNA POLARITY & TEST DISTANCE: HORIZONTAL AT 3 M										
FREQ. (MHz)	EMISSION LEVEL (dBuV/m)	READ LEVEL (dBuV)	LIMIT (dBuV/m)	MARGIN (dB)	ANTENNA FACTOR (dB/m)	CABLE LOSS (dB)	PREAMP FACTOR (dB)	ANTENNA HEIGHT (cm)	TABLE ANGLE (Degree)	REMARK
5120	38.95	39.68	54	-15.05	31.29	5.28	37.3	108	198	Average
5120	58.7	59.43	74	-15.3	31.29	5.28	37.3	108	198	Peak
5230	92.23	92.83			31.39	5.33	37.32	108	198	Average
5230	102.48	103.08			31.39	5.33	37.32	108	198	Peak
5406	37.88	38.13	54	-16.12	31.52	5.41	37.18	108	198	Average
5406	59.55	59.8	74	-14.45	31.52	5.41	37.18	108	198	Peak
ANTENNA POLARITY & TEST DISTANCE: VERTICAL AT 3 M										
FREQ. (MHz)	EMISSION LEVEL (dBuV/m)	READ LEVEL (dBuV)	LIMIT (dBuV/m)	MARGIN (dB)	ANTENNA FACTOR (dB/m)	CABLE LOSS (dB)	PREAMP FACTOR (dB)	ANTENNA HEIGHT (cm)	TABLE ANGLE (Degree)	REMARK
5078	37.88	38.62	54	-16.12	31.27	5.26	37.27	101	8	Average
5078	58.98	59.72	74	-15.02	31.27	5.26	37.27	101	8	Peak
5230	84.79	85.39			31.39	5.33	37.32	101	8	Average
5230	94.69	95.29			31.39	5.33	37.32	101	8	Peak
5416	37.57	37.8	54	-16.43	31.53	5.42	37.18	101	8	Average
5416	59.64	59.87	74	-14.36	31.53	5.42	37.18	101	8	Peak

REMARKS:

- Emission Level = Read Level + Antenna Factor + Cable Loss - Preamp Factor
Margin value = Emission level – Limit value
- 5230MHz: Fundamental frequency.



A D T

EUT TEST CONDITION		MEASUREMENT DETAIL	
CHANNEL	Channel 54	FREQUENCY RANGE	1GHz ~ 40GHz
INPUT POWER	120Vac, 60 Hz	DETECTOR FUNCTION	Peak (PK) Average (AV)
ENVIRONMENTAL CONDITIONS	25deg. C, 65%RH	TESTED BY	Anson Lin

ANTENNA POLARITY & TEST DISTANCE: HORIZONTAL AT 3 M										
FREQ. (MHz)	EMISSION LEVEL (dBuV/m)	READ LEVEL (dBuV)	LIMIT (dBuV/m)	MARGIN (dB)	ANTENNA FACTOR (dB/m)	CABLE LOSS (dB)	PREAMP FACTOR (dB)	ANTENNA HEIGHT (cm)	TABLE ANGLE (Degree)	REMARK
5134	37.6	38.31	54	-16.4	31.31	5.28	37.3	107	193	Average
5134	59.44	60.15	74	-14.56	31.31	5.28	37.3	107	193	Peak
5270	92.04	92.55			31.41	5.35	37.27	107	193	Average
5270	101.94	102.45			31.41	5.35	37.27	107	193	Peak
5374	39.46	39.75	54	-14.54	31.49	5.4	37.18	107	193	Average
5374	59.25	59.54	74	-14.75	31.49	5.4	37.18	107	193	Peak
ANTENNA POLARITY & TEST DISTANCE: VERTICAL AT 3 M										
FREQ. (MHz)	EMISSION LEVEL (dBuV/m)	READ LEVEL (dBuV)	LIMIT (dBuV/m)	MARGIN (dB)	ANTENNA FACTOR (dB/m)	CABLE LOSS (dB)	PREAMP FACTOR (dB)	ANTENNA HEIGHT (cm)	TABLE ANGLE (Degree)	REMARK
5100	37.53	38.26	54	-16.47	31.28	5.27	37.28	100	359	Average
5100	59.67	60.4	74	-14.33	31.28	5.27	37.28	100	359	Peak
5270	84.72	85.23			31.41	5.35	37.27	100	359	Average
5270	94.65	95.16			31.41	5.35	37.27	100	359	Peak
5434	37.79	37.95	54	-16.21	31.55	5.42	37.13	100	359	Average
5434	59.81	59.97	74	-14.19	31.55	5.42	37.13	100	359	Peak

REMARKS:

- Emission Level = Read Level + Antenna Factor + Cable Loss - Preamp Factor
Margin value = Emission level – Limit value
- 5270MHz: Fundamental frequency.



A D T

EUT TEST CONDITION		MEASUREMENT DETAIL	
CHANNEL	Channel 62	FREQUENCY RANGE	1GHz ~ 40GHz
INPUT POWER	120Vac, 60 Hz	DETECTOR FUNCTION	Peak (PK) Average (AV)
ENVIRONMENTAL CONDITIONS	25deg. C, 65%RH	TESTED BY	Anson Lin

ANTENNA POLARITY & TEST DISTANCE: HORIZONTAL AT 3 M										
FREQ. (MHz)	EMISSION LEVEL (dBuV/m)	READ LEVEL (dBuV)	LIMIT (dBuV/m)	MARGIN (dB)	ANTENNA FACTOR (dB/m)	CABLE LOSS (dB)	PREAMP FACTOR (dB)	ANTENNA HEIGHT (cm)	TABLE ANGLE (Degree)	REMARK
5004	37.41	38.21	54	-16.59	31.21	5.22	37.23	107	193	Average
5004	58.93	59.73	74	-15.07	31.21	5.22	37.23	107	193	Peak
5310	91.97	92.34			31.45	5.37	37.19	107	193	Average
5310	101.07	101.44			31.45	5.37	37.19	107	193	Peak
5356	50.06	50.37	54	-3.94	31.48	5.39	37.18	107	193	Average
5356	65.21	65.52	74	-8.79	31.48	5.39	37.18	107	193	Peak
ANTENNA POLARITY & TEST DISTANCE: VERTICAL AT 3 M										
FREQ. (MHz)	EMISSION LEVEL (dBuV/m)	READ LEVEL (dBuV)	LIMIT (dBuV/m)	MARGIN (dB)	ANTENNA FACTOR (dB/m)	CABLE LOSS (dB)	PREAMP FACTOR (dB)	ANTENNA HEIGHT (cm)	TABLE ANGLE (Degree)	REMARK
5038	37.36	38.11	54	-16.64	31.24	5.25	37.24	100	359	Average
5038	59.23	59.98	74	-14.77	31.24	5.25	37.24	100	359	Peak
5310	84.38	84.75			31.45	5.37	37.19	100	359	Average
5310	94.88	95.25			31.45	5.37	37.19	100	359	Peak
5438	43.17	43.31	54	-10.83	31.55	5.44	37.13	100	359	Average
5438	59.89	60.03	74	-14.11	31.55	5.44	37.13	100	359	Peak

REMARKS:

- Emission Level = Read Level + Antenna Factor + Cable Loss - Preamp Factor
Margin value = Emission level – Limit value
- 5310MHz: Fundamental frequency.



A D T

EUT TEST CONDITION		MEASUREMENT DETAIL	
CHANNEL	Channel 102	FREQUENCY RANGE	1GHz ~ 40GHz
INPUT POWER	120Vac, 60 Hz	DETECTOR FUNCTION	Peak (PK) Average (AV)
ENVIRONMENTAL CONDITIONS	25deg. C, 65%RH	TESTED BY	Anson Lin

ANTENNA POLARITY & TEST DISTANCE: HORIZONTAL AT 3 M										
FREQ. (MHz)	EMISSION LEVEL (dBuV/m)	READ LEVEL (dBuV)	LIMIT (dBuV/m)	MARGIN (dB)	ANTENNA FACTOR (dB/m)	CABLE LOSS (dB)	PREAMP FACTOR (dB)	ANTENNA HEIGHT (cm)	TABLE ANGLE (Degree)	REMARK
5406	42.13	42.38	54	-11.87	31.52	5.41	37.18	100	188	Average
5406	59.17	59.42	74	-14.83	31.52	5.41	37.18	100	188	Peak
5470	61.74	61.8	68.3	-6.56	31.57	5.45	37.08	100	188	Peak
5510	91.04	91.04			31.6	5.46	37.06	100	188	Average
5510	100.26	100.26			31.6	5.46	37.06	100	188	Peak
5725	58.87	58.75	68.3	-9.43	31.96	5.59	37.43	100	188	Peak
ANTENNA POLARITY & TEST DISTANCE: VERTICAL AT 3 M										
FREQ. (MHz)	EMISSION LEVEL (dBuV/m)	READ LEVEL (dBuV)	LIMIT (dBuV/m)	MARGIN (dB)	ANTENNA FACTOR (dB/m)	CABLE LOSS (dB)	PREAMP FACTOR (dB)	ANTENNA HEIGHT (cm)	TABLE ANGLE (Degree)	REMARK
5436	37.76	37.92	54	-16.24	31.55	5.42	37.13	111	292	Average
5436	59.32	59.48	74	-14.68	31.55	5.42	37.13	111	292	Peak
5470	58.36	58.42	68.3	-9.94	31.57	5.45	37.08	111	292	Peak
5510	82.79	82.79			31.6	5.46	37.06	111	292	Average
5510	91.72	91.72			31.6	5.46	37.06	111	292	Peak
5725	58.24	58.12	68.3	-10.06	31.96	5.59	37.43	111	292	Peak

REMARKS:

- Emission Level = Read Level + Antenna Factor + Cable Loss - Preamp Factor
Margin value = Emission level – Limit value
- 5510MHz: Fundamental frequency.
- 5470MHz & 5725MHz: Out of restricted band



A D T

EUT TEST CONDITION		MEASUREMENT DETAIL	
CHANNEL	Channel 110	FREQUENCY RANGE	1GHz ~ 40GHz
INPUT POWER	120Vac, 60 Hz	DETECTOR FUNCTION	Peak (PK) Average (AV)
ENVIRONMENTAL CONDITIONS	25deg. C, 65%RH	TESTED BY	Anson Lin

ANTENNA POLARITY & TEST DISTANCE: HORIZONTAL AT 3 M										
FREQ. (MHz)	EMISSION LEVEL (dBuV/m)	READ LEVEL (dBuV)	LIMIT (dBuV/m)	MARGIN (dB)	ANTENNA FACTOR (dB/m)	CABLE LOSS (dB)	PREAMP FACTOR (dB)	ANTENNA HEIGHT (cm)	TABLE ANGLE (Degree)	REMARK
5388	38.86	39.12	54	-15.14	31.51	5.41	37.18	100	194	Average
5388	58.74	59	74	-15.26	31.51	5.41	37.18	100	194	Peak
5470	56.61	56.67	68.3	-11.69	31.57	5.45	37.08	100	194	Peak
5550	93.46	93.38			31.68	5.49	37.09	100	194	Average
5550	102.95	102.87			31.68	5.49	37.09	100	194	Peak
5725	59.59	59.47	68.3	-8.71	31.96	5.59	37.43	100	194	Peak

ANTENNA POLARITY & TEST DISTANCE: VERTICAL AT 3 M										
FREQ. (MHz)	EMISSION LEVEL (dBuV/m)	READ LEVEL (dBuV)	LIMIT (dBuV/m)	MARGIN (dB)	ANTENNA FACTOR (dB/m)	CABLE LOSS (dB)	PREAMP FACTOR (dB)	ANTENNA HEIGHT (cm)	TABLE ANGLE (Degree)	REMARK
5380	37.27	37.54	54	-16.73	31.51	5.4	37.18	120	259	Average
5380	59.08	59.35	74	-14.92	31.51	5.4	37.18	120	259	Peak
5470	58.16	58.22	68.3	-10.14	31.57	5.45	37.08	120	259	Peak
5550	85.24	85.16			31.68	5.49	37.09	120	259	Average
5550	95.87	95.79			31.68	5.49	37.09	120	259	Peak
5725	58.87	58.75	68.3	-9.43	31.96	5.59	37.43	120	259	Peak

REMARKS:

- Emission Level = Read Level + Antenna Factor + Cable Loss - Preamp Factor
Margin value = Emission level – Limit value
- 5550MHz: Fundamental frequency.
- 5470MHz & 5725MHz: Out of restricted band



A D T

EUT TEST CONDITION		MEASUREMENT DETAIL	
CHANNEL	Channel 134	FREQUENCY RANGE	1GHz ~ 40GHz
INPUT POWER	120Vac, 60 Hz	DETECTOR FUNCTION	Peak (PK) Average (AV)
ENVIRONMENTAL CONDITIONS	25deg. C, 65%RH	TESTED BY	Anson Lin

ANTENNA POLARITY & TEST DISTANCE: HORIZONTAL AT 3 M										
FREQ. (MHz)	EMISSION LEVEL (dBuV/m)	READ LEVEL (dBuV)	LIMIT (dBuV/m)	MARGIN (dB)	ANTENNA FACTOR (dB/m)	CABLE LOSS (dB)	PREAMP FACTOR (dB)	ANTENNA HEIGHT (cm)	TABLE ANGLE (Degree)	REMARK
5362	37.23	37.53	54	-16.77	31.49	5.39	37.18	100	185	Average
5362	59.29	59.59	74	-14.71	31.49	5.39	37.18	100	185	Peak
5470	57.01	57.07	68.3	-11.29	31.57	5.45	37.08	100	185	Peak
5670	93.23	93.13			31.88	5.56	37.34	100	185	Average
5670	102.38	102.28			31.88	5.56	37.34	100	185	Peak
5725	61.21	61.09	68.3	-7.09	31.96	5.59	37.43	100	185	Peak

ANTENNA POLARITY & TEST DISTANCE: VERTICAL AT 3 M										
FREQ. (MHz)	EMISSION LEVEL (dBuV/m)	READ LEVEL (dBuV)	LIMIT (dBuV/m)	MARGIN (dB)	ANTENNA FACTOR (dB/m)	CABLE LOSS (dB)	PREAMP FACTOR (dB)	ANTENNA HEIGHT (cm)	TABLE ANGLE (Degree)	REMARK
5382	37.25	37.52	54	-16.75	31.51	5.4	37.18	128	279	Average
5382	58.33	58.6	74	-15.67	31.51	5.4	37.18	128	279	Peak
5470	57.66	57.72	68.3	-10.64	31.57	5.45	37.08	128	279	Peak
5670	85.39	85.29			31.88	5.56	37.34	128	279	Average
5670	94.55	94.45			31.88	5.56	37.34	128	279	Peak
5725	58.33	58.21	68.3	-9.97	31.96	5.59	37.43	128	279	Peak

REMARKS:

- Emission Level = Read Level + Antenna Factor + Cable Loss - Preamp Factor
Margin value = Emission level – Limit value
- 5670MHz: Fundamental frequency.
- 5470MHz & 5725MHz: Out of restricted band



A D T

EUT TEST CONDITION		MEASUREMENT DETAIL	
CHANNEL	Channel 151	FREQUENCY RANGE	1GHz ~ 40GHz
INPUT POWER	120Vac, 60 Hz	DETECTOR FUNCTION	Peak (PK) Average (AV)
ENVIRONMENTAL CONDITIONS	25deg. C, 65%RH	TESTED BY	Anson Lin

ANTENNA POLARITY & TEST DISTANCE: HORIZONTAL AT 3 M										
FREQ. (MHz)	EMISSION LEVEL (dBuV/m)	READ LEVEL (dBuV)	LIMIT (dBuV/m)	MARGIN (dB)	ANTENNA FACTOR (dB/m)	CABLE LOSS (dB)	PREAMP FACTOR (dB)	ANTENNA HEIGHT (cm)	TABLE ANGLE (Degree)	REMARK
5714	59.86	59.77	68.3	-8.44	31.93	5.59	37.43	127	219	Peak
5725	64.23	64.11	78.3	-14.07	31.96	5.59	37.43	127	219	Peak
5755	84.27	84.13			32.01	5.6	37.47	127	219	Average
5755	93.64	93.5			32.01	5.6	37.47	127	219	Peak
5850	57.68	57.38	78.3	-20.62	32.15	5.66	37.51	127	219	Peak
5860	58.67	58.33	68.3	-9.63	32.18	5.66	37.5	127	219	Peak

ANTENNA POLARITY & TEST DISTANCE: VERTICAL AT 3 M										
FREQ. (MHz)	EMISSION LEVEL (dBuV/m)	READ LEVEL (dBuV)	LIMIT (dBuV/m)	MARGIN (dB)	ANTENNA FACTOR (dB/m)	CABLE LOSS (dB)	PREAMP FACTOR (dB)	ANTENNA HEIGHT (cm)	TABLE ANGLE (Degree)	REMARK
5714	65.73	65.64	68.3	-2.57	31.93	5.59	37.43	108	179	Peak
5725	73.08	72.96	78.3	-5.22	31.96	5.59	37.43	108	179	Peak
5755	91.23	91.09			32.01	5.6	37.47	108	179	Average
5755	100.84	100.7			32.01	5.6	37.47	108	179	Peak
5850	58.12	57.82	78.3	-20.18	32.15	5.66	37.51	108	179	Peak
5860	59.21	58.87	68.3	-9.09	32.18	5.66	37.5	108	179	Peak

REMARKS:

- Emission Level = Read Level + Antenna Factor + Cable Loss - Preamp Factor
Margin value = Emission level – Limit value
- 5755MHz: Fundamental frequency.
- 5725MHz & 5850MHz: Out of restricted band



A D T

EUT TEST CONDITION		MEASUREMENT DETAIL	
CHANNEL	Channel 159	FREQUENCY RANGE	1GHz ~ 40GHz
INPUT POWER	120Vac, 60 Hz	DETECTOR FUNCTION	Peak (PK) Average (AV)
ENVIRONMENTAL CONDITIONS	25deg. C, 65%RH	TESTED BY	Anson Lin

ANTENNA POLARITY & TEST DISTANCE: HORIZONTAL AT 3 M										
FREQ. (MHz)	EMISSION LEVEL (dBuV/m)	READ LEVEL (dBuV)	LIMIT (dBuV/m)	MARGIN (dB)	ANTENNA FACTOR (dB/m)	CABLE LOSS (dB)	PREAMP FACTOR (dB)	ANTENNA HEIGHT (cm)	TABLE ANGLE (Degree)	REMARK
5714	58.26	58.17	68.3	-10.04	31.93	5.59	37.43	127	219	Peak
5725	59.64	59.52	78.3	-18.66	31.96	5.59	37.43	127	219	Peak
5795	86.28	86.12			32.07	5.63	37.54	127	219	Average
5795	95.56	95.4			32.07	5.63	37.54	127	219	Peak
5850	58.89	58.59	78.3	-19.41	32.15	5.66	37.51	127	219	Peak
5860	58.54	58.2	68.3	-9.76	32.18	5.66	37.5	127	219	Peak
ANTENNA POLARITY & TEST DISTANCE: VERTICAL AT 3 M										
FREQ. (MHz)	EMISSION LEVEL (dBuV/m)	READ LEVEL (dBuV)	LIMIT (dBuV/m)	MARGIN (dB)	ANTENNA FACTOR (dB/m)	CABLE LOSS (dB)	PREAMP FACTOR (dB)	ANTENNA HEIGHT (cm)	TABLE ANGLE (Degree)	REMARK
5714	58.49	58.4	68.3	-9.81	31.93	5.59	37.43	108	179	Peak
5725	60.53	60.41	78.3	-17.77	31.96	5.59	37.43	108	179	Peak
5795	92.86	92.7			32.07	5.63	37.54	108	179	Average
5795	102.52	102.36			32.07	5.63	37.54	108	179	Peak
5850	60.3	60	78.3	-18	32.15	5.66	37.51	108	179	Peak
5860	59.7	59.36	68.3	-8.6	32.18	5.66	37.5	108	179	Peak

REMARKS:

- Emission Level = Read Level + Antenna Factor + Cable Loss - Preamp Factor
Margin value = Emission level – Limit value
- 5795MHz: Fundamental frequency.
- 5725MHz & 5850MHz: Out of restricted band



A D T

BELOW 1GHz WORST-CASE DATA:

5180 ~ 5240MHz

802.11a

EUT TEST CONDITION		MEASUREMENT DETAIL	
CHANNEL	Channel 48	FREQUENCY RANGE	30MHz ~ 1GHz
INPUT POWER	120Vac, 60 Hz	DETECTOR FUNCTION	Peak (PK) Quasi-peak (QP)
ENVIRONMENTAL CONDITIONS	25deg. C, 65%RH	TESTED BY	Anson Lin

ANTENNA POLARITY & TEST DISTANCE: HORIZONTAL AT 3 M										
FREQ. (MHz)	EMISSION LEVEL (dBuV/m)	READ LEVEL (dBuV)	LIMIT (dBuV/m)	MARGIN (dB)	ANTENNA FACTOR (dB/m)	CABLE LOSS (dB)	PREAMP FACTOR (dB)	ANTENNA HEIGHT (cm)	TABLE ANGLE (Degree)	REMARK
99.12	19.16	41.08	43.5	-24.34	8.98	1.06	31.96	118	70	Peak
160.14	31.48	49.24	43.5	-12.02	12.73	1.39	31.88	100	219	Peak
207.12	31.39	51.71	43.5	-12.11	9.69	1.63	31.64	126	360	Peak
307	21.72	38.43	46	-24.28	13.13	2.08	31.92	111	299	Peak
477.8	21.32	33.58	46	-24.68	16.89	2.71	31.86	138	26	Peak
664.7	25.21	33.41	46	-20.79	20.39	3.3	31.89	135	172	Peak
ANTENNA POLARITY & TEST DISTANCE: VERTICAL AT 3 M										
FREQ. (MHz)	EMISSION LEVEL (dBuV/m)	READ LEVEL (dBuV)	LIMIT (dBuV/m)	MARGIN (dB)	ANTENNA FACTOR (dB/m)	CABLE LOSS (dB)	PREAMP FACTOR (dB)	ANTENNA HEIGHT (cm)	TABLE ANGLE (Degree)	REMARK
39.18	30.96	47.93	40	-9.04	13.39	0.64	31	140	78	Peak
194.43	25.07	45.52	43.5	-18.43	9.7	1.57	31.72	124	269	Peak
289.74	26.08	43.09	46	-19.92	12.65	2.01	31.67	132	325	Peak
358.1	22.06	37.41	46	-23.94	14.33	2.26	31.94	118	38	Peak
528.2	24.08	34.91	46	-21.92	17.97	2.88	31.68	107	142	Peak
760.6	27.52	33.7	46	-18.48	21.67	3.6	31.45	100	173	Peak

REMARKS: Emission Level = Read Level + Antenna Factor + Cable Loss - Preamp Factor

Margin value = Emission level – Limit value



A D T

5260 ~ 5320MHz

802.11a

EUT TEST CONDITION		MEASUREMENT DETAIL	
CHANNEL	Channel 60	FREQUENCY RANGE	30MHz ~ 1GHz
INPUT POWER	120Vac, 60 Hz	DETECTOR FUNCTION	Peak (PK) Quasi-peak (QP)
ENVIRONMENTAL CONDITIONS	25deg. C, 65%RH	TESTED BY	Anson Lin

ANTENNA POLARITY & TEST DISTANCE: HORIZONTAL AT 3 M										
FREQ. (MHz)	EMISSION LEVEL (dBuV/m)	READ LEVEL (dBuV)	LIMIT (dBuV/m)	MARGIN (dB)	ANTENNA FACTOR (dB/m)	CABLE LOSS (dB)	PREAMP FACTOR (dB)	ANTENNA HEIGHT (cm)	TABLE ANGLE (Degree)	REMARK
101.82	17.02	38.63	43.5	-26.48	9.25	1.08	31.94	110	258	Peak
160.14	32.11	49.87	43.5	-11.39	12.73	1.39	31.88	103	328	Peak
249.51	36.6	55.26	46	-9.4	11.44	1.83	31.93	104	86	Peak
358.1	27.94	43.29	46	-18.06	14.33	2.26	31.94	123	303	Peak
547.8	23.37	33.93	46	-22.63	18.41	2.94	31.91	106	16	Peak
722.1	26.93	33.94	46	-19.07	21.13	3.5	31.64	120	0	Peak
ANTENNA POLARITY & TEST DISTANCE: VERTICAL AT 3 M										
FREQ. (MHz)	EMISSION LEVEL (dBuV/m)	READ LEVEL (dBuV)	LIMIT (dBuV/m)	MARGIN (dB)	ANTENNA FACTOR (dB/m)	CABLE LOSS (dB)	PREAMP FACTOR (dB)	ANTENNA HEIGHT (cm)	TABLE ANGLE (Degree)	REMARK
37.56	29.86	47.01	40	-10.14	13.24	0.63	31.02	132	3	Peak
193.35	24.48	44.78	43.5	-19.02	9.84	1.56	31.7	103	272	Peak
246.54	27.01	45.75	46	-18.99	11.32	1.82	31.88	106	319	Peak
361.6	23.66	38.92	46	-22.34	14.43	2.27	31.96	122	250	Peak
538.7	23.95	34.57	46	-22.05	18.19	2.91	31.72	107	266	Peak
708.8	25.9	33.24	46	-20.1	20.94	3.46	31.74	100	348	Peak

REMARKS: Emission Level = Read Level + Antenna Factor + Cable Loss - Preamp Factor
Margin value = Emission level – Limit value



A D T

5500 ~ 5700MHz

802.11a

EUT TEST CONDITION		MEASUREMENT DETAIL	
CHANNEL	Channel 116	FREQUENCY RANGE	30MHz ~ 1GHz
INPUT POWER	120Vac, 60 Hz	DETECTOR FUNCTION	Peak (PK) Quasi-peak (QP)
ENVIRONMENTAL CONDITIONS	25deg. C, 65%RH	TESTED BY	Anson Lin

ANTENNA POLARITY & TEST DISTANCE: HORIZONTAL AT 3 M

FREQ. (MHz)	EMISSION LEVEL (dBuV/m)	READ LEVEL (dBuV)	LIMIT (dBuV/m)	MARGIN (dB)	ANTENNA FACTOR (dB/m)	CABLE LOSS (dB)	PREAMP FACTOR (dB)	ANTENNA HEIGHT (cm)	TABLE ANGLE (Degree)	REMARK
42.96	20.34	37.14	40	-19.66	13.58	0.7	31.08	105	54	Peak
206.58	32.25	52.63	43.5	-11.25	9.65	1.63	31.66	120	305	Peak
247.62	31.16	49.88	46	-14.84	11.36	1.82	31.9	140	18	Peak
301.4	26.15	42.96	46	-19.85	12.99	2.06	31.86	109	334	Peak
570.2	24.52	34.68	46	-21.48	18.92	3	32.08	105	129	Peak
713.7	26.28	33.51	46	-19.72	21.01	3.47	31.71	134	229	Peak

ANTENNA POLARITY & TEST DISTANCE: VERTICAL AT 3 M

FREQ. (MHz)	EMISSION LEVEL (dBuV/m)	READ LEVEL (dBuV)	LIMIT (dBuV/m)	MARGIN (dB)	ANTENNA FACTOR (dB/m)	CABLE LOSS (dB)	PREAMP FACTOR (dB)	ANTENNA HEIGHT (cm)	TABLE ANGLE (Degree)	REMARK
30.27	31.07	49.66	40	-8.93	11.98	0.57	31.14	139	132	Peak
55.65	23.78	41.86	40	-16.22	12.45	0.8	31.33	132	147	Peak
195.51	22.7	43.22	43.5	-20.8	9.64	1.57	31.73	104	180	Peak
424.6	21.68	35.36	46	-24.32	15.83	2.52	32.03	128	65	Peak
604.5	24.47	33.89	46	-21.53	19.66	3.1	32.18	118	7	Peak
697.6	26.82	34.42	46	-19.18	20.78	3.42	31.8	103	163	Peak

REMARKS: Emission Level = Read Level + Antenna Factor + Cable Loss - Preamp Factor

Margin value = Emission level – Limit value



A D T

5745 ~ 5825MHz

802.11n (20MHz)

EUT TEST CONDITION		MEASUREMENT DETAIL	
CHANNEL	Channel 157	FREQUENCY RANGE	30MHz ~ 1GHz
INPUT POWER	120Vac, 60 Hz	DETECTOR FUNCTION	Peak (PK) Quasi-peak (QP)
ENVIRONMENTAL CONDITIONS	25deg. C, 65%RH	TESTED BY	Anson Lin

ANTENNA POLARITY & TEST DISTANCE: HORIZONTAL AT 3 M										
FREQ. (MHz)	EMISSION LEVEL (dBuV/m)	READ LEVEL (dBuV)	LIMIT (dBuV/m)	MARGIN (dB)	ANTENNA FACTOR (dB/m)	CABLE LOSS (dB)	PREAMP FACTOR (dB)	ANTENNA HEIGHT (cm)	TABLE ANGLE (Degree)	REMARK
160.14	28.75	46.51	43.5	-14.75	12.73	1.39	31.88	100	291	Peak
199.02	29.1	49.84	43.5	-14.4	9.43	1.59	31.76	122	137	Peak
246.54	36.07	54.81	46	-9.93	11.32	1.82	31.88	112	343	Peak
360.2	27.75	43.07	46	-18.25	14.38	2.27	31.97	100	247	Peak
622.7	24.88	34	46	-21.12	19.88	3.16	32.16	100	28	Peak
740.3	27.6	34.15	46	-18.4	21.38	3.55	31.48	101	271	Peak
ANTENNA POLARITY & TEST DISTANCE: VERTICAL AT 3 M										
FREQ. (MHz)	EMISSION LEVEL (dBuV/m)	READ LEVEL (dBuV)	LIMIT (dBuV/m)	MARGIN (dB)	ANTENNA FACTOR (dB/m)	CABLE LOSS (dB)	PREAMP FACTOR (dB)	ANTENNA HEIGHT (cm)	TABLE ANGLE (Degree)	REMARK
37.29	31.14	48.29	40	-8.86	13.24	0.63	31.02	125	264	Peak
191.73	23.09	43.31	43.5	-20.41	9.91	1.56	31.69	100	353	Peak
249.51	23.02	41.68	46	-22.98	11.44	1.83	31.93	109	323	Peak
358.1	24.64	39.99	46	-21.36	14.33	2.26	31.94	114	331	Peak
534.5	23.41	34.12	46	-22.59	18.1	2.9	31.71	104	175	Peak
722.1	27.09	34.1	46	-18.91	21.13	3.5	31.64	118	30	Peak

REMARKS: Emission Level = Read Level + Antenna Factor + Cable Loss - Preamp Factor

Margin value = Emission level – Limit value

4.2 CONDUCTED EMISSION MEASUREMENT

4.2.1 LIMITS OF CONDUCTED EMISSION MEASUREMENT

FREQUENCY OF EMISSION (MHz)	CONDUCTED LIMIT (dB μ V)	
	Quasi-peak	Average
0.15 ~ 0.5	66 to 56	56 to 46
0.5 ~ 5	56	46
5 ~ 30	60	50

NOTE:

1. The lower limit shall apply at the transition frequencies.
2. The limit decreases in line with the logarithm of the frequency in the range of 0.15 to 0.50MHz.
3. All emanations from a class A/B digital device or system, including any network of conductors and apparatus connected thereto, shall not exceed the level of field strengths specified above.

4.2.2 TEST INSTRUMENTS

DESCRIPTION & MANUFACTURER	MODEL NO.	SERIAL NO.	DATE OF CALIBRATION	DUE DATE OF CALIBRATION
Test Receiver ROHDE & SCHWARZ	ESCS30	100288	Nov. 17, 2013	Nov. 16, 2014
RF signal cable Woken	5D-FB	Cable-HYCO2-01	Dec. 27, 2013	Dec. 26, 2014
LISN ROHDE & SCHWARZ (EUT)	ESH2-Z5	100100	Dec. 23, 2013	Dec. 22, 2014
LISN ROHDE & SCHWARZ (Peripheral)	ESH3-Z5	100311	Jul. 21, 2014	Jul. 20, 2015
Software ADT	BV ADT_Cond_ V7.3.7.3	NA	NA	NA

- NOTE:**
1. The calibration interval of the above test instruments is 12 months and the calibrations are traceable to NML/ROC and NIST/USA.
 2. The test was performed in HwaYa Shielded Room 2.
 3. The VCCI Site Registration No. is C-2047.

4.2.3 TEST PROCEDURES

- a. The EUT was placed 0.4 meters from the conducting wall of the shielded room with EUT being connected to the power mains through a line impedance stabilization network (LISN). Other support units were connected to the power mains through another LISN. The two LISNs provide 50 ohm/ 50uH of coupling impedance for the measuring instrument.
- b. Both lines of the power mains connected to the EUT were checked for maximum conducted interference.
- c. The frequency range from 150kHz to 30MHz was searched. Emission levels under (Limit - 20dB) was not recorded.

NOTE: All modes of operation were investigated and the worst-case emissions are reported.

4.2.4 DEVIATION FROM TEST STANDARD

No deviation.

4.2.5 TEST SETUP

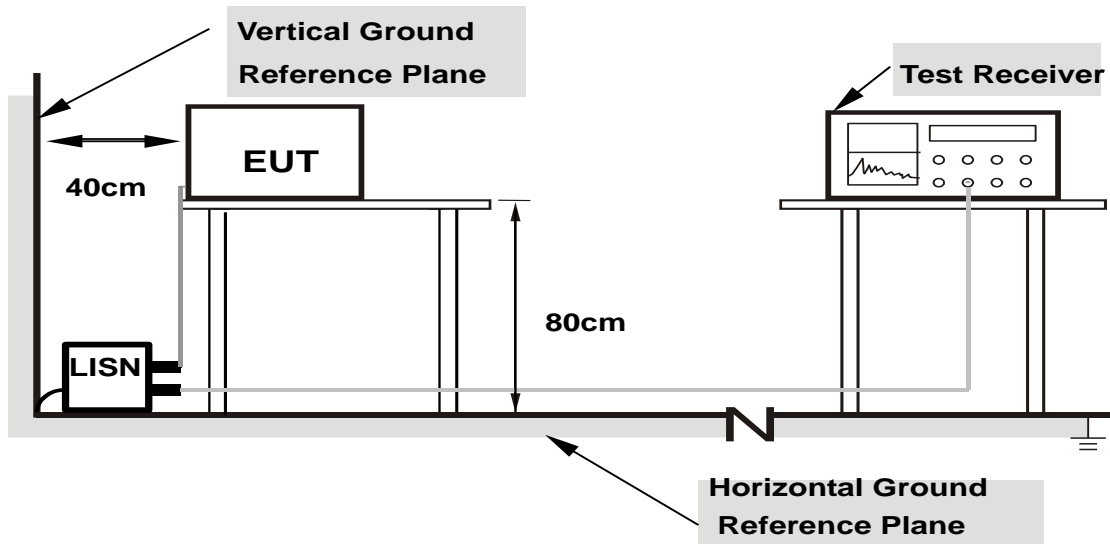

- Note:**
- 1.Support units were connected to second LISN.
 - 2.Both of LISNs (AMN) are 80 cm from EUT and at least 80 from other units and other metal planes

For the actual test configuration, please refer to the attached file (Test Setup Photo).

4.2.6 EUT OPERATING CONDITIONS

Same as section 4.1.6.

4.2.7 TEST RESULTS

CONDUCTED WORST-CASE DATA :

PHASE	Line 1	6dB BANDWIDTH	9kHz
--------------	--------	----------------------	------

Phase Of Power : Line (L)										
No	Frequency (MHz)	Correction Factor (dB)	Reading Value (dBuV)		Emission Level (dBuV)		Limit (dBuV)		Margin (dB)	
			Q.P.	AV.	Q.P.	AV.	Q.P.	AV.	Q.P.	AV.
1	0.16955	0.08	37.53	25.09	37.61	25.17	64.98	54.98	-27.38	-29.82
2	0.38460	0.08	34.96	27.30	35.04	27.38	58.18	48.18	-23.14	-20.80
3	0.48626	0.08	44.49	35.23	44.57	35.31	56.23	46.23	-11.66	-10.92
4	1.27999	0.12	37.49	31.94	37.61	32.06	56.00	46.00	-18.39	-13.94
5	1.79220	0.14	39.13	32.62	39.27	32.76	56.00	46.00	-16.73	-13.24
6	7.41869	0.39	37.51	27.51	37.90	27.90	60.00	50.00	-22.10	-22.10

Remarks:

1. Q.P. and AV. are abbreviations of quasi-peak and average individually.
2. The emission levels of other frequencies were very low against the limit.
3. Margin value = Emission level – Limit value
4. Correction factor = Insertion loss + Cable loss
5. Emission Level = Correction Factor + Reading Value

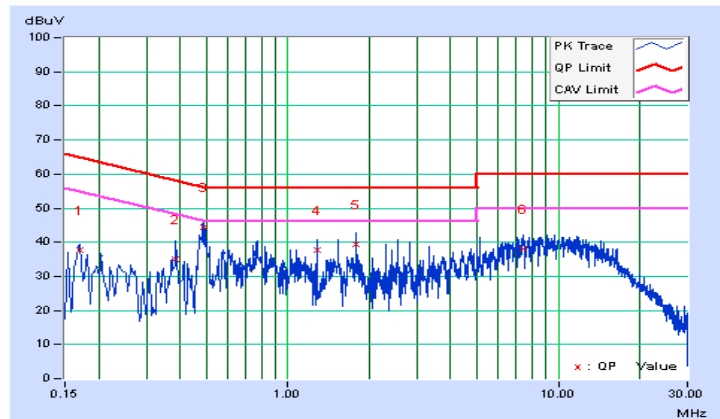



A D T

PHASE	Line 2	6dB BANDWIDTH	9kHz
--------------	--------	----------------------	------

Phase Of Power : Neutral (N)										
No	Frequency (MHz)	Correction Factor (dB)	Reading Value (dBuV)		Emission Level (dBuV)		Limit (dBuV)		Margin (dB)	
			Q.P.	AV.	Q.P.	AV.	Q.P.	AV.	Q.P.	AV.
1	0.16569	0.05	37.57	25.20	37.62	25.25	65.17	55.17	-27.55	-29.92
2	0.19305	0.05	34.72	19.07	34.77	19.12	63.90	53.90	-29.13	-34.78
3	0.48626	0.07	40.42	29.06	40.49	29.13	56.23	46.23	-15.74	-17.10
4	1.54196	0.12	36.68	29.70	36.80	29.82	56.00	46.00	-19.20	-16.18
5	1.79220	0.13	36.28	29.21	36.41	29.34	56.00	46.00	-19.59	-16.66
6	6.39818	0.30	34.92	25.22	35.22	25.52	60.00	50.00	-24.78	-24.48

Remarks:

1. Q.P. and AV. are abbreviations of quasi-peak and average individually.
2. The emission levels of other frequencies were very low against the limit.
3. Margin value = Emission level – Limit value
4. Correction factor = Insertion loss + Cable loss
5. Emission Level = Correction Factor + Reading Value

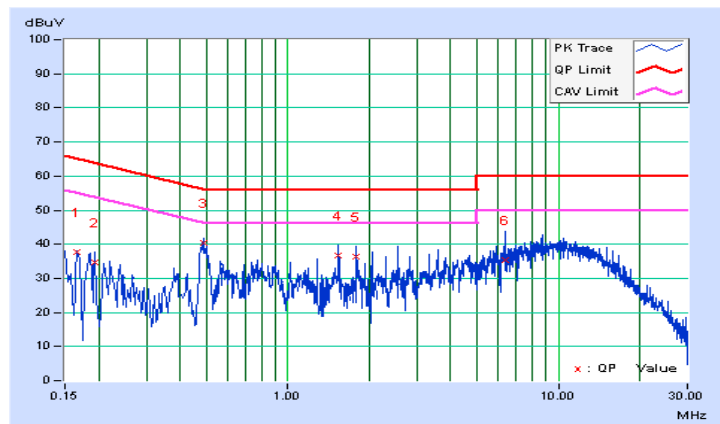

4.3 TRANSMIT POWER MEASUREMENT

4.3.1 LIMITS OF TRANSMIT POWER MEASUREMENT

OPERATION BAND	EUT CATEGORY		LIMIT
U-NII-1		Outdoor Access Point	1 Watt (30 dBm) (Max. e.i.r.p \leq 125mW(21 dBm) at any elevation angle above 30 degrees as measured from the horizon)
		Fixed point-to-point Access Point	1 Watt (30 dBm)
		Indoor Access Point	1 Watt (30 dBm)
	√	Mobile and Portable client device	250mW (24 dBm)
U-NII-2A	√	---	250mW (24 dBm) or 11 dBm+10 log B*
U-NII-2C	√	---	250mW (24 dBm) or 11 dBm+10 log B*
U-NII-3	√	---	1 Watt (30 dBm)

NOTE: Where B is the 26dB emission bandwidth in MHz.

4.3.2 TEST SETUP

FOR POWER OUTPUT MEASUREMENT

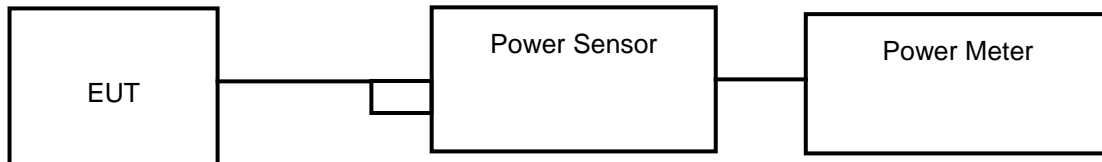

FOR 26dB BANDWIDTH

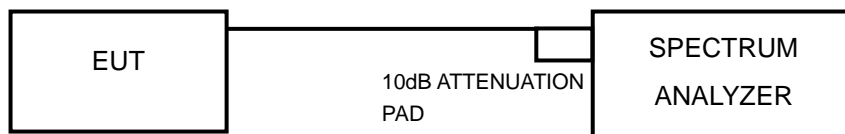

4.3.3 TEST INSTRUMENTS

Refer to section 4.1.3 to get information of above instrument.

4.3.4 TEST PROCEDURE

FOR AVERAGE POWER MEASUREMENT

<802.11a, 802.11n (20MHz), 802.11n (40MHz)>

Method PM is used to perform output power measurement, trigger and gating function of wide band power meter is enabled to measure max output power of TX on burst. Duty factor is not added to measured value.

FOR 26dB BANDWIDTH

- 1) Set RBW = approximately 1% of the emission bandwidth.
- 2) Set the VBW > RBW.
- 3) Detector = Peak.
- 4) Trace mode = max hold.
- 5) Measure the maximum width of the emission that is 26 dB down from the peak of the emission.
Compare this with the RBW setting of the analyzer. Readjust RBW and repeat measurement as needed until the RBW/EBW ratio is approximately 1%.

4.3.5 DEVIATION FROM TEST STANDARD

No deviation.

4.3.6 EUT OPERATING CONDITIONS

The software provided by client to enable the EUT under transmission condition continuously at specific channel frequencies individually.



A D T

4.3.7 TEST RESULTS

POWER OUTPUT

802.11a

CHANNEL	CHANNEL FREQUENCY (MHz)	MAX. CONDUCTED POWER (mW)	MAX. CONDUCTED POWER (dBm)	POWER LIMIT (dBm)	PASS/FAIL
36	5180	22.23	13.47	24	PASS
44	5220	22.80	13.58	24	PASS
48	5240	23.23	13.66	24	PASS
52	5260	21.48	13.32	24	PASS
60	5300	24.43	13.88	24	PASS
64	5320	22.13	13.45	24	PASS
100	5500	18.37	12.64	24	PASS
116	5580	20.04	13.02	24	PASS
140	5700	12.68	11.03	24	PASS
149	5745	98.40	19.93	30	PASS
157	5785	107.40	20.31	30	PASS
165	5825	101.16	20.05	30	PASS

NOTE:

For U-NII-2A, U-NII-2C Band:

1. $11\text{dBm} + 10\log(25.59) = 25.08\text{ dBm} > 24\text{dBm}$.
2. $11\text{dBm} + 10\log(28.72) = 25.58\text{ dBm} > 24\text{dBm}$.
3. $11\text{dBm} + 10\log(23.97) = 24.80\text{ dBm} > 24\text{dBm}$.
4. $11\text{dBm} + 10\log(25.46) = 25.06\text{ dBm} > 24\text{dBm}$.
5. $11\text{dBm} + 10\log(26.48) = 25.23\text{ dBm} > 24\text{dBm}$.
6. $11\text{dBm} + 10\log(23.21) = 24.66\text{ dBm} > 24\text{dBm}$.



A D T

802.11n (20MHz)

CHANNEL	CHANNEL FREQUENCY (MHz)	MAX. CONDUCTED POWER (mW)	MAX. CONDUCTED POWER (dBm)	POWER LIMIT (dBm)	PASS/FAIL
36	5180	21.68	13.36	24	PASS
44	5220	20.61	13.14	24	PASS
48	5240	21.18	13.26	24	PASS
52	5260	19.63	12.93	24	PASS
60	5300	22.49	13.52	24	PASS
64	5320	21.73	13.37	24	PASS
100	5500	18.37	12.64	24	PASS
116	5580	19.63	12.93	24	PASS
140	5700	11.53	10.62	24	PASS
149	5745	90.99	19.59	30	PASS
157	5785	108.89	20.37	30	PASS
165	5825	102.80	20.12	30	PASS

NOTE:

For U-NII-2A, U-NII-2C Band:

1. $11\text{dBm} + 10\log(29.91) = 25.76\text{ dBm} > 24\text{dBm}$.
2. $11\text{dBm} + 10\log(29.92) = 25.76\text{ dBm} > 24\text{dBm}$.
3. $11\text{dBm} + 10\log(29.59) = 25.71\text{ dBm} > 24\text{dBm}$.
4. $11\text{dBm} + 10\log(26.82) = 25.29\text{ dBm} > 24\text{dBm}$.
5. $11\text{dBm} + 10\log(28.96) = 25.62\text{ dBm} > 24\text{dBm}$.
6. $11\text{dBm} + 10\log(23.36) = 24.69\text{ dBm} > 24\text{dBm}$.



A D T

802.11n (40MHz)

CHANNEL	CHANNEL FREQUENCY (MHz)	MAX. CONDUCTED POWER (mW)	MAX. CONDUCTED POWER (dBm)	POWER LIMIT (dBm)	PASS/FAIL
38	5190	14.49	11.61	24	PASS
46	5230	15.24	11.83	24	PASS
54	5270	13.30	11.24	24	PASS
62	5310	13.87	11.42	24	PASS
102	5510	9.04	9.56	24	PASS
110	5550	12.36	10.92	24	PASS
134	5670	13.12	11.18	24	PASS
151	5755	74.47	18.72	30	PASS
159	5795	98.17	19.92	30	PASS

NOTE:

For U-NII-2A, U-NII-2C Band:

1. $11\text{dBm} + 10\log(46.00) = 27.63\text{ dBm} > 24\text{dBm}$.
2. $11\text{dBm} + 10\log(51.33) = 28.10\text{ dBm} > 24\text{dBm}$.
3. $11\text{dBm} + 10\log(47.82) = 27.80\text{ dBm} > 24\text{dBm}$.
4. $11\text{dBm} + 10\log(48.18) = 27.83\text{ dBm} > 24\text{dBm}$.
5. $11\text{dBm} + 10\log(51.75) = 28.14\text{ dBm} > 24\text{dBm}$.



A D T

26dB BANDWIDTH

802.11a

CHANNEL	CHANNEL FREQUENCY (MHz)	26dBc BANDWIDTH (MHz)	PASS / FAIL
52	5260	25.59	PASS
60	5300	28.72	PASS
64	5320	23.97	PASS
100	5500	25.46	PASS
116	5580	26.48	PASS
140	5700	23.21	PASS

802.11n (20MHz)

CHANNEL	CHANNEL FREQUENCY (MHz)	26dBc BANDWIDTH (MHz)	PASS / FAIL
52	5260	29.91	PASS
60	5300	29.92	PASS
64	5320	29.59	PASS
100	5500	26.82	PASS
116	5580	28.96	PASS
140	5700	23.36	PASS

802.11n (40MHz)

CHANNEL	CHANNEL FREQUENCY (MHz)	26dBc BANDWIDTH (MHz)	PASS / FAIL
54	5270	46.00	PASS
62	5310	51.33	PASS
102	5510	47.82	PASS
110	5550	48.18	PASS
134	5670	51.75	PASS



A D T

SPECTRUM PLOT OF WORST VALUE

802.11a

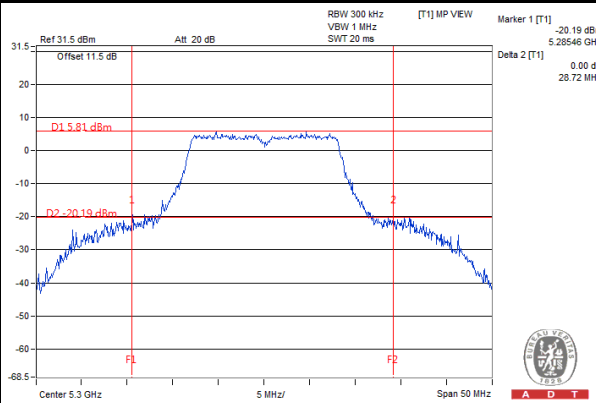

802.11n (20MHz)

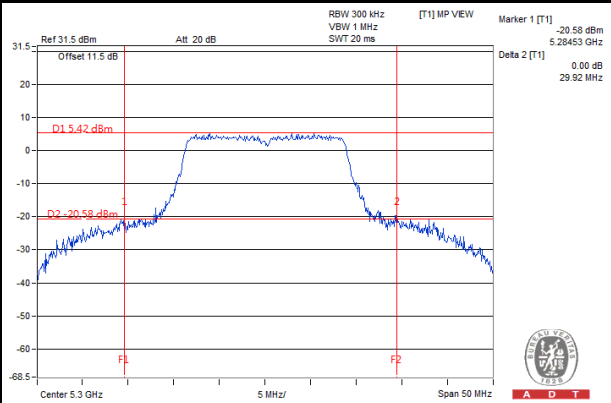

802.11n (40MHz)

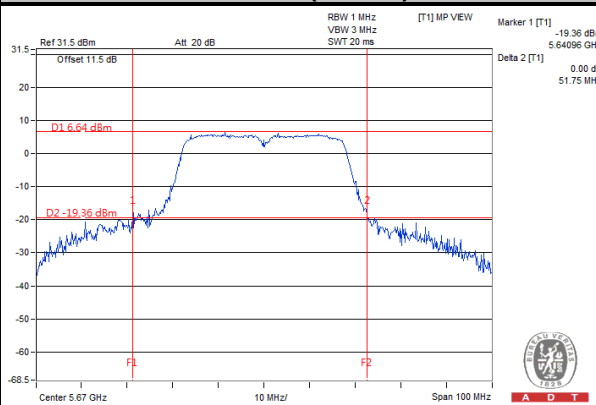

4.4 PEAK POWER SPECTRAL DENSITY MEASUREMENT

4.4.1 LIMITS OF PEAK POWER SPECTRAL DENSITY MEASUREMENT

Operation Band	EUT Category		LIMIT
U-NII-1		Outdoor Access Point	17dBm/ MHz
		Fixed point-to-point Access Point	
		Indoor Access Point	
	√	Mobile and Portable client device	11dBm/ MHz
U-NII-2A	√	---	11dBm/ MHz
U-NII-2C	√	---	11dBm/ MHz
U-NII-3	√	---	30dBm/ MHz

4.4.2 TEST SETUP

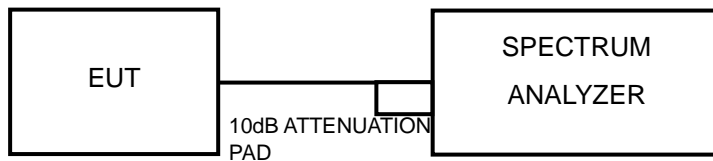

4.4.3 TEST INSTRUMENTS

Refer to section 4.1.3 to get information of above instrument.

4.4.4 TEST PROCEDURES

For U-NII-1, U-NII-2A, U-NII-2C band:

<802.11a, 802.11n (20MHz), 802.11n (40MHz) >

Using method SA-2 alternative

- 1) Set span to encompass the entire emission bandwidth (EBW) of the signal.
- 2) Set RBW = 1 MHz, Set VBW ≥ 3 MHz, Detector = RMS
- 3) Sweep time = 4second.
- 4) Perform a single sweep.
- 5) Record the max value and add 10 log (1/duty cycle)

For U-NII-3 band:

- 1) Set span to encompass the entire emission bandwidth (EBW) of the signal.
- 2) Set RBW = 500 kHz, Set VBW ≥ 3 RBW, Detector = RMS
- 3) Sweep time = auto, trigger set to “free run”.
- 4) Trace average at least 100 traces in power averaging mode.
- 5) Record the max value and add 10 log (1/duty cycle)



A D T

4.4.5 DEVIATION FROM TEST STANDARD

No deviation.

4.4.6 EUT OPERATING CONDITIONS

Same as Item 4.3.6.



4.4.7 TEST RESULTS

802.11a

CHANNEL	FREQUENCY (MHz)	PSD W/O DUTY FACTOR (dBm)	DUTY FACTOR	PSD WITH DUTY FACTOR (dBm)	MAXIMUM LIMIT (dBm)	PASS/FAIL
36	5180	0.19	0.98	1.17	4	PASS
44	5220	0.52	0.98	1.50	4	PASS
48	5240	0.75	0.98	1.73	4	PASS
52	5260	0.81	0.98	1.79	11	PASS
60	5300	1.21	0.98	2.19	11	PASS
64	5320	1.14	0.98	2.12	11	PASS
100	5500	0.95	0.98	1.93	11	PASS
116	5580	1.03	0.98	2.01	11	PASS
140	5700	-0.93	0.98	0.05	11	PASS
149	5745	-8.66	0.98	-7.68	30	PASS
157	5785	-7.92	0.98	-6.94	30	PASS
165	5825	-4.27	0.98	-3.29	30	PASS

NOTE: Refer to section 3.3 for duty cycle spectrum plot.

802.11n (20MHz)

CHANNEL	FREQUENCY (MHz)	PSD W/O DUTY FACTOR (dBm)	DUTY FACTOR	PSD WITH DUTY FACTOR (dBm)	MAXIMUM LIMIT (dBm)	PASS/FAIL
36	5180	-0.04	1.05	1.01	4	PASS
44	5220	-0.05	1.05	1.00	4	PASS
48	5240	0.24	1.05	1.29	4	PASS
52	5260	0.18	1.05	1.23	11	PASS
60	5300	0.82	1.05	1.87	11	PASS
64	5320	0.59	1.05	1.64	11	PASS
100	5500	0.45	1.05	1.50	11	PASS
116	5580	0.49	1.05	1.54	11	PASS
140	5700	-2.04	1.05	-0.99	11	PASS
149	5745	-6.22	1.02	-5.20	30	PASS
157	5785	-5.29	1.02	-4.27	30	PASS
165	5825	-4.89	1.02	-3.87	30	PASS

NOTE: Refer to section 3.3 for duty cycle spectrum plot.



A D T

802.11n (40MHz)

CHANNEL	FREQUENCY (MHz)	PSD W/O DUTY FACTOR (dBm)	DUTY FACTOR	PSD WITH DUTY FACTOR (dBm)	MAXIMUM LIMIT (dBm)	PASS/FAIL
38	5190	-4.79	2.01	-2.78	4	PASS
46	5230	-4.47	2.01	-2.46	4	PASS
54	5270	-4.11	2.01	-2.10	11	PASS
62	5310	-3.92	2.01	-1.91	11	PASS
102	5510	-5.75	2.01	-3.74	11	PASS
110	5550	-4.36	2.01	-2.35	11	PASS
134	5670	-4.53	2.01	-2.52	11	PASS
151	5755	-17.66	2.01	-15.65	30	PASS
159	5795	-16.91	2.01	-14.90	30	PASS

NOTE: Refer to section 3.3 for duty cycle spectrum plot.

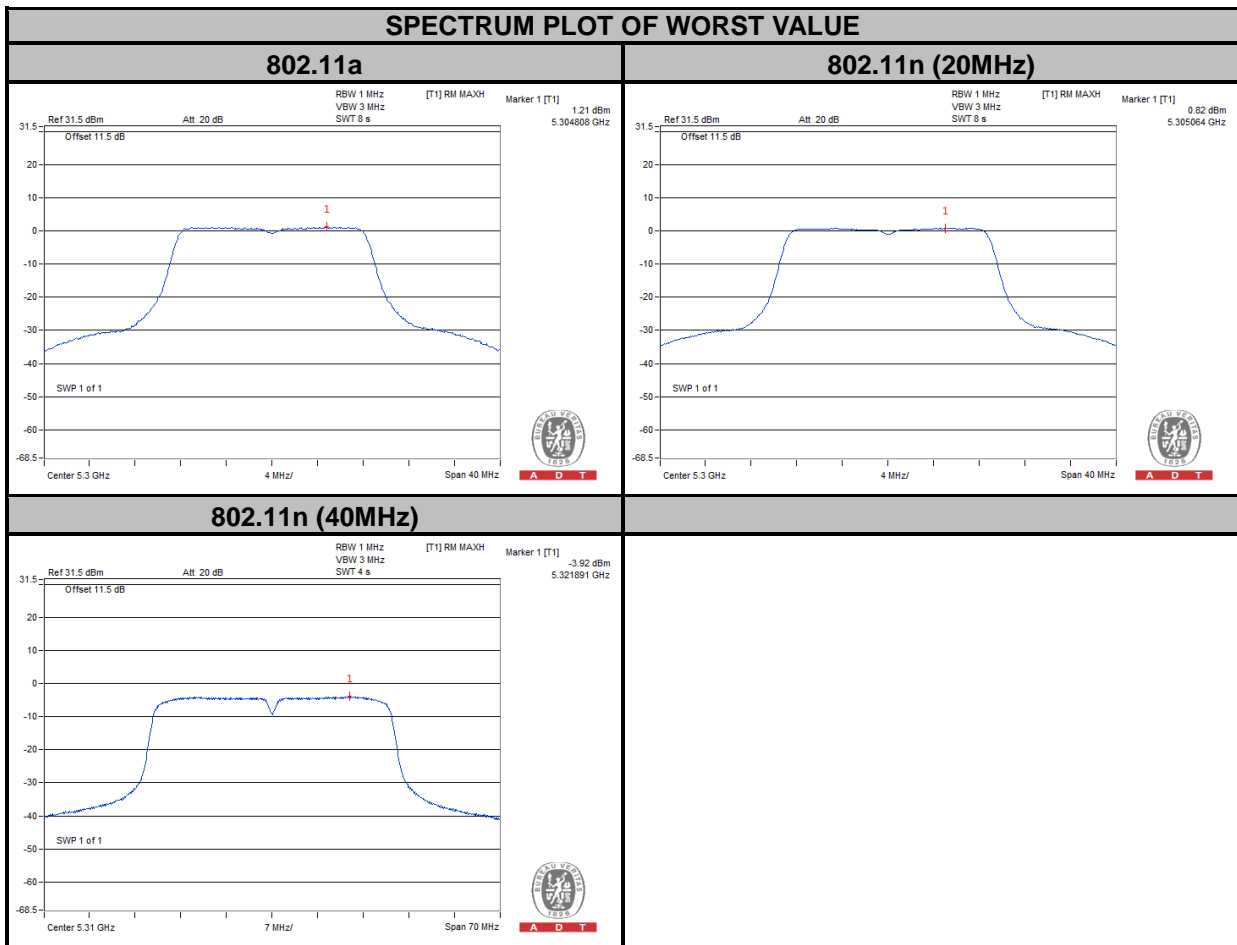

4.5 FREQUENCY STABILITY

4.5.1 LIMITS OF FREQUENCY STABILITY MEASUREMENT

The frequency of the carrier signal shall be maintained within band of operation.

4.5.2 TEST SETUP

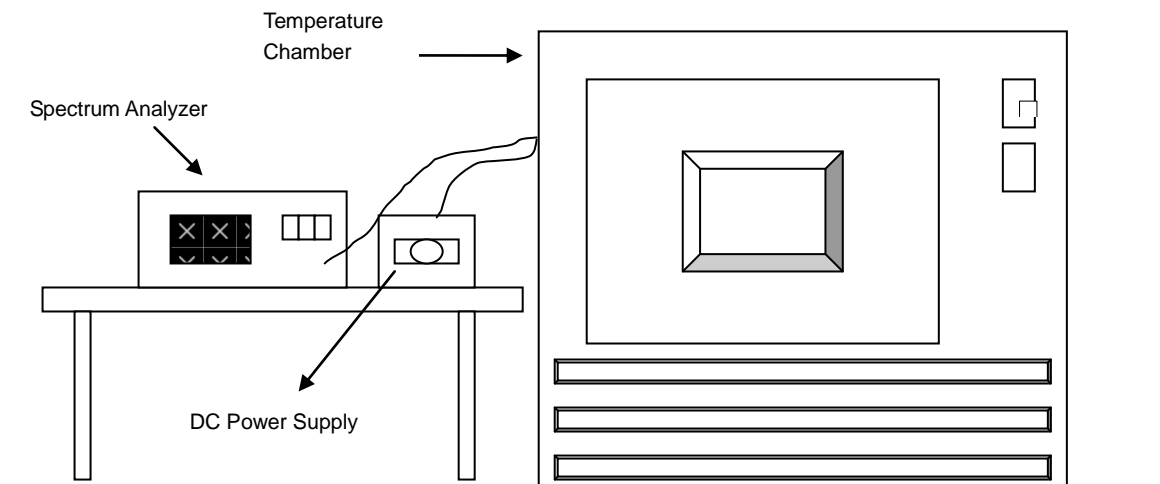

4.5.3 TEST INSTRUMENTS

Refer to section 4.1.3 to get information of above instrument.



A D T

4.5.4 TEST PROCEDURE

- a. To ensure emission at the band edge is maintained within the authorized band, those values shall be measured by radiation emissions at upper and lower frequency points, and finally compensated by frequency deviation as procedures below.
- b. The EUT was operated at the maximum output power, and connected to the spectrum analyzer, which is set to maximum hold function and peak detector. The peak value of the power envelope was measured and noted. The upper and lower frequency points were respectively measured relatively 10dB lower than the measured peak value.
- c. The frequency deviation was calculated by adding the upper frequency point and the lower frequency point divided by two. Those detailed values of frequency deviation are provided in table below.

4.5.5 DEVIATION FROM TEST STANDARD

No deviation.

4.5.6 EUT OPERATING CONDITION

Set the EUT transmit at un-modulation mode to test frequency stability.



A D T

4.5.7 TEST RESULTS

FREQUENCY STABILITY VERSUS TEMP.									
OPERATING FREQUENCY: 5320MHz									
TEMP. (°C)	POWER SUPPLY (Vdc)	0 MINUTE		2 MINUTE		5 MINUTE		10 MINUTE	
		Measured Frequency (MHz)	Frequency Drift (ppm)	Measured Frequency (MHz)	Frequency Drift (ppm)	Measured Frequency (MHz)	Frequency Drift (ppm)	Measured Frequency (MHz)	Frequency Drift (ppm)
60	3.8	5320.0395	7.430	5320.03899 ₅	7.330	5320.03936 ₅	7.399	5320.03900 ₉	7.333
50	3.8	5320.0399	7.500	5320.03978 ₅	7.478	5320.04012 ₀	7.541	5320.03995 ₁	7.510
40	3.8	5320.0398	7.489	5320.04029 ₄	7.574	5320.04034 ₂	7.583	5320.04017 ₃	7.551
30	3.8	5320.0407	7.645	5320.04094 ₂	7.696	5320.04144 ₈	7.791	5320.04127 ₉	7.759
20	3.8	5320.0424	7.965	5320.04195 ₃	7.886	5320.04226 ₂	7.944	5320.04243 ₇	7.977
10	3.8	5320.0432	8.114	5320.04345 ₉	8.169	5320.04381 ₂	8.235	5320.04338 ₂	8.155
0	3.8	5320.0419	7.876	5320.04221 ₀	7.934	5320.04205 ₂	7.905	5320.04180 ₆	7.858
-10	3.8	5320.0406	7.624	5320.04030 ₂	7.576	5320.04061 ₈	7.635	5320.04044 ₃	7.602
-20	3.8	5320.0402	7.561	5320.03972 ₁	7.466	5320.04017 ₇	7.552	5320.04035 ₃	7.585
-30	3.8	5320.0391	7.354	5320.03890 ₀	7.312	5320.03900 ₆	7.332	5320.03931 ₇	7.390

FREQUENCY STABILITY VERSUS VOLTAGE									
OPERATING FREQUENCY: 5320MHz									
TEMP. (°C)	POWER SUPPLY (Vdc)	0 MINUTE		2 MINUTE		5 MINUTE		10 MINUTE	
		Measured Frequency (MHz)	Frequency Drift (ppm)	Measured Frequency (MHz)	Frequency Drift (ppm)	Measured Frequency (MHz)	Frequency Drift (ppm)	Measured Frequency (MHz)	Frequency Drift (ppm)
20	3.4	5320.04149 ₅	7.800	5320.04197 ₀	7.889	5320.04178 ₀	7.853	5320.04146 ₁	7.793
	3.8	5320.04237 ₆	7.965	5320.04195 ₃	7.886	5320.04226 ₂	7.944	5320.04243 ₇	7.977
	4.35	5320.04363 ₈	8.203	5320.04287 ₆	8.059	5320.04322 ₃	8.125	5320.04363 ₆	8.202

4.6 6dB BANDWIDTH MEASUREMENT

4.6.1 LIMITS OF 6dB BANDWIDTH MEASUREMENT

The minimum of 6dB Bandwidth Measurement is 0.5MHz.

4.6.2 TEST SETUP

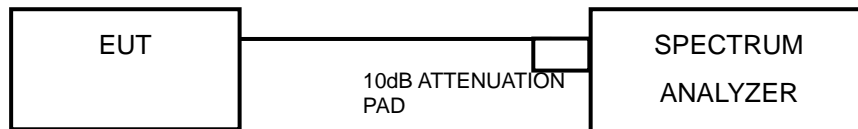

4.6.3 TEST INSTRUMENTS

Refer to section 4.1.3 to get information of above instrument.

4.6.4 TEST PROCEDURE

- Set resolution bandwidth (RBW) = 100kHz
- Set the video bandwidth (VBW) $\geq 3 \times$ RBW, Detector = Peak.
- Trace mode = max hold.
- Sweep = auto couple.
- Measure the maximum width of the emission that is constrained by the frequencies associated with the two amplitude points (upper and lower) that are attenuated by 6 dB relative to the maximum level measured in the fundamental emission.

4.6.5 DEVIATION FROM TEST STANDARD

No deviation.

4.6.6 EUT OPERATING CONDITIONS

The software provided by client to enable the EUT under transmission condition continuously at lowest, middle and highest channel frequencies individually.



A D T

4.6.7 TEST RESULTS

802.11a

CHANNEL	FREQUENCY (MHz)	6dB BANDWIDTH (MHz)	MINIMUM LIMIT (MHz)	PASS / FAIL
149	5745	16.42	0.5	PASS
157	5785	16.41	0.5	PASS
165	5825	16.40	0.5	PASS

802.11n (20MHz)

CHANNEL	FREQUENCY (MHz)	6dB BANDWIDTH (MHz)	MINIMUM LIMIT (MHz)	PASS / FAIL
149	5745	17.63	0.5	PASS
157	5785	17.64	0.5	PASS
165	5825	17.65	0.5	PASS

802.11n (40MHz)

CHANNEL	FREQUENCY (MHz)	6dB BANDWIDTH (MHz)	MINIMUM LIMIT (MHz)	PASS / FAIL
151	5755	35.22	0.5	PASS
159	5795	35.23	0.5	PASS



A D T

SPECTRUM PLOT OF WORST VALUE

802.11a

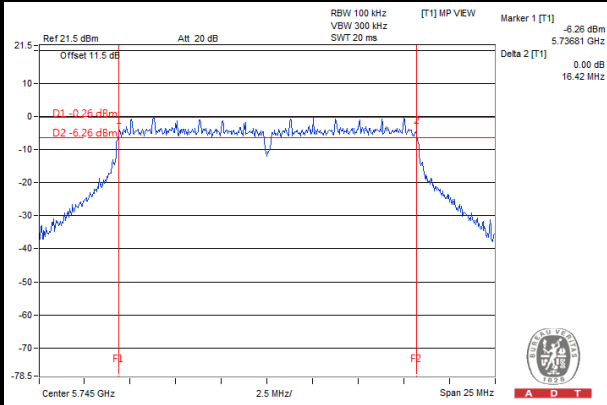

802.11n (20MHz)

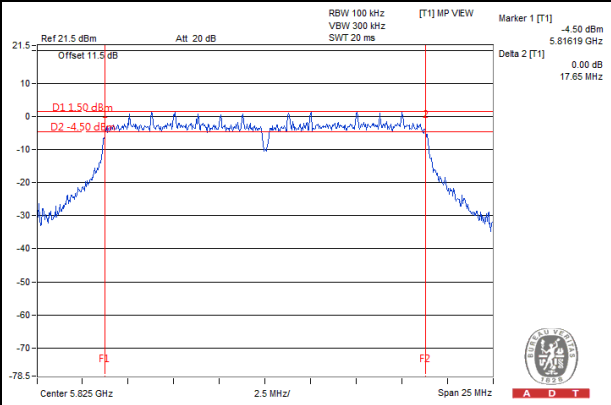

802.11n (40MHz)

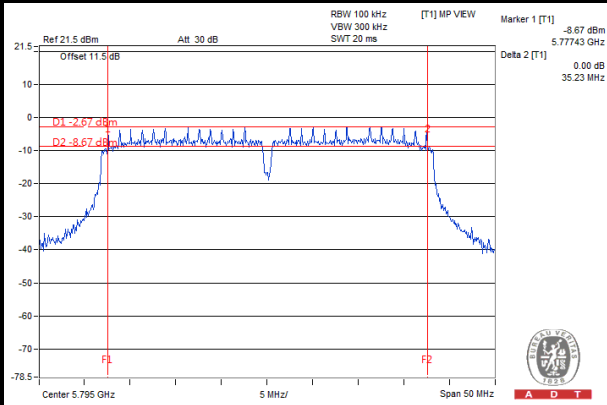



A D T

5. PHOTOGRAPHS OF THE TEST CONFIGURATION

Please refer to the attached file (Test Setup Photo).



6. INFORMATION ON THE TESTING LABORATORIES

We, Bureau Veritas Consumer Products Services (H.K.) Ltd., Taoyuan Branch, were founded in 1988 to provide our best service in EMC, Radio, Telecom and Safety consultation. Our laboratories are accredited and approved according to ISO/IEC 17025.

If you have any comments, please feel free to contact us at the following:

Linko EMC/RF Lab:

Tel: 886-2-26052180

Fax: 886-2-26051924

Hsin Chu EMC/RF Lab:

Tel: 886-3-5935343

Fax: 886-3-5935342

Hwa Ya EMC/RF/Safety Telecom Lab:

Tel: 886-3-3183232

Fax: 886-3-3270892

Email: service.adt@tw.bureauveritas.com

Web Site: www.bureauveritas-adt.com

The address and road map of all our labs can be found in our web site also.



A D T

7. APPENDIX A - MODIFICATIONS RECORDERS FOR ENGINEERING CHANGES TO THE EUT BY THE LAB

No any modifications are made to the EUT by the lab during the test.

---END---