

HAC RF-Emission Test Report

Report No. : HFBFJZ-WTW-P22040598

Applicant : Kyocera Corporation % Kyocera International, Inc.

Address : 8611 Balboa Avenue, San Diego, CA 92123

Product : Feature Phone

FCC ID : V65E4811

Brand : Kyocera

Model No. : E4811

Series Model No. : E4811NC (refer to section 2 for more details)

Standards : FCC 47 CFR Part 20.19, ANSI C63.19-2011
KDB 285076 D01 v05, KDB 285076 D02 v03r01

Sample Received Date : Apr. 22, 2022

Date of Testing : May 30, 2022

M-Rating Summary : M4

Lab Address : No. 47-2, 14th Ling, Chia Pau Vil., Lin Kou Dist., New Taipei City, Taiwan

Test Location : No. 19, Hwa Ya 2nd Rd., Wen Hwa Vil., Kwei Shan Dist., Taoyuan City, Taiwan

CERTIFICATION: The above equipment have been tested by **Bureau Veritas Consumer Products Services (H.K.) Ltd., Taoyuan Branch – Lin Kou Laboratories**, and found compliance with the requirement of the above standards. The test record, data evaluation & Equipment Under Test (EUT) configurations represented herein are true and accurate accounts of the measurements of the sample's HAC characteristics under the conditions specified in this report. It should not be reproduced except in full, without the written approval of our laboratory. The client should not use it to claim product certification, approval, or endorsement by TAF or any government agencies.

Prepared By :

Vera Huang

Vera Huang / Specialist

Approved By :

Gordon Lin

Gordon Lin / Manager



Testing Laboratory
2021

FCC Accredited No.: TW0003

This report is governed by, and incorporates by reference, the Conditions of Testing as posted at the date of issuance of this report at <http://www.bureauveritas.com/home/about-us/our-business/cps/about-us/terms-conditions/> and is intended for your exclusive use. Any copying or replication of this report to or for any other person or entity, or use of our name or trademark, is permitted only with our prior written permission. This report sets forth our findings solely with respect to the test samples identified herein. The results set forth in this report are not indicative or representative of the quality or characteristics of the lot from which a test sample was taken or any similar or identical product unless specifically and expressly noted. Our report includes all of the tests requested by you and the results thereof based upon the information that you provided to us. Measurement uncertainty is only provided upon request for accredited tests. Statements of conformity are based on simple acceptance criteria without taking measurement uncertainty into account, unless otherwise requested in writing. You have 60 days from date of issuance of this report to notify us of any material error or omission caused by our negligence or if you require measurement uncertainty; provided, however, that such notice shall be in writing and shall specifically address the issue you wish to raise. A failure to raise such issue within the prescribed time shall constitute your unqualified acceptance of the completeness of this report, the tests conducted and the correctness of the report contents.

Table of Contents

Release Control Record	3
1. Summary of Maximum M-Rating	4
2. Description of Equipment Under Test	5
3. HAC RF Emission Measurement System	7
3.1 SPEAG DASY6 System	7
3.1.1 Robot.....	8
3.1.2 Probes.....	8
3.1.3 Data Acquisition Electronics (DAE)	9
3.1.4 Phantoms	9
3.1.5 Device Holder.....	9
3.1.6 RF Emission Calibration Dipoles.....	9
3.2 DASY6 System Verification	10
3.3 EUT Measurements Reference and Plane	11
3.4 HAC RF Emission Measurement Procedure	12
3.5 Modulation Interference Factor	14
4. HAC Measurement Evaluation.....	16
4.1 M-Rating Category	16
4.2 EUT Configuration and Setting.....	16
4.3 System Verification.....	17
4.4 Maximum Target Conducted Power	17
4.5 Low Power Exemption Evaluation.....	17
4.6 Measured Conducted Power Results	17
4.7 HAC RF Emission Testing Results	17
5. Calibration of Test Equipment.....	18
6. Measurement Uncertainty.....	19
7. Information of the Testing Laboratories.....	20
Annex A. Plots of System Verification	
Annex B. Plots of HAC RF Emission Measurement	
Annex C. System Verification	
Annex D. Maximum Target Conducted Power	
Annex E. Low Power Exemption Evaluation	
Annex F. Measured Conducted Power Result	
Annex G. HAC RF Emission Test Result	
Annex H. Calibration of Test Equipment List	
Annex Z. Calibration Certificate for Probe and Dipole	

Release Control Record

Report No.	Reason for Change	Date Issued
HFBJZ-WTW-P22040598	Initial release	Jul. 22, 2022

1. Summary of Maximum M-Rating

Mode	Band	Maximum Audio Interference Level (dBV/m)	M-Rating
WCDMA	Band II	N/A	M4
	Band V	N/A	M4
FDD-LTE	Band 2	N/A	M4
	Band 4	N/A	M4
	Band 5	N/A	M4
	Band 12	N/A	M4
	Band 13	N/A	M4
WLAN	2.4G	16.36	M4
	5.2G	N/A	M4
	5.3G	N/A	M4
	5.6G	N/A	M4
	5.8G	N/A	M4
M-Rating Summary		M4	

Note:

1. The HAC RF emission limit (**M-rating Category M3**) is specified in FCC 47 CFR part 20.19 and ANSI C63.19.
2. The device RF emission rating is determined by the minimum rating.

HAC RF-Emission Test Report

2. Description of Equipment Under Test

EUT Type	Feature Phone
FCC ID	V65E4811
Brand Name	Kyocera
Model Name	E4811
Series Model Name	E4811NC
Tx Frequency Bands (Unit: MHz)	WCDMA Band II : 1852.4 ~ 1907.6 WCDMA Band V : 826.4 ~ 846.6 LTE Band 2 : 1850.7 ~ 1909.3 LTE Band 4 : 1710.7 ~ 1754.3 LTE Band 5 : 824.7 ~ 848.3 LTE Band 12 : 699.7 ~ 715.3 LTE Band 13 : 779.5 ~ 784.5 WLAN : 2412 ~ 2462, 5180 ~ 5240, 5260 ~ 5320, 5500 ~ 5720, 5745 ~ 5825 Bluetooth : 2402 ~ 2480
Uplink Modulations	WCDMA : QPSK LTE : QPSK, 16QAM 802.11b : DSSS 802.11a/g/n/ac : OFDM Bluetooth : GFSK, $\pi/4$ -DQPSK, 8-DPSK
Antenna Type	Internal fixed monopole
EUT Stage	Identical Prototype

Note:

- All models are listed as below.

Brand	Model	Difference
Kyocera	E4811	with Camera function
	E4811NC	without Camera function

- The WLAN/BT module (Brand: Mediatek, Model: MT6631) was installed in the EUT.
- The above EUT information is declared by manufacturer and for more detailed features description please refers to the manufacturer's specifications or User's Manual.

List of Accessory:

Battery	Brand Name	Kyocera
	Model Name	SCP-73LBPS
	Power Rating	3.8Vdc, 1770mAh, 6.8 Wh
	Type	Li-ion

HAC RF-Emission Test Report

Air Interface and Operational Mode:

Air Interface	Bands	Transport Type	HAC Tested	Simultaneous But Not Tested	Name of Voice Service	Power Reduction
WCDMA	II	VO	No ⁽¹⁾	WLAN or BT	CMRS Voice	No
	V					No
	HSPA	DT	No	WLAN or BT	N/A	No
FDD-LTE	2	VD	No ⁽¹⁾	WLAN or BT	N/A	No
	4					No
	5					No
	12					No
	13					No
WLAN	2.4G	VD	YES	WWAN	N/A	No
	5.2G	VD	No ⁽¹⁾		N/A	No
	5.3G					No
	5.6G					No
	5.8G					No
Bluetooth	2.4G	DT	No	WWAN	N/A	No
Transport Type VO = Legacy Cellular Voice Service DT = Digital Transport Only (No Voice) VD = IP Voice Service over Digital Transport			Note 1. It applies the low power exemption per ANSI C63.19-2011.			

3. HAC RF Emission Measurement System

3.1 SPEAG DASY6 System

The SPEAG DASY6 system consists of high precision robot, probe alignment sensor, phantom, robot controller, controlled measurement server and near-field probe. The robot includes six axes that can move to the precision position of the DASY6 software defined. The DASY6 software can define the area that is detected by the probe. The robot is connected to controlled box. Controlled measurement server is connected to the controlled robot box. The DAE includes amplifier, signal multiplexing, AD converter, offset measurement and surface detection. It is connected to the Electro-optical coupler (EOC). The EOC performs the conversion form the optical into digital electric signal of the DAE and transfers data to the PC.

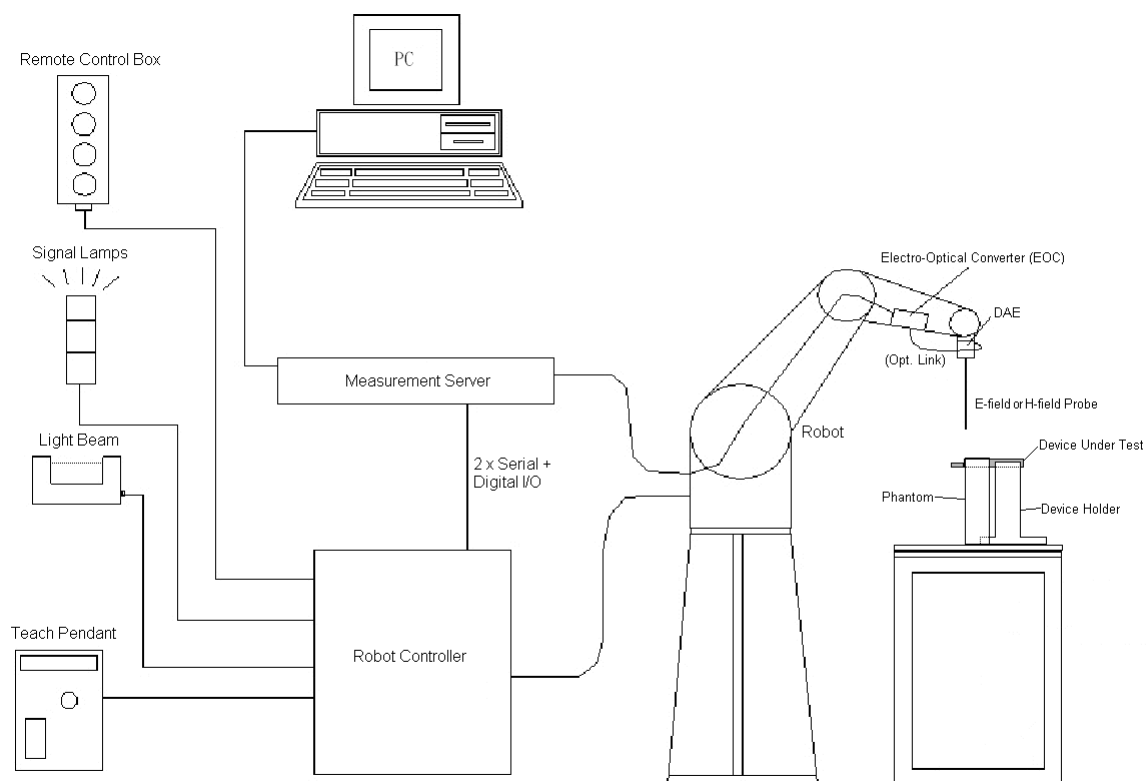

Fig-3.1 SPEAG DASY6 System Setup

HAC RF-Emission Test Report

3.1.1 Robot

The DASY6 system uses the high precision robots from Stäubli SA (France). For the 6-axis controller system, the robot controller version (DASY6: CS8c) from Stäubli is used. The Stäubli robot series have many features that are important for our application:

- High precision (repeatability ± 0.035 mm)
- High reliability (industrial design)
- Jerk-free straight movements
- Low ELF interference (the closed metallic construction shields against motor control fields)

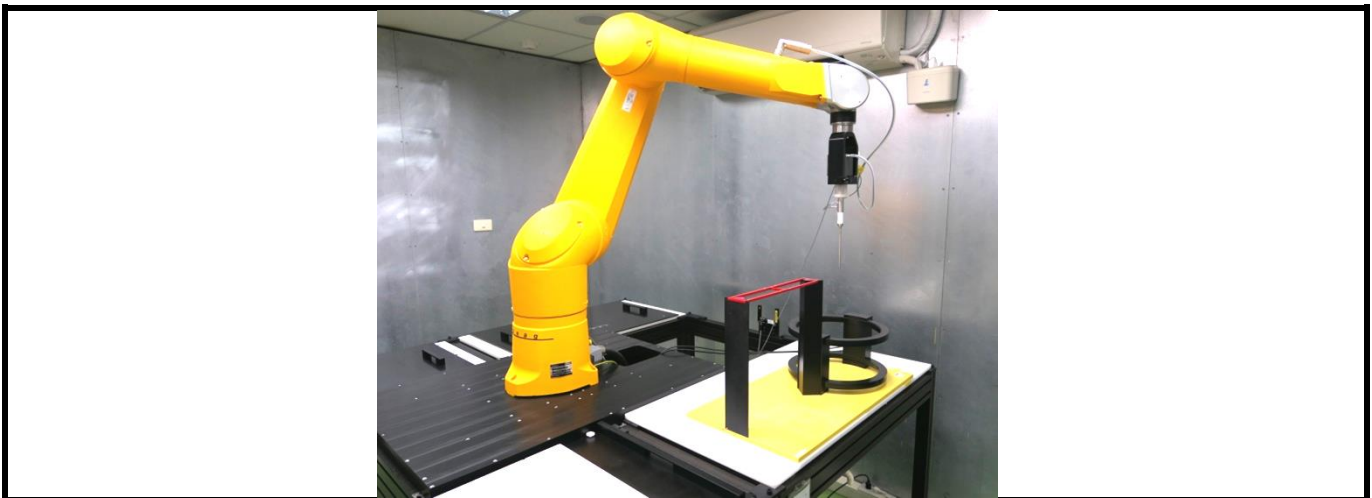



Fig-3.2 DASY6 Measurement System

3.1.2 Probes

Model	ER3DV6	
Construction	One dipole parallel, two dipoles normal to probe axis Built-in shielding against static charges	
Frequency	40 MHz to 3 GHz Linearity: ± 0.2 dB	
Directivity	± 0.2 dB in air (rotation around probe axis) ± 0.4 dB in air (rotation normal to probe axis)	
Dynamic Range	2 V/m to 1000 V/m Linearity: ± 0.2 dB	
Dimensions	Overall length: 337 mm (Tip: 16 mm) Tip diameter: 8 mm (Body: 12 mm) Distance from probe tip to dipole centers: 2.5 mm	

Model	EF3DV3	
Construction	One dipole parallel, two dipoles normal to probe axis Built-in shielding against static charges	
Frequency	40 MHz to 6 GHz Linearity: ± 0.2 dB	
Directivity	± 0.2 dB in air (rotation around probe axis) ± 0.4 dB in air (rotation normal to probe axis)	
Dynamic Range	2 V/m to 1000 V/m Linearity: ± 0.2 dB	
Dimensions	Overall length: 337 mm (Tip: 20 mm) Tip diameter: 3.9 mm (Body: 12 mm) Distance from probe tip to dipole centers: 1.5 mm	

HAC RF-Emission Test Report

3.1.3 Data Acquisition Electronics (DAE)

Model	DAE3, DAE4	
Construction	Signal amplifier, multiplexer, A/D converter and control logic. Serial optical link for communication with DASY embedded system (fully remote controlled). Two step probe touch detector for mechanical surface detection and emergency robot stop.	
Measurement Range	-100 to +300 mV (16 bit resolution and two range settings: 4mV, 400mV)	
Input Offset Voltage	< 5µV (with auto zero)	
Input Bias Current	< 50 fA	
Dimensions	60 x 60 x 68 mm	

3.1.4 Phantoms

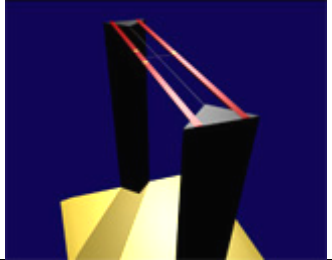
Model	Test Arch	
Construction	Enables easy and well defined positioning of the phone and validation dipoles as well as simple teaching of the robot.	
Dimensions	Length : 370 mm Width : 370 mm Height : 370 mm	

3.1.5 Device Holder

Model	Mounting Device	
Construction	The Mounting Device enables the rotation of the mounted transmitter device in spherical coordinates. Rotation point is the ear opening point. Transmitter devices can be easily and accurately positioned according to ANSI C63.19.	
Material	POM	

3.1.6 RF Emission Calibration Dipoles

Model	CD-Serial	
Construction	Free space antenna Hearing Aid susceptibility measurements according to ANSI C63.19. Validation of Hearing Aid RF setup for wireless device emission measurements according to ANSI C63.19	
Frequency	CD700V3 : 698 ~ 806 MHz CD835V3 : 800 ~ 960 MHz CD1880V3 : 1710 ~ 2000 MHz CD2450V3 : 2250 ~ 2650 MHz CD2600V3 : 2450 ~ 2750 MHz CD3500V3 : 3300 ~ 3950 MHz CD5500V3 : 5000 ~ 5900 MHz	
Return Loss	CD700V3 : > 15 dB (750 MHz > 20 dB) CD835V3 : > 15 dB (835 MHz > 25 dB) CD1880V3 : > 18 dB (1880 MHz > 20 dB) CD2450V3 : > 18 dB (2450 MHz > 25 dB) CD2600V3 : > 18 dB (2600 MHz > 20 dB) CD3500V3 : > 16 dB (3500 MHz > 20 dB) CD5500V3 : > 18 dB (5500 MHz > 20 dB)	
Power Capability	> 40 W continuous	

3.2 DASY6 System Verification

The system check verifies that the system operates within its specifications. It is performed before every E-field measurement. The system check uses normal measurements in the center section of the arch phantom with a matched dipole at a specified distance. The system verification setup is shown as below.

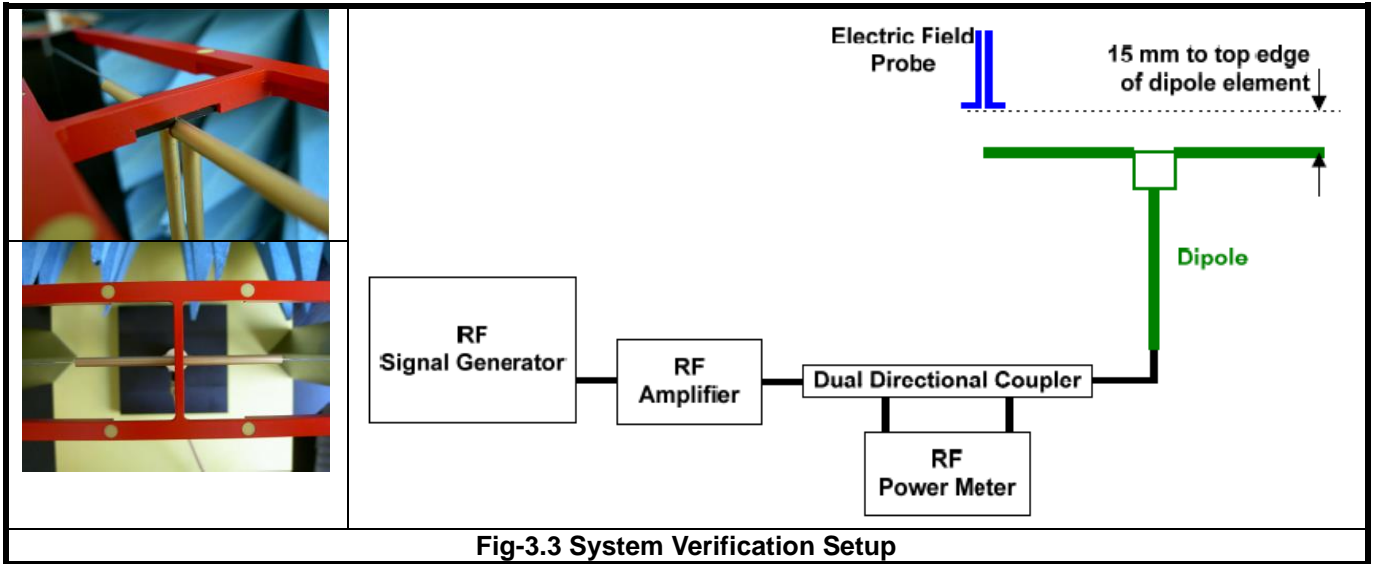

Fig-3.3 System Verification Setup

The validation dipole is placed beneath the center of arch phantom. The power meter measures the forward power at the location of the system check dipole connector. The signal generator is adjusted for the desired forward power, 100 mW (20 dBm) at the dipole connector and the RF power meter is read at that level. After connecting the cable to the dipole, the signal generator is readjusted for the same reading at RF power meter.

After system check testing, the E-field result will be compared with the reference value derived from validation dipole certificate report. The deviation of system check should be within 25 %.

The result of system verification is shown in section 4.3 of this report.

3.3 EUT Measurements Reference and Plane

The EUT is mounted in the device holder. The acoustic output of the EUT will coincide with the center point of the area formed by the dielectric wire and the middle bar of the arch's top frame. Then EUT will be moved vertically upwards until it touches the frame.

Fig-3.4 and Fig-3.5 illustrate the references and reference plane that is used in the RF emissions measurement.

- (a) The grid is 50 mm by 50 mm area that is divided into nine evenly sized blocks or sub-grids.
- (b) The grid is centered on the audio frequency output transducer of the EUT.
- (c) The grid is in a reference plane, which is defined as the planar area that contains the highest point in the area of the phone that normally rests against the user's ear. It is parallel to the centerline of the receiver area of the phone and is defined by the points of the receiver-end of the EUT handset, which in normal handset use rest against the ear.
- (d) The measurement plane is parallel to and 15 mm in front of the reference plane.



Fig-3.4 EUT Reference and Plane

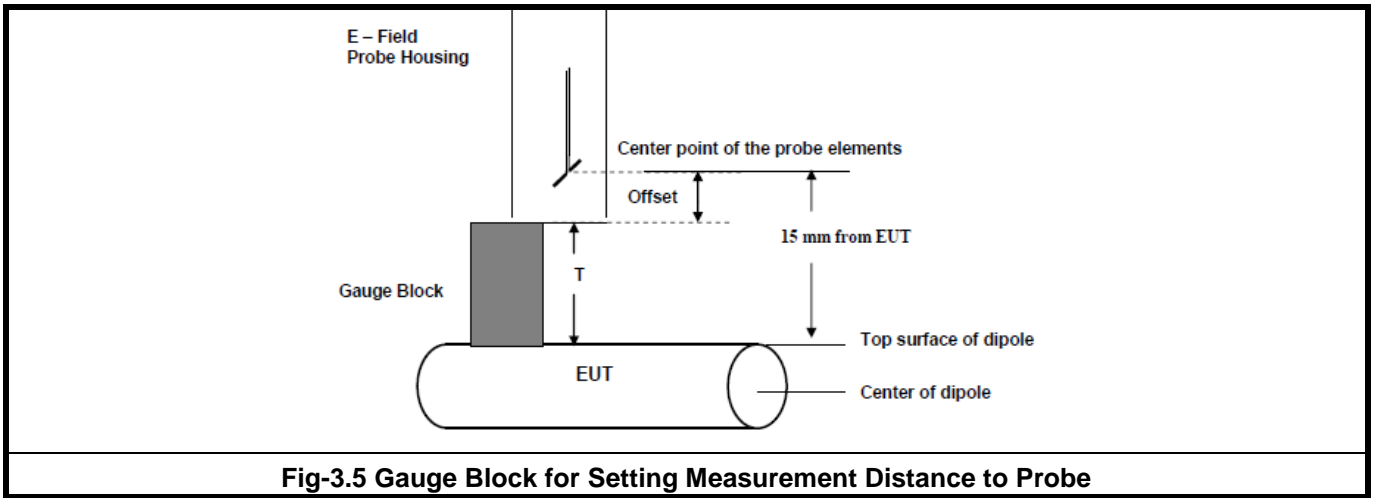

Fig-3.5 Gauge Block for Setting Measurement Distance to Probe

3.4 HAC RF Emission Measurement Procedure

The RF emissions test procedure for wireless communications device is as below.

1. Confirm the proper operation of the field probe, probe measurement system, and other instrumentation and the positioning system.
2. Position the WD in its intended test position.
3. Set the WD to transmit a fixed and repeatable combination of signal power and modulation characteristic that is representative of the worst case (highest interference potential) encountered in normal use. Transiently occurring start-up, changeover, or termination conditions, or other operations likely to occur less than 1% of the time during normal operation, may be excluded from consideration.
4. The center sub-grid shall be centered on the T-Coil mode perpendicular measurement point or the acoustic output, as appropriate. Locate the field probe at the initial test position in the 50 mm by 50 mm grid, which is contained in the measurement plane, illustrated in Fig-3.4. If the field alignment method is used, align the probe for maximum field reception.
5. Record the reading at the output of the measurement system.
6. Scan the entire 50 mm by 50 mm region in equally spaced increments and record the reading at each measurement point. The distance between measurement points shall be sufficient to assure the identification of the maximum reading.
7. Identify the five contiguous sub-grids around the center sub-grid whose maximum reading is the lowest of all available choices. This eliminates the three sub-grids with the maximum readings. Thus, the six areas to be used to determine the WD's highest emissions are identified.
8. Identify the maximum reading within the non-excluded sub-grids identified in step 7.
9. Indirect Measurement Method: The RF audio interference level in dB(V/m) is obtained by adding the MIF (in dB) to the maximum steady-state rms field-strength reading, in dB(V/m), from step 8. Use this result to determine the category rating.

10. Compare this RF audio interference level with the categories in section 4.1 and record the resulting WD category rating.
- 11 For the T-Coil mode M-rating assessment, determine whether the chosen perpendicular measurement point is contained in an included sub-grid of the first can. If so, then a second scan is not necessary. The first scan and resultant category rating may be used for the T-Coil mode M-rating. Otherwise, repeat step 1 through step 9, with the grid shifted so that it is centered on the perpendicular measurement point. Record the WD category rating.

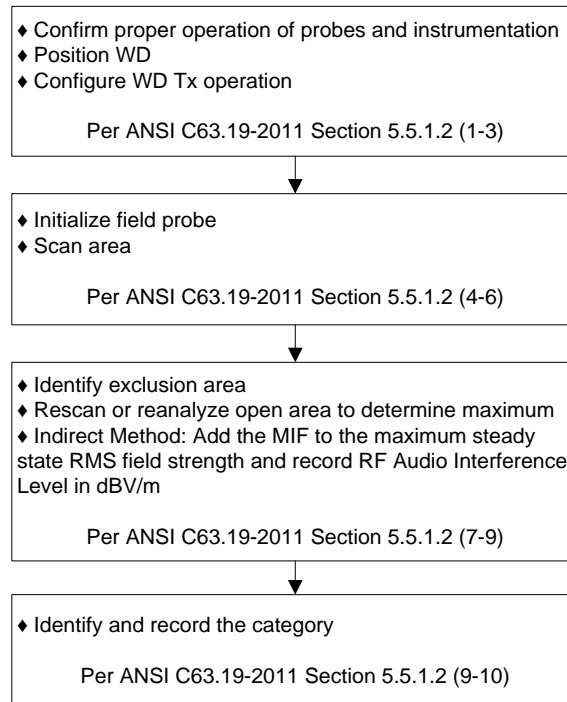

Fig-3.6 WD Near-Field Emission Test Flowchart

3.5 Modulation Interference Factor

The HAC Standard ANSI C63.19-2011 defines a new scaling using the Modulation Interference Factor (MIF) which replaces the need for the Articulation Weighting Factor (AWF) during the evaluation and is applicable to any modulation scheme.

The Modulation Interference Factor (MIF, in dB) is added to the measured average E-field (in dBV/m) and converts it to the RF audio interference potential (in dBV/m). This level considers the audible amplitude modulation components in the RF E-field. CW fields without amplitude modulation are assumed to not interfere with the hearing aid electronics. Modulations without time slots and low fluctuations at low frequencies have low MIF values, TDMA modulations with narrow transmission slots and repetition rates of few 100 Hz have high MIF values and give similar classification as ANSI C63.19-2007.

ER3D E-field probe have a bandwidth <10 kHz and can therefore not evaluate the RF envelope in the full audio band. DASY6 is therefore using the "indirect" measurement method according to ANSI C63.19-2011 which is the primary method. This near field probe read the averaged E-field. Especially for the new high peak-to-average (PAR) signal types, the probes shall be linearized by PMR calibration in order to not overestimate the field reading.

The evaluation method for the MIF is defined in ANSI C63.19-2011 section D.7. An RMS demodulated RF signal is fed to a spectral filter (similar to an A weighting filter) and forwarded to a temporal filter acting as a quasi-peak detector. The averaged output of these filtering is scaled to a 1 kHz 80% AM signal as reference. It may alternatively be determined through analysis and simulation, because it is constant and characteristic for a communication signal. DASY6 uses well-defined signals for PMR calibration. The MIF of these signals has been determined numerically. It allows a precise scaling and is therefore automatically applied.

The following table lists the MIF values evaluated by DASY6 manufacturer (SPEAG), and the test result will be calculated with the MIF parameter automatically. The detailed parameters for E-field probe can be found in the probe calibration report in annex Z.

UID	Reversion	Communication System Name	MIF (dB)
10460	AAA	UMTS-FDD (WCDMA, AMR)	-25.43
10225	CAB	UMTS-FDD (HSPA+)	-20.39
10170	CAE	LTE-FDD (SC-FDMA, 1 RB, 20 MHz, 16-QAM)	-9.76
10061	CAB	IEEE 802.11b WiFi 2.4 GHz (DSSS, 11 Mbps)	-2.02
10077	CAB	IEEE 802.11g WiFi 2.4 GHz (DSSS/OFDM, 54 Mbps)	0.12
10427	AAC	IEEE 802.11n (HT Greenfield, 150 Mbps, 64-QAM)	-13.44
10069	CAD	IEEE 802.11a/h WiFi 5 GHz (OFDM, 54 Mbps)	-3.15
10616	AAC	IEEE 802.11ac WiFi (40MHz, MCS0, 90pc duty cycle)	-5.57

HAC RF-Emission Test Report

The MIF measurement uncertainty listed in following table is estimated by SPEAG.

MIF (dB)	MIF Measurement Uncertainty (dB)
-7 to +5	0.2
-13 to +11	0.5
> -20	1.0

4. HAC Measurement Evaluation

4.1 M-Rating Category

The HAC Standard ANSI C63.19-2011 represents performance requirements for acceptable interoperability of hearing aids with wireless communications devices. When these parameters are met, a hearing aid operates acceptably in close proximity to a wireless communications device.

Emission Categories	E-Field Emissions < 960 MHz (dB V/m)	E-Field Emissions > 960 MHz (dB V/m)
Category M1	50 - 55	40 - 45
Category M2	45 - 50	35 - 40
Category M3	40 - 45	30 - 35
Category M4	< 40	< 30

4.2 EUT Configuration and Setting

For HAC RF emission testing, the EUT was linked and controlled by base station emulator. Communication between the EUT and the emulator was established by air link. The distance between the EUT and the communicating antenna of the emulator is larger than 50 cm and the output power radiated from the emulator antenna is at least 30 dB smaller than the output power of EUT. The EUT was set from the emulator to radiate maximum output power during HAC testing.

4.3 System Verification

Refer to Annex C.

4.4 Maximum Target Conducted Power

Refer to Annex D.

4.5 Low Power Exemption Evaluation

Refer to Annex E.

4.6 Measured Conducted Power Results

Refer to Annex F.

4.7 HAC RF Emission Testing Results

Refer to Annex G.

Test Engineer : Willy Chang

5. Calibration of Test Equipment

Refer to Annex H.

HAC RF-Emission Test Report

6. Measurement Uncertainty

Error Description	Uncertainty Value (±%)	Probability Distribution	Divisor	Ci (E)	Standard Uncertainty (E)
Measurement System					
Probe Calibration	5.05	Normal	1	1	± 5.1 %
Axial Isotropy	4.7	Rectangular	√3	1	± 2.7 %
Sensor Displacement	16.5	Rectangular	√3	1	± 9.5 %
Boundary Effects	2.4	Rectangular	√3	1	± 1.4 %
Phantom Boundary Effect	7.2	Rectangular	√3	1	± 4.2 %
Linearity	4.7	Rectangular	√3	1	± 2.7 %
Scaling with PMR Calibration	10.0	Rectangular	√3	1	± 5.8 %
System Detection Limit	0.25	Rectangular	√3	1	± 0.1 %
Readout Electronics	0.3	Normal	1	1	± 0.3 %
Response Time	0.0	Rectangular	√3	1	± 0.0 %
Integration Time	2.6	Rectangular	√3	1	± 1.5 %
RF Ambient Conditions	3.0	Rectangular	√3	1	± 1.7 %
RF Reflections	12.0	Rectangular	√3	1	± 6.9 %
Probe Positioner	1.2	Rectangular	√3	1	± 0.7 %
Probe Positioning	4.7	Rectangular	√3	1	± 2.7 %
Extrap. and Interpolation	2.0	Rectangular	√3	1	± 1.2 %
Test Sample Related					
Device Positioning Vertical	4.7	Rectangular	√3	1	± 2.7 %
Device Positioning Lateral	1.0	Rectangular	√3	1	± 0.6 %
Device Holder and Phantom	2.4	Rectangular	√3	1	± 1.4 %
Power Drift	5.0	Rectangular	√3	1	± 2.9 %
Phantom and Setup Related					
Phantom Thickness	2.4	Rectangular	√3	1	± 1.4 %
Combined Standard Uncertainty					± 16.3 %
Coverage Factor for 95 %					K = 2
Expanded Uncertainty					± 32.6 %

Uncertainty budget for HAC RF Emission

7. Information of the Testing Laboratories

We, Bureau Veritas Consumer Products Services (H.K.) Ltd., Taoyuan Branch, were founded in 1988 to provide our best service in EMC, Radio, Telecom and Safety consultation. Our laboratories are accredited and approved according to ISO/IEC 17025.

If you have any comments, please feel free to contact us at the following:

Taiwan Huaya Lab:

Add: No. 19, Huaya 2nd Rd., Guishan Dist., Taoyuan City 333, Taiwan

Tel: +886-(0)3-318-3232

Fax: +886-(0)3-211-5834

Taiwan Linkou Lab:

Add: No. 47-2, Baodoucuokeng, Linkou Dist., New Taipei City 244, Taiwan

Tel: +886-(0)2-2605-2180

Fax: +886-(0)2-2605-2943

Taiwan Hsinchu Lab1:

Add: E-2, No. 1, Lixing 1st Rd., East Dist., Hsinchu City 300, Taiwan

Tel: +886-(0)3-666-8565

Fax: +886-(0)3-666-8323

Taiwan Hsinchu Lab2:

Add: No. 49, Ln. 206, Wende Rd., Qionglin Township, Hsinchu County 307, Taiwan

Tel: +886-(0)3-512-0595

Fax: +886-(0)3-512-0568

Taiwan Xindian Lab:

Add: B2F., No. 215, Sec. 3, Beixin Rd., Xindian Dist., New Taipei City 231, Taiwan

Tel: +886-(0)2-8914-5882

Fax: +886-(0)2-8914-5840

Email: service.adt@tw.bureauveritas.com

Web Site: <https://ee.bureauveritas.com.tw/BVInternet/Default>

The road map of all our labs can be found in our web site also.

---END---