

FCC Test Report

Report No.: RF191211C18-2

FCC ID: V65E4810

Test Model: E4810

Series Model: E4810NC

Received Date: Dec. 11, 2019

Test Date: Dec. 28, 2019 ~ Jan. 05, 2020

Issued Date: Jan. 15, 2020

Applicant: Kyocera Corporation % Kyocera International, Inc.

Address: 8611 Balboa Avenue, San Diego, CA 92123

Issued By: Bureau Veritas Consumer Products Services (H.K.) Ltd., Taoyuan Branch
Lin Kou Laboratories

Lab Address: No. 47-2, 14th Ling, Chia Pau Vil., Lin Kou Dist., New Taipei City, Taiwan

Test Location (1): No.19, Hwa Ya 2nd Rd., Wen Hwa Vil., Kwei Shan Dist., Taoyuan City
33383, Taiwan

Test Location (2): B2F., No.215, Sec. 3, Beixin Rd., Xindian Dist., New Taipei City 231, Taiwan

FCC Registration / 788550 / TW0003

Designation Number: 427177 / TW0011



This report is for your exclusive use. Any copying or replication of this report to or for any other person or entity, or use of our name or trademark, is permitted only with our prior written permission. This report sets forth our findings solely with respect to the test samples identified herein. The results set forth in this report are not indicative or representative of the quality or characteristics of the lot from which a test sample was taken or any similar or identical product unless specifically and expressly noted. Our report includes all of the tests requested by you and the results thereof based upon the information that you provided to us. You have 60 days from date of issuance of this report to notify us of any material error or omission caused by our negligence, provided, however, that such notice shall be in writing and shall specifically address the issue you wish to raise. A failure to raise such issue within the prescribed time shall constitute your unqualified acceptance of the completeness of this report, the tests conducted and the correctness of the report contents. Unless specific mention, the uncertainty of measurement has been explicitly taken into account to declare the compliance or non-compliance to the specification. The report must not be used by the client to claim product certification, approval, or endorsement by TAF or any government agencies.

Table of Contents

Release Control Record	4
1 Certificate of Conformity	5
2 Summary of Test Results.....	6
2.1 Measurement Uncertainty.....	6
2.2 Modification Record	6
3 General Information	7
3.1 General Description of EUT	7
3.2 Description of Test Modes.....	9
3.2.1 Test Mode Applicability and Tested Channel Detail.....	11
3.3 Duty Cycle of Test Signal	13
3.4 Description of Support Units	14
3.4.1 Configuration of System under Test	14
3.5 General Description of Applied Standards and References	14
4 Test Types and Results	15
4.1 Radiated Emission and Bandedge Measurement	15
4.1.1 Limits of Radiated Emission and Bandedge Measurement	15
4.1.2 Limits of Unwanted Emission Out of the Restricted Bands	16
4.1.3 Test Instruments	17
4.1.4 Test Procedures.....	18
4.1.5 Deviation from Test Standard	18
4.1.6 Test Setup.....	19
4.1.7 EUT Operating Conditions.....	20
4.1.8 Test Results	21
4.2 Conducted Emission Measurement.....	56
4.2.1 Limits of Conducted Emission Measurement	56
4.2.2 Test Instruments	56
4.2.3 Test Procedures.....	57
4.2.4 Deviation from Test Standard	57
4.2.5 Test Setup.....	57
4.2.6 EUT Operating Conditions.....	57
4.2.7 Test Results	58
4.3 Transmit Power Measurement.....	60
4.3.1 Limits of Transmit Power Measurement	60
4.3.2 Test Setup.....	60
4.3.3 Test Instruments	61
4.3.4 Test Procedure	61
4.3.5 Deviation from Test Standard	61
4.3.6 EUT Operating Conditions.....	61
4.3.7 Test Results	62
4.4 Occupied Bandwidth Measurement.....	67
4.4.1 Test Setup.....	67
4.4.2 Test Instruments	67
4.4.3 Test Procedure	67
4.4.4 Test Results	68
4.5 Peak Power Spectral Density Measurement	71
4.5.1 Limits of Peak Power Spectral Density Measurement	71
4.5.2 Test Setup.....	71
4.5.3 Test Instruments	71
4.5.4 Test Procedures.....	71
4.5.5 Deviation from Test Standard	72
4.5.6 EUT Operating Conditions.....	72
4.5.7 Test Results	73
4.6 Frequency Stability	77

4.6.1	Limit of Frequency Stability Measurement	77
4.6.2	Test Setup	77
4.6.3	Test Instruments	77
4.6.4	Test Procedure	77
4.6.5	Deviation from Test Standard	77
4.6.6	EUT Operating Condition	77
4.6.7	Test Results	78
4.7	6 dB Bandwidth Measurement.....	79
4.7.1	Limits of 6 dB Bandwidth Measurement.....	79
4.7.2	Test Setup.....	79
4.7.3	Test Instruments	79
4.7.4	Test Procedure	79
4.7.5	Deviation from Test Standard	79
4.7.6	EUT Operating Condition	79
4.7.7	Test Results	80
5	Pictures of Test Arrangements.....	82
	Annex A- Radiated Out of Band Emission (OOBE) Measurement (For U-NII-3 band)	83
	Appendix – Information of the Testing Laboratories	86

Release Control Record

Issue No.	Description	Date Issued
RF191211C18-2	Original Release	Jan. 15, 2020

1 Certificate of Conformity

Product: Feature Phone

Brand: Kyocera

Test Model: E4810

Series Model: E4810NC

Sample Status: Identical Prototype

Applicant: Kyocera Corporation % Kyocera International, Inc.

Test Date: Dec. 28, 2019 ~ Jan. 05, 2020

Standards: 47 CFR FCC Part 15, Subpart E (Section 15.407)
ANSI C63.10:2013

The above equipment has been tested by **Bureau Veritas Consumer Products Services (H.K.) Ltd., Taoyuan Branch**, and found compliance with the requirement of the above standards. The test record, data evaluation & Equipment Under Test (EUT) configurations represented herein are true and accurate accounts of the measurements of the sample's RF characteristics under the conditions specified in this report.

Prepared by : , **Date:** Jan. 15, 2020
Rona Chen / Specialist

Approved by : , **Date:** Jan. 15, 2020
Dylan Chiou / Senior Project Engineer

2 Summary of Test Results

47 CFR FCC Part 15, Subpart E (Section 15.407)			
FCC Clause	Test Item	Result	Remarks
15.407(b)(6)	AC Power Conducted Emissions	Pass	Meet the requirement of limit. Minimum passing margin is -8.32 dB at 5.53593 MHz.
15.407(b) (1/2/3/4(i/ii)/6)	Radiated Emissions & Band Edge Measurement	Pass	Meet the requirement of limit. Minimum passing margin is -1.06 dB at 5469.52 MHz.
15.407(a)(1/2/3)	Max Average Transmit Power	Pass	Meet the requirement of limit.
---	Occupied Bandwidth Measurement	-	Reference only
15.407(a)(1/2/3)	Peak Power Spectral Density	Pass	Meet the requirement of limit.
15.407(e)	6 dB Bandwidth	Pass	Meet the requirement of limit. (U-NII-3 Band only)
15.407(g)	Frequency Stability	Pass	Meet the requirement of limit.
15.203	Antenna Requirement	Pass	No antenna connector is used.

Note:

- For U-NII-3 band compliance with rule part 15.407(b)(4)(i), the OOB test plots were recorded in Annex A.
- Determining compliance based on the results of the compliance measurement, not taking into account measurement instrumentation uncertainty.

2.1 Measurement Uncertainty

Where relevant, the following measurement uncertainty levels have been estimated for tests performed on the EUT as specified in CISPR 16-4-2:

Measurement	Frequency	Expanded Uncertainty (k=2) (±)
Conducted Emissions at mains ports	150 kHz ~ 30 MHz	2.79 dB
Radiated Emissions up to 1 GHz	9 kHz ~ 30 MHz	3.04 dB
	30 MHz ~ 200 MHz	2.0153 dB
	200 MHz ~ 1000 MHz	2.0224 dB
Radiated Emissions above 1 GHz	1 GHz ~ 18 GHz	1.0121 dB
	18 GHz ~ 40 GHz	1.1508 dB

2.2 Modification Record

There were no modifications required for compliance.

3 General Information

3.1 General Description of EUT

Product	Feature Phone
Brand	Kyocera
Test Model	E4810
Series Model	E4810NC
Status of EUT	Identical Prototype
Power Supply Rating	5.0 Vdc (Adapter or Host equipment) 3.8 Vdc (Li-ion battery)
Modulation Type	64QAM, 16QAM, QPSK, BPSK
Modulation Technology	OFDM
Transfer Rate	802.11a: 54.0/ 48.0/ 36.0/ 24.0/ 18.0/ 12.0/ 9.0/ 6.0 Mbps 802.11n: up to 150.0 Mbps
Operating Frequency	5180 ~ 5240 MHz, 5260 ~ 5320 MHz, 5500 ~ 5700 MHz, 5745 ~ 5825 MHz
Number of Channel	5180 ~ 5240 MHz: 4 for 802.11a, 802.11n (HT20) 2 for 802.11n (HT40) 5260 ~ 5320 MHz: 4 for 802.11a, 802.11n (HT20) 2 for 802.11n (HT40) 5500 ~ 5700 MHz: 11 for 802.11a, 802.11n (HT20) 5 for 802.11n (HT40) 5745 ~ 5825 MHz: 5 for 802.11a, 802.11n (HT20) 2 for 802.11n (HT40)
Output Power	36.475 mW for 5180 ~ 5240 MHz 36.475 mW for 5260 ~ 5320 MHz 36.475 mW for 5500 ~ 5700 MHz 36.728 mW for 5745 ~ 5825 MHz
Antenna Type	Fixed internal antenna with 3.34 dBi gain
Antenna Connector	N/A
Accessory Device	Refer to Note as below
Data Cable Supplied	Refer to Note as below

Note:

- The EUT provides 1 completed transmitter and 1 receiver.

Modulation Mode	Tx Function
802.11a	1TX
802.11n (HT20)	1TX
802.11n (HT40)	1TX

- All models are listed as below. (Test Model: E4810)

Brand	Model	Difference
Kyocera	E4810	With camera function
	E4810NC	Without camera function

3. The EUT contains following accessory devices.

Product	Brand	Model	Description
Adapter	Kyocera	SCP-47ADT	I/P: 100-240 Vac, 50/60 Hz, 0.2 A O/P: 5.0 Vdc, 1.0 A
Battery	Kyocera	SCP-73LBPS	3.8 Vdc, 1770 mAh, 6.8 Wh
USB Cable	KYOCERA	SCP-24SDC	1.0 m shielded cable w/o core

4. The above EUT information is declared by manufacturer and for more detailed features description, please refers to the manufacturer's specifications or user's manual.

3.2 Description of Test Modes

For 5180 ~ 5240 MHz

4 channels are provided for 802.11a, 802.11n (HT20):

Channel	Frequency (MHz)	Channel	Frequency (MHz)
36	5180	44	5220
40	5200	48	5240

2 channels are provided for 802.11n (HT40):

Channel	Frequency (MHz)	Channel	Frequency (MHz)
38	5190	46	5230

For 5260 ~ 5320 MHz

4 channels are provided for 802.11a, 802.11n (HT20):

Channel	Frequency (MHz)	Channel	Frequency (MHz)
52	5260	60	5300
56	5280	64	5320

2 channels are provided for 802.11n (HT40):

Channel	Frequency (MHz)	Channel	Frequency (MHz)
54	5270	62	5310

For 5500 ~ 5700 MHz

11 channels are provided for 802.11a, 802.11n (HT20):

Channel	Frequency (MHz)	Channel	Frequency (MHz)
100	5500	124	5620
104	5520	128	5640
108	5540	132	5660
112	5560	136	5680
116	5580	140	5700
120	5600		

5 channels are provided for 802.11n (HT40):

Channel	Frequency (MHz)	Channel	Frequency (MHz)
102	5510	126	5630
110	5550	134	5670
118	5590		

For 5745 ~ 5825 MHz:

5 channels are provided for 802.11a, 802.11n (HT20):

Channel	Frequency (MHz)	Channel	Frequency (MHz)
149	5745	161	5805
153	5765	165	5825
157	5785		

2 channels are provided for 802.11n (HT40):

Channel	Frequency (MHz)	Channel	Frequency (MHz)
151	5755	159	5795

3.2.1 Test Mode Applicability and Tested Channel Detail

EUT Configure Mode	Applicable To				Description
	RE \geq 1G	RE $<$ 1G	PLC	APCM	
-	√	√	√	√	-

Where **RE \geq 1G**: Radiated Emission above 1 GHz **RE $<$ 1G**: Radiated Emission below 1 GHz
PLC: Power Line Conducted Emission **APCM**: Antenna Port Conducted Measurement

Note: The EUT had been pre-tested on the positioned of each 3 axis. The worst case was found when positioned on **X-plane** for **U-NII-1 & U-NII-2A**, and **Z-plane** for **U-NII-2C & U-NII-3**.

Radiated Emission Test (Above 1 GHz):

- Pre-Scan has been conducted to determine the worst-case mode from all possible combinations between available modulations, data rates and antenna ports (if EUT with antenna diversity architecture).
- Following channel(s) was (were) selected for the final test as listed below.

EUT Configure Mode	Frequency Band (MHz)	Mode	Available Channel	Tested Channel	Modulation Technology	Modulation Type	Data Rate (Mbps)	
-	5180-5240	802.11a	36 to 48	36, 40, 48	OFDM	BPSK	6.0	
-		802.11n (HT20)	36 to 48	36, 40, 48	OFDM	BPSK	6.5	
-		802.11n (HT40)	38 to 46	38, 46	38, 46	OFDM	BPSK	13.5
-	5260-5320	802.11a	52 to 64	52, 60, 64	OFDM	BPSK	6.0	
-		802.11n (HT20)	52 to 64	52, 60, 64	OFDM	BPSK	6.5	
-		802.11n (HT40)	54 to 62	54, 62	54, 62	OFDM	BPSK	13.5
-	5500-5700	802.11a	100 to 140	100, 116, 140	OFDM	BPSK	6.0	
-		802.11n (HT20)	100 to 140	100, 116, 140	OFDM	BPSK	6.5	
-		802.11n (HT40)	102 to 134	102, 110, 134	102, 110, 134	OFDM	BPSK	13.5
-	5745-5825	802.11a	149 to 165	149, 157, 165	OFDM	BPSK	6.0	
-		802.11n (HT20)	149 to 165	149, 157, 165	149, 157, 165	OFDM	BPSK	6.5
-		802.11n (HT40)	151 to 159	151, 159	151, 159	OFDM	BPSK	13.5

Radiated Emission Test (Below 1 GHz):

- Pre-Scan has been conducted to determine the worst-case mode from all possible combinations between available modulations, data rates and antenna ports (if EUT with antenna diversity architecture).
- Following channel(s) was (were) selected for the final test as listed below.

EUT Configure Mode	Frequency Band (MHz)	Mode	Available Channel	Tested Channel	Modulation Technology	Modulation Type	Data Rate (Mbps)
-	5500-5700	802.11n (HT40)	102 to 134	102	OFDM	BPSK	13.5

Power Line Conducted Emission Test:

- Pre-Scan has been conducted to determine the worst-case mode from all possible combinations between available modulations, data rates and antenna ports (if EUT with antenna diversity architecture).
- Following channel(s) was (were) selected for the final test as listed below.

EUT Configure Mode	Frequency Band (MHz)	Mode	Available Channel	Tested Channel	Modulation Technology	Modulation Type	Data Rate (Mbps)
-	5500-5700	802.11n (HT40)	102 to 134	102	OFDM	BPSK	13.5

Antenna Port Conducted Measurement:

- This item includes all test value of each mode, but only includes spectrum plot of worst value of each mode.
- Pre-Scan has been conducted to determine the worst-case mode from all possible combinations between available modulations, data rates and antenna ports (if EUT with antenna diversity architecture).
- Following channel(s) was (were) selected for the final test as listed below.

EUT Configure Mode	Frequency Band (MHz)	Mode	Available Channel	Tested Channel	Modulation Technology	Modulation Type	Data Rate (Mbps)
-	5180-5240	802.11a	36 to 48	36, 40, 48	OFDM	BPSK	6.0
-		802.11n (HT20)	36 to 48	36, 40, 48	OFDM	BPSK	6.5
-		802.11n (HT40)	38 to 46	38, 46	OFDM	BPSK	13.5
-	5260-5320	802.11a	52 to 64	52, 60, 64	OFDM	BPSK	6.0
-		802.11n (HT20)	52 to 64	52, 60, 64	OFDM	BPSK	6.5
-		802.11n (HT40)	54 to 62	54, 62	OFDM	BPSK	13.5
-	5500-5700	802.11a	100 to 140	100, 116, 140	OFDM	BPSK	6.0
-		802.11n (HT20)	100 to 140	100, 116, 140	OFDM	BPSK	6.5
-		802.11n (HT40)	102 to 134	102, 110, 134	OFDM	BPSK	13.5
-	5745-5825	802.11a	149 to 165	149, 157, 165	OFDM	BPSK	6.0
-		802.11n (HT20)	149 to 165	149, 157, 165	OFDM	BPSK	6.5
-		802.11n (HT40)	151 to 159	151, 159	OFDM	BPSK	13.5

Test Condition:

Applicable To	Environmental Conditions	Input Power	Tested by
RE \geq 1G	25 deg. C, 65 % RH	120 Vac, 60 Hz	Chales Hsiao
RE<1G	25 deg. C, 65 % RH	120 Vac, 60 Hz	Chales Hsiao
PLC	25 deg. C, 65 % RH	120 Vac, 60 Hz	Jisyong Wang
APCM	25 deg. C, 65 % RH	3.8 Vdc	Gavin Wu

3.3 Duty Cycle of Test Signal

MODULATION TYPE: BPSK

802.11a: Duty cycle = $1.362/1.480 = 0.920$, Duty factor = $10 * \log(1/0.920) = 0.36$

802.11n (HT20): Duty cycle = $1.274/1.374 = 0.927$, Duty factor = $10 * \log(1/0.927) = 0.33$

802.11n (HT40): Duty cycle = $0.634/0.751 = 0.844$, Duty factor = $10 * \log(1/0.844) = 0.74$

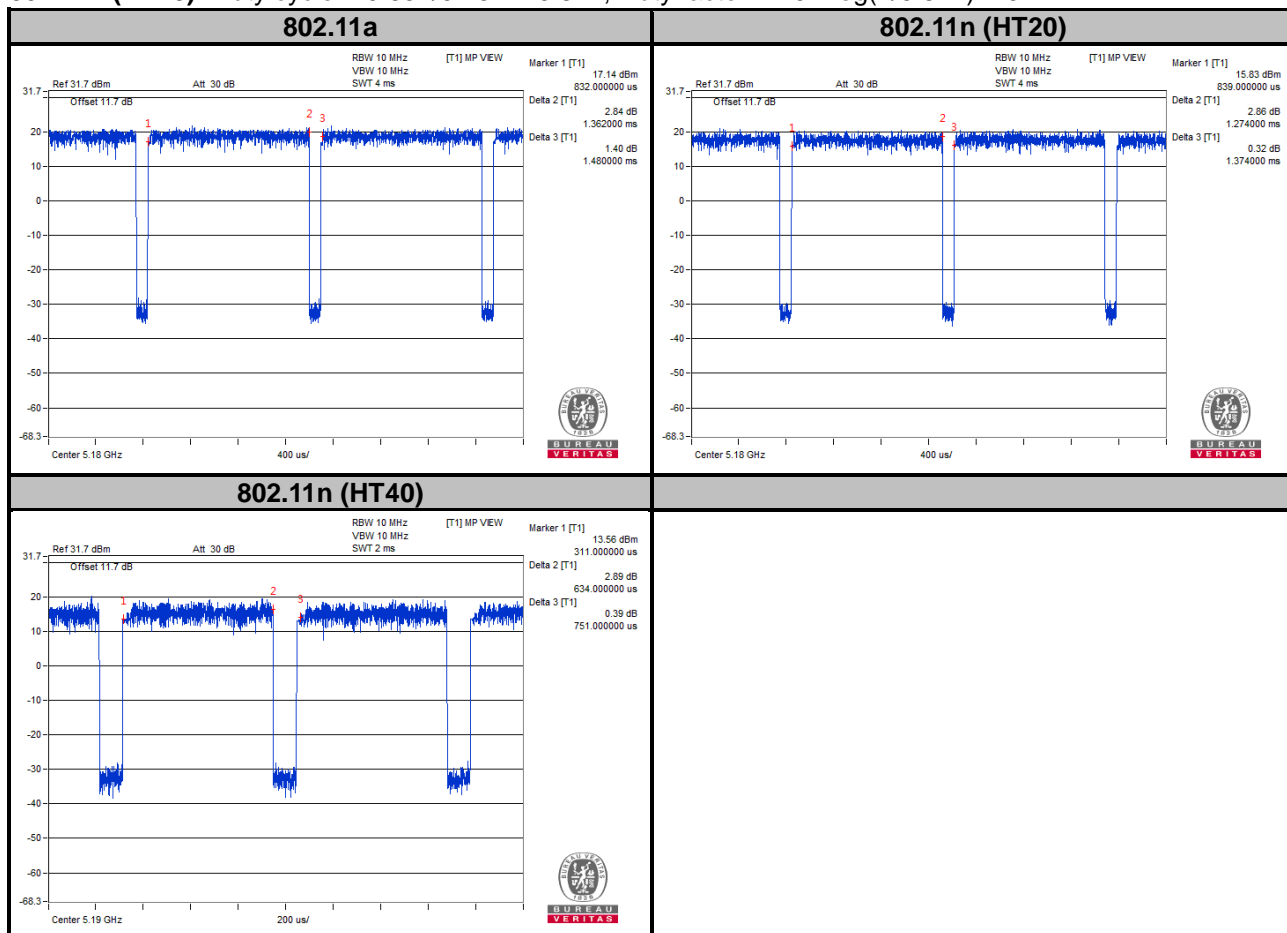

3.4 Description of Support Units

The EUT has been tested as an independent unit together with other necessary accessories or support units.

3.4.1 Configuration of System under Test

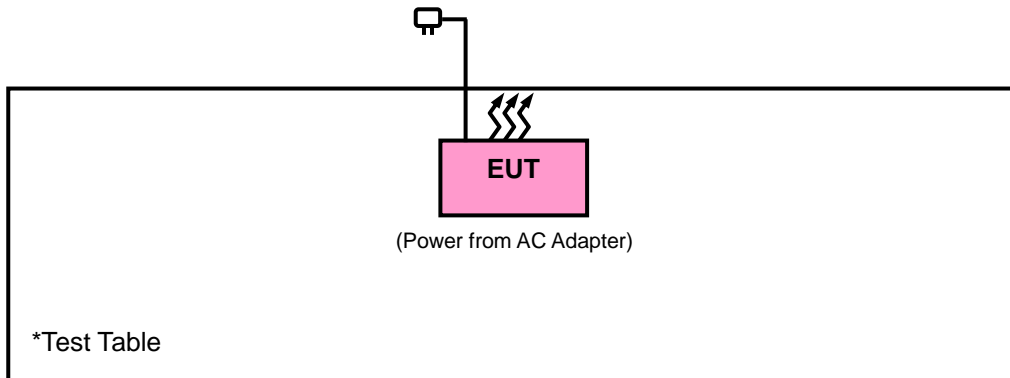

3.5 General Description of Applied Standards and References

The EUT is a RF Product. According to the specifications of the manufacturer, it must comply with the requirements of the following standards and references:

Test Standard:

FCC Part 15, Subpart E (15.407)

ANSI C63.10-2013

All test items have been performed and recorded as per the above standards.

References Test Guidance:

KDB 789033 D02 General UNII Test Procedures New Rules v02r01

All test items have been performed as a reference to the above KDB test guidance.

4 Test Types and Results

4.1 Radiated Emission and Bandedge Measurement

4.1.1 Limits of Radiated Emission and Bandedge Measurement

Radiated emissions which fall in the restricted bands must comply with the radiated emission limits specified as below table.

Frequencies (MHz)	Field Strength (microvolts/meter)	Measurement Distance (meters)
0.009 ~ 0.490	2400/F (kHz)	300
0.490 ~ 1.705	24000/F (kHz)	30
1.705 ~ 30.0	30	30
30 ~ 88	100	3
88 ~ 216	150	3
216 ~ 960	200	3
Above 960	500	3

Note:

1. The lower limit shall apply at the transition frequencies.
2. Emission level (dBuV/m) = 20 log Emission level (uV/m).
3. For frequencies above 1000 MHz, the field strength limits are based on average detector, however, the peak field strength of any emission shall not exceed the maximum permitted average limits, specified above by more than 20 dB under any condition of modulation.

4.1.2 Limits of Unwanted Emission Out of the Restricted Bands

Applicable To		Limit	
789033 D02 General UNII Test Procedures New Rules v02r01		Field Strength at 3 m	
		PK: 74 (dBµV/m)	AV: 54 (dBµV/m)
Frequency Band	Applicable To	EIRP Limit	Equivalent Field Strength at 3 m
5150~5250 MHz	15.407(b)(1)	PK: -27 (dBm/MHz)	PK: 68.2 (dBµV/m)
5250~5350 MHz	15.407(b)(2)		
5470~5725 MHz	15.407(b)(3)		
5725~5850 MHz	<input checked="" type="checkbox"/> 15.407(b)(4)(i)	PK:-27 (dBm/MHz) ^{*1} PK:10 (dBm/MHz) ^{*2} PK:15.6 (dBm/MHz) ^{*3} PK:27 (dBm/MHz) ^{*4}	PK: 68.2 (dBµV/m) ^{*1} PK:105.2 (dBµV/m) ^{*2} PK: 110.8 (dBµV/m) ^{*3} PK:122.2 (dBµV/m) ^{*4}
	<input type="checkbox"/> 15.407(b)(4)(ii)	Emission limits in section 15.247(d)	

^{*1} beyond 75 MHz or more above of the band edge.
^{*2} below the band edge increasing linearly to 10 dBm/MHz at 25 MHz above.
^{*3} below the band edge increasing linearly to a level of 15.6 dBm/MHz at 5 MHz above.
^{*4} from 5 MHz above or below the band edge increasing linearly to a level of 27 dBm/MHz at the band edge.

Note:

The following formula is used to convert the equipment isotropic radiated power (eirp) to field strength:

$$E = \frac{1000000\sqrt{30P}}{3} \mu\text{V/m, where } P \text{ is the eirp (Watts).}$$

4.1.3 Test Instruments

Description & Manufacturer	Model No.	Serial No.	Date of Calibration	Due Date of Calibration
Test Receiver Agilent Technologies	N9038A	MY52260177	Aug. 26, 2019	Aug. 25, 2020
Spectrum Analyzer ROHDE & SCHWARZ	FSU43	101261	Apr. 15, 2019	Apr. 14, 2020
HORN Antenna ETS-Lindgren	3117	00143293	Nov. 24, 2019	Nov. 23, 2020
BILOG Antenna SCHWARZBECK	VULB 9168	9168-616	Nov. 12, 2019	Nov. 11, 2020
HORN Antenna SCHWARZBECK	BBHA 9170	9170-480	Nov. 24, 2019	Nov. 23, 2020
Fixed Attenuator Mini-Circuits	MDCS18N-10	MDCS18N-10-01	Apr. 15, 2019	Apr. 14, 2020
Loop Antenna	EM-6879	269	Sep. 16, 2019	Sep. 15, 2020
MXG Vector signal generator Agilent	N5182B	MY53050430	Nov. 25, 2019	Nov. 24, 2020
Preamplifier Agilent	310N	187226	Jun. 18, 2019	Jun. 17, 2020
Preamplifier Agilent	83017A	MY39501357	Jun. 18, 2019	Jun. 17, 2020
Preamplifier EMCI	EMC 184045	980116	Oct. 08, 2019	Oct. 07, 2020
Power Meter Anritsu	ML2495A	1012010	Sep. 04, 2019	Sep. 03, 2020
Power Sensor Anritsu	MA2411B	1315050	Sep. 04, 2019	Sep. 03, 2020
RF signal cable ETS-LINDGREN	5D-FB	Cable-CH1-01(RFC -SMS-100-SMS-12 0+RFC-SMS-100-S MS-400)	Jun. 18, 2019	Jun. 17, 2020
RF signal cable ETS-LINDGREN	8D-FB	Cable-CH1-02(RFC -SMS-100-SMS-24)	Jun. 18, 2019	Jun. 17, 2020
Boresight Antenna Fixture	FBA-01	FBA-SIP01	NA	NA
Software BV ADT	E3 8.130425b	NA	NA	NA
Antenna Tower MF	NA	NA	NA	NA
Turn Table MF	NA	NA	NA	NA
Antenna Tower & Turn Table Controller MF	MF-7802	NA	NA	NA
Temperature & Humidity Chamber	GTH-120-40-CP-A R	MAA1306-019	Sep. 06, 2019	Sep. 05, 2020
DC Power Supply Topward	33010D	807748	NA	NA
Digital Multimeter Fluke	87-III	70360742	Sep. 27, 2019	Sep. 26, 2020

- Note: 1. The calibration interval of the above test instruments is 12 months and the calibrations are traceable to NML/ROC and NIST/USA.
2. The test was performed in HsinTien Chamber 1.

4.1.4 Test Procedures

For Radiated Emission below 30 MHz

- a. The EUT was placed on the top of a rotating table 0.8 meters above the ground at a 3 meter chamber room. The table was rotated 360 degrees to determine the position of the highest radiation.
- b. The EUT was set 3 meters away from the interference-receiving antenna, which was mounted on the top of a variable-height antenna tower.
- c. Parallel, perpendicular, and ground-parallel orientations of the antenna are set to make the measurement.
- d. For each suspected emission, the EUT was arranged to its worst case and the rotatable table was turned from 0 degrees to 360 degrees to find the maximum reading.
- e. The test-receiver system was set to Quasi-Peak Detect Function and Specified Bandwidth with Maximum Hold Mode.

Note:

1. The resolution bandwidth and video bandwidth of test receiver/spectrum analyzer is 9 kHz at frequency below 30 MHz.

For Radiated Emission above 30 MHz

- a. The EUT was placed on the top of a rotating table 0.8 meters (for 30 MHz ~ 1 GHz) / 1.5 meters (for above 1 GHz) above the ground at 3 meter chamber room for test. The table was rotated 360 degrees to determine the position of the highest radiation.
- b. The EUT was set 3 meters away from the interference-receiving antenna, which was mounted on the top of a variable-height antenna tower.
- c. The height of antenna is varied from one meter to four meters above the ground to determine the maximum value of the field strength. Both horizontal and vertical polarizations of the antenna are set to make the measurement.
- d. For each suspected emission, the EUT was arranged to its worst case and then the antenna was tuned to heights from 1 meter to 4 meters and the rotatable table was turned from 0 degrees to 360 degrees to find the maximum reading.
- e. The test-receiver system was set to quasi-peak detect function and specified bandwidth with maximum hold mode when the test frequency is below 1 GHz.
- f. The test-receiver system was set to peak and average detected function and specified bandwidth with maximum hold mode when the test frequency is above 1 GHz. If the peak reading value also meets average limit, measurement with the average detector is unnecessary.

Note:

1. The resolution bandwidth and video bandwidth of test receiver/spectrum analyzer is 120 kHz for Quasi-peak detection (QP) or Peak detection (PK) at frequency below 1 GHz.
2. The resolution bandwidth of test receiver/spectrum analyzer is 1 MHz and the video bandwidth is 3 MHz for Peak detection (PK) at frequency above 1 GHz.
3. The resolution bandwidth of test receiver/spectrum analyzer is 1 MHz and the video bandwidth is $\geq 1/T$ (Duty cycle < 98 %) or 10 Hz (Duty cycle ≥ 98 %) for Average detection (AV) at frequency above 1 GHz.
(11a: RBW = 1 MHz, VBW = 1 kHz ; 11n (HT20): RBW = 1 MHz, VBW = 1 kHz ;
11n (HT40): RBW = 1 MHz, VBW = 3 kHz)
4. All modes of operation were investigated and the worst-case emissions are reported.

4.1.5 Deviation from Test Standard

No deviation.

4.1.6 Test Setup

<Radiated Emission below 30 MHz>

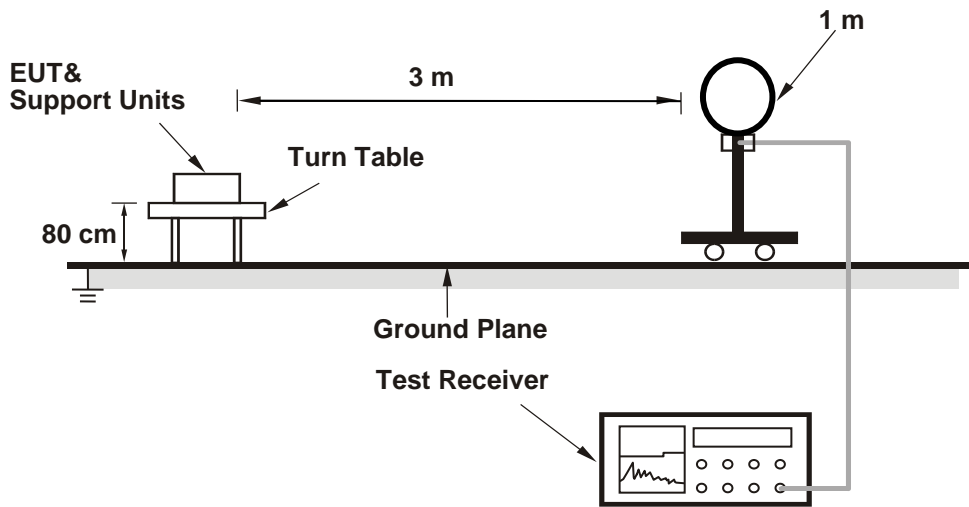

<Radiated Emission 30 MHz to 1 GHz>

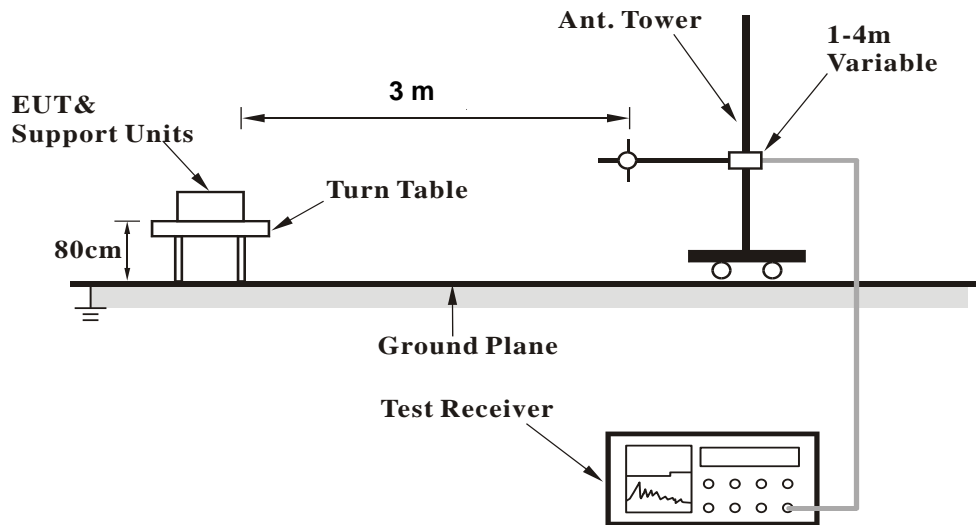

<Radiated Emission above 1 GHz>

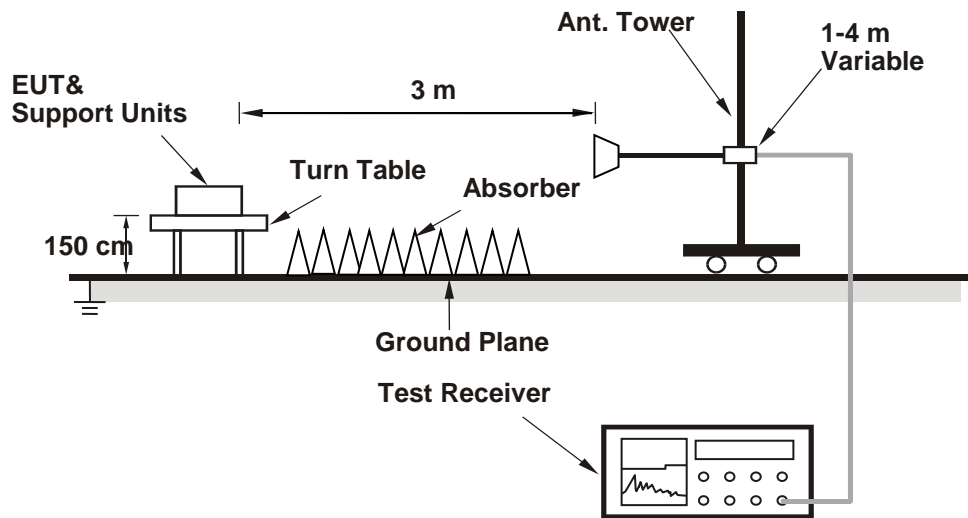

For the actual test configuration, please refer to the attached file (Test Setup Photo).

4.1.7 EUT Operating Conditions

- a. Placed the EUT on a testing table.
- b. Use the software to control the EUT under transmission condition continuously at specific channel frequency.

4.1.8 Test Results
Above 1 GHz Data :
802.11a

EUT Test Condition		Measurement Detail	
Channel	Channel 36	Frequency Range	1 GHz ~ 40 GHz
Input Power	120 Vac, 60 Hz	Detector Function	Peak (PK) Average (AV)
Environmental Conditions	25 deg. C, 65 % RH	Tested By	Chales Hsiao

Antenna Polarity & Test Distance: Horizontal at 3 m								
Frequency (MHz)	Emission Level (dBuV/m)	Read Level (dBuV)	Limit (dBuV/m)	Margin (dB)	Factor (dB/m)	Antenna Height (cm)	Table Angle (Degree)	Remark
5149.1	47.94	37.89	54	-6.06	10.05	189	360	Average
5149.1	62.34	52.29	74	-11.66	10.05	189	360	Peak
5180	94.58	84.46			10.12	189	360	Average
5180	101.73	91.61			10.12	189	360	Peak
*10360	55.18	39.16	68.2	-18.82	-13.02	164	3	Peak
Antenna Polarity & Test Distance: Vertical at 3 m								
Frequency (MHz)	Emission Level (dBuV/m)	Read Level (dBuV)	Limit (dBuV/m)	Margin (dB)	Factor (dB/m)	Antenna Height (cm)	Table Angle (Degree)	Remark
5149.7	52.92	42.87	54	-1.08	10.05	208	198	Average
5149.7	65.2	55.15	74	-8.8	10.05	208	198	Peak
5180	97.87	87.75			10.12	208	198	Average
5180	104.47	94.35			10.12	208	198	Peak
*10360	55.1	39.08	68.2	-18.9	-13.1	155	275	Peak

Remarks:

- Emission Level = Read Level + Factor
Margin value = Emission level – Limit value
- 5180 MHz: Fundamental Frequency
- *: Out of Restricted Band
- The emission levels of other frequencies were very low against the limit

EUT Test Condition		Measurement Detail	
Channel	Channel 40	Frequency Range	1 GHz ~ 40 GHz
Input Power	120 Vac, 60 Hz	Detector Function	Peak (PK) Average (AV)
Environmental Conditions	25 deg. C, 65 % RH	Tested By	Chales Hsiao

Antenna Polarity & Test Distance: Horizontal at 3 m								
Frequency (MHz)	Emission Level (dBuV/m)	Read Level (dBuV)	Limit (dBuV/m)	Margin (dB)	Factor (dB/m)	Antenna Height (cm)	Table Angle (Degree)	Remark
5147.9	45.18	35.13	54	-8.82	10.05	189	360	Average
5147.9	55.25	45.2	74	-18.75	10.05	189	360	Peak
5200	95.58	85.42			10.16	189	360	Average
5200	102.62	92.46			10.16	189	360	Peak
5398.73	41.95	31.58	54	-12.05	10.37	189	360	Average
5398.73	52.38	42.01	74	-21.62	10.37	189	360	Peak
*10400	55.86	39.68	68.2	-12.34	16.18	134	117	Peak
Antenna Polarity & Test Distance: Vertical at 3 m								
Frequency (MHz)	Emission Level (dBuV/m)	Read Level (dBuV)	Limit (dBuV/m)	Margin (dB)	Factor (dB/m)	Antenna Height (cm)	Table Angle (Degree)	Remark
5147.6	48	37.95	54	-6	10.05	208	198	Average
5147.6	57.61	47.56	74	-16.39	10.05	208	198	Peak
5200	98.55	88.39			10.16	208	198	Average
5200	105.76	95.6			10.16	208	198	Peak
5447.68	41.97	31.48	54	-12.03	10.49	208	198	Average
5447.68	53.87	43.38	74	-20.13	10.49	208	198	Peak
*10400	55.04	38.86	68.2	-13.16	16.18	115	54	Peak

Remarks:

- Emission Level = Read Level + Factor
Margin value = Emission level – Limit value
- 5200 MHz: Fundamental Frequency
- *: Out of Restricted Band
- The emission levels of other frequencies were very low against the limit

EUT Test Condition		Measurement Detail	
Channel	Channel 48	Frequency Range	1 GHz ~ 40 GHz
Input Power	120 Vac, 60 Hz	Detector Function	Peak (PK) Average (AV)
Environmental Conditions	25 deg. C, 65 % RH	Tested By	Chales Hsiao

Antenna Polarity & Test Distance: Horizontal at 3 m								
Frequency (MHz)	Emission Level (dBuV/m)	Read Level (dBuV)	Limit (dBuV/m)	Margin (dB)	Factor (dB/m)	Antenna Height (cm)	Table Angle (Degree)	Remark
5240	96.95	86.81			10.14	189	0	Average
5240	103.25	93.11			10.14	189	0	Peak
5442.07	41.87	31.39	54	-12.13	10.48	189	0	Average
5442.07	52.12	41.64	74	-21.88	10.48	189	0	Peak
*10480	55.18	39.28	68.2	-13.02	15.9	104	54	Peak
Antenna Polarity & Test Distance: Vertical at 3 m								
Frequency (MHz)	Emission Level (dBuV/m)	Read Level (dBuV)	Limit (dBuV/m)	Margin (dB)	Factor (dB/m)	Antenna Height (cm)	Table Angle (Degree)	Remark
5240	99.64	89.5			10.14	208	198	Average
5240	106.94	96.8			10.14	208	198	Peak
5436.24	42.16	31.68	54	-11.84	10.48	208	198	Average
5436.24	52.94	42.46	74	-21.06	10.48	208	198	Peak
*10480	56.09	40.19	68.2	-12.11	15.9	119	345	Peak

Remarks:

- Emission Level = Read Level + Factor
Margin value = Emission level – Limit value
- 5240 MHz: Fundamental Frequency
- *: Out of Restricted Band
- The emission levels of other frequencies were very low against the limit

EUT Test Condition		Measurement Detail	
Channel	Channel 52	Frequency Range	1 GHz ~ 40 GHz
Input Power	120 Vac, 60 Hz	Detector Function	Peak (PK) Average (AV)
Environmental Conditions	25 deg. C, 65 % RH	Tested By	Chales Hsiao

Antenna Polarity & Test Distance: Horizontal at 3 m								
Frequency (MHz)	Emission Level (dBuV/m)	Read Level (dBuV)	Limit (dBuV/m)	Margin (dB)	Factor (dB/m)	Antenna Height (cm)	Table Angle (Degree)	Remark
5106.05	43.01	33.07	54	-10.99	9.94	192	353	Average
5106.05	52.7	42.76	74	-21.3	9.94	192	353	Peak
5260	97.66	87.54			10.12	192	353	Average
5260	104.19	94.07			10.12	192	353	Peak
*10520	55.43	39.55	68.2	-12.77	15.88	131	68	Peak

Antenna Polarity & Test Distance: Vertical at 3 m								
Frequency (MHz)	Emission Level (dBuV/m)	Read Level (dBuV)	Limit (dBuV/m)	Margin (dB)	Factor (dB/m)	Antenna Height (cm)	Table Angle (Degree)	Remark
5122.85	43.1	33.11	54	-10.9	9.99	221	192	Average
5122.85	52.96	42.97	74	-21.04	9.99	221	192	Peak
5260	100.15	90.03			10.12	221	192	Average
5260	106.77	96.65			10.12	221	192	Peak
*10520	55.75	39.87	68.2	-12.45	15.88	136	228	Peak

Remarks:

- Emission Level = Read Level + Factor
Margin value = Emission level – Limit value
- 5260 MHz: Fundamental Frequency
- *: Out of Restricted Band
- The emission levels of other frequencies were very low against the limit

EUT Test Condition		Measurement Detail	
Channel	Channel 60	Frequency Range	1 GHz ~ 40 GHz
Input Power	120 Vac, 60 Hz	Detector Function	Peak (PK) Average (AV)
Environmental Conditions	25 deg. C, 65 % RH	Tested By	Chales Hsiao

Antenna Polarity & Test Distance: Horizontal at 3 m								
Frequency (MHz)	Emission Level (dBuV/m)	Read Level (dBuV)	Limit (dBuV/m)	Margin (dB)	Factor (dB/m)	Antenna Height (cm)	Table Angle (Degree)	Remark
5116.4	43.15	33.19	54	-10.85	9.96	192	353	Average
5116.4	53.08	43.12	74	-20.92	9.96	192	353	Peak
5300	97.93	87.87			10.06	192	353	Average
5300	104.18	94.12			10.06	192	353	Peak
5352.2	45.29	35.06	54	-8.71	10.23	192	353	Average
5352.2	53.51	43.28	74	-20.49	10.23	192	353	Peak
10600	46.43	30.67	54	-7.57	15.76	186	141	Average
10600	56.26	40.5	74	-17.74	15.76	186	141	Peak
Antenna Polarity & Test Distance: Vertical at 3 m								
Frequency (MHz)	Emission Level (dBuV/m)	Read Level (dBuV)	Limit (dBuV/m)	Margin (dB)	Factor (dB/m)	Antenna Height (cm)	Table Angle (Degree)	Remark
5134.4	43.24	33.24	54	-10.76	10	221	192	Average
5134.4	52.73	42.73	74	-21.27	10	221	192	Peak
5300	100.37	90.31			10.06	221	192	Average
5300	106.84	96.78			10.06	221	192	Peak
5352.31	47.41	37.18	54	-6.59	10.23	221	192	Average
5352.31	55.91	45.68	74	-18.09	10.23	221	192	Peak
10600	45.53	29.77	54	-8.47	15.76	192	103	Average
10600	55	39.24	74	-19	15.76	192	103	Peak

Remarks:

- Emission Level = Read Level + Factor
Margin value = Emission level – Limit value
- 5300 MHz: Fundamental Frequency
- *: Out of Restricted Band
- The emission levels of other frequencies were very low against the limit

EUT Test Condition		Measurement Detail	
Channel	Channel 64	Frequency Range	1 GHz ~ 40 GHz
Input Power	120 Vac, 60 Hz	Detector Function	Peak (PK) Average (AV)
Environmental Conditions	25 deg. C, 65 % RH	Tested By	Chales Hsiao

Antenna Polarity & Test Distance: Horizontal at 3 m								
Frequency (MHz)	Emission Level (dBuV/m)	Read Level (dBuV)	Limit (dBuV/m)	Margin (dB)	Factor (dB/m)	Antenna Height (cm)	Table Angle (Degree)	Remark
5320	96.06	85.97			10.09	192	353	Average
5320	102.73	92.64			10.09	192	353	Peak
5350.55	48.63	38.4	54	-5.37	10.23	192	353	Average
5350.55	62.42	52.19	74	-11.58	10.23	192	353	Peak
10640	45.68	29.69	54	-8.32	15.99	123	56	Average
10640	55.33	39.34	74	-18.67	15.99	123	56	Peak
Antenna Polarity & Test Distance: Vertical at 3 m								
Frequency (MHz)	Emission Level (dBuV/m)	Read Level (dBuV)	Limit (dBuV/m)	Margin (dB)	Factor (dB/m)	Antenna Height (cm)	Table Angle (Degree)	Remark
5320	98.91	88.82			10.09	221	192	Average
5320	105.11	95.02			10.09	221	192	Peak
5350.66	52.27	42.04	54	-1.73	10.23	221	192	Average
5350.66	65.74	55.51	74	-8.26	10.23	221	192	Peak
10640	46.89	30.9	54	-7.11	15.99	146	205	Average
10640	56.63	40.64	74	-17.37	15.99	146	205	Peak

Remarks:

1. Emission Level = Read Level + Factor
Margin value = Emission level – Limit value
2. 5320 MHz: Fundamental Frequency
3. *: Out of Restricted Band
4. The emission levels of other frequencies were very low against the limit

EUT Test Condition		Measurement Detail	
Channel	Channel 100	Frequency Range	1 GHz ~ 40 GHz
Input Power	120 Vac, 60 Hz	Detector Function	Peak (PK) Average (AV)
Environmental Conditions	25 deg. C, 65 % RH	Tested By	Chales Hsiao

Antenna Polarity & Test Distance: Horizontal at 3 m								
Frequency (MHz)	Emission Level (dBuV/m)	Read Level (dBuV)	Limit (dBuV/m)	Margin (dB)	Factor (dB/m)	Antenna Height (cm)	Table Angle (Degree)	Remark
5447.6	46.9	36.41	54	-7.1	10.49	191	295	Average
5447.6	54.79	44.3	74	-19.21	10.49	191	295	Peak
*5469.84	59.99	49.46	68.2	-8.21	10.53	191	295	Peak
5500	97.67	87.07			10.6	191	295	Average
5500	104.27	93.67			10.6	191	295	Peak
11000	47.57	31.44	54	-6.43	16.13	135	3	Average
11000	55.83	39.7	74	-18.17	16.13	135	3	Peak
Antenna Polarity & Test Distance: Vertical at 3 m								
Frequency (MHz)	Emission Level (dBuV/m)	Read Level (dBuV)	Limit (dBuV/m)	Margin (dB)	Factor (dB/m)	Antenna Height (cm)	Table Angle (Degree)	Remark
5447.92	43.05	32.56	54	-10.95	10.49	100	138	Average
5447.92	53.41	42.92	74	-20.59	10.49	100	138	Peak
*5469.36	52.81	42.28	68.2	-15.39	10.53	100	138	Peak
5500	91.63	81.03			10.6	100	138	Average
5500	98.41	87.81			10.6	100	138	Peak
11000	47.71	31.58	54	-6.29	16.13	189	256	Average
11000	56.62	40.49	74	-17.38	16.13	189	256	Peak

Remarks:

- Emission Level = Read Level + Factor
Margin value = Emission level – Limit value
- 5500 MHz: Fundamental Frequency
- *: Out of Restricted Band
- The emission levels of other frequencies were very low against the limit

EUT Test Condition		Measurement Detail	
Channel	Channel 116	Frequency Range	1 GHz ~ 40 GHz
Input Power	120 Vac, 60 Hz	Detector Function	Peak (PK) Average (AV)
Environmental Conditions	25 deg. C, 65 % RH	Tested By	Chales Hsiao

Antenna Polarity & Test Distance: Horizontal at 3 m								
Frequency (MHz)	Emission Level (dBuV/m)	Read Level (dBuV)	Limit (dBuV/m)	Margin (dB)	Factor (dB/m)	Antenna Height (cm)	Table Angle (Degree)	Remark
5391.76	42.59	32.25	54	-11.41	10.34	191	295	Average
5391.76	52.87	42.53	74	-21.13	10.34	191	295	Peak
*5469.68	51.53	41	68.2	-16.67	10.53	191	295	Peak
5580	100.88	90.17			10.71	191	295	Average
5580	107.44	96.73			10.71	191	295	Peak
*5725.4	52.11	41.19	68.2	-16.09	10.92	191	295	Peak
11160	47.8	31.44	54	-6.2	16.36	164	356	Average
11160	57.23	40.87	74	-16.77	16.36	164	356	Peak

Antenna Polarity & Test Distance: Vertical at 3 m								
Frequency (MHz)	Emission Level (dBuV/m)	Read Level (dBuV)	Limit (dBuV/m)	Margin (dB)	Factor (dB/m)	Antenna Height (cm)	Table Angle (Degree)	Remark
5391.12	41.83	31.49	54	-12.17	10.34	100	138	Average
5391.12	52.54	42.2	74	-21.46	10.34	100	138	Peak
*5469.36	51.05	40.52	68.2	-17.15	10.53	100	138	Peak
5580	94.48	83.77			10.71	100	138	Average
5580	101.79	91.08			10.71	100	138	Peak
*5725	51.35	40.43	68.2	-16.85	10.92	100	138	Peak
11160	47.88	31.52	54	-6.12	16.36	134	285	Average
11160	56.8	40.44	74	-17.2	16.36	134	285	Peak

Remarks:

- Emission Level = Read Level + Factor
Margin value = Emission level – Limit value
- 5580 MHz: Fundamental Frequency
- *: Out of Restricted Band
- The emission levels of other frequencies were very low against the limit

EUT Test Condition		Measurement Detail	
Channel	Channel 140	Frequency Range	1 GHz ~ 40 GHz
Input Power	120 Vac, 60 Hz	Detector Function	Peak (PK) Average (AV)
Environmental Conditions	25 deg. C, 65 % RH	Tested By	Chales Hsiao

Antenna Polarity & Test Distance: Horizontal at 3 m								
Frequency (MHz)	Emission Level (dBuV/m)	Read Level (dBuV)	Limit (dBuV/m)	Margin (dB)	Factor (dB/m)	Antenna Height (cm)	Table Angle (Degree)	Remark
5700	97.49	86.54			10.95	191	295	Average
5700	104.17	93.22			10.95	191	295	Peak
*5725.16	66	55.08	68.2	-2.2	10.92	191	295	Peak
11400	47.77	31.58	54	-6.23	16.19	174	175	Average
11400	56.76	40.57	74	-17.24	16.19	174	175	Peak
Antenna Polarity & Test Distance: Vertical at 3 m								
Frequency (MHz)	Emission Level (dBuV/m)	Read Level (dBuV)	Limit (dBuV/m)	Margin (dB)	Factor (dB/m)	Antenna Height (cm)	Table Angle (Degree)	Remark
5700	91.2	80.25			10.95	100	138	Average
5700	98.22	87.27			10.95	100	138	Peak
*5725.88	54.88	43.96	68.2	-13.32	10.92	100	138	Peak
11400	47.78	31.59	54	-6.22	16.19	134	185	Average
11400	58.51	42.32	74	-15.49	16.19	134	185	Peak

Remarks:

- Emission Level = Read Level + Factor
Margin value = Emission level – Limit value
- 5700 MHz: Fundamental Frequency
- *: Out of Restricted Band
- The emission levels of other frequencies were very low against the limit

EUT Test Condition		Measurement Detail	
Channel	Channel 149	Frequency Range	1 GHz ~ 40 GHz
Input Power	120 Vac, 60 Hz	Detector Function	Peak (PK) Average (AV)
Environmental Conditions	25 deg. C, 65 % RH	Tested By	Chales Hsiao

<Spurious Emission>

Antenna Polarity & Test Distance: Horizontal at 3 m								
Frequency (MHz)	Emission Level (dBuV/m)	Read Level (dBuV)	Limit (dBuV/m)	Margin (dB)	Factor (dB/m)	Antenna Height (cm)	Table Angle (Degree)	Remark
*5631.25	53.04	42.23	68.2	-15.16	10.81	191	295	Peak
5652.25	52.68	41.81	69.86	-17.18	10.87	191	295	Peak
5916.325	50.87	39.78	74.62	-23.75	11.09	191	295	Peak
*6007.15	52.29	40.94	68.2	-15.91	11.35	191	295	Peak
Antenna Polarity & Test Distance: Vertical at 3 m								
Frequency (MHz)	Emission Level (dBuV/m)	Read Level (dBuV)	Limit (dBuV/m)	Margin (dB)	Factor (dB/m)	Antenna Height (cm)	Table Angle (Degree)	Remark
*5645.425	52.1	41.27	68.2	-16.1	10.83	200	208	Peak
5656.975	51.39	40.52	73.36	-21.97	10.87	200	208	Peak
5915.275	52.01	40.92	75.4	-23.39	11.09	200	208	Peak
*5964.1	52.31	41.08	68.2	-15.89	11.23	200	208	Peak

<Out of Band Emission (OOBE)>

Antenna Polarity & Test Distance: Horizontal at 3 m								
Frequency (MHz)	Emission Level (dBuV/m)	Read Level (dBuV)	Limit (dBuV/m)	Margin (dB)	Factor (dB/m)	Antenna Height (cm)	Table Angle (Degree)	Remark
5745	97.78	86.9			10.88	191	295	Average
5745	104.41	93.53			10.88	191	295	Peak
11490	48.03	31.56	54	-5.97	16.47	135	2	Average
11490	56.5	40.03	74	-17.5	16.47	135	2	Peak
Antenna Polarity & Test Distance: Vertical at 3 m								
Frequency (MHz)	Emission Level (dBuV/m)	Read Level (dBuV)	Limit (dBuV/m)	Margin (dB)	Factor (dB/m)	Antenna Height (cm)	Table Angle (Degree)	Remark
5745	95.81	84.93			10.88	200	208	Average
5745	102.55	91.67			10.88	200	208	Peak
11490	48.01	31.54	54	-5.99	16.47	131	114	Average
11490	56.1	39.63	74	-17.9	16.47	131	114	Peak

Remarks:

- Emission Level = Read Level + Factor
Margin value = Emission level – Limit value
- 5745 MHz: Fundamental Frequency
- *: Out of Restricted Band
- The emission levels of other frequencies were very low against the limit

EUT Test Condition		Measurement Detail	
Channel	Channel 157	Frequency Range	1 GHz ~ 40 GHz
Input Power	120 Vac, 60 Hz	Detector Function	Peak (PK) Average (AV)
Environmental Conditions	25 deg. C, 65 % RH	Tested By	Chales Hsiao

<Spurious Emission>

Antenna Polarity & Test Distance: Horizontal at 3 m								
Frequency (MHz)	Emission Level (dBuV/m)	Read Level (dBuV)	Limit (dBuV/m)	Margin (dB)	Factor (dB/m)	Antenna Height (cm)	Table Angle (Degree)	Remark
*5528.875	52.71	42.08	68.2	-15.49	10.63	191	295	Peak
5652.775	48.98	38.11	70.25	-21.27	10.87	191	295	Peak
5921.575	49.8	38.69	70.73	-20.93	11.11	191	295	Peak
*5933.125	53.03	41.92	68.2	-15.17	11.11	191	295	Peak
Antenna Polarity & Test Distance: Vertical at 3 m								
Frequency (MHz)	Emission Level (dBuV/m)	Read Level (dBuV)	Limit (dBuV/m)	Margin (dB)	Factor (dB/m)	Antenna Height (cm)	Table Angle (Degree)	Remark
*5598.7	52.95	42.19	68.2	-15.25	10.76	200	208	Peak
5652.775	49.83	38.96	70.25	-20.42	10.87	200	208	Peak
5918.425	50.2	39.11	73.07	-22.87	11.09	200	208	Peak
*5995.075	53.85	42.52	68.2	-14.35	11.33	200	208	Peak

<Out of Band Emission (OOBE)>

Antenna Polarity & Test Distance: Horizontal at 3 m								
Frequency (MHz)	Emission Level (dBuV/m)	Read Level (dBuV)	Limit (dBuV/m)	Margin (dB)	Factor (dB/m)	Antenna Height (cm)	Table Angle (Degree)	Remark
5785	100.61	89.8			10.81	191	295	Average
5785	107.33	96.52			10.81	191	295	Peak
11570	47.96	31.47	54	-6.04	16.49	182	25	Average
11570	56.13	39.64	74	-17.87	16.49	182	25	Peak
Antenna Polarity & Test Distance: Vertical at 3 m								
Frequency (MHz)	Emission Level (dBuV/m)	Read Level (dBuV)	Limit (dBuV/m)	Margin (dB)	Factor (dB/m)	Antenna Height (cm)	Table Angle (Degree)	Remark
5785	98.72	87.91			10.81	200	208	Average
5785	105.55	94.74			10.81	200	208	Peak
11570	48	31.51	54	-6	16.49	164	4	Average
11570	57.12	40.63	74	-16.88	16.49	164	4	Peak

Remarks:

- Emission Level = Read Level + Factor
Margin value = Emission level – Limit value
- 5785 MHz: Fundamental Frequency
- *: Out of Restricted Band
- The emission levels of other frequencies were very low against the limit

EUT Test Condition		Measurement Detail	
Channel	Channel 165	Frequency Range	1 GHz ~ 40 GHz
Input Power	120 Vac, 60 Hz	Detector Function	Peak (PK) Average (AV)
Environmental Conditions	25 deg. C, 65 % RH	Tested By	Chales Hsiao

<Spurious Emission>

Antenna Polarity & Test Distance: Horizontal at 3 m								
Frequency (MHz)	Emission Level (dBuV/m)	Read Level (dBuV)	Limit (dBuV/m)	Margin (dB)	Factor (dB/m)	Antenna Height (cm)	Table Angle (Degree)	Remark
*5641.75	54.11	43.28	68.2	-14.09	10.83	191	295	Peak
5653.825	49.28	38.41	71.03	-21.75	10.87	191	295	Peak
5922.1	49.04	37.93	70.35	-21.31	11.11	191	295	Peak
*5954.125	53.5	42.31	68.2	-14.7	11.19	191	295	Peak
Antenna Polarity & Test Distance: Vertical at 3 m								
Frequency (MHz)	Emission Level (dBuV/m)	Read Level (dBuV)	Limit (dBuV/m)	Margin (dB)	Factor (dB/m)	Antenna Height (cm)	Table Angle (Degree)	Remark
*5608.675	53.08	42.33	68.2	-15.12	10.75	200	208	Peak
5655.925	51.6	40.73	72.58	-20.98	10.87	200	208	Peak
5921.575	51.56	40.45	70.73	-19.17	11.11	200	208	Peak
*5992.45	53.21	41.88	68.2	-14.99	11.33	200	208	Peak

<Out of Band Emission (OOBE)>

Antenna Polarity & Test Distance: Horizontal at 3 m								
Frequency (MHz)	Emission Level (dBuV/m)	Read Level (dBuV)	Limit (dBuV/m)	Margin (dB)	Factor (dB/m)	Antenna Height (cm)	Table Angle (Degree)	Remark
5825	100.58	89.7			10.88	191	295	Average
5825	107.17	96.29			10.88	191	295	Peak
11650	48.24	31.46	54	-5.76	16.78	164	288	Average
11650	55.67	38.89	74	-18.33	16.78	164	288	Peak
Antenna Polarity & Test Distance: Vertical at 3 m								
Frequency (MHz)	Emission Level (dBuV/m)	Read Level (dBuV)	Limit (dBuV/m)	Margin (dB)	Factor (dB/m)	Antenna Height (cm)	Table Angle (Degree)	Remark
5825	98.22	87.34			10.88	200	208	Average
5825	105.57	94.69			10.88	200	208	Peak
11650	48.3	31.52	54	-5.7	16.78	156	322	Average
11650	56	39.22	74	-18	16.78	156	322	Peak

Remarks:

- Emission Level = Read Level + Factor
Margin value = Emission level – Limit value
- 5825 MHz: Fundamental Frequency
- *: Out of Restricted Band
- The emission levels of other frequencies were very low against the limit

802.11n (HT20)

EUT Test Condition		Measurement Detail	
Channel	Channel 36	Frequency Range	1 GHz ~ 40 GHz
Input Power	120 Vac, 60 Hz	Detector Function	Peak (PK) Average (AV)
Environmental Conditions	25 deg. C, 65 % RH	Tested By	Chales Hsiao

Antenna Polarity & Test Distance: Horizontal at 3 m								
Frequency (MHz)	Emission Level (dBuV/m)	Read Level (dBuV)	Limit (dBuV/m)	Margin (dB)	Factor (dB/m)	Antenna Height (cm)	Table Angle (Degree)	Remark
5148.95	46.67	36.62	54	-7.33	10.05	189	0	Average
5148.95	61.45	51.4	74	-12.55	10.05	189	0	Peak
5180	94.78	84.66			10.12	189	0	Average
5180	101.5	91.38			10.12	189	0	Peak
*10360	56.37	40.35	68.2	-11.83	16.02	154	74	Peak
Antenna Polarity & Test Distance: Vertical at 3 m								
Frequency (MHz)	Emission Level (dBuV/m)	Read Level (dBuV)	Limit (dBuV/m)	Margin (dB)	Factor (dB/m)	Antenna Height (cm)	Table Angle (Degree)	Remark
5149.7	52.21	42.16	54	-1.79	10.05	200	198	Average
5149.7	63.38	53.33	74	-10.62	10.05	200	198	Peak
5180	97.59	87.47			10.12	200	198	Average
5180	104.48	94.36			10.12	200	198	Peak
*10360	54.77	38.75	68.2	-13.43	16.02	112	252	Peak

Remarks:

- Emission Level = Read Level + Factor
Margin value = Emission level – Limit value
- 5180 MHz: Fundamental Frequency
- *: Out of Restricted Band
- The emission levels of other frequencies were very low against the limit

EUT Test Condition		Measurement Detail	
Channel	Channel 40	Frequency Range	1 GHz ~ 40 GHz
Input Power	120 Vac, 60 Hz	Detector Function	Peak (PK) Average (AV)
Environmental Conditions	25 deg. C, 65 % RH	Tested By	Chales Hsiao

Antenna Polarity & Test Distance: Horizontal at 3 m								
Frequency (MHz)	Emission Level (dBuV/m)	Read Level (dBuV)	Limit (dBuV/m)	Margin (dB)	Factor (dB/m)	Antenna Height (cm)	Table Angle (Degree)	Remark
5148.2	44.78	34.73	54	-9.22	10.05	189	0	Average
5148.2	53.98	43.93	74	-20.02	10.05	189	0	Peak
5200	95.33	85.17			10.16	189	0	Average
5200	102.62	92.46			10.16	189	0	Peak
5397.63	41.9	31.53	54	-12.1	10.37	189	0	Average
5397.63	53.3	42.93	74	-20.7	10.37	189	0	Peak
*10400	55.84	39.66	68.2	-12.36	16.18	105	356	Peak
Antenna Polarity & Test Distance: Vertical at 3 m								
Frequency (MHz)	Emission Level (dBuV/m)	Read Level (dBuV)	Limit (dBuV/m)	Margin (dB)	Factor (dB/m)	Antenna Height (cm)	Table Angle (Degree)	Remark
5148.2	47.28	37.23	54	-6.72	10.05	208	198	Average
5148.2	57.23	47.18	74	-16.77	10.05	208	198	Peak
5200	98.47	88.31			10.16	208	198	Average
5200	105.19	95.03			10.16	208	198	Peak
5395.87	41.97	31.6	54	-12.03	10.37	208	198	Average
5395.87	53.19	42.82	74	-20.81	10.37	208	198	Peak
*10400	56.88	40.7	68.2	-11.32	16.18	114	174	Peak

Remarks:

- Emission Level = Read Level + Factor
Margin value = Emission level – Limit value
- 5200 MHz: Fundamental Frequency
- *: Out of Restricted Band
- The emission levels of other frequencies were very low against the limit

EUT Test Condition		Measurement Detail	
Channel	Channel 48	Frequency Range	1 GHz ~ 40 GHz
Input Power	120 Vac, 60 Hz	Detector Function	Peak (PK) Average (AV)
Environmental Conditions	25 deg. C, 65 % RH	Tested By	Chales Hsiao

Antenna Polarity & Test Distance: Horizontal at 3 m								
Frequency (MHz)	Emission Level (dBuV/m)	Read Level (dBuV)	Limit (dBuV/m)	Margin (dB)	Factor (dB/m)	Antenna Height (cm)	Table Angle (Degree)	Remark
5240	95.42	85.28			10.14	189	0	Average
5240	102	91.86			10.14	189	0	Peak
5452.3	41.86	31.35	54	-12.14	10.51	189	0	Average
5452.3	52.91	42.4	74	-21.09	10.51	189	0	Peak
*10480	56.05	40.15	68.2	-12.15	15.9	134	322	Peak
Antenna Polarity & Test Distance: Vertical at 3 m								
Frequency (MHz)	Emission Level (dBuV/m)	Read Level (dBuV)	Limit (dBuV/m)	Margin (dB)	Factor (dB/m)	Antenna Height (cm)	Table Angle (Degree)	Remark
5240	98.95	88.81			10.14	208	198	Average
5240	105.07	94.93			10.14	208	198	Peak
5432.72	41.94	31.46	54	-12.06	10.48	208	198	Average
5432.72	52.49	42.01	74	-21.51	10.48	208	198	Peak
*10480	55.72	39.82	68.2	-12.48	15.9	117	145	Peak

Remarks:

- Emission Level = Read Level + Factor
Margin value = Emission level – Limit value
- 5240 MHz: Fundamental Frequency
- *: Out of Restricted Band
- The emission levels of other frequencies were very low against the limit

EUT Test Condition		Measurement Detail	
Channel	Channel 52	Frequency Range	1 GHz ~ 40 GHz
Input Power	120 Vac, 60 Hz	Detector Function	Peak (PK) Average (AV)
Environmental Conditions	25 deg. C, 65 % RH	Tested By	Chales Hsiao

Antenna Polarity & Test Distance: Horizontal at 3 m								
Frequency (MHz)	Emission Level (dBuV/m)	Read Level (dBuV)	Limit (dBuV/m)	Margin (dB)	Factor (dB/m)	Antenna Height (cm)	Table Angle (Degree)	Remark
5067.8	43.01	33.13	54	-10.99	9.88	192	353	Average
5067.8	52.91	43.03	74	-21.09	9.88	192	353	Peak
5260	96.47	86.35			10.12	192	353	Average
5260	103.58	93.46			10.12	192	353	Peak
*10520	56.69	40.81	68.2	-11.51	15.88	121	246	Peak
Antenna Polarity & Test Distance: Vertical at 3 m								
Frequency (MHz)	Emission Level (dBuV/m)	Read Level (dBuV)	Limit (dBuV/m)	Margin (dB)	Factor (dB/m)	Antenna Height (cm)	Table Angle (Degree)	Remark
5106.8	43.11	33.15	54	-10.89	9.96	221	192	Average
5106.8	52.74	42.78	74	-21.26	9.96	221	192	Peak
5260	99.07	88.95			10.12	221	192	Average
5260	106.61	96.49			10.12	221	192	Peak
*10520	55.13	39.25	68.2	-13.07	15.88	135	87	Peak

Remarks:

- Emission Level = Read Level + Factor
Margin value = Emission level – Limit value
- 5260 MHz: Fundamental Frequency
- *: Out of Restricted Band
- The emission levels of other frequencies were very low against the limit

EUT Test Condition		Measurement Detail	
Channel	Channel 60	Frequency Range	1 GHz ~ 40 GHz
Input Power	120 Vac, 60 Hz	Detector Function	Peak (PK) Average (AV)
Environmental Conditions	25 deg. C, 65 % RH	Tested By	Chales Hsiao

Antenna Polarity & Test Distance: Horizontal at 3 m								
Frequency (MHz)	Emission Level (dBuV/m)	Read Level (dBuV)	Limit (dBuV/m)	Margin (dB)	Factor (dB/m)	Antenna Height (cm)	Table Angle (Degree)	Remark
5103.2	42.96	33.03	54	-11.04	9.93	192	353	Average
5103.2	52.67	42.74	74	-21.33	9.93	192	353	Peak
5300	96.45	86.39			10.06	192	353	Average
5300	103.7	93.64			10.06	192	353	Peak
5351.32	45.22	34.99	54	-8.78	10.23	192	353	Average
5351.32	53.37	43.14	74	-20.63	10.23	192	353	Peak
10600	44.48	28.72	54	-9.52	15.76	136	209	Average
10600	54.27	38.51	74	-19.73	15.76	136	209	Peak

Antenna Polarity & Test Distance: Vertical at 3 m								
Frequency (MHz)	Emission Level (dBuV/m)	Read Level (dBuV)	Limit (dBuV/m)	Margin (dB)	Factor (dB/m)	Antenna Height (cm)	Table Angle (Degree)	Remark
5139.95	43.15	33.14	54	-10.85	10.01	221	192	Average
5139.95	52.63	42.62	74	-21.37	10.01	221	192	Peak
5300	99.16	89.1			10.06	221	192	Average
5300	106.69	96.63			10.06	221	192	Peak
5350.88	47.35	37.12	54	-6.65	10.23	221	192	Average
5350.88	57.06	46.83	74	-16.94	10.23	221	192	Peak
10600	45.75	29.99	54	-8.25	15.76	187	151	Average
10600	55.22	39.46	74	-18.78	15.76	187	151	Peak

Remarks:

- Emission Level = Read Level + Factor
Margin value = Emission level – Limit value
- 5300 MHz: Fundamental Frequency
- *: Out of Restricted Band
- The emission levels of other frequencies were very low against the limit

EUT Test Condition		Measurement Detail	
Channel	Channel 64	Frequency Range	1 GHz ~ 40 GHz
Input Power	120 Vac, 60 Hz	Detector Function	Peak (PK) Average (AV)
Environmental Conditions	25 deg. C, 65 % RH	Tested By	Chales Hsiao

Antenna Polarity & Test Distance: Horizontal at 3 m								
Frequency (MHz)	Emission Level (dBuV/m)	Read Level (dBuV)	Limit (dBuV/m)	Margin (dB)	Factor (dB/m)	Antenna Height (cm)	Table Angle (Degree)	Remark
5320	95.29	85.2			10.09	192	353	Average
5320	102.21	92.12			10.09	192	353	Peak
5350	49.41	39.18	54	-4.59	10.23	192	353	Average
5350	63.22	52.99	74	-10.78	10.23	192	353	Peak
10640	45.12	29.13	54	-8.88	15.99	184	112	Average
10640	54.88	38.89	74	-19.12	15.99	184	112	Peak
Antenna Polarity & Test Distance: Vertical at 3 m								
Frequency (MHz)	Emission Level (dBuV/m)	Read Level (dBuV)	Limit (dBuV/m)	Margin (dB)	Factor (dB/m)	Antenna Height (cm)	Table Angle (Degree)	Remark
5320	98.75	88.66			10.09	221	192	Average
5320	105.31	95.22			10.09	221	192	Peak
5350.22	52.91	42.68	54	-1.09	10.23	221	192	Average
5350.22	69.69	59.46	74	-4.31	10.23	221	192	Peak
10640	45.82	29.83	54	-8.18	15.99	142	306	Average
10640	55.53	39.54	74	-18.47	15.99	142	306	Peak

Remarks:

1. Emission Level = Read Level + Factor
Margin value = Emission level – Limit value
2. 5320 MHz: Fundamental Frequency
3. *: Out of Restricted Band
4. The emission levels of other frequencies were very low against the limit

EUT Test Condition		Measurement Detail	
Channel	Channel 100	Frequency Range	1 GHz ~ 40 GHz
Input Power	120 Vac, 60 Hz	Detector Function	Peak (PK) Average (AV)
Environmental Conditions	25 deg. C, 65 % RH	Tested By	Chales Hsiao

Antenna Polarity & Test Distance: Horizontal at 3 m								
Frequency (MHz)	Emission Level (dBuV/m)	Read Level (dBuV)	Limit (dBuV/m)	Margin (dB)	Factor (dB/m)	Antenna Height (cm)	Table Angle (Degree)	Remark
5448.56	47.76	37.27	54	-6.24	10.49	191	295	Average
5448.56	55.61	45.12	74	-18.39	10.49	191	295	Peak
*5470	59.89	49.36	68.2	-8.31	10.53	191	295	Peak
5500	97.64	87.04			10.6	191	295	Average
5500	104.52	93.92			10.6	191	295	Peak
11000	47.51	31.38	54	-6.49	16.13	105	290	Average
11000	55.39	39.26	74	-18.61	16.13	105	290	Peak
Antenna Polarity & Test Distance: Vertical at 3 m								
Frequency (MHz)	Emission Level (dBuV/m)	Read Level (dBuV)	Limit (dBuV/m)	Margin (dB)	Factor (dB/m)	Antenna Height (cm)	Table Angle (Degree)	Remark
5448.56	43.44	32.95	54	-10.56	10.49	100	138	Average
5448.56	52.94	42.45	74	-21.06	10.49	100	138	Peak
*5469.04	55.86	45.33	68.2	-12.34	10.53	100	138	Peak
5500	91.71	81.11			10.6	100	138	Average
5500	98.28	87.68			10.6	100	138	Peak
11000	47.69	31.56	54	-6.31	16.13	155	275	Average
11000	55.53	39.4	74	-18.47	16.13	155	275	Peak

Remarks:

- Emission Level = Read Level + Factor
Margin value = Emission level – Limit value
- 5500 MHz: Fundamental Frequency
- *: Out of Restricted Band
- The emission levels of other frequencies were very low against the limit

EUT Test Condition		Measurement Detail	
Channel	Channel 116	Frequency Range	1 GHz ~ 40 GHz
Input Power	120 Vac, 60 Hz	Detector Function	Peak (PK) Average (AV)
Environmental Conditions	25 deg. C, 65 % RH	Tested By	Chales Hsiao

Antenna Polarity & Test Distance: Horizontal at 3 m								
Frequency (MHz)	Emission Level (dBuV/m)	Read Level (dBuV)	Limit (dBuV/m)	Margin (dB)	Factor (dB/m)	Antenna Height (cm)	Table Angle (Degree)	Remark
5394.48	42.38	32.02	54	-11.62	10.36	191	295	Average
5394.48	53.31	42.95	74	-20.69	10.36	191	295	Peak
*5469.36	50.22	39.69	68.2	-17.98	10.53	191	295	Peak
5580	100.54	89.83			10.71	191	295	Average
5580	107.17	96.46			10.71	191	295	Peak
*5725.32	51.92	41	68.2	-16.28	10.92	191	295	Peak
11160	47.87	31.51	54	-6.13	16.36	185	58	Average
11160	57.69	41.33	74	-16.31	16.36	185	58	Peak
Antenna Polarity & Test Distance: Vertical at 3 m								
Frequency (MHz)	Emission Level (dBuV/m)	Read Level (dBuV)	Limit (dBuV/m)	Margin (dB)	Factor (dB/m)	Antenna Height (cm)	Table Angle (Degree)	Remark
5379.92	41.82	31.48	54	-12.18	10.34	100	138	Average
5379.92	52.73	42.39	74	-21.27	10.34	100	138	Peak
*5469.2	49.87	39.34	68.2	-18.33	10.53	100	138	Peak
5580	94.19	83.48			10.71	100	138	Average
5580	101.48	90.77			10.71	100	138	Peak
*5725.16	51.7	40.78	68.2	-16.5	10.92	100	138	Peak
11160	47.9	31.54	54	-6.1	16.36	157	215	Average
11160	57.24	40.88	74	-16.76	16.36	157	215	Peak

Remarks:

- Emission Level = Read Level + Factor
Margin value = Emission level – Limit value
- 5580 MHz: Fundamental Frequency
- *: Out of Restricted Band
- The emission levels of other frequencies were very low against the limit

EUT Test Condition		Measurement Detail	
Channel	Channel 140	Frequency Range	1 GHz ~ 40 GHz
Input Power	120 Vac, 60 Hz	Detector Function	Peak (PK) Average (AV)
Environmental Conditions	25 deg. C, 65 % RH	Tested By	Chales Hsiao

Antenna Polarity & Test Distance: Horizontal at 3 m								
Frequency (MHz)	Emission Level (dBuV/m)	Read Level (dBuV)	Limit (dBuV/m)	Margin (dB)	Factor (dB/m)	Antenna Height (cm)	Table Angle (Degree)	Remark
5700	97.4	86.45			10.95	191	295	Average
5700	104.08	93.13			10.95	191	295	Peak
*5725	67.05	56.13	68.2	-1.15	10.92	191	295	Peak
11400	47.65	31.46	54	-6.35	16.19	185	255	Average
11400	56.79	40.6	74	-17.21	16.19	185	255	Peak

Antenna Polarity & Test Distance: Vertical at 3 m								
Frequency (MHz)	Emission Level (dBuV/m)	Read Level (dBuV)	Limit (dBuV/m)	Margin (dB)	Factor (dB/m)	Antenna Height (cm)	Table Angle (Degree)	Remark
5700	91.43	80.48			10.95	100	138	Average
5700	98.85	87.9			10.95	100	138	Peak
*5725.72	57.55	46.63	68.2	-10.65	10.92	100	138	Peak
11400	47.65	31.46	54	-6.35	16.19	213	222	Average
11400	56.95	40.76	74	-17.05	16.19	213	222	Peak

Remarks:

- Emission Level = Read Level + Factor
Margin value = Emission level – Limit value
- 5700 MHz: Fundamental Frequency
- *: Out of Restricted Band
- The emission levels of other frequencies were very low against the limit

EUT Test Condition		Measurement Detail	
Channel	Channel 149	Frequency Range	1 GHz ~ 40 GHz
Input Power	120 Vac, 60 Hz	Detector Function	Peak (PK) Average (AV)
Environmental Conditions	25 deg. C, 65 % RH	Tested By	Chales Hsiao

<Spurious Emission>

Antenna Polarity & Test Distance: Horizontal at 3 m								
Frequency (MHz)	Emission Level (dBuV/m)	Read Level (dBuV)	Limit (dBuV/m)	Margin (dB)	Factor (dB/m)	Antenna Height (cm)	Table Angle (Degree)	Remark
*5611.3	52.46	41.69	68.2	-15.74	10.77	191	295	Peak
5656.975	51.83	40.96	73.36	-21.53	10.87	191	295	Peak
5913.175	52.72	41.65	76.95	-24.23	11.07	191	295	Peak
*6022.375	53.4	42.05	68.2	-14.8	11.35	191	295	Peak
Antenna Polarity & Test Distance: Vertical at 3 m								
Frequency (MHz)	Emission Level (dBuV/m)	Read Level (dBuV)	Limit (dBuV/m)	Margin (dB)	Factor (dB/m)	Antenna Height (cm)	Table Angle (Degree)	Remark
*5587.675	52.52	41.79	68.2	-15.68	10.73	200	208	Peak
5656.975	50.99	40.12	73.36	-22.37	10.87	200	208	Peak
5918.95	51.89	40.8	72.68	-20.79	11.09	200	208	Peak
*5991.925	52.61	41.28	68.2	-15.59	11.33	200	208	Peak

<Out of Band Emission (OOBE)>

Antenna Polarity & Test Distance: Horizontal at 3 m								
Frequency (MHz)	Emission Level (dBuV/m)	Read Level (dBuV)	Limit (dBuV/m)	Margin (dB)	Factor (dB/m)	Antenna Height (cm)	Table Angle (Degree)	Remark
5745	97.58	86.7			10.88	191	295	Average
5745	104.96	94.08			10.88	191	295	Peak
11490	48.03	31.56	54	-5.97	16.47	215	222	Average
11490	57.21	40.74	74	-16.79	16.47	215	222	Peak
Antenna Polarity & Test Distance: Vertical at 3 m								
Frequency (MHz)	Emission Level (dBuV/m)	Read Level (dBuV)	Limit (dBuV/m)	Margin (dB)	Factor (dB/m)	Antenna Height (cm)	Table Angle (Degree)	Remark
5745	95.56	84.68			10.88	200	208	Average
5745	102.39	91.51			10.88	200	208	Peak
11490	48.04	31.57	54	-5.96	16.47	178	5	Average
11490	56.41	39.94	74	-17.59	16.47	178	5	Peak

Remarks:

- Emission Level = Read Level + Factor
Margin value = Emission level – Limit value
- 5745 MHz: Fundamental Frequency
- *: Out of Restricted Band
- The emission levels of other frequencies were very low against the limit

EUT Test Condition		Measurement Detail	
Channel	Channel 157	Frequency Range	1 GHz ~ 40 GHz
Input Power	120 Vac, 60 Hz	Detector Function	Peak (PK) Average (AV)
Environmental Conditions	25 deg. C, 65 % RH	Tested By	Chales Hsiao

<Spurious Emission>

Antenna Polarity & Test Distance: Horizontal at 3 m								
Frequency (MHz)	Emission Level (dBuV/m)	Read Level (dBuV)	Limit (dBuV/m)	Margin (dB)	Factor (dB/m)	Antenna Height (cm)	Table Angle (Degree)	Remark
*5615.5	52.44	41.65	68.2	-15.76	10.79	191	295	Peak
5658.025	52.81	41.94	74.14	-21.33	10.87	191	295	Peak
5915.8	51.32	40.23	75.01	-23.69	11.09	191	295	Peak
*5968.3	52.67	41.44	68.2	-15.53	11.23	191	295	Peak
Antenna Polarity & Test Distance: Vertical at 3 m								
Frequency (MHz)	Emission Level (dBuV/m)	Read Level (dBuV)	Limit (dBuV/m)	Margin (dB)	Factor (dB/m)	Antenna Height (cm)	Table Angle (Degree)	Remark
*5546.725	52.29	41.63	68.2	-15.91	10.66	200	208	Peak
5653.3	50	39.13	70.64	-20.64	10.87	200	208	Peak
5921.575	49.69	38.58	70.73	-21.04	11.11	200	208	Peak
*6005.575	53.11	41.78	68.2	-15.09	11.33	200	208	Peak

<Out of Band Emission (OOBE)>

Antenna Polarity & Test Distance: Horizontal at 3 m								
Frequency (MHz)	Emission Level (dBuV/m)	Read Level (dBuV)	Limit (dBuV/m)	Margin (dB)	Factor (dB/m)	Antenna Height (cm)	Table Angle (Degree)	Remark
5785	99.58	88.77			10.81	191	295	Average
5785	106.76	95.95			10.81	191	295	Peak
11570	47.94	31.45	54	-6.06	16.49	177	285	Average
11570	56.25	39.76	74	-17.75	16.49	177	285	Peak
Antenna Polarity & Test Distance: Vertical at 3 m								
Frequency (MHz)	Emission Level (dBuV/m)	Read Level (dBuV)	Limit (dBuV/m)	Margin (dB)	Factor (dB/m)	Antenna Height (cm)	Table Angle (Degree)	Remark
5785	97.74	86.93			10.81	200	208	Average
5785	104.3	93.49			10.81	200	208	Peak
11570	47.88	31.39	54	-6.12	16.49	135	252	Average
11570	56.53	40.04	74	-17.47	16.49	135	252	Peak

Remarks:

- Emission Level = Read Level + Factor
Margin value = Emission level – Limit value
- 5785 MHz: Fundamental Frequency
- *: Out of Restricted Band
- The emission levels of other frequencies were very low against the limit

EUT Test Condition		Measurement Detail	
Channel	Channel 165	Frequency Range	1 GHz ~ 40 GHz
Input Power	120 Vac, 60 Hz	Detector Function	Peak (PK) Average (AV)
Environmental Conditions	25 deg. C, 65 % RH	Tested By	Chales Hsiao

<Spurious Emission>

Antenna Polarity & Test Distance: Horizontal at 3 m								
Frequency (MHz)	Emission Level (dBuV/m)	Read Level (dBuV)	Limit (dBuV/m)	Margin (dB)	Factor (dB/m)	Antenna Height (cm)	Table Angle (Degree)	Remark
*5638.075	53.06	42.23	68.2	-15.14	10.83	191	295	Peak
5654.35	49.82	38.95	71.42	-21.6	10.87	191	295	Peak
5923.675	51.86	40.75	69.18	-17.32	11.11	191	295	Peak
*5965.15	52.05	40.82	68.2	-16.15	11.23	191	295	Peak
Antenna Polarity & Test Distance: Vertical at 3 m								
Frequency (MHz)	Emission Level (dBuV/m)	Read Level (dBuV)	Limit (dBuV/m)	Margin (dB)	Factor (dB/m)	Antenna Height (cm)	Table Angle (Degree)	Remark
*5555.65	52.73	42.07	68.2	-15.47	10.66	200	208	Peak
5651.725	51.98	41.11	69.48	-17.5	10.87	200	208	Peak
5921.575	52.15	41.04	70.73	-18.58	11.11	200	208	Peak
*6007.15	53.44	42.09	68.2	-14.76	11.35	200	208	Peak

<Out of Band Emission (OOBE)>

Antenna Polarity & Test Distance: Horizontal at 3 m								
Frequency (MHz)	Emission Level (dBuV/m)	Read Level (dBuV)	Limit (dBuV/m)	Margin (dB)	Factor (dB/m)	Antenna Height (cm)	Table Angle (Degree)	Remark
5825	99.67	88.79			10.88	191	295	Average
5825	106.8	95.92			10.88	191	295	Peak
11650	48.26	31.48	54	-5.74	16.78	152	5	Average
11650	56.14	39.36	74	-17.86	16.78	152	5	Peak
Antenna Polarity & Test Distance: Vertical at 3 m								
Frequency (MHz)	Emission Level (dBuV/m)	Read Level (dBuV)	Limit (dBuV/m)	Margin (dB)	Factor (dB/m)	Antenna Height (cm)	Table Angle (Degree)	Remark
5825	97.89	87.01			10.88	200	208	Average
5825	104.43	93.55			10.88	200	208	Peak
11650	48.33	31.55	54	-5.67	16.78	134	318	Average
11650	55.91	39.13	74	-18.09	16.78	134	318	Peak

Remarks:

- Emission Level = Read Level + Factor
Margin value = Emission level – Limit value
- 5825 MHz: Fundamental Frequency
- *: Out of Restricted Band
- The emission levels of other frequencies were very low against the limit

802.11n (HT40)

EUT Test Condition		Measurement Detail	
Channel	Channel 38	Frequency Range	1 GHz ~ 40 GHz
Input Power	120 Vac, 60 Hz	Detector Function	Peak (PK) Average (AV)
Environmental Conditions	25 deg. C, 65 % RH	Tested By	Chales Hsiao

Antenna Polarity & Test Distance: Horizontal at 3 m								
Frequency (MHz)	Emission Level (dBuV/m)	Read Level (dBuV)	Limit (dBuV/m)	Margin (dB)	Factor (dB/m)	Antenna Height (cm)	Table Angle (Degree)	Remark
5149.85	47.9	37.85	54	-6.1	10.05	189	0	Average
5149.85	64.97	54.92	74	-9.03	10.05	189	0	Peak
5190	88.59	78.47			10.12	189	0	Average
5190	95.86	85.74			10.12	189	0	Peak
5443.94	42.34	31.86	54	-11.66	10.48	189	0	Average
5443.94	52.22	41.74	74	-21.78	10.48	189	0	Peak
*10380	55.34	39.24	68.2	-12.86	16.1	118	32	Peak
Antenna Polarity & Test Distance: Vertical at 3 m								
Frequency (MHz)	Emission Level (dBuV/m)	Read Level (dBuV)	Limit (dBuV/m)	Margin (dB)	Factor (dB/m)	Antenna Height (cm)	Table Angle (Degree)	Remark
5149.55	52.89	42.84	54	-1.11	10.05	200	198	Average
5149.55	64	53.95	74	-10	10.05	200	198	Peak
5190	91.48	81.36			10.12	200	198	Average
5190	98.22	88.1			10.12	200	198	Peak
5447.35	42.33	31.84	54	-11.67	10.49	200	198	Average
5447.35	52.43	41.94	74	-21.57	10.49	200	198	Peak
*10380	54.99	38.89	68.2	-13.21	16.1	154	179	Peak

Remarks:

- Emission Level = Read Level + Factor
Margin value = Emission level – Limit value
- 5190 MHz: Fundamental Frequency
- *: Out of Restricted Band
- The emission levels of other frequencies were very low against the limit

EUT Test Condition		Measurement Detail	
Channel	Channel 46	Frequency Range	1 GHz ~ 40 GHz
Input Power	120 Vac, 60 Hz	Detector Function	Peak (PK) Average (AV)
Environmental Conditions	25 deg. C, 65 % RH	Tested By	Chales Hsiao

Antenna Polarity & Test Distance: Horizontal at 3 m								
Frequency (MHz)	Emission Level (dBuV/m)	Read Level (dBuV)	Limit (dBuV/m)	Margin (dB)	Factor (dB/m)	Antenna Height (cm)	Table Angle (Degree)	Remark
5149.55	44.58	34.53	54	-9.42	10.05	189	0	Average
5149.55	54.03	43.98	74	-19.97	10.05	189	0	Peak
5230	92.58	82.44			10.14	189	0	Average
5230	99.32	89.18			10.14	189	0	Peak
5438.55	42.22	31.74	54	-11.78	10.48	189	0	Average
5438.55	52.64	42.16	74	-21.36	10.48	189	0	Peak
*10460	54.82	38.82	68.2	-13.38	16	135	5	Peak
Antenna Polarity & Test Distance: Vertical at 3 m								
Frequency (MHz)	Emission Level (dBuV/m)	Read Level (dBuV)	Limit (dBuV/m)	Margin (dB)	Factor (dB/m)	Antenna Height (cm)	Table Angle (Degree)	Remark
5150	47.18	37.13	54	-6.82	10.05	200	198	Average
5150	59.45	49.4	74	-14.55	10.05	200	198	Peak
5230	95.46	85.32			10.14	200	198	Average
5230	102.71	92.57			10.14	200	198	Peak
5351.76	42.5	32.27	54	-11.5	10.23	200	198	Average
5351.76	52.67	42.44	74	-21.33	10.23	200	198	Peak
*10460	54.83	38.83	68.2	-13.37	16	118	347	Peak

Remarks:

- Emission Level = Read Level + Factor
Margin value = Emission level – Limit value
- 5230 MHz: Fundamental Frequency
- *: Out of Restricted Band
- The emission levels of other frequencies were very low against the limit

EUT Test Condition		Measurement Detail	
Channel	Channel 54	Frequency Range	1 GHz ~ 40 GHz
Input Power	120 Vac, 60 Hz	Detector Function	Peak (PK) Average (AV)
Environmental Conditions	25 deg. C, 65 % RH	Tested By	Chales Hsiao

Antenna Polarity & Test Distance: Horizontal at 3 m								
Frequency (MHz)	Emission Level (dBuV/m)	Read Level (dBuV)	Limit (dBuV/m)	Margin (dB)	Factor (dB/m)	Antenna Height (cm)	Table Angle (Degree)	Remark
5117	43.29	33.33	54	-10.71	9.96	192	353	Average
5117	52.88	42.92	74	-21.12	9.96	192	353	Peak
5270	94.13	84.01			10.12	192	353	Average
5270	100.83	90.71			10.12	192	353	Peak
5350.55	44.85	34.62	54	-9.15	10.23	192	353	Average
5350.55	53.64	43.41	74	-20.36	10.23	192	353	Peak
*10540	55.1	39.27	68.2	-13.1	15.83	163	204	Peak
Antenna Polarity & Test Distance: Vertical at 3 m								
Frequency (MHz)	Emission Level (dBuV/m)	Read Level (dBuV)	Limit (dBuV/m)	Margin (dB)	Factor (dB/m)	Antenna Height (cm)	Table Angle (Degree)	Remark
5140.4	43.7	33.69	54	-10.3	10.01	221	192	Average
5140.4	53.71	43.7	74	-20.29	10.01	221	192	Peak
5270	96.76	86.64			10.12	221	192	Average
5270	103.84	93.72			10.12	221	192	Peak
5352.31	47.41	37.18	54	-6.59	10.23	221	192	Average
5352.31	54.77	44.54	74	-19.23	10.23	221	192	Peak
*10540	55.06	39.23	68.2	-13.14	15.83	187	151	Peak

Remarks:

- Emission Level = Read Level + Factor
Margin value = Emission level – Limit value
- 5270 MHz: Fundamental Frequency
- *: Out of Restricted Band
- The emission levels of other frequencies were very low against the limit

EUT Test Condition		Measurement Detail	
Channel	Channel 62	Frequency Range	1 GHz ~ 40 GHz
Input Power	120 Vac, 60 Hz	Detector Function	Peak (PK) Average (AV)
Environmental Conditions	25 deg. C, 65 % RH	Tested By	Chales Hsiao

Antenna Polarity & Test Distance: Horizontal at 3 m								
Frequency (MHz)	Emission Level (dBuV/m)	Read Level (dBuV)	Limit (dBuV/m)	Margin (dB)	Factor (dB/m)	Antenna Height (cm)	Table Angle (Degree)	Remark
5146.4	43.31	33.26	54	-10.69	10.05	192	353	Average
5146.4	52.71	42.66	74	-21.29	10.05	192	353	Peak
5310	87.81	77.72			10.09	192	353	Average
5310	94.88	84.79			10.09	192	353	Peak
5350.22	48.64	38.41	54	-5.36	10.23	192	353	Average
5350.22	60	49.77	74	-14	10.23	192	353	Peak
10620	45.49	29.61	54	-8.51	15.88	174	215	Average
10620	55.26	39.38	74	-18.74	15.88	174	215	Peak

Antenna Polarity & Test Distance: Vertical at 3 m								
Frequency (MHz)	Emission Level (dBuV/m)	Read Level (dBuV)	Limit (dBuV/m)	Margin (dB)	Factor (dB/m)	Antenna Height (cm)	Table Angle (Degree)	Remark
5120	43.53	33.56	54	-10.47	9.97	221	192	Average
5120	52.99	43.02	74	-21.01	9.97	221	192	Peak
5310	91.09	81			10.09	221	192	Average
5310	97.75	87.66			10.09	221	192	Peak
5350.33	52.26	42.03	54	-1.74	10.23	221	192	Average
5350.33	63.47	53.24	74	-10.53	10.23	221	192	Peak
10620	45.46	29.58	54	-8.54	15.88	181	245	Average
10620	55.13	39.25	74	-18.87	15.88	181	245	Peak

Remarks:

- Emission Level = Read Level + Factor
Margin value = Emission level – Limit value
- 5310 MHz: Fundamental Frequency
- *: Out of Restricted Band
- The emission levels of other frequencies were very low against the limit

EUT Test Condition		Measurement Detail	
Channel	Channel 102	Frequency Range	1 GHz ~ 40 GHz
Input Power	120 Vac, 60 Hz	Detector Function	Peak (PK) Average (AV)
Environmental Conditions	25 deg. C, 65 % RH	Tested By	Chales Hsiao

Antenna Polarity & Test Distance: Horizontal at 3 m								
Frequency (MHz)	Emission Level (dBuV/m)	Read Level (dBuV)	Limit (dBuV/m)	Margin (dB)	Factor (dB/m)	Antenna Height (cm)	Table Angle (Degree)	Remark
5459.92	47.98	37.47	54	-6.02	10.51	191	295	Average
5459.92	57.43	46.92	74	-16.57	10.51	191	295	Peak
*5469.52	67.14	56.61	68.2	-1.06	10.53	191	295	Peak
5510	93.45	82.85			10.6	191	295	Average
5510	100.1	89.5			10.6	191	295	Peak
*5725.48	52.81	41.89	68.2	-15.39	10.92	191	295	Peak
11020	47.85	31.69	54	-6.15	16.16	108	2	Average
11020	56.34	40.18	74	-17.66	16.16	108	2	Peak

Antenna Polarity & Test Distance: Vertical at 3 m								
Frequency (MHz)	Emission Level (dBuV/m)	Read Level (dBuV)	Limit (dBuV/m)	Margin (dB)	Factor (dB/m)	Antenna Height (cm)	Table Angle (Degree)	Remark
5459.76	43.25	32.74	54	-10.75	10.51	100	138	Average
5459.76	52.73	42.22	74	-21.27	10.51	100	138	Peak
*5469.04	58.3	47.77	68.2	-9.9	10.53	100	138	Peak
5510	87.68	77.08			10.6	100	138	Average
5510	94.9	84.3			10.6	100	138	Peak
*5725.8	53.07	42.15	68.2	-15.13	10.92	100	138	Peak
11020	47.92	31.76	54	-6.08	16.16	188	164	Average
11020	54.87	38.71	74	-19.13	16.16	188	164	Peak

Remarks:

- Emission Level = Read Level + Factor
Margin value = Emission level – Limit value
- 5510 MHz: Fundamental Frequency
- *: Out of Restricted Band
- The emission levels of other frequencies were very low against the limit

EUT Test Condition		Measurement Detail	
Channel	Channel 110	Frequency Range	1 GHz ~ 40 GHz
Input Power	120 Vac, 60 Hz	Detector Function	Peak (PK) Average (AV)
Environmental Conditions	25 deg. C, 65 % RH	Tested By	Chales Hsiao

Antenna Polarity & Test Distance: Horizontal at 3 m								
Frequency (MHz)	Emission Level (dBuV/m)	Read Level (dBuV)	Limit (dBuV/m)	Margin (dB)	Factor (dB/m)	Antenna Height (cm)	Table Angle (Degree)	Remark
5447.12	46.32	35.83	54	-7.68	10.49	191	295	Average
5447.12	54.49	44	74	-19.51	10.49	191	295	Peak
*5469.84	55.74	45.21	68.2	-12.46	10.53	191	295	Peak
5550	97.61	86.93			10.68	191	295	Average
5550	104.56	93.88			10.68	191	295	Peak
*5725.8	52.81	41.89	68.2	-15.39	10.92	191	295	Peak
11100	47.95	31.68	54	-6.05	16.27	155	162	Average
11100	56.57	40.3	74	-17.43	16.27	155	162	Peak
Antenna Polarity & Test Distance: Vertical at 3 m								
Frequency (MHz)	Emission Level (dBuV/m)	Read Level (dBuV)	Limit (dBuV/m)	Margin (dB)	Factor (dB/m)	Antenna Height (cm)	Table Angle (Degree)	Remark
5446.32	43.31	32.82	54	-10.69	10.49	100	138	Average
5446.32	53.49	43	74	-20.51	10.49	100	138	Peak
*5469.68	52.33	41.8	68.2	-15.87	10.53	100	138	Peak
5550	91.66	80.98			10.68	100	138	Average
5550	98.49	87.81			10.68	100	138	Peak
*5725.24	52.39	41.47	68.2	-15.81	10.92	100	138	Peak
11100	48.05	31.78	54	-5.95	16.27	164	256	Average
11100	55.15	38.88	74	-18.85	16.27	164	256	Peak

Remarks:

- Emission Level = Read Level + Factor
Margin value = Emission level – Limit value
- 5550 MHz: Fundamental Frequency
- *: Out of Restricted Band
- The emission levels of other frequencies were very low against the limit

EUT Test Condition		Measurement Detail	
Channel	Channel 134	Frequency Range	1 GHz ~ 40 GHz
Input Power	120 Vac, 60 Hz	Detector Function	Peak (PK) Average (AV)
Environmental Conditions	25 deg. C, 65 % RH	Tested By	Chales Hsiao

Antenna Polarity & Test Distance: Horizontal at 3 m								
Frequency (MHz)	Emission Level (dBuV/m)	Read Level (dBuV)	Limit (dBuV/m)	Margin (dB)	Factor (dB/m)	Antenna Height (cm)	Table Angle (Degree)	Remark
5453.84	42.47	31.96	54	-11.53	10.51	191	295	Average
5453.84	52.92	42.41	74	-21.08	10.51	191	295	Peak
*5470	51.94	41.41	68.2	-16.26	10.53	191	295	Peak
5670	97.49	86.59			10.9	191	295	Average
5670	104.66	93.76			10.9	191	295	Peak
*5725.96	66.96	56.04	68.2	-1.24	10.92	191	295	Peak
11340	48.2	31.78	54	-5.8	16.42	156	285	Average
11340	57.42	41	74	-16.58	16.42	156	285	Peak

Antenna Polarity & Test Distance: Vertical at 3 m								
Frequency (MHz)	Emission Level (dBuV/m)	Read Level (dBuV)	Limit (dBuV/m)	Margin (dB)	Factor (dB/m)	Antenna Height (cm)	Table Angle (Degree)	Remark
5444.72	42.29	31.81	54	-11.71	10.48	100	138	Average
5444.72	52.14	41.66	74	-21.86	10.48	100	138	Peak
*5469.68	51.59	41.06	68.2	-16.61	10.53	100	138	Peak
5670	91.56	80.66			10.9	100	138	Average
5670	98.33	87.43			10.9	100	138	Peak
*5725.8	56.4	45.48	68.2	-11.8	10.92	100	138	Peak
11340	48.12	31.7	54	-5.88	16.42	154	177	Average
11340	56.86	40.44	74	-17.14	16.42	154	177	Peak

Remarks:

- Emission Level = Read Level + Factor
Margin value = Emission level – Limit value
- 5670 MHz: Fundamental Frequency
- *: Out of Restricted Band
- The emission levels of other frequencies were very low against the limit

EUT Test Condition		Measurement Detail	
Channel	Channel 151	Frequency Range	1 GHz ~ 40 GHz
Input Power	120 Vac, 60 Hz	Detector Function	Peak (PK) Average (AV)
Environmental Conditions	25 deg. C, 65 % RH	Tested By	Chales Hsiao

<Spurious Emission>

Antenna Polarity & Test Distance: Horizontal at 3 m								
Frequency (MHz)	Emission Level (dBuV/m)	Read Level (dBuV)	Limit (dBuV/m)	Margin (dB)	Factor (dB/m)	Antenna Height (cm)	Table Angle (Degree)	Remark
*5650.15	53.41	42.54	68.31	-14.9	10.87	191	295	Peak
5659.075	52.94	42.07	74.92	-21.98	10.87	191	295	Peak
5918.425	50.57	39.48	73.07	-22.5	11.09	191	295	Peak
*5986.15	52.76	41.47	68.2	-15.44	11.29	191	295	Peak
Antenna Polarity & Test Distance: Vertical at 3 m								
Frequency (MHz)	Emission Level (dBuV/m)	Read Level (dBuV)	Limit (dBuV/m)	Margin (dB)	Factor (dB/m)	Antenna Height (cm)	Table Angle (Degree)	Remark
*5538.85	53.5	42.84	68.2	-14.7	10.66	200	208	Peak
5652.25	51.31	40.44	69.86	-18.55	10.87	200	208	Peak
5921.575	49.79	38.68	70.73	-20.94	11.11	200	208	Peak
*5967.775	52.78	41.55	68.2	-15.42	11.23	200	208	Peak

<Out of Band Emission (OOBE)>

Antenna Polarity & Test Distance: Horizontal at 3 m								
Frequency (MHz)	Emission Level (dBuV/m)	Read Level (dBuV)	Limit (dBuV/m)	Margin (dB)	Factor (dB/m)	Antenna Height (cm)	Table Angle (Degree)	Remark
5755	96.59	85.69			10.9	191	295	Average
5755	103.44	92.54			10.9	191	295	Peak
11510	48.21	31.7	54	-5.79	16.51	185	5	Average
11510	56.48	39.97	74	-17.52	16.51	185	5	Peak
Antenna Polarity & Test Distance: Vertical at 3 m								
Frequency (MHz)	Emission Level (dBuV/m)	Read Level (dBuV)	Limit (dBuV/m)	Margin (dB)	Factor (dB/m)	Antenna Height (cm)	Table Angle (Degree)	Remark
5755	94.58	83.68			10.9	200	208	Average
5755	101.1	90.2			10.9	200	208	Peak
11510	48.19	31.68	54	-5.81	16.51	137	155	Average
11510	56.39	39.88	74	-17.61	16.51	137	155	Peak

Remarks:

- Emission Level = Read Level + Factor
Margin value = Emission level – Limit value
- 5755 MHz: Fundamental Frequency
- *: Out of Restricted Band
- The emission levels of other frequencies were very low against the limit

EUT Test Condition		Measurement Detail	
Channel	Channel 159	Frequency Range	1 GHz ~ 40 GHz
Input Power	120 Vac, 60 Hz	Detector Function	Peak (PK) Average (AV)
Environmental Conditions	25 deg. C, 65 % RH	Tested By	Chales Hsiao

<Spurious Emission>

Antenna Polarity & Test Distance: Horizontal at 3 m								
Frequency (MHz)	Emission Level (dBuV/m)	Read Level (dBuV)	Limit (dBuV/m)	Margin (dB)	Factor (dB/m)	Antenna Height (cm)	Table Angle (Degree)	Remark
*5539.9	52.48	41.82	68.2	-15.72	10.66	191	295	Peak
5652.775	51.65	40.78	70.25	-18.6	10.87	191	295	Peak
5923.675	49.76	38.65	69.18	-19.42	11.11	191	295	Peak
*5985.1	53.73	42.47	68.2	-14.47	11.26	191	295	Peak
Antenna Polarity & Test Distance: Vertical at 3 m								
Frequency (MHz)	Emission Level (dBuV/m)	Read Level (dBuV)	Limit (dBuV/m)	Margin (dB)	Factor (dB/m)	Antenna Height (cm)	Table Angle (Degree)	Remark
*5622.85	52.26	41.47	68.2	-15.94	10.79	200	208	Peak
5653.3	50.64	39.77	70.64	-20	10.87	200	208	Peak
5923.15	50.87	39.76	69.57	-18.7	11.11	200	208	Peak
*5987.2	52.8	41.49	68.2	-15.4	11.31	200	208	Peak

<Out of Band Emission (OOBE)>

Antenna Polarity & Test Distance: Horizontal at 3 m								
Frequency (MHz)	Emission Level (dBuV/m)	Read Level (dBuV)	Limit (dBuV/m)	Margin (dB)	Factor (dB/m)	Antenna Height (cm)	Table Angle (Degree)	Remark
5795	96.59	85.77			10.82	191	295	Average
5795	103.5	92.68			10.82	191	295	Peak
11590	48.17	31.66	54	-5.83	16.51	195	5	Average
11590	56.97	40.46	74	-17.03	16.51	195	5	Peak
Antenna Polarity & Test Distance: Vertical at 3 m								
Frequency (MHz)	Emission Level (dBuV/m)	Read Level (dBuV)	Limit (dBuV/m)	Margin (dB)	Factor (dB/m)	Antenna Height (cm)	Table Angle (Degree)	Remark
5795	94.85	84.03			10.82	200	208	Average
5795	101.81	90.99			10.82	200	208	Peak
11590	48.18	31.67	54	-5.82	16.51	135	355	Average
11590	56.05	39.54	74	-17.95	16.51	135	355	Peak

Remarks:

- Emission Level = Read Level + Factor
Margin value = Emission level – Limit value
- 5795 MHz: Fundamental Frequency
- *: Out of Restricted Band
- The emission levels of other frequencies were very low against the limit

9 kHz ~ 30 MHz Data:

The amplitude of spurious emissions attenuated more than 20 dB below the permissible value is not required to be report.

30 MHz ~ 1 GHz Worst-Case Data:

802.11n (HT40)

EUT Test Condition		Measurement Detail	
Channel	Channel 102	Frequency Range	30 MHz ~ 1 GHz
Input Power	120 Vac, 60 Hz	Detector Function	Peak (PK) Quasi-peak (QP)
Environmental Conditions	25 deg. C, 65 % RH	Tested By	Chales Hsiao

Horizontal

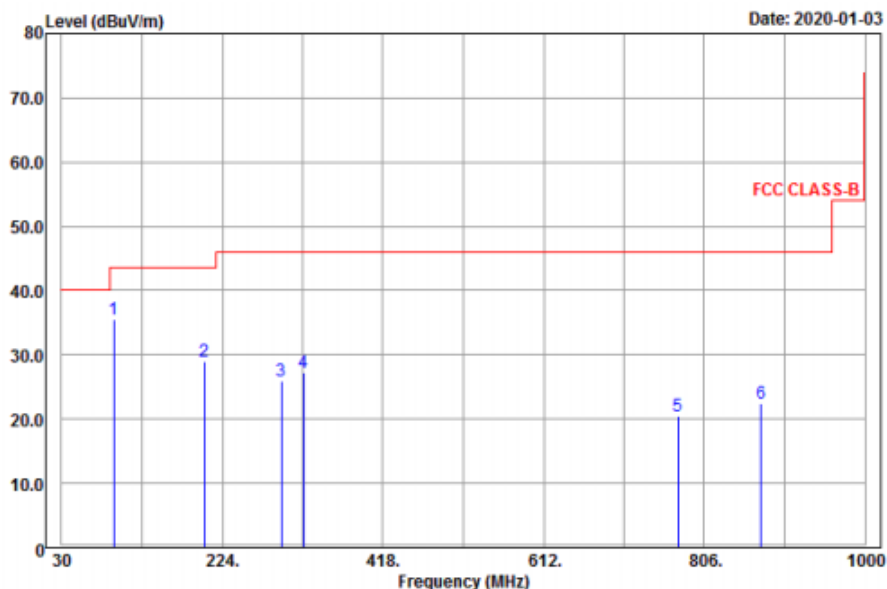

Vertical

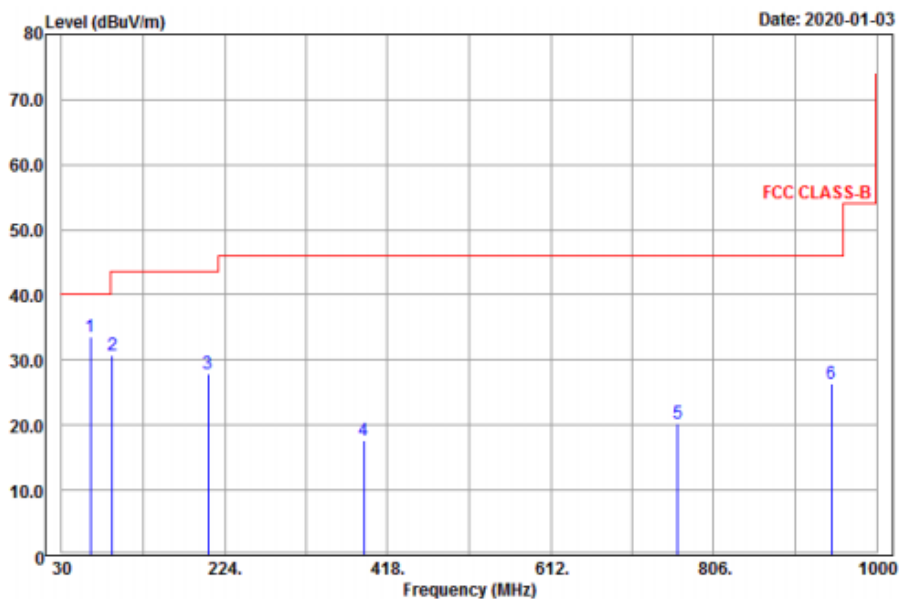

Antenna Polarity & Test Distance: Horizontal at 3 m

Frequency (MHz)	Emission Level (dBuV/m)	Read Level (dBuV)	Limit (dBuV/m)	Margin (dB)	Factor (dB/m)	Antenna Height (cm)	Table Angle (Degree)	Remark
92.64	35.54	53.88	43.5	-7.96	-18.34	124	196	Peak
202.53	28.89	47.09	43.5	-14.61	-18.2	111	12	Peak
295.68	25.9	41.9	46	-20.1	-16	105	256	Peak
322.4	27.17	42.69	46	-18.83	-15.52	158	8	Peak
774.6	20.52	28.71	46	-25.48	-8.19	124	200	Peak
874.7	22.41	28.69	46	-23.59	-6.28	124	224	Peak

Antenna Polarity & Test Distance: Vertical at 3 m

Frequency (MHz)	Emission Level (dBuV/m)	Read Level (dBuV)	Limit (dBuV/m)	Margin (dB)	Factor (dB/m)	Antenna Height (cm)	Table Angle (Degree)	Remark
64.02	33.58	50.82	40	-6.42	-17.24	123	322	Peak
89.94	30.78	49.81	43.5	-12.72	-19.03	187	174	Peak
204.42	27.8	45.98	43.5	-15.7	-18.18	105	165	Peak
389.6	17.57	31.67	46	-28.43	-14.1	165	285	Peak
763.4	20.36	28.61	46	-25.64	-8.25	105	151	Peak
946.1	26.35	31.75	46	-19.65	-5.4	145	255	Peak

Remarks:

- Emission Level = Read Level + Factor
Margin value = Emission level – Limit value
- The emission levels of other frequencies were very low against the limit

4.2 Conducted Emission Measurement

4.2.1 Limits of Conducted Emission Measurement

Frequency (MHz)	Conducted Limit (dBuV)	
	Quasi-Peak	Average
0.15 - 0.5	66 - 56	56 - 46
0.50 - 5.0	56	46
5.0 - 30.0	60	50

- Note: 1. The lower limit shall apply at the transition frequencies.
 2. The limit decreases in line with the logarithm of the frequency in the range of 0.15 to 0.50 MHz.

4.2.2 Test Instruments

Description & Manufacturer	Model No.	Serial No.	Date of Calibration	Due Date of Calibration
Test Receiver ROHDE & SCHWARZ	ESR3	102412	Feb. 14, 2019	Feb. 13, 2020
RF signal cable (with 10dB PAD) Woken	5D-FB	Cable-cond2-01	Sep. 05, 2019	Sep. 04, 2020
LISN ROHDE & SCHWARZ (EUT)	ESH2-Z5	100100	Jan. 30, 2019	Jan. 29, 2020
LISN ROHDE & SCHWARZ (Peripheral)	ESH3-Z5	100312	Aug. 13, 2019	Aug. 12, 2020
Software ADT	BV ADT_Cond_ V7.3.7.4	NA	NA	NA

- Note: 1. The calibration interval of the above test instruments is 12 months and the calibrations are traceable to NML/ROC and NIST/USA.
 2. The test was performed in HwaYa Shielded Room 2.
 3. The VCCI Site Registration No. is C-12047.

4.2.3 Test Procedures

- a. The EUT was placed 0.4 meters from the conducting wall of the shielded room with EUT being connected to the power mains through a line impedance stabilization network (LISN). Other support units were connected to the power mains through another LISN. The two LISNs provide 50 ohm/ 50uH of coupling impedance for the measuring instrument.
- b. Both lines of the power mains connected to the EUT were checked for maximum conducted interference.
- c. The frequency range from 150 kHz to 30 MHz was searched. Emission levels under (Limit -20 dB) was not recorded.

Note: All modes of operation were investigated and the worst-case emissions are reported.

4.2.4 Deviation from Test Standard

No deviation.

4.2.5 Test Setup

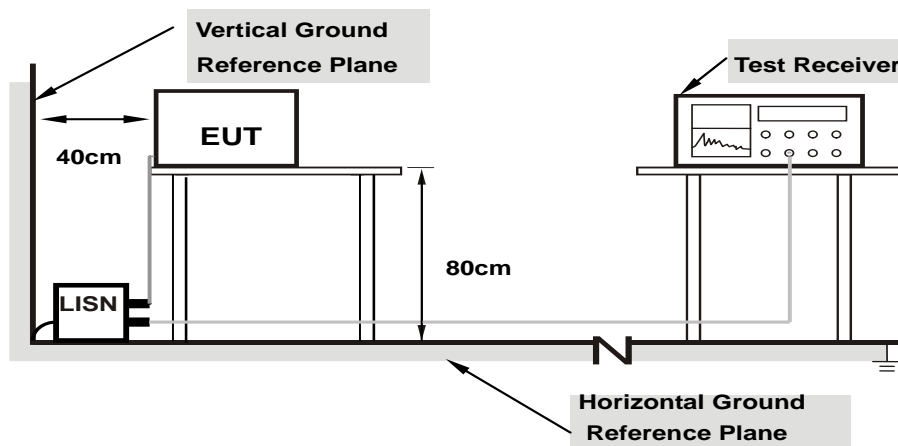

- Note:**
1. Support units were connected to second LISN.
 2. Both of LISNs (AMN) are 80 cm from EUT and at least 80 cm from other units and other metal planes

For the actual test configuration, please refer to the attached file (Test Setup Photo).

4.2.6 EUT Operating Conditions

- a. Placed the EUT on a testing table.
- b. Use the software to control the EUT under transmission condition continuously at specific channel frequency.

4.2.7 Test Results

Frequency Range	150kHz ~ 30MHz	Detector Function & Resolution Bandwidth	Quasi-Peak (QP) / Average (AV), 9kHz
Input Power	120Vac, 60Hz	Environmental Conditions	25°C, 65%RH
Tested by	Jisyong Wang	Test Date	2020/1/5

Phase Of Power : Line (L)										
No	Frequency (MHz)	Correction Factor (dB)	Reading Value (dBuV)		Emission Level (dBuV)		Limit (dBuV)		Margin (dB)	
			Q.P.	AV.	Q.P.	AV.	Q.P.	AV.	Q.P.	AV.
1	0.17011	10.11	26.17	24.70	36.28	34.81	64.96	54.96	-28.68	-20.15
2	0.34975	10.15	30.04	25.03	40.19	35.18	58.97	48.97	-18.78	-13.79
3	0.40200	10.16	26.33	23.86	36.49	34.02	57.81	47.81	-21.32	-13.79
4	5.53593	10.37	33.12	31.31	43.49	41.68	60.00	50.00	-16.51	-8.32
5	7.89225	10.40	27.11	24.01	37.51	34.41	60.00	50.00	-22.49	-15.59
6	19.15125	10.63	23.93	21.28	34.56	31.91	60.00	50.00	-25.44	-18.09

Remarks:

1. Q.P. and AV. are abbreviations of quasi-peak and average individually.
2. The emission levels of other frequencies were very low against the limit.
3. Margin value = Emission level – Limit value
4. Correction factor = Insertion loss + Cable loss
5. Emission Level = Correction Factor + Reading Value

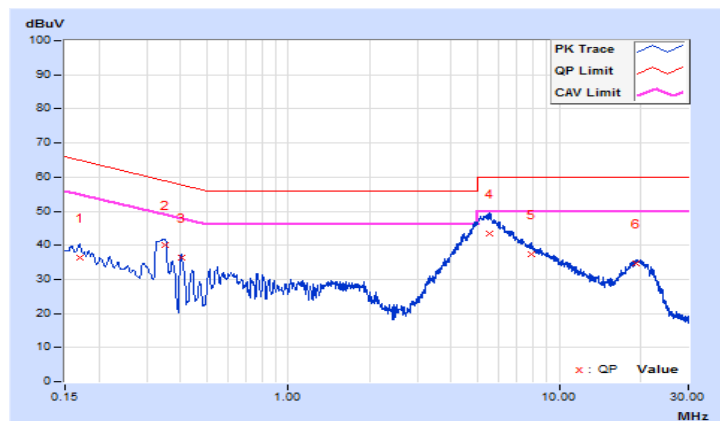

Frequency Range	150kHz ~ 30MHz	Detector Function & Resolution Bandwidth	Quasi-Peak (QP) / Average (AV), 9kHz
Input Power	120Vac, 60Hz	Environmental Conditions	25°C, 65%RH
Tested by	Jisyong Wang	Test Date	2020/1/5

Phase Of Power : Neutral (N)										
No	Frequency (MHz)	Correction Factor (dB)	Reading Value (dBuV)		Emission Level (dBuV)		Limit (dBuV)		Margin (dB)	
			Q.P.	AV.	Q.P.	AV.	Q.P.	AV.	Q.P.	AV.
1	0.16966	10.17	25.12	23.40	35.29	33.57	64.98	54.98	-29.69	-21.41
2	0.34244	10.21	29.32	25.30	39.53	35.51	59.14	49.14	-19.61	-13.63
3	1.43025	10.30	21.42	20.33	31.72	30.63	56.00	46.00	-24.28	-15.37
4	5.41725	10.45	33.81	30.79	44.26	41.24	60.00	50.00	-15.74	-8.76
5	10.78800	10.57	25.33	23.30	35.90	33.87	60.00	50.00	-24.10	-16.13
6	19.98825	10.81	22.28	20.52	33.09	31.33	60.00	50.00	-26.91	-18.67

Remarks:

1. Q.P. and AV. are abbreviations of quasi-peak and average individually.
2. The emission levels of other frequencies were very low against the limit.
3. Margin value = Emission level – Limit value
4. Correction factor = Insertion loss + Cable loss
5. Emission Level = Correction Factor + Reading Value

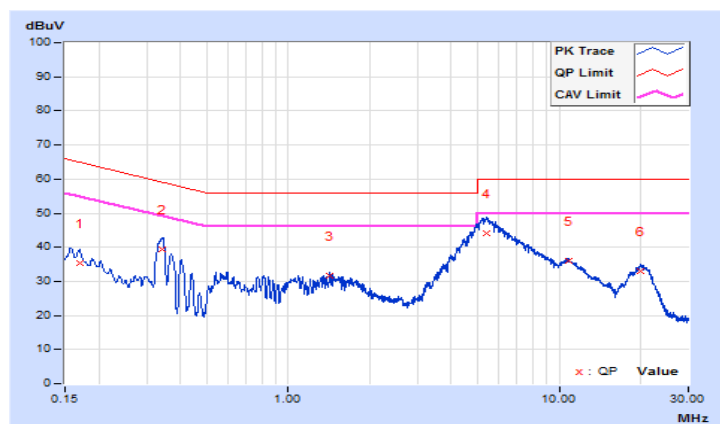

4.3 Transmit Power Measurement

4.3.1 Limits of Transmit Power Measurement

Operation Band	EUT Category	Limit
U-NII-1	Outdoor Access Point	1 Watt (30 dBm) (Max. e.i.r.p \leq 125 mW (21 dBm) at any elevation angle above 30 degrees as measured from the horizon)
	Fixed point-to-point Access Point	1 Watt (30 dBm)
	Indoor Access Point	1 Watt (30 dBm)
	√ Mobile and Portable client device	250 mW (24 dBm)
U-NII-2A	√	250 mW (24 dBm) or 11 dBm + 10 log B*
U-NII-2C	√	250 mW (24 dBm) or 11 dBm + 10 log B*
U-NII-3	√	1 Watt (30 dBm)

*B is the 26 dB emission bandwidth in megahertz

Per KDB 662911 Method of conducted output power measurement on IEEE 802.11 devices,

Array Gain = 0 dB (i.e., no array gain) for $N_{ANT} \leq 4$;

Array Gain = 0 dB (i.e., no array gain) for channel widths ≥ 40 MHz for any N_{ANT} ;

Array Gain = $5 \log(N_{ANT}/N_{SS})$ dB or 3 dB, whichever is less for 20 MHz channel widths with $N_{ANT} \geq 5$.

For power measurements on all other devices: Array Gain = $10 \log(N_{ANT}/N_{SS})$ dB.

4.3.2 Test Setup

<Power Output Measurement>

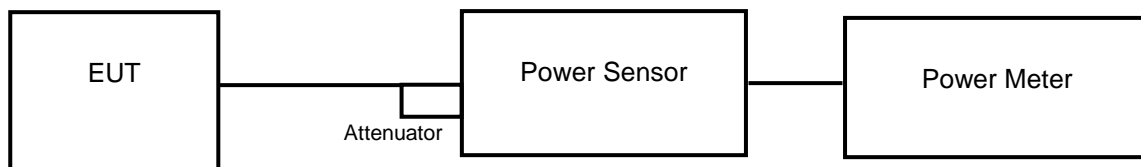

<26 dB Bandwidth>

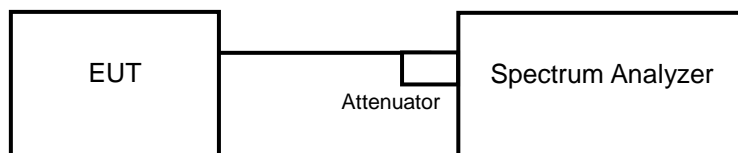

4.3.3 Test Instruments

Refer to section 4.1.2 to get information of above instrument.

4.3.4 Test Procedure

Average Power Measurement

<802.11a, 802.11n (HT20), 802.11n (HT40)>

Method PM is used to perform output power measurement, trigger and gating function of wide band power meter is enabled to measure max output power of TX on burst. Duty factor is not added to measured value.

26 dB Bandwidth

- a. Set RBW = approximately 1 % of the emission bandwidth.
- b. Set the VBW > RBW.
- c. Detector = Peak.
- d. Trace mode = max hold.
- e. Measure the maximum width of the emission that is 26 dB down from the peak of the emission. Compare this with the RBW setting of the analyzer. Readjust RBW and repeat measurement as needed until the RBW/EBW ratio is approximately 1 %.

4.3.5 Deviation from Test Standard

No deviation.

4.3.6 EUT Operating Conditions

The software provided by client to enable the EUT under transmission condition continuously at lowest, middle and highest channel frequencies individually.

4.3.7 Test Results

Power Output:

802.11a

Channel	Frequency (MHz)	Maximum Conducted Power (mW)	Maximum Conducted Power (dBm)	Power Limit (dBm)	Pass / Fail
36	5180	25.942	14.14	24	Pass
40	5200	36.308	15.60	24	Pass
48	5240	36.475	15.62	24	Pass
52	5260	36.141	15.58	24	Pass
60	5300	36.475	15.62	24	Pass
64	5320	25.527	14.07	24	Pass
100	5500	19.907	12.99	24	Pass
116	5580	36.475	15.62	24	Pass
140	5700	20.606	13.14	24	Pass
149	5745	20.512	13.12	30	Pass
157	5785	36.141	15.58	30	Pass
165	5825	36.728	15.65	30	Pass

Note:

For U-NII-2A, U-NII-2C Band:

1. $11 \text{ dBm} + 10\log (39.14) = 26.92 \text{ dBm} > 24 \text{ dBm}$.
2. $11 \text{ dBm} + 10\log (39.28) = 26.94 \text{ dBm} > 24 \text{ dBm}$.
3. $11 \text{ dBm} + 10\log (32.68) = 26.14 \text{ dBm} > 24 \text{ dBm}$.
4. $11 \text{ dBm} + 10\log (28.62) = 25.56 \text{ dBm} > 24 \text{ dBm}$.
5. $11 \text{ dBm} + 10\log (40.60) = 27.08 \text{ dBm} > 24 \text{ dBm}$.
6. $11 \text{ dBm} + 10\log (29.62) = 25.71 \text{ dBm} > 24 \text{ dBm}$.

802.11n (HT20)

Channel	Frequency (MHz)	Maximum Conducted Power (mW)	Maximum Conducted Power (dBm)	Power Limit (dBm)	Pass / Fail
36	5180	25.293	14.03	24	Pass
40	5200	30.832	14.89	24	Pass
48	5240	31.189	14.94	24	Pass
52	5260	30.761	14.88	24	Pass
60	5300	31.189	14.94	24	Pass
64	5320	25.468	14.06	24	Pass
100	5500	20.512	13.12	24	Pass
116	5580	31.117	14.93	24	Pass
140	5700	20.654	13.15	24	Pass
149	5745	20.606	13.14	30	Pass
157	5785	30.974	14.91	30	Pass
165	5825	31.117	14.93	30	Pass

Note:

For U-NII-2A, U-NII-2C Band:

1. $11 \text{ dBm} + 10\log(40.66) = 27.09 \text{ dBm} > 24 \text{ dBm}$.
2. $11 \text{ dBm} + 10\log(41.08) = 27.13 \text{ dBm} > 24 \text{ dBm}$.
3. $11 \text{ dBm} + 10\log(36.33) = 26.60 \text{ dBm} > 24 \text{ dBm}$.
4. $11 \text{ dBm} + 10\log(27.99) = 25.47 \text{ dBm} > 24 \text{ dBm}$.
5. $11 \text{ dBm} + 10\log(43.41) = 27.37 \text{ dBm} > 24 \text{ dBm}$.
6. $11 \text{ dBm} + 10\log(30.08) = 25.78 \text{ dBm} > 24 \text{ dBm}$.

802.11n (HT40)

Channel	Frequency (MHz)	Maximum Conducted Power (mW)	Maximum Conducted Power (dBm)	Power Limit (dBm)	Pass / Fail
38	5190	12.445	10.95	24	Pass
46	5230	30.549	14.85	24	Pass
54	5270	30.339	14.82	24	Pass
62	5310	9.12	9.60	24	Pass
102	5510	9.954	9.98	24	Pass
110	5550	25.704	14.10	24	Pass
134	5670	26.002	14.15	24	Pass
151	5755	19.861	12.98	30	Pass
159	5795	20.045	13.02	30	Pass

Note:

For U-NII-2A, U-NII-2C Band:

1. $11 \text{ dBm} + 10\log (63.39) = 29.02 \text{ dBm} > 24 \text{ dBm}$.
2. $11 \text{ dBm} + 10\log (52.22) = 28.17 \text{ dBm} > 24 \text{ dBm}$.
3. $11 \text{ dBm} + 10\log (46.09) = 27.63 \text{ dBm} > 24 \text{ dBm}$.
4. $11 \text{ dBm} + 10\log (74.21) = 29.70 \text{ dBm} > 24 \text{ dBm}$.
5. $11 \text{ dBm} + 10\log (85.52) = 30.32 \text{ dBm} > 24 \text{ dBm}$.

26 dB Bandwidth:
802.11a

Channel	Frequency (MHz)	26 dBc Bandwidth (MHz)
36	5180	37.22
40	5200	39.18
48	5240	39.11
52	5260	39.14
60	5300	39.28
64	5320	32.68
100	5500	28.62
116	5580	40.60
140	5700	29.62

802.11n (HT20)

Channel	Frequency (MHz)	26 dBc Bandwidth (MHz)
36	5180	32.09
40	5200	39.91
48	5240	42.43
52	5260	40.66
60	5300	41.08
64	5320	36.33
100	5500	27.99
116	5580	43.41
140	5700	30.08

802.11n (HT40)

Channel	Frequency (MHz)	26 dBc Bandwidth (MHz)
38	5190	57.74
46	5230	62.44
54	5270	63.39
62	5310	52.22
102	5510	46.09
110	5550	74.21
134	5670	85.52

Spectrum Plot of Worst Value

802.11a

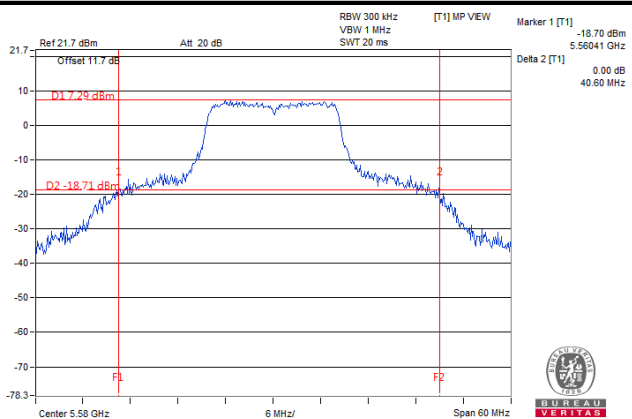

802.11n (HT20)

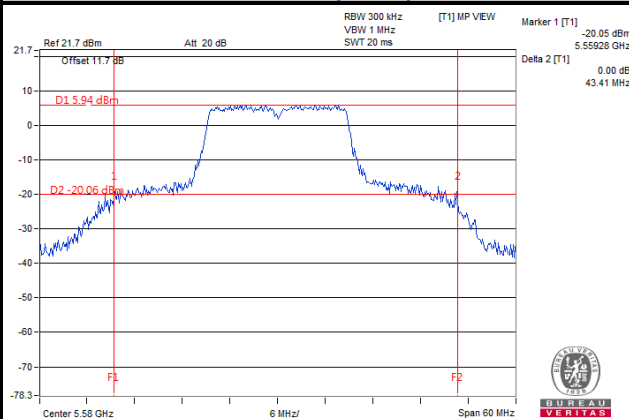

802.11n (HT40)

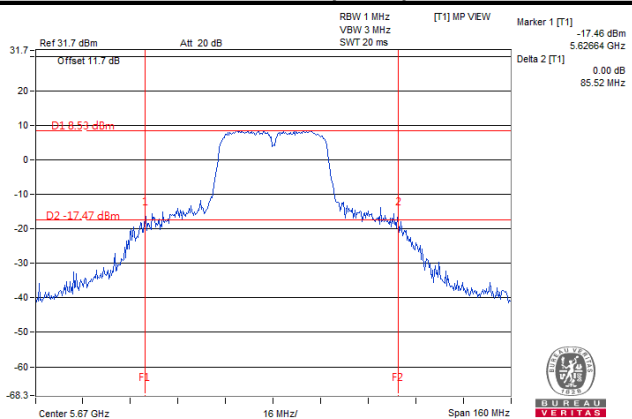

4.4 Occupied Bandwidth Measurement

4.4.1 Test Setup

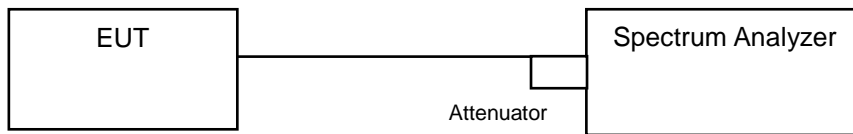

4.4.2 Test Instruments

Refer to section 4.1.2 to get information of above instrument.

4.4.3 Test Procedure

The transmitter output was connected to the spectrum analyzer through an attenuator. The bandwidth of the fundamental frequency was measured by spectrum analyzer with resolution bandwidth in the range of 1 % to 5 % of the anticipated emission bandwidth, and a video bandwidth at least 3x the resolution bandwidth and set the detector to SAMPLE. The width of a frequency band such that, below the lower and above the upper frequency limits, the mean powers emitted are each equal to a specified percentage 0.5 % of the total mean power of a given emission.

4.4.4 Test Results

802.11a

Channel	Channel Frequency (MHz)	Occupied Bandwidth (MHz)
36	5180	18.48
40	5200	19.08
48	5240	19.08
52	5260	19.56
60	5300	19.20
64	5320	18.36
100	5500	17.04
116	5580	17.88
140	5700	16.92
149	5745	16.92
157	5785	18.17
165	5825	18.27

802.11n (HT20)

Channel	Channel Frequency (MHz)	Occupied Bandwidth (MHz)
36	5180	18.72
40	5200	19.44
48	5240	18.12
52	5260	19.80
60	5300	19.20
64	5320	18.84
100	5500	18.00
116	5580	18.36
140	5700	18.12
149	5745	18.17
157	5785	18.46
165	5825	18.36

802.11n (HT40)

Channel	Channel Frequency (MHz)	Occupied Bandwidth (MHz)
38	5190	36.84
46	5230	37.68
54	5270	37.56
62	5310	36.60
102	5510	36.48
110	5550	36.72
134	5670	36.72
151	5755	36.84
159	5795	36.60

Spectrum Plot of Worst Value

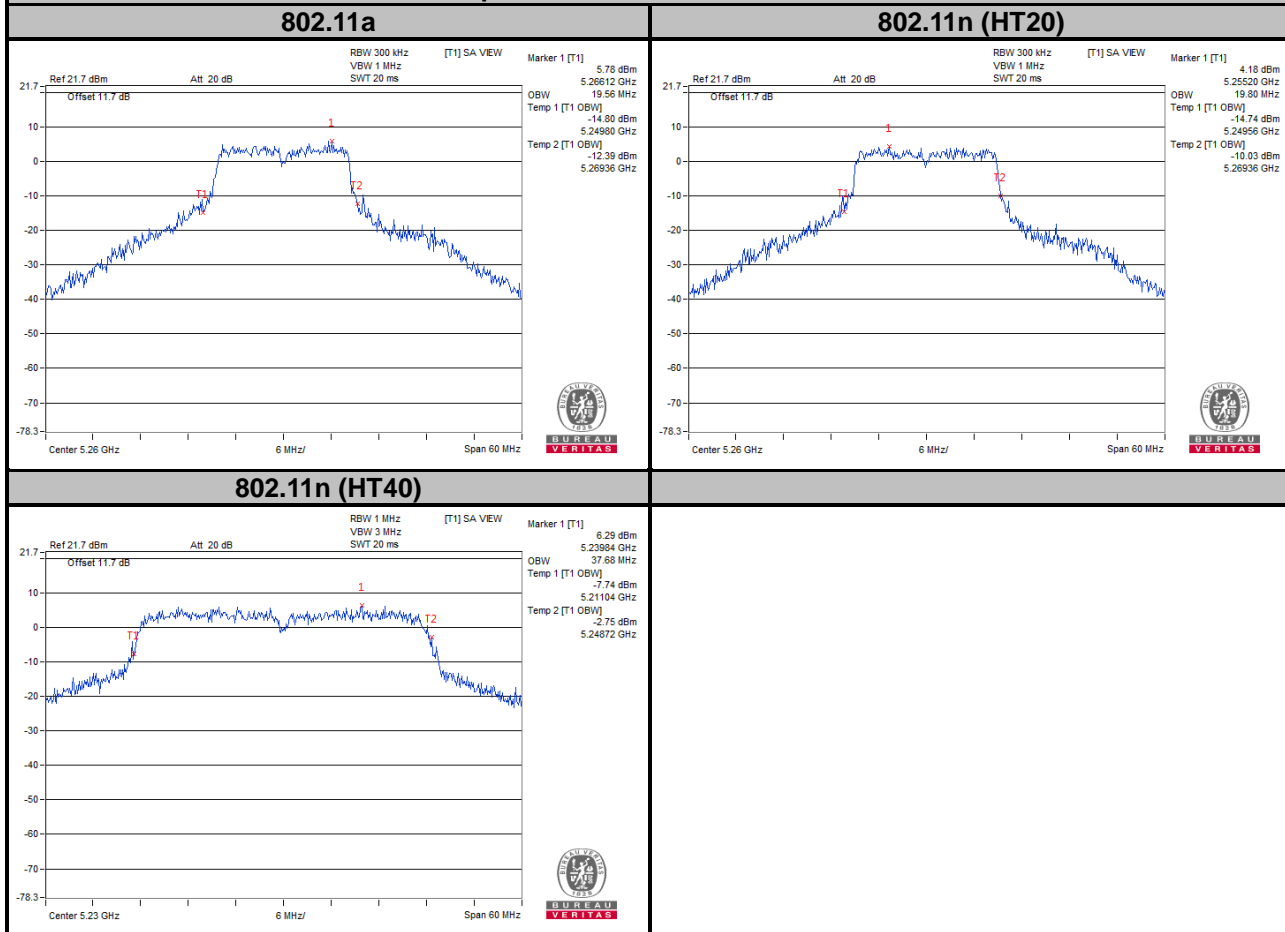

Spectrum Plot for Nearby DFS Band

802.11a

Ch 48 (5240 MHz)

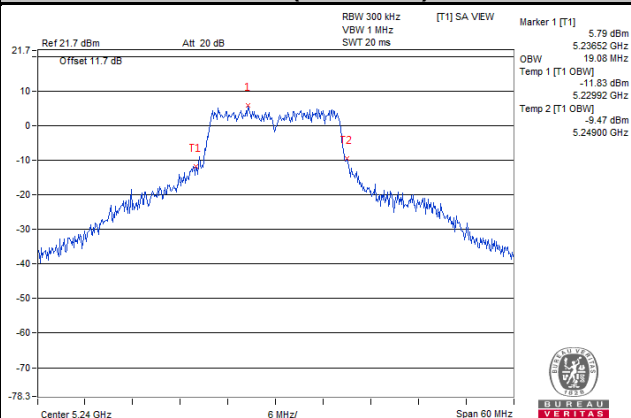

Ch 149 (5745 MHz)

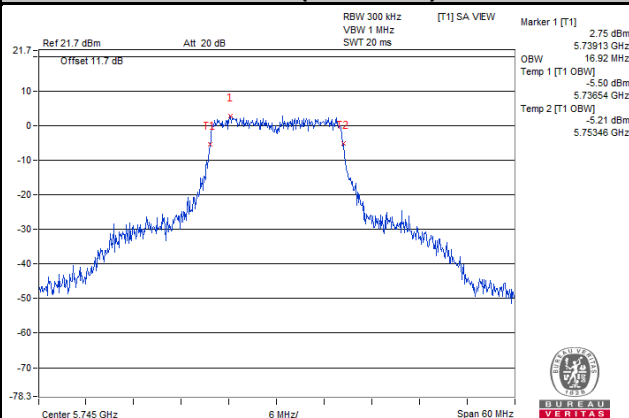

802.11n (HT20)

Ch 48 (5240 MHz)

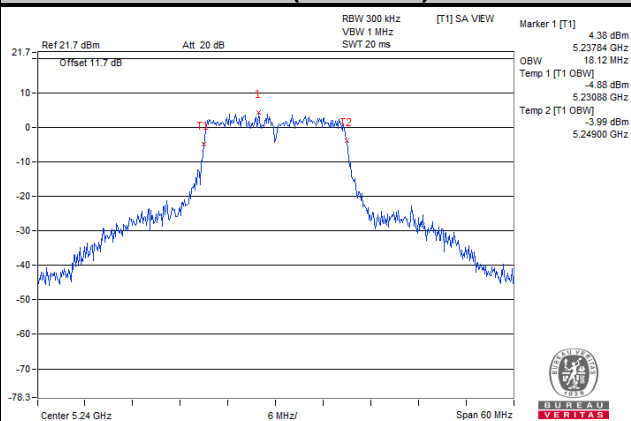

Ch 149 (5745 MHz)

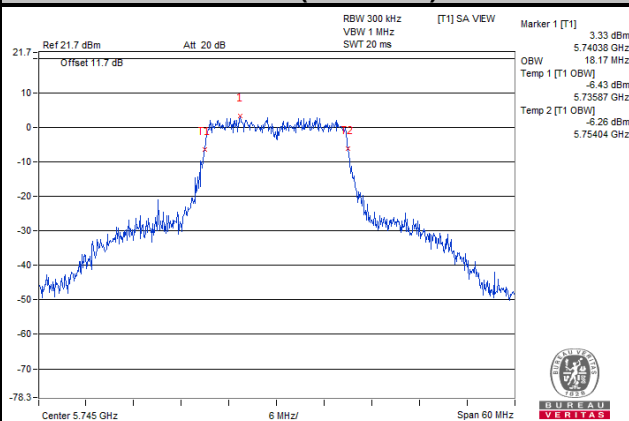

802.11n (HT40)

Ch 46 (5230 MHz)

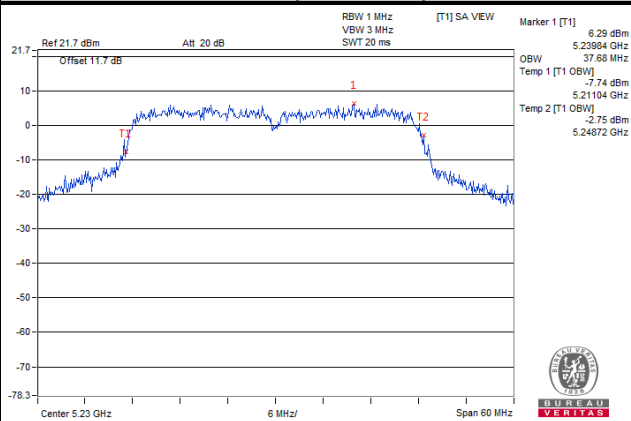

Ch 151 (5755 MHz)

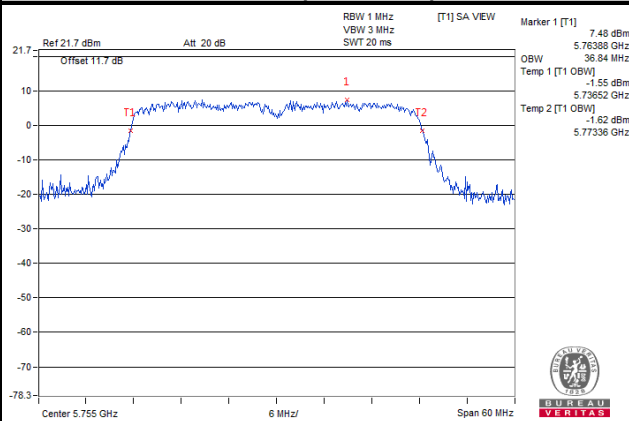

4.5 Peak Power Spectral Density Measurement

4.5.1 Limits of Peak Power Spectral Density Measurement

Operation Band	EUT Category		Limit
U-NII-1		Outdoor Access Point	17 dBm/MHz
		Fixed point-to-point Access Point	
		Indoor Access Point	
	√	Mobile and Portable client device	11 dBm/MHz
U-NII-2A		√	11 dBm/MHz
U-NII-2C		√	11 dBm/MHz
U-NII-3		√	30 dBm/500 kHz

4.5.2 Test Setup

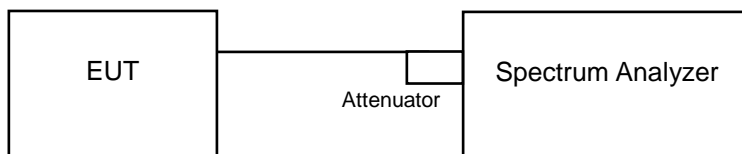

4.5.3 Test Instruments

Refer to section 4.1.3 to get information of above instrument.

4.5.4 Test Procedures

For U-NII-1, U-NII-2A, U-NII-2C band:

Using method SA-2

1. Set span to encompass the entire emission bandwidth (EBW) of the signal.
2. Set RBW = 1 MHz, Set VBW \geq 3 RBW, Detector = RMS
3. Sweep time = auto, trigger set to "free run".
4. Trace average at least 100 traces in power averaging mode.
5. Record the max value and add 10 log (1/duty cycle)

※ For U-NII-3:

1. Set span to encompass the entire emission bandwidth (EBW) of the signal.
2. Set RBW = 300 kHz, Set VBW \geq 1 RBW, Detector = RMS
3. Use the peak marker function to determine the maximum power level in any 300 kHz band segment within the fundamental EBW.
4. Scale the observed power level to an equivalent value in 500 kHz by adjusting (reducing) the measured power by a bandwidth correction factor (BWCF) where $BWCF = 10\log(500 \text{ kHz} / 300 \text{ kHz})$.
5. Sweep time = auto, trigger set to "free run".
6. Trace average at least 100 traces in power averaging mode.
7. Record the max value and add 10 log (1/duty cycle)

4.5.5 Deviation from Test Standard

No deviation.

4.5.6 EUT Operating Conditions

The software provided by client to enable the EUT under transmission condition continuously at lowest, middle and highest channel frequencies individually.

4.5.7 Test Results

For U-NII-1, U-NII-2A, U-NII-2C Band

802.11a

Channel	Frequency (MHz)	PSD w/o Duty Factor (dBm/MHz)	Duty Factor (dB)	PSD with Duty Factor (dBm/MHz)	Maximum Limit (dBm/MHz)	Pass / Fail
36	5180	0.02	0.36	0.38	11	Pass
40	5200	1.31	0.36	1.67	11	Pass
48	5240	1.20	0.36	1.56	11	Pass
52	5260	1.20	0.36	1.56	11	Pass
60	5300	1.18	0.36	1.54	11	Pass
64	5320	-0.52	0.36	-0.16	11	Pass
100	5500	-0.91	0.36	-0.55	11	Pass
116	5580	1.45	0.36	1.81	11	Pass
140	5700	-0.95	0.36	-0.59	11	Pass

Note: Refer to section 3.3 for duty cycle spectrum plot.

802.11n (HT20)

Channel	Frequency (MHz)	PSD w/o Duty Factor (dBm/MHz)	Duty Factor (dB)	PSD with Duty Factor (dBm/MHz)	Maximum Limit (dBm/MHz)	Pass / Fail
36	5180	-0.67	0.33	-0.34	11	Pass
40	5200	0.21	0.33	0.54	11	Pass
48	5240	0.23	0.33	0.56	11	Pass
52	5260	0.22	0.33	0.55	11	Pass
60	5300	0.33	0.33	0.66	11	Pass
64	5320	-0.80	0.33	-0.47	11	Pass
100	5500	-1.19	0.33	-0.86	11	Pass
116	5580	0.40	0.33	0.73	11	Pass
140	5700	-1.14	0.33	-0.81	11	Pass

Note: Refer to section 3.3 for duty cycle spectrum plot.

802.11n (HT40)

Channel	Frequency (MHz)	PSD w/o Duty Factor (dBm/MHz)	Duty Factor (dB)	PSD with Duty Factor (dBm/MHz)	Maximum Limit (dBm/MHz)	Pass / Fail
38	5190	-6.77	0.74	-6.03	11	Pass
46	5230	-4.26	0.74	-3.52	11	Pass
54	5270	-4.13	0.74	-3.39	11	Pass
62	5310	-8.88	0.74	-8.14	11	Pass
102	5510	-7.22	0.74	-6.48	11	Pass
110	5550	-4.53	0.74	-3.79	11	Pass
134	5670	-4.44	0.74	-3.70	11	Pass

Note: Refer to section 3.3 for duty cycle spectrum plot.

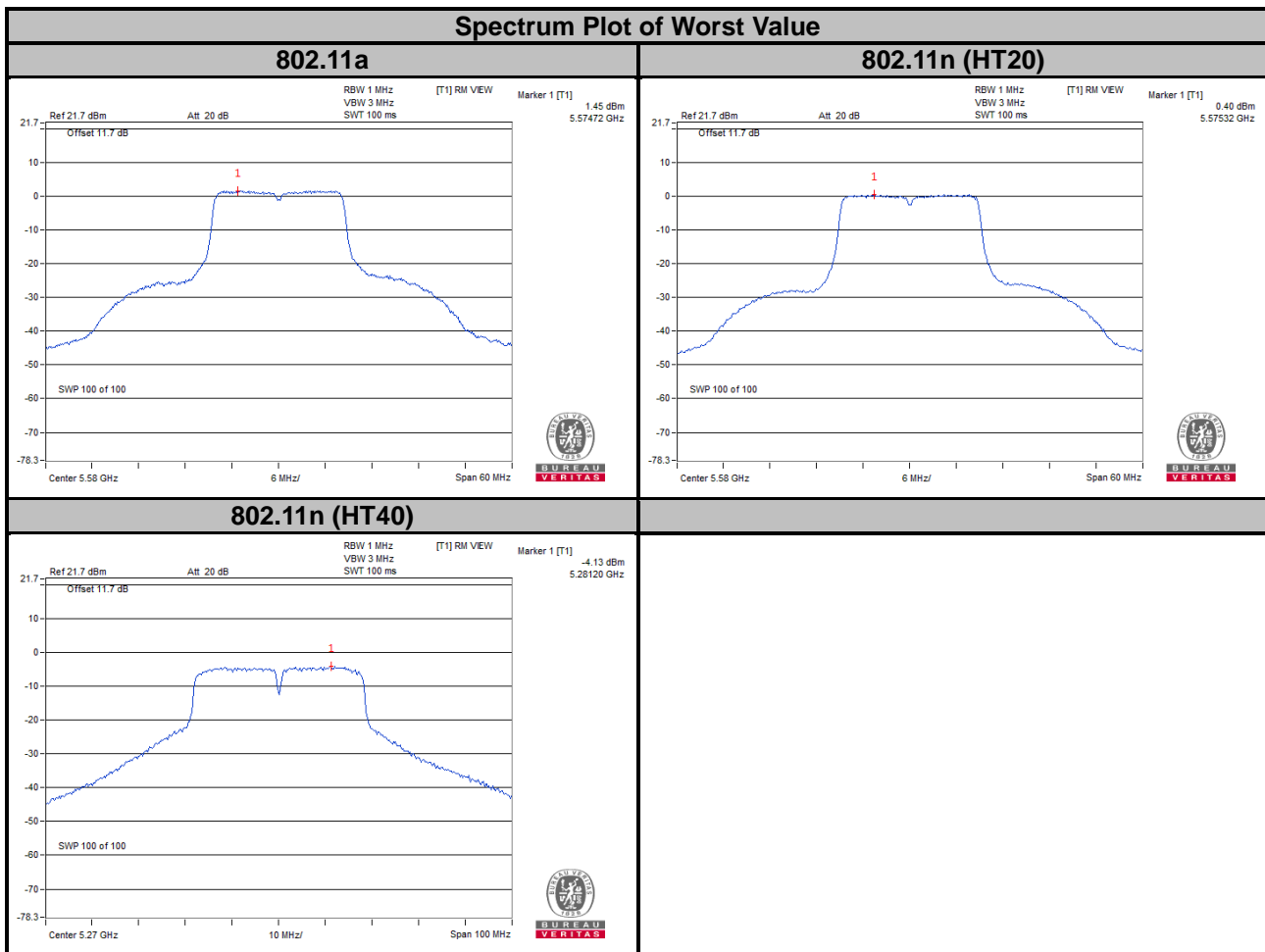

For U-NII-3 Band

802.11a

Channel	Frequency (MHz)	PSD w/o Duty Factor		Duty Factor (dB)	PSD with Duty Factor (dBm/500 kHz)	Limit (dBm/500 kHz)	Pass / Fail
		(dBm/300 kHz)	(dBm/500 kHz)				
149	5745	-9.27	-7.05	0.36	-6.69	30	Pass
157	5785	-6.68	-4.46	0.36	-4.10	30	Pass
165	5825	-6.60	-4.38	0.36	-4.02	30	Pass

Note: Refer to section 3.3 for duty cycle spectrum plot.

802.11n (HT20)

Channel	Frequency (MHz)	PSD w/o Duty Factor		Duty Factor (dB)	PSD with Duty Factor (dBm/500 kHz)	Limit (dBm/500 kHz)	Pass / Fail
		(dBm/300 kHz)	(dBm/500 kHz)				
149	5745	-9.39	-7.17	0.33	-6.84	30	Pass
157	5785	-7.76	-5.54	0.33	-5.21	30	Pass
165	5825	-7.66	-5.44	0.33	-5.11	30	Pass

Note: Refer to section 3.3 for duty cycle spectrum plot.

802.11n (HT40)

Channel	Frequency (MHz)	PSD w/o Duty Factor		Duty Factor (dB)	PSD with Duty Factor (dBm/500 kHz)	Limit (dBm/500 kHz)	Pass / Fail
		(dBm/300 kHz)	(dBm/500 kHz)				
151	5755	-11.89	-9.67	0.74	-8.93	30	Pass
159	5795	-11.96	-9.74	0.74	-9.00	30	Pass

Note: Refer to section 3.3 for duty cycle spectrum plot.

Spectrum Plot of Worst Value

802.11a

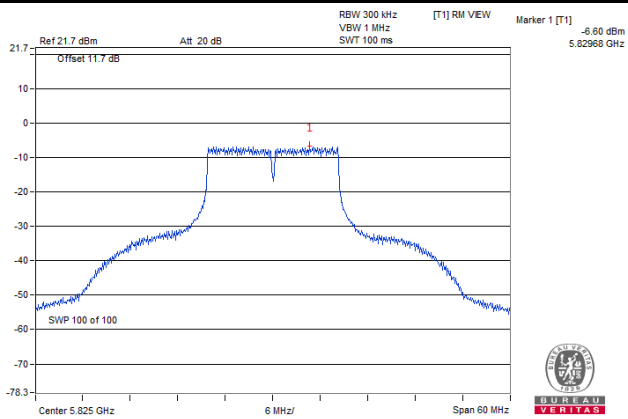

802.11n (HT20)

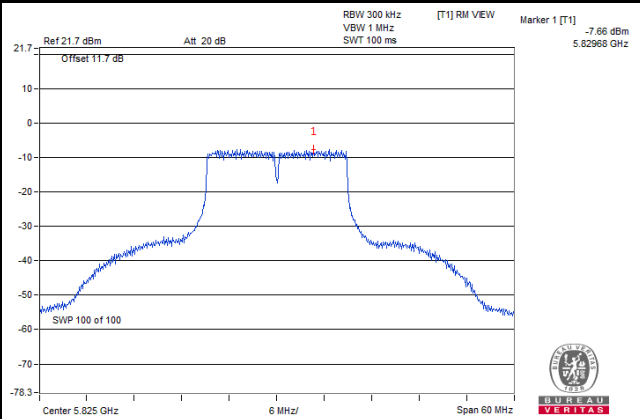

802.11n (HT40)

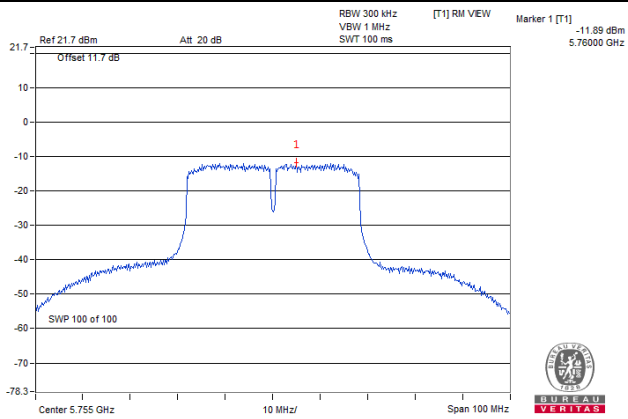

4.6 Frequency Stability

4.6.1 Limit of Frequency Stability Measurement

The frequency of the carrier signal shall be maintained within band of operation.

4.6.2 Test Setup

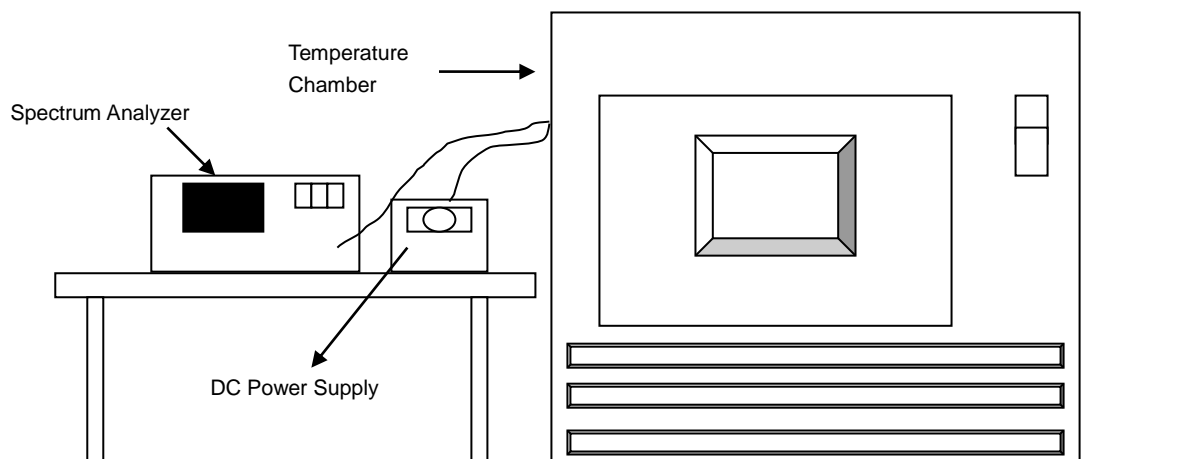

4.6.3 Test Instruments

Refer to section 4.1.3 to get information of above instrument.

4.6.4 Test Procedure

- The EUT was placed inside the environmental test chamber and powered by nominal DC voltage.
- Turn the EUT on and couple its output to a spectrum analyzer.
- Turn the EUT off and set the chamber to the highest temperature specified.
- Allow sufficient time (approximately 30 min) for the temperature of the chamber to stabilize, turn the EUT on and measure the operating frequency after 2, 5, and 10 Minutes.
- Repeat step (d) with the temperature chamber set to the next desired temperature until measurements down to the lowest specified temperature have been completed.
- The test chamber was allowed to stabilize at +20 degree C for a minimum of 30 Minutes. The supply voltage was then adjusted on the EUT from 85% to 115% and the frequency record.

4.6.5 Deviation from Test Standard

No deviation.

4.6.6 EUT Operating Condition

Set the EUT transmit at un-modulation mode to test frequency stability.

4.6.7 Test Results

Frequency Stability Versus Temp.									
Operating Frequency: 5180 MHz									
Temp. (°C)	Power Supply (Vdc)	0 Minute		2 Minute		5 Minute		10 Minute	
		Measured Frequency (MHz)	Result	Measured Frequency (MHz)	Result	Measured Frequency (MHz)	Result	Measured Frequency (MHz)	Result
60	3.8	5180.0111	PASS	5180.0082	PASS	5180.0098	PASS	5180.0096	PASS
50	3.8	5179.9751	PASS	5179.9779	PASS	5179.975	PASS	5179.9774	PASS
40	3.8	5179.9765	PASS	5179.9777	PASS	5179.9794	PASS	5179.9799	PASS
30	3.8	5180.0045	PASS	5180.0025	PASS	5180.0042	PASS	5180.0036	PASS
20	3.8	5180.0245	PASS	5180.0249	PASS	5180.0246	PASS	5180.0217	PASS
10	3.8	5179.9807	PASS	5179.9809	PASS	5179.9825	PASS	5179.9808	PASS
0	3.8	5179.9989	PASS	5179.9965	PASS	5179.9956	PASS	5179.9977	PASS
-10	3.8	5179.9825	PASS	5179.9808	PASS	5179.9852	PASS	5179.9816	PASS
-20	3.8	5180.005	PASS	5180.004	PASS	5180.0025	PASS	5180.0034	PASS

Frequency Stability Versus Voltage									
Operating Frequency: 5180 MHz									
Temp. (°C)	Power Supply (Vdc)	0 Minute		2 Minute		5 Minute		10 Minute	
		Measured Frequency (MHz)	Result	Measured Frequency (MHz)	Result	Measured Frequency (MHz)	Result	Measured Frequency (MHz)	Result
20	4.37	5180.0236	PASS	5180.0245	PASS	5180.0245	PASS	5180.0216	PASS
	3.8	5180.0245	PASS	5180.0249	PASS	5180.0246	PASS	5180.0217	PASS
	3.23	5180.0239	PASS	5180.0244	PASS	5180.024	PASS	5180.0219	PASS

4.7 6 dB Bandwidth Measurement

4.7.1 Limits of 6 dB Bandwidth Measurement

The minimum of 6 dB Bandwidth Measurement is 0.5 MHz.

4.7.2 Test Setup

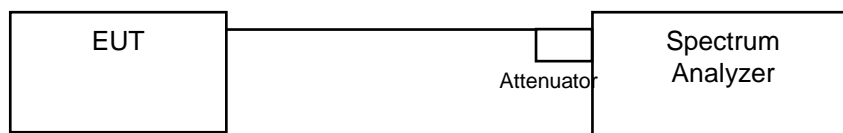

4.7.3 Test Instruments

Refer to section 4.1.3 to get information of above instrument.

4.7.4 Test Procedure

MEASUREMENT PROCEDURE REF

- Set resolution bandwidth (RBW) = 100 kHz
- Set the video bandwidth (VBW) $\geq 3 \times$ RBW, Detector = Peak.
- Trace mode = max hold.
- Sweep = auto couple.
- Measure the maximum width of the emission that is constrained by the frequencies associated with the two amplitude points (upper and lower) that are attenuated by 6 dB relative to the maximum level measured in the fundamental emission

4.7.5 Deviation from Test Standard

No deviation.

4.7.6 EUT Operating Condition

The software provided by client to enable the EUT under transmission condition continuously at lowest, middle and highest channel frequencies individually.

4.7.7 Test Results

802.11a

Channel	Frequency (MHz)	6 dB Bandwidth (MHz)	Minimum Limit (MHz)	Pass / Fail
149	5745	16.40	0.5	Pass
157	5785	16.38	0.5	Pass
165	5825	16.39	0.5	Pass

802.11n (HT20)

Channel	Frequency (MHz)	6 dB Bandwidth (MHz)	Minimum Limit (MHz)	Pass / Fail
149	5745	17.63	0.5	Pass
157	5785	17.63	0.5	Pass
165	5825	17.64	0.5	Pass

802.11n (HT40)

Channel	Frequency (MHz)	6 dB Bandwidth (MHz)	Minimum Limit (MHz)	Pass / Fail
151	5755	35.44	0.5	Pass
159	5795	35.50	0.5	Pass

Spectrum Plot of Worst Value

802.11a

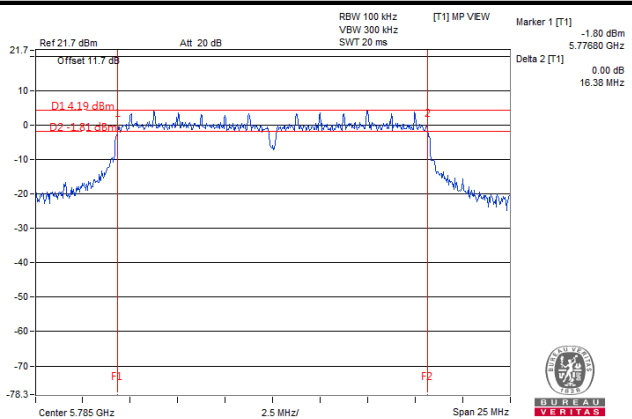

802.11n (HT20)

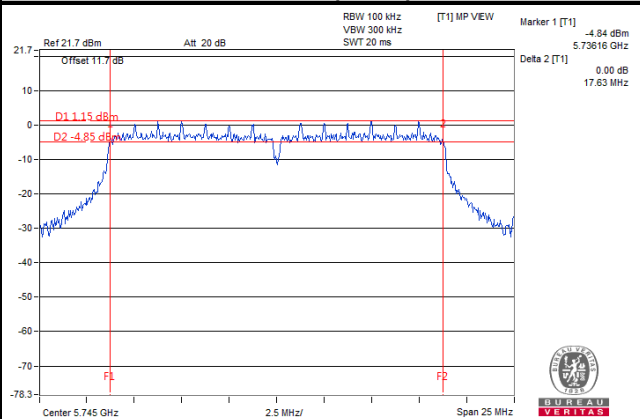

802.11n (HT40)

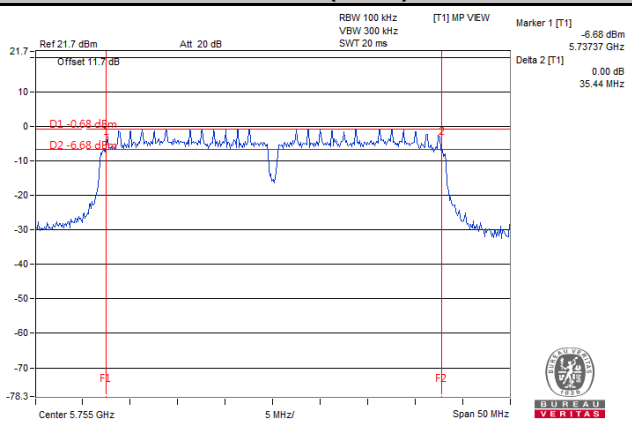

5 Pictures of Test Arrangements

Please refer to the attached file (Test Setup Photo).

Annex A- Radiated Out of Band Emission (OOBE) Measurement (For U-NII-3 band)

802.11a

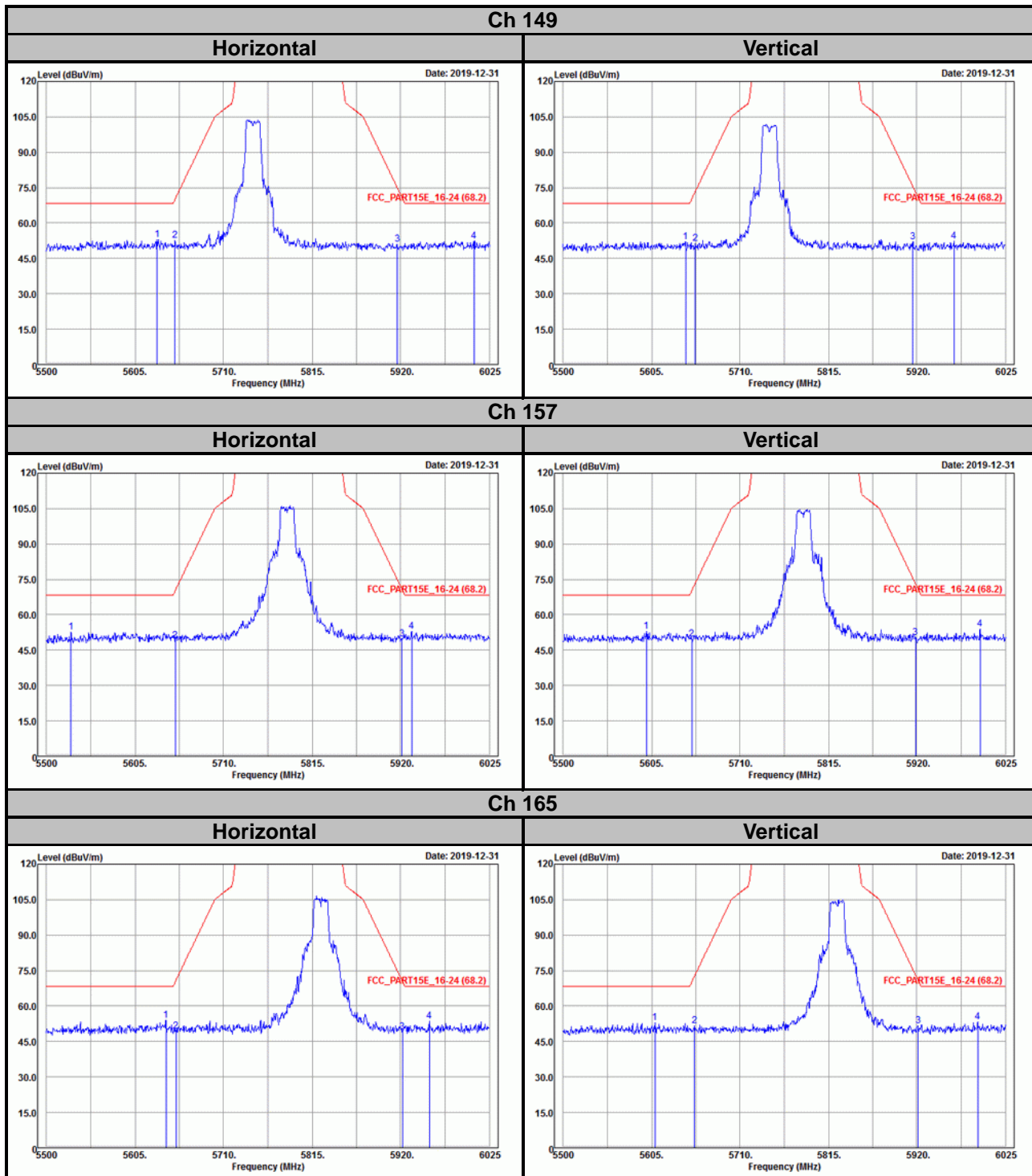

802.11n (HT20)

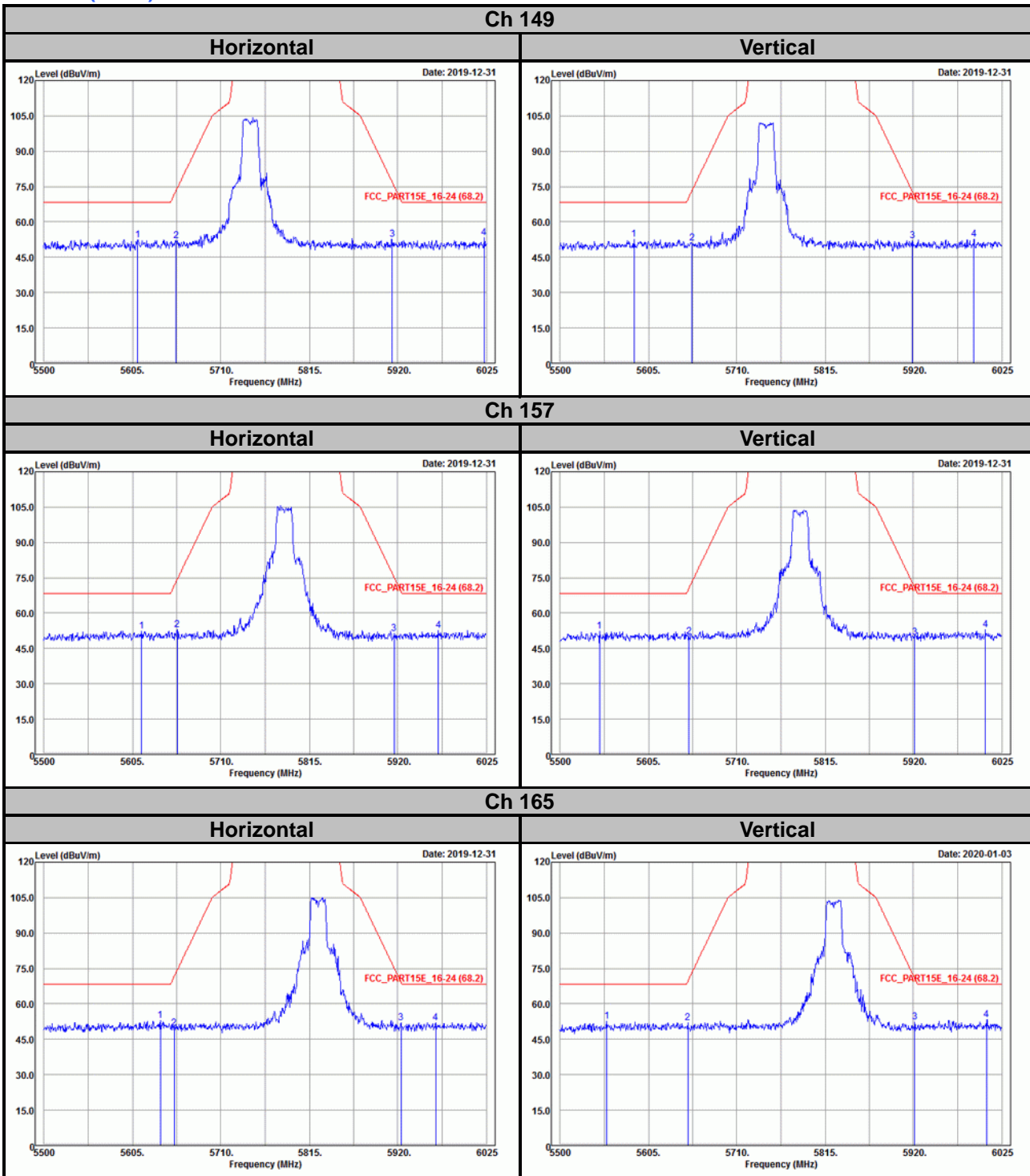

802.11n (HT40)

Ch 151

Horizontal

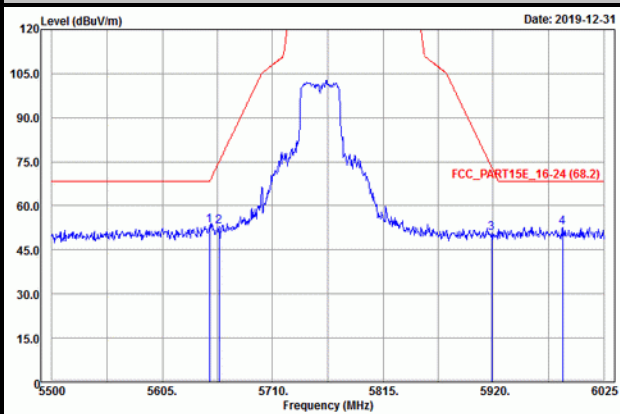

Vertical

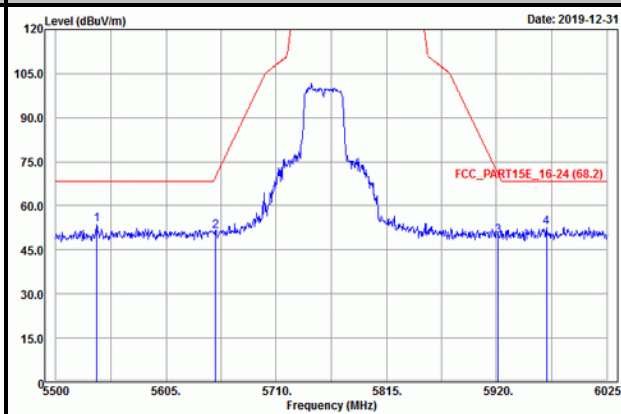

Ch 159

Horizontal

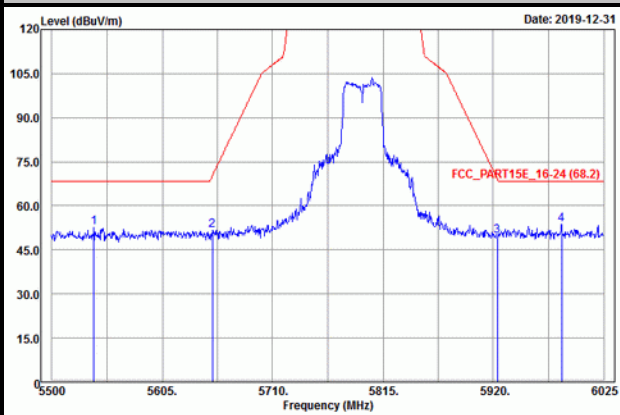

Vertical

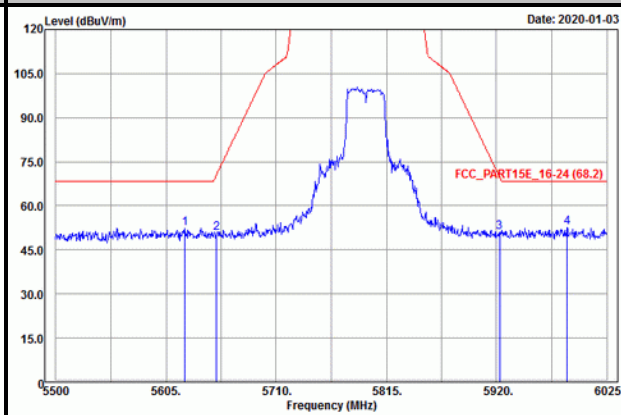

Appendix – Information of the Testing Laboratories

We, Bureau Veritas Consumer Products Services (H.K.) Ltd., Taoyuan Branch, were founded in 1988 to provide our best service in EMC, Radio, Telecom and Safety consultation. Our laboratories are FCC recognized accredited test firms and accredited according to ISO/IEC 17025.

If you have any comments, please feel free to contact us at the following:

Lin Kou EMC/RF Lab

Tel: 886-2-26052180

Fax: 886-2-26051924

Hsin Chu EMC/RF/Telecom Lab

Tel: 886-3-6668565

Fax: 886-3-6668323

Hwa Ya EMC/RF/Safety Lab

Tel: 886-3-3183232

Fax: 886-3-3270892

Email: service.adt@tw.bureauveritas.com

Web Site: www.bureauveritas-adt.com

The address and road map of all our labs can be found in our web site also.

--- END ---