

FCC Test Report

Report No.: RF170328C23-3

FCC ID: V65E4750

Test Model: E4750

Received Date: Mar. 28, 2017

Test Date: Apr. 10, 2017 ~ Apr. 21, 2017

Issued Date: May 02, 2017

Applicant: Kyocera Corporation c/o Kyocera International, Inc.

Address: 8611 Balboa Avenue, San Diego, CA 92123

Issued By: Bureau Veritas Consumer Products Services (H.K.) Ltd., Taoyuan Branch

Lab Address: No. 47-2, 14th Ling, Chia Pau Vil., Lin Kou Dist., New Taipei City, Taiwan
(R.O.C)

Test Location: No. 19, Hwa Ya 2nd Rd, Wen Hwa Tsuen, Kwei Shan Hsiang, Taoyuan
Hsien 333, Taiwan, R.O.C.



This report is for your exclusive use. Any copying or replication of this report to or for any other person or entity, or use of our name or trademark, is permitted only with our prior written permission. This report sets forth our findings solely with respect to the test samples identified herein. The results set forth in this report are not indicative or representative of the quality or characteristics of the lot from which a test sample was taken or any similar or identical product unless specifically and expressly noted. Our report includes all of the tests requested by you and the results thereof based upon the information that you provided to us. You have 60 days from date of issuance of this report to notify us of any material error or omission caused by our negligence, provided, however, that such notice shall be in writing and shall specifically address the issue you wish to raise. A failure to raise such issue within the prescribed time shall constitute your unqualified acceptance of the completeness of this report, the tests conducted and the correctness of the report contents. Unless specific mention, the uncertainty of measurement has been explicitly taken into account to declare the compliance or non-compliance to the specification. The report must not be used by the client to claim product certification, approval, or endorsement by TAF or any government agencies.

Table of Contents

Release Control Record	4
1 Certificate of Conformity	5
2 Summary of Test Results.....	6
2.1 Measurement Uncertainty.....	6
2.2 Modification Record	6
3 General Information	7
3.1 General Description of EUT	7
3.2 Description of Test Modes.....	8
3.2.1 Test Mode Applicability and Tested Channel Detail.....	10
3.3 Duty Cycle of Test Signal	12
3.4 Description of Support Units	13
3.4.1 Configuration of System under Test	13
3.5 General Description of Applied Standards.....	13
4 Test Types and Results	14
4.1 Radiated Emission and Bandedge Measurement	14
4.1.1 Limits of Radiated Emission and Bandedge Measurement	14
4.1.2 Limits of Unwanted Emission Out of the Restricted Bands	15
4.1.3 Test Instruments	16
4.1.4 Test Procedures.....	17
4.1.5 Deviation from Test Standard	17
4.1.6 Test Set Up	18
4.1.7 EUT Operating Conditions.....	19
4.1.8 Test Results	20
4.2 Conducted Emission Measurement.....	54
4.2.1 Limits of Conducted Emission Measurement	54
4.2.2 Test Instruments	54
4.2.3 Test Procedures.....	55
4.2.4 Deviation from Test Standard	55
4.2.5 Test Setup.....	55
4.2.6 EUT Operating Conditions.....	55
4.2.7 Test Results	56
4.3 Transmit Power Measurement.....	58
4.3.1 Limits of Transmit Power Measurement	58
4.3.2 Test Setup.....	58
4.3.3 Test Instruments	59
4.3.4 Test Procedure	59
4.3.5 Deviation from Test Standard	59
4.3.6 EUT Operating Conditions.....	59
4.3.7 Test Result	60
4.4 Peak Power Spectral Density Measurement	65
4.4.1 Limits of Peak Power Spectral Density Measurement	65
4.4.2 Test Setup.....	65
4.4.3 Test Instruments	65
4.4.4 Test Procedures.....	66
4.4.5 Deviation from Test Standard	66
4.4.6 EUT Operating Conditions.....	66
4.4.7 Test Results	67
4.5 Frequency Stability	71
4.5.1 Limit of Frequency Stability Measurement	71
4.5.2 Test Setup.....	71
4.5.3 Test Instruments	71
4.5.4 Test Procedure	71
4.5.5 Deviation from Test Standard	71

4.5.6 EUT Operating Condition	71
4.5.7 Test Results	72
4.6 6 dB Bandwidth Measurement.....	73
4.6.1 Limits of 6 dB Bandwidth Measurement.....	73
4.6.2 Test Setup.....	73
4.6.3 Test Instruments	73
4.6.4 Test Procedure	73
4.6.5 Deviation from Test Standard	73
4.6.6 EUT Operating Condition	73
4.6.7 Test Results	74
5 Pictures of Test Arrangements.....	76
Annex A- Radiated Out of Band Emisison (OOBE) Measurement (For U-NII-3 band)	77
Appendix – Information on the Testing Laboratories	80

Release Control Record

Issue No.	Description	Date Issued
RF170328C23-3	Original Release	May 02, 2017

1 Certificate of Conformity

Product: Feature Phone

Brand: KYOCERA

Test Model: E4750

Sample Status: Identical Prototype

Applicant: Kyocera Corporation c/o Kyocera International, Inc.

Test Date: Apr. 10, 2017 ~ Apr. 21, 2017

Standards: 47 CFR FCC Part 15, Subpart E (Section 15.407)
ANSI C63.10:2013

The above equipment has been tested by **Bureau Veritas Consumer Products Services (H.K.) Ltd., Taoyuan Branch**, and found compliance with the requirement of the above standards. The test record, data evaluation & Equipment Under Test (EUT) configurations represented herein are true and accurate accounts of the measurements of the sample's EMC characteristics under the conditions specified in this report.

Prepared by : Evonne Liu , **Date:** May 02, 2017
Evonne Liu / Specialist

Approved by : David Huang , **Date:** May 02, 2017
David Huang / Project Engineer

2 Summary of Test Results

47 CFR FCC Part 15, Subpart E (Section 15.407)			
FCC Clause	Test Item	Result	Remarks
15.407(b)(6)	AC Power Conducted Emissions	Pass	Meet the requirement of limit. Minimum passing margin is -10.30 dB at 0.17328 MHz.
15.407(b) (1/2/3/4(i/ii)/6)	Radiated Emissions & Band Edge Measurement	Pass	Meet the requirement of limit. Minimum passing margin is -2.4 dB at 11000.00 MHz.
15.407(a)(1/2/3)	Max Average Transmit Power	Pass	Meet the requirement of limit.
15.407(a)(1/2/3)	Peak Power Spectral Density	Pass	Meet the requirement of limit.
15.407(e)	6 dB Bandwidth	Pass	Meet the requirement of limit. (U-NII-3 Band only)
15.407(g)	Frequency Stability	Pass	Meet the requirement of limit.
15.203	Antenna Requirement	Pass	No antenna connector is used.

*For U-NII-3 band compliance with rule part 15.407(b)(4)(i), the OOB test plots were recorded in Annex A.

2.1 Measurement Uncertainty

Where relevant, the following measurement uncertainty levels have been estimated for tests performed on the EUT as specified in CISPR 16-4-2:

Measurement	Frequency	Expanded Uncertainty (k=2) (±)
Conducted Emissions at mains ports	150 kHz ~ 30 MHz	2.44 dB
Radiated Emissions up to 1 GHz	30MHz ~ 200MHz	3.59 dB
	200MHz ~ 1000MHz	3.60 dB
Radiated Emissions above 1 GHz	1GHz ~ 18GHz	2.29 dB
	18GHz ~ 40GHz	2.29 dB

2.2 Modification Record

There were no modifications required for compliance.

3 General Information

3.1 General Description of EUT

Product	Feature Phone
Brand	KYOCERA
Test Model	E4750
Status of EUT	Identical Prototype
Power Supply Rating	5.0 Vdc (adapter) 3.8 Vdc (Li-ion battery)
Modulation Type	64QAM, 16QAM, QPSK, BPSK
Modulation Technology	OFDM
Transfer Rate	802.11a: 54.0/ 48.0/ 36.0/ 24.0/ 18.0/ 12.0/ 9.0/ 6.0 Mbps 802.11n: up to MCS7
Operating Frequency	5180 ~ 5240 MHz, 5260 ~ 5320 MHz, 5500 ~ 5700 MHz, 5745 ~ 5825 MHz
Number of Channel	5180 ~ 5240 MHz: 4 for 802.11a, 802.11n (HT20) 2 for 802.11n (HT40) 5260 ~ 5320 MHz: 4 for 802.11a, 802.11n (HT20) 2 for 802.11n (HT40) 5500 ~ 5700 MHz: 11 for 802.11a, 802.11n (HT20) 5 for 802.11n (HT40) 5745 ~ 5825 MHz: 5 for 802.11a, 802.11n (HT20) 2 for 802.11n (HT40)
Output Power	83.56 mW for 5180 ~ 5240 MHz 83.753 mW for 5260 ~ 5320 MHz 83.946 mW for 5500 ~ 5700 MHz 94.406 mW for 5745 ~ 5825 MHz
Antenna Type	Fixed Internal antenna with 1.9 dBi gain (5180 ~ 5240 MHz) Fixed Internal antenna with 1 dBi gain (5260 ~ 5320 MHz) Fixed Internal antenna with 1 dBi gain (5500 ~ 5700 MHz) Fixed Internal antenna with -0.2 dBi gain (5745 ~ 5825 MHz)
Antenna Connector	N/A
Accessory Device	Refer to Note as below
Data Cable Supplied	Refer to Note as below

Note:

- The EUT provides 1 completed transmitter and 1 receiver.

Modulation Mode	Tx Function
802.11a	1TX
802.11n (HT20)	1TX
802.11n (HT40)	1TX

- The EUT contains following accessory devices.

Product	Brand	Model	Description
Adapter	KYOCERA	SCP-50ADT	I/P: 100-240 Vac, 50/60 Hz, 0.25 A O/P: 5 Vdc, 1.5 A
Battery	KYOCERA	SCP-71LBPS	3.8 Vdc, 11.02 Wh
USB Cable	KYOCERA	SCP-22SDC	1 m shielded cable w/o core

3. The above EUT information is declared by manufacturer and for more detailed features description, please refer to the manufacturer's specifications or user's manual.

3.2 Description of Test Modes

For 5180 ~ 5240 MHz

4 channels are provided for 802.11a, 802.11n (HT20):

Channel	Frequency (MHz)	Channel	Frequency (MHz)
36	5180	44	5220
40	5200	48	5240

2 channels are provided for 802.11n (HT40):

Channel	Frequency (MHz)	Channel	Frequency (MHz)
38	5190	46	5230

For 5260 ~ 5320 MHz

4 channels are provided for 802.11a, 802.11n (HT20):

Channel	Frequency (MHz)	Channel	Frequency (MHz)
52	5260	60	5300
56	5280	64	5320

2 channels are provided for 802.11n (HT40):

Channel	Frequency (MHz)	Channel	Frequency (MHz)
54	5270	62	5310

For 5500 ~ 5700 MHz

11 channels are provided for 802.11a, 802.11n (HT20):

Channel	Frequency (MHz)	Channel	Frequency (MHz)
100	5500	124	5620
104	5520	128	5640
108	5540	132	5660
112	5560	136	5680
116	5580	140	5700
120	5600		

5 channels are provided for 802.11n (HT40):

Channel	Frequency (MHz)	Channel	Frequency (MHz)
102	5510	126	5630
110	5550	134	5670
118	5590		

For 5745 ~ 5825 MHz:

5 channels are provided for 802.11a, 802.11n (HT20):

Channel	Frequency (MHz)	Channel	Frequency (MHz)
149	5745	161	5805
153	5765	165	5825
157	5785		

2 channels are provided for 802.11n (HT40):

Channel	Frequency (MHz)	Channel	Frequency (MHz)
151	5755	159	5795

3.2.1 Test Mode Applicability and Tested Channel Detail

EUT Configure Mode	Applicable To				Description
	RE \geq 1G	RE $<$ 1G	PLC	APCM	
-	√	√	√	√	-

Where **RE \geq 1G**: Radiated Emission above 1 GHz **RE $<$ 1G**: Radiated Emission below 1 GHz
PLC: Power Line Conducted Emission **APCM**: Antenna Port Conducted Measurement

Note:

1. The EUT had been pre-tested on the positioned of each 3 axis. The worst case was found when positioned on **X-plane**.

Radiated Emission Test (Above 1 GHz):

- Pre-Scan has been conducted to determine the worst-case mode from all possible combinations between available modulations, data rates and antenna ports (if EUT with antenna diversity architecture).
- Following channel(s) was (were) selected for the final test as listed below.

EUT Configure Mode	Frequency Band (MHz)	Mode	Available Channel	Tested Channel	Modulation Technology	Modulation Type	Data Rate (Mbps)
-	5180-5240	802.11a	36 to 48	36, 44, 48	OFDM	BPSK	6.0
-		802.11n (HT20)	36 to 48	36, 44, 48	OFDM	BPSK	MCS0
-		802.11n (HT40)	38 to 46	38, 46	38, 46	OFDM	BPSK
-	5260-5320	802.11a	52 to 64	52, 60, 64	OFDM	BPSK	6.0
-		802.11n (HT20)	52 to 64	52, 60, 64	OFDM	BPSK	MCS0
-		802.11n (HT40)	54 to 62	54, 62	54, 62	OFDM	BPSK
-	5500-5700	802.11a	100 to 140	100, 116, 140	OFDM	BPSK	6.0
-		802.11n (HT20)	100 to 140	100, 116, 140	OFDM	BPSK	MCS0
-		802.11n (HT40)	102 to 134	102, 110, 134	102, 110, 134	OFDM	BPSK
-	5745-5825	802.11a	149 to 165	149, 157, 165	OFDM	BPSK	6.0
-		802.11n (HT20)	149 to 165	149, 157, 165	OFDM	BPSK	MCS0
-		802.11n (HT40)	151 to 159	151, 159	151, 159	OFDM	BPSK

Radiated Emission Test (Below 1 GHz):

- Pre-Scan has been conducted to determine the worst-case mode from all possible combinations between available modulations, data rates and antenna ports (if EUT with antenna diversity architecture).
- Following channel(s) was (were) selected for the final test as listed below.

EUT Configure Mode	Frequency Band (MHz)	Mode	Available Channel	Tested Channel	Modulation Technology	Modulation Type	Data Rate (Mbps)
-	5500-5700	802.11a	100 to 140	100	OFDM	BPSK	6.0

Power Line Conducted Emission Test:

- Pre-Scan has been conducted to determine the worst-case mode from all possible combinations between available modulations, data rates and antenna ports (if EUT with antenna diversity architecture).
- Following channel(s) was (were) selected for the final test as listed below.

EUT Configure Mode	Frequency Band (MHz)	Mode	Available Channel	Tested Channel	Modulation Technology	Modulation Type	Data Rate (Mbps)
-	5180-5320	802.11a	36 to 64	62	OFDM	BPSK	6.0

Antenna Port Conducted Measurement:

- This item includes all test value of each mode, but only includes spectrum plot of worst value of each mode.
- Pre-Scan has been conducted to determine the worst-case mode from all possible combinations between available modulations, data rates and antenna ports (if EUT with antenna diversity architecture).
- Following channel(s) was (were) selected for the final test as listed below.

EUT Configure Mode	Frequency Band (MHz)	Mode	Available Channel	Tested Channel	Modulation Technology	Modulation Type	Data Rate (Mbps)
-	5180-5240	802.11a	36 to 48	36, 44, 48	OFDM	BPSK	6.0
-		802.11n (HT20)	36 to 48	36, 44, 48	OFDM	BPSK	MCS0
-		802.11n (HT40)	38 to 46	38, 46	OFDM	BPSK	MCS0
-	5260-5320	802.11a	52 to 64	52, 60, 64	OFDM	BPSK	6.0
-		802.11n (HT20)	52 to 64	52, 60, 64	OFDM	BPSK	MCS0
-		802.11n (HT40)	54 to 62	54, 62	OFDM	BPSK	MCS0
-	5500-5700	802.11a	100 to 140	100, 116, 140	OFDM	BPSK	6.0
-		802.11n (HT20)	100 to 140	100, 116, 140	OFDM	BPSK	MCS0
-		802.11n (HT40)	102 to 134	102, 110, 134	OFDM	BPSK	MCS0
-	5745-5825	802.11a	149 to 165	149, 157, 165	OFDM	BPSK	6.0
-		802.11n (HT20)	149 to 165	149, 157, 165	OFDM	BPSK	MCS0
-		802.11n (HT40)	151 to 159	151, 159	OFDM	BPSK	MCS0

Test Condition:

Applicable To	Environmental Conditions	Input Power	Tested by
RE \geq 1G	25 deg. C, 65 % RH	120 Vac, 60 Hz	Bond Tseng
RE<1G	25 deg. C, 65 % RH	120 Vac, 60 Hz	Bond Tseng
PLC	25 deg. C, 65 % RH	120 Vac, 60 Hz	Wayne Lin
APCM	25 deg. C, 65 % RH	3.8 Vdc	Getaz Yang

3.3 Duty Cycle of Test Signal

MODULATION TYPE: BPSK

802.11a: Duty cycle of test signal is > 98 %, duty factor is not required.

802.11n (HT20): Duty cycle of test signal is > 98 %, duty factor is not required.

802.11n (HT40): Duty cycle of test signal is > 98 %, duty factor is not required.



3.4 Description of Support Units

The EUT has been tested as an independent unit together with other necessary accessories or support units.

3.4.1 Configuration of System under Test

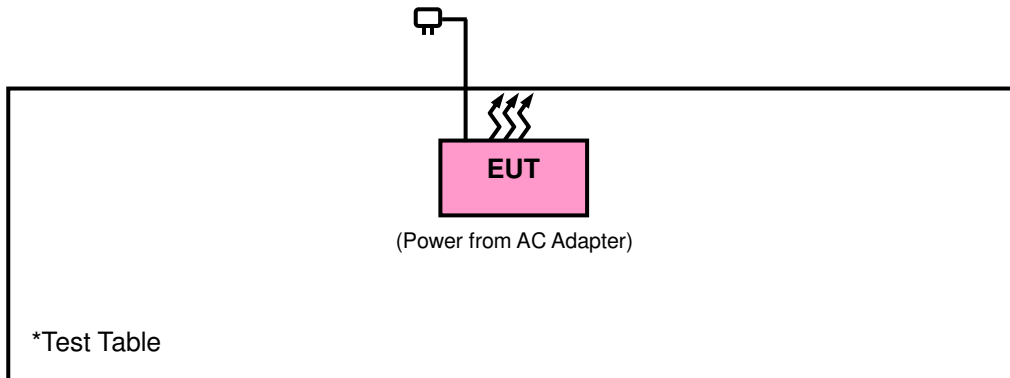

3.5 General Description of Applied Standards

The EUT is a RF Product. According to the specifications of the manufacturer, it must comply with the requirements of the following standards:

FCC Part 15, Subpart E (15.407)

789033 D02 General UNII Test Procedures New Rules v01r03

ANSI C63.10-2013

All test items have been performed and recorded as per the above standards.

Note: The EUT has been verified to comply with the requirements of FCC Part 15, Subpart B, Class B (DoC).
The test report has been issued separately.

4 Test Types and Results

4.1 Radiated Emission and Bandedge Measurement

4.1.1 Limits of Radiated Emission and Bandedge Measurement

Radiated emissions which fall in the restricted bands must comply with the radiated emission limits specified as below table. Other emissions shall be at least 20 dB below the highest level of the desired power:

Frequencies (MHz)	Field Strength (microvolts/meter)	Measurement Distance (meters)
0.009 ~ 0.490	2400/F (kHz)	300
0.490 ~ 1.705	24000/F (kHz)	30
1.705 ~ 30.0	30	30
30 ~ 88	100	3
88 ~ 216	150	3
216 ~ 960	200	3
Above 960	500	3

Note:

1. The lower limit shall apply at the transition frequencies.
2. Emission level (dBuV/m) = 20 log Emission level (uV/m).
3. For frequencies above 1000 MHz, the field strength limits are based on average detector, however, the peak field strength of any emission shall not exceed the maximum permitted average limits, specified above by more than 20 dB under any condition of modulation.

4.1.2 Limits of Unwanted Emission Out of the Restricted Bands

Applicable To		Limit	
789033 D02 General UNII Test Procedures New Rules v01r03		Field Strength at 3 m	
		PK: 74 (dBμV/m)	AV: 54 (dBμV/m)
Frequency Band	Applicable To	EIRP Limit	Equivalent Field Strength at 3 m
5150~5250 MHz	15.407(b)(1)	PK: -27 (dBm/MHz)	PK: 68.2 (dBμV/m)
5250~5350 MHz	15.407(b)(2)		
5470~5725 MHz	15.407(b)(3)		
5725~5850 MHz	15.407(b)(4)(i)	PK:-27 (dBm/MHz) ^{*1} PK:10 (dBm/MHz) ^{*2} PK:15.6 (dBm/MHz) ^{*3} PK:27 (dBm/MHz) ^{*4}	PK: 68.2 (dBμV/m) ^{*1} PK:105.2 (dBμV/m) ^{*2} PK: 110.8 (dBμV/m) ^{*3} PK:122.2 (dBμV/m) ^{*4}
	15.407(b)(4)(ii)	Emission limits in section 15.247(d)	
^{*1} beyond 75 MHz or more above of the band edge. ^{*2} below the band edge increasing linearly to 10 dBm/MHz at 25 MHz above. ^{*3} below the band edge increasing linearly to a level of 15.6 dBm/MHz at 5 MHz above. ^{*4} from 5 MHz above or below the band edge increasing linearly to a level of 27 dBm/MHz at the band edge.			

Note:

The following formula is used to convert the equipment isotropic radiated power (eirp) to field strength:

$$E = \frac{1000000\sqrt{30P}}{3} \mu\text{V/m, where } P \text{ is the eirp (Watts).}$$

4.1.3 Test Instruments

Description & Manufacturer	Model No.	Serial No.	Cal. Date	Cal. Due
Test Receiver ROHDE & SCHWARZ	ESCI	100424	Oct. 24, 2016	Oct. 23, 2017
Spectrum Analyzer ROHDE & SCHWARZ	FSP40	100040	Aug. 16, 2016	Aug. 15, 2017
BILOG Antenna SCHWARZBECK	VULB9168	9168-155	Dec. 28, 2016	Dec. 27, 2017
HORN Antenna SCHWARZBECK	BBHA 9120D	9120D-1170	Dec. 15, 2016	Dec. 14, 2017
HORN Antenna SCHWARZBECK	BBHA 9170	BBHA9170241	Dec. 14, 2016	Dec. 13, 2017
Loop Antenna	EM-6879	269	Aug. 11, 2016	Aug. 10, 2017
Preamplifier Agilent	8449B	3008A01960	Aug. 09, 2016	Aug. 08, 2017
Preamplifier Agilent	8447D	2944A10631	Aug. 09, 2016	Aug. 08, 2017
RF signal cable HUBER+SUHNER	SUCOFLEX 104	MY 13380+295012/04	Aug. 09, 2016	Aug. 08, 2017
RF signal cable HUBER+SUHNER	SUCOFLEX 104	Cable-CH4-03 (250724)	Aug. 09, 2016	Aug. 08, 2017
Software BV ADT	ADT_Radiated_ V7.6.15.9.4	NA	NA	NA
Antenna Tower inn-co GmbH	MA 4000	010303	NA	NA
Antenna Tower Controller BV ADT	AT100	AT93021703	NA	NA
Turn Table BV ADT	TT100	TT93021703	NA	NA
Turn Table Controller BV ADT	SC100	SC93021703	NA	NA
High Speed Peak Power Meter	ML2495A	0824012	Aug. 11, 2016	Aug. 10, 2017
Power Sensor	MA2411B	0738171	Aug. 11, 2016	Aug. 10, 2017

- Note: 1. The calibration interval of the above test instruments is 12 months and the calibrations are traceable to NML/ROC and NIST/USA.
2. The test was performed in HwaYa Chamber 4.
3. The horn antenna and preamplifier (model: 8449B) are used only for the measurement of emission frequency above 1GHz if tested.
4. The FCC Site Registration No. is 460141.
5. The IC Site Registration No. is IC7450F-4.

4.1.4 Test Procedures

For Radiated emission below 30MHz

- a. The EUT was placed on the top of a rotating table 0.8 meters above the ground at a 3 meter chamber room. The table was rotated 360 degrees to determine the position of the highest radiation.
- b. The EUT was set 3 meters away from the interference-receiving antenna, which was mounted on the top of a variable-height antenna tower.
- c. Both X and Y axes of the antenna are set to make the measurement.
- d. For each suspected emission, the EUT was arranged to its worst case and the rotatable table was turned from 0 degrees to 360 degrees to find the maximum reading.
- e. The test-receiver system was set to Quasi-Peak Detect Function and Specified Bandwidth with Maximum Hold Mode.

Note:

1. The resolution bandwidth and video bandwidth of test receiver/spectrum analyzer is 9kHz at frequency below 30MHz.

For Radiated emission above 30MHz

- a. The EUT was placed on the top of a rotating table 0.8 meters (for 30MHz ~ 1GHz) / 1.5 meters (for above 1GHz) above the ground at 3 meter chamber room for test. The table was rotated 360 degrees to determine the position of the highest radiation.
- b. The EUT was set 3 meters away from the interference-receiving antenna, which was mounted on the top of a variable-height antenna tower.
- c. The height of antenna is varied from one meter to four meters above the ground to determine the maximum value of the field strength. Both horizontal and vertical polarizations of the antenna are set to make the measurement.
- d. For each suspected emission, the EUT was arranged to its worst case and then the antenna was tuned to heights from 1 meter to 4 meters and the rotatable table was turned from 0 degrees to 360 degrees to find the maximum reading.
- e. The test-receiver system was set to quasi-peak detect function and specified bandwidth with maximum hold mode when the test frequency is below 1 GHz.
- f. The test-receiver system was set to peak and average detect function and specified bandwidth with maximum hold mode when the test frequency is above 1 GHz. If the peak reading value also meets average limit, measurement with the average detector is unnecessary.

Note:

1. The resolution bandwidth and video bandwidth of test receiver/spectrum analyzer is 120kHz for Quasi-peak detection (QP) at frequency below 1GHz.
2. The resolution bandwidth of test receiver/spectrum analyzer is 1 MHz and the video bandwidth is 3 MHz for Peak detection (PK) at frequency above 1GHz.
3. The resolution bandwidth of test receiver/spectrum analyzer is 1MHz and the video bandwidth is $\geq 1/T$ (Duty cycle < 98%) or 10Hz (Duty cycle $\geq 98\%$) for Average detection (AV) at frequency above 1GHz.
4. All modes of operation were investigated and the worst-case emissions are reported.

4.1.5 Deviation from Test Standard

No deviation.

4.1.6 Test Set Up

<Radiated emission below 30MHz>

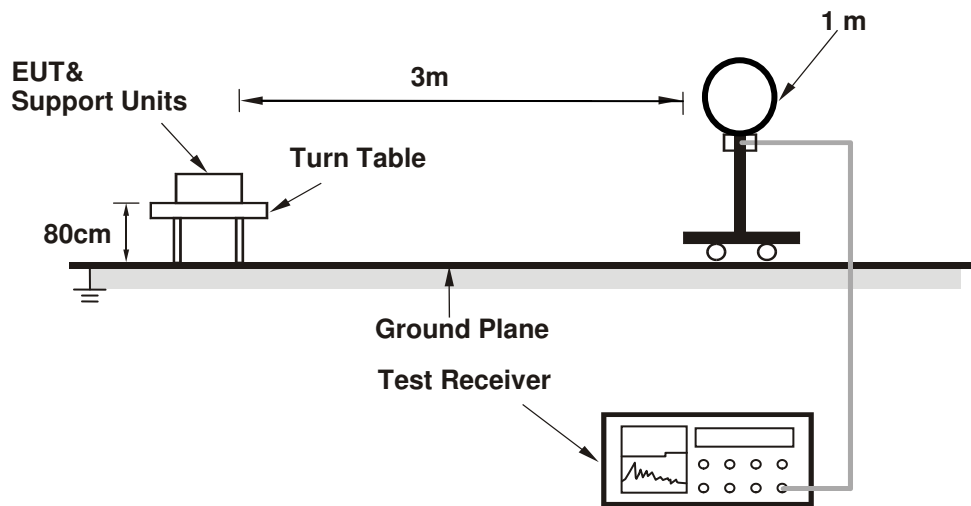

<Frequency Range below 1 GHz>

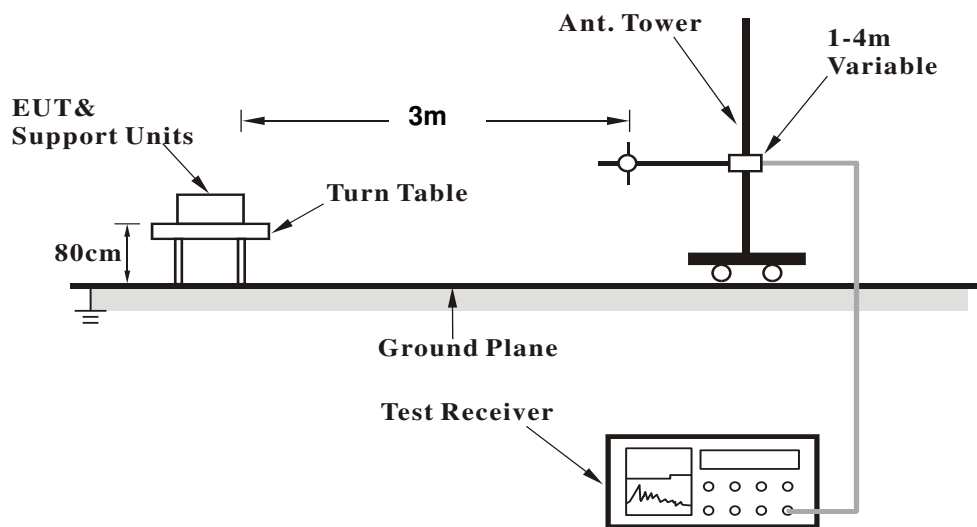

<Frequency Range above 1 GHz>

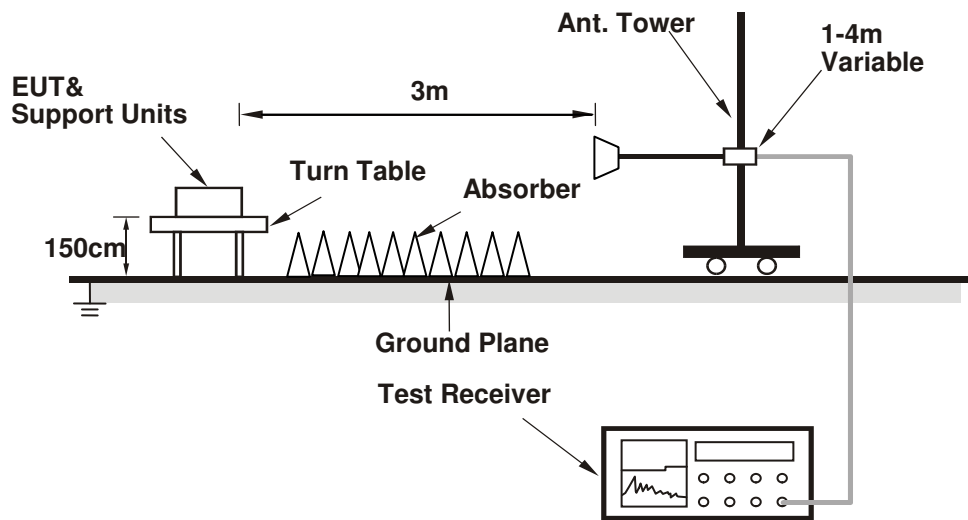

For the actual test configuration, please refer to the attached file (Test Setup Photo).

4.1.7 EUT Operating Conditions

- a. Placed the EUT on the testing table.
- b. Prepared a notebook to act as a communication partner and placed it outside of testing area.
- c. The communication partner connected with EUT via a RJ45 cable and ran a test program (provided by manufacturer) to enable EUT under transmission condition continuously at specific channel frequency.
- d. The communication partner sent data to EUT by command "PING".
- e. The necessary accessories enable the system in full functions.

4.1.8 Test Results
Above 1 GHz Data :
802.11a

CHANNEL	TX Channel 36	DETECTOR FUNCTION	Peak (PK)
FREQUENCY RANGE	1GHz ~ 40GHz		Average (AV)

ANTENNA POLARITY & TEST DISTANCE: HORIZONTAL AT 3 M								
NO.	FREQ. (MHz)	EMISSION LEVEL (dBuV/m)	LIMIT (dBuV/m)	MARGIN (dB)	ANTENNA HEIGHT (m)	TABLE ANGLE (Degree)	RAW VALUE (dBuV)	CORRECTION FACTOR (dB/m)
1	5150.00	55.6 PK	74.0	-18.4	3.59 H	329	53.50	2.10
2	5150.00	42.8 AV	54.0	-11.2	3.59 H	329	40.70	2.10
3	*5180.00	101.3 PK			3.59 H	329	62.40	38.90
4	*5180.00	91.2 AV			3.59 H	329	52.30	38.90
5	#10360.00	58.9 PK	74.0	-15.1	1.52 H	41	44.50	14.40
6	#10360.00	48.6 AV	54.0	-5.4	1.52 H	41	34.20	14.40

ANTENNA POLARITY & TEST DISTANCE: VERTICAL AT 3 M								
NO.	FREQ. (MHz)	EMISSION LEVEL (dBuV/m)	LIMIT (dBuV/m)	MARGIN (dB)	ANTENNA HEIGHT (m)	TABLE ANGLE (Degree)	RAW VALUE (dBuV)	CORRECTION FACTOR (dB/m)
1	5150.00	55.4 PK	74.0	-18.6	1.00 V	170	53.30	2.10
2	5150.00	43.4 AV	54.0	-10.6	1.00 V	170	41.30	2.10
3	*5180.00	105.3 PK			1.00 V	170	66.40	38.90
4	*5180.00	94.7 AV			1.00 V	170	55.80	38.90
5	#10360.00	58.7 PK	74.0	-15.3	1.00 V	128	44.30	14.40
6	#10360.00	51.3 AV	54.0	-2.7	1.00 V	128	36.90	14.40

REMARKS:

1. Emission Level(dBuV/m) = Raw Value(dBuV) + Correction Factor(dB/m)
2. Correction Factor(dB/m) = Antenna Factor(dB/m) + Cable Factor(dB) – Pre-Amplifier Factor(dB)
3. The other emission levels were very low against the limit.
4. Margin value = Emission Level – Limit value
5. " * ": Fundamental frequency.
6. " # ": The radiated frequency is out of the restricted band.

CHANNEL	TX Channel 40	DETECTOR FUNCTION	Peak (PK)
FREQUENCY RANGE	1GHz ~ 40GHz		Average (AV)

ANTENNA POLARITY & TEST DISTANCE: HORIZONTAL AT 3 M

NO.	FREQ. (MHz)	EMISSION LEVEL (dBuV/m)	LIMIT (dBuV/m)	MARGIN (dB)	ANTENNA HEIGHT (m)	TABLE ANGLE (Degree)	RAW VALUE (dBuV)	CORRECTION FACTOR (dB/m)
1	*5200.00	105.4 PK			3.25 H	331	66.40	39.00
2	*5200.00	95.7 AV			3.25 H	331	56.70	39.00
3	#10400.00	59.0 PK	74.0	-15.0	1.00 H	112	44.40	14.60
4	#10400.00	49.1 AV	54.0	-4.9	1.00 H	112	34.50	14.60

ANTENNA POLARITY & TEST DISTANCE: VERTICAL AT 3 M

NO.	FREQ. (MHz)	EMISSION LEVEL (dBuV/m)	LIMIT (dBuV/m)	MARGIN (dB)	ANTENNA HEIGHT (m)	TABLE ANGLE (Degree)	RAW VALUE (dBuV)	CORRECTION FACTOR (dB/m)
1	*5200.00	109.4 PK			1.00 V	173	70.40	39.00
2	*5200.00	98.9 AV			1.00 V	173	59.90	39.00
3	#10400.00	59.5 PK	74.0	-14.5	1.00 V	351	44.90	14.60
4	#10400.00	50.9 AV	54.0	-3.1	1.00 V	351	36.30	14.60

REMARKS:

1. Emission Level(dBuV/m) = Raw Value(dBuV) + Correction Factor(dB/m)
2. Correction Factor(dB/m) = Antenna Factor(dB/m) + Cable Factor(dB) – Pre-Amplifier Factor(dB)
3. The other emission levels were very low against the limit.
4. Margin value = Emission Level – Limit value
5. " * ": Fundamental frequency.
6. " # ": The radiated frequency is out of the restricted band.

CHANNEL	TX Channel 48	DETECTOR FUNCTION	Peak (PK)
FREQUENCY RANGE	1GHz ~ 40GHz		Average (AV)

ANTENNA POLARITY & TEST DISTANCE: HORIZONTAL AT 3 M

NO.	FREQ. (MHz)	EMISSION LEVEL (dBuV/m)	LIMIT (dBuV/m)	MARGIN (dB)	ANTENNA HEIGHT (m)	TABLE ANGLE (Degree)	RAW VALUE (dBuV)	CORRECTION FACTOR (dB/m)
1	*5240.00	106.5 PK			3.40 H	320	67.50	39.00
2	*5240.00	96.7 AV			3.40 H	320	57.70	39.00
3	5350.00	54.5 PK	74.0	-19.5	3.40 H	320	51.90	2.60
4	5350.00	43.0 AV	54.0	-11.0	3.40 H	320	40.40	2.60
5	#10480.00	58.3 PK	74.0	-15.7	1.81 H	146	44.10	14.20
6	#10480.00	46.9 AV	54.0	-7.1	1.81 H	146	32.70	14.20

ANTENNA POLARITY & TEST DISTANCE: VERTICAL AT 3 M

NO.	FREQ. (MHz)	EMISSION LEVEL (dBuV/m)	LIMIT (dBuV/m)	MARGIN (dB)	ANTENNA HEIGHT (m)	TABLE ANGLE (Degree)	RAW VALUE (dBuV)	CORRECTION FACTOR (dB/m)
1	*5240.00	110.3 PK			1.00 V	159	71.30	39.00
2	*5240.00	99.7 AV			1.00 V	159	60.70	39.00
3	5350.00	56.4 PK	74.0	-17.6	1.00 V	159	53.80	2.60
4	5350.00	45.0 AV	54.0	-9.0	1.00 V	159	42.40	2.60
5	#10480.00	58.4 PK	74.0	-15.6	1.45 V	325	44.20	14.20
6	#10480.00	49.1 AV	54.0	-4.9	1.45 V	325	34.90	14.20

REMARKS:

1. Emission Level(dBuV/m) = Raw Value(dBuV) + Correction Factor(dB/m)
2. Correction Factor(dB/m) = Antenna Factor(dB/m) + Cable Factor(dB) – Pre-Amplifier Factor(dB)
3. The other emission levels were very low against the limit.
4. Margin value = Emission Level – Limit value
5. " * " : Fundamental frequency.
6. " # " : The radiated frequency is out of the restricted band.

CHANNEL	TX Channel 52	DETECTOR FUNCTION	Peak (PK)
FREQUENCY RANGE	1GHz ~ 40GHz		Average (AV)

ANTENNA POLARITY & TEST DISTANCE: HORIZONTAL AT 3 M

NO.	FREQ. (MHz)	EMISSION LEVEL (dBuV/m)	LIMIT (dBuV/m)	MARGIN (dB)	ANTENNA HEIGHT (m)	TABLE ANGLE (Degree)	RAW VALUE (dBuV)	CORRECTION FACTOR (dB/m)
1	5150.00	55.1 PK	74.0	-18.9	3.17 H	142	53.00	2.10
2	5150.00	43.3 AV	54.0	-10.7	3.17 H	142	41.20	2.10
3	*5260.00	107.6 PK			3.17 H	142	68.50	39.10
4	*5260.00	97.4 AV			3.17 H	142	58.30	39.10
5	#10520.00	59.2 PK	74.0	-14.8	1.42 H	133	45.00	14.20
6	#10520.00	48.2 AV	54.0	-5.8	1.42 H	133	34.00	14.20

ANTENNA POLARITY & TEST DISTANCE: VERTICAL AT 3 M

NO.	FREQ. (MHz)	EMISSION LEVEL (dBuV/m)	LIMIT (dBuV/m)	MARGIN (dB)	ANTENNA HEIGHT (m)	TABLE ANGLE (Degree)	RAW VALUE (dBuV)	CORRECTION FACTOR (dB/m)
1	5150.00	57.1 PK	74.0	-16.9	1.00 V	175	55.00	2.10
2	5150.00	45.4 AV	54.0	-8.6	1.00 V	175	43.30	2.10
3	*5260.00	110.4 PK			1.00 V	175	71.30	39.10
4	*5260.00	100.7 AV			1.00 V	175	61.60	39.10
5	#10520.00	60.2 PK	74.0	-13.8	1.45 V	303	46.00	14.20
6	#10520.00	50.5 AV	54.0	-3.5	1.45 V	303	36.30	14.20

REMARKS:

1. Emission Level(dBuV/m) = Raw Value(dBuV) + Correction Factor(dB/m)
2. Correction Factor(dB/m) = Antenna Factor(dB/m) + Cable Factor(dB) – Pre-Amplifier Factor(dB)
3. The other emission levels were very low against the limit.
4. Margin value = Emission Level – Limit value
5. " * " : Fundamental frequency.
6. " # " : The radiated frequency is out of the restricted band.

CHANNEL	TX Channel 60	DETECTOR FUNCTION	Peak (PK)
FREQUENCY RANGE	1GHz ~ 40GHz		Average (AV)

ANTENNA POLARITY & TEST DISTANCE: HORIZONTAL AT 3 M

NO.	FREQ. (MHz)	EMISSION LEVEL (dBuV/m)	LIMIT (dBuV/m)	MARGIN (dB)	ANTENNA HEIGHT (m)	TABLE ANGLE (Degree)	RAW VALUE (dBuV)	CORRECTION FACTOR (dB/m)
1	*5300.00	107.5 PK			3.28 H	246	68.30	39.20
2	*5300.00	97.8 AV			3.28 H	246	58.60	39.20
3	10600.00	59.0 PK	74.0	-15.0	2.33 H	196	44.30	14.70
4	10600.00	48.3 AV	54.0	-5.7	2.33 H	196	33.60	14.70

ANTENNA POLARITY & TEST DISTANCE: VERTICAL AT 3 M

NO.	FREQ. (MHz)	EMISSION LEVEL (dBuV/m)	LIMIT (dBuV/m)	MARGIN (dB)	ANTENNA HEIGHT (m)	TABLE ANGLE (Degree)	RAW VALUE (dBuV)	CORRECTION FACTOR (dB/m)
1	*5300.00	111.0 PK			1.35 V	173	71.80	39.20
2	*5300.00	100.8 AV			1.35 V	173	61.60	39.20
3	10600.00	60.9 PK	74.0	-13.1	1.93 V	24	46.20	14.70
4	10600.00	50.8 AV	54.0	-3.2	1.93 V	24	36.10	14.70

REMARKS:

1. Emission Level(dBuV/m) = Raw Value(dBuV) + Correction Factor(dB/m)
2. Correction Factor(dB/m) = Antenna Factor(dB/m) + Cable Factor(dB) – Pre-Amplifier Factor(dB)
3. The other emission levels were very low against the limit.
4. Margin value = Emission Level – Limit value
5. " * ": Fundamental frequency.

CHANNEL	TX Channel 64	DETECTOR FUNCTION	Peak (PK)
FREQUENCY RANGE	1GHz ~ 40GHz		Average (AV)

ANTENNA POLARITY & TEST DISTANCE: HORIZONTAL AT 3 M

NO.	FREQ. (MHz)	EMISSION LEVEL (dBuV/m)	LIMIT (dBuV/m)	MARGIN (dB)	ANTENNA HEIGHT (m)	TABLE ANGLE (Degree)	RAW VALUE (dBuV)	CORRECTION FACTOR (dB/m)
1	*5320.00	103.4 PK			3.51 H	296	64.20	39.20
2	*5320.00	93.6 AV			3.51 H	296	54.40	39.20
3	5350.00	56.0 PK	74.0	-18.0	3.51 H	296	53.40	2.60
4	5350.00	43.7 AV	54.0	-10.3	3.51 H	296	41.10	2.60
5	10640.00	59.5 PK	74.0	-14.5	1.54 H	225	44.80	14.70
6	10640.00	47.9 AV	54.0	-6.1	1.54 H	225	33.20	14.70

ANTENNA POLARITY & TEST DISTANCE: VERTICAL AT 3 M

NO.	FREQ. (MHz)	EMISSION LEVEL (dBuV/m)	LIMIT (dBuV/m)	MARGIN (dB)	ANTENNA HEIGHT (m)	TABLE ANGLE (Degree)	RAW VALUE (dBuV)	CORRECTION FACTOR (dB/m)
1	*5320.00	105.9 PK			1.00 V	182	66.70	39.20
2	*5320.00	95.8 AV			1.00 V	182	56.60	39.20
3	5350.00	57.2 PK	74.0	-16.8	1.00 V	182	54.60	2.60
4	5350.00	44.4 AV	54.0	-9.6	1.00 V	182	41.80	2.60
5	10640.00	61.0 PK	74.0	-13.0	1.75 V	116	46.30	14.70
6	10640.00	50.9 AV	54.0	-3.1	1.75 V	116	36.20	14.70

REMARKS:

1. Emission Level(dBuV/m) = Raw Value(dBuV) + Correction Factor(dB/m)
2. Correction Factor(dB/m) = Antenna Factor(dB/m) + Cable Factor(dB) – Pre-Amplifier Factor(dB)
3. The other emission levels were very low against the limit.
4. Margin value = Emission Level – Limit value
5. " * ": Fundamental frequency.

CHANNEL	TX Channel 100	DETECTOR FUNCTION	Peak (PK)
FREQUENCY RANGE	1GHz ~ 40GHz		Average (AV)

ANTENNA POLARITY & TEST DISTANCE: HORIZONTAL AT 3 M

NO.	FREQ. (MHz)	EMISSION LEVEL (dBuV/m)	LIMIT (dBuV/m)	MARGIN (dB)	ANTENNA HEIGHT (m)	TABLE ANGLE (Degree)	RAW VALUE (dBuV)	CORRECTION FACTOR (dB/m)
1	5448.00	58.0 PK	74.0	-16.0	1.93 H	334	55.30	2.70
2	5448.00	45.3 AV	54.0	-8.7	1.93 H	334	42.60	2.70
3	#5470.00	55.8 PK	74.0	-18.2	1.93 H	334	53.10	2.70
4	#5470.00	45.0 AV	54.0	-9.0	1.93 H	334	42.30	2.70
5	*5500.00	102.5 PK			1.93 H	334	63.00	39.50
6	*5500.00	91.8 AV			1.93 H	334	52.30	39.50
7	11000.00	61.0 PK	74.0	-13.0	2.43 H	290	44.90	16.10
8	11000.00	49.9 AV	54.0	-4.1	2.43 H	290	33.80	16.10

ANTENNA POLARITY & TEST DISTANCE: VERTICAL AT 3 M

NO.	FREQ. (MHz)	EMISSION LEVEL (dBuV/m)	LIMIT (dBuV/m)	MARGIN (dB)	ANTENNA HEIGHT (m)	TABLE ANGLE (Degree)	RAW VALUE (dBuV)	CORRECTION FACTOR (dB/m)
1	5448.00	58.5 PK	74.0	-15.5	1.21 V	165	55.80	2.70
2	5448.00	46.2 AV	54.0	-7.8	1.21 V	165	43.50	2.70
3	#5470.00	56.5 PK	74.0	-17.5	1.21 V	165	53.80	2.70
4	#5470.00	45.8 AV	54.0	-8.2	1.21 V	165	43.10	2.70
5	*5500.00	106.0 PK			1.21 V	165	66.50	39.50
6	*5500.00	94.9 AV			1.21 V	165	55.40	39.50
7	11000.00	62.4 PK	74.0	-11.6	1.08 V	201	46.30	16.10
8	11000.00	51.6 AV	54.0	-2.4	1.08 V	201	35.50	16.10

REMARKS:

1. Emission Level(dBuV/m) = Raw Value(dBuV) + Correction Factor(dB/m)
2. Correction Factor(dB/m) = Antenna Factor(dB/m) + Cable Factor(dB) – Pre-Amplifier Factor(dB)
3. The other emission levels were very low against the limit.
4. Margin value = Emission Level – Limit value
5. " * ": Fundamental frequency.
6. " # ": The radiated frequency is out of the restricted band.

CHANNEL	TX Channel 116	DETECTOR FUNCTION	Peak (PK)
FREQUENCY RANGE	1GHz ~ 40GHz		Average (AV)

ANTENNA POLARITY & TEST DISTANCE: HORIZONTAL AT 3 M

NO.	FREQ. (MHz)	EMISSION LEVEL (dBuV/m)	LIMIT (dBuV/m)	MARGIN (dB)	ANTENNA HEIGHT (m)	TABLE ANGLE (Degree)	RAW VALUE (dBuV)	CORRECTION FACTOR (dB/m)
1	*5580.00	107.9 PK			1.87 H	326	68.20	39.70
2	*5580.00	96.0 AV			1.87 H	326	56.30	39.70
3	11160.00	59.5 PK	74.0	-14.5	2.25 H	281	44.20	15.30
4	11160.00	47.9 AV	54.0	-6.1	2.25 H	281	32.60	15.30

ANTENNA POLARITY & TEST DISTANCE: VERTICAL AT 3 M

NO.	FREQ. (MHz)	EMISSION LEVEL (dBuV/m)	LIMIT (dBuV/m)	MARGIN (dB)	ANTENNA HEIGHT (m)	TABLE ANGLE (Degree)	RAW VALUE (dBuV)	CORRECTION FACTOR (dB/m)
1	*5580.00	111.6 PK			1.25 V	170	71.90	39.70
2	*5580.00	100.5 AV			1.25 V	170	60.80	39.70
3	11160.00	61.6 PK	74.0	-12.4	1.13 V	198	46.30	15.30
4	11160.00	50.4 AV	54.0	-3.6	1.13 V	198	35.10	15.30

REMARKS:

1. Emission Level(dBuV/m) = Raw Value(dBuV) + Correction Factor(dB/m)
2. Correction Factor(dB/m) = Antenna Factor(dB/m) + Cable Factor(dB) – Pre-Amplifier Factor(dB)
3. The other emission levels were very low against the limit.
4. Margin value = Emission Level – Limit value
5. " * ": Fundamental frequency.

CHANNEL	TX Channel 140	DETECTOR FUNCTION	Peak (PK)
FREQUENCY RANGE	1GHz ~ 40GHz		Average (AV)

ANTENNA POLARITY & TEST DISTANCE: HORIZONTAL AT 3 M

NO.	FREQ. (MHz)	EMISSION LEVEL (dBuV/m)	LIMIT (dBuV/m)	MARGIN (dB)	ANTENNA HEIGHT (m)	TABLE ANGLE (Degree)	RAW VALUE (dBuV)	CORRECTION FACTOR (dB/m)
1	*5700.00	100.2 PK			1.94 H	312	60.30	39.90
2	*5700.00	90.2 AV			1.94 H	312	50.30	39.90
3	#5760.00	57.8 PK	74.0	-16.2	1.94 H	312	54.70	3.10
4	#5760.00	47.9 AV	54.0	-6.1	1.94 H	312	44.80	3.10
5	11400.00	60.0 PK	74.0	-14.0	2.14 H	273	44.70	15.30
6	11400.00	48.4 AV	54.0	-5.6	2.14 H	273	33.10	15.30

ANTENNA POLARITY & TEST DISTANCE: VERTICAL AT 3 M

NO.	FREQ. (MHz)	EMISSION LEVEL (dBuV/m)	LIMIT (dBuV/m)	MARGIN (dB)	ANTENNA HEIGHT (m)	TABLE ANGLE (Degree)	RAW VALUE (dBuV)	CORRECTION FACTOR (dB/m)
1	*5700.00	103.8 PK			1.30 V	171	63.90	39.90
2	*5700.00	92.9 AV			1.30 V	171	53.00	39.90
3	#5760.00	59.5 PK	74.0	-14.5	1.30 V	171	56.40	3.10
4	#5760.00	50.1 AV	54.0	-3.9	1.30 V	171	47.00	3.10
5	11400.00	61.5 PK	74.0	-12.5	1.06 V	192	46.20	15.30
6	11400.00	50.1 AV	54.0	-3.9	1.06 V	192	34.80	15.30

REMARKS:

1. Emission Level(dBuV/m) = Raw Value(dBuV) + Correction Factor(dB/m)
2. Correction Factor(dB/m) = Antenna Factor(dB/m) + Cable Factor(dB) – Pre-Amplifier Factor(dB)
3. The other emission levels were very low against the limit.
4. Margin value = Emission Level – Limit value
5. " * ": Fundamental frequency.
6. " # ": The radiated frequency is out of the restricted band.

CHANNEL	TX Channel 149	DETECTOR FUNCTION	Peak (PK)
FREQUENCY RANGE	1GHz ~ 40GHz		Average (AV)

ANTENNA POLARITY & TEST DISTANCE: HORIZONTAL AT 3 M

NO.	FREQ. (MHz)	EMISSION LEVEL (dBuV/m)	LIMIT (dBuV/m)	MARGIN (dB)	ANTENNA HEIGHT (m)	TABLE ANGLE (Degree)	RAW VALUE (dBuV)	CORRECTION FACTOR (dB/m)
1	*5745.00	99.8 PK			1.02 H	351	59.90	39.90
2	*5745.00	88.9 AV			1.02 H	351	49.00	39.90
3	11490.00	59.9 PK	74.0	-14.1	2.10 H	282	45.30	14.60
4	11490.00	47.2 AV	54.0	-6.8	2.10 H	282	32.60	14.60

ANTENNA POLARITY & TEST DISTANCE: VERTICAL AT 3 M

NO.	FREQ. (MHz)	EMISSION LEVEL (dBuV/m)	LIMIT (dBuV/m)	MARGIN (dB)	ANTENNA HEIGHT (m)	TABLE ANGLE (Degree)	RAW VALUE (dBuV)	CORRECTION FACTOR (dB/m)
1	*5745.00	102.2 PK			1.21 V	166	62.30	39.90
2	*5745.00	91.2 AV			1.21 V	166	51.30	39.90
3	11490.00	60.7 PK	74.0	-13.3	1.16 V	264	46.10	14.60
4	11490.00	49.8 AV	54.0	-4.2	1.16 V	264	35.20	14.60

REMARKS:

1. Emission Level(dBuV/m) = Raw Value(dBuV) + Correction Factor(dB/m)
2. Correction Factor(dB/m) = Antenna Factor(dB/m) + Cable Factor(dB) – Pre-Amplifier Factor(dB)
3. The other emission levels were very low against the limit.
4. Margin value = Emission Level – Limit value
5. " * ": Fundamental frequency.

CHANNEL	TX Channel 157	DETECTOR FUNCTION	Peak (PK)
FREQUENCY RANGE	1GHz ~ 40GHz		Average (AV)

ANTENNA POLARITY & TEST DISTANCE: HORIZONTAL AT 3 M

NO.	FREQ. (MHz)	EMISSION LEVEL (dBuV/m)	LIMIT (dBuV/m)	MARGIN (dB)	ANTENNA HEIGHT (m)	TABLE ANGLE (Degree)	RAW VALUE (dBuV)	CORRECTION FACTOR (dB/m)
1	*5785.00	107.6 PK			1.03 H	346	67.70	39.90
2	*5785.00	96.4 AV			1.03 H	346	56.50	39.90
3	11570.00	60.1 PK	74.0	-13.9	2.03 H	279	45.60	14.50
4	11570.00	47.4 AV	54.0	-6.6	2.03 H	279	32.90	14.50

ANTENNA POLARITY & TEST DISTANCE: VERTICAL AT 3 M

NO.	FREQ. (MHz)	EMISSION LEVEL (dBuV/m)	LIMIT (dBuV/m)	MARGIN (dB)	ANTENNA HEIGHT (m)	TABLE ANGLE (Degree)	RAW VALUE (dBuV)	CORRECTION FACTOR (dB/m)
1	*5785.00	108.8 PK			1.25 V	165	68.90	39.90
2	*5785.00	98.2 AV			1.25 V	165	58.30	39.90
3	11570.00	60.9 PK	74.0	-13.1	1.23 V	247	46.40	14.50
4	11570.00	49.4 AV	54.0	-4.6	1.23 V	247	34.90	14.50

REMARKS:

1. Emission Level(dBuV/m) = Raw Value(dBuV) + Correction Factor(dB/m)
2. Correction Factor(dB/m) = Antenna Factor(dB/m) + Cable Factor(dB) – Pre-Amplifier Factor(dB)
3. The other emission levels were very low against the limit.
4. Margin value = Emission Level – Limit value
5. " * ": Fundamental frequency.

CHANNEL	TX Channel 165	DETECTOR FUNCTION	Peak (PK)
FREQUENCY RANGE	1GHz ~ 40GHz		Average (AV)

ANTENNA POLARITY & TEST DISTANCE: HORIZONTAL AT 3 M

NO.	FREQ. (MHz)	EMISSION LEVEL (dBuV/m)	LIMIT (dBuV/m)	MARGIN (dB)	ANTENNA HEIGHT (m)	TABLE ANGLE (Degree)	RAW VALUE (dBuV)	CORRECTION FACTOR (dB/m)
1	*5825.00	102.9 PK			1.10 H	347	62.90	40.00
2	*5825.00	91.5 AV			1.10 H	347	51.50	40.00
3	11650.00	60.5 PK	74.0	-13.5	1.95 H	302	45.80	14.70
4	11650.00	47.3 AV	54.0	-6.7	1.95 H	302	32.60	14.70

ANTENNA POLARITY & TEST DISTANCE: VERTICAL AT 3 M

NO.	FREQ. (MHz)	EMISSION LEVEL (dBuV/m)	LIMIT (dBuV/m)	MARGIN (dB)	ANTENNA HEIGHT (m)	TABLE ANGLE (Degree)	RAW VALUE (dBuV)	CORRECTION FACTOR (dB/m)
1	*5825.00	105.5 PK			1.31 V	168	65.50	40.00
2	*5825.00	95.0 AV			1.31 V	168	55.00	40.00
3	11650.00	61.1 PK	74.0	-12.9	1.00 V	281	46.40	14.70
4	11650.00	48.8 AV	54.0	-5.2	1.00 V	281	34.10	14.70

REMARKS:

1. Emission Level(dBuV/m) = Raw Value(dBuV) + Correction Factor(dB/m)
2. Correction Factor(dB/m) = Antenna Factor(dB/m) + Cable Factor(dB) – Pre-Amplifier Factor(dB)
3. The other emission levels were very low against the limit.
4. Margin value = Emission Level – Limit value
5. " * ": Fundamental frequency.

802.11n (20MHz)

CHANNEL	TX Channel 36	DETECTOR FUNCTION	Peak (PK)
FREQUENCY RANGE	1GHz ~ 40GHz		Average (AV)

ANTENNA POLARITY & TEST DISTANCE: HORIZONTAL AT 3 M

NO.	FREQ. (MHz)	EMISSION LEVEL (dBuV/m)	LIMIT (dBuV/m)	MARGIN (dB)	ANTENNA HEIGHT (m)	TABLE ANGLE (Degree)	RAW VALUE (dBuV)	CORRECTION FACTOR (dB/m)
1	5150.00	55.5 PK	74.0	-18.5	1.93 H	185	53.40	2.10
2	5150.00	42.7 AV	54.0	-11.3	1.93 H	185	40.60	2.10
3	*5180.00	101.8 PK			1.93 H	185	62.90	38.90
4	*5180.00	91.8 AV			1.93 H	185	52.90	38.90
5	#10360.00	57.5 PK	74.0	-16.5	1.75 H	122	43.10	14.40
6	#10360.00	48.2 AV	54.0	-5.8	1.75 H	122	33.80	14.40

ANTENNA POLARITY & TEST DISTANCE: VERTICAL AT 3 M

NO.	FREQ. (MHz)	EMISSION LEVEL (dBuV/m)	LIMIT (dBuV/m)	MARGIN (dB)	ANTENNA HEIGHT (m)	TABLE ANGLE (Degree)	RAW VALUE (dBuV)	CORRECTION FACTOR (dB/m)
1	5150.00	57.2 PK	74.0	-16.8	1.00 V	173	55.10	2.10
2	5150.00	45.1 AV	54.0	-8.9	1.00 V	173	43.00	2.10
3	*5180.00	105.7 PK			1.00 V	173	66.80	38.90
4	*5180.00	94.8 AV			1.00 V	173	55.90	38.90
5	#10360.00	58.1 PK	74.0	-15.9	1.31 V	349	43.70	14.40
6	#10360.00	50.0 AV	54.0	-4.0	1.31 V	349	35.60	14.40

REMARKS:

1. Emission Level(dBuV/m) = Raw Value(dBuV) + Correction Factor(dB/m)
2. Correction Factor(dB/m) = Antenna Factor(dB/m) + Cable Factor(dB) – Pre-Amplifier Factor(dB)
3. The other emission levels were very low against the limit.
4. Margin value = Emission Level – Limit value
5. " * ": Fundamental frequency.
6. " # ": The radiated frequency is out of the restricted band.

CHANNEL	TX Channel 40	DETECTOR FUNCTION	Peak (PK)
FREQUENCY RANGE	1GHz ~ 40GHz		Average (AV)

ANTENNA POLARITY & TEST DISTANCE: HORIZONTAL AT 3 M

NO.	FREQ. (MHz)	EMISSION LEVEL (dBuV/m)	LIMIT (dBuV/m)	MARGIN (dB)	ANTENNA HEIGHT (m)	TABLE ANGLE (Degree)	RAW VALUE (dBuV)	CORRECTION FACTOR (dB/m)
1	*5200.00	105.2 PK			3.28 H	130	66.20	39.00
2	*5200.00	95.6 AV			3.28 H	130	56.60	39.00
3	#10400.00	59.4 PK	74.0	-14.6	1.93 H	142	44.80	14.60
4	#10400.00	47.4 AV	54.0	-6.6	1.93 H	142	32.80	14.60

ANTENNA POLARITY & TEST DISTANCE: VERTICAL AT 3 M

NO.	FREQ. (MHz)	EMISSION LEVEL (dBuV/m)	LIMIT (dBuV/m)	MARGIN (dB)	ANTENNA HEIGHT (m)	TABLE ANGLE (Degree)	RAW VALUE (dBuV)	CORRECTION FACTOR (dB/m)
1	*5200.00	109.2 PK			1.02 V	173	70.20	39.00
2	*5200.00	98.9 AV			1.02 V	173	59.90	39.00
3	#10400.00	61.3 PK	74.0	-12.7	1.03 V	350	46.70	14.60
4	#10400.00	50.5 AV	54.0	-3.5	1.03 V	350	35.90	14.60

REMARKS:

1. Emission Level(dBuV/m) = Raw Value(dBuV) + Correction Factor(dB/m)
2. Correction Factor(dB/m) = Antenna Factor(dB/m) + Cable Factor(dB) – Pre-Amplifier Factor(dB)
3. The other emission levels were very low against the limit.
4. Margin value = Emission Level – Limit value
5. " * ": Fundamental frequency.
6. " # ": The radiated frequency is out of the restricted band.

CHANNEL	TX Channel 48	DETECTOR FUNCTION	Peak (PK)
FREQUENCY RANGE	1GHz ~ 40GHz		Average (AV)

ANTENNA POLARITY & TEST DISTANCE: HORIZONTAL AT 3 M

NO.	FREQ. (MHz)	EMISSION LEVEL (dBuV/m)	LIMIT (dBuV/m)	MARGIN (dB)	ANTENNA HEIGHT (m)	TABLE ANGLE (Degree)	RAW VALUE (dBuV)	CORRECTION FACTOR (dB/m)
1	*5240.00	105.5 PK			3.34 H	139	66.50	39.00
2	*5240.00	95.7 AV			3.34 H	139	56.70	39.00
3	5350.00	55.8 PK	74.0	-18.2	3.34 H	139	53.20	2.60
4	5350.00	43.2 AV	54.0	-10.8	3.34 H	139	40.60	2.60
5	#10480.00	58.0 PK	74.0	-16.0	1.79 H	11	43.80	14.20
6	#10480.00	47.9 AV	54.0	-6.1	1.79 H	11	33.70	14.20

ANTENNA POLARITY & TEST DISTANCE: VERTICAL AT 3 M

NO.	FREQ. (MHz)	EMISSION LEVEL (dBuV/m)	LIMIT (dBuV/m)	MARGIN (dB)	ANTENNA HEIGHT (m)	TABLE ANGLE (Degree)	RAW VALUE (dBuV)	CORRECTION FACTOR (dB/m)
1	*5240.00	109.2 PK			1.00 V	173	70.20	39.00
2	*5240.00	99.3 AV			1.00 V	173	60.30	39.00
3	5350.00	57.9 PK	74.0	-16.1	1.00 V	173	55.30	2.60
4	5350.00	45.5 AV	54.0	-8.5	1.00 V	173	42.90	2.60
5	#10480.00	60.4 PK	74.0	-13.6	1.30 V	149	46.20	14.20
6	#10480.00	50.3 AV	54.0	-3.7	1.30 V	149	36.10	14.20

REMARKS:

1. Emission Level(dBuV/m) = Raw Value(dBuV) + Correction Factor(dB/m)
2. Correction Factor(dB/m) = Antenna Factor(dB/m) + Cable Factor(dB) – Pre-Amplifier Factor(dB)
3. The other emission levels were very low against the limit.
4. Margin value = Emission Level – Limit value
5. " * ": Fundamental frequency.
6. " # ": The radiated frequency is out of the restricted band.

CHANNEL	TX Channel 52	DETECTOR FUNCTION	Peak (PK)
FREQUENCY RANGE	1GHz ~ 40GHz		Average (AV)

ANTENNA POLARITY & TEST DISTANCE: HORIZONTAL AT 3 M

NO.	FREQ. (MHz)	EMISSION LEVEL (dBuV/m)	LIMIT (dBuV/m)	MARGIN (dB)	ANTENNA HEIGHT (m)	TABLE ANGLE (Degree)	RAW VALUE (dBuV)	CORRECTION FACTOR (dB/m)
1	5150.00	54.0 PK	74.0	-20.0	3.84 H	175	51.90	2.10
2	5150.00	42.8 AV	54.0	-11.2	3.84 H	175	40.70	2.10
3	*5260.00	108.6 PK			3.84 H	175	69.50	39.10
4	*5260.00	98.5 AV			3.84 H	175	59.40	39.10
5	#10520.00	58.8 PK	74.0	-15.2	1.14 H	136	44.60	14.20
6	#10520.00	47.8 AV	54.0	-6.2	1.14 H	136	33.60	14.20

ANTENNA POLARITY & TEST DISTANCE: VERTICAL AT 3 M

NO.	FREQ. (MHz)	EMISSION LEVEL (dBuV/m)	LIMIT (dBuV/m)	MARGIN (dB)	ANTENNA HEIGHT (m)	TABLE ANGLE (Degree)	RAW VALUE (dBuV)	CORRECTION FACTOR (dB/m)
1	5150.00	55.9 PK	74.0	-18.1	1.00 V	167	53.80	2.10
2	5150.00	44.5 AV	54.0	-9.5	1.00 V	167	42.40	2.10
3	*5260.00	110.9 PK			1.00 V	167	71.80	39.10
4	*5260.00	100.7 AV			1.00 V	167	61.60	39.10
5	#10520.00	59.7 PK	74.0	-14.3	1.24 V	19	45.50	14.20
6	#10520.00	49.7 AV	54.0	-4.3	1.24 V	19	35.50	14.20

REMARKS:

1. Emission Level(dBuV/m) = Raw Value(dBuV) + Correction Factor(dB/m)
2. Correction Factor(dB/m) = Antenna Factor(dB/m) + Cable Factor(dB) – Pre-Amplifier Factor(dB)
3. The other emission levels were very low against the limit.
4. Margin value = Emission Level – Limit value
5. " * " : Fundamental frequency.
6. " # " : The radiated frequency is out of the restricted band.

CHANNEL	TX Channel 60	DETECTOR FUNCTION	Peak (PK)
FREQUENCY RANGE	1GHz ~ 40GHz		Average (AV)

ANTENNA POLARITY & TEST DISTANCE: HORIZONTAL AT 3 M

NO.	FREQ. (MHz)	EMISSION LEVEL (dBuV/m)	LIMIT (dBuV/m)	MARGIN (dB)	ANTENNA HEIGHT (m)	TABLE ANGLE (Degree)	RAW VALUE (dBuV)	CORRECTION FACTOR (dB/m)
1	*5300.00	107.5 PK			3.32 H	169	68.30	39.20
2	*5300.00	96.5 AV			3.32 H	169	57.30	39.20
3	10600.00	59.3 PK	74.0	-14.7	1.72 H	116	44.60	14.70
4	10600.00	48.4 AV	54.0	-5.6	1.72 H	116	33.70	14.70

ANTENNA POLARITY & TEST DISTANCE: VERTICAL AT 3 M

NO.	FREQ. (MHz)	EMISSION LEVEL (dBuV/m)	LIMIT (dBuV/m)	MARGIN (dB)	ANTENNA HEIGHT (m)	TABLE ANGLE (Degree)	RAW VALUE (dBuV)	CORRECTION FACTOR (dB/m)
1	*5300.00	109.8 PK			1.00 V	162	70.60	39.20
2	*5300.00	99.5 AV			1.00 V	162	60.30	39.20
3	10600.00	60.9 PK	74.0	-13.1	2.21 V	111	46.20	14.70
4	10600.00	50.3 AV	54.0	-3.7	2.21 V	111	35.60	14.70

REMARKS:

1. Emission Level(dBuV/m) = Raw Value(dBuV) + Correction Factor(dB/m)
2. Correction Factor(dB/m) = Antenna Factor(dB/m) + Cable Factor(dB) – Pre-Amplifier Factor(dB)
3. The other emission levels were very low against the limit.
4. Margin value = Emission Level – Limit value
5. " * ": Fundamental frequency.

CHANNEL	TX Channel 64	DETECTOR FUNCTION	Peak (PK)
FREQUENCY RANGE	1GHz ~ 40GHz		Average (AV)

ANTENNA POLARITY & TEST DISTANCE: HORIZONTAL AT 3 M

NO.	FREQ. (MHz)	EMISSION LEVEL (dBuV/m)	LIMIT (dBuV/m)	MARGIN (dB)	ANTENNA HEIGHT (m)	TABLE ANGLE (Degree)	RAW VALUE (dBuV)	CORRECTION FACTOR (dB/m)
1	*5320.00	103.7 PK			3.28 H	162	64.50	39.20
2	*5320.00	93.7 AV			3.28 H	162	54.50	39.20
3	5350.00	55.3 PK	74.0	-18.7	3.28 H	162	52.70	2.60
4	5350.00	43.8 AV	54.0	-10.2	3.28 H	162	41.20	2.60
5	10640.00	58.8 PK	74.0	-15.2	1.27 H	118	44.10	14.70
6	10640.00	47.3 AV	54.0	-6.7	1.27 H	118	32.60	14.70

ANTENNA POLARITY & TEST DISTANCE: VERTICAL AT 3 M

NO.	FREQ. (MHz)	EMISSION LEVEL (dBuV/m)	LIMIT (dBuV/m)	MARGIN (dB)	ANTENNA HEIGHT (m)	TABLE ANGLE (Degree)	RAW VALUE (dBuV)	CORRECTION FACTOR (dB/m)
1	*5320.00	106.5 PK			1.00 V	162	67.30	39.20
2	*5320.00	96.6 AV			1.00 V	162	57.40	39.20
3	5350.00	57.8 PK	74.0	-16.2	1.00 V	162	55.20	2.60
4	5350.00	45.4 AV	54.0	-8.6	1.00 V	162	42.80	2.60
5	10640.00	61.0 PK	74.0	-13.0	1.25 V	359	46.30	14.70
6	10640.00	49.8 AV	54.0	-4.2	1.25 V	359	35.10	14.70

REMARKS:

1. Emission Level(dBuV/m) = Raw Value(dBuV) + Correction Factor(dB/m)
2. Correction Factor(dB/m) = Antenna Factor(dB/m) + Cable Factor(dB) – Pre-Amplifier Factor(dB)
3. The other emission levels were very low against the limit.
4. Margin value = Emission Level – Limit value
5. " * ": Fundamental frequency.

CHANNEL	TX Channel 100	DETECTOR FUNCTION	Peak (PK)
FREQUENCY RANGE	1GHz ~ 40GHz		Average (AV)

ANTENNA POLARITY & TEST DISTANCE: HORIZONTAL AT 3 M

NO.	FREQ. (MHz)	EMISSION LEVEL (dBuV/m)	LIMIT (dBuV/m)	MARGIN (dB)	ANTENNA HEIGHT (m)	TABLE ANGLE (Degree)	RAW VALUE (dBuV)	CORRECTION FACTOR (dB/m)
1	5448.00	59.0 PK	74.0	-15.0	1.76 H	354	56.30	2.70
2	5448.00	45.9 AV	54.0	-8.1	1.76 H	354	43.20	2.70
3	#5470.00	58.6 PK	74.0	-15.4	1.76 H	354	55.90	2.70
4	#5470.00	44.3 AV	54.0	-9.7	1.76 H	354	41.60	2.70
5	*5500.00	102.9 PK			1.76 H	354	63.40	39.50
6	*5500.00	91.9 AV			1.76 H	354	52.40	39.50
7	11000.00	59.4 PK	74.0	-14.6	2.28 H	279	43.30	16.10
8	11000.00	47.3 AV	54.0	-6.7	2.28 H	279	31.20	16.10

ANTENNA POLARITY & TEST DISTANCE: VERTICAL AT 3 M

NO.	FREQ. (MHz)	EMISSION LEVEL (dBuV/m)	LIMIT (dBuV/m)	MARGIN (dB)	ANTENNA HEIGHT (m)	TABLE ANGLE (Degree)	RAW VALUE (dBuV)	CORRECTION FACTOR (dB/m)
1	5448.00	60.1 PK	74.0	-13.9	1.18 V	162	57.40	2.70
2	5448.00	48.1 AV	54.0	-5.9	1.18 V	162	45.40	2.70
3	#5470.00	59.5 PK	74.0	-14.5	1.18 V	162	56.80	2.70
4	#5470.00	45.7 AV	54.0	-8.3	1.18 V	162	43.00	2.70
5	*5500.00	107.3 PK			1.18 V	162	67.80	39.50
6	*5500.00	96.4 AV			1.18 V	162	56.90	39.50
7	11000.00	60.6 PK	74.0	-13.4	1.24 V	275	44.50	16.10
8	11000.00	49.9 AV	54.0	-4.1	1.24 V	275	33.80	16.10

REMARKS:

1. Emission Level(dBuV/m) = Raw Value(dBuV) + Correction Factor(dB/m)
2. Correction Factor(dB/m) = Antenna Factor(dB/m) + Cable Factor(dB) – Pre-Amplifier Factor(dB)
3. The other emission levels were very low against the limit.
4. Margin value = Emission Level – Limit value
5. " * ": Fundamental frequency.
6. " # ": The radiated frequency is out of the restricted band.

CHANNEL	TX Channel 116	DETECTOR FUNCTION	Peak (PK)
FREQUENCY RANGE	1GHz ~ 40GHz		Average (AV)

ANTENNA POLARITY & TEST DISTANCE: HORIZONTAL AT 3 M

NO.	FREQ. (MHz)	EMISSION LEVEL (dBuV/m)	LIMIT (dBuV/m)	MARGIN (dB)	ANTENNA HEIGHT (m)	TABLE ANGLE (Degree)	RAW VALUE (dBuV)	CORRECTION FACTOR (dB/m)
1	*5580.00	108.8 PK			1.86 H	328	69.10	39.70
2	*5580.00	98.5 AV			1.86 H	328	58.80	39.70
3	11160.00	60.4 PK	74.0	-13.6	2.34 H	286	45.10	15.30
4	11160.00	47.1 AV	54.0	-6.9	2.34 H	286	31.80	15.30

ANTENNA POLARITY & TEST DISTANCE: VERTICAL AT 3 M

NO.	FREQ. (MHz)	EMISSION LEVEL (dBuV/m)	LIMIT (dBuV/m)	MARGIN (dB)	ANTENNA HEIGHT (m)	TABLE ANGLE (Degree)	RAW VALUE (dBuV)	CORRECTION FACTOR (dB/m)
1	*5580.00	113.2 PK			1.26 V	168	73.50	39.70
2	*5580.00	102.1 AV			1.26 V	168	62.40	39.70
3	11160.00	61.2 PK	74.0	-12.8	1.22 V	254	45.90	15.30
4	11160.00	50.1 AV	54.0	-3.9	1.22 V	254	34.80	15.30

REMARKS:

1. Emission Level(dBuV/m) = Raw Value(dBuV) + Correction Factor(dB/m)
2. Correction Factor(dB/m) = Antenna Factor(dB/m) + Cable Factor(dB) – Pre-Amplifier Factor(dB)
3. The other emission levels were very low against the limit.
4. Margin value = Emission Level – Limit value
5. " * ": Fundamental frequency.

CHANNEL	TX Channel 140	DETECTOR FUNCTION	Peak (PK)
FREQUENCY RANGE	1GHz ~ 40GHz		Average (AV)

ANTENNA POLARITY & TEST DISTANCE: HORIZONTAL AT 3 M

NO.	FREQ. (MHz)	EMISSION LEVEL (dBuV/m)	LIMIT (dBuV/m)	MARGIN (dB)	ANTENNA HEIGHT (m)	TABLE ANGLE (Degree)	RAW VALUE (dBuV)	CORRECTION FACTOR (dB/m)
1	*5700.00	101.3 PK			1.94 H	343	61.40	39.90
2	*5700.00	90.1 AV			1.94 H	343	50.20	39.90
3	#5760.00	58.9 PK	74.0	-15.1	1.94 H	343	55.80	3.10
4	#5760.00	47.4 AV	54.0	-6.6	1.94 H	343	44.30	3.10
5	11400.00	58.9 PK	74.0	-15.1	2.13 H	295	43.60	15.30
6	11400.00	47.3 AV	54.0	-6.7	2.13 H	295	32.00	15.30

ANTENNA POLARITY & TEST DISTANCE: VERTICAL AT 3 M

NO.	FREQ. (MHz)	EMISSION LEVEL (dBuV/m)	LIMIT (dBuV/m)	MARGIN (dB)	ANTENNA HEIGHT (m)	TABLE ANGLE (Degree)	RAW VALUE (dBuV)	CORRECTION FACTOR (dB/m)
1	*5700.00	105.1 PK			1.26 V	163	65.20	39.90
2	*5700.00	93.2 AV			1.26 V	163	53.30	39.90
3	#5760.00	59.9 PK	74.0	-14.1	1.26 V	163	56.80	3.10
4	#5760.00	48.0 AV	54.0	-6.0	1.26 V	163	44.90	3.10
5	11400.00	59.6 PK	74.0	-14.4	1.18 V	295	44.30	15.30
6	11400.00	49.0 AV	54.0	-5.0	1.18 V	295	33.70	15.30

REMARKS:

1. Emission Level(dBuV/m) = Raw Value(dBuV) + Correction Factor(dB/m)
2. Correction Factor(dB/m) = Antenna Factor(dB/m) + Cable Factor(dB) – Pre-Amplifier Factor(dB)
3. The other emission levels were very low against the limit.
4. Margin value = Emission Level – Limit value
5. " * ": Fundamental frequency.
6. " # ": The radiated frequency is out of the restricted band.

CHANNEL	TX Channel 149	DETECTOR FUNCTION	Peak (PK)
FREQUENCY RANGE	1GHz ~ 40GHz		Average (AV)

ANTENNA POLARITY & TEST DISTANCE: HORIZONTAL AT 3 M

NO.	FREQ. (MHz)	EMISSION LEVEL (dBuV/m)	LIMIT (dBuV/m)	MARGIN (dB)	ANTENNA HEIGHT (m)	TABLE ANGLE (Degree)	RAW VALUE (dBuV)	CORRECTION FACTOR (dB/m)
1	*5745.00	100.1 PK			1.17 H	347	60.20	39.90
2	*5745.00	88.8 AV			1.17 H	347	48.90	39.90
3	11490.00	59.9 PK	74.0	-14.1	2.03 H	300	45.30	14.60
4	11490.00	46.6 AV	54.0	-7.4	2.03 H	300	32.00	14.60

ANTENNA POLARITY & TEST DISTANCE: VERTICAL AT 3 M

NO.	FREQ. (MHz)	EMISSION LEVEL (dBuV/m)	LIMIT (dBuV/m)	MARGIN (dB)	ANTENNA HEIGHT (m)	TABLE ANGLE (Degree)	RAW VALUE (dBuV)	CORRECTION FACTOR (dB/m)
1	*5745.00	102.0 PK			1.59 V	171	62.10	39.90
2	*5745.00	91.5 AV			1.59 V	171	51.60	39.90
3	11490.00	60.7 PK	74.0	-13.3	1.06 V	284	46.10	14.60
4	11490.00	47.5 AV	54.0	-6.5	1.06 V	284	32.90	14.60

REMARKS:

1. Emission Level(dBuV/m) = Raw Value(dBuV) + Correction Factor(dB/m)
2. Correction Factor(dB/m) = Antenna Factor(dB/m) + Cable Factor(dB) – Pre-Amplifier Factor(dB)
3. The other emission levels were very low against the limit.
4. Margin value = Emission Level – Limit value
5. " * ": Fundamental frequency.

CHANNEL	TX Channel 157	DETECTOR FUNCTION	Peak (PK)
FREQUENCY RANGE	1GHz ~ 40GHz		Average (AV)

ANTENNA POLARITY & TEST DISTANCE: HORIZONTAL AT 3 M

NO.	FREQ. (MHz)	EMISSION LEVEL (dBuV/m)	LIMIT (dBuV/m)	MARGIN (dB)	ANTENNA HEIGHT (m)	TABLE ANGLE (Degree)	RAW VALUE (dBuV)	CORRECTION FACTOR (dB/m)
1	*5785.00	106.6 PK			1.10 H	347	66.70	39.90
2	*5785.00	95.7 AV			1.10 H	347	55.80	39.90
3	11570.00	60.4 PK	74.0	-13.6	2.36 H	288	45.90	14.50
4	11570.00	46.9 AV	54.0	-7.1	2.36 H	288	32.40	14.50

ANTENNA POLARITY & TEST DISTANCE: VERTICAL AT 3 M

NO.	FREQ. (MHz)	EMISSION LEVEL (dBuV/m)	LIMIT (dBuV/m)	MARGIN (dB)	ANTENNA HEIGHT (m)	TABLE ANGLE (Degree)	RAW VALUE (dBuV)	CORRECTION FACTOR (dB/m)
1	*5785.00	109.1 PK			1.58 V	172	69.20	39.90
2	*5785.00	98.5 AV			1.58 V	172	58.60	39.90
3	11570.00	61.8 PK	74.0	-12.2	1.20 V	261	47.30	14.50
4	11570.00	49.6 AV	54.0	-4.4	1.20 V	261	35.10	14.50

REMARKS:

1. Emission Level(dBuV/m) = Raw Value(dBuV) + Correction Factor(dB/m)
2. Correction Factor(dB/m) = Antenna Factor(dB/m) + Cable Factor(dB) – Pre-Amplifier Factor(dB)
3. The other emission levels were very low against the limit.
4. Margin value = Emission Level – Limit value
5. " * ": Fundamental frequency.

CHANNEL	TX Channel 165	DETECTOR FUNCTION	Peak (PK)
FREQUENCY RANGE	1GHz ~ 40GHz		Average (AV)

ANTENNA POLARITY & TEST DISTANCE: HORIZONTAL AT 3 M

NO.	FREQ. (MHz)	EMISSION LEVEL (dBuV/m)	LIMIT (dBuV/m)	MARGIN (dB)	ANTENNA HEIGHT (m)	TABLE ANGLE (Degree)	RAW VALUE (dBuV)	CORRECTION FACTOR (dB/m)
1	*5825.00	102.1 PK			1.10 H	343	62.10	40.00
2	*5825.00	91.5 AV			1.10 H	343	51.50	40.00
3	11650.00	61.2 PK	74.0	-12.8	1.26 H	259	46.50	14.70
4	11650.00	49.1 AV	54.0	-4.9	1.26 H	259	34.40	14.70

ANTENNA POLARITY & TEST DISTANCE: VERTICAL AT 3 M

NO.	FREQ. (MHz)	EMISSION LEVEL (dBuV/m)	LIMIT (dBuV/m)	MARGIN (dB)	ANTENNA HEIGHT (m)	TABLE ANGLE (Degree)	RAW VALUE (dBuV)	CORRECTION FACTOR (dB/m)
1	*5825.00	106.1 PK			1.67 V	176	66.10	40.00
2	*5825.00	95.9 AV			1.67 V	176	55.90	40.00
3	11650.00	61.3 PK	74.0	-12.7	1.26 V	253	46.60	14.70
4	11650.00	49.2 AV	54.0	-4.8	1.26 V	253	34.50	14.70

REMARKS:

1. Emission Level(dBuV/m) = Raw Value(dBuV) + Correction Factor(dB/m)
2. Correction Factor(dB/m) = Antenna Factor(dB/m) + Cable Factor(dB) – Pre-Amplifier Factor(dB)
3. The other emission levels were very low against the limit.
4. Margin value = Emission Level – Limit value
5. " * ": Fundamental frequency.

802.11n (40MHz)

CHANNEL	TX Channel 38	DETECTOR FUNCTION	Peak (PK)
FREQUENCY RANGE	1GHz ~ 40GHz		Average (AV)

ANTENNA POLARITY & TEST DISTANCE: HORIZONTAL AT 3 M

NO.	FREQ. (MHz)	EMISSION LEVEL (dBuV/m)	LIMIT (dBuV/m)	MARGIN (dB)	ANTENNA HEIGHT (m)	TABLE ANGLE (Degree)	RAW VALUE (dBuV)	CORRECTION FACTOR (dB/m)
1	5150.00	55.3 PK	74.0	-18.7	3.58 H	339	53.20	2.10
2	5150.00	43.4 AV	54.0	-10.6	3.58 H	339	41.30	2.10
3	*5190.00	97.5 PK			3.59 H	339	58.50	39.00
4	*5190.00	86.4 AV			3.59 H	339	47.40	39.00
5	#10380.00	58.9 PK	74.0	-15.1	2.49 H	169	44.30	14.60
6	#10380.00	47.3 AV	54.0	-6.7	2.49 H	169	32.70	14.60

ANTENNA POLARITY & TEST DISTANCE: VERTICAL AT 3 M

NO.	FREQ. (MHz)	EMISSION LEVEL (dBuV/m)	LIMIT (dBuV/m)	MARGIN (dB)	ANTENNA HEIGHT (m)	TABLE ANGLE (Degree)	RAW VALUE (dBuV)	CORRECTION FACTOR (dB/m)
1	5150.00	56.1 PK	74.0	-17.9	1.00 V	170	54.00	2.10
2	5150.00	44.5 AV	54.0	-9.5	1.00 V	170	42.40	2.10
3	*5190.00	99.2 PK			1.00 V	170	60.20	39.00
4	*5190.00	89.4 AV			1.00 V	170	50.40	39.00
5	#10380.00	59.4 PK	74.0	-14.6	1.66 V	17	44.80	14.60
6	#10380.00	50.0 AV	54.0	-4.0	1.66 V	17	35.40	14.60

REMARKS:

1. Emission Level(dBuV/m) = Raw Value(dBuV) + Correction Factor(dB/m)
2. Correction Factor(dB/m) = Antenna Factor(dB/m) + Cable Factor(dB) – Pre-Amplifier Factor(dB)
3. The other emission levels were very low against the limit.
4. Margin value = Emission Level – Limit value
5. " * ": Fundamental frequency.
6. " # ": The radiated frequency is out of the restricted band.

CHANNEL	TX Channel 46	DETECTOR FUNCTION	Peak (PK)
FREQUENCY RANGE	1GHz ~ 40GHz		Average (AV)

ANTENNA POLARITY & TEST DISTANCE: HORIZONTAL AT 3 M

NO.	FREQ. (MHz)	EMISSION LEVEL (dBuV/m)	LIMIT (dBuV/m)	MARGIN (dB)	ANTENNA HEIGHT (m)	TABLE ANGLE (Degree)	RAW VALUE (dBuV)	CORRECTION FACTOR (dB/m)
1	*5230.00	98.3 PK			3.24 H	351	59.30	39.00
2	*5230.00	88.2 AV			3.24 H	351	49.20	39.00
3	5350.00	54.8 PK	74.0	-19.2	3.24 H	351	52.20	2.60
4	5350.00	43.4 AV	54.0	-10.6	3.24 H	351	40.80	2.60
5	#10460.00	58.9 PK	74.0	-15.1	2.37 H	263	44.70	14.20
6	#10460.00	47.4 AV	54.0	-6.6	2.37 H	263	33.20	14.20

ANTENNA POLARITY & TEST DISTANCE: VERTICAL AT 3 M

NO.	FREQ. (MHz)	EMISSION LEVEL (dBuV/m)	LIMIT (dBuV/m)	MARGIN (dB)	ANTENNA HEIGHT (m)	TABLE ANGLE (Degree)	RAW VALUE (dBuV)	CORRECTION FACTOR (dB/m)
1	*5230.00	102.1 PK			1.30 V	172	63.10	39.00
2	*5230.00	90.8 AV			1.30 V	172	51.80	39.00
3	5350.00	56.9 PK	74.0	-17.1	1.30 V	172	54.30	2.60
4	5350.00	44.8 AV	54.0	-9.2	1.30 V	172	42.20	2.60
5	#10460.00	60.3 PK	74.0	-13.7	2.56 V	342	46.10	14.20
6	#10460.00	49.4 AV	54.0	-4.6	2.56 V	342	35.20	14.20

REMARKS:

1. Emission Level(dBuV/m) = Raw Value(dBuV) + Correction Factor(dB/m)
2. Correction Factor(dB/m) = Antenna Factor(dB/m) + Cable Factor(dB) – Pre-Amplifier Factor(dB)
3. The other emission levels were very low against the limit.
4. Margin value = Emission Level – Limit value
5. " * " : Fundamental frequency.
6. " # " : The radiated frequency is out of the restricted band.

CHANNEL	TX Channel 54	DETECTOR FUNCTION	Peak (PK)
FREQUENCY RANGE	1GHz ~ 40GHz		Average (AV)

ANTENNA POLARITY & TEST DISTANCE: HORIZONTAL AT 3 M

NO.	FREQ. (MHz)	EMISSION LEVEL (dBuV/m)	LIMIT (dBuV/m)	MARGIN (dB)	ANTENNA HEIGHT (m)	TABLE ANGLE (Degree)	RAW VALUE (dBuV)	CORRECTION FACTOR (dB/m)
1	5150.00	56.0 PK	74.0	-18.0	3.59 H	163	53.90	2.10
2	5150.00	42.9 AV	54.0	-11.1	3.59 H	163	40.80	2.10
3	*5270.00	98.9 PK			3.59 H	163	59.70	39.20
4	*5270.00	88.7 AV			3.59 H	163	49.50	39.20
5	#10540.00	58.6 PK	74.0	-15.4	2.22 H	204	44.30	14.30
6	#10540.00	47.8 AV	54.0	-6.2	2.22 H	204	33.50	14.30

ANTENNA POLARITY & TEST DISTANCE: VERTICAL AT 3 M

NO.	FREQ. (MHz)	EMISSION LEVEL (dBuV/m)	LIMIT (dBuV/m)	MARGIN (dB)	ANTENNA HEIGHT (m)	TABLE ANGLE (Degree)	RAW VALUE (dBuV)	CORRECTION FACTOR (dB/m)
1	5150.00	57.5 PK	74.0	-16.5	1.29 V	172	55.40	2.10
2	5150.00	45.4 AV	54.0	-8.6	1.29 V	172	43.30	2.10
3	*5270.00	101.7 PK			1.29 V	172	62.50	39.20
4	*5270.00	91.9 AV			1.29 V	172	52.70	39.20
5	#10540.00	60.5 PK	74.0	-13.5	2.04 V	61	46.20	14.30
6	#10540.00	49.5 AV	54.0	-4.5	2.04 V	61	35.20	14.30

REMARKS:

1. Emission Level(dBuV/m) = Raw Value(dBuV) + Correction Factor(dB/m)
2. Correction Factor(dB/m) = Antenna Factor(dB/m) + Cable Factor(dB) – Pre-Amplifier Factor(dB)
3. The other emission levels were very low against the limit.
4. Margin value = Emission Level – Limit value
5. " * " : Fundamental frequency.
6. " # " : The radiated frequency is out of the restricted band.

CHANNEL	TX Channel 62	DETECTOR FUNCTION	Peak (PK)
FREQUENCY RANGE	1GHz ~ 40GHz		Average (AV)

ANTENNA POLARITY & TEST DISTANCE: HORIZONTAL AT 3 M

NO.	FREQ. (MHz)	EMISSION LEVEL (dBuV/m)	LIMIT (dBuV/m)	MARGIN (dB)	ANTENNA HEIGHT (m)	TABLE ANGLE (Degree)	RAW VALUE (dBuV)	CORRECTION FACTOR (dB/m)
1	*5310.00	97.6 PK			3.51 H	126	58.40	39.20
2	*5310.00	87.5 AV			3.51 H	126	48.30	39.20
3	5350.00	53.9 PK	74.0	-20.1	3.51 H	126	51.30	2.60
4	5350.00	43.4 AV	54.0	-10.6	3.51 H	126	40.80	2.60
5	10620.00	59.0 PK	74.0	-15.0	1.17 H	151	44.30	14.70
6	10620.00	47.5 AV	54.0	-6.5	1.17 H	151	32.80	14.70

ANTENNA POLARITY & TEST DISTANCE: VERTICAL AT 3 M

NO.	FREQ. (MHz)	EMISSION LEVEL (dBuV/m)	LIMIT (dBuV/m)	MARGIN (dB)	ANTENNA HEIGHT (m)	TABLE ANGLE (Degree)	RAW VALUE (dBuV)	CORRECTION FACTOR (dB/m)
1	*5310.00	99.8 PK			1.00 V	159	60.60	39.20
2	*5310.00	89.9 AV			1.00 V	159	50.70	39.20
3	5350.00	56.0 PK	74.0	-18.0	1.00 V	159	53.40	2.60
4	5350.00	45.0 AV	54.0	-9.0	1.00 V	159	42.40	2.60
5	10620.00	60.3 PK	74.0	-13.7	2.51 V	45	45.60	14.70
6	10620.00	50.0 AV	54.0	-4.0	2.51 V	45	35.30	14.70

REMARKS:

1. Emission Level(dBuV/m) = Raw Value(dBuV) + Correction Factor(dB/m)
2. Correction Factor(dB/m) = Antenna Factor(dB/m) + Cable Factor(dB) – Pre-Amplifier Factor(dB)
3. The other emission levels were very low against the limit.
4. Margin value = Emission Level – Limit value
5. " * ": Fundamental frequency.

CHANNEL	TX Channel 102	DETECTOR FUNCTION	Peak (PK)
FREQUENCY RANGE	1GHz ~ 40GHz		Average (AV)

ANTENNA POLARITY & TEST DISTANCE: HORIZONTAL AT 3 M

NO.	FREQ. (MHz)	EMISSION LEVEL (dBuV/m)	LIMIT (dBuV/m)	MARGIN (dB)	ANTENNA HEIGHT (m)	TABLE ANGLE (Degree)	RAW VALUE (dBuV)	CORRECTION FACTOR (dB/m)
1	5405.00	57.5 PK	74.0	-16.5	1.85 H	340	54.80	2.70
2	5405.00	44.6 AV	54.0	-9.4	1.85 H	340	41.90	2.70
3	#5470.00	58.0 PK	74.0	-16.0	1.85 H	340	55.30	2.70
4	#5470.00	45.0 AV	54.0	-9.0	1.85 H	340	42.30	2.70
5	*5510.00	100.3 PK			1.85 H	340	60.80	39.50
6	*5510.00	90.7 AV			1.85 H	340	51.20	39.50
7	11020.00	60.7 PK	74.0	-13.3	2.38 H	276	44.80	15.90
8	11020.00	48.2 AV	54.0	-5.8	2.38 H	276	32.30	15.90

ANTENNA POLARITY & TEST DISTANCE: VERTICAL AT 3 M

NO.	FREQ. (MHz)	EMISSION LEVEL (dBuV/m)	LIMIT (dBuV/m)	MARGIN (dB)	ANTENNA HEIGHT (m)	TABLE ANGLE (Degree)	RAW VALUE (dBuV)	CORRECTION FACTOR (dB/m)
1	5405.00	60.0 PK	74.0	-14.0	1.13 V	172	57.30	2.70
2	5405.00	46.5 AV	54.0	-7.5	1.13 V	172	43.80	2.70
3	#5470.00	60.3 PK	74.0	-13.7	1.13 V	172	57.60	2.70
4	#5470.00	46.7 AV	54.0	-7.3	1.13 V	172	44.00	2.70
5	*5510.00	104.4 PK			1.13 V	172	64.90	39.50
6	*5510.00	93.2 AV			1.13 V	172	53.70	39.50
7	11020.00	61.2 PK	74.0	-12.8	1.26 V	293	45.30	15.90
8	11020.00	49.8 AV	54.0	-4.2	1.26 V	293	33.90	15.90

REMARKS:

1. Emission Level(dBuV/m) = Raw Value(dBuV) + Correction Factor(dB/m)
2. Correction Factor(dB/m) = Antenna Factor(dB/m) + Cable Factor(dB) – Pre-Amplifier Factor(dB)
3. The other emission levels were very low against the limit.
4. Margin value = Emission Level – Limit value
5. " * ": Fundamental frequency.
6. " # ": The radiated frequency is out of the restricted band.

CHANNEL	TX Channel 110	DETECTOR FUNCTION	Peak (PK)
FREQUENCY RANGE	1GHz ~ 40GHz		Average (AV)

ANTENNA POLARITY & TEST DISTANCE: HORIZONTAL AT 3 M

NO.	FREQ. (MHz)	EMISSION LEVEL (dBuV/m)	LIMIT (dBuV/m)	MARGIN (dB)	ANTENNA HEIGHT (m)	TABLE ANGLE (Degree)	RAW VALUE (dBuV)	CORRECTION FACTOR (dB/m)
1	*5550.00	100.8 PK			1.84 H	316	61.20	39.60
2	*5550.00	90.5 AV			1.84 H	316	50.90	39.60
3	11100.00	59.1 PK	74.0	-14.9	2.18 H	274	43.80	15.30
4	11100.00	47.9 AV	54.0	-6.1	2.18 H	274	32.60	15.30

ANTENNA POLARITY & TEST DISTANCE: VERTICAL AT 3 M

NO.	FREQ. (MHz)	EMISSION LEVEL (dBuV/m)	LIMIT (dBuV/m)	MARGIN (dB)	ANTENNA HEIGHT (m)	TABLE ANGLE (Degree)	RAW VALUE (dBuV)	CORRECTION FACTOR (dB/m)
1	*5550.00	105.1 PK			1.06 V	158	65.50	39.60
2	*5550.00	93.9 AV			1.06 V	158	54.30	39.60
3	11100.00	59.8 PK	74.0	-14.2	1.10 V	301	44.50	15.30
4	11100.00	48.4 AV	54.0	-5.6	1.10 V	301	33.10	15.30

REMARKS:

1. Emission Level(dBuV/m) = Raw Value(dBuV) + Correction Factor(dB/m)
2. Correction Factor(dB/m) = Antenna Factor(dB/m) + Cable Factor(dB) – Pre-Amplifier Factor(dB)
3. The other emission levels were very low against the limit.
4. Margin value = Emission Level – Limit value
5. " * ": Fundamental frequency.

CHANNEL	TX Channel 134	DETECTOR FUNCTION	Peak (PK)
FREQUENCY RANGE	1GHz ~ 40GHz		Average (AV)

ANTENNA POLARITY & TEST DISTANCE: HORIZONTAL AT 3 M

NO.	FREQ. (MHz)	EMISSION LEVEL (dBuV/m)	LIMIT (dBuV/m)	MARGIN (dB)	ANTENNA HEIGHT (m)	TABLE ANGLE (Degree)	RAW VALUE (dBuV)	CORRECTION FACTOR (dB/m)
1	*5670.00	97.4 PK			1.83 H	326	57.60	39.80
2	*5670.00	88.2 AV			1.83 H	326	48.40	39.80
3	#5760.00	58.4 PK	74.0	-15.6	1.83 H	326	55.30	3.10
4	#5760.00	46.4 AV	54.0	-7.6	1.83 H	326	43.30	3.10
5	11340.00	59.9 PK	74.0	-14.1	2.10 H	289	44.10	15.80
6	11340.00	48.1 AV	54.0	-5.9	2.10 H	289	32.30	15.80

ANTENNA POLARITY & TEST DISTANCE: VERTICAL AT 3 M

NO.	FREQ. (MHz)	EMISSION LEVEL (dBuV/m)	LIMIT (dBuV/m)	MARGIN (dB)	ANTENNA HEIGHT (m)	TABLE ANGLE (Degree)	RAW VALUE (dBuV)	CORRECTION FACTOR (dB/m)
1	*5670.00	102.1 PK			1.03 V	165	62.30	39.80
2	*5670.00	91.2 AV			1.03 V	165	51.40	39.80
3	#5760.00	59.4 PK	74.0	-14.6	1.03 V	165	56.30	3.10
4	#5760.00	49.7 AV	54.0	-4.3	1.03 V	165	46.60	3.10
5	11340.00	61.0 PK	74.0	-13.0	1.23 V	287	45.20	15.80
6	11340.00	50.3 AV	54.0	-3.7	1.23 V	287	34.50	15.80

REMARKS:

1. Emission Level(dBuV/m) = Raw Value(dBuV) + Correction Factor(dB/m)
2. Correction Factor(dB/m) = Antenna Factor(dB/m) + Cable Factor(dB) – Pre-Amplifier Factor(dB)
3. The other emission levels were very low against the limit.
4. Margin value = Emission Level – Limit value
5. " * ": Fundamental frequency.
6. " # ": The radiated frequency is out of the restricted band.

CHANNEL	TX Channel 151	DETECTOR FUNCTION	Peak (PK)
FREQUENCY RANGE	1GHz ~ 40GHz		Average (AV)

ANTENNA POLARITY & TEST DISTANCE: HORIZONTAL AT 3 M

NO.	FREQ. (MHz)	EMISSION LEVEL (dBuV/m)	LIMIT (dBuV/m)	MARGIN (dB)	ANTENNA HEIGHT (m)	TABLE ANGLE (Degree)	RAW VALUE (dBuV)	CORRECTION FACTOR (dB/m)
1	*5755.00	98.4 PK			1.39 H	347	58.50	39.90
2	*5755.00	87.1 AV			1.39 H	347	47.20	39.90
3	11510.00	60.4 PK	74.0	-13.6	2.00 H	294	45.90	14.50
4	11510.00	46.6 AV	54.0	-7.4	2.00 H	294	32.10	14.50

ANTENNA POLARITY & TEST DISTANCE: VERTICAL AT 3 M

NO.	FREQ. (MHz)	EMISSION LEVEL (dBuV/m)	LIMIT (dBuV/m)	MARGIN (dB)	ANTENNA HEIGHT (m)	TABLE ANGLE (Degree)	RAW VALUE (dBuV)	CORRECTION FACTOR (dB/m)
1	*5755.00	101.0 PK			1.71 V	173	61.10	39.90
2	*5755.00	90.0 AV			1.71 V	173	50.10	39.90
3	11510.00	61.3 PK	74.0	-12.7	1.32 V	294	46.80	14.50
4	11510.00	47.6 AV	54.0	-6.4	1.32 V	294	33.10	14.50

REMARKS:

1. Emission Level(dBuV/m) = Raw Value(dBuV) + Correction Factor(dB/m)
2. Correction Factor(dB/m) = Antenna Factor(dB/m) + Cable Factor(dB) – Pre-Amplifier Factor(dB)
3. The other emission levels were very low against the limit.
4. Margin value = Emission Level – Limit value
5. " * ": Fundamental frequency.

CHANNEL	TX Channel 159	DETECTOR FUNCTION	Peak (PK)
FREQUENCY RANGE	1GHz ~ 40GHz		Average (AV)

ANTENNA POLARITY & TEST DISTANCE: HORIZONTAL AT 3 M

NO.	FREQ. (MHz)	EMISSION LEVEL (dBuV/m)	LIMIT (dBuV/m)	MARGIN (dB)	ANTENNA HEIGHT (m)	TABLE ANGLE (Degree)	RAW VALUE (dBuV)	CORRECTION FACTOR (dB/m)
1	*5795.00	97.8 PK			1.07 H	347	57.90	39.90
2	*5795.00	85.1 AV			1.07 H	347	45.20	39.90
3	11590.00	60.3 PK	74.0	-13.7	1.93 H	286	45.90	14.40
4	11590.00	46.8 AV	54.0	-7.2	1.93 H	286	32.40	14.40

ANTENNA POLARITY & TEST DISTANCE: VERTICAL AT 3 M

NO.	FREQ. (MHz)	EMISSION LEVEL (dBuV/m)	LIMIT (dBuV/m)	MARGIN (dB)	ANTENNA HEIGHT (m)	TABLE ANGLE (Degree)	RAW VALUE (dBuV)	CORRECTION FACTOR (dB/m)
1	*5795.00	100.7 PK			1.23 V	165	60.80	39.90
2	*5795.00	89.3 AV			1.23 V	165	49.40	39.90
3	11590.00	60.9 PK	74.0	-13.1	1.06 V	284	46.50	14.40
4	11590.00	47.6 AV	54.0	-6.4	1.06 V	284	33.20	14.40

REMARKS:

1. Emission Level(dBuV/m) = Raw Value(dBuV) + Correction Factor(dB/m)
2. Correction Factor(dB/m) = Antenna Factor(dB/m) + Cable Factor(dB) – Pre-Amplifier Factor(dB)
3. The other emission levels were very low against the limit.
4. Margin value = Emission Level – Limit value
5. " * ": Fundamental frequency.

9 kHz ~ 30 MHz DATA:

The amplitude of spurious emissions attenuated more than 20 dB below the permissible value is not required to be report.

30 MHz ~ 1 GHz WORST-CASE DATA:

802.11a

CHANNEL	TX Channel 100	DETECTOR FUNCTION	Quasi-Peak (QP)
FREQUENCY RANGE	30MHz ~ 1GHz		

ANTENNA POLARITY & TEST DISTANCE: HORIZONTAL AT 3 M

NO.	FREQ. (MHz)	EMISSION LEVEL (dBuV/m)	LIMIT (dBuV/m)	MARGIN (dB)	ANTENNA HEIGHT (m)	TABLE ANGLE (Degree)	RAW VALUE (dBuV)	CORRECTION FACTOR (dB/m)
1	31.94	30.1 QP	40.0	-9.9	2.00 H	17	46.10	-16.00
2	92.08	29.4 QP	43.5	-14.1	2.00 H	53	48.60	-19.20
3	148.34	23.5 QP	43.5	-20.0	2.00 H	237	36.80	-13.30
4	198.78	21.4 QP	43.5	-22.1	1.01 H	201	37.10	-15.70
5	297.72	23.2 QP	46.0	-22.8	1.01 H	277	34.50	-11.30
6	897.18	34.9 QP	46.0	-11.1	1.01 H	33	32.40	2.50

ANTENNA POLARITY & TEST DISTANCE: VERTICAL AT 3 M

NO.	FREQ. (MHz)	EMISSION LEVEL (dBuV/m)	LIMIT (dBuV/m)	MARGIN (dB)	ANTENNA HEIGHT (m)	TABLE ANGLE (Degree)	RAW VALUE (dBuV)	CORRECTION FACTOR (dB/m)
1	33.88	32.5 QP	40.0	-7.5	1.00 V	348	48.00	-15.50
2	68.80	32.8 QP	40.0	-7.2	1.24 V	295	48.30	-15.50
3	86.26	29.5 QP	40.0	-10.5	1.00 V	240	48.60	-19.10
4	158.04	19.4 QP	43.5	-24.1	1.24 V	279	32.40	-13.00
5	429.64	27.1 QP	46.0	-18.9	1.24 V	217	35.20	-8.10
6	943.74	37.2 QP	46.0	-8.8	1.49 V	357	33.50	3.70

REMARKS:

1. Emission Level(dBuV/m) = Raw Value(dBuV) + Correction Factor(dB/m)
2. Correction Factor(dB/m) = Antenna Factor(dB/m) + Cable Factor(dB) – Pre-Amplifier Factor(dB)
3. The other emission levels were very low against the limit.
4. Margin value = Emission Level – Limit value

4.2 Conducted Emission Measurement

4.2.1 Limits of Conducted Emission Measurement

Frequency (MHz)	Conducted Limit (dBuV)	
	Quasi-peak	Average
0.15 - 0.5	66 - 56	56 - 46
0.50 - 5.0	56	46
5.0 - 30.0	60	50

Note: 1. The lower limit shall apply at the transition frequencies.

2. The limit decreases in line with the logarithm of the frequency in the range of 0.15 to 0.50 MHz.

4.2.2 Test Instruments

Description & Manufacturer	Model No.	Serial No.	Date Of Calibration	Due Date Of Calibration
Test Receiver ROHDE & SCHWARZ	ESCI	100613	Nov. 21, 2016	Nov. 20, 2017
RF signal cable (with 10dB PAD) Woken	5D-FB	Cable-cond1-01	Dec. 22, 2016	Dec. 21, 2017
LISN/AMN ROHDE & SCHWARZ (EUT)	ESH3-Z5	835239/001	Mar. 10, 2017	Mar. 09, 2018
LISN/AMN ROHDE & SCHWARZ (Peripheral)	ESH3-Z5	100311	Jul. 28, 2016	Jul. 27, 2017
Software ADT	BV ADT_Cond_ V7.3.7.3	NA	NA	NA

- Note:**
1. The calibration interval of the above test instruments is 12 months and the calibrations are traceable to NML/ROC and NIST/USA.
 2. The test was performed in HwaYa Shielded Room 1.
 3. The VCCI Site Registration No. is C-2040.

4.2.3 Test Procedures

- a. The EUT was placed 0.4 meters from the conducting wall of the shielded room with EUT being connected to the power mains through a line impedance stabilization network (LISN). Other support units were connected to the power mains through another LISN. The two LISNs provide 50 ohm/ 50uH of coupling impedance for the measuring instrument.
- b. Both lines of the power mains connected to the EUT were checked for maximum conducted interference.
- c. The frequency range from 150 kHz to 30 MHz was searched. Emission levels under (Limit -20 dB) was not recorded.

Note: All modes of operation were investigated and the worst-case emissions are reported.

4.2.4 Deviation from Test Standard

No deviation.

4.2.5 Test Setup

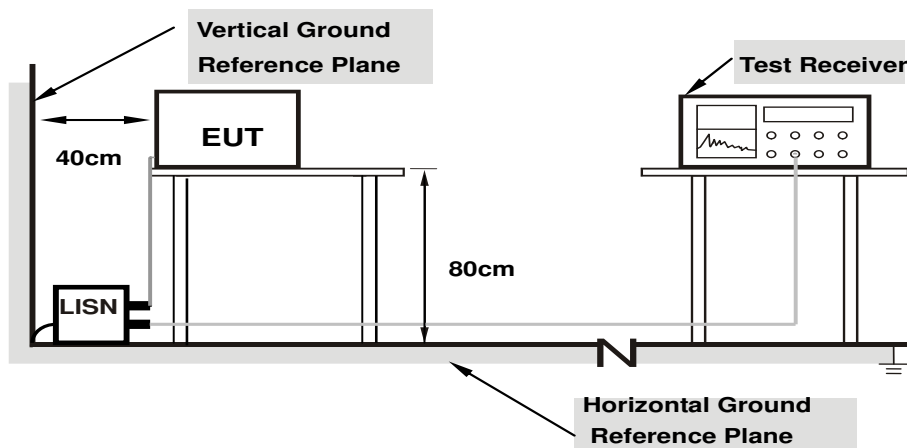

- Note:**
- 1.Support units were connected to second LISN.
 - 2.Both of LISNs (AMN) are 80 cm from EUT and at least 80 from other units and other metal planes

For the actual test configuration, please refer to the attached file (Test Setup Photo).

4.2.6 EUT Operating Conditions

- a. Placed the EUT on a testing table.
- b. Use the software to control the EUT under transmission condition continuously at specific channel frequency.

4.2.7 Test Results

Frequency Range	150kHz ~ 30MHz	Detector Function & Resolution Bandwidth	Quasi-Peak (QP) / Average (AV), 9kHz
Input Power	120Vac, 60Hz	Environmental Conditions	25°C, 65%RH
Tested by	Getaz Yang	Test Date	2017/4/21

Phase Of Power : Line (L)										
No	Frequency (MHz)	Correction Factor (dB)	Reading Value (dBuV)		Emission Level (dBuV)		Limit (dBuV)		Margin (dB)	
			Q.P.	AV.	Q.P.	AV.	Q.P.	AV.	Q.P.	AV.
1	0.16955	10.35	38.13	29.03	48.48	39.38	64.98	54.98	-16.50	-15.60
2	0.24775	10.38	28.29	16.17	38.67	26.55	61.83	51.83	-23.16	-25.28
3	0.65044	10.40	26.52	19.11	36.92	29.51	56.00	46.00	-19.08	-16.49
4	1.06885	10.40	28.94	18.75	39.34	29.15	56.00	46.00	-16.66	-16.85
5	2.82444	10.51	28.13	17.01	38.64	27.52	56.00	46.00	-17.36	-18.48
6	4.20467	10.58	27.14	16.55	37.72	27.13	56.00	46.00	-18.28	-18.87

Remarks:

1. Q.P. and AV. are abbreviations of quasi-peak and average individually.
2. The emission levels of other frequencies were very low against the limit.
3. Margin value = Emission level – Limit value
4. Correction factor = Insertion loss + Cable loss
5. Emission Level = Correction Factor + Reading Value

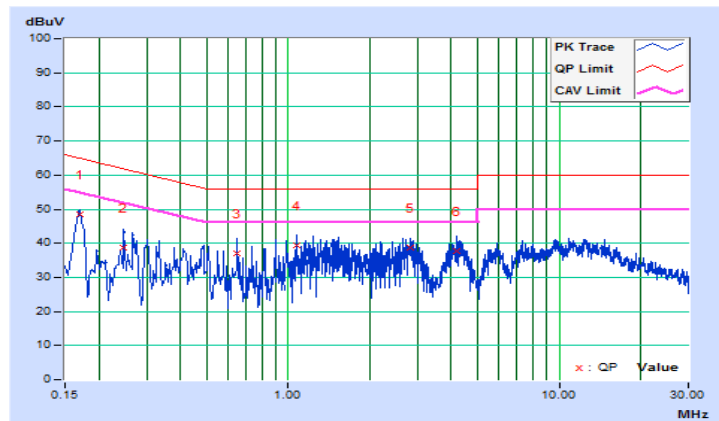

Frequency Range	150kHz ~ 30MHz	Detector Function & Resolution Bandwidth	Quasi-Peak (QP) / Average (AV), 9kHz
Input Power	120Vac, 60Hz	Environmental Conditions	25°C, 65%RH
Tested by	Getaz Yang	Test Date	2017/4/21

Phase Of Power : Neutral (N)										
No	Frequency (MHz)	Correction Factor (dB)	Reading Value (dBuV)		Emission Level (dBuV)		Limit (dBuV)		Margin (dB)	
			Q.P.	AV.	Q.P.	AV.	Q.P.	AV.	Q.P.	AV.
1	0.17328	10.12	44.38	29.06	54.50	39.18	64.80	54.80	-10.30	-15.62
2	0.25557	10.15	37.21	23.86	47.36	34.01	61.57	51.57	-14.21	-17.56
3	0.41233	10.16	33.44	22.07	43.60	32.23	57.60	47.60	-14.00	-15.37
4	0.65044	10.16	34.08	24.86	44.24	35.02	56.00	46.00	-11.76	-10.98
5	0.81861	10.17	32.96	23.68	43.13	33.85	56.00	46.00	-12.87	-12.15
6	2.66022	10.27	24.99	14.74	35.26	25.01	56.00	46.00	-20.74	-20.99

Remarks:

1. Q.P. and AV. are abbreviations of quasi-peak and average individually.
2. The emission levels of other frequencies were very low against the limit.
3. Margin value = Emission level – Limit value
4. Correction factor = Insertion loss + Cable loss
5. Emission Level = Correction Factor + Reading Value

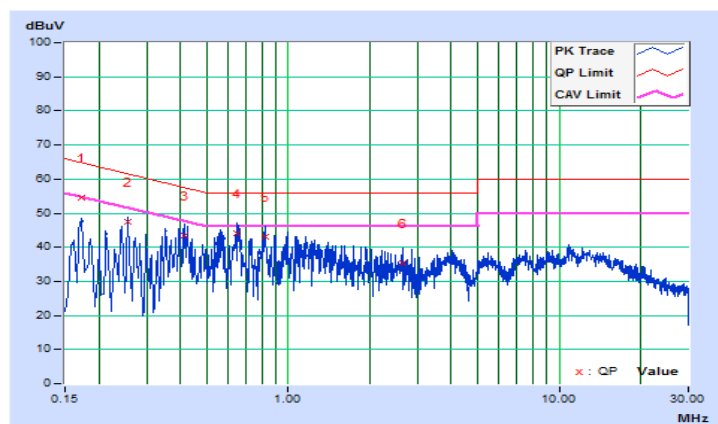

4.3 Transmit Power Measurement

4.3.1 Limits of Transmit Power Measurement

Operation Band	EUT Category	Limit
U-NII-1	Outdoor Access Point	1 Watt (30 dBm) (Max. e.i.r.p \leq 125 mW (21 dBm) at any elevation angle above 30 degrees as measured from the horizon)
	Fixed point-to-point Access Point	1 Watt (30 dBm)
	Indoor Access Point	1 Watt (30 dBm)
	√ Mobile and Portable client device	250 mW (24 dBm)
U-NII-2A	√	250 mW (24 dBm) or 11 dBm+10 log B*
U-NII-2C	√	250 mW (24 dBm) or 11 dBm+10 log B*
U-NII-3	√	1 Watt (30 dBm)

*B is the 26 dB emission bandwidth in megahertz

4.3.2 Test Setup

<Power Output Measurement>

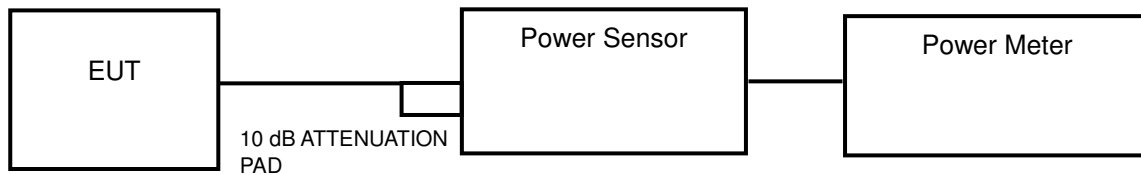

<26 dB Bandwidth>

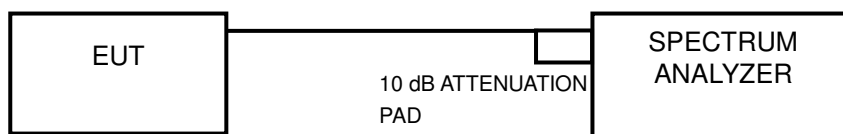

4.3.3 Test Instruments

Refer to section 4.1.2 to get information of above instrument.

4.3.4 Test Procedure

Average Power Measurement

<802.11a, 802.11n (HT20), 802.11n (HT40)>

Method PM is used to perform output power measurement, trigger and gating function of wide band power meter is enabled to measure max output power of TX on burst. Duty factor is not added to measured value.

26 dB Bandwidth

- 1) Set RBW = approximately 1 % of the emission bandwidth.
- 2) Set the VBW > RBW.
- 3) Detector = Peak.
- 4) Trace mode = max hold.
- 5) Measure the maximum width of the emission that is 26 dB down from the peak of the emission. Compare this with the RBW setting of the analyzer. Readjust RBW and repeat measurement as needed until the RBW/EBW ratio is approximately 1 %.

4.3.5 Deviation from Test Standard

No deviation.

4.3.6 EUT Operating Conditions

The software provided by client to enable the EUT under transmission condition continuously at lowest, middle and highest channel frequencies individually.

4.3.7 Test Result

Power Output:

802.11a

Channel	Frequency (MHz)	Maximum Conducted Power (mW)	Maximum Conducted Power (dBm)	Power Limit (dBm)	Pass / Fail
36	5180	36.983	15.68	24	Pass
44	5220	78.343	18.94	24	Pass
48	5240	79.25	18.99	24	Pass
52	5260	81.846	19.13	24	Pass
60	5300	79.433	19.00	24	Pass
64	5320	36.813	15.66	24	Pass
100	5500	24.66	13.92	24	Pass
116	5580	80.538	19.06	24	Pass
140	5700	20.559	13.13	24	Pass
149	5745	15.276	11.84	30	Pass
157	5785	92.683	19.67	30	Pass
165	5825	36.392	15.61	30	Pass

Note:

For U-NII-2A, U-NII-2C Band:

- $11 \text{ dBm} + 10\log(40.26) = 27.04 \text{ dBm} > 24 \text{ dBm}$.
- $11 \text{ dBm} + 10\log(39.84) = 27 \text{ dBm} > 24 \text{ dBm}$.
- $11 \text{ dBm} + 10\log(22.50) = 24.52 \text{ dBm} > 24 \text{ dBm}$.
- $11 \text{ dBm} + 10\log(22.44) = 24.51 \text{ dBm} > 24 \text{ dBm}$.
- $11 \text{ dBm} + 10\log(39.99) = 27.01 \text{ dBm} > 24 \text{ dBm}$.
- $11 \text{ dBm} + 10\log(22.42) = 24.5 \text{ dBm} > 24 \text{ dBm}$.

802.11n (HT20)

Channel	Frequency (MHz)	Maximum Conducted Power (mW)	Maximum Conducted Power (dBm)	Power Limit (dBm)	Pass / Fail
36	5180	36.559	15.63	24	Pass
44	5220	83.56	19.22	24	Pass
48	5240	82.794	19.18	24	Pass
52	5260	83.753	19.23	24	Pass
60	5300	79.983	19.03	24	Pass
64	5320	35.075	15.45	24	Pass
100	5500	22.439	13.51	24	Pass
116	5580	83.946	19.24	24	Pass
140	5700	25.293	14.03	24	Pass
149	5745	16.52	12.18	30	Pass
157	5785	94.406	19.75	30	Pass
165	5825	36.898	15.67	30	Pass

Note:

For U-NII-2A, U-NII-2C Band:

1. $11 \text{ dBm} + 10\log(42.62) = 27.29 \text{ dBm} > 24 \text{ dBm}$.
2. $11 \text{ dBm} + 10\log(40.58) = 27.08 \text{ dBm} > 24 \text{ dBm}$.
3. $11 \text{ dBm} + 10\log(23.06) = 24.62 \text{ dBm} > 24 \text{ dBm}$.
4. $11 \text{ dBm} + 10\log(22.69) = 24.55 \text{ dBm} > 24 \text{ dBm}$.
5. $11 \text{ dBm} + 10\log(43.84) = 27.41 \text{ dBm} > 24 \text{ dBm}$.
6. $11 \text{ dBm} + 10\log(22.82) = 24.58 \text{ dBm} > 24 \text{ dBm}$.

802.11n (HT40)

Channel	Frequency (MHz)	Maximum Conducted Power (mW)	Maximum Conducted Power (dBm)	Power Limit (dBm)	Pass / Fail
38	5190	18.072	12.57	24	Pass
46	5230	19.364	12.87	24	Pass
54	5270	19.099	12.81	24	Pass
62	5310	18.03	12.56	24	Pass
102	5510	17.865	12.52	24	Pass
110	5550	18.923	12.77	24	Pass
134	5670	21.478	13.32	24	Pass
151	5755	17.742	12.49	30	Pass
159	5795	17.179	12.35	30	Pass

Note:

For U-NII-2A, U-NII-2C Band:

1. $11 \text{ dBm} + 10\log(46.25) = 27.65 \text{ dBm} > 24 \text{ dBm}$.
2. $11 \text{ dBm} + 10\log(45.96) = 27.62 \text{ dBm} > 24 \text{ dBm}$.
3. $11 \text{ dBm} + 10\log(45.95) = 27.62 \text{ dBm} > 24 \text{ dBm}$.
4. $11 \text{ dBm} + 10\log(45.81) = 27.6 \text{ dBm} > 24 \text{ dBm}$.
5. $11 \text{ dBm} + 10\log(45.75) = 27.6 \text{ dBm} > 24 \text{ dBm}$.

26 dB Bandwidth:
802.11a

Channel	Frequency (MHz)	26 dBc Bandwidth (MHz)
36	5180	22.47
44	5220	40.19
48	5240	41.51
52	5260	40.26
60	5300	39.84
64	5320	22.50
100	5500	22.44
116	5580	39.99
140	5700	22.42

802.11n (HT20)

Channel	Frequency (MHz)	26 dBc Bandwidth (MHz)
36	5180	22.65
44	5220	42.71
48	5240	43.33
52	5260	42.62
60	5300	40.58
64	5320	23.06
100	5500	22.69
116	5580	43.84
140	5700	22.82

802.11n (HT40)

Channel	Frequency (MHz)	26 dBc Bandwidth (MHz)
38	5190	46.69
46	5230	46.22
54	5270	46.25
62	5310	45.96
102	5510	45.95
110	5550	45.81
134	5670	45.75

Spectrum Plot of Worst Value

802.11a

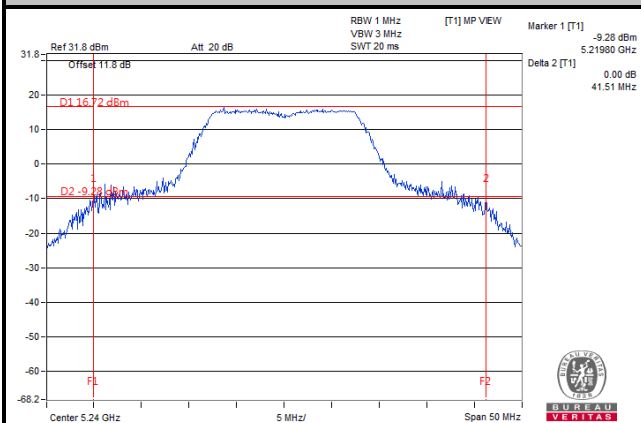

802.11n (HT20)

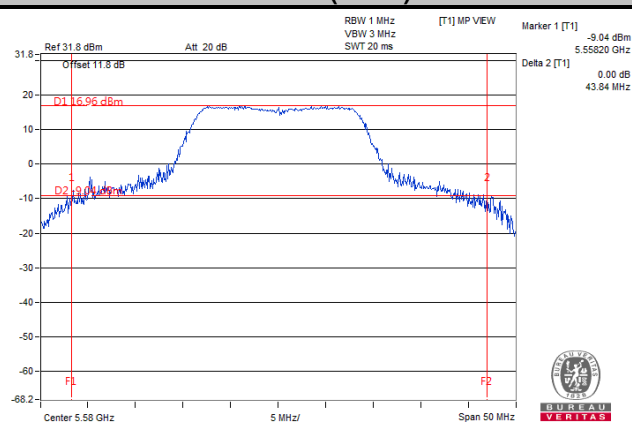

802.11n (HT40)

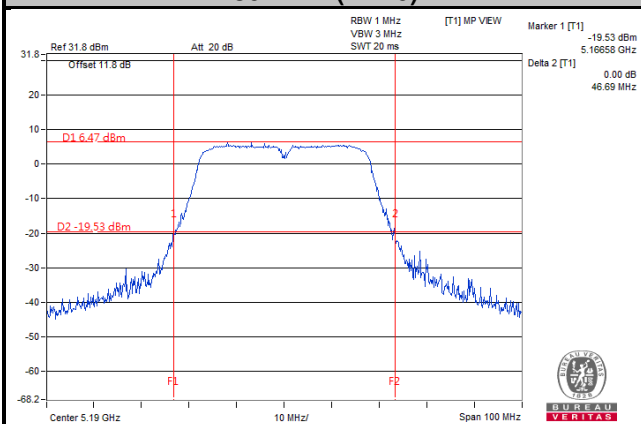

4.4 Peak Power Spectral Density Measurement

4.4.1 Limits of Peak Power Spectral Density Measurement

Operation Band	EUT Category		Limit
U-NII-1		Outdoor Access Point	17 dBm/MHz
		Fixed point-to-point Access Point	
		Indoor Access Point	
	√	Mobile and Portable client device	11 dBm/MHz
U-NII-2A		√	11 dBm/MHz
U-NII-2C		√	11 dBm/MHz
U-NII-3		√	30 dBm/500 kHz

4.4.2 Test Setup

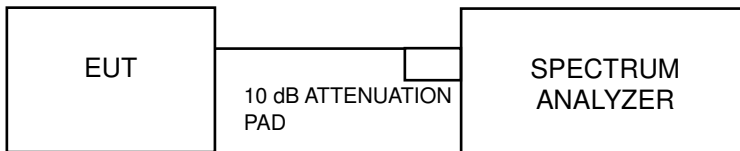

4.4.3 Test Instruments

Refer to section 4.1.3 to get information of above instrument.

4.4.4 Test Procedures

For U-NII-1, U-NII-2A, U-NII-2C band:

Using method SA-1

1. Set span to encompass the entire emission bandwidth (EBW) of the signal.
2. Set RBW = 1 MHz, Set VBW \geq 3 RBW, Detector = RMS
3. Sweep time = auto, trigger set to "free run".
4. Trace average at least 100 traces in power averaging mode.
5. Record the max value

※For U-NII-3:

1. Set span to encompass the entire emission bandwidth (EBW) of the signal.
2. Set RBW = 500 kHz, Set VBW \geq 3 RBW, Detector = RMS
3. Use the peak marker function to determine the maximum power level in any 500 kHz band segment within the fundamental EBW.
4. Sweep time = auto, trigger set to "free run".
5. Trace average at least 100 traces in power averaging mode.
6. Record the max value

4.4.5 Deviation from Test Standard

No deviation.

4.4.6 EUT Operating Conditions

The software provided by client to enable the EUT under transmission condition continuously at lowest, middle and highest channel frequencies individually.

4.4.7 Test Results

For U-NII-1, U-NII-2A, U-NII-2C Band

802.11a

Channel	Frequency (MHz)	PSD (dBm/MHz)	Maximum Limit (dBm/MHz)	Pass / Fail
36	5180	2.77	11	Pass
44	5220	6.70	11	Pass
48	5240	6.89	11	Pass
52	5260	6.99	11	Pass
60	5300	7.41	11	Pass
64	5320	3.47	11	Pass
100	5500	2.88	11	Pass
116	5580	8.18	11	Pass
140	5700	1.54	11	Pass

802.11n (HT20)

Channel	Frequency (MHz)	PSD (dBm/MHz)	Maximum Limit (dBm/MHz)	Pass / Fail
36	5180	2.35	11	Pass
44	5220	6.47	11	Pass
48	5240	6.42	11	Pass
52	5260	6.75	11	Pass
60	5300	7.10	11	Pass
64	5320	3.22	11	Pass
100	5500	1.71	11	Pass
116	5580	8.02	11	Pass
140	5700	1.31	11	Pass

802.11n (HT40)

Channel	Frequency (MHz)	PSD (dBm/MHz)	Maximum Limit (dBm/MHz)	Pass / Fail
38	5190	-2.98	11	Pass
46	5230	-1.70	11	Pass
54	5270	-1.30	11	Pass
62	5310	-2.00	11	Pass
102	5510	-0.88	11	Pass
110	5550	0.60	11	Pass
134	5670	-1.91	11	Pass

Spectrum Plot of Worst Value

802.11a

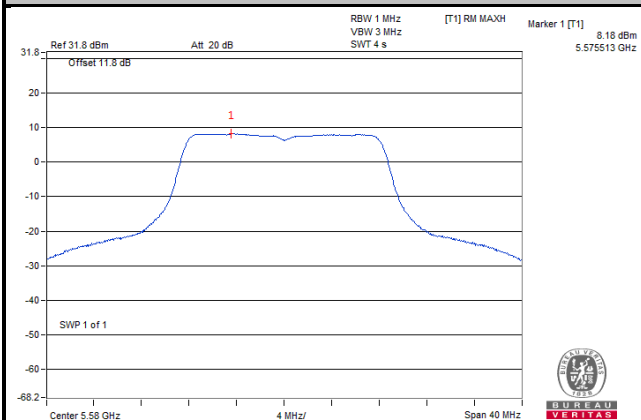

802.11n (HT20)

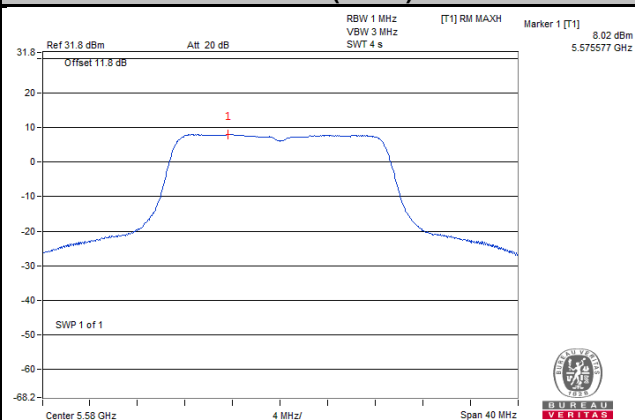

802.11n (HT40)

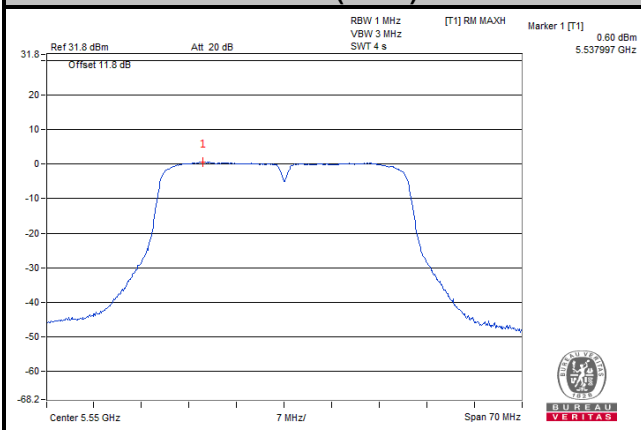

For U-NII-3 Band
802.11a

Channel	Freq. (MHz)	PSD (dBm/500 kHz)	Limit (dBm/500 kHz)	Pass / Fail
149	5745	-3.70	30	Pass
157	5785	4.40	30	Pass
165	5825	0.71	30	Pass

802.11n (HT20)

Channel	Freq. (MHz)	PSD (dBm/500 kHz)	Limit (dBm/500 kHz)	Pass / Fail
149	5745	-3.99	30	Pass
157	5785	4.19	30	Pass
165	5825	0.55	30	Pass

802.11n (HT40)

Channel	Freq. (MHz)	PSD (dBm/500 kHz)	Limit (dBm/500 kHz)	Pass / Fail
151	5755	-6.05	30	Pass
159	5795	-5.57	30	Pass

Spectrum Plot of Worst Value

802.11a

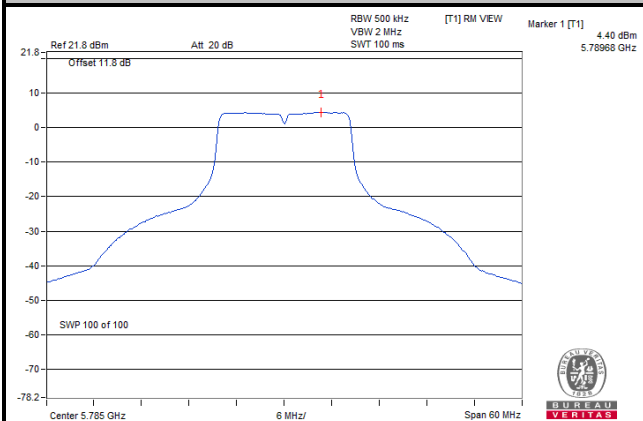

802.11n (HT20)

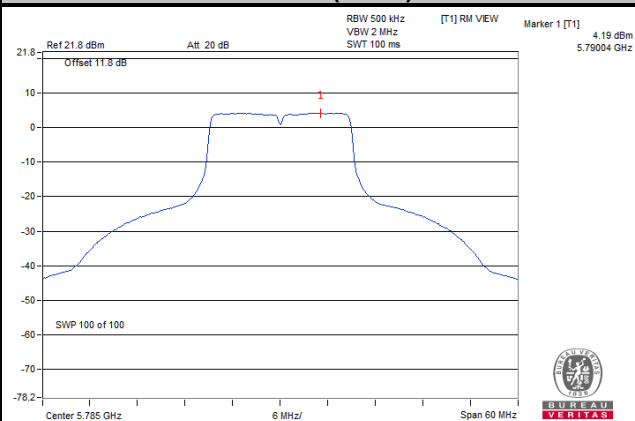

802.11n (HT40)

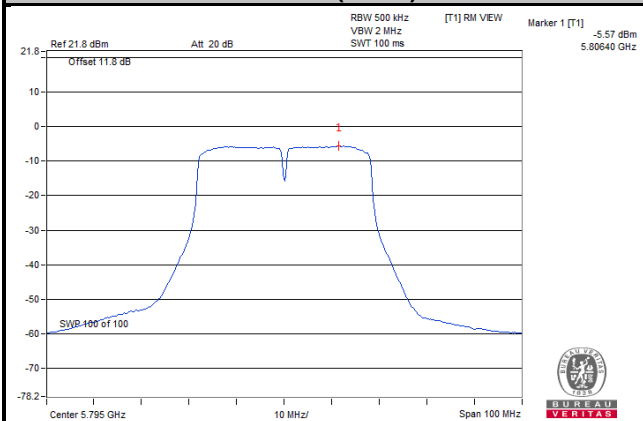

4.5 Frequency Stability

4.5.1 Limit of Frequency Stability Measurement

The frequency of the carrier signal shall be maintained within band of operation.

4.5.2 Test Setup

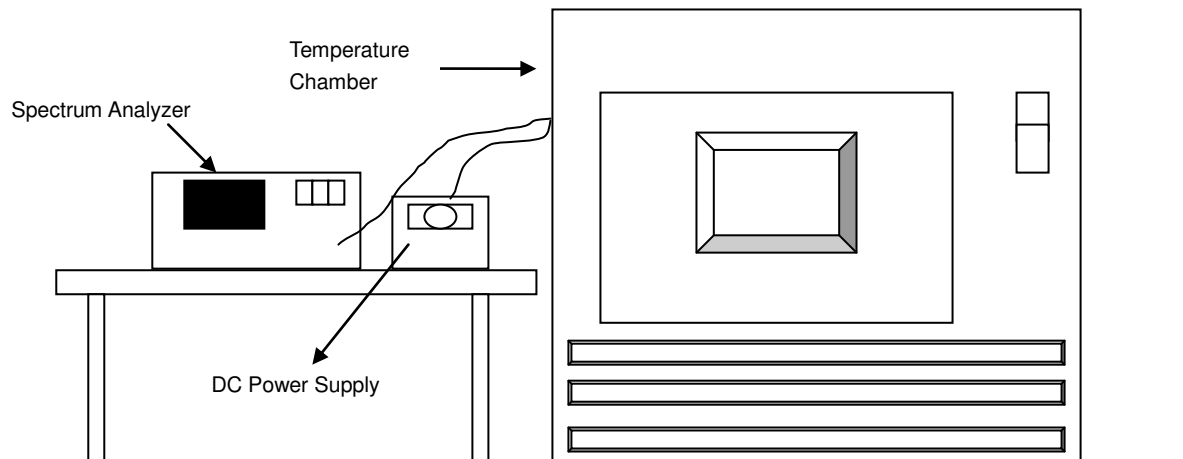

4.5.3 Test Instruments

Refer to section 4.1.3 to get information of above instrument.

4.5.4 Test Procedure

- To ensure emission at the band edge is maintained within the authorized band, those values shall be measured by radiation emissions at upper and lower frequency points, and finally compensated by frequency deviation as procedures below.
- The EUT was operated at the maximum output power, and connected to the spectrum analyzer, which is set to maximum hold function and peak detector. The peak value of the power envelope was measured and noted. The upper and lower frequency points were respectively measured relatively 10 dB lower than the measured peak value.
- The frequency deviation was calculated by adding the upper frequency point and the lower frequency point divided by two. Those detailed values of frequency deviation are provided in table below.

4.5.5 Deviation from Test Standard

No deviation.

4.5.6 EUT Operating Condition

Set the EUT transmit at un-modulation mode to test frequency stability.

4.5.7 Test Results

Frequency Stability Versus Temp.									
Operating Frequency: 5180 MHz									
Temp. (°C)	Power Supply (Vdc)	0 Minute		2 Minute		5 Minute		10 Minute	
		Measured Frequency (MHz)	Frequency Drift (ppm)	Measured Frequency (MHz)	Frequency Drift (ppm)	Measured Frequency (MHz)	Frequency Drift (ppm)	Measured Frequency (MHz)	Frequency Drift (ppm)
60	3.8	5179.9801	-3.8	5179.9834	-3.2	5179.9827	-3.3	5179.9814	-3.6
50	3.8	5179.9887	-2.2	5179.9871	-2.5	5179.9892	-2.1	5179.9907	-1.8
40	3.8	5180.0127	2.5	5180.0148	2.9	5180.0123	2.4	5180.0147	2.8
30	3.8	5180.0182	3.5	5180.0172	3.3	5180.0159	3.1	5180.0147	2.8
20	3.8	5180.0058	1.1	5180.0032	0.6	5180.0026	0.5	5180.0027	0.5
10	3.8	5179.9829	-3.3	5179.9831	-3.3	5179.9872	-2.5	5179.9868	-2.5
0	3.8	5179.996	-0.8	5179.9945	-1.1	5179.9945	-1.1	5179.9934	-1.3
-10	3.8	5180.0068	1.3	5180.0075	1.4	5180.0096	1.9	5180.0086	1.7
-20	3.8	5180.0194	3.7	5180.0204	3.9	5180.0188	3.6	5180.0225	4.3
-30	3.8	5179.9866	-2.6	5179.9882	-2.3	5179.9874	-2.4	5179.988	-2.3

Frequency Stability Versus Temp.									
Operating Frequency: 5180 MHz									
Temp. (°C)	Power Supply (Vdc)	0 Minute		2 Minute		5 Minute		10 Minute	
		Measured Frequency (MHz)	Frequency Drift (ppm)	Measured Frequency (MHz)	Frequency Drift (ppm)	Measured Frequency (MHz)	Frequency Drift (ppm)	Measured Frequency (MHz)	Frequency Drift (ppm)
20	4.35	5180.0052	1.0	5180.0028	0.5	5180.0018	0.3	5180.0033	0.6
	3.8	5180.0058	1.1	5180.0032	0.6	5180.0026	0.5	5180.0027	0.5
	3.3	5180.0055	1.1	5180.0027	0.5	5180.0035	0.7	5180.002	0.4

4.6 6 dB Bandwidth Measurement

4.6.1 Limits of 6 dB Bandwidth Measurement

The minimum of 6 dB Bandwidth Measurement is 0.5 MHz.

4.6.2 Test Setup

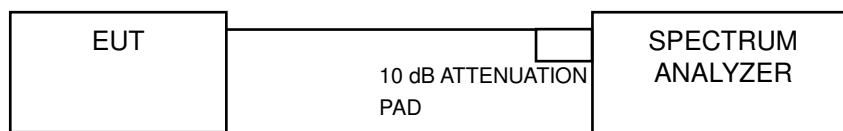

4.6.3 Test Instruments

Refer to section 4.1.3 to get information of above instrument.

4.6.4 Test Procedure

MEASUREMENT PROCEDURE REF

- Set resolution bandwidth (RBW) = 100 kHz
- Set the video bandwidth (VBW) $\geq 3 \times$ RBW, Detector = Peak.
- Trace mode = max hold.
- Sweep = auto couple.
- Measure the maximum width of the emission that is constrained by the frequencies associated with the two amplitude points (upper and lower) that are attenuated by 6 dB relative to the maximum level measured in the fundamental emission

4.6.5 Deviation from Test Standard

No deviation.

4.6.6 EUT Operating Condition

The software provided by client to enable the EUT under transmission condition continuously at lowest, middle and highest channel frequencies individually.

4.6.7 Test Results

802.11a

Channel	Frequency (MHz)	6 dB Bandwidth (MHz)	Minimum Limit (MHz)	Pass / Fail
149	5745	16.40	0.5	Pass
157	5785	16.41	0.5	Pass
165	5825	16.40	0.5	Pass

802.11n (HT20)

Channel	Frequency (MHz)	6 dB Bandwidth (MHz)	Minimum Limit (MHz)	Pass / Fail
149	5745	17.64	0.5	Pass
157	5785	17.61	0.5	Pass
165	5825	17.64	0.5	Pass

802.11n (HT40)

Channel	Frequency (MHz)	6 dB Bandwidth (MHz)	Minimum Limit (MHz)	Pass / Fail
151	5755	35.41	0.5	Pass
159	5795	35.28	0.5	Pass

Spectrum Plot of Worst Value

802.11a

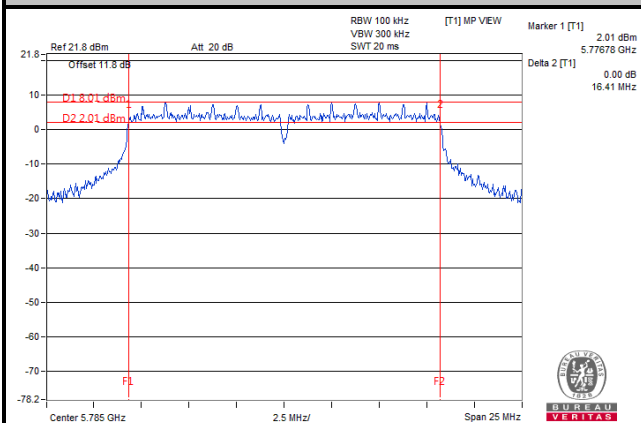

802.11n (HT20)

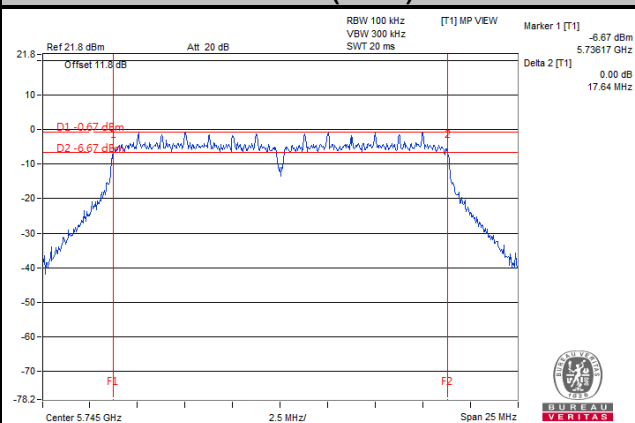

802.11n (HT40)

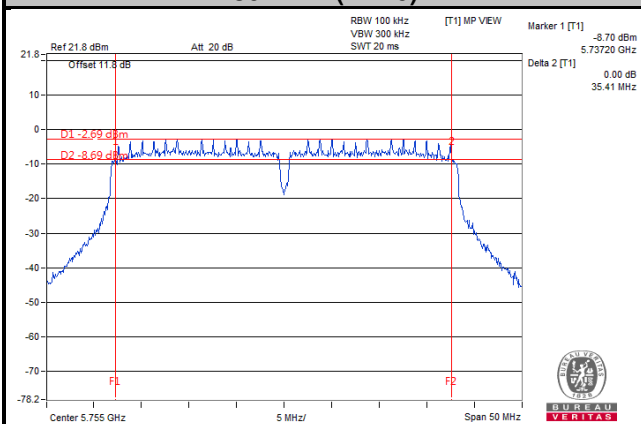

5 Pictures of Test Arrangements

Please refer to the attached file (Test Setup Photo).

Annex A- Radiated Out of Band Emisison (OOBE) Measurement (For U-NII-3 band)

802.11a

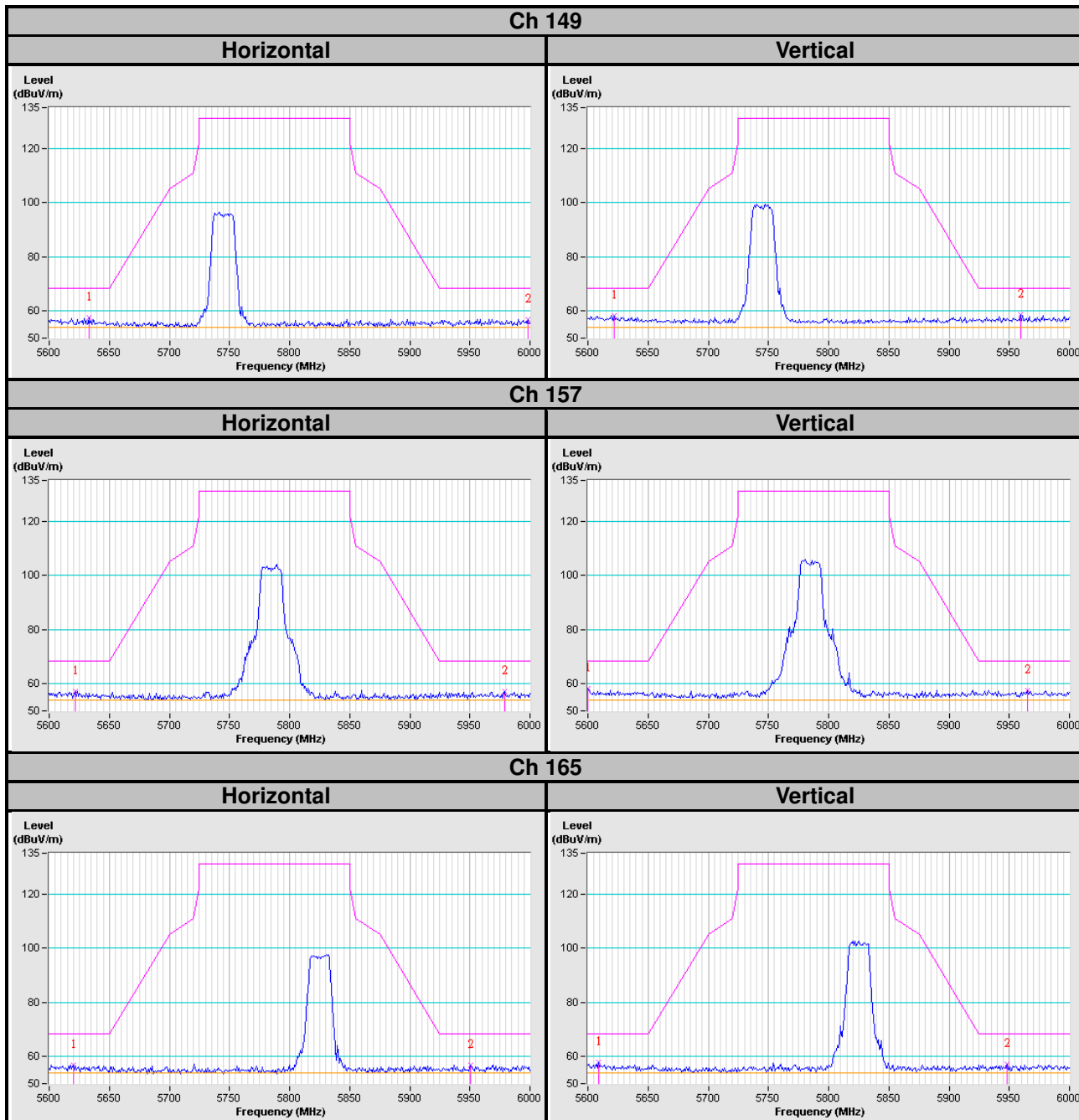

802.11n (HT20)

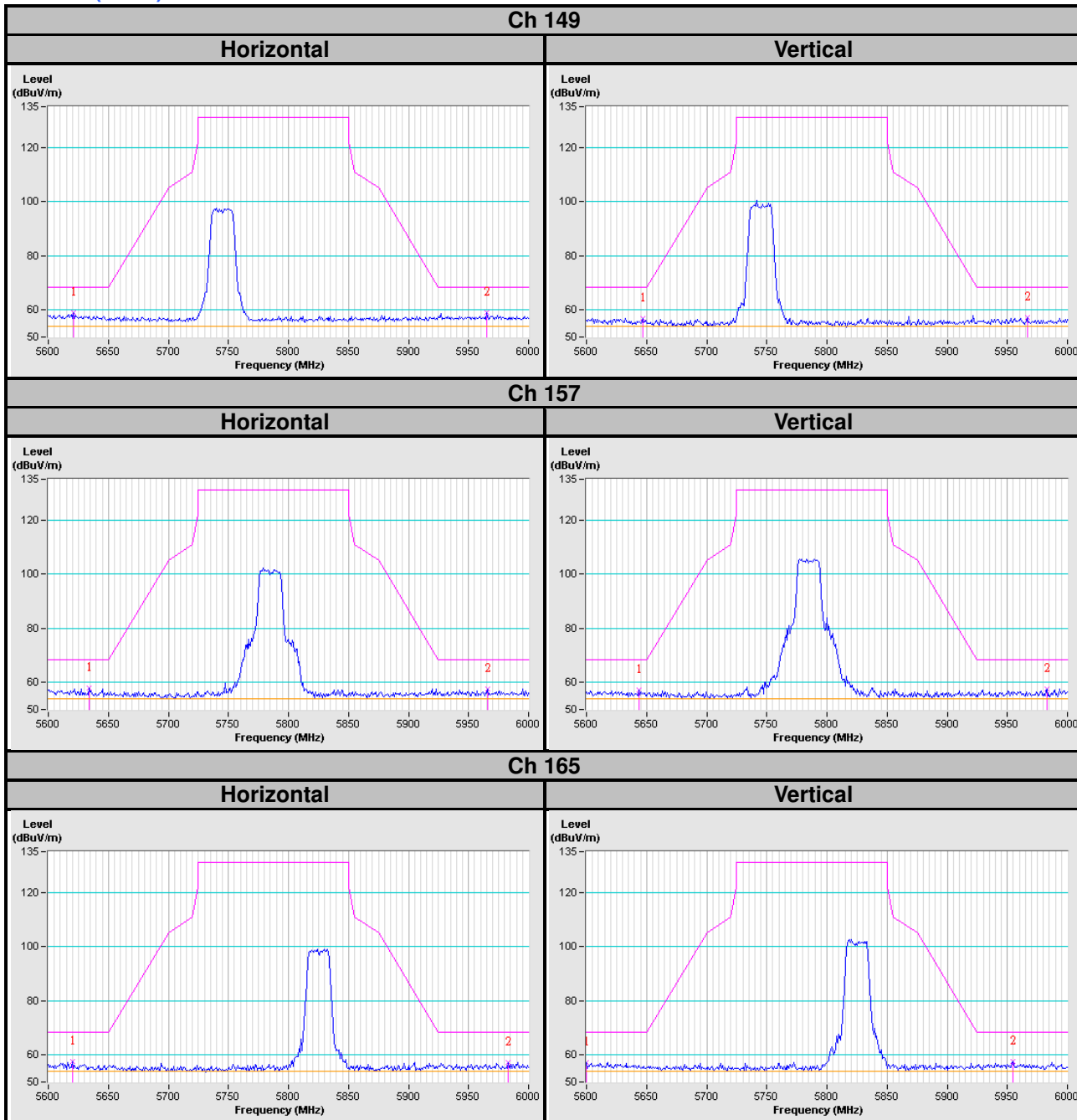

802.11n (HT40)

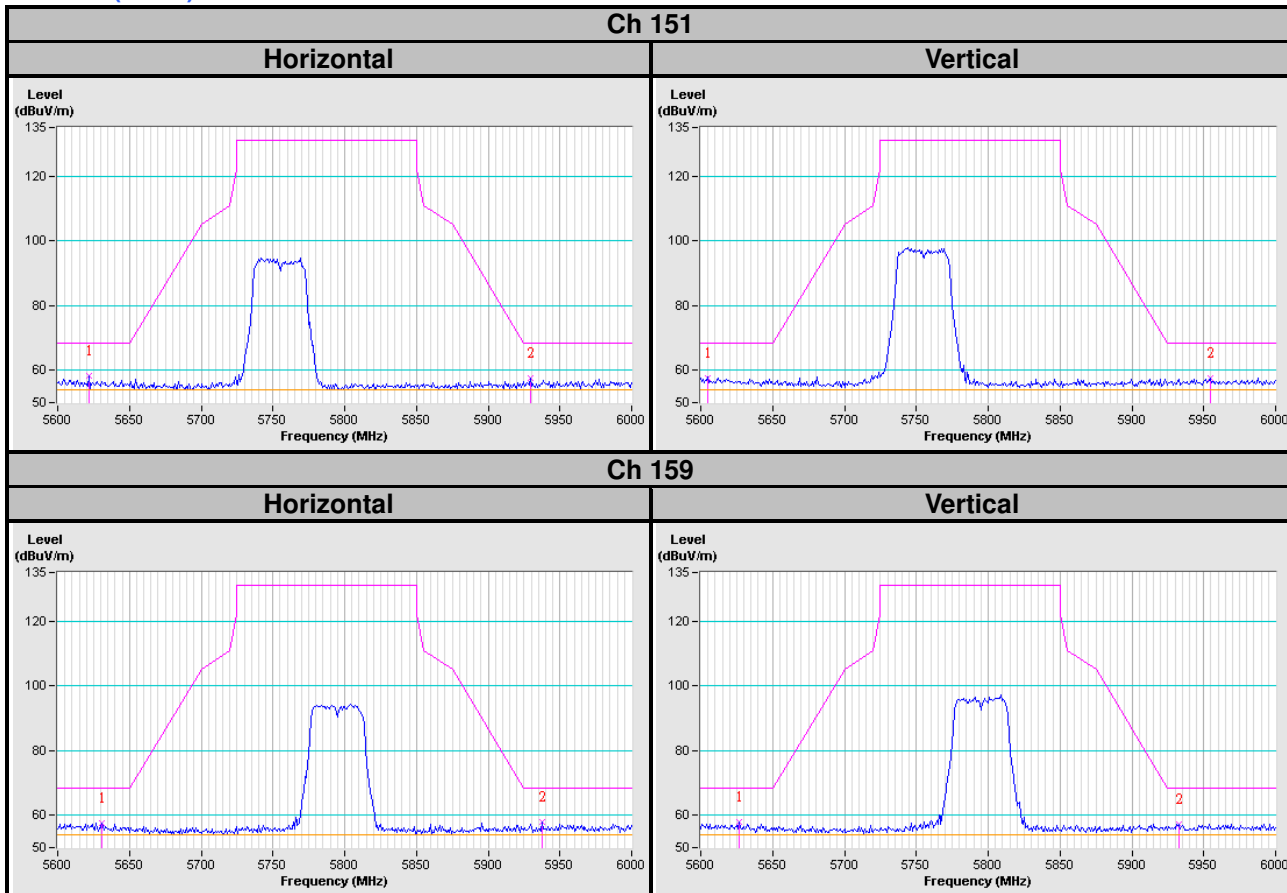

Appendix – Information on the Testing Laboratories

We, Bureau Veritas Consumer Products Services (H.K.) Ltd., Taoyuan Branch, were founded in 1988 to provide our best service in EMC, Radio, Telecom and Safety consultation. Our laboratories are accredited and approved according to ISO/IEC 17025.

If you have any comments, please feel free to contact us at the following:

Linko EMC/RF Lab

Tel: 886-2-26052180

Fax: 886-2-26051924

Hsin Chu EMC/RF/Telecom Lab

Tel: 886-3-6668565

Fax: 886-3-6668323

Hwa Ya EMC/RF/Safety

Tel: 886-3-3183232

Fax: 886-3-3270892

Email: service.adt@tw.bureauveritas.com

Web Site: www.bureauveritas-adt.com

The address and road map of all our labs can be found in our web site also.

--- END ---