

## FCC Test Report

**Report No.:** RF170524C02-3

**FCC ID:** V65E4610

**Test Model:** E4610 / E4610NC

**Received Date:** May 24, 2017

**Test Date:** Jun. 21, 2017 ~ Jun. 30, 2017

**Issued Date:** Jul. 05, 2017

**Applicant:** Kyocera Corporation c/o Kyocera International, Inc.

**Address:** 8611 Balboa Avenue, San Diego, CA 92123

**Issued By:** Bureau Veritas Consumer Products Services (H.K.) Ltd., Taoyuan Branch

**Lab Address:** No. 47-2, 14th Ling, Chia Pau Vil., Lin Kou Dist., New Taipei City, Taiwan  
( R.O.C )

**Test Location (1):** No. 19, Hwa Ya 2nd Rd, Wen Hwa Tsuen, Kwei Shan Hsiang, Taoyuan  
Hsien 333, Taiwan, R.O.C.



This report is for your exclusive use. Any copying or replication of this report to or for any other person or entity, or use of our name or trademark, is permitted only with our prior written permission. This report sets forth our findings solely with respect to the test samples identified herein. The results set forth in this report are not indicative or representative of the quality or characteristics of the lot from which a test sample was taken or any similar or identical product unless specifically and expressly noted. Our report includes all of the tests requested by you and the results thereof based upon the information that you provided to us. You have 60 days from date of issuance of this report to notify us of any material error or omission caused by our negligence, provided, however, that such notice shall be in writing and shall specifically address the issue you wish to raise. A failure to raise such issue within the prescribed time shall constitute your unqualified acceptance of the completeness of this report, the tests conducted and the correctness of the report contents. Unless specific mention, the uncertainty of measurement has been explicitly taken into account to declare the compliance or non-compliance to the specification. The report must not be used by the client to claim product certification, approval, or endorsement by TAF or any government agencies.

## Table of Contents

<b>Release Control Record</b> .....	<b>4</b>
<b>1 Certificate of Conformity</b> .....	<b>5</b>
<b>2 Summary of Test Results</b> .....	<b>6</b>
2.1 Measurement Uncertainty.....	6
2.2 Modification Record .....	6
<b>3 General Information</b> .....	<b>7</b>
3.1 General Description of EUT .....	7
3.2 Description of Test Modes.....	9
3.2.1 Test Mode Applicability and Tested Channel Detail.....	11
3.3 Duty Cycle of Test Signal .....	13
3.4 Description of Support Units .....	14
3.4.1 Configuration of System under Test .....	14
3.5 General Description of Applied Standards.....	15
<b>4 Test Types and Results</b> .....	<b>16</b>
4.1 Radiated Emission and Bandedge Measurement .....	16
4.1.1 Limits of Radiated Emission and Bandedge Measurement .....	16
4.1.2 Limits of Unwanted Emission Out of the Restricted Bands .....	17
4.1.3 Test Instruments .....	18
4.1.4 Test Procedures.....	19
4.1.5 Deviation from Test Standard .....	19
4.1.6 Test Set Up .....	20
4.1.7 EUT Operating Conditions.....	21
4.1.8 Test Results .....	22
4.2 Conducted Emission Measurement.....	59
4.2.1 Limits of Conducted Emission Measurement .....	59
4.2.2 Test Instruments .....	59
4.2.3 Test Procedures.....	60
4.2.4 Deviation from Test Standard .....	60
4.2.5 Test Setup.....	60
4.2.6 EUT Operating Conditions.....	60
4.2.7 Test Results .....	61
4.3 Transmit Power Measurement.....	63
4.3.1 Limits of Transmit Power Measurement .....	63
4.3.2 Test Setup.....	63
4.3.3 Test Instruments .....	64
4.3.4 Test Procedure .....	64
4.3.5 Deviation from Test Standard .....	64
4.3.6 EUT Operating Conditions.....	64
4.3.7 Test Result .....	65
4.4 Peak Power Spectral Density Measurement .....	70
4.4.1 Limits of Peak Power Spectral Density Measurement .....	70
4.4.2 Test Setup.....	70
4.4.3 Test Instruments .....	70
4.4.4 Test Procedures.....	71
4.4.5 Deviation from Test Standard .....	71
4.4.6 EUT Operating Conditions.....	71
4.4.7 Test Results .....	72
4.5 Frequency Stability .....	76
4.5.1 Limit of Frequency Stability Measurement .....	76
4.5.2 Test Setup.....	76
4.5.3 Test Instruments .....	76
4.5.4 Test Procedure .....	76
4.5.5 Deviation from Test Standard .....	76

4.5.6 EUT Operating Condition .....	76
4.5.7 Test Results .....	77
4.6 6 dB Bandwidth Measurement.....	78
4.6.1 Limits of 6 dB Bandwidth Measurement.....	78
4.6.2 Test Setup.....	78
4.6.3 Test Instruments .....	78
4.6.4 Test Procedure .....	78
4.6.5 Deviation from Test Standard .....	78
4.6.6 EUT Operating Condition .....	78
4.6.7 Test Results .....	79
<b>5 Pictures of Test Arrangements.....</b>	<b>81</b>
<b>Annex A- Radiated Out of Band Emisison (OOBE) Measurement (For U-NII-3 band).....</b>	<b>82</b>
<b>Appendix – Information on the Testing Laboratories .....</b>	<b>85</b>

### Release Control Record

Issue No.	Description	Date Issued
RF170524C02-3	Original Release	Jul. 05, 2017

## 1 Certificate of Conformity

**Product:** Feature Phone

**Brand:** Kyocera

**Test Model:** E4610 / E4610NC

**Sample Status:** Identical Prototype

**Applicant:** Kyocera Corporation c/o Kyocera International, Inc.

**Test Date:** Jun. 21, 2017 ~ Jun. 30, 2017

**Standards:** 47 CFR FCC Part 15, Subpart E (Section 15.407)  
ANSI C63.10:2013

The above equipment has been tested by **Bureau Veritas Consumer Products Services (H.K.) Ltd., Taoyuan Branch**, and found compliance with the requirement of the above standards. The test record, data evaluation & Equipment Under Test (EUT) configurations represented herein are true and accurate accounts of the measurements of the sample's EMC characteristics under the conditions specified in this report.

**Prepared by :**



**Date:**

Jul. 05, 2017

Ivonne Wu / Supervisor

**Approved by :**



**Date:**

Jul. 05, 2017

David Huang / Project Engineer

## 2 Summary of Test Results

47 CFR FCC Part 15, Subpart E (Section 15.407)			
FCC Clause	Test Item	Result	Remarks
15.407(b)(6)	AC Power Conducted Emissions	Pass	Meet the requirement of limit. Minimum passing margin is -23.53 dB at 0.38600 MHz.
15.407(b) (1/2/3/4(i/ii)/6)	Radiated Emissions & Band Edge Measurement	Pass	Meet the requirement of limit. Minimum passing margin is -1.04 dB at 5350.11 MHz.
15.407(a)(1/2/3)	Max Average Transmit Power	Pass	Meet the requirement of limit.
15.407(a)(1/2/3)	Peak Power Spectral Density	Pass	Meet the requirement of limit.
15.407(e)	6 dB Bandwidth	Pass	Meet the requirement of limit. (U-NII-3 Band only)
15.407(g)	Frequency Stability	Pass	Meet the requirement of limit.
15.203	Antenna Requirement	Pass	No antenna connector is used.

\*For U-NII-3 band compliance with rule part 15.407(b)(4)(i), the OOB test plots were recorded in Annex A.

### 2.1 Measurement Uncertainty

Where relevant, the following measurement uncertainty levels have been estimated for tests performed on the EUT as specified in CISPR 16-4-2:

Measurement	Frequency	Expanded Uncertainty (k=2) (±)
Conducted Emissions at mains ports	150 kHz ~ 30 MHz	2.44 dB
Radiated Emissions up to 1 GHz	30 MHz ~ 200 MHz	2.93 dB
	200 MHz ~ 1000 MHz	2.95 dB
Radiated Emissions above 1 GHz	1 GHz ~ 18 GHz	2.26 dB
	18 GHz ~ 40 GHz	1.94 dB

### 2.2 Modification Record

There were no modifications required for compliance.

### 3 General Information

#### 3.1 General Description of EUT

<b>Product</b>	Feature Phone
<b>Brand</b>	Kyocera
<b>Test Model</b>	E4610 / E4610NC
<b>Status of EUT</b>	Identical Prototype
<b>Power Supply Rating</b>	5.0 Vdc (adapter or host equipment) 3.7 Vdc (Li-ion battery)
<b>Modulation Type</b>	64QAM, 16QAM, QPSK, BPSK
<b>Modulation Technology</b>	OFDM
<b>Transfer Rate</b>	802.11a: 54.0/ 48.0/ 36.0/ 24.0/ 18.0/ 12.0/ 9.0/ 6.0 Mbps 802.11n: up to MCS7
<b>Operating Frequency</b>	5180 ~ 5240 MHz, 5260 ~ 5320 MHz, 5500 ~ 5700 MHz, 5745 ~ 5825 MHz
<b>Number of Channel</b>	5180 ~ 5240 MHz: 4 for 802.11a, 802.11n (HT20) 2 for 802.11n (HT40) 5260 ~ 5320 MHz: 4 for 802.11a, 802.11n (HT20) 2 for 802.11n (HT40) 5500 ~ 5700 MHz: 11 for 802.11a, 802.11n (HT20) 5 for 802.11n (HT40) 5745 ~ 5825 MHz: 5 for 802.11a, 802.11n (HT20) 2 for 802.11n (HT40)
<b>Output Power</b>	23.659 mW for 5180 ~ 5240 MHz 24.210 mW for 5260 ~ 5320 MHz 23.281 mW for 5500 ~ 5700 MHz 22.080 mW for 5745 ~ 5825 MHz
<b>Antenna Type</b>	Fixed internal antenna with -0.32 dBi gain (5180 ~ 5240 MHz) Fixed internal antenna with -0.28 dBi gain (5260 ~ 5320 MHz) Fixed internal antenna with -0.27 dBi gain (5500 ~ 5700 MHz) Fixed internal antenna with -0.25 dBi gain (5745 ~ 5825 MHz)
<b>Antenna Connector</b>	N/A
<b>Accessory Device</b>	Refer to Note as below
<b>Data Cable Supplied</b>	Refer to Note as below

**Note:**

1. All the models are listed as below.

Brand	Mode	Description
Kyocera	E4610	With Camera function
	E4610NC	Disable Camera function

2. The EUT contains following accessory devices.

Product	Brand	Model	Description
Adapter	KYOCERA	SCP-47ADT	I/P: 100-240 Vac, 50/60 Hz, 200 mA O/P: 5.0 Vdc, 1000 mA
Battery	KYOCERA	SCP-69LBPS	3.7 Vdc, 1500/1530 mAh
USB Cable	KYOCERA	SCP-23SDC	1.0 m shielded cable w/o core

3. The above EUT information is declared by manufacturer and for more detailed features description, please refer to the manufacturer's specifications or user's manual.



### 3.2 Description of Test Modes

#### For 5180 ~ 5240 MHz

4 channels are provided for 802.11a, 802.11n (HT20):

Channel	Frequency (MHz)	Channel	Frequency (MHz)
36	5180	44	5220
40	5200	48	5240

2 channels are provided for 802.11n (HT40):

Channel	Frequency (MHz)	Channel	Frequency (MHz)
38	5190	46	5230

#### For 5260 ~ 5320 MHz

4 channels are provided for 802.11a, 802.11n (HT20):

Channel	Frequency (MHz)	Channel	Frequency (MHz)
52	5260	60	5300
56	5280	64	5320

2 channels are provided for 802.11n (HT40):

Channel	Frequency (MHz)	Channel	Frequency (MHz)
54	5270	62	5310

### For 5500 ~ 5700 MHz

11 channels are provided for 802.11a, 802.11n (HT20):

Channel	Frequency (MHz)	Channel	Frequency (MHz)
100	5500	124	5620
104	5520	128	5640
108	5540	132	5660
112	5560	136	5680
116	5580	140	5700
120	5600		

5 channels are provided for 802.11n (HT40):

Channel	Frequency (MHz)	Channel	Frequency (MHz)
102	5510	126	5630
110	5550	134	5670
118	5590		

### For 5745 ~ 5825 MHz:

5 channels are provided for 802.11a, 802.11n (HT20):

Channel	Frequency (MHz)	Channel	Frequency (MHz)
149	5745	161	5805
153	5765	165	5825
157	5785		

2 channels are provided for 802.11n (HT40):

Channel	Frequency (MHz)	Channel	Frequency (MHz)
151	5755	159	5795

### 3.2.1 Test Mode Applicability and Tested Channel Detail

EUT Configure Mode	Applicable To				Description
	RE $\geq$ 1G	RE $<$ 1G	PLC	APCM	
-	√	√	√	√	-

Where **RE $\geq$ 1G**: Radiated Emission above 1 GHz      **RE $<$ 1G**: Radiated Emission below 1 GHz  
**PLC**: Power Line Conducted Emission      **APCM**: Antenna Port Conducted Measurement

**Note:**

- The EUT had been pre-tested on the positioned of each 3 axis. The worst case was found when positioned on **Z-plane** for 5180-5247MHz & 5260-5320MHz and **X-plane** for 5500-5700MHz & 5745-5825MHz.
- "-" means no effect.

#### **Radiated Emission Test (Above 1 GHz):**

- Pre-Scan has been conducted to determine the worst-case mode from all possible combinations between available modulations, data rates and antenna ports (if EUT with antenna diversity architecture).
- Following channel(s) was (were) selected for the final test as listed below.

EUT Configure Mode	Frequency Band (MHz)	Mode	Available Channel	Tested Channel	Modulation Technology	Modulation Type	Data Rate (Mbps)	
-	5180-5240	802.11a	36 to 48	36, 44, 48	OFDM	BPSK	6.0	
-		802.11n (HT20)	36 to 48	36, 44, 48	OFDM	BPSK	MCS0	
-		802.11n (HT40)	38 to 46	38, 46	38, 46	OFDM	BPSK	MCS0
-	5260-5320	802.11a	52 to 64	52, 60, 64	OFDM	BPSK	6.0	
-		802.11n (HT20)	52 to 64	52, 60, 64	OFDM	BPSK	MCS0	
-		802.11n (HT40)	54 to 62	54, 62	54, 62	OFDM	BPSK	MCS0
-	5500-5700	802.11a	100 to 140	100, 116, 140	OFDM	BPSK	6.0	
-		802.11n (HT20)	100 to 140	100, 116, 140	OFDM	BPSK	MCS0	
-		802.11n (HT40)	102 to 134	102, 110, 134	102, 110, 134	OFDM	BPSK	MCS0
-	5745-5825	802.11a	149 to 165	149, 157, 165	OFDM	BPSK	6.0	
-		802.11n (HT20)	149 to 165	149, 157, 165	149, 157, 165	OFDM	BPSK	MCS0
-		802.11n (HT40)	151 to 159	151, 159	151, 159	OFDM	BPSK	MCS0

#### **Radiated Emission Test (Below 1 GHz):**

- Pre-Scan has been conducted to determine the worst-case mode from all possible combinations between available modulations, data rates and antenna ports (if EUT with antenna diversity architecture).
- Following channel(s) was (were) selected for the final test as listed below.

EUT Configure Mode	Frequency Band (MHz)	Mode	Available Channel	Tested Channel	Modulation Technology	Modulation Type	Data Rate (Mbps)
-	5180-5240	802.11n (HT40)	38 to 46	38	OFDM	BPSK	MCS0
-	5260-5320	802.11n (HT40)	54 to 62	62	OFDM	BPSK	MCS0
-	5500-5700	802.11n (HT40)	102 to 134	102	OFDM	BPSK	MCS0
-	5745-5825	802.11a	149 to 165	165	OFDM	BPSK	6.0

#### **Power Line Conducted Emission Test:**

- Pre-Scan has been conducted to determine the worst-case mode from all possible combinations between available modulations, data rates and antenna ports (if EUT with antenna diversity architecture).
- Following channel(s) was (were) selected for the final test as listed below.

EUT Configure Mode	Frequency Band (MHz)	Mode	Available Channel	Tested Channel	Modulation Technology	Modulation Type	Data Rate (Mbps)
-	5260-5320	802.11n (HT40)	54 to 62	62	OFDM	BPSK	6.0

**Antenna Port Conducted Measurement:**

- This item includes all test value of each mode, but only includes spectrum plot of worst value of each mode.
- Pre-Scan has been conducted to determine the worst-case mode from all possible combinations between available modulations, data rates and antenna ports (if EUT with antenna diversity architecture).
- Following channel(s) was (were) selected for the final test as listed below.

EUT Configure Mode	Frequency Band (MHz)	Mode	Available Channel	Tested Channel	Modulation Technology	Modulation Type	Data Rate (Mbps)
-	5180-5240	802.11a	36 to 48	36, 44, 48	OFDM	BPSK	6.0
-		802.11n (HT20)	36 to 48	36, 44, 48	OFDM	BPSK	MCS0
-		802.11n (HT40)	38 to 46	38, 46	OFDM	BPSK	MCS0
-	5260-5320	802.11a	52 to 64	52, 60, 64	OFDM	BPSK	6.0
-		802.11n (HT20)	52 to 64	52, 60, 64	OFDM	BPSK	MCS0
-		802.11n (HT40)	54 to 62	54, 62	OFDM	BPSK	MCS0
-	5500-5700	802.11a	100 to 140	100, 116, 140	OFDM	BPSK	6.0
-		802.11n (HT20)	100 to 140	100, 116, 140	OFDM	BPSK	MCS0
-		802.11n (HT40)	102 to 134	102, 110, 134	OFDM	BPSK	MCS0
-	5745-5825	802.11a	149 to 165	149, 157, 165	OFDM	BPSK	6.0
-		802.11n (HT20)	149 to 165	149, 157, 165	OFDM	BPSK	MCS0
-		802.11n (HT40)	151 to 159	151, 159	OFDM	BPSK	MCS0

**Test Condition:**

Applicable To	Environmental Conditions	Input Power	Tested by
RE $\geq$ 1G	25 deg. C, 65 % RH	120 Vac, 60 Hz	Getaz Yang
RE<1G	25 deg. C, 65 % RH	120 Vac, 60 Hz	Getaz Yang
PLC	25 deg. C, 65 % RH	120 Vac, 60 Hz	Getaz Yang
APCM	25 deg. C, 65 % RH	3.7 Vdc	Wayne Lin

### 3.3 Duty Cycle of Test Signal

#### MODULATION TYPE: BPSK

**802.11a:** Duty cycle of test signal is > 98 %, duty factor is not required.

Duty cycle of test signal is < 98 %, duty factor is required.

**802.11n (HT20):** Duty cycle =  $1.275/1.306 = 0.976$ , Duty factor =  $10 * \log(1/0.976) = 0.10$

**802.11n (HT40):** Duty cycle =  $633/666 = 0.950$ , Duty factor =  $10 * \log(1/0.950) = 0.22$

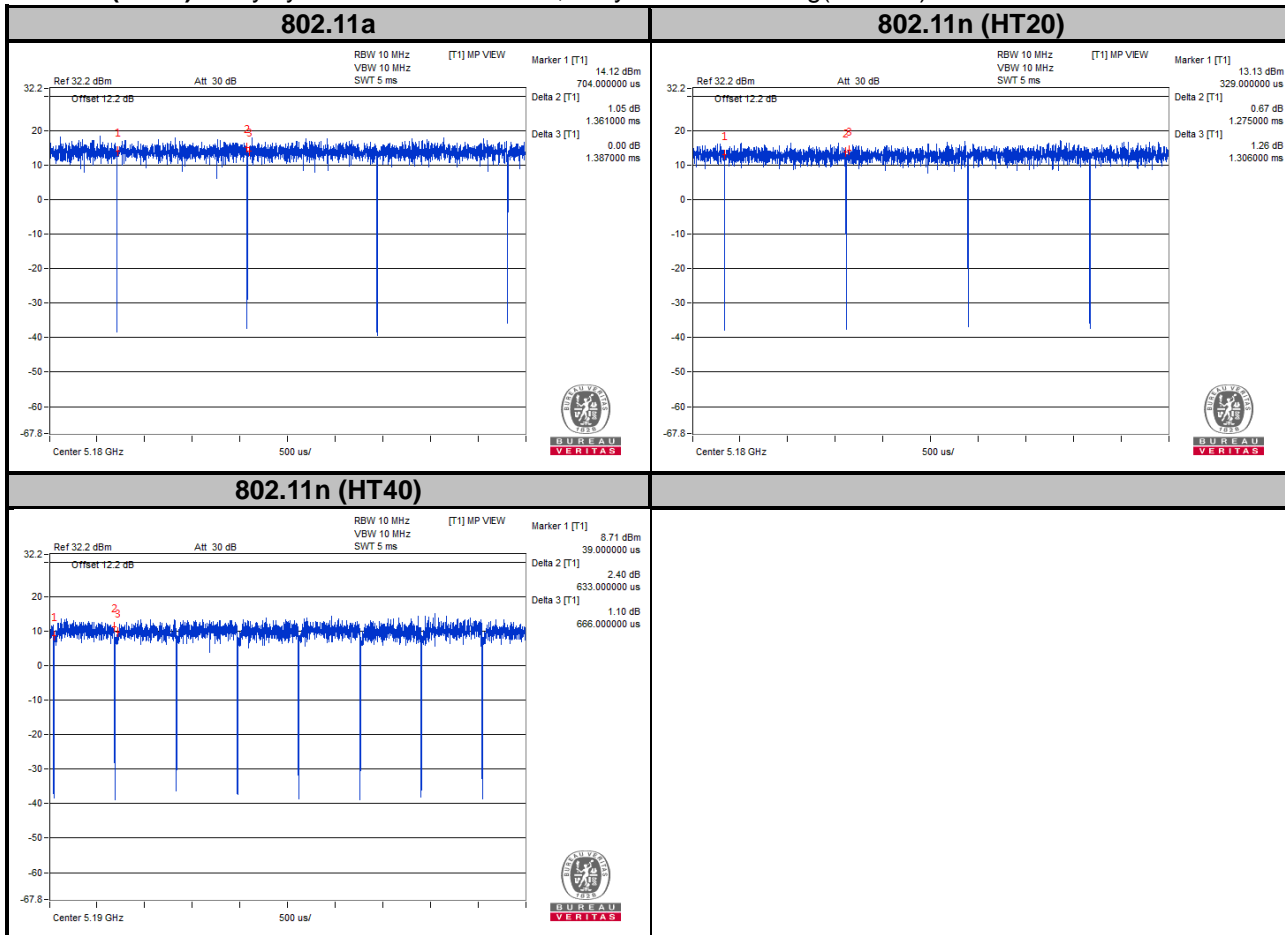

### 3.4 Description of Support Units

The EUT has been tested as an independent unit together with other necessary accessories or support units. The following support units or accessories were used to form a representative test configuration during the tests.

No.	Product	Brand	Model No.	Serial No.	FCC ID
1.	Earphone	Funkey	FK-130102	N/A	N/A

No.	Signal Cable Description Of The Above Support Units
1.	N/A

Note:

1. All power cords of the above support units are non-shielded (1.8m).

#### 3.4.1 Configuration of System under Test

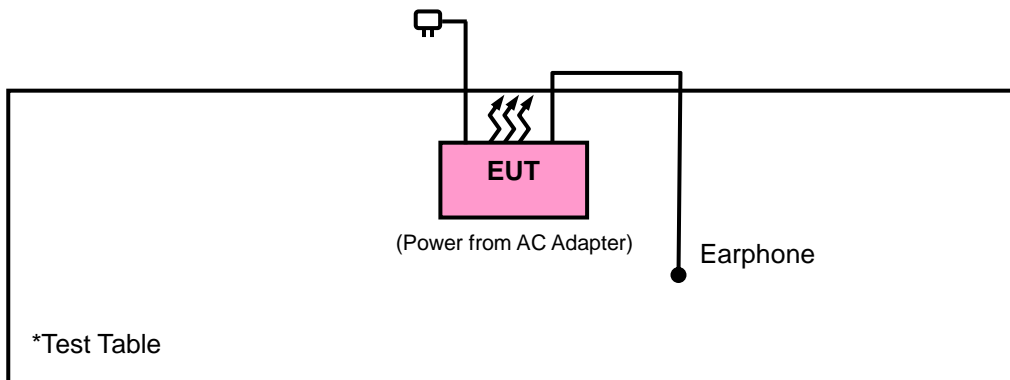

### 3.5 General Description of Applied Standards

The EUT is a RF Product. According to the specifications of the manufacturer, it must comply with the requirements of the following standards:

**FCC Part 15, Subpart E (15.407)**

**789033 D02 General UNII Test Procedures New Rules v01r04**

ANSI C63.10-2013

All test items have been performed and recorded as per the above standards.

**Note:** The EUT has been verified to comply with the requirements of FCC Part 15, Subpart B, Class B (DoC).  
The test report has been issued separately.

## 4 Test Types and Results

### 4.1 Radiated Emission and Bandedge Measurement

#### 4.1.1 Limits of Radiated Emission and Bandedge Measurement

Radiated emissions which fall in the restricted bands must comply with the radiated emission limits specified as below table. Other emissions shall be at least 20 dB below the highest level of the desired power:

Frequencies (MHz)	Field Strength (microvolts/meter)	Measurement Distance (meters)
0.009 ~ 0.490	2400/F (kHz)	300
0.490 ~ 1.705	24000/F (kHz)	30
1.705 ~ 30.0	30	30
30 ~ 88	100	3
88 ~ 216	150	3
216 ~ 960	200	3
Above 960	500	3

**Note:**

1. The lower limit shall apply at the transition frequencies.
2. Emission level (dBuV/m) = 20 log Emission level (uV/m).
3. For frequencies above 1000 MHz, the field strength limits are based on average detector, however, the peak field strength of any emission shall not exceed the maximum permitted average limits, specified above by more than 20 dB under any condition of modulation.



#### 4.1.2 Limits of Unwanted Emission Out of the Restricted Bands

Applicable To		Limit	
789033 D02 General UNII Test Procedures New Rules v01r04		Field Strength at 3 m	
		PK: 74 (dBµV/m)	AV: 54 (dBµV/m)
Frequency Band	Applicable To	EIRP Limit	Equivalent Field Strength at 3 m
5150~5250 MHz	15.407(b)(1)	PK: -27 (dBm/MHz)	PK: 68.2 (dBµV/m)
5250~5350 MHz	15.407(b)(2)		
5470~5725 MHz	15.407(b)(3)		
5725~5850 MHz	15.407(b)(4)(i)	PK:-27 (dBm/MHz) <sup>*1</sup> PK:10 (dBm/MHz) <sup>*2</sup> PK:15.6 (dBm/MHz) <sup>*3</sup> PK:27 (dBm/MHz) <sup>*4</sup>	PK: 68.2 (dBµV/m) <sup>*1</sup> PK:105.2 (dBµV/m) <sup>*2</sup> PK: 110.8 (dBµV/m) <sup>*3</sup> PK:122.2 (dBµV/m) <sup>*4</sup>
	15.407(b)(4)(ii)	Emission limits in section 15.247(d)	

<sup>\*1</sup> beyond 75 MHz or more above of the band edge.  
<sup>\*2</sup> below the band edge increasing linearly to 10 dBm/MHz at 25 MHz above.  
<sup>\*3</sup> below the band edge increasing linearly to a level of 15.6 dBm/MHz at 5 MHz above.  
<sup>\*4</sup> from 5 MHz above or below the band edge increasing linearly to a level of 27 dBm/MHz at the band edge.

**Note:**

The following formula is used to convert the equipment isotropic radiated power (eirp) to field strength:

$$E = \frac{1000000\sqrt{30P}}{3} \mu\text{V/m, where P is the eirp (Watts).$$

#### 4.1.3 Test Instruments

Description & Manufacturer	Model No.	Serial No.	Date of Calibration	Due Date of Calibration
Test Receiver Agilent	N9038A	MY51210203	Feb. 17, 2017	Feb. 16, 2018
Spectrum Analyzer Agilent	N9010A	MY52220314	Dec. 16, 2016	Dec. 15, 2017
BILOG Antenna SCHWARZBECK	VULB9168	9168-472	Dec. 26, 2016	Dec. 27, 2017
HORN Antenna SCHWARZBECK	BBHA 9120 D	9120D-969	Dec. 12, 2016	Dec. 13, 2017
HORN Antenna SCHWARZBECK	BBHA 9170	9170-480	Dec. 14, 2016	Dec. 13, 2017
Fixed Attenuator Mini-Circuits	BW-N10W5+	NA	Jul. 08, 2016	Jul. 07, 2017
Loop Antenna	EM-6879	269	Aug. 11, 2016	Aug. 10, 2017
Preamplifier EMCI	EMC001340	980201	Nov. 02, 2016	Nov. 01, 2017
Bluetooth Tester	CBT	100946	Jul. 29, 2016	Jul. 28, 2018
Preamplifier EMCI	EMC 012645	980115	Oct. 21, 2016	Oct. 20, 2017
Preamplifier EMCI	EMC 184045	980116	Oct. 21, 2016	Oct. 20, 2017
Preamplifier EMCI	EMC 330H	980112	Oct. 21, 2016	Oct. 20, 2017
Power Meter Anritsu	ML2495A	1232002	Sep. 08, 2016	Sep. 07, 2017
Power Sensor Anritsu	MA2411B	1207325	Sep. 08, 2016	Sep. 07, 2017
RF signal cable HUBER+SUHNNER	SUCOFLEX 104	309219/4 2950114	Oct. 21, 2016	Oct. 20, 2017
RF signal cable HUBER+SUHNNER	SUCOFLEX 104	250130/4	Oct. 21, 2016	Oct. 20, 2017
RF Coaxial Cable Worken	8D-FB	Cable-Ch10-01	Oct. 21, 2016	Oct. 20, 2017
Software BV ADT	E3 6.120103	NA	NA	NA
Antenna Tower MF	MFA-440H	NA	NA	NA
Turn Table MF	MFT-201SS	NA	NA	NA
Antenna Tower & Turn Table Controller MF	MF-7802	NA	NA	NA

- Note: 1. The calibration interval of the above test instruments is 12 / 24 months and the calibrations are traceable to NML/ROC and NIST/USA.
2. The test was performed in HwaYa Chamber 10.
3. The horn antenna and preamplifier (model: EMC 184045) are used only for the measurement of emission frequency above 1 GHz if tested.
4. The FCC Site Registration No. is 690701.
5. The IC Site Registration No. is IC7450F-10.

#### 4.1.4 Test Procedures

- a. The EUT was placed on the top of a rotating table 0.8 meters (for below 1 GHz) / 1.5 meters (for above 1 GHz) above the ground at 3 meter chamber room for test. The table was rotated 360 degrees to determine the position of the highest radiation.
- b. The EUT was set 3 meters away from the interference-receiving antenna, which was mounted on the top of a variable-height antenna tower.
- c. The height of antenna is varied from one meter to four meters above the ground to determine the maximum value of the field strength. Both horizontal and vertical polarizations of the antenna are set to make the measurement.
- d. For each suspected emission, the EUT was arranged to its worst case and then the antenna was tuned to heights from 1 meter to 4 meters and the rotatable table was turned from 0 degrees to 360 degrees to find the maximum reading.
- e. The test-receiver system was set to quasi-peak detect function and specified bandwidth with maximum hold mode when the test frequency is below 1 GHz.
- f. The test-receiver system was set to peak and average detected function and specified bandwidth with maximum hold mode when the test frequency is above 1 GHz. If the peak reading value also meets average limit, measurement with the average detector is unnecessary.

**Note:**

1. The resolution bandwidth and video bandwidth of test receiver/spectrum analyzer is 120 kHz & 360 kHz for Quasi-peak detection (QP) at frequency below 1 GHz.
2. The resolution bandwidth of test receiver/spectrum analyzer is 1 MHz and the video bandwidth is 3 MHz for Peak detection (PK) at frequency above 1 GHz.
3. The resolution bandwidth of test receiver/spectrum analyzer is 1 MHz and the video bandwidth is 1/T for Average (Duty cycle < 98 %) detection at frequency above 1 GHz.
4. The resolution bandwidth of test receiver/spectrum analyzer is 1 MHz and the video bandwidth is 10 Hz (Duty cycle ≥ 98 %) for Average detection (AV) at frequency above 1 GHz.
5. All modes of operation were investigated and the worst-case emissions are reported.

#### 4.1.5 Deviation from Test Standard

No deviation.

4.1.6 Test Set Up

<Radiated emission below 30MHz>

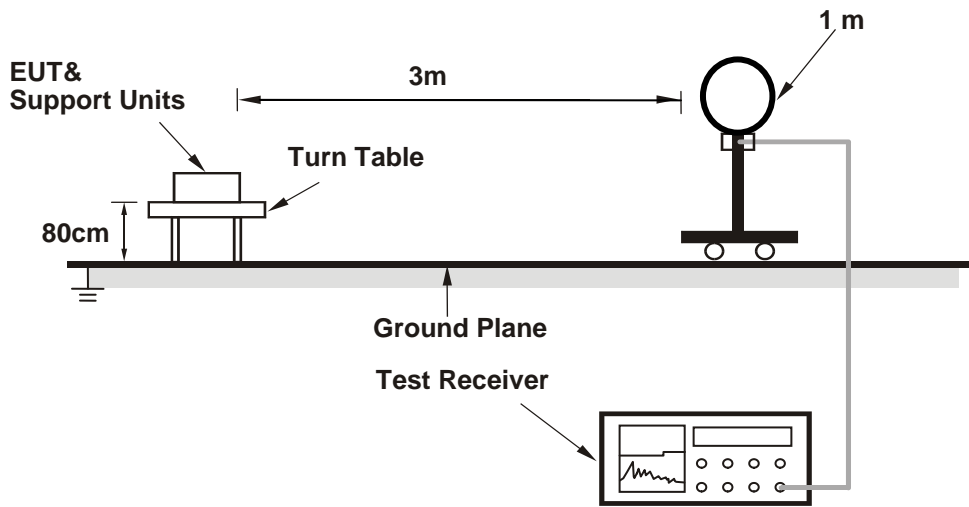

<Frequency Range below 1 GHz>

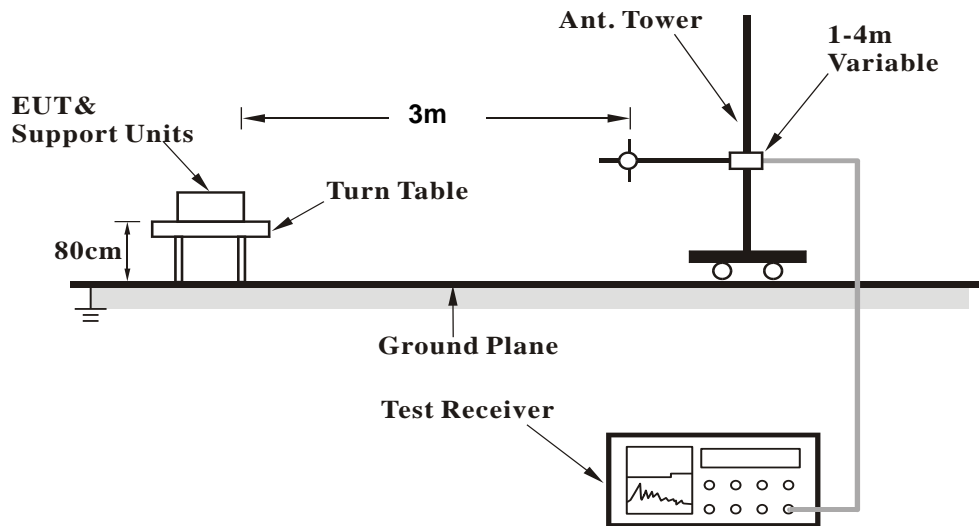

**<Frequency Range above 1 GHz>**

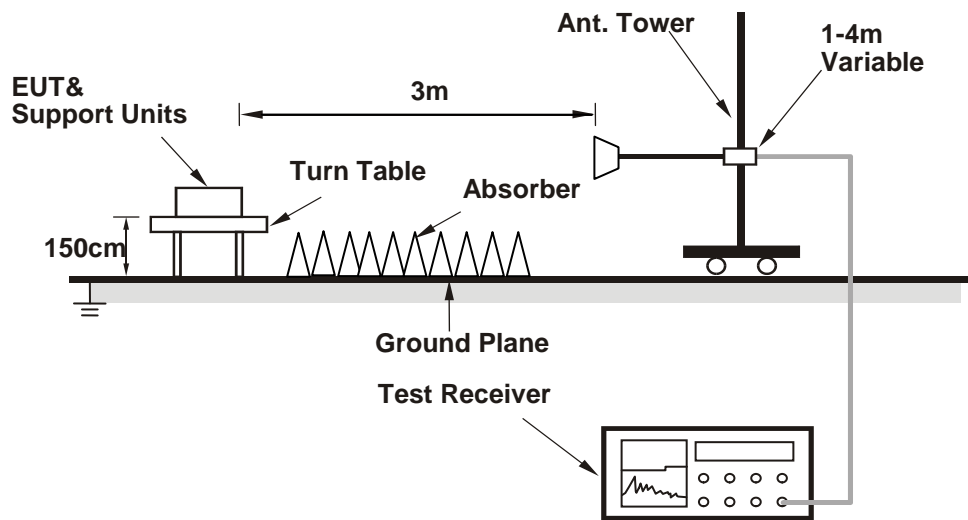

For the actual test configuration, please refer to the attached file (Test Setup Photo).

**4.1.7 EUT Operating Conditions**

- a. Placed the EUT on a testing table.
- b. Use the software to control the EUT under transmission condition continuously at specific channel frequency.

4.1.8 Test Results  
 Above 1 GHz Data :  
 802.11a

EUT Test Condition		Measurement Detail	
Channel	Channel 36	Frequency Range	1 GHz ~ 40 GHz
Input Power	120 Vac, 60 Hz	Detector Function	Peak (PK) Average (AV)
Environmental Conditions	25 deg. C, 65 % RH	Tested By	Getaz Yang

Antenna Polarity & Test Distance: Horizontal at 3 m										
Frequency (MHz)	Emission Level (dBuV/m)	Read Level (dBuV)	Limit (dBuV/m)	Margin (dB)	Antenna Factor (dB/m)	Cable Loss (dB)	Preamp Factor (dB)	Antenna Height (cm)	Table Angle (Degree)	Remark
5148.2	45.91	37.66	54	-8.09	34.12	8.13	34	178	334	Average
5148.2	62.54	54.29	74	-11.46	34.12	8.13	34	178	334	Peak
5180	92.99	84.68			34.15	8.16	34	178	334	Average
5180	101.61	93.3			34.15	8.16	34	178	334	Peak
*10360	55.49	41.19	68.2	-12.71	37.12	12.3	35.12	185	116	Peak

Antenna Polarity & Test Distance: Vertical at 3 m										
Frequency (MHz)	Emission Level (dBuV/m)	Read Level (dBuV)	Limit (dBuV/m)	Margin (dB)	Antenna Factor (dB/m)	Cable Loss (dB)	Preamp Factor (dB)	Antenna Height (cm)	Table Angle (Degree)	Remark
5146.4	45.68	37.43	54	-8.32	34.12	8.13	34	257	10	Average
5146.4	57.94	49.69	74	-16.06	34.12	8.13	34	257	10	Peak
5180	90.43	82.12			34.15	8.16	34	257	10	Average
5180	99.56	91.25			34.15	8.16	34	257	10	Peak
*10360	56.26	41.96	68.2	-11.94	37.12	12.3	35.12	126	334	Peak

Remarks:

- Emission Level = Read Level + Antenna Factor + Cable Loss - Preamp Factor  
 Margin value = Emission level – Limit value
- 5180 MHz: Fundamental Frequency
- \*: Out of Restricted Band

EUT Test Condition		Measurement Detail	
Channel	Channel 44	Frequency Range	1 GHz ~ 40 GHz
Input Power	120 Vac, 60 Hz	Detector Function	Peak (PK) Average (AV)
Environmental Conditions	25 deg. C, 65 % RH	Tested By	Getaz Yang

Antenna Polarity & Test Distance: Horizontal at 3 m										
Frequency (MHz)	Emission Level (dBuV/m)	Read Level (dBuV)	Limit (dBuV/m)	Margin (dB)	Antenna Factor (dB/m)	Cable Loss (dB)	Preamp Factor (dB)	Antenna Height (cm)	Table Angle (Degree)	Remark
5110.4	44.81	36.61	54	-9.19	34.09	8.1	33.99	178	334	Average
5110.4	55.45	47.25	74	-18.55	34.09	8.1	33.99	178	334	Peak
5220	91.69	83.3			34.17	8.22	34	178	334	Average
5220	100.87	92.48			34.17	8.22	34	178	334	Peak
5352.64	45.39	36.76	54	-8.61	34.28	8.38	34.03	178	334	Average
5352.64	57.04	48.41	74	-16.96	34.28	8.38	34.03	178	334	Peak

Antenna Polarity & Test Distance: Vertical at 3 m										
Frequency (MHz)	Emission Level (dBuV/m)	Read Level (dBuV)	Limit (dBuV/m)	Margin (dB)	Antenna Factor (dB/m)	Cable Loss (dB)	Preamp Factor (dB)	Antenna Height (cm)	Table Angle (Degree)	Remark
5148.65	44.82	36.57	54	-9.18	34.12	8.13	34	257	10	Average
5148.65	55.98	47.73	74	-18.02	34.12	8.13	34	257	10	Peak
5220	89.96	81.57			34.17	8.22	34	257	10	Average
5220	98.97	90.58			34.17	8.22	34	257	10	Peak
5444.05	45.37	36.58	54	-8.63	34.35	8.48	34.04	257	10	Average
5444.05	57.51	48.72	74	-16.49	34.35	8.48	34.04	257	10	Peak

Remarks:

- Emission Level = Read Level + Antenna Factor + Cable Loss - Preamp Factor  
Margin value = Emission level – Limit value
- 5220 MHz: Fundamental Frequency

EUT Test Condition		Measurement Detail	
Channel	Channel 48	Frequency Range	1 GHz ~ 40 GHz
Input Power	120 Vac, 60 Hz	Detector Function	Peak (PK) Average (AV)
Environmental Conditions	25 deg. C, 65 % RH	Tested By	Getaz Yang

Antenna Polarity & Test Distance: Horizontal at 3 m										
Frequency (MHz)	Emission Level (dBuV/m)	Read Level (dBuV)	Limit (dBuV/m)	Margin (dB)	Antenna Factor (dB/m)	Cable Loss (dB)	Preamp Factor (dB)	Antenna Height (cm)	Table Angle (Degree)	Remark
5240	92.61	84.17			34.19	8.26	34.01	118	334	Average
5240	101.78	93.34			34.19	8.26	34.01	118	334	Peak
5351.43	45.38	36.75	54	-8.62	34.28	8.38	34.03	118	334	Average
5351.43	56.3	47.67	74	-17.7	34.28	8.38	34.03	118	334	Peak
*10480	57.59	43.08	68.2	-10.61	37.19	12.53	35.21	154	208	Peak

Antenna Polarity & Test Distance: Vertical at 3 m										
Frequency (MHz)	Emission Level (dBuV/m)	Read Level (dBuV)	Limit (dBuV/m)	Margin (dB)	Antenna Factor (dB/m)	Cable Loss (dB)	Preamp Factor (dB)	Antenna Height (cm)	Table Angle (Degree)	Remark
5240	90.34	81.9			34.19	8.26	34.01	257	10	Average
5240	99.32	90.88			34.19	8.26	34.01	257	10	Peak
5440.2	45.41	36.62	54	-8.59	34.35	8.48	34.04	257	10	Average
5440.2	55.26	46.47	74	-18.74	34.35	8.48	34.04	257	10	Peak
*10480	56.87	42.36	68.2	-11.33	37.19	12.53	35.21	195	134	Peak

Remarks:

- Emission Level = Read Level + Antenna Factor + Cable Loss - Preamp Factor  
Margin value = Emission level – Limit value
- 5240 MHz: Fundamental Frequency
- \*: Out of Restricted Band



EUT Test Condition		Measurement Detail	
Channel	Channel 52	Frequency Range	1 GHz ~ 40 GHz
Input Power	120 Vac, 60 Hz	Detector Function	Peak (PK) Average (AV)
Environmental Conditions	25 deg. C, 65 % RH	Tested By	Getaz Yang

Antenna Polarity & Test Distance: Horizontal at 3 m										
Frequency (MHz)	Emission Level (dBuV/m)	Read Level (dBuV)	Limit (dBuV/m)	Margin (dB)	Antenna Factor (dB/m)	Cable Loss (dB)	Preamp Factor (dB)	Antenna Height (cm)	Table Angle (Degree)	Remark
5147.6	44.89	36.64	54	-9.11	34.12	8.13	34	118	329	Average
5147.6	55.21	46.96	74	-18.79	34.12	8.13	34	118	329	Peak
5260	93.68	85.22			34.21	8.26	34.01	118	329	Average
5260	102.59	94.13			34.21	8.26	34.01	118	329	Peak
*10520	57.48	42.89	68.2	-10.72	37.21	12.61	35.23	137	199	Peak

Antenna Polarity & Test Distance: Vertical at 3 m										
Frequency (MHz)	Emission Level (dBuV/m)	Read Level (dBuV)	Limit (dBuV/m)	Margin (dB)	Antenna Factor (dB/m)	Cable Loss (dB)	Preamp Factor (dB)	Antenna Height (cm)	Table Angle (Degree)	Remark
5095.7	44.88	36.72	54	-9.12	34.08	8.07	33.99	247	0	Average
5095.7	56.54	48.38	74	-17.46	34.08	8.07	33.99	247	0	Peak
5260	88.93	80.47			34.21	8.26	34.01	247	0	Average
5260	99.96	91.5			34.21	8.26	34.01	247	0	Peak
*10520	57.47	42.88	68.2	-10.73	37.21	12.61	35.23	127	196	Peak

Remarks:

- Emission Level = Read Level + Antenna Factor + Cable Loss - Preamp Factor  
Margin value = Emission level – Limit value
- 5260 MHz: Fundamental Frequency
- \*: Out of Restricted Band

EUT Test Condition		Measurement Detail	
Channel	Channel 60	Frequency Range	1 GHz ~ 40 GHz
Input Power	120 Vac, 60 Hz	Detector Function	Peak (PK) Average (AV)
Environmental Conditions	25 deg. C, 65 % RH	Tested By	Getaz Yang

Antenna Polarity & Test Distance: Horizontal at 3 m										
Frequency (MHz)	Emission Level (dBuV/m)	Read Level (dBuV)	Limit (dBuV/m)	Margin (dB)	Antenna Factor (dB/m)	Cable Loss (dB)	Preamp Factor (dB)	Antenna Height (cm)	Table Angle (Degree)	Remark
5134.1	44.75	36.5	54	-9.25	34.11	8.13	33.99	118	329	Average
5134.1	55.48	47.23	74	-18.52	34.11	8.13	33.99	118	329	Peak
5300	93.73	85.19			34.24	8.32	34.02	118	329	Average
5300	102.82	94.28			34.24	8.32	34.02	118	329	Peak
5351.21	45.56	36.93	54	-8.44	34.28	8.38	34.03	118	329	Average
5351.21	57.19	48.56	74	-16.81	34.28	8.38	34.03	118	329	Peak

Antenna Polarity & Test Distance: Vertical at 3 m										
Frequency (MHz)	Emission Level (dBuV/m)	Read Level (dBuV)	Limit (dBuV/m)	Margin (dB)	Antenna Factor (dB/m)	Cable Loss (dB)	Preamp Factor (dB)	Antenna Height (cm)	Table Angle (Degree)	Remark
5134.85	44.85	36.6	54	-9.15	34.11	8.13	33.99	247	0	Average
5134.85	55.99	47.74	74	-18.01	34.11	8.13	33.99	247	0	Peak
5300	91.01	82.47			34.24	8.32	34.02	247	0	Average
5300	99.91	91.37			34.24	8.32	34.02	247	0	Peak
5433.82	45.52	36.73	54	-8.48	34.35	8.48	34.04	247	0	Average
5433.82	55.19	46.4	74	-18.81	34.35	8.48	34.04	247	0	Peak

Remarks:

- Emission Level = Read Level + Antenna Factor + Cable Loss - Preamp Factor  
Margin value = Emission level – Limit value
- 5300 MHz: Fundamental Frequency

EUT Test Condition		Measurement Detail	
Channel	Channel 64	Frequency Range	1 GHz ~ 40 GHz
Input Power	120 Vac, 60 Hz	Detector Function	Peak (PK) Average (AV)
Environmental Conditions	25 deg. C, 65 % RH	Tested By	Getaz Yang

Antenna Polarity & Test Distance: Horizontal at 3 m										
Frequency (MHz)	Emission Level (dBuV/m)	Read Level (dBuV)	Limit (dBuV/m)	Margin (dB)	Antenna Factor (dB/m)	Cable Loss (dB)	Preamp Factor (dB)	Antenna Height (cm)	Table Angle (Degree)	Remark
5320	92.67	84.09			34.25	8.35	34.02	118	329	Average
5320	102	93.42			34.25	8.35	34.02	118	329	Peak
5350.33	45.63	37	54	-8.37	34.28	8.38	34.03	118	329	Average
5350.33	58.71	50.08	74	-15.29	34.28	8.38	34.03	118	329	Peak
10640	47.85	33.12	54	-6.15	37.31	12.71	35.29	126	83	Average
10640	56.42	41.69	74	-17.58	37.31	12.71	35.29	126	83	Peak

Antenna Polarity & Test Distance: Vertical at 3 m										
Frequency (MHz)	Emission Level (dBuV/m)	Read Level (dBuV)	Limit (dBuV/m)	Margin (dB)	Antenna Factor (dB/m)	Cable Loss (dB)	Preamp Factor (dB)	Antenna Height (cm)	Table Angle (Degree)	Remark
5320	89.97	81.39			34.25	8.35	34.02	247	0	Average
5320	99.3	90.72			34.25	8.35	34.02	247	0	Peak
5409.73	45.38	36.66	54	-8.62	34.32	8.44	34.04	247	0	Average
5409.73	55.9	47.18	74	-18.1	34.32	8.44	34.04	247	0	Peak
10640	47.97	33.24	54	-6.03	37.31	12.71	35.29	152	332	Average
10640	57.06	42.33	74	-16.94	37.31	12.71	35.29	152	332	Peak

Remarks:

- Emission Level = Read Level + Antenna Factor + Cable Loss - Preamp Factor  
Margin value = Emission level – Limit value
- 5320 MHz: Fundamental Frequency

EUT Test Condition		Measurement Detail	
Channel	Channel 100	Frequency Range	1 GHz ~ 40 GHz
Input Power	120 Vac, 60 Hz	Detector Function	Peak (PK) Average (AV)
Environmental Conditions	25 deg. C, 65 % RH	Tested By	Getaz Yang

Antenna Polarity & Test Distance: Horizontal at 3 m										
Frequency (MHz)	Emission Level (dBuV/m)	Read Level (dBuV)	Limit (dBuV/m)	Margin (dB)	Antenna Factor (dB/m)	Cable Loss (dB)	Preamp Factor (dB)	Antenna Height (cm)	Table Angle (Degree)	Remark
5430.48	45.45	36.66	54	-8.55	34.35	8.48	34.04	266	341	Average
5430.48	54.29	45.5	74	-19.71	34.35	8.48	34.04	266	341	Peak
*5468.56	53.93	45.1	68.2	-14.27	34.37	8.51	34.05	266	341	Peak
5500	87.14	78.22			34.4	8.57	34.05	266	341	Average
5500	96.72	87.8			34.4	8.57	34.05	266	341	Peak
11000	46.74	31.66	54	-7.26	37.6	12.96	35.48	166	134	Average
11000	55.78	40.7	74	-18.22	37.6	12.96	35.48	166	134	Peak
Antenna Polarity & Test Distance: Vertical at 3 m										
Frequency (MHz)	Emission Level (dBuV/m)	Read Level (dBuV)	Limit (dBuV/m)	Margin (dB)	Antenna Factor (dB/m)	Cable Loss (dB)	Preamp Factor (dB)	Antenna Height (cm)	Table Angle (Degree)	Remark
5350.16	45.55	36.92	54	-8.45	34.28	8.38	34.03	100	9	Average
5350.16	54.24	45.61	74	-19.76	34.28	8.38	34.03	100	9	Peak
*5470.48	55.99	47.16	68.2	-12.21	34.37	8.51	34.05	100	9	Peak
5500	91.72	82.8			34.4	8.57	34.05	100	9	Average
5500	101.4	92.48			34.4	8.57	34.05	100	9	Peak
11000	45.28	30.2	54	-8.72	37.6	12.96	35.48	136	255	Average
11000	54.1	39.02	74	-19.9	37.6	12.96	35.48	136	255	Peak

Remarks:

- Emission Level = Read Level + Antenna Factor + Cable Loss - Preamp Factor  
Margin value = Emission level – Limit value
- 5500 MHz: Fundamental Frequency
- \*: Out of Restricted Band

EUT Test Condition		Measurement Detail	
Channel	Channel 116	Frequency Range	1 GHz ~ 40 GHz
Input Power	120 Vac, 60 Hz	Detector Function	Peak (PK) Average (AV)
Environmental Conditions	25 deg. C, 65 % RH	Tested By	Getaz Yang

Antenna Polarity & Test Distance: Horizontal at 3 m										
Frequency (MHz)	Emission Level (dBuV/m)	Read Level (dBuV)	Limit (dBuV/m)	Margin (dB)	Antenna Factor (dB/m)	Cable Loss (dB)	Preamp Factor (dB)	Antenna Height (cm)	Table Angle (Degree)	Remark
5454.16	45.32	36.5	54	-8.68	34.36	8.51	34.05	219	341	Average
5454.16	54.2	45.38	74	-19.8	34.36	8.51	34.05	219	341	Peak
*5469.68	54.27	45.44	68.2	-13.93	34.37	8.51	34.05	219	341	Peak
5580	88.98	79.99			34.47	8.6	34.08	219	341	Average
5580	99.54	90.55			34.47	8.6	34.08	219	341	Peak
*5724.52	54.07	44.91	68.2	-14.13	34.62	8.65	34.11	219	341	Peak

Antenna Polarity & Test Distance: Vertical at 3 m										
Frequency (MHz)	Emission Level (dBuV/m)	Read Level (dBuV)	Limit (dBuV/m)	Margin (dB)	Antenna Factor (dB/m)	Cable Loss (dB)	Preamp Factor (dB)	Antenna Height (cm)	Table Angle (Degree)	Remark
5442.32	45.23	36.44	54	-8.77	34.35	8.48	34.04	100	206	Average
5442.32	54.87	46.08	74	-19.13	34.35	8.48	34.04	100	206	Peak
*5470.64	53.73	44.9	68.2	-14.47	34.37	8.51	34.05	100	206	Peak
5580	92.76	83.77			34.47	8.6	34.08	100	206	Average
5580	102.65	93.66			34.47	8.6	34.08	100	206	Peak
*5725.32	53.27	44.11	68.2	-14.93	34.62	8.65	34.11	100	206	Peak

Remarks:

- Emission Level = Read Level + Antenna Factor + Cable Loss - Preamp Factor  
Margin value = Emission level – Limit value
- 5580 MHz: Fundamental Frequency
- \*: Out of Restricted Band

EUT Test Condition		Measurement Detail	
Channel	Channel 140	Frequency Range	1 GHz ~ 40 GHz
Input Power	120 Vac, 60 Hz	Detector Function	Peak (PK) Average (AV)
Environmental Conditions	25 deg. C, 65 % RH	Tested By	Getaz Yang

Antenna Polarity & Test Distance: Horizontal at 3 m										
Frequency (MHz)	Emission Level (dBuV/m)	Read Level (dBuV)	Limit (dBuV/m)	Margin (dB)	Antenna Factor (dB/m)	Cable Loss (dB)	Preamp Factor (dB)	Antenna Height (cm)	Table Angle (Degree)	Remark
5700	86.03	76.9			34.59	8.64	34.1	219	341	Average
5700	95.68	86.55			34.59	8.64	34.1	219	341	Peak
*5724.68	53.64	44.48	68.2	-14.56	34.62	8.65	34.11	219	341	Peak
11400	45.36	30.26	54	-8.64	37.84	12.67	35.41	136	227	Average
11400	54.78	39.68	74	-19.22	37.84	12.67	35.41	136	227	Peak

Antenna Polarity & Test Distance: Vertical at 3 m										
Frequency (MHz)	Emission Level (dBuV/m)	Read Level (dBuV)	Limit (dBuV/m)	Margin (dB)	Antenna Factor (dB/m)	Cable Loss (dB)	Preamp Factor (dB)	Antenna Height (cm)	Table Angle (Degree)	Remark
5700	90.4	81.27			34.59	8.64	34.1	104	201	Average
5700	100.04	90.91			34.59	8.64	34.1	104	201	Peak
*5724.44	55	45.84	68.2	-13.2	34.62	8.65	34.11	104	201	Peak
11400	45.22	30.12	54	-8.78	37.84	12.67	35.41	184	105	Average
11400	53.84	38.74	74	-20.16	37.84	12.67	35.41	184	105	Peak

Remarks:

- Emission Level = Read Level + Antenna Factor + Cable Loss - Preamp Factor  
Margin value = Emission level – Limit value
- 5700 MHz: Fundamental Frequency
- \*: Out of Restricted Band

EUT Test Condition		Measurement Detail	
Channel	Channel 149	Frequency Range	1 GHz ~ 40 GHz
Input Power	120 Vac, 60 Hz	Detector Function	Peak (PK) Average (AV)
Environmental Conditions	25 deg. C, 65 % RH	Tested By	Getaz Yang

**<Spurious Emission>**

Antenna Polarity & Test Distance: Horizontal at 3 m										
Frequency (MHz)	Emission Level (dBuV/m)	Read Level (dBuV)	Limit (dBuV/m)	Margin (dB)	Antenna Factor (dB/m)	Cable Loss (dB)	Preamp Factor (dB)	Antenna Height (cm)	Table Angle (Degree)	Remark
5745	88.12	78.93			34.64	8.66	34.11	200	34	Average
5745	97.71	88.52			34.64	8.66	34.11	200	34	Peak
11490	46.91	31.79	54	-7.09	37.89	12.62	35.39	149	245	Average
11490	54.5	39.38	74	-19.5	37.89	12.62	35.39	149	245	Peak
Antenna Polarity & Test Distance: Vertical at 3 m										
Frequency (MHz)	Emission Level (dBuV/m)	Read Level (dBuV)	Limit (dBuV/m)	Margin (dB)	Antenna Factor (dB/m)	Cable Loss (dB)	Preamp Factor (dB)	Antenna Height (cm)	Table Angle (Degree)	Remark
5745	90.98	81.79			34.64	8.66	34.11	101	30	Average
5745	100.2	91.01			34.64	8.66	34.11	101	30	Peak
11490	47.04	31.92	54	-6.96	37.89	12.62	35.39	185	346	Average
11490	55.12	40	74	-18.88	37.89	12.62	35.39	185	346	Peak

**<Out of Band Emission (OOBE)>**

Antenna Polarity & Test Distance: Horizontal at 3 m										
Frequency (MHz)	Emission Level (dBuV/m)	Read Level (dBuV)	Limit (dBuV/m)	Margin (dB)	Antenna Factor (dB/m)	Cable Loss (dB)	Preamp Factor (dB)	Antenna Height (cm)	Table Angle (Degree)	Remark
*5566.15	56.35	47.36	68.2	-11.85	34.47	8.59	34.07	200	34	Peak
5653.3	55.47	46.37	70.64	-15.17	34.56	8.63	34.09	200	34	Peak
5922.625	55.82	46.42	69.96	-14.14	34.83	8.73	34.16	200	34	Peak
*5983.525	56.99	47.53	68.2	-11.21	34.88	8.75	34.17	200	34	Peak
Antenna Polarity & Test Distance: Vertical at 3 m										
Frequency (MHz)	Emission Level (dBuV/m)	Read Level (dBuV)	Limit (dBuV/m)	Margin (dB)	Antenna Factor (dB/m)	Cable Loss (dB)	Preamp Factor (dB)	Antenna Height (cm)	Table Angle (Degree)	Remark
*5570.875	57.09	48.1	68.2	-11.11	34.47	8.59	34.07	101	30	Peak
5651.725	54.33	45.24	69.48	-15.15	34.56	8.62	34.09	101	30	Peak
5923.675	53.59	44.19	69.18	-15.59	34.83	8.73	34.16	101	30	Peak
*6025	56.5	46.98	68.2	-11.7	34.93	8.77	34.18	101	30	Peak

Remarks:

- Emission Level = Read Level + Antenna Factor + Cable Loss - Preamp Factor  
Margin value = Emission level – Limit value
- 5745 MHz: Fundamental Frequency
- \*: Out of Restricted Band

EUT Test Condition		Measurement Detail	
Channel	Channel 157	Frequency Range	1 GHz ~ 40 GHz
Input Power	120 Vac, 60 Hz	Detector Function	Peak (PK) Average (AV)
Environmental Conditions	25 deg. C, 65 % RH	Tested By	Getaz Yang

**<Spurious Emission>**

Antenna Polarity & Test Distance: Horizontal at 3 m										
Frequency (MHz)	Emission Level (dBuV/m)	Read Level (dBuV)	Limit (dBuV/m)	Margin (dB)	Antenna Factor (dB/m)	Cable Loss (dB)	Preamp Factor (dB)	Antenna Height (cm)	Table Angle (Degree)	Remark
5785	92.44	83.21			34.68	8.68	34.13	101	30	Average
5785	102.7	93.47			34.68	8.68	34.13	101	30	Peak
11570	47.16	31.85	54	-6.84	38	12.68	35.37	177	195	Average
11570	54.93	39.62	74	-19.07	38	12.68	35.37	177	195	Peak
Antenna Polarity & Test Distance: Vertical at 3 m										
Frequency (MHz)	Emission Level (dBuV/m)	Read Level (dBuV)	Limit (dBuV/m)	Margin (dB)	Antenna Factor (dB/m)	Cable Loss (dB)	Preamp Factor (dB)	Antenna Height (cm)	Table Angle (Degree)	Remark
5785	89.6	80.37			34.68	8.68	34.13	200	34	Average
5785	99.64	90.41			34.68	8.68	34.13	200	34	Peak
11570	47.3	31.99	54	-6.7	38	12.68	35.37	185	195	Average
11570	54.94	39.63	74	-19.06	38	12.68	35.37	185	195	Peak

**<Out of Band Emission (OOBE)>**

Antenna Polarity & Test Distance: Horizontal at 3 m										
Frequency (MHz)	Emission Level (dBuV/m)	Read Level (dBuV)	Limit (dBuV/m)	Margin (dB)	Antenna Factor (dB/m)	Cable Loss (dB)	Preamp Factor (dB)	Antenna Height (cm)	Table Angle (Degree)	Remark
*5577.175	57.79	48.79	68.2	-10.41	34.47	8.6	34.07	200	34	Peak
5652.25	54.35	45.26	69.86	-15.51	34.56	8.62	34.09	200	34	Peak
5923.15	53.14	43.74	69.57	-16.43	34.83	8.73	34.16	200	34	Peak
*6009.25	57.51	48	68.2	-10.69	34.92	8.76	34.17	200	34	Peak
Antenna Polarity & Test Distance: Vertical at 3 m										
Frequency (MHz)	Emission Level (dBuV/m)	Read Level (dBuV)	Limit (dBuV/m)	Margin (dB)	Antenna Factor (dB/m)	Cable Loss (dB)	Preamp Factor (dB)	Antenna Height (cm)	Table Angle (Degree)	Remark
*5565.1	57.28	48.29	68.2	-10.92	34.47	8.59	34.07	101	30	Peak
5651.725	54.11	45.02	69.48	-15.37	34.56	8.62	34.09	101	30	Peak
5923.675	52.99	43.59	69.18	-16.19	34.83	8.73	34.16	101	30	Peak
*6006.1	56.39	46.9	68.2	-11.81	34.9	8.76	34.17	101	30	Peak

Remarks:

- Emission Level = Read Level + Antenna Factor + Cable Loss - Preamp Factor  
Margin value = Emission level – Limit value
- 5785 MHz: Fundamental Frequency
- \*: Out of Restricted Band



EUT Test Condition		Measurement Detail	
Channel	Channel 165	Frequency Range	1 GHz ~ 40 GHz
Input Power	120 Vac, 60 Hz	Detector Function	Peak (PK) Average (AV)
Environmental Conditions	25 deg. C, 65 % RH	Tested By	Getaz Yang

<Spurious Emission>

Antenna Polarity & Test Distance: Horizontal at 3 m										
Frequency (MHz)	Emission Level (dBuV/m)	Read Level (dBuV)	Limit (dBuV/m)	Margin (dB)	Antenna Factor (dB/m)	Cable Loss (dB)	Preamp Factor (dB)	Antenna Height (cm)	Table Angle (Degree)	Remark
5825	90.09	80.8			34.73	8.69	34.13	200	34	Average
5825	99.95	90.66			34.73	8.69	34.13	200	34	Peak
11650	47.31	31.78	54	-6.69	38.09	12.8	35.36	105	214	Average
11650	55.62	40.09	74	-18.38	38.09	12.8	35.36	105	214	Peak
Antenna Polarity & Test Distance: Vertical at 3 m										
Frequency (MHz)	Emission Level (dBuV/m)	Read Level (dBuV)	Limit (dBuV/m)	Margin (dB)	Antenna Factor (dB/m)	Cable Loss (dB)	Preamp Factor (dB)	Antenna Height (cm)	Table Angle (Degree)	Remark
5825	92.32	83.03			34.73	8.69	34.13	101	30	Average
5825	102.12	92.83			34.73	8.69	34.13	101	30	Peak
11650	47.54	32.01	54	-6.46	38.09	12.8	35.36	180	93	Average
11650	56.67	41.14	74	-17.33	38.09	12.8	35.36	180	93	Peak

<Out of Band Emission (OOBE)>

Antenna Polarity & Test Distance: Horizontal at 3 m										
Frequency (MHz)	Emission Level (dBuV/m)	Read Level (dBuV)	Limit (dBuV/m)	Margin (dB)	Antenna Factor (dB/m)	Cable Loss (dB)	Preamp Factor (dB)	Antenna Height (cm)	Table Angle (Degree)	Remark
*5580.85	57.01	48.02	68.2	-11.19	34.47	8.6	34.08	200	34	Peak
5652.25	54.23	45.14	69.86	-15.63	34.56	8.62	34.09	200	34	Peak
5922.625	54.8	45.4	69.96	-15.16	34.83	8.73	34.16	200	34	Peak
*5985.625	56.49	47.03	68.2	-11.71	34.88	8.75	34.17	200	34	Peak
Antenna Polarity & Test Distance: Vertical at 3 m										
Frequency (MHz)	Emission Level (dBuV/m)	Read Level (dBuV)	Limit (dBuV/m)	Margin (dB)	Antenna Factor (dB/m)	Cable Loss (dB)	Preamp Factor (dB)	Antenna Height (cm)	Table Angle (Degree)	Remark
*5591.875	57.36	48.35	68.2	-10.84	34.49	8.6	34.08	101	30	Peak
5654.35	57.38	48.29	71.42	-14.04	34.56	8.63	34.1	101	30	Peak
5923.675	54.16	44.76	69.18	-15.02	34.83	8.73	34.16	101	30	Peak
*6010.3	56.77	47.26	68.2	-11.43	34.92	8.76	34.17	101	30	Peak

Remarks:

- Emission Level = Read Level + Antenna Factor + Cable Loss - Preamp Factor  
Margin value = Emission level – Limit value
- 5825 MHz: Fundamental Frequency
- \*: Out of Restricted Band

**802.11n (HT20)**

EUT Test Condition		Measurement Detail	
Channel	Channel 36	Frequency Range	1 GHz ~ 40 GHz
Input Power	120 Vac, 60 Hz	Detector Function	Peak (PK) Average (AV)
Environmental Conditions	25 deg. C, 65 % RH	Tested By	Getaz Yang

**Antenna Polarity & Test Distance: Horizontal at 3 m**

Frequency (MHz)	Emission Level (dBuV/m)	Read Level (dBuV)	Limit (dBuV/m)	Margin (dB)	Antenna Factor (dB/m)	Cable Loss (dB)	Preamp Factor (dB)	Antenna Height (cm)	Table Angle (Degree)	Remark
5147.45	45.44	37.19	54	-8.56	34.12	8.13	34	178	334	Average
5147.45	57.37	49.12	74	-16.63	34.12	8.13	34	178	334	Peak
5180	91.64	83.33			34.15	8.16	34	178	334	Average
5180	100.6	92.29			34.15	8.16	34	178	334	Peak
*10360	55.38	41.08	68.2	-12.82	37.12	12.3	35.12	109	345	Peak

**Antenna Polarity & Test Distance: Vertical at 3 m**

Frequency (MHz)	Emission Level (dBuV/m)	Read Level (dBuV)	Limit (dBuV/m)	Margin (dB)	Antenna Factor (dB/m)	Cable Loss (dB)	Preamp Factor (dB)	Antenna Height (cm)	Table Angle (Degree)	Remark
5002.25	45.22	37.25	54	-8.78	34	7.94	33.97	257	10	Average
5002.25	56.15	48.18	74	-17.85	34	7.94	33.97	257	10	Peak
5180	89.93	47.62			34.15	8.16	0	257	10	Average
5180	98.91	56.6			34.15	8.16	0	257	10	Peak
*10360	56.44	42.14	68.2	-11.76	37.12	12.3	35.12	133	128	Peak

## Remarks:

- Emission Level = Read Level + Antenna Factor + Cable Loss - Preamp Factor  
Margin value = Emission level – Limit value
- 5180 MHz: Fundamental Frequency
- \*: Out of Restricted Band

EUT Test Condition		Measurement Detail	
Channel	Channel 44	Frequency Range	1 GHz ~ 40 GHz
Input Power	120 Vac, 60 Hz	Detector Function	Peak (PK) Average (AV)
Environmental Conditions	25 deg. C, 65 % RH	Tested By	Getaz Yang

Antenna Polarity & Test Distance: Horizontal at 3 m										
Frequency (MHz)	Emission Level (dBuV/m)	Read Level (dBuV)	Limit (dBuV/m)	Margin (dB)	Antenna Factor (dB/m)	Cable Loss (dB)	Preamp Factor (dB)	Antenna Height (cm)	Table Angle (Degree)	Remark
5141.15	44.78	36.52	54	-9.22	34.12	8.13	33.99	118	334	Average
5141.15	55.45	47.19	74	-18.55	34.12	8.13	33.99	118	334	Peak
5220	91.22	82.83			34.17	8.22	34	118	334	Average
5220	100.42	92.03			34.17	8.22	34	118	334	Peak
5350.44	45.55	36.92	54	-8.45	34.28	8.38	34.03	118	334	Average
5350.44	56.19	47.56	74	-17.81	34.28	8.38	34.03	118	334	Peak

Antenna Polarity & Test Distance: Vertical at 3 m										
Frequency (MHz)	Emission Level (dBuV/m)	Read Level (dBuV)	Limit (dBuV/m)	Margin (dB)	Antenna Factor (dB/m)	Cable Loss (dB)	Preamp Factor (dB)	Antenna Height (cm)	Table Angle (Degree)	Remark
5002.25	44.76	36.79	54	-9.24	34	7.94	33.97	257	10	Average
5002.25	56.25	48.28	74	-17.75	34	7.94	33.97	257	10	Peak
5220	87.01	78.62			34.17	8.22	34	257	10	Average
5220	99.33	90.94			34.17	8.22	34	257	10	Peak
5452.19	45.46	36.64	54	-8.54	34.36	8.51	34.05	257	10	Average
5452.19	56.14	47.32	74	-17.86	34.36	8.51	34.05	257	10	Peak

Remarks:

- Emission Level = Read Level + Antenna Factor + Cable Loss - Preamp Factor  
Margin value = Emission level – Limit value
- 5220 MHz: Fundamental Frequency

EUT Test Condition		Measurement Detail	
Channel	Channel 48	Frequency Range	1 GHz ~ 40 GHz
Input Power	120 Vac, 60 Hz	Detector Function	Peak (PK) Average (AV)
Environmental Conditions	25 deg. C, 65 % RH	Tested By	Getaz Yang

Antenna Polarity & Test Distance: Horizontal at 3 m										
Frequency (MHz)	Emission Level (dBuV/m)	Read Level (dBuV)	Limit (dBuV/m)	Margin (dB)	Antenna Factor (dB/m)	Cable Loss (dB)	Preamp Factor (dB)	Antenna Height (cm)	Table Angle (Degree)	Remark
5240	91.14	82.7			34.19	8.26	34.01	178	334	Average
5240	100.44	92			34.19	8.26	34.01	178	334	Peak
5412.48	45.36	36.63	54	-8.64	34.33	8.44	34.04	178	334	Average
5412.48	55.97	47.24	74	-18.03	34.33	8.44	34.04	178	334	Peak
*10480	57.62	43.11	68.2	-10.58	37.19	12.53	35.21	196	238	Peak

Antenna Polarity & Test Distance: Vertical at 3 m										
Frequency (MHz)	Emission Level (dBuV/m)	Read Level (dBuV)	Limit (dBuV/m)	Margin (dB)	Antenna Factor (dB/m)	Cable Loss (dB)	Preamp Factor (dB)	Antenna Height (cm)	Table Angle (Degree)	Remark
5240	90.7	82.26			34.19	8.26	34.01	257	10	Average
5240	99.65	91.21			34.19	8.26	34.01	257	10	Peak
5350.33	45.37	36.74	54	-8.63	34.28	8.38	34.03	257	10	Average
5350.33	56.54	47.91	74	-17.46	34.28	8.38	34.03	257	10	Peak
*10480	56.69	42.18	68.2	-11.51	37.19	12.53	35.21	127	68	Peak

Remarks:

- Emission Level = Read Level + Antenna Factor + Cable Loss - Preamp Factor  
Margin value = Emission level – Limit value
- 5240 MHz: Fundamental Frequency
- \*: Out of Restricted Band

EUT Test Condition		Measurement Detail	
Channel	Channel 52	Frequency Range	1 GHz ~ 40 GHz
Input Power	120 Vac, 60 Hz	Detector Function	Peak (PK) Average (AV)
Environmental Conditions	25 deg. C, 65 % RH	Tested By	Getaz Yang

Antenna Polarity & Test Distance: Horizontal at 3 m										
Frequency (MHz)	Emission Level (dBuV/m)	Read Level (dBuV)	Limit (dBuV/m)	Margin (dB)	Antenna Factor (dB/m)	Cable Loss (dB)	Preamp Factor (dB)	Antenna Height (cm)	Table Angle (Degree)	Remark
5134.4	44.77	36.52	54	-9.23	34.11	8.13	33.99	118	329	Average
5134.4	56.09	47.84	74	-17.91	34.11	8.13	33.99	118	329	Peak
5260	92.83	84.37			34.21	8.26	34.01	118	329	Average
5260	101.61	93.15			34.21	8.26	34.01	118	329	Peak
*10520	57.48	42.89	68.2	-10.72	37.21	12.61	35.23	192	106	Peak

Antenna Polarity & Test Distance: Vertical at 3 m										
Frequency (MHz)	Emission Level (dBuV/m)	Read Level (dBuV)	Limit (dBuV/m)	Margin (dB)	Antenna Factor (dB/m)	Cable Loss (dB)	Preamp Factor (dB)	Antenna Height (cm)	Table Angle (Degree)	Remark
5123.9	44.77	36.55	54	-9.23	34.11	8.1	33.99	247	0	Average
5123.9	56.34	48.12	74	-17.66	34.11	8.1	33.99	247	0	Peak
5260	89.9	81.44			34.21	8.26	34.01	247	0	Average
5260	99.17	90.71			34.21	8.26	34.01	247	0	Peak
*10520	57.47	42.88	68.2	-10.73	37.21	12.61	35.23	157	262	Peak

Remarks:

- Emission Level = Read Level + Antenna Factor + Cable Loss - Preamp Factor  
Margin value = Emission level – Limit value
- 5260 MHz: Fundamental Frequency
- \*: Out of Restricted Band

EUT Test Condition		Measurement Detail	
Channel	Channel 60	Frequency Range	1 GHz ~ 40 GHz
Input Power	120 Vac, 60 Hz	Detector Function	Peak (PK) Average (AV)
Environmental Conditions	25 deg. C, 65 % RH	Tested By	Getaz Yang

Antenna Polarity & Test Distance: Horizontal at 3 m										
Frequency (MHz)	Emission Level (dBuV/m)	Read Level (dBuV)	Limit (dBuV/m)	Margin (dB)	Antenna Factor (dB/m)	Cable Loss (dB)	Preamp Factor (dB)	Antenna Height (cm)	Table Angle (Degree)	Remark
5132.75	44.89	36.67	54	-9.11	34.11	8.1	33.99	118	329	Average
5132.75	55.89	47.67	74	-18.11	34.11	8.1	33.99	118	329	Peak
5300	92.86	84.32			34.24	8.32	34.02	118	329	Average
5300	102	93.46			34.24	8.32	34.02	118	329	Peak
5357.15	45.57	36.94	54	-8.43	34.28	8.38	34.03	118	329	Average
5357.15	55.8	47.17	74	-18.2	34.28	8.38	34.03	118	329	Peak
Antenna Polarity & Test Distance: Vertical at 3 m										
Frequency (MHz)	Emission Level (dBuV/m)	Read Level (dBuV)	Limit (dBuV/m)	Margin (dB)	Antenna Factor (dB/m)	Cable Loss (dB)	Preamp Factor (dB)	Antenna Height (cm)	Table Angle (Degree)	Remark
5138	44.87	36.62	54	-9.13	34.11	8.13	33.99	247	0	Average
5138	55.06	46.81	74	-18.94	34.11	8.13	33.99	247	0	Peak
5300	87.41	78.87			34.24	8.32	34.02	247	0	Average
5300	96.24	87.7			34.24	8.32	34.02	247	0	Peak
5436.46	45.46	36.67	54	-8.54	34.35	8.48	34.04	247	0	Average
5436.46	55.94	47.15	74	-18.06	34.35	8.48	34.04	247	0	Peak

Remarks:

- Emission Level = Read Level + Antenna Factor + Cable Loss - Preamp Factor  
Margin value = Emission level – Limit value
- 5300 MHz: Fundamental Frequency

EUT Test Condition		Measurement Detail	
Channel	Channel 64	Frequency Range	1 GHz ~ 40 GHz
Input Power	120 Vac, 60 Hz	Detector Function	Peak (PK) Average (AV)
Environmental Conditions	25 deg. C, 65 % RH	Tested By	Getaz Yang

Antenna Polarity & Test Distance: Horizontal at 3 m										
Frequency (MHz)	Emission Level (dBuV/m)	Read Level (dBuV)	Limit (dBuV/m)	Margin (dB)	Antenna Factor (dB/m)	Cable Loss (dB)	Preamp Factor (dB)	Antenna Height (cm)	Table Angle (Degree)	Remark
5320	91.82	83.24			34.25	8.35	34.02	118	329	Average
5320	101.32	92.74			34.25	8.35	34.02	118	329	Peak
5355.39	45.43	36.8	54	-8.57	34.28	8.38	34.03	118	329	Average
5355.39	56.66	48.03	74	-17.34	34.28	8.38	34.03	118	329	Peak
10640	47.54	32.81	54	-6.46	37.31	12.71	35.29	136	244	Average
10640	56.42	41.69	74	-17.58	37.31	12.71	35.29	136	244	Peak

Antenna Polarity & Test Distance: Vertical at 3 m										
Frequency (MHz)	Emission Level (dBuV/m)	Read Level (dBuV)	Limit (dBuV/m)	Margin (dB)	Antenna Factor (dB/m)	Cable Loss (dB)	Preamp Factor (dB)	Antenna Height (cm)	Table Angle (Degree)	Remark
5320	89.39	80.81			34.25	8.35	34.02	247	0	Average
5320	98.63	90.05			34.25	8.35	34.02	247	0	Peak
5410.61	45.47	36.75	54	-8.53	34.32	8.44	34.04	247	0	Average
5410.61	55.79	47.07	74	-18.21	34.32	8.44	34.04	247	0	Peak
10640	48.21	33.48	54	-5.79	37.31	12.71	35.29	127	164	Average
10640	57.06	42.33	74	-16.94	37.31	12.71	35.29	127	164	Peak

Remarks:

- Emission Level = Read Level + Antenna Factor + Cable Loss - Preamp Factor  
Margin value = Emission level – Limit value
- 5320 MHz: Fundamental Frequency

EUT Test Condition		Measurement Detail	
Channel	Channel 100	Frequency Range	1 GHz ~ 40 GHz
Input Power	120 Vac, 60 Hz	Detector Function	Peak (PK) Average (AV)
Environmental Conditions	25 deg. C, 65 % RH	Tested By	Getaz Yang

Antenna Polarity & Test Distance: Horizontal at 3 m										
Frequency (MHz)	Emission Level (dBuV/m)	Read Level (dBuV)	Limit (dBuV/m)	Margin (dB)	Antenna Factor (dB/m)	Cable Loss (dB)	Preamp Factor (dB)	Antenna Height (cm)	Table Angle (Degree)	Remark
5454.64	45.22	36.4	54	-8.78	34.36	8.51	34.05	266	341	Average
5454.64	54.5	45.68	74	-19.5	34.36	8.51	34.05	266	341	Peak
*5470.64	53.35	44.52	68.2	-14.85	34.37	8.51	34.05	266	341	Peak
5500	85.8	76.88			34.4	8.57	34.05	266	341	Average
5500	95.72	86.8			34.4	8.57	34.05	266	341	Peak
11000	45.18	30.1	54	-8.82	37.6	12.96	35.48	129	346	Average
11000	53.42	38.34	74	-20.58	37.6	12.96	35.48	129	346	Peak
Antenna Polarity & Test Distance: Vertical at 3 m										
Frequency (MHz)	Emission Level (dBuV/m)	Read Level (dBuV)	Limit (dBuV/m)	Margin (dB)	Antenna Factor (dB/m)	Cable Loss (dB)	Preamp Factor (dB)	Antenna Height (cm)	Table Angle (Degree)	Remark
5395.28	45.52	36.8	54	-8.48	34.32	8.44	34.04	100	9	Average
5395.28	55.08	46.36	74	-18.92	34.32	8.44	34.04	100	9	Peak
*5470.8	53.79	44.93	68.2	-14.41	34.37	8.54	34.05	100	9	Peak
5500	91.01	82.09			34.4	8.57	34.05	100	9	Average
5500	101.11	92.19			34.4	8.57	34.05	100	9	Peak
11000	45.32	30.24	54	-8.68	37.6	12.96	35.48	129	243	Average
11000	54.14	39.06	74	-19.86	37.6	12.96	35.48	129	243	Peak

Remarks:

- Emission Level = Read Level + Antenna Factor + Cable Loss - Preamp Factor  
Margin value = Emission level – Limit value
- 5500 MHz: Fundamental Frequency
- \*: Out of Restricted Band



EUT Test Condition		Measurement Detail	
Channel	Channel 116	Frequency Range	1 GHz ~ 40 GHz
Input Power	120 Vac, 60 Hz	Detector Function	Peak (PK) Average (AV)
Environmental Conditions	25 deg. C, 65 % RH	Tested By	Getaz Yang

Antenna Polarity & Test Distance: Horizontal at 3 m										
Frequency (MHz)	Emission Level (dBuV/m)	Read Level (dBuV)	Limit (dBuV/m)	Margin (dB)	Antenna Factor (dB/m)	Cable Loss (dB)	Preamp Factor (dB)	Antenna Height (cm)	Table Angle (Degree)	Remark
5415.6	45.34	36.61	54	-8.66	34.33	8.44	34.04	219	341	Average
5415.6	54.28	45.55	74	-19.72	34.33	8.44	34.04	219	341	Peak
*5468.72	52.93	44.1	68.2	-15.27	34.37	8.51	34.05	219	341	Peak
5580	88.1	79.11			34.47	8.6	34.08	219	341	Average
5580	98.33	89.34			34.47	8.6	34.08	219	341	Peak
*5726.04	53.1	43.94	68.2	-15.1	34.62	8.65	34.11	219	341	Peak

Antenna Polarity & Test Distance: Vertical at 3 m										
Frequency (MHz)	Emission Level (dBuV/m)	Read Level (dBuV)	Limit (dBuV/m)	Margin (dB)	Antenna Factor (dB/m)	Cable Loss (dB)	Preamp Factor (dB)	Antenna Height (cm)	Table Angle (Degree)	Remark
5353.36	45.17	36.54	54	-8.83	34.28	8.38	34.03	100	206	Average
5353.36	54.68	46.05	74	-19.32	34.28	8.38	34.03	100	206	Peak
*5469.52	53.63	44.8	68.2	-14.57	34.37	8.51	34.05	100	206	Peak
5580	91.79	82.8			34.47	8.6	34.08	100	206	Average
5580	102.09	93.1			34.47	8.6	34.08	100	206	Peak
*5726.04	54.82	45.66	68.2	-13.38	34.62	8.65	34.11	100	206	Peak

Remarks:

- Emission Level = Read Level + Antenna Factor + Cable Loss - Preamp Factor  
Margin value = Emission level – Limit value
- 5580 MHz: Fundamental Frequency
- \*: Out of Restricted Band

EUT Test Condition		Measurement Detail	
Channel	Channel 140	Frequency Range	1 GHz ~ 40 GHz
Input Power	120 Vac, 60 Hz	Detector Function	Peak (PK) Average (AV)
Environmental Conditions	25 deg. C, 65 % RH	Tested By	Getaz Yang

Antenna Polarity & Test Distance: Horizontal at 3 m										
Frequency (MHz)	Emission Level (dBuV/m)	Read Level (dBuV)	Limit (dBuV/m)	Margin (dB)	Antenna Factor (dB/m)	Cable Loss (dB)	Preamp Factor (dB)	Antenna Height (cm)	Table Angle (Degree)	Remark
5700	85.69	76.56			34.59	8.64	34.1	219	341	Average
5700	95.66	86.53			34.59	8.64	34.1	219	341	Peak
*5724.12	55.01	45.85	68.2	-13.19	34.62	8.65	34.11	219	341	Peak
11400	45.64	30.54	54	-8.36	37.84	12.67	35.41	127	154	Average
11400	54.86	39.76	74	-19.14	37.84	12.67	35.41	127	154	Peak

Antenna Polarity & Test Distance: Vertical at 3 m										
Frequency (MHz)	Emission Level (dBuV/m)	Read Level (dBuV)	Limit (dBuV/m)	Margin (dB)	Antenna Factor (dB/m)	Cable Loss (dB)	Preamp Factor (dB)	Antenna Height (cm)	Table Angle (Degree)	Remark
5700	90.23	81.1			34.59	8.64	34.1	104	201	Average
5700	99.7	90.57			34.59	8.64	34.1	104	201	Peak
*5724.6	57.6	48.44	68.2	-10.6	34.62	8.65	34.11	104	201	Peak
11400	45.86	30.76	54	-8.14	37.84	12.67	35.41	148	133	Average
11400	54.97	39.87	74	-19.03	37.84	12.67	35.41	148	133	Peak

Remarks:

- Emission Level = Read Level + Antenna Factor + Cable Loss - Preamp Factor  
Margin value = Emission level – Limit value
- 5700 MHz: Fundamental Frequency
- \*: Out of Restricted Band

EUT Test Condition		Measurement Detail	
Channel	Channel 149	Frequency Range	1 GHz ~ 40 GHz
Input Power	120 Vac, 60 Hz	Detector Function	Peak (PK) Average (AV)
Environmental Conditions	25 deg. C, 65 % RH	Tested By	Getaz Yang

<Spurious Emission>

Antenna Polarity & Test Distance: Horizontal at 3 m										
Frequency (MHz)	Emission Level (dBuV/m)	Read Level (dBuV)	Limit (dBuV/m)	Margin (dB)	Antenna Factor (dB/m)	Cable Loss (dB)	Preamp Factor (dB)	Antenna Height (cm)	Table Angle (Degree)	Remark
5745	86.98	77.79			34.64	8.66	34.11	200	34	Average
5745	96.35	87.16			34.64	8.66	34.11	200	34	Peak
11490	47.17	32.05	54	-6.83	37.89	12.62	35.39	134	331	Average
11490	53.38	38.26	74	-20.62	37.89	12.62	35.39	134	331	Peak
Antenna Polarity & Test Distance: Vertical at 3 m										
Frequency (MHz)	Emission Level (dBuV/m)	Read Level (dBuV)	Limit (dBuV/m)	Margin (dB)	Antenna Factor (dB/m)	Cable Loss (dB)	Preamp Factor (dB)	Antenna Height (cm)	Table Angle (Degree)	Remark
5745	90.55	81.36			34.64	8.66	34.11	101	30	Average
5745	100.22	91.03			34.64	8.66	34.11	101	30	Peak
11490	46.97	31.85	54	-7.03	37.89	12.62	35.39	187	77	Average
11490	54.04	38.92	74	-19.96	37.89	12.62	35.39	187	77	Peak

<Out of Band Emission (OOBE)>

Antenna Polarity & Test Distance: Horizontal at 3 m										
Frequency (MHz)	Emission Level (dBuV/m)	Read Level (dBuV)	Limit (dBuV/m)	Margin (dB)	Antenna Factor (dB/m)	Cable Loss (dB)	Preamp Factor (dB)	Antenna Height (cm)	Table Angle (Degree)	Remark
*5590.3	57.21	48.2	68.2	-10.99	34.49	8.6	34.08	200	34	Peak
5652.25	53.76	44.67	69.86	-16.1	34.56	8.62	34.09	200	34	Peak
5923.15	52.83	43.43	69.57	-16.74	34.83	8.73	34.16	200	34	Peak
*5946.775	55.77	46.34	68.2	-12.43	34.85	8.74	34.16	200	34	Peak
Antenna Polarity & Test Distance: Vertical at 3 m										
Frequency (MHz)	Emission Level (dBuV/m)	Read Level (dBuV)	Limit (dBuV/m)	Margin (dB)	Antenna Factor (dB/m)	Cable Loss (dB)	Preamp Factor (dB)	Antenna Height (cm)	Table Angle (Degree)	Remark
*5514.7	58.18	49.25	68.2	-10.02	34.42	8.57	34.06	101	30	Peak
5652.25	54.63	45.54	69.86	-15.23	34.56	8.62	34.09	101	30	Peak
5923.675	54.69	45.29	69.18	-14.49	34.83	8.73	34.16	101	30	Peak
*5983	57.43	47.97	68.2	-10.77	34.88	8.75	34.17	101	30	Peak

Remarks:

- Emission Level = Read Level + Antenna Factor + Cable Loss - Preamp Factor  
Margin value = Emission level – Limit value
- 5745 MHz: Fundamental Frequency
- \*: Out of Restricted Band

EUT Test Condition		Measurement Detail	
Channel	Channel 157	Frequency Range	1 GHz ~ 40 GHz
Input Power	120 Vac, 60 Hz	Detector Function	Peak (PK) Average (AV)
Environmental Conditions	25 deg. C, 65 % RH	Tested By	Getaz Yang

<Spurious Emission>

Antenna Polarity & Test Distance: Horizontal at 3 m										
Frequency (MHz)	Emission Level (dBuV/m)	Read Level (dBuV)	Limit (dBuV/m)	Margin (dB)	Antenna Factor (dB/m)	Cable Loss (dB)	Preamp Factor (dB)	Antenna Height (cm)	Table Angle (Degree)	Remark
5785	89.84	80.61			34.68	8.68	34.13	200	34	Average
5785	99.71	90.48			34.68	8.68	34.13	200	34	Peak
11570	47.41	32.1	54	-6.59	38	12.68	35.37	147	25	Average
11570	55.05	39.74	74	-18.95	38	12.68	35.37	147	25	Peak
Antenna Polarity & Test Distance: Vertical at 3 m										
Frequency (MHz)	Emission Level (dBuV/m)	Read Level (dBuV)	Limit (dBuV/m)	Margin (dB)	Antenna Factor (dB/m)	Cable Loss (dB)	Preamp Factor (dB)	Antenna Height (cm)	Table Angle (Degree)	Remark
5785	91.66	82.43			34.68	8.68	34.13	101	30	Average
5785	101.72	92.49			34.68	8.68	34.13	101	30	Peak
11570	47.44	32.13	54	-6.56	38	12.68	35.37	175	350	Average
11570	53.81	38.5	74	-20.19	38	12.68	35.37	175	350	Peak

<Out of Band Emission (OOBE)>

Antenna Polarity & Test Distance: Horizontal at 3 m										
Frequency (MHz)	Emission Level (dBuV/m)	Read Level (dBuV)	Limit (dBuV/m)	Margin (dB)	Antenna Factor (dB/m)	Cable Loss (dB)	Preamp Factor (dB)	Antenna Height (cm)	Table Angle (Degree)	Remark
*5591.35	57.31	48.3	68.2	-10.89	34.49	8.6	34.08	200	34	Peak
5652.25	55.02	45.93	69.86	-14.84	34.56	8.62	34.09	200	34	Peak
5923.15	54.22	44.82	69.57	-15.35	34.83	8.73	34.16	200	34	Peak
*5977.75	56.42	46.96	68.2	-11.78	34.88	8.75	34.17	200	34	Peak
Antenna Polarity & Test Distance: Vertical at 3 m										
Frequency (MHz)	Emission Level (dBuV/m)	Read Level (dBuV)	Limit (dBuV/m)	Margin (dB)	Antenna Factor (dB/m)	Cable Loss (dB)	Preamp Factor (dB)	Antenna Height (cm)	Table Angle (Degree)	Remark
*5548.825	56.66	47.69	68.2	-11.54	34.45	8.59	34.07	101	30	Peak
5652.25	52.57	43.48	69.86	-17.29	34.56	8.62	34.09	101	30	Peak
5923.15	54.11	44.71	69.57	-15.46	34.83	8.73	34.16	101	30	Peak
*6001.375	56.2	46.71	68.2	-12	34.9	8.76	34.17	101	30	Peak

Remarks:

- Emission Level = Read Level + Antenna Factor + Cable Loss - Preamp Factor  
Margin value = Emission level – Limit value
- 5785 MHz: Fundamental Frequency
- \*: Out of Restricted Band

EUT Test Condition		Measurement Detail	
Channel	Channel 165	Frequency Range	1 GHz ~ 40 GHz
Input Power	120 Vac, 60 Hz	Detector Function	Peak (PK) Average (AV)
Environmental Conditions	25 deg. C, 65 % RH	Tested By	Getaz Yang

<Spurious Emission>

Antenna Polarity & Test Distance: Horizontal at 3 m										
Frequency (MHz)	Emission Level (dBuV/m)	Read Level (dBuV)	Limit (dBuV/m)	Margin (dB)	Antenna Factor (dB/m)	Cable Loss (dB)	Preamp Factor (dB)	Antenna Height (cm)	Table Angle (Degree)	Remark
5825	89.37	80.08			34.73	8.69	34.13	200	34	Average
5825	99.35	90.06			34.73	8.69	34.13	200	34	Peak
11650	47.33	31.8	54	-6.67	38.09	12.8	35.36	105	181	Average
11650	54.11	38.58	74	-19.89	38.09	12.8	35.36	105	181	Peak
Antenna Polarity & Test Distance: Vertical at 3 m										
Frequency (MHz)	Emission Level (dBuV/m)	Read Level (dBuV)	Limit (dBuV/m)	Margin (dB)	Antenna Factor (dB/m)	Cable Loss (dB)	Preamp Factor (dB)	Antenna Height (cm)	Table Angle (Degree)	Remark
5825	91.54	82.25			34.73	8.69	34.13	101	30	Average
5825	101.39	92.1			34.73	8.69	34.13	101	30	Peak
11650	47.15	31.62	54	-6.85	38.09	12.8	35.36	196	55	Average
11650	53.37	37.84	74	-20.63	38.09	12.8	35.36	196	55	Peak

<Out of Band Emission (OOBE)>

Antenna Polarity & Test Distance: Horizontal at 3 m										
Frequency (MHz)	Emission Level (dBuV/m)	Read Level (dBuV)	Limit (dBuV/m)	Margin (dB)	Antenna Factor (dB/m)	Cable Loss (dB)	Preamp Factor (dB)	Antenna Height (cm)	Table Angle (Degree)	Remark
*5544.625	57.56	48.62	68.2	-10.64	34.43	8.58	34.07	200	34	Peak
5651.725	55.13	46.04	69.48	-14.35	34.56	8.62	34.09	200	34	Peak
5923.675	53.87	44.47	69.18	-15.31	34.83	8.73	34.16	200	34	Peak
*5943.1	56.38	46.95	68.2	-11.82	34.85	8.74	34.16	200	34	Peak
Antenna Polarity & Test Distance: Vertical at 3 m										
Frequency (MHz)	Emission Level (dBuV/m)	Read Level (dBuV)	Limit (dBuV/m)	Margin (dB)	Antenna Factor (dB/m)	Cable Loss (dB)	Preamp Factor (dB)	Antenna Height (cm)	Table Angle (Degree)	Remark
*5572.975	57.4	48.41	68.2	-10.8	34.47	8.59	34.07	101	30	Peak
5652.25	54.29	45.2	69.86	-15.57	34.56	8.62	34.09	101	30	Peak
5922.625	54.42	45.02	69.96	-15.54	34.83	8.73	34.16	101	30	Peak
*5946.25	56.81	47.38	68.2	-11.39	34.85	8.74	34.16	101	30	Peak

Remarks:

- Emission Level = Read Level + Antenna Factor + Cable Loss - Preamp Factor  
Margin value = Emission level – Limit value
- 5825 MHz: Fundamental Frequency
- \*: Out of Restricted Band

**802.11n (HT40)**

EUT Test Condition		Measurement Detail	
Channel	Channel 38	Frequency Range	1 GHz ~ 40 GHz
Input Power	120 Vac, 60 Hz	Detector Function	Peak (PK) Average (AV)
Environmental Conditions	25 deg. C, 65 % RH	Tested By	Getaz Yang

**Antenna Polarity & Test Distance: Horizontal at 3 m**

Frequency (MHz)	Emission Level (dBuV/m)	Read Level (dBuV)	Limit (dBuV/m)	Margin (dB)	Antenna Factor (dB/m)	Cable Loss (dB)	Preamp Factor (dB)	Antenna Height (cm)	Table Angle (Degree)	Remark
5148.95	52.23	43.98	54	-1.77	34.12	8.13	34	178	334	Average
5148.95	69.28	61.03	74	-4.72	34.12	8.13	34	178	334	Peak
5190	90.24	81.9			34.15	8.19	34	178	334	Average
5190	98.9	90.56			34.15	8.19	34	178	334	Peak
5351.65	45.47	36.84	54	-8.53	34.28	8.38	34.03	178	334	Average
5351.65	56.17	47.54	74	-17.83	34.28	8.38	34.03	178	334	Peak

**Antenna Polarity & Test Distance: Vertical at 3 m**

Frequency (MHz)	Emission Level (dBuV/m)	Read Level (dBuV)	Limit (dBuV/m)	Margin (dB)	Antenna Factor (dB/m)	Cable Loss (dB)	Preamp Factor (dB)	Antenna Height (cm)	Table Angle (Degree)	Remark
5145.2	51.35	43.1	54	-2.65	34.12	8.13	34	257	10	Average
5145.2	64.3	56.05	74	-9.7	34.12	8.13	34	257	10	Peak
5190	88.81	80.47			34.15	8.19	34	257	10	Average
5190	97.79	89.45			34.15	8.19	34	257	10	Peak
5350	45.43	36.8	54	-8.57	34.28	8.38	34.03	257	10	Average
5350	55.84	47.21	74	-18.16	34.28	8.38	34.03	257	10	Peak

## Remarks:

- Emission Level = Read Level + Antenna Factor + Cable Loss - Preamp Factor  
Margin value = Emission level – Limit value
- 5190 MHz: Fundamental Frequency

EUT Test Condition		Measurement Detail	
Channel	Channel 46	Frequency Range	1 GHz ~ 40 GHz
Input Power	120 Vac, 60 Hz	Detector Function	Peak (PK) Average (AV)
Environmental Conditions	25 deg. C, 65 % RH	Tested By	Getaz Yang

Antenna Polarity & Test Distance: Horizontal at 3 m										
Frequency (MHz)	Emission Level (dBuV/m)	Read Level (dBuV)	Limit (dBuV/m)	Margin (dB)	Antenna Factor (dB/m)	Cable Loss (dB)	Preamp Factor (dB)	Antenna Height (cm)	Table Angle (Degree)	Remark
5148.95	44.92	36.67	54	-9.08	34.12	8.13	34	178	334	Average
5148.95	55.84	47.59	74	-18.16	34.12	8.13	34	178	334	Peak
5230	90.67	82.27			34.19	8.22	34.01	178	334	Average
5230	99.7	91.3			34.19	8.22	34.01	178	334	Peak
5353.85	45.37	36.74	54	-8.63	34.28	8.38	34.03	178	334	Average
5353.85	55.37	46.74	74	-18.63	34.28	8.38	34.03	178	334	Peak

Antenna Polarity & Test Distance: Vertical at 3 m										
Frequency (MHz)	Emission Level (dBuV/m)	Read Level (dBuV)	Limit (dBuV/m)	Margin (dB)	Antenna Factor (dB/m)	Cable Loss (dB)	Preamp Factor (dB)	Antenna Height (cm)	Table Angle (Degree)	Remark
5087.3	45.91	37.75	54	-8.09	34.07	8.07	33.98	257	10	Average
5087.3	57.64	49.48	74	-16.36	34.07	8.07	33.98	257	10	Peak
5230	89.38	80.98			34.19	8.22	34.01	257	10	Average
5230	98.3	89.9			34.19	8.22	34.01	257	10	Peak
5443.72	44.34	35.55	54	-9.66	34.35	8.48	34.04	257	10	Average
5443.72	54.03	45.24	74	-19.97	34.35	8.48	34.04	257	10	Peak

Remarks:

- Emission Level = Read Level + Antenna Factor + Cable Loss - Preamp Factor  
Margin value = Emission level – Limit value
- 5230 MHz: Fundamental Frequency

EUT Test Condition		Measurement Detail	
Channel	Channel 54	Frequency Range	1 GHz ~ 40 GHz
Input Power	120 Vac, 60 Hz	Detector Function	Peak (PK) Average (AV)
Environmental Conditions	25 deg. C, 65 % RH	Tested By	Getaz Yang

Antenna Polarity & Test Distance: Horizontal at 3 m										
Frequency (MHz)	Emission Level (dBuV/m)	Read Level (dBuV)	Limit (dBuV/m)	Margin (dB)	Antenna Factor (dB/m)	Cable Loss (dB)	Preamp Factor (dB)	Antenna Height (cm)	Table Angle (Degree)	Remark
5137.1	44.82	36.57	54	-9.18	34.11	8.13	33.99	118	329	Average
5137.1	56.75	48.5	74	-17.25	34.11	8.13	33.99	118	329	Peak
5270	91.46	82.97			34.21	8.29	34.01	118	329	Average
5270	99.99	91.5			34.21	8.29	34.01	118	329	Peak
5353.96	45.41	36.78	54	-8.59	34.28	8.38	34.03	118	329	Average
5353.96	55.57	46.94	74	-18.43	34.28	8.38	34.03	118	329	Peak

Antenna Polarity & Test Distance: Vertical at 3 m										
Frequency (MHz)	Emission Level (dBuV/m)	Read Level (dBuV)	Limit (dBuV/m)	Margin (dB)	Antenna Factor (dB/m)	Cable Loss (dB)	Preamp Factor (dB)	Antenna Height (cm)	Table Angle (Degree)	Remark
5143.1	44.71	36.45	54	-9.29	34.12	8.13	33.99	247	0	Average
5143.1	56.62	48.36	74	-17.38	34.12	8.13	33.99	247	0	Peak
5270	87.82	79.33			34.21	8.29	34.01	247	0	Average
5270	96.83	88.34			34.21	8.29	34.01	247	0	Peak
5354.51	45.41	36.78	54	-8.59	34.28	8.38	34.03	247	0	Average
5354.51	57.31	48.68	74	-16.69	34.28	8.38	34.03	247	0	Peak

Remarks:

- Emission Level = Read Level + Antenna Factor + Cable Loss - Preamp Factor  
Margin value = Emission level – Limit value
- 5270 MHz: Fundamental Frequency



EUT Test Condition		Measurement Detail	
Channel	Channel 62	Frequency Range	1 GHz ~ 40 GHz
Input Power	120 Vac, 60 Hz	Detector Function	Peak (PK) Average (AV)
Environmental Conditions	25 deg. C, 65 % RH	Tested By	Getaz Yang

Antenna Polarity & Test Distance: Horizontal at 3 m										
Frequency (MHz)	Emission Level (dBuV/m)	Read Level (dBuV)	Limit (dBuV/m)	Margin (dB)	Antenna Factor (dB/m)	Cable Loss (dB)	Preamp Factor (dB)	Antenna Height (cm)	Table Angle (Degree)	Remark
5136.8	45.22	36.97	54	-8.78	34.11	8.13	33.99	118	329	Average
5136.8	55.21	46.96	74	-18.79	34.11	8.13	33.99	118	329	Peak
5310	90.64	82.09			34.25	8.32	34.02	118	329	Average
5310	99.51	90.96			34.25	8.32	34.02	118	329	Peak
5353.52	52.82	44.19	54	-1.18	34.28	8.38	34.03	118	329	Average
5353.52	69.61	60.98	74	-4.39	34.28	8.38	34.03	118	329	Peak

Antenna Polarity & Test Distance: Vertical at 3 m										
Frequency (MHz)	Emission Level (dBuV/m)	Read Level (dBuV)	Limit (dBuV/m)	Margin (dB)	Antenna Factor (dB/m)	Cable Loss (dB)	Preamp Factor (dB)	Antenna Height (cm)	Table Angle (Degree)	Remark
5117.6	45.26	37.06	54	-8.74	34.09	8.1	33.99	247	0	Average
5117.6	56.48	48.28	74	-17.52	34.09	8.1	33.99	247	0	Peak
5310	87.15	78.6			34.25	8.32	34.02	247	0	Average
5310	96.43	87.88			34.25	8.32	34.02	247	0	Peak
5350.11	52.96	44.33	54	-1.04	34.28	8.38	34.03	247	0	Average
5350.11	68.45	59.82	74	-5.55	34.28	8.38	34.03	247	0	Peak

Remarks:

- Emission Level = Read Level + Antenna Factor + Cable Loss - Preamp Factor  
Margin value = Emission level – Limit value
- 5310 MHz: Fundamental Frequency

EUT Test Condition		Measurement Detail	
Channel	Channel 102	Frequency Range	1 GHz ~ 40 GHz
Input Power	120 Vac, 60 Hz	Detector Function	Peak (PK) Average (AV)
Environmental Conditions	25 deg. C, 65 % RH	Tested By	Getaz Yang

Antenna Polarity & Test Distance: Horizontal at 3 m										
Frequency (MHz)	Emission Level (dBuV/m)	Read Level (dBuV)	Limit (dBuV/m)	Margin (dB)	Antenna Factor (dB/m)	Cable Loss (dB)	Preamp Factor (dB)	Antenna Height (cm)	Table Angle (Degree)	Remark
5459.92	46.53	37.71	54	-7.47	34.36	8.51	34.05	266	341	Average
5459.92	55.5	46.68	74	-18.5	34.36	8.51	34.05	266	341	Peak
*5470.8	63.3	54.44	68.2	-4.9	34.37	8.54	34.05	266	341	Peak
5510	85.13	76.22			34.4	8.57	34.06	266	341	Average
5510	95.64	86.73			34.4	8.57	34.06	266	341	Peak
*5724.28	53.75	44.59	68.2	-14.45	34.62	8.65	34.11	266	341	Peak

Antenna Polarity & Test Distance: Vertical at 3 m										
Frequency (MHz)	Emission Level (dBuV/m)	Read Level (dBuV)	Limit (dBuV/m)	Margin (dB)	Antenna Factor (dB/m)	Cable Loss (dB)	Preamp Factor (dB)	Antenna Height (cm)	Table Angle (Degree)	Remark
5459.44	48.8	39.98	54	-5.2	34.36	8.51	34.05	100	9	Average
5459.44	58.78	49.96	74	-15.22	34.36	8.51	34.05	100	9	Peak
*5470.8	66.92	58.06	68.2	-1.28	34.37	8.54	34.05	100	9	Peak
5510	90.27	81.36			34.4	8.57	34.06	100	9	Average
5510	100.08	91.17			34.4	8.57	34.06	100	9	Peak
*5724.68	52.99	43.83	68.2	-15.21	34.62	8.65	34.11	100	9	Peak

Remarks:

- Emission Level = Read Level + Antenna Factor + Cable Loss - Preamp Factor  
Margin value = Emission level – Limit value
- 5510 MHz: Fundamental Frequency
- \*: Out of Restricted Band

EUT Test Condition		Measurement Detail	
Channel	Channel 110	Frequency Range	1 GHz ~ 40 GHz
Input Power	120 Vac, 60 Hz	Detector Function	Peak (PK) Average (AV)
Environmental Conditions	25 deg. C, 65 % RH	Tested By	Getaz Yang

Antenna Polarity & Test Distance: Horizontal at 3 m										
Frequency (MHz)	Emission Level (dBuV/m)	Read Level (dBuV)	Limit (dBuV/m)	Margin (dB)	Antenna Factor (dB/m)	Cable Loss (dB)	Preamp Factor (dB)	Antenna Height (cm)	Table Angle (Degree)	Remark
5436.56	45.95	37.16	54	-8.05	34.35	8.48	34.04	219	341	Average
5436.56	54.51	45.72	74	-19.49	34.35	8.48	34.04	219	341	Peak
*5469.04	52.41	43.58	68.2	-15.79	34.37	8.51	34.05	219	341	Peak
5550	85.4	76.43			34.45	8.59	34.07	219	341	Average
5550	95.64	86.67			34.45	8.59	34.07	219	341	Peak
*5726.04	53.15	43.99	68.2	-15.05	34.62	8.65	34.11	219	341	Peak

Antenna Polarity & Test Distance: Vertical at 3 m										
Frequency (MHz)	Emission Level (dBuV/m)	Read Level (dBuV)	Limit (dBuV/m)	Margin (dB)	Antenna Factor (dB/m)	Cable Loss (dB)	Preamp Factor (dB)	Antenna Height (cm)	Table Angle (Degree)	Remark
5426	45.71	36.94	54	-8.29	34.33	8.48	34.04	115	206	Average
5426	55.14	46.37	74	-18.86	34.33	8.48	34.04	115	206	Peak
*5468.4	52.95	44.12	68.2	-15.25	34.37	8.51	34.05	115	206	Peak
5550	89.53	80.56			34.45	8.59	34.07	115	206	Average
5550	99.26	90.29			34.45	8.59	34.07	115	206	Peak
*5725.4	54.09	44.93	68.2	-14.11	34.62	8.65	34.11	115	206	Peak

Remarks:

- Emission Level = Read Level + Antenna Factor + Cable Loss - Preamp Factor  
Margin value = Emission level – Limit value
- 5550 MHz: Fundamental Frequency
- \*: Out of Restricted Band

EUT Test Condition		Measurement Detail	
Channel	Channel 134	Frequency Range	1 GHz ~ 40 GHz
Input Power	120 Vac, 60 Hz	Detector Function	Peak (PK) Average (AV)
Environmental Conditions	25 deg. C, 65 % RH	Tested By	Getaz Yang

Antenna Polarity & Test Distance: Horizontal at 3 m										
Frequency (MHz)	Emission Level (dBuV/m)	Read Level (dBuV)	Limit (dBuV/m)	Margin (dB)	Antenna Factor (dB/m)	Cable Loss (dB)	Preamp Factor (dB)	Antenna Height (cm)	Table Angle (Degree)	Remark
5434.48	45.76	36.97	54	-8.24	34.35	8.48	34.04	220	341	Average
5434.48	54.41	45.62	74	-19.59	34.35	8.48	34.04	220	341	Peak
*5468.4	52.42	43.59	68.2	-15.78	34.37	8.51	34.05	220	341	Peak
5670	85.44	76.34			34.57	8.63	34.1	220	341	Average
5670	95.12	86.02			34.57	8.63	34.1	220	341	Peak
*5724.36	53.66	44.5	68.2	-14.54	34.62	8.65	34.11	220	341	Peak

Antenna Polarity & Test Distance: Vertical at 3 m										
Frequency (MHz)	Emission Level (dBuV/m)	Read Level (dBuV)	Limit (dBuV/m)	Margin (dB)	Antenna Factor (dB/m)	Cable Loss (dB)	Preamp Factor (dB)	Antenna Height (cm)	Table Angle (Degree)	Remark
5351.44	45.83	37.2	54	-8.17	34.28	8.38	34.03	104	201	Average
5351.44	54.92	46.29	74	-19.08	34.28	8.38	34.03	104	201	Peak
*5469.52	54.29	45.46	68.2	-13.91	34.37	8.51	34.05	104	201	Peak
5670	88.62	79.52			34.57	8.63	34.1	104	201	Average
5670	99.17	90.07			34.57	8.63	34.1	104	201	Peak
*5725.08	55.57	46.41	68.2	-12.63	34.62	8.65	34.11	104	201	Peak

Remarks:

- Emission Level = Read Level + Antenna Factor + Cable Loss - Preamp Factor  
Margin value = Emission level – Limit value
- 5670 MHz: Fundamental Frequency
- \*: Out of Restricted Band

EUT Test Condition		Measurement Detail	
Channel	Channel 151	Frequency Range	1 GHz ~ 40 GHz
Input Power	120 Vac, 60 Hz	Detector Function	Peak (PK) Average (AV)
Environmental Conditions	25 deg. C, 65 % RH	Tested By	Getaz Yang

<Spurious Emission>

Antenna Polarity & Test Distance: Horizontal at 3 m										
Frequency (MHz)	Emission Level (dBuV/m)	Read Level (dBuV)	Limit (dBuV/m)	Margin (dB)	Antenna Factor (dB/m)	Cable Loss (dB)	Preamp Factor (dB)	Antenna Height (cm)	Table Angle (Degree)	Remark
5755	85.97	76.76			34.66	8.66	34.11	200	34	Average
5755	96.16	86.95			34.66	8.66	34.11	200	34	Peak
11510	47.16	32.05	54	-6.84	37.9	12.6	35.39	178	88	Average
11510	52.8	37.69	74	-21.2	37.9	12.6	35.39	178	88	Peak
Antenna Polarity & Test Distance: Vertical at 3 m										
Frequency (MHz)	Emission Level (dBuV/m)	Read Level (dBuV)	Limit (dBuV/m)	Margin (dB)	Antenna Factor (dB/m)	Cable Loss (dB)	Preamp Factor (dB)	Antenna Height (cm)	Table Angle (Degree)	Remark
5755	89.34	80.13			34.66	8.66	34.11	114	25	Average
5755	98.55	89.34			34.66	8.66	34.11	114	25	Peak
11510	47.11	32	54	-6.89	37.9	12.6	35.39	137	159	Average
11510	53.44	38.33	74	-20.56	37.9	12.6	35.39	137	159	Peak

<Out of Band Emission (OOBE)>

Antenna Polarity & Test Distance: Horizontal at 3 m										
Frequency (MHz)	Emission Level (dBuV/m)	Read Level (dBuV)	Limit (dBuV/m)	Margin (dB)	Antenna Factor (dB/m)	Cable Loss (dB)	Preamp Factor (dB)	Antenna Height (cm)	Table Angle (Degree)	Remark
*5575.075	57.39	48.39	68.2	-10.81	34.47	8.6	34.07	200	34	Peak
5652.25	53.75	44.66	69.86	-16.11	34.56	8.62	34.09	200	34	Peak
5922.1	54.76	45.36	70.35	-15.59	34.83	8.73	34.16	200	34	Peak
*5990.875	56.7	47.21	68.2	-11.5	34.9	8.76	34.17	200	34	Peak
Antenna Polarity & Test Distance: Vertical at 3 m										
Frequency (MHz)	Emission Level (dBuV/m)	Read Level (dBuV)	Limit (dBuV/m)	Margin (dB)	Antenna Factor (dB/m)	Cable Loss (dB)	Preamp Factor (dB)	Antenna Height (cm)	Table Angle (Degree)	Remark
*5575.075	57.77	48.77	68.2	-10.43	34.47	8.6	34.07	114	25	Peak
5652.25	55.39	46.3	69.86	-14.47	34.56	8.62	34.09	114	25	Peak
5923.15	54.59	45.19	69.57	-14.98	34.83	8.73	34.16	114	25	Peak
*6000.325	56.58	47.09	68.2	-11.62	34.9	8.76	34.17	114	25	Peak

Remarks:

- Emission Level = Read Level + Antenna Factor + Cable Loss - Preamp Factor  
Margin value = Emission level – Limit value
- 5755 MHz: Fundamental Frequency
- \*: Out of Restricted Band

EUT Test Condition		Measurement Detail	
Channel	Channel 159	Frequency Range	1 GHz ~ 40 GHz
Input Power	120 Vac, 60 Hz	Detector Function	Peak (PK) Average (AV)
Environmental Conditions	25 deg. C, 65 % RH	Tested By	Getaz Yang

<Spurious Emission>

Antenna Polarity & Test Distance: Horizontal at 3 m										
Frequency (MHz)	Emission Level (dBuV/m)	Read Level (dBuV)	Limit (dBuV/m)	Margin (dB)	Antenna Factor (dB/m)	Cable Loss (dB)	Preamp Factor (dB)	Antenna Height (cm)	Table Angle (Degree)	Remark
5795	87.5	78.26			34.69	8.68	34.13	200	34	Average
5795	96.84	87.6			34.69	8.68	34.13	200	34	Peak
11590	47.26	31.89	54	-6.74	38.02	12.72	35.37	178	328	Average
11590	53.87	38.5	74	-20.13	38.02	12.72	35.37	178	328	Peak
Antenna Polarity & Test Distance: Vertical at 3 m										
Frequency (MHz)	Emission Level (dBuV/m)	Read Level (dBuV)	Limit (dBuV/m)	Margin (dB)	Antenna Factor (dB/m)	Cable Loss (dB)	Preamp Factor (dB)	Antenna Height (cm)	Table Angle (Degree)	Remark
5795	87.08	77.84			34.69	8.68	34.13	101	30	Average
5795	98.07	88.83			34.69	8.68	34.13	101	30	Peak
11590	47.29	31.92	54	-6.71	38.02	12.72	35.37	115	247	Average
11590	54.27	38.9	74	-19.73	38.02	12.72	35.37	115	247	Peak

<Out of Band Emission (OOBE)>

Antenna Polarity & Test Distance: Horizontal at 3 m										
Frequency (MHz)	Emission Level (dBuV/m)	Read Level (dBuV)	Limit (dBuV/m)	Margin (dB)	Antenna Factor (dB/m)	Cable Loss (dB)	Preamp Factor (dB)	Antenna Height (cm)	Table Angle (Degree)	Remark
*5565.625	57.31	48.32	68.2	-10.89	34.47	8.59	34.07	200	34	Peak
5651.725	53.54	44.45	69.48	-15.94	34.56	8.62	34.09	200	34	Peak
5922.625	54.73	45.33	69.96	-15.23	34.83	8.73	34.16	200	34	Peak
*6019.225	56.48	46.97	68.2	-11.72	34.92	8.77	34.18	200	34	Peak
Antenna Polarity & Test Distance: Vertical at 3 m										
Frequency (MHz)	Emission Level (dBuV/m)	Read Level (dBuV)	Limit (dBuV/m)	Margin (dB)	Antenna Factor (dB/m)	Cable Loss (dB)	Preamp Factor (dB)	Antenna Height (cm)	Table Angle (Degree)	Remark
*5542.525	56.94	48	68.2	-11.26	34.43	8.58	34.07	101	30	Peak
5652.25	52.3	43.21	69.86	-17.56	34.56	8.62	34.09	101	30	Peak
5922.1	54.23	44.83	70.35	-16.12	34.83	8.73	34.16	101	30	Peak
*6023.425	56.83	47.32	68.2	-11.37	34.92	8.77	34.18	101	30	Peak

Remarks:

- Emission Level = Read Level + Antenna Factor + Cable Loss - Preamp Factor  
Margin value = Emission level – Limit value
- 5795 MHz: Fundamental Frequency
- \*: Out of Restricted Band

**9 kHz ~ 30 MHz DATA:**

The amplitude of spurious emissions attenuated more than 20 dB below the permissible value is not required to be report.

**30 MHz ~ 1 GHz WORST-CASE DATA:**

**802.11n (HT40)**

EUT Test Condition		Measurement Detail	
Channel	Channel 38	Frequency Range	30 MHz ~ 1 GHz
Input Power	120 Vac, 60 Hz	Detector Function	Peak (PK) Quasi-peak (QP)
Environmental Conditions	25 deg. C, 65 % RH	Tested By	Getaz Yang

Antenna Polarity & Test Distance: Horizontal at 3 m										
Frequency (MHz)	Emission Level (dBuV/m)	Read Level (dBuV)	Limit (dBuV/m)	Margin (dB)	Antenna Factor (dB/m)	Cable Loss (dB)	Preamp Factor (dB)	Antenna Height (cm)	Table Angle (Degree)	Remark
34.05	19.96	39.63	40	-20.04	11.83	0.74	32.24	163	154	Peak
90.75	32.9	52.87	43.5	-10.6	10.69	1.11	31.77	115	148	Peak
185.52	23.28	43.71	43.5	-20.22	10.2	1.61	32.24	125	147	Peak
397.3	18.72	33.65	46	-27.28	14.95	2.34	32.22	102	132	Peak
622.7	22.31	33.4	46	-23.69	18.15	2.93	32.17	166	154	Peak
709.5	22.61	32.22	46	-23.39	19.38	3.11	32.1	198	175	Peak
Antenna Polarity & Test Distance: Vertical at 3 m										
Frequency (MHz)	Emission Level (dBuV/m)	Read Level (dBuV)	Limit (dBuV/m)	Margin (dB)	Antenna Factor (dB/m)	Cable Loss (dB)	Preamp Factor (dB)	Antenna Height (cm)	Table Angle (Degree)	Remark
49.71	26.36	43.13	40	-13.64	14.55	0.9	32.22	132	165	Peak
97.77	28.45	47.3	43.5	-15.05	12.02	1.28	32.15	156	147	Peak
156.63	12.23	34.34	43.5	-31.27	8.64	1.52	32.27	125	20	Peak
401.5	18	32.87	46	-28	15.01	2.34	32.22	122	52	Peak
653.5	20.79	31.43	46	-25.21	18.51	2.99	32.14	169	184	Peak
794.2	23.67	32.2	46	-22.33	20.27	3.27	32.07	175	184	Peak

Remarks:

1. Emission Level = Read Level + Antenna Factor + Cable Loss - Preamp Factor

Margin value = Emission level – Limit value

**802.11n (HT40)**

EUT Test Condition		Measurement Detail	
Channel	Channel 62	Frequency Range	30 MHz ~ 1 GHz
Input Power	120 Vac, 60 Hz	Detector Function	Peak (PK) Quasi-peak (QP)
Environmental Conditions	25 deg. C, 65 % RH	Tested By	Getaz Yang

**Antenna Polarity & Test Distance: Horizontal at 3 m**

Frequency (MHz)	Emission Level (dBuV/m)	Read Level (dBuV)	Limit (dBuV/m)	Margin (dB)	Antenna Factor (dB/m)	Cable Loss (dB)	Preamp Factor (dB)	Antenna Height (cm)	Table Angle (Degree)	Remark
88.86	34.56	55	43.5	-8.94	10.21	1.11	31.76	136	214	Peak
178.77	23.23	44.24	43.5	-20.27	9.62	1.61	32.24	115	147	Peak
226.83	18.25	36.96	46	-27.75	11.63	1.85	32.19	105	168	Peak
398	18.93	33.86	46	-27.07	14.95	2.34	32.22	168	147	Peak
634.6	20.8	31.79	46	-25.2	18.24	2.93	32.16	115	195	Peak
747.3	27.11	36.25	46	-18.89	19.78	3.22	32.14	104	157	Peak

**Antenna Polarity & Test Distance: Vertical at 3 m**

Frequency (MHz)	Emission Level (dBuV/m)	Read Level (dBuV)	Limit (dBuV/m)	Margin (dB)	Antenna Factor (dB/m)	Cable Loss (dB)	Preamp Factor (dB)	Antenna Height (cm)	Table Angle (Degree)	Remark
32.43	33.11	52.88	40	-6.89	11.74	0.74	32.25	136	214	Peak
97.5	28.33	47.18	43.5	-15.17	12.02	1.28	32.15	195	174	Peak
163.92	16.81	38.66	43.5	-26.69	8.89	1.52	32.26	188	174	Peak
337.1	18.08	33.97	46	-27.92	14	2.19	32.08	104	154	Peak
484.1	17.83	31.25	46	-28.17	16.13	2.56	32.11	133	20	Peak
729.8	27.83	37.18	46	-18.17	19.61	3.16	32.12	169	158	Peak

## Remarks:

- Emission Level = Read Level + Antenna Factor + Cable Loss - Preamp Factor  
Margin value = Emission level – Limit value



### 802.11n (HT40)

EUT Test Condition		Measurement Detail	
Channel	Channel 102	Frequency Range	30 MHz ~ 1 GHz
Input Power	120 Vac, 60 Hz	Detector Function	Peak (PK) Quasi-peak (QP)
Environmental Conditions	25 deg. C, 65 % RH	Tested By	Getaz Yang

#### Antenna Polarity & Test Distance: Horizontal at 3 m

Frequency (MHz)	Emission Level (dBuV/m)	Read Level (dBuV)	Limit (dBuV/m)	Margin (dB)	Antenna Factor (dB/m)	Cable Loss (dB)	Preamp Factor (dB)	Antenna Height (cm)	Table Angle (Degree)	Remark
84.27	33.1	55	40	-6.9	9	1.11	32.01	166	154	Peak
183.9	23.8	44.32	43.5	-19.7	10.11	1.61	32.24	195	187	Peak
232.23	18.34	36.84	46	-27.66	11.82	1.85	32.17	104	187	Peak
403.6	18.78	33.62	46	-27.22	15.04	2.34	32.22	102	145	Peak
451.2	20.09	34.16	46	-25.91	15.58	2.49	32.14	133	165	Peak
780.9	23.94	32.62	46	-22.06	20.14	3.27	32.09	195	174	Peak

#### Antenna Polarity & Test Distance: Vertical at 3 m

Frequency (MHz)	Emission Level (dBuV/m)	Read Level (dBuV)	Limit (dBuV/m)	Margin (dB)	Antenna Factor (dB/m)	Cable Loss (dB)	Preamp Factor (dB)	Antenna Height (cm)	Table Angle (Degree)	Remark
32.16	32.82	52.68	40	-7.18	11.66	0.74	32.26	159	165	Peak
97.77	28.26	47.11	43.5	-15.24	12.02	1.28	32.15	142	157	Peak
162.03	16.48	38.4	43.5	-27.02	8.82	1.52	32.26	188	174	Peak
398.7	17.69	32.6	46	-28.31	14.97	2.34	32.22	132	165	Peak
561.8	20.73	32.86	46	-25.27	17.31	2.76	32.2	102	154	Peak
748	26.2	35.33	46	-19.8	19.79	3.22	32.14	159	169	Peak

Remarks:

- Emission Level = Read Level + Antenna Factor + Cable Loss - Preamp Factor  
Margin value = Emission level – Limit value

802.11a

EUT Test Condition		Measurement Detail	
Channel	Channel 165	Frequency Range	30 MHz ~ 1 GHz
Input Power	120 Vac, 60 Hz	Detector Function	Peak (PK) Quasi-peak (QP)
Environmental Conditions	25 deg. C, 65 % RH	Tested By	Getaz Yang

**Antenna Polarity & Test Distance: Horizontal at 3 m**

Frequency (MHz)	Emission Level (dBuV/m)	Read Level (dBuV)	Limit (dBuV/m)	Margin (dB)	Antenna Factor (dB/m)	Cable Loss (dB)	Preamp Factor (dB)	Antenna Height (cm)	Table Angle (Degree)	Remark
90.48	32.54	52.68	43.5	-10.96	10.46	1.11	31.71	169	158	Peak
171.75	21.22	42.73	43.5	-22.28	9.21	1.52	32.24	114	174	Peak
220.35	18.08	37.31	46	-27.92	11.34	1.65	32.22	154	187	Peak
402.2	18.69	33.55	46	-27.31	15.02	2.34	32.22	102	136	Peak
685.7	21.68	31.71	46	-24.32	19.02	3.05	32.1	165	195	Peak
860.7	24.51	31.64	46	-21.49	21.16	3.44	31.73	184	157	Peak

**Antenna Polarity & Test Distance: Vertical at 3 m**

Frequency (MHz)	Emission Level (dBuV/m)	Read Level (dBuV)	Limit (dBuV/m)	Margin (dB)	Antenna Factor (dB/m)	Cable Loss (dB)	Preamp Factor (dB)	Antenna Height (cm)	Table Angle (Degree)	Remark
65.1	24.15	43.38	40	-15.85	12.09	0.9	32.22	122	165	Peak
98.04	28.18	47.03	43.5	-15.32	12.02	1.28	32.15	143	162	Peak
176.88	14.92	36.05	43.5	-28.58	9.5	1.61	32.24	157	184	Peak
404.3	17.81	32.64	46	-28.19	15.05	2.34	32.22	199	165	Peak
677.3	22.06	32.25	46	-23.94	18.88	3.05	32.12	184	175	Peak
775.3	23.49	32.24	46	-22.51	20.08	3.27	32.1	133	145	Peak

Remarks:

- Emission Level = Read Level + Antenna Factor + Cable Loss - Preamp Factor  
Margin value = Emission level – Limit value

## 4.2 Conducted Emission Measurement

### 4.2.1 Limits of Conducted Emission Measurement

Frequency (MHz)	Conducted Limit (dBuV)	
	Quasi-peak	Average
0.15 - 0.5	66 - 56	56 - 46
0.50 - 5.0	56	46
5.0 - 30.0	60	50

Note: 1. The lower limit shall apply at the transition frequencies.

2. The limit decreases in line with the logarithm of the frequency in the range of 0.15 to 0.50 MHz.

### 4.2.2 Test Instruments

Description & Manufacturer	Model No.	Serial No.	Date Of Calibration	Due Date Of Calibration
Test Receiver ROHDE & SCHWARZ	ESCI	100613	Nov. 21, 2016	Nov. 20, 2017
RF signal cable (with 10dB PAD) Woken	5D-FB	Cable-cond1-01	Dec. 22, 2016	Dec. 21, 2017
LISN/AMN ROHDE & SCHWARZ (EUT)	ESH3-Z5	835239/001	Mar. 10, 2017	Mar. 09, 2018
LISN/AMN ROHDE & SCHWARZ (Peripheral)	ESH3-Z5	100311	Jul. 28, 2016	Jul. 27, 2017
Software ADT	BV ADT_Cond_ V7.3.7.3	NA	NA	NA

- Note:**
1. The calibration interval of the above test instruments is 12 months and the calibrations are traceable to NML/ROC and NIST/USA.
  2. The test was performed in HwaYa Shielded Room 1.
  3. The VCCI Site Registration No. is C-2040.

#### 4.2.3 Test Procedures

- a. The EUT was placed 0.4 meters from the conducting wall of the shielded room with EUT being connected to the power mains through a line impedance stabilization network (LISN). Other support units were connected to the power mains through another LISN. The two LISNs provide 50 ohm/ 50uH of coupling impedance for the measuring instrument.
- b. Both lines of the power mains connected to the EUT were checked for maximum conducted interference.
- c. The frequency range from 150 kHz to 30 MHz was searched. Emission levels under (Limit -20 dB) was not recorded.

**Note:** All modes of operation were investigated and the worst-case emissions are reported.

#### 4.2.4 Deviation from Test Standard

No deviation.

#### 4.2.5 Test Setup

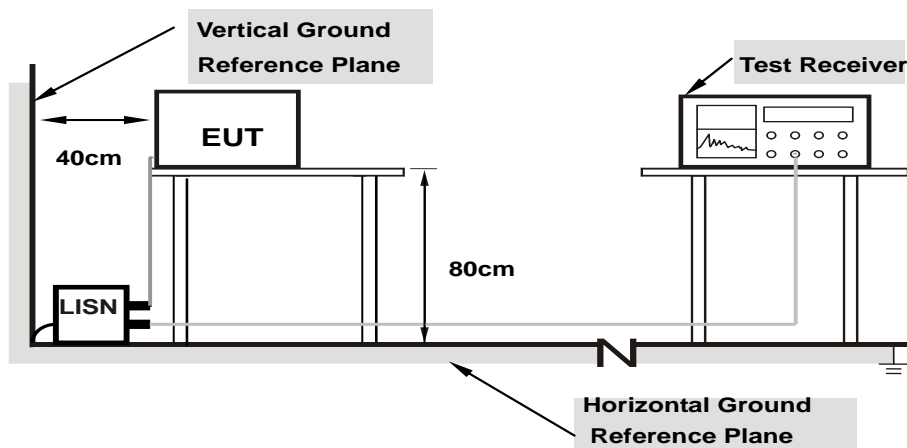

- Note:**
- 1.Support units were connected to second LISN.
  - 2.Both of LISNs (AMN) are 80 cm from EUT and at least 80 from other units and other metal planes

For the actual test configuration, please refer to the attached file (Test Setup Photo).

#### 4.2.6 EUT Operating Conditions

- a. Placed the EUT on a testing table.
- b. Use the software to control the EUT under transmission condition continuously at specific channel frequency.

#### 4.2.7 Test Results

Frequency Range	150kHz ~ 30MHz	Detector Function & Resolution Bandwidth	Quasi-Peak (QP) / Average (AV), 9kHz
Input Power	120Vac, 60Hz	Environmental Conditions	25°C, 65%RH
Tested by	Getaz Yang	Test Date	2017/6/21

Phase Of Power : Line (L)										
No	Frequency (MHz)	Correction Factor (dB)	Reading Value (dBuV)		Emission Level (dBuV)		Limit (dBuV)		Margin (dB)	
			Q.P.	AV.	Q.P.	AV.	Q.P.	AV.	Q.P.	AV.
1	0.18200	10.36	23.92	9.13	34.28	19.49	64.39	54.39	-30.11	-34.90
2	0.27400	10.38	17.42	6.63	27.80	17.01	61.00	51.00	-33.20	-33.99
3	0.38600	10.40	19.34	14.22	29.74	24.62	58.15	48.15	-28.41	-23.53
4	0.88331	10.40	6.59	1.47	16.99	11.87	56.00	46.00	-39.01	-34.13
5	5.68923	10.64	17.68	9.73	28.32	20.37	60.00	50.00	-31.68	-29.63
6	18.41400	11.27	9.69	2.13	20.96	13.40	60.00	50.00	-39.04	-36.60

Remarks:

1. Q.P. and AV. are abbreviations of quasi-peak and average individually.
2. The emission levels of other frequencies were very low against the limit.
3. Margin value = Emission level – Limit value
4. Correction factor = Insertion loss + Cable loss
5. Emission Level = Correction Factor + Reading Value

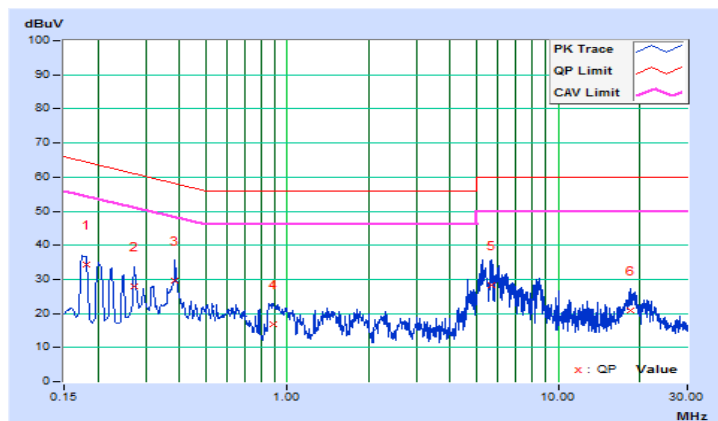

Frequency Range	150kHz ~ 30MHz	Detector Function & Resolution Bandwidth	Quasi-Peak (QP) / Average (AV), 9kHz
Input Power	120Vac, 60Hz	Environmental Conditions	25°C, 65%RH
Tested by	Getaz Yang	Test Date	2017/6/21

Phase Of Power : Neutral (N)										
No	Frequency (MHz)	Correction Factor (dB)	Reading Value (dBuV)		Emission Level (dBuV)		Limit (dBuV)		Margin (dB)	
			Q.P.	AV.	Q.P.	AV.	Q.P.	AV.	Q.P.	AV.
1	0.16579	10.12	24.99	9.28	35.11	19.40	65.17	55.17	-30.06	-35.77
2	0.20600	10.14	28.76	13.60	38.90	23.74	63.37	53.37	-24.47	-29.63
3	0.37718	10.16	20.92	14.12	31.08	24.28	58.34	48.34	-27.26	-24.06
4	0.96200	10.17	7.84	2.98	18.01	13.15	56.00	46.00	-37.99	-32.85
5	7.65000	10.47	17.56	10.25	28.03	20.72	60.00	50.00	-31.97	-29.28
6	18.97000	10.92	20.36	9.51	31.28	20.43	60.00	50.00	-28.72	-29.57

Remarks:

1. Q.P. and AV. are abbreviations of quasi-peak and average individually.
2. The emission levels of other frequencies were very low against the limit.
3. Margin value = Emission level – Limit value
4. Correction factor = Insertion loss + Cable loss
5. Emission Level = Correction Factor + Reading Value

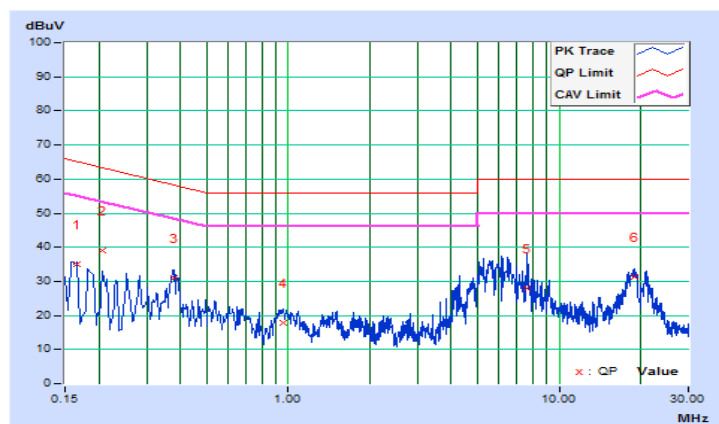

### 4.3 Transmit Power Measurement

#### 4.3.1 Limits of Transmit Power Measurement

Operation Band	EUT Category	Limit
U-NII-1	Outdoor Access Point	1 Watt (30 dBm) (Max. e.i.r.p $\leq$ 125 mW (21 dBm) at any elevation angle above 30 degrees as measured from the horizon)
	Fixed point-to-point Access Point	1 Watt (30 dBm)
	Indoor Access Point	1 Watt (30 dBm)
	√ Mobile and Portable client device	250 mW (24 dBm)
U-NII-2A	√	250 mW (24 dBm) or 11 dBm+10 log B*
U-NII-2C	√	250 mW (24 dBm) or 11 dBm+10 log B*
U-NII-3	√	1 Watt (30 dBm)

\*B is the 26 dB emission bandwidth in megahertz

#### 4.3.2 Test Setup

##### <Power Output Measurement>

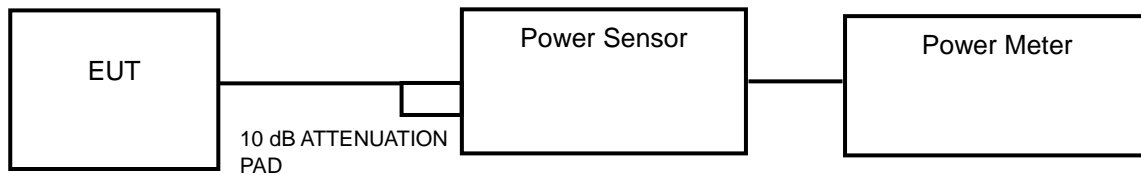

##### <26 dB Bandwidth>

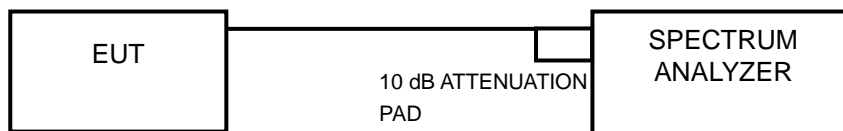

#### 4.3.3 Test Instruments

Refer to section 4.1.2 to get information of above instrument.

#### 4.3.4 Test Procedure

##### **Average Power Measurement**

<802.11a, 802.11n (HT20), 802.11n (HT40)>

Method PM is used to perform output power measurement, trigger and gating function of wide band power meter is enabled to measure max output power of TX on burst. Duty factor is not added to measured value.

##### **26 dB Bandwidth**

- 1) Set RBW = approximately 1 % of the emission bandwidth.
- 2) Set the VBW > RBW.
- 3) Detector = Peak.
- 4) Trace mode = max hold.
- 5) Measure the maximum width of the emission that is 26 dB down from the peak of the emission. Compare this with the RBW setting of the analyzer. Readjust RBW and repeat measurement as needed until the RBW/EBW ratio is approximately 1 %.

#### 4.3.5 Deviation from Test Standard

No deviation.

#### 4.3.6 EUT Operating Conditions

The software provided by client to enable the EUT under transmission condition continuously at lowest, middle and highest channel frequencies individually.



#### 4.3.7 Test Result

##### Power Output:

##### 802.11a

Channel	Frequency (MHz)	Maximum Conducted Power (mW)	Maximum Conducted Power (dBm)	Power Limit (dBm)	Pass / Fail
36	5180	23.227	13.66	24	Pass
44	5220	23.659	13.74	24	Pass
48	5240	23.605	13.73	24	Pass
52	5260	24.210	13.84	24	Pass
60	5300	23.605	13.73	24	Pass
64	5320	23.823	13.77	24	Pass
100	5500	13.274	11.23	24	Pass
116	5580	23.281	13.67	24	Pass
140	5700	13.428	11.28	24	Pass
149	5745	12.853	11.09	30	Pass
157	5785	22.080	13.44	30	Pass
165	5825	21.979	13.42	30	Pass

##### Note:

##### For U-NII-2A, U-NII-2C Band:

1.  $11 \text{ dBm} + 10\log(25.93) = 25.14 \text{ dBm} > 24 \text{ dBm}$ .
2.  $11 \text{ dBm} + 10\log(26.47) = 25.23 \text{ dBm} > 24 \text{ dBm}$ .
3.  $11 \text{ dBm} + 10\log(26.81) = 25.28 \text{ dBm} > 24 \text{ dBm}$ .
4.  $11 \text{ dBm} + 10\log(22.74) = 24.57 \text{ dBm} > 24 \text{ dBm}$ .
5.  $11 \text{ dBm} + 10\log(28.13) = 25.49 \text{ dBm} > 24 \text{ dBm}$ .
6.  $11 \text{ dBm} + 10\log(22.62) = 24.54 \text{ dBm} > 24 \text{ dBm}$ .

### 802.11n (HT20)

Channel	Frequency (MHz)	Maximum Conducted Power (mW)	Maximum Conducted Power (dBm)	Power Limit (dBm)	Pass / Fail
36	5180	22.080	13.44	24	Pass
44	5220	22.182	13.46	24	Pass
48	5240	21.727	13.37	24	Pass
52	5260	21.478	13.32	24	Pass
60	5300	21.928	13.41	24	Pass
64	5320	21.979	13.42	24	Pass
100	5500	12.912	11.11	24	Pass
116	5580	21.777	13.38	24	Pass
140	5700	13.397	11.27	24	Pass
149	5745	13.213	11.21	30	Pass
157	5785	21.627	13.35	30	Pass
165	5825	21.528	13.33	30	Pass

**Note:**

**For U-NII-2A, U-NII-2C Band:**

1.  $11 \text{ dBm} + 10\log(25.85) = 25.12 \text{ dBm} > 24 \text{ dBm}$ .
2.  $11 \text{ dBm} + 10\log(25.90) = 25.13 \text{ dBm} > 24 \text{ dBm}$ .
3.  $11 \text{ dBm} + 10\log(25.07) = 24.99 \text{ dBm} > 24 \text{ dBm}$ .
4.  $11 \text{ dBm} + 10\log(23.07) = 24.63 \text{ dBm} > 24 \text{ dBm}$ .
5.  $11 \text{ dBm} + 10\log(25.91) = 25.13 \text{ dBm} > 24 \text{ dBm}$ .
6.  $11 \text{ dBm} + 10\log(24.41) = 24.88 \text{ dBm} > 24 \text{ dBm}$ .

### 802.11n (HT40)

Channel	Frequency (MHz)	Maximum Conducted Power (mW)	Maximum Conducted Power (dBm)	Power Limit (dBm)	Pass / Fail
38	5190	21.429	13.31	24	Pass
46	5230	21.928	13.41	24	Pass
54	5270	21.627	13.35	24	Pass
62	5310	21.777	13.38	24	Pass
102	5510	20.797	13.18	24	Pass
110	5550	20.941	13.21	24	Pass
134	5670	20.464	13.11	24	Pass
151	5755	13.152	11.19	30	Pass
159	5795	13.274	11.23	30	Pass

**Note:**

**For U-NII-2A, U-NII-2C Band:**

1.  $11 \text{ dBm} + 10\log(61.24) = 28.87 \text{ dBm} > 24 \text{ dBm}$ .
2.  $11 \text{ dBm} + 10\log(58.22) = 28.65 \text{ dBm} > 24 \text{ dBm}$ .
3.  $11 \text{ dBm} + 10\log(51.38) = 28.11 \text{ dBm} > 24 \text{ dBm}$ .
4.  $11 \text{ dBm} + 10\log(54.81) = 28.39 \text{ dBm} > 24 \text{ dBm}$ .
5.  $11 \text{ dBm} + 10\log(61.77) = 28.91 \text{ dBm} > 24 \text{ dBm}$ .

**26 dB Bandwidth:**
**802.11a**

Channel	Frequency (MHz)	26 dBc Bandwidth (MHz)
36	5180	26.18
44	5220	25.58
48	5240	27.39
52	5260	25.93
60	5300	26.47
64	5320	26.81
100	5500	22.74
116	5580	28.13
140	5700	22.62

**802.11n (HT20)**

Channel	Frequency (MHz)	26 dBc Bandwidth (MHz)
36	5180	25.11
44	5220	27.82
48	5240	24.83
52	5260	25.85
60	5300	25.90
64	5320	25.07
100	5500	23.07
116	5580	25.91
140	5700	24.41

**802.11n (HT40)**

Channel	Frequency (MHz)	26 dBc Bandwidth (MHz)
38	5190	65.26
46	5230	64.91
54	5270	61.24
62	5310	58.22
102	5510	51.38
110	5550	54.81
134	5670	61.77

### Spectrum Plot of Worst Value

#### 802.11a

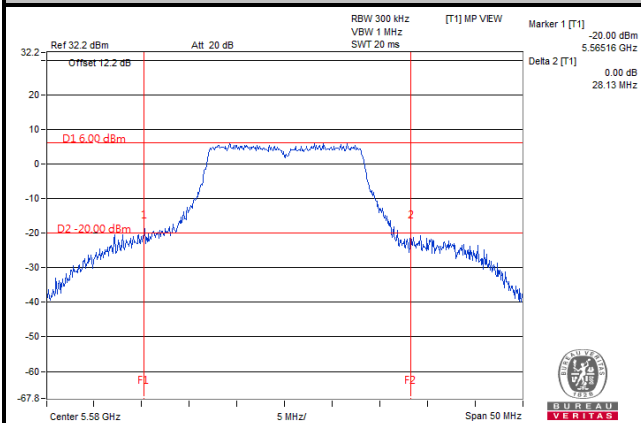

#### 802.11n (HT20)

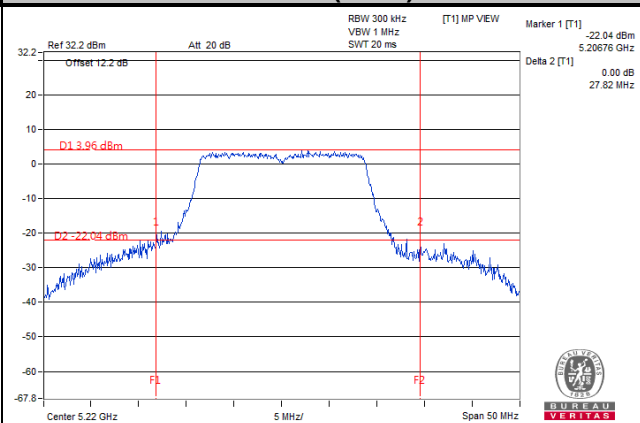

#### 802.11n (HT40)

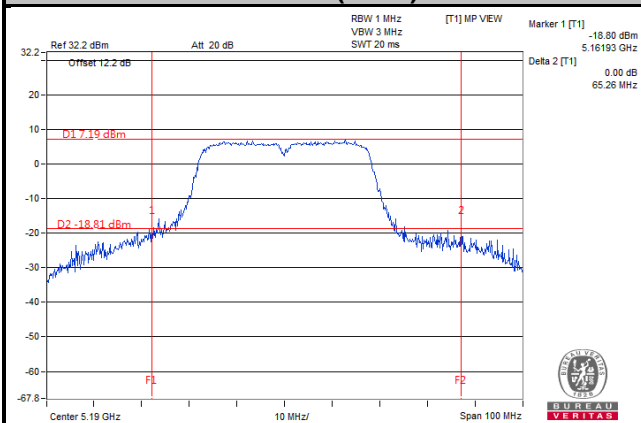

#### 4.4 Peak Power Spectral Density Measurement

##### 4.4.1 Limits of Peak Power Spectral Density Measurement

Operation Band	EUT Category		Limit
U-NII-1		Outdoor Access Point	17 dBm/MHz
		Fixed point-to-point Access Point	
		Indoor Access Point	
	√	Mobile and Portable client device	11 dBm/MHz
U-NII-2A		√	11 dBm/MHz
U-NII-2C		√	11 dBm/MHz
U-NII-3		√	30 dBm/500 kHz

##### 4.4.2 Test Setup

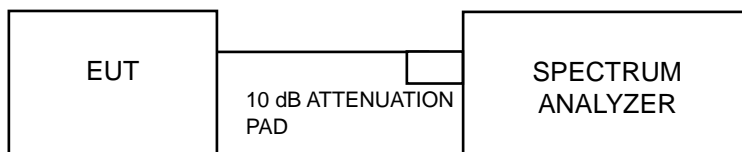

##### 4.4.3 Test Instruments

Refer to section 4.1.3 to get information of above instrument.

#### 4.4.4 Test Procedures

##### **For U-NII-1, U-NII-2A, U-NII-2C band:**

Using method SA-1

1. Set span to encompass the entire emission bandwidth (EBW) of the signal.
2. Set RBW = 1 MHz, Set VBW  $\geq$  3 RBW, Detector = RMS
3. Sweep time = auto, trigger set to "free run".
4. Trace average at least 100 traces in power averaging mode.
5. Record the max value

Using method SA-2

1. Set span to encompass the entire emission bandwidth (EBW) of the signal.
2. Set RBW = 1 MHz, Set VBW  $\geq$  3 RBW, Detector = RMS
3. Sweep time = auto, trigger set to "free run".
4. Trace average at least 100 traces in power averaging mode.
5. Record the max value and add  $10 \log (1/\text{duty cycle})$

##### **※For U-NII-3:**

1. Set span to encompass the entire emission bandwidth (EBW) of the signal.
2. Set RBW = 500 kHz, Set VBW  $\geq$  3 RBW, Detector = RMS
3. Use the peak marker function to determine the maximum power level in any 500 kHz band segment within the fundamental EBW.
4. Sweep time = auto, trigger set to "free run".
5. Trace average at least 100 traces in power averaging mode.
6. Record the max value and add  $10 \log (1/\text{duty cycle})$

#### 4.4.5 Deviation from Test Standard

No deviation.

#### 4.4.6 EUT Operating Conditions

The software provided by client to enable the EUT under transmission condition continuously at lowest, middle and highest channel frequencies individually.

#### 4.4.7 Test Results

##### 802.11a

Channel	Frequency (MHz)	PSD (dBm/MHz)	Maximum Limit (dBm/MHz)	Pass / Fail
36	5180	0.94	11	Pass
44	5220	1.09	11	Pass
48	5240	1.05	11	Pass
52	5260	1.21	11	Pass
60	5300	1.69	11	Pass
64	5320	1.94	11	Pass
100	5500	0.31	11	Pass
116	5580	2.53	11	Pass
140	5700	-1.28	11	Pass

##### 802.11n (HT20)

Channel	Frequency (MHz)	PSD w/o Duty Factor (dBm/MHz)	Duty Factor (dB)	PSD with Duty Factor (dBm/MHz)	Maximum Limit (dBm/MHz)	Pass / Fail
36	5180	0.04	0.10	0.14	11	Pass
44	5220	0.39	0.10	0.49	11	Pass
48	5240	0.12	0.10	0.22	11	Pass
52	5260	0.47	0.10	0.57	11	Pass
60	5300	0.76	0.10	0.86	11	Pass
64	5320	0.85	0.10	0.95	11	Pass
100	5500	-0.07	0.10	0.03	11	Pass
116	5580	1.54	0.10	1.64	11	Pass
140	5700	-1.75	0.10	-1.65	11	Pass

**Note:** Refer to section 3.3 for duty cycle spectrum plot.



### 802.11n (HT40)

Channel	Frequency (MHz)	PSD w/o Duty Factor (dBm/MHz)	Duty Factor (dB)	PSD with Duty Factor (dBm/MHz)	Maximum Limit (dBm/MHz)	Pass / Fail
38	5190	-2.29	0.22	-2.07	11	Pass
46	5230	-2.12	0.22	-1.90	11	Pass
54	5270	-2.03	0.22	-1.81	11	Pass
62	5310	-1.57	0.22	-1.35	11	Pass
102	5510	-0.83	0.22	-0.61	11	Pass
110	5550	-0.92	0.22	-0.70	11	Pass
134	5670	-1.91	0.22	-1.69	11	Pass

**Note:** Refer to section 3.3 for duty cycle spectrum plot.

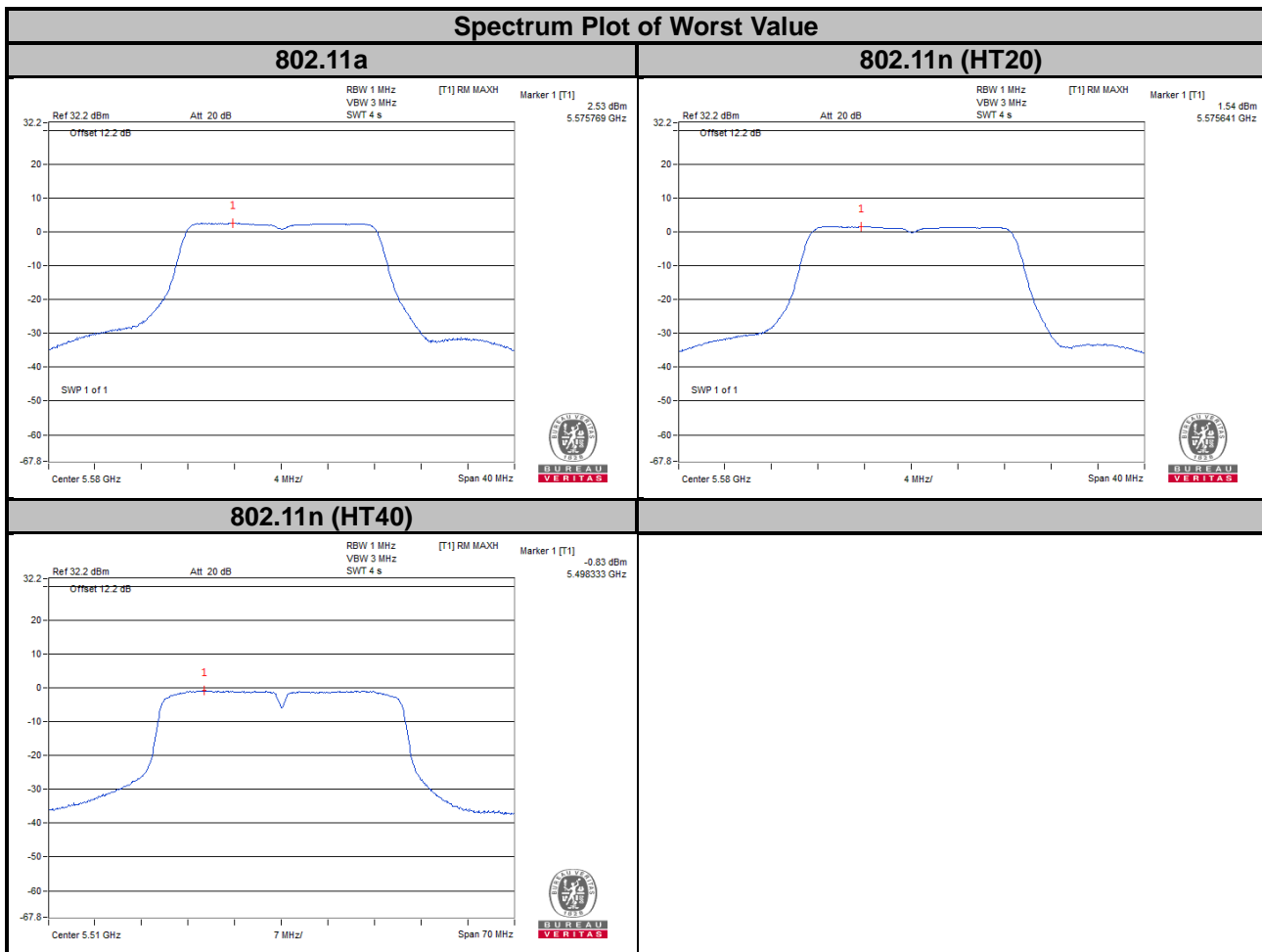

## For U-NII-3 Band

### 802.11a

Channel	Freq. (MHz)	PSD (dBm/500 kHz)	Limit (dBm/500 kHz)	Pass / Fail
149	5745	-4.75	30	Pass
157	5785	-1.98	30	Pass
165	5825	-1.71	30	Pass

### 802.11n (HT20)

Channel	Frequency (MHz)	PSD w/o Duty Factor (dBm/500 kHz)	Duty Factor (dB)	PSD with Duty Factor (dBm/500 kHz)	Limit (dBm/500 kHz)	Pass / Fail
149	5745	-5.16	0.10	-5.06	30	Pass
157	5785	-2.89	0.10	-2.79	30	Pass
165	5825	-2.50	0.10	-2.40	30	Pass

**Note:** Refer to section 3.3 for duty cycle spectrum plot.

### 802.11n (HT40)

Channel	Frequency (MHz)	PSD w/o Duty Factor (dBm/500 kHz)	Duty Factor (dB)	PSD with Duty Factor (dBm/500 kHz)	Limit (dBm/500 kHz)	Pass / Fail
151	5755	-8.27	0.22	-8.05	30	Pass
159	5795	-7.57	0.22	-7.35	30	Pass

**Note:** Refer to section 3.3 for duty cycle spectrum plot.

### Spectrum Plot of Worst Value

#### 802.11a

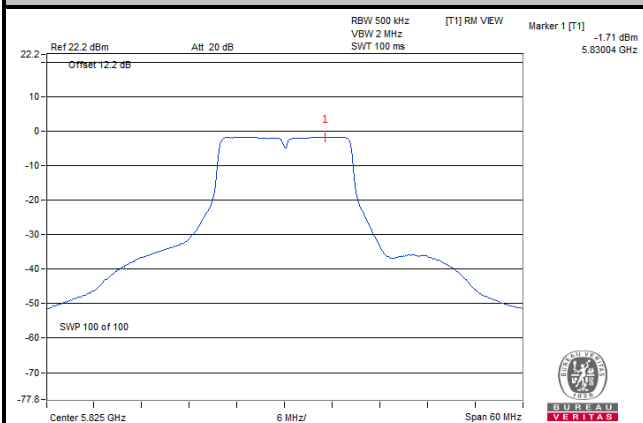

#### 802.11n (HT20)

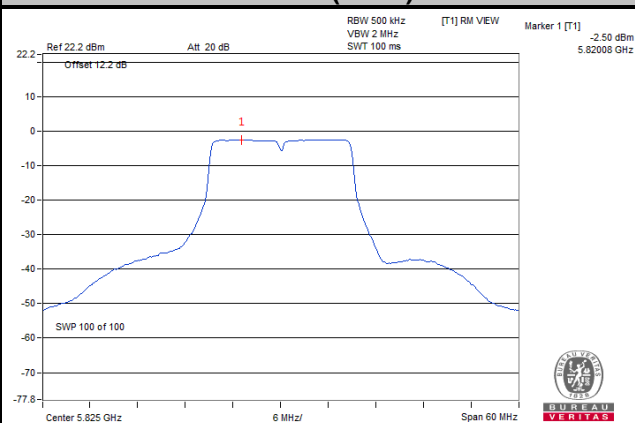

#### 802.11n (HT40)

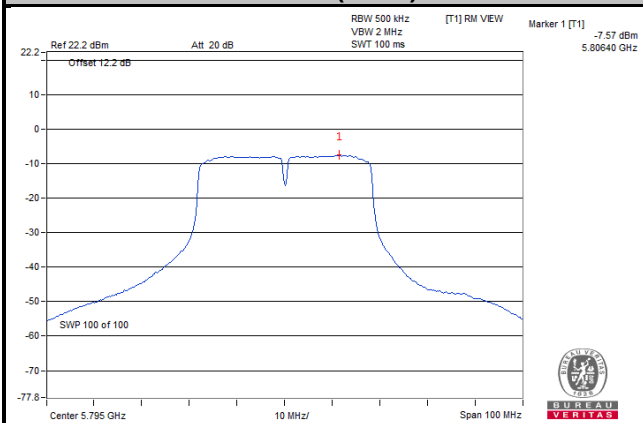

## 4.5 Frequency Stability

### 4.5.1 Limit of Frequency Stability Measurement

The frequency of the carrier signal shall be maintained within band of operation.

### 4.5.2 Test Setup

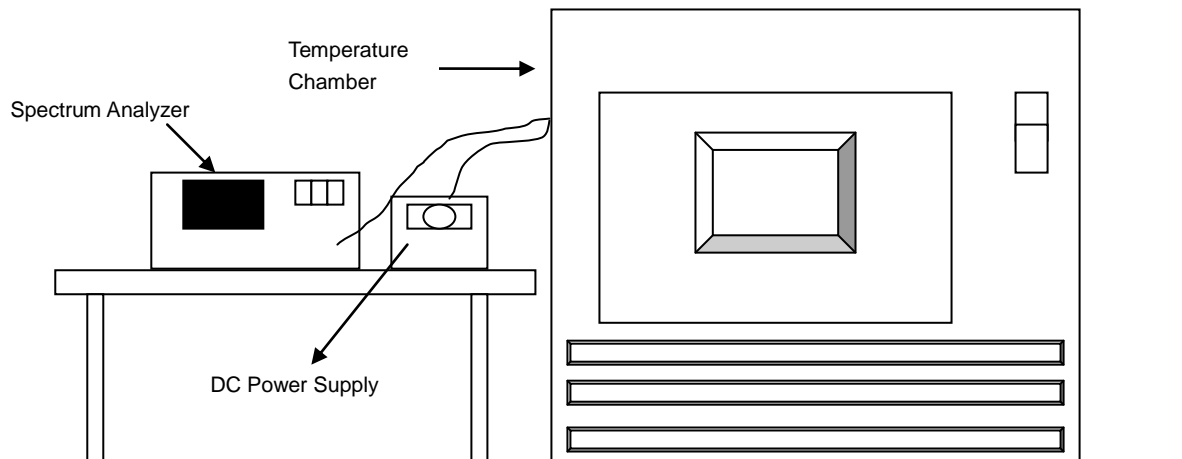

### 4.5.3 Test Instruments

Refer to section 4.1.3 to get information of above instrument.

### 4.5.4 Test Procedure

- To ensure emission at the band edge is maintained within the authorized band, those values shall be measured by radiation emissions at upper and lower frequency points, and finally compensated by frequency deviation as procedures below.
- The EUT was operated at the maximum output power, and connected to the spectrum analyzer, which is set to maximum hold function and peak detector. The peak value of the power envelope was measured and noted. The upper and lower frequency points were respectively measured relatively 10 dB lower than the measured peak value.
- The frequency deviation was calculated by adding the upper frequency point and the lower frequency point divided by two. Those detailed values of frequency deviation are provided in table below.

### 4.5.5 Deviation from Test Standard

No deviation.

### 4.5.6 EUT Operating Condition

Set the EUT transmit at un-modulation mode to test frequency stability.

#### 4.5.7 Test Results

Frequency Stability Versus Temp.									
Operating Frequency: 5180 MHz									
Temp. (°C)	Power Supply (Vdc)	0 Minute		2 Minute		5 Minute		10 Minute	
		Measured Frequency (MHz)	Frequency Drift (ppm)	Measured Frequency (MHz)	Frequency Drift (ppm)	Measured Frequency (MHz)	Frequency Drift (ppm)	Measured Frequency (MHz)	Frequency Drift (ppm)
50	3.7	5179.9803	-3.80000	5179.982	-3.47000	5179.9803	-3.80000	5179.9788	-4.09000
40	3.7	5180.0221	4.27000	5180.0226	4.36000	5180.0205	3.96000	5180.0235	4.54000
30	3.7	5179.987	-2.51000	5179.9859	-2.72000	5179.9871	-2.49000	5179.9857	-2.76000
20	3.7	5179.979	-4.05000	5179.9817	-3.53000	5179.9815	-3.57000	5179.9816	-3.55000
10	3.7	5180.0115	2.22000	5180.0135	2.61000	5180.0139	2.68000	5180.0129	2.49000
0	3.7	5180.0067	1.29000	5180.0095	1.83000	5180.0076	1.47000	5180.0089	1.72000
-10	3.7	5180.012	2.32000	5180.0125	2.41000	5180.011	2.12000	5180.0111	2.14000
-20	3.7	5179.9813	-3.61000	5179.9778	-4.29000	5179.9789	-4.07000	5179.9804	-3.78000
-30	3.7	5180.0048	0.93000	5180.0088	1.70000	5180.0081	1.56000	5180.0057	1.10000

Frequency Stability Versus Temp.									
Operating Frequency: 5180 MHz									
Temp. (°C)	Power Supply (Vdc)	0 Minute		2 Minute		5 Minute		10 Minute	
		Measured Frequency (MHz)	Frequency Drift (ppm)	Measured Frequency (MHz)	Frequency Drift (ppm)	Measured Frequency (MHz)	Frequency Drift (ppm)	Measured Frequency (MHz)	Frequency Drift (ppm)
20	4.255	5179.9785	-4.15000	5179.9809	-3.69000	5179.9815	-3.57000	5179.9824	-3.40000
	3.7	5179.979	-4.05000	5179.9817	-3.53000	5179.9815	-3.57000	5179.9816	-3.55000
	3.145	5179.9782	-4.21000	5179.9811	-3.65000	5179.9808	-3.71000	5179.9815	-3.57000

## 4.6 6 dB Bandwidth Measurement

### 4.6.1 Limits of 6 dB Bandwidth Measurement

The minimum of 6 dB Bandwidth Measurement is 0.5 MHz.

### 4.6.2 Test Setup

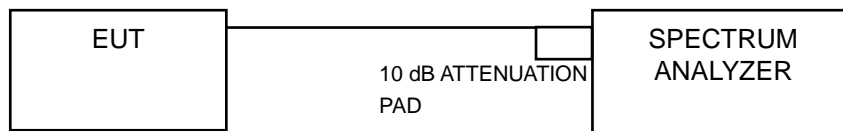

### 4.6.3 Test Instruments

Refer to section 4.1.3 to get information of above instrument.

### 4.6.4 Test Procedure

#### MEASUREMENT PROCEDURE REF

- Set resolution bandwidth (RBW) = 100 kHz
- Set the video bandwidth (VBW)  $\geq 3 \times$  RBW, Detector = Peak.
- Trace mode = max hold.
- Sweep = auto couple.
- Measure the maximum width of the emission that is constrained by the frequencies associated with the two amplitude points (upper and lower) that are attenuated by 6 dB relative to the maximum level measured in the fundamental emission

### 4.6.5 Deviation from Test Standard

No deviation.

### 4.6.6 EUT Operating Condition

The software provided by client to enable the EUT under transmission condition continuously at lowest, middle and highest channel frequencies individually.

#### 4.6.7 Test Results

##### 802.11a

Channel	Frequency (MHz)	6 dB Bandwidth (MHz)	Minimum Limit (MHz)	Pass / Fail
149	5745	16.41	0.5	Pass
157	5785	16.41	0.5	Pass
165	5825	16.40	0.5	Pass

##### 802.11n (HT20)

Channel	Frequency (MHz)	6 dB Bandwidth (MHz)	Minimum Limit (MHz)	Pass / Fail
149	5745	17.66	0.5	Pass
157	5785	17.62	0.5	Pass
165	5825	17.64	0.5	Pass

##### 802.11n (HT40)

Channel	Frequency (MHz)	6 dB Bandwidth (MHz)	Minimum Limit (MHz)	Pass / Fail
151	5755	35.40	0.5	Pass
159	5795	35.33	0.5	Pass

### Spectrum Plot of Worst Value

#### 802.11a

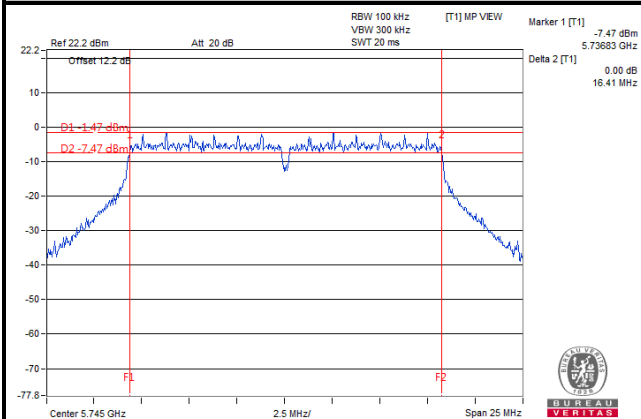

#### 802.11n (HT20)

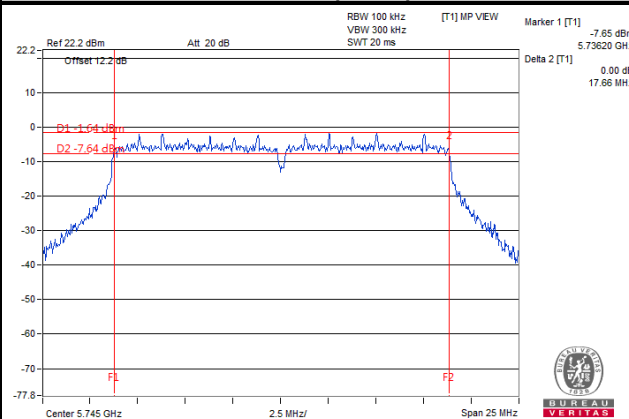

#### 802.11n (HT40)

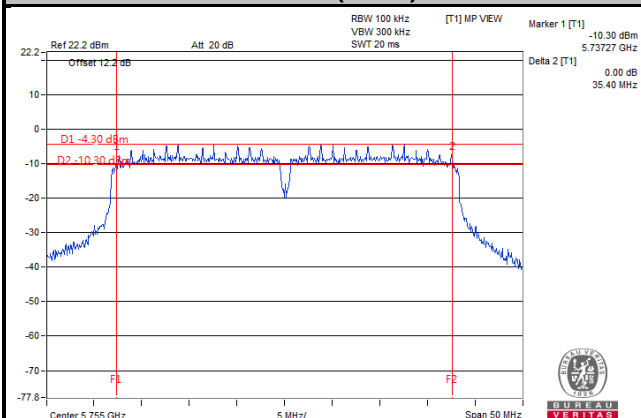



## 5 Pictures of Test Arrangements

Please refer to the attached file (Test Setup Photo).

# Annex A- Radiated Out of Band Emision (OOBE) Measurement (For U-NII-3 band)

## 802.11a

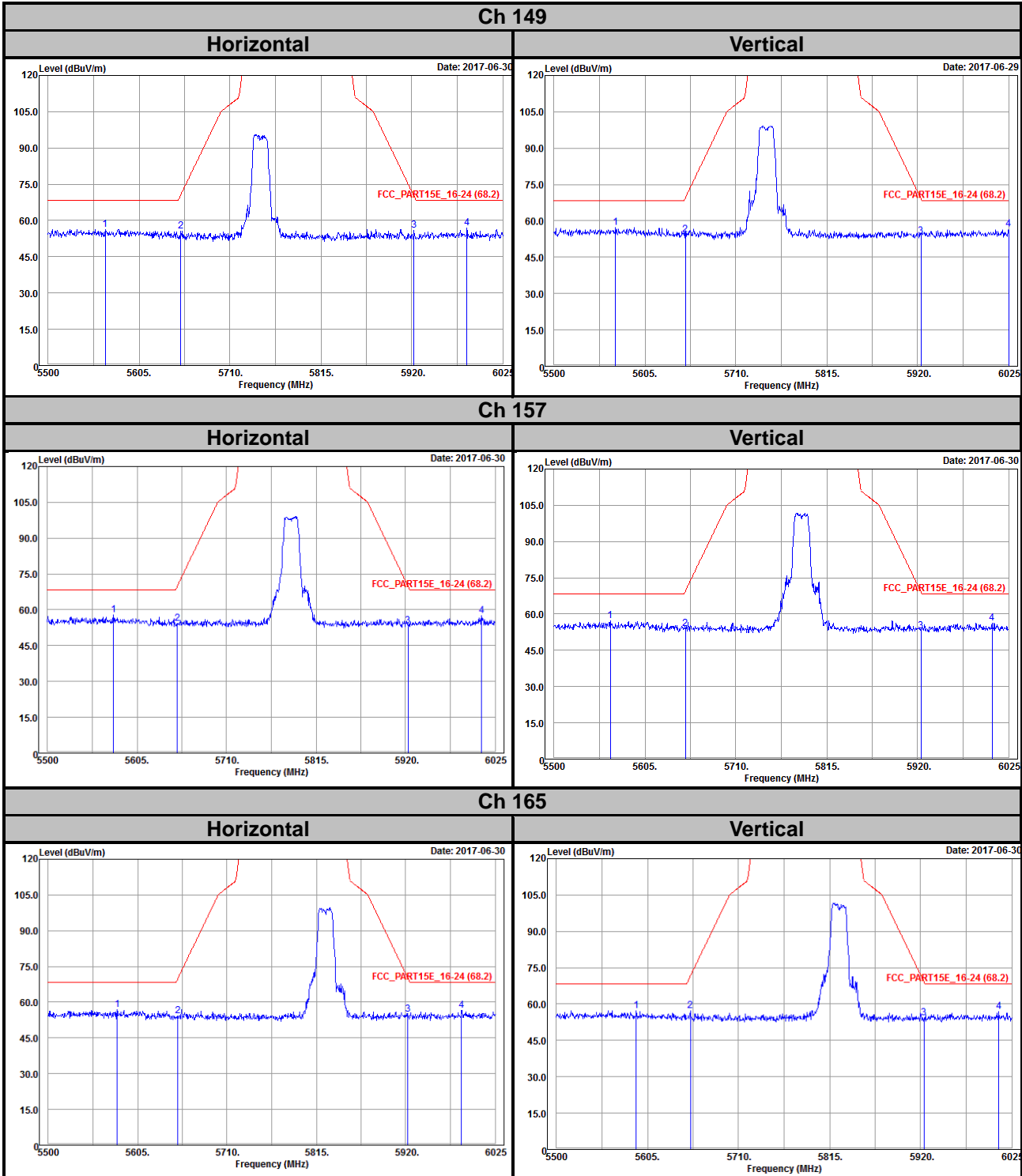

802.11n (HT20)

Ch 149

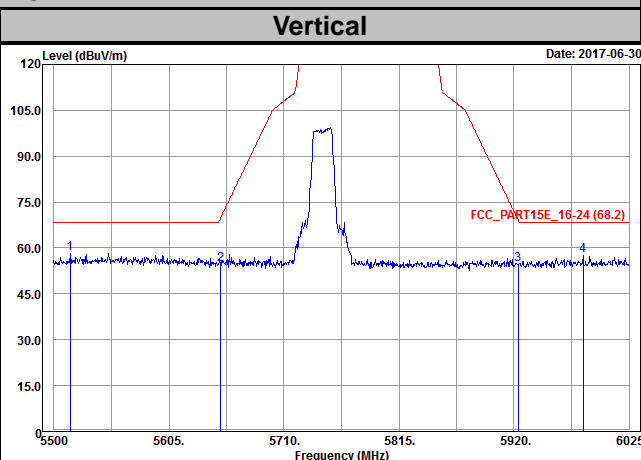
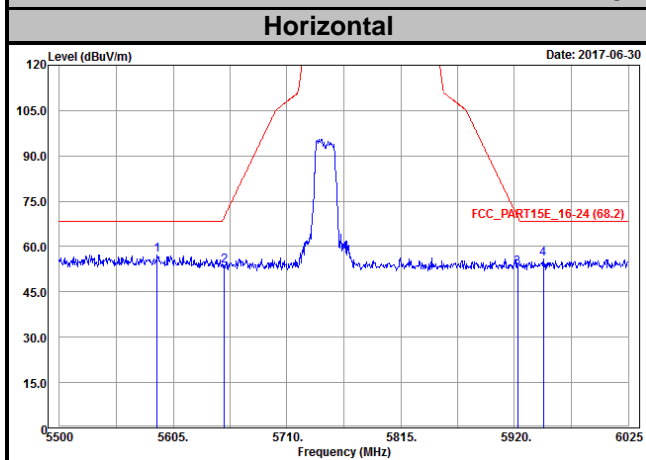

Ch 157

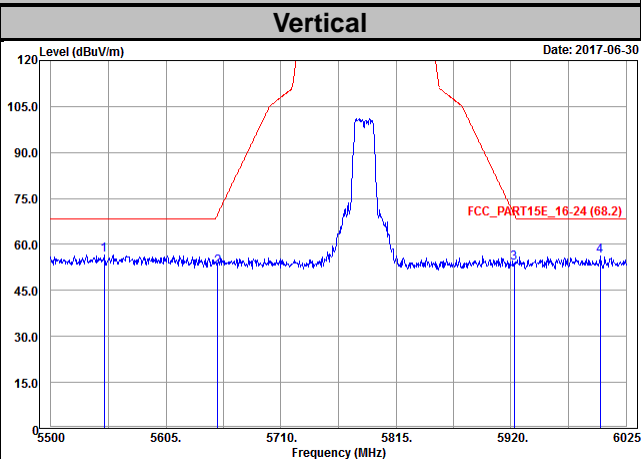
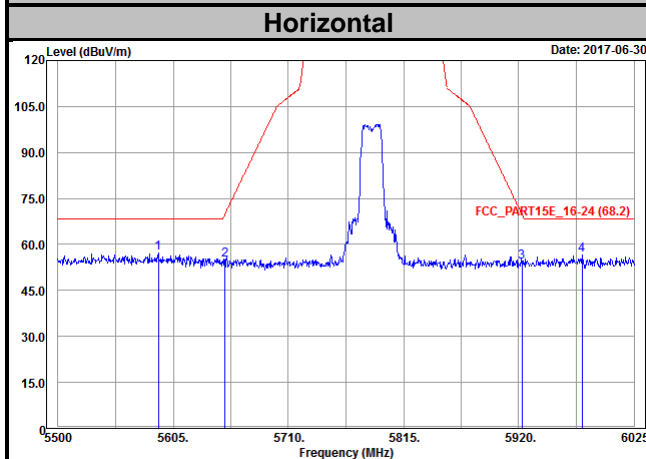

Ch 165

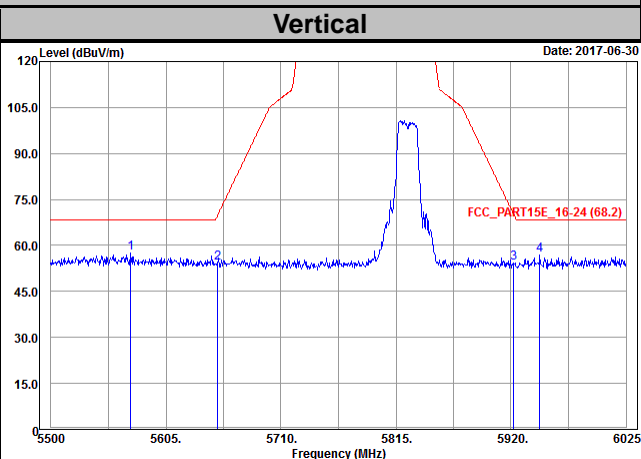
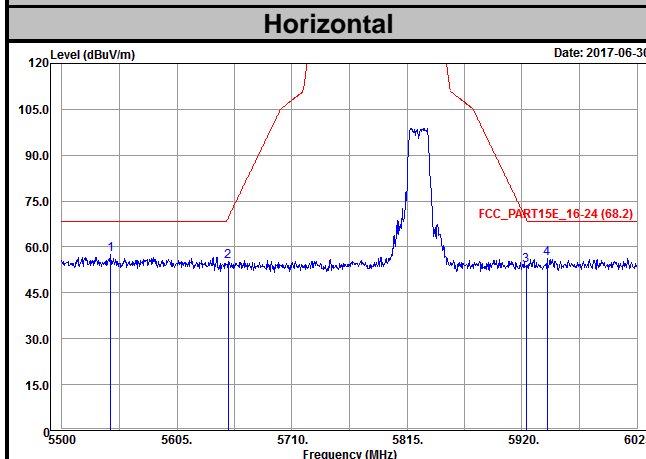

802.11n (HT40)

Ch 151

Horizontal

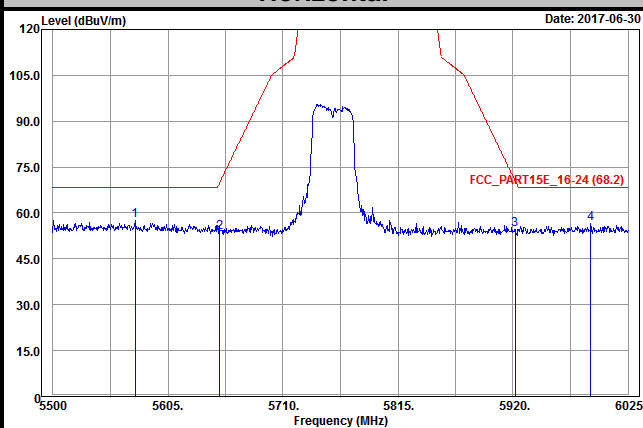

Vertical

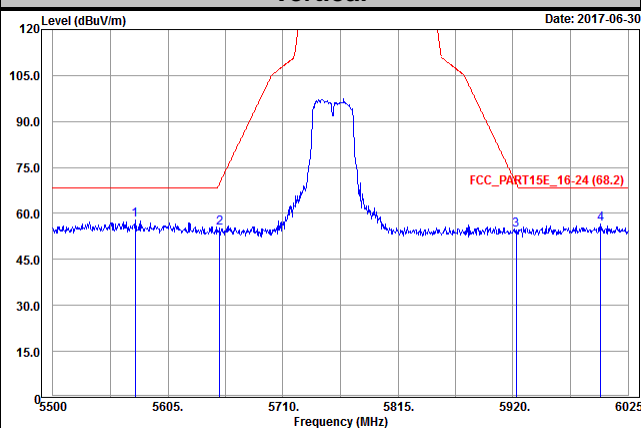

Ch 159

Horizontal

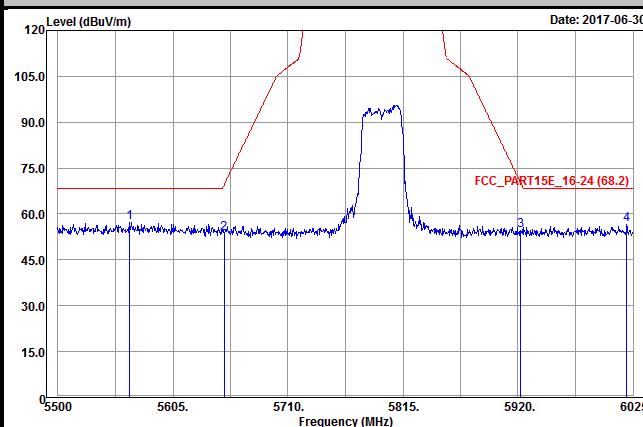

Vertical

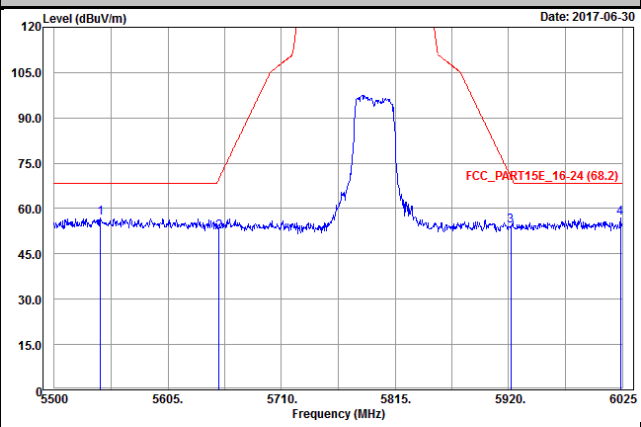

## Appendix – Information on the Testing Laboratories

We, Bureau Veritas Consumer Products Services (H.K.) Ltd., Taoyuan Branch, were founded in 1988 to provide our best service in EMC, Radio, Telecom and Safety consultation. Our laboratories are accredited and approved according to ISO/IEC 17025.

If you have any comments, please feel free to contact us at the following:

**Linko EMC/RF Lab**

Tel: 886-2-26052180

Fax: 886-2-26051924

**Hsin Chu EMC/RF/Telecom Lab**

Tel: 886-3-6668565

Fax: 886-3-6668323

**Hwa Ya EMC/RF/Safety**

Tel: 886-3-3183232

Fax: 886-3-3270892

**Email:** [service.adt@tw.bureauveritas.com](mailto:service.adt@tw.bureauveritas.com)

**Web Site:** [www.bureauveritas-adt.com](http://www.bureauveritas-adt.com)

The address and road map of all our labs can be found in our web site also.

--- END ---