

|            |                        |
|------------|------------------------|
| Applicant: | Kyocera                |
| FCC ID:    | V65E4100               |
| Report #:  | CT-E4100-22_24-0810-R1 |

## RF Emissions Test Report

FCC Part 22 and 24

For

Kyocera Corporation  
c/o Kyocera Communication Inc.

|          |                      |
|----------|----------------------|
| Product: | Dual-Band CDMA Phone |
| Model:   | E4100                |

|            |                        |
|------------|------------------------|
| Applicant: | Kyocera                |
| FCC ID:    | V65E4100               |
| Report #:  | CT-E4100-22_24-0810-R1 |

**TABLE OF CONTENTS**

1 SUMMARY OF TESTING ..... 4

2 EQUIPMENT UNDER TEST INFORMATION..... 4

3 TEST FACILITIES..... 5

4 TEST SETUP ..... 5

    4.1 Test Configuration ..... 6

5 tty compliance ..... 7

6 Conducted RF OUTPUT POWER..... 7

    6.1 Test Configuration ..... 7

    6.2 Test Results..... 7

7 RADIATED RF OUTPUT POWER ..... 8

    7.1 Test Configuration ..... 8

    7.2 Test Results..... 8

8 OCCUPIED BANDWIDTH ..... 9

    8.1 Test Configuration ..... 9

    8.2 Test Result ..... 9

9 Spurious Emissions At Antenna Terminals ..... 14

    9.1 Test Configuration ..... 14

    9.2 Test Result ..... 14

10 Transmitter Radiated Spurious Emissions ..... 21

    10.1 Test Configuration and Result ..... 21

11 Receiver Spurious Emissions ..... 21

    11.1 Receiver Spurious Emissions..... 21

12 Transmitter RF Carrier Frequency Stability..... 22

    12.1 Test Configuration ..... 22

    12.2 Test Result ..... 23

13 Exposure of Humans to RF Fields (SAR) ..... 25

    13.1 Test Configuration and Result ..... 25

14 TEST EQUIPMENT..... 25



|            |                        |
|------------|------------------------|
| Applicant: | Kyocera                |
| FCC ID:    | V65E4100               |
| Report #:  | CT-E4100-22_24-0810-R1 |

**ATTESTATION**

The tested device complies with the requirements in respect of all parameters subject to the test.

The test results and statements relate only to the items tested.

The test equipment used was suitable for the tests performed and within manufacturer's published specifications and operating parameters.

The test methods were consistent with the methods described in the relevant standards.

|                                   |   |
|-----------------------------------|---|
| <b>Product:</b>                   | Dual-Band CDMA Cellular Phone with Bluetooth  |
| <b>Model #:</b>                   | E4100   |
| <b>FCC ID:</b>                    | V65E4100  |
| <b>Tested in accordance with:</b> | FCC Part 22 & 24  |
| <b>Test performed by:</b>         | CompTest Services LLC   |
| <b>Test Requested by:</b>         | Kyocera Corporation<br>c/o Kyocera Communication Inc<br>10300 Campus Point Drive<br>San Diego, CA 92121 United States |
| <b>Date of Test:</b>              | August 20, 2010 – August 23, 2010   |

**Responsible Engineer**

*Benjamin Nguyen*

---

Benjamin Nguyen  
Test Engineer

**Reviewed and approved by:**

---

Tammy To  
Quality Manager

|            |                        |
|------------|------------------------|
| Applicant: | Kyocera                |
| FCC ID:    | V65E4100               |
| Report #:  | CT-E4100-22_24-0810-R1 |

## 1 SUMMARY OF TESTING

| Section # | Rule Part                           | Test Description                           | Verdict |
|-----------|-------------------------------------|--|---------|
| 4         | FCC § 2.1046                        | Conducted Power                            | Pass    |
| 5         | FCC § 22.913, 24.232                | Radiated Power                             | Pass    |
| 6         | FCC § 2.1049, 22.917 (b)(d), 24.238 | Occupied Bandwidth                         | Pass    |
| 7         | FCC § 2.1051, 22.917(e)(f), 24.238  | Spurious Emissions at Antenna Terminals    | Pass    |
| 8         | FCC § 2.1053, 22.91, 24.238         | Transmitter Radiated Spurious Emissions    | Pass    |
| 9         | FCC § 15.109                        | Receiver Spurious Emissions                | Pass    |
| 10        | FCC § 2.1055, 22.355, 24.235        | Transmitter RF Carrier Frequency Stability | Pass    |
| 11        | FCC § 2.1093                        | Exposure of Humans to RF Fields            | Pass    |

## 2 EQUIPMENT UNDER TEST INFORMATION

|                                 |   |             |
|---------------------------------|---|-------------|
| <b>EUT Serial Number:</b>       | 4100D050  |             |
| <b>Type:</b>                    | <input type="checkbox"/> Prototype, <input checked="" type="checkbox"/> Pre-Production, <input type="checkbox"/> Production |             |
| <b>Equipment Category:</b>      | Portable  |             |
| <b>RF Exposure Environment:</b> | General Population / Uncontrolled   |             |
| <b>Antenna:</b>                 | Internal Antenna  |             |
| <b>Detachable Antenna:</b>      | No  |             |
| <b>External Input:</b>          | Audio/Digital Data  |             |
| <b>Quantity:</b>                | Quantity production is planned  |             |
| <b>Multiple Access Scheme:</b>  | CDMA  |             |
| <b>Emission Designators:</b>    | 1M25F9W   |             |
| <b>FCC Rule Parts:</b>          | §22H  | §24E        |
| <b>Modes:</b>                   | 800 CDMA  | 1900 CDMA   |
| <b>TX Frequency (MHz):</b>      | 824 – 849   | 1850 - 1910 |
| <b>Max. Output Power (W):</b>   | 0.692 ERP   | 1.259 EIRP  |

|            |                        |
|------------|------------------------|
| Applicant: | Kyocera                |
| FCC ID:    | V65E4100               |
| Report #:  | CT-E4100-22_24-0810-R1 |

### 3 TEST FACILITIES

The test sites and measurement facilities used to collect data are located at 10300 Campus Point Drive San Diego, CA 92121, USA

### 4 TEST SETUP

All CDMA measurements were conducted with a base station simulator to establish a CDMA link with the equipment under test (EUT). To investigate the response of the EUT the main antenna RF output port of the EUT was connected to the input of the spectrum analyzer with a RF cable. The amplitude of the spectrum analyzer is corrected for the cable insertion loss and any other applicable losses. A fully charged battery was used as a power supply voltage, except for the Transmitter RF Carrier Frequency Stability test a dummy battery connected to a power supply was used.

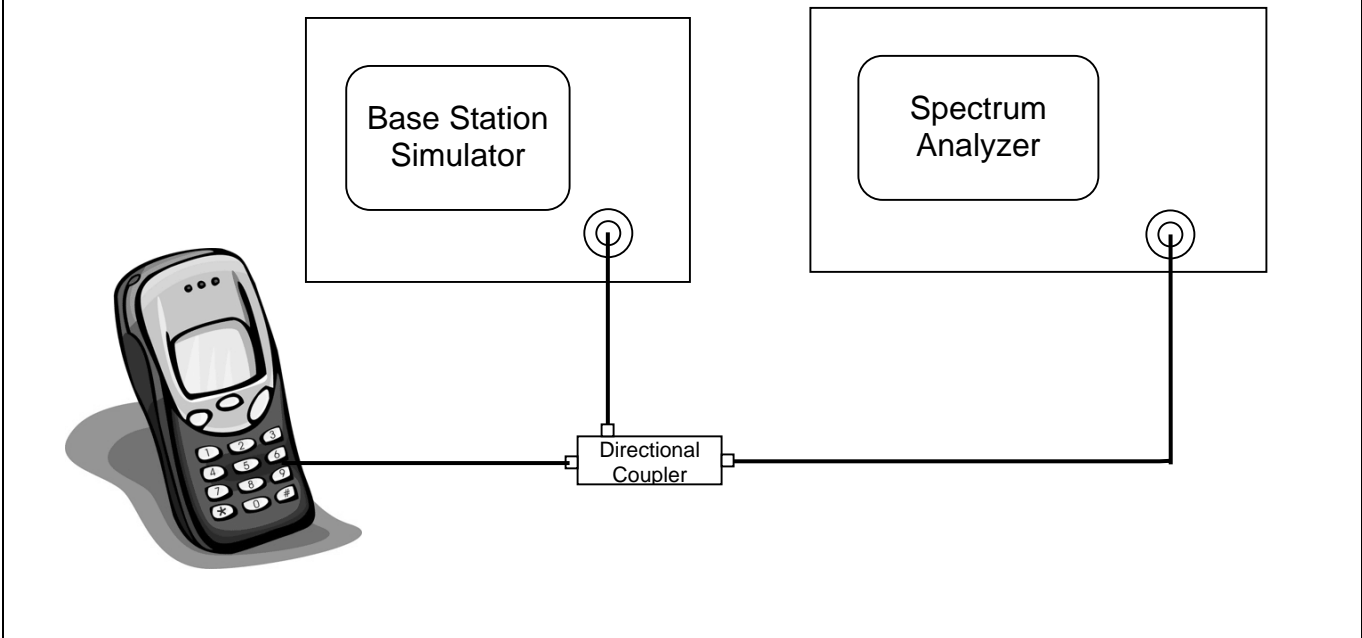

|            |                        |
|------------|------------------------|
| Applicant: | Kyocera                |
| FCC ID:    | V65E4100               |
| Report #:  | CT-E4100-22_24-0810-R1 |

## 4.1 Test Configuration

To justify on the selection of applicable configurations, the EUT was pre-tested under all Radio Configuration and Service Option operation modes to determine the worst-case scenario.

The following configuration was determined and reported as worst-case for all measurements:

|                      |                  |
|----------------------|------------------|
| Radio Configuration: | <b>RC1</b>       |
| Service Options:     | <b>SO55</b>      |
| Data Rate:           | <b>Full Rate</b> |

| CONFIGURATION                     | CONDUCTED POWER (dBm) |              |              |              |              |              |
|-----------------------------------|-----------------------|--------------|--------------|--------------|--------------|--------------|
|                                   | CDMA 800              |              |              | CDMA 1900    |              |              |
|                                   | Ch 1013               | Ch 383       | Ch 777       | Ch 25        | Ch 600       | Ch 1175      |
|                                   | Peak                  | Peak         | Peak         | Peak         | Peak         | Peak         |
| SO2, RC1 Full Rate                | 29.50                 | 29.72        | 29.31        | 29.31        | 28.89        | 29.05        |
| SO2, RC3 Full Rate                | 29.49                 | 29.38        | 29.42        | 29.05        | 28.66        | 28.89        |
| SO55, RC1 Full Rate               | <b>29.50</b>          | <b>29.87</b> | <b>29.53</b> | <b>29.37</b> | <b>28.92</b> | <b>29.54</b> |
| SO55, RC3 Full Rate               | 29.27                 | 29.34        | 29.21        | 29.24        | 28.92        | 29.01        |
| TDSO SO32, RC3 (+SCH) Full Rate   | 29.19                 | 29.74        | 29.09        | 29.04        | 28.66        | 28.89        |
| TDSO SO32, RC3 (+F-SCH) Full Rate | 29.00                 | 29.43        | 28.98        | 28.94        | 28.57        | 28.80        |

| CONFIGURATION                     | CONDUCTED POWER (dBm) |              |              |              |              |              |
|-----------------------------------|-----------------------|--------------|--------------|--------------|--------------|--------------|
|                                   | CDMA 800              |              |              | CDMA 1900    |              |              |
|                                   | Ch 1013               | Ch 383       | Ch 777       | Ch 25        | Ch 600       | Ch 1175      |
|                                   | Avg                   | Avg          | Avg          | Avg          | Avg          | Avg          |
| SO2, RC1 Full Rate                | 25.14                 | 25.05        | 24.95        | 25.28        | 25.19        | 25.35        |
| SO2, RC3 Full Rate                | 25.13                 | 25.00        | 24.96        | 25.24        | 25.16        | 25.30        |
| SO55, RC1 Full Rate               | 25.10                 | 25.05        | 24.89        | 25.26        | 25.17        | 25.27        |
| SO55, RC3 Full Rate               | <b>25.14</b>          | <b>25.06</b> | <b>24.97</b> | <b>25.29</b> | <b>25.20</b> | <b>25.30</b> |
| TDSO SO32, RC3 (+SCH) Full Rate   | 25.14                 | 25.02        | 24.95        | 25.24        | 25.15        | 25.30        |
| TDSO SO32, RC3 (+F-SCH) Full Rate | 25.14                 | 25.04        | 24.96        | 25.22        | 25.16        | 25.30        |

|            |                        |
|------------|------------------------|
| Applicant: | Kyocera                |
| FCC ID:    | V65E4100               |
| Report #:  | CT-E4100-22_24-0810-R1 |

## 5 TTY COMPLIANCE

**FCC:** § 255 of the Telecom Act

The EUT has been designed for TTY Compliance with Cellular Compatibility Standard.

## 6 CONDUCTED RF OUTPUT POWER

### 6.1 Test Configuration

**FCC:** § 2.1046

**IC:** RSS132 §4.4; RSS133 §6.4

The EUT was connected to a Universal Power Meter through a RF cable. The cable loss was taken into account for accurate power measurement. The EUT was set at low, mid, high channels and each frequency band to investigate the conducted power.

### 6.2 Test Results

| Mode      | Frequency (MHz) | Channel | Conducted Power (dBm) |
|-----------|-----------------|---------|-----------------------|
| CDMA 800  | 824.70          | 1013    | 25.14                 |
|           | 836.52          | 383     | 25.06                 |
|           | 848.31          | 777     | 24.97                 |
| CDMA 1900 | 1851.25         | 25      | 25.29                 |
|           | 1880            | 600     | 25.20                 |
|           | 1908.75         | 1175    | 25.30                 |

|            |                        |
|------------|------------------------|
| Applicant: | Kyocera                |
| FCC ID:    | V65E4100               |
| Report #:  | CT-E4100-22_24-0810-R1 |

## 7 RADIATED RF OUTPUT POWER

### 7.1 Test Configuration

**FCC:** § 22.913, § 24.232

**IC:** RSS132 §4.4; RSS133 §6.4

The test was performed in Compliance Certification Service using substitution method. See separated radiated emission report for details.

### 7.2 Test Results

| Mode      | Frequency (MHz) | Channel | Maximum Radiated Power (dBm) |
|-----------|-----------------|---------|------------------------------|
| CDMA 800  | 824.70          | 1013    | 28.4                         |
|           | 836.52          | 383     | 28.4                         |
|           | 848.31          | 777     | 27.5                         |
| CDMA 1900 | 1851.25         | 25      | 29.8                         |
|           | 1880            | 600     | 31.0                         |
|           | 1908.75         | 1175    | 30.3                         |



|            |                        |
|------------|------------------------|
| Applicant: | Kyocera                |
| FCC ID:    | V65E4100               |
| Report #:  | CT-E4100-22_24-0810-R1 |

## 8 OCCUPIED BANDWIDTH

### 8.1 Test Configuration

**FCC:** § 2.1049, § 22.917(b)(d), § 24.238, § 27.53(g)(1)

**IC:** RSS132 §4.5; RSS133 §6.5

The RF output of the EUT was connected to the input of the spectrum analyzer (S.A.) with sufficient attenuation. The spectrum with no modulation was recorded.

For Digital: Modulate with full rate all up power control bit.

| S.A. Setting          | RBW    | VBW    |
|-----------------------|--------|--------|
| Bandwidth Measurement | 30KHz  | 300kHz |
| Band Edge Measurement | 100KHz | 100KHz |

**Limits:** Bandwidth: N/A  
 Bandedge: -13dBm

### 8.2 Test Result

| Figure | Description               | Mode             | Result |
|--------|---------------------------|------------------|--------|
| 8-1    | CDMA @ Ch383              | <b>CDMA 800</b>  | Pass   |
| 8-2    | Lower Band Edge @ Ch 1013 |                  | Pass   |
| 8-3    | Upper Band Edge @ Ch 777  |                  | Pass   |
| 8-4    | CDMA @ CH600              | <b>CDMA 1900</b> | Pass   |
| 8-5    | Lower Band Edge @ CH 25   |                  | Pass   |
| 8-6    | Upper Band Edge @ CH 1175 |                  | Pass   |



|            |                        |
|------------|------------------------|
| Applicant: | Kyocera                |
| FCC ID:    | V65E4100               |
| Report #:  | CT-E4100-22_24-0810-R1 |

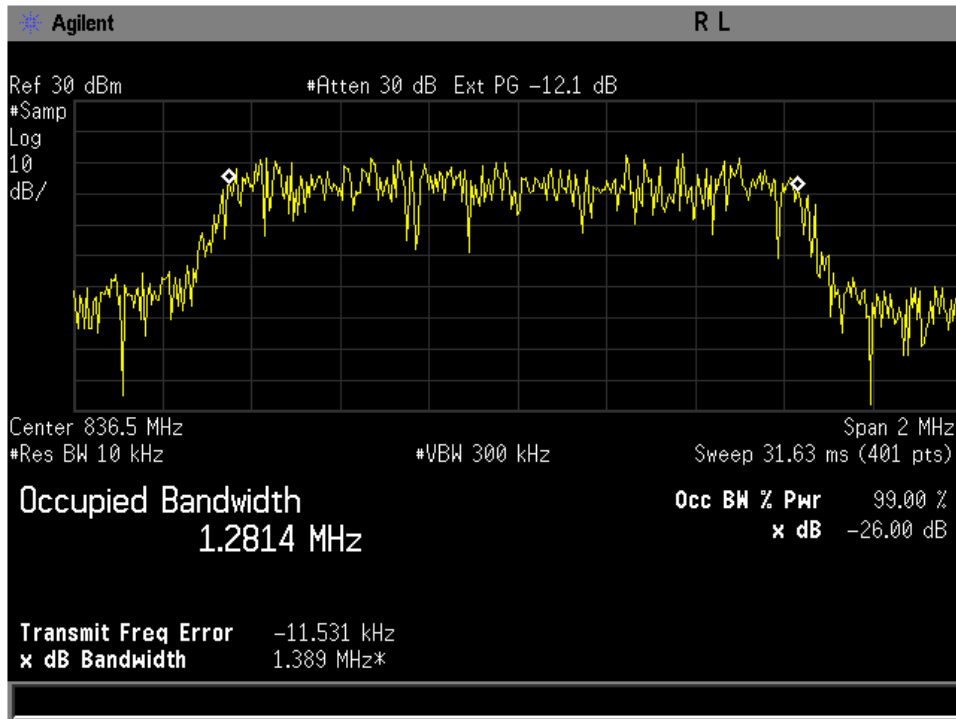
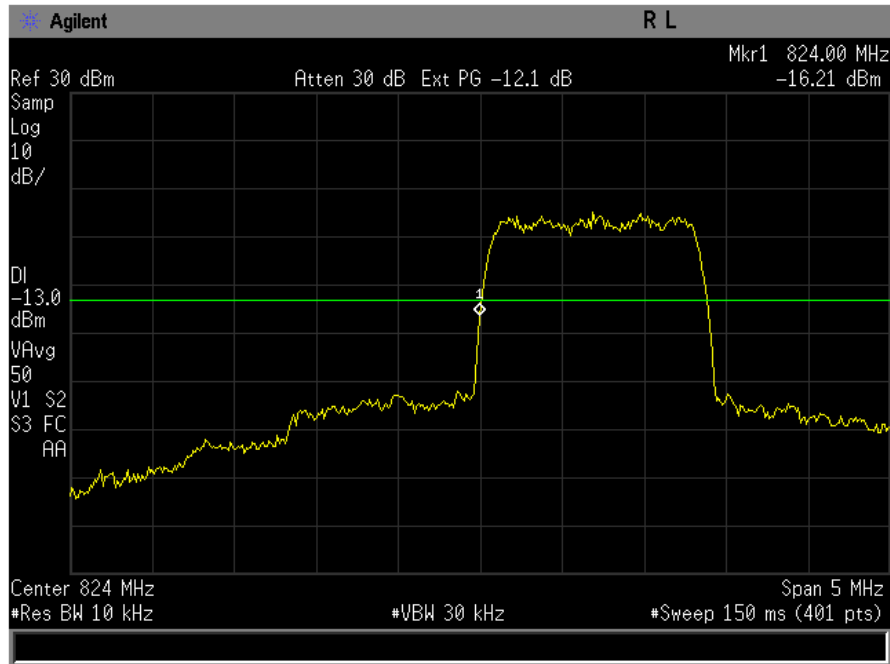
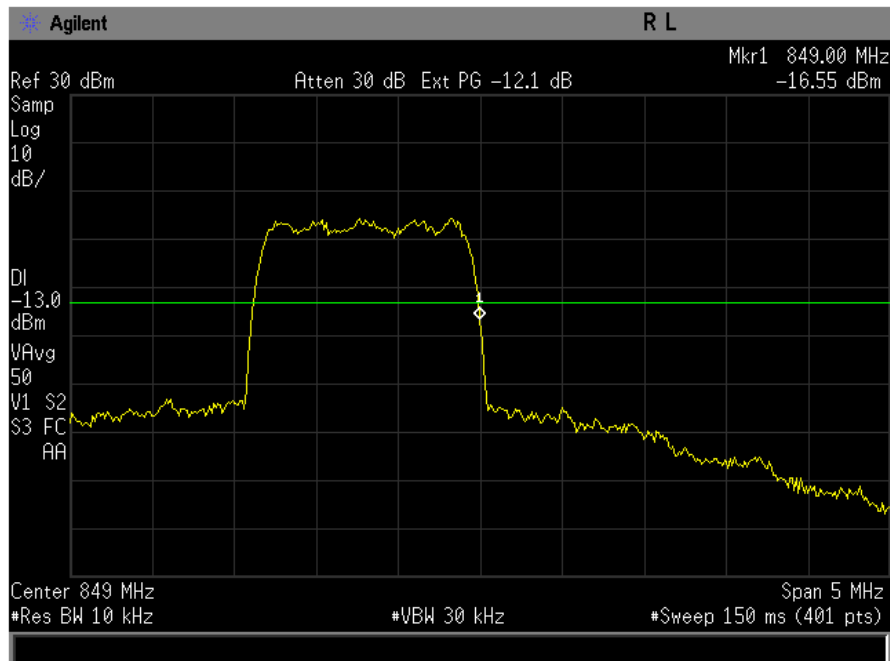

Figure 8-1 CDMA 800 @ CH 383

|            |                        |
|------------|------------------------|
| Applicant: | Kyocera                |
| FCC ID:    | V65E4100               |
| Report #:  | CT-E4100-22_24-0810-R1 |



**Figure 8-2 CDMA 800 Lower Band Edge @ CH 1013**



**Figure 8-3 CDMA 800 Lower Band Edge @ CH 777**



|            |                        |
|------------|------------------------|
| Applicant: | Kyocera                |
| FCC ID:    | V65E4100               |
| Report #:  | CT-E4100-22_24-0810-R1 |

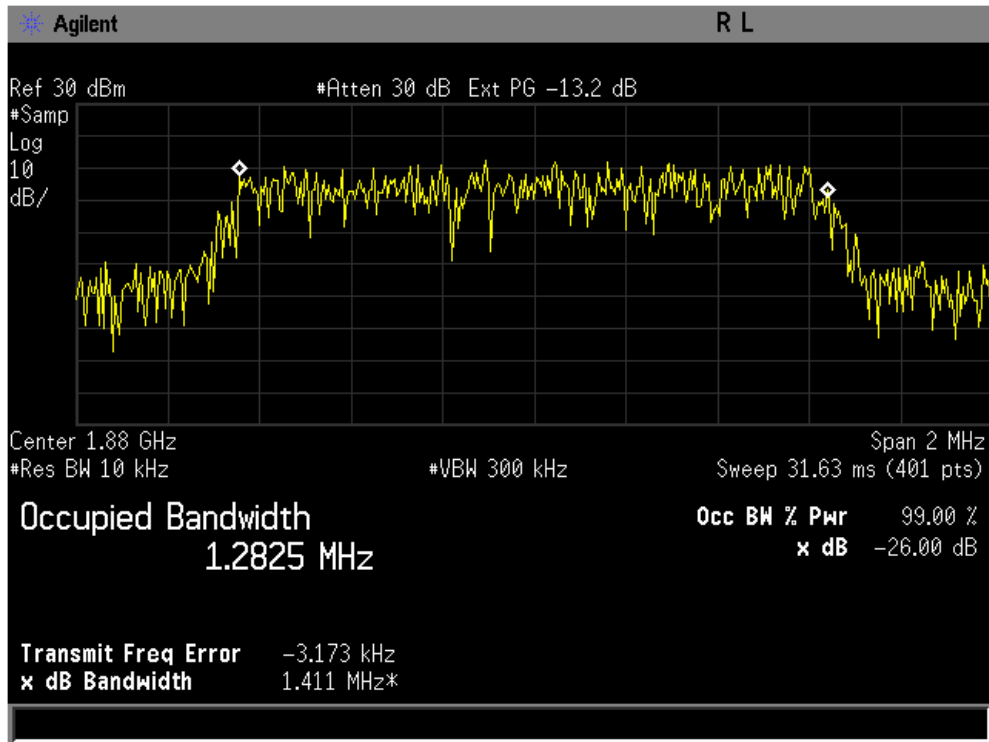

Figure 8-4 CDMA 1900 @ CH 600



|            |                        |
|------------|------------------------|
| Applicant: | Kyocera                |
| FCC ID:    | V65E4100               |
| Report #:  | CT-E4100-22_24-0810-R1 |

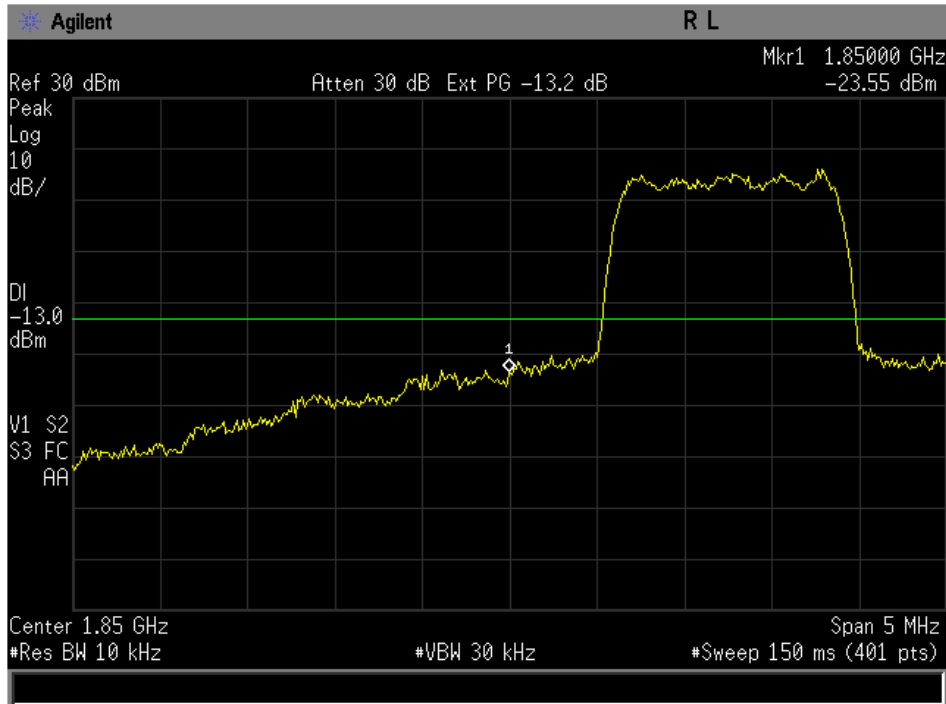

Figure 8-5 CDMA 1900 Lower Band Edge @ CH 25

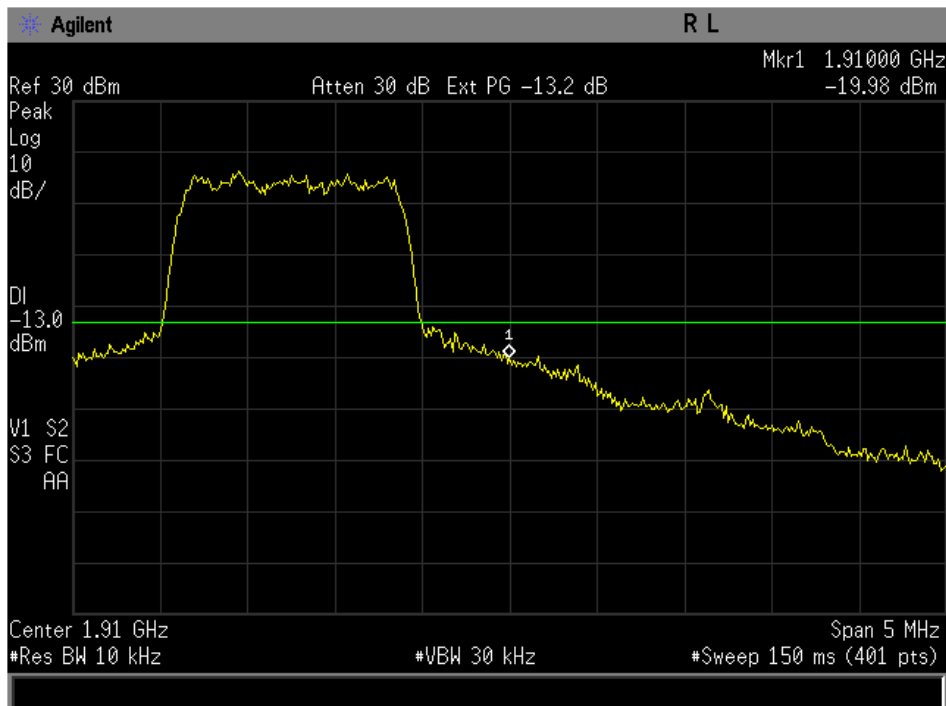

Figure 8-6 CDMA 1900 Upper Band Edge @ CH 1175

## 9 SPURIOUS EMISSIONS AT ANTENNA TERMINALS

### 9.1 Test Configuration

**FCC:** § 2.1051, § 22.917(e)(f), § 24.238

**IC:** RSS132 §4.5; RSS133 §6.5

**Measurement Procedures:**

Out of Band: The RF output of the EUT was connected to the input of the spectrum analyzer with sufficient attenuation. The modulating signal was applied accordingly. The frequency spectrum was investigated from the lowest frequency signal generated up to at least the tenth harmonic of the fundamental.

| S.A. Setting                   | RBW  | VBW  |
|--------------------------------|------|------|
| Spurious Emissions Measurement | 1MHz | 1MHz |

**Limits:** -13dBm

### 9.2 Test Result

| Figure | Channel | Plot Description  | Result |
|--------|---------|---|--------|
| 9-1    | 1013    | CDMA 800 Conducted spurious emissions<br>9kHz to 10GHz  | Pass   |
| 9-2    | 383     |   | Pass   |
| 9-3    | 777     |   | Pass   |
| 9-4    | 25      | CDMA 1900 Conducted spurious emissions<br>9kHz to 20GHz | Pass   |
| 9-5    | 600     |   | Pass   |
| 9-6    | 1175    |   | Pass   |



|            |                        |
|------------|------------------------|
| Applicant: | Kyocera                |
| FCC ID:    | V65E4100               |
| Report #:  | CT-E4100-22_24-0810-R1 |

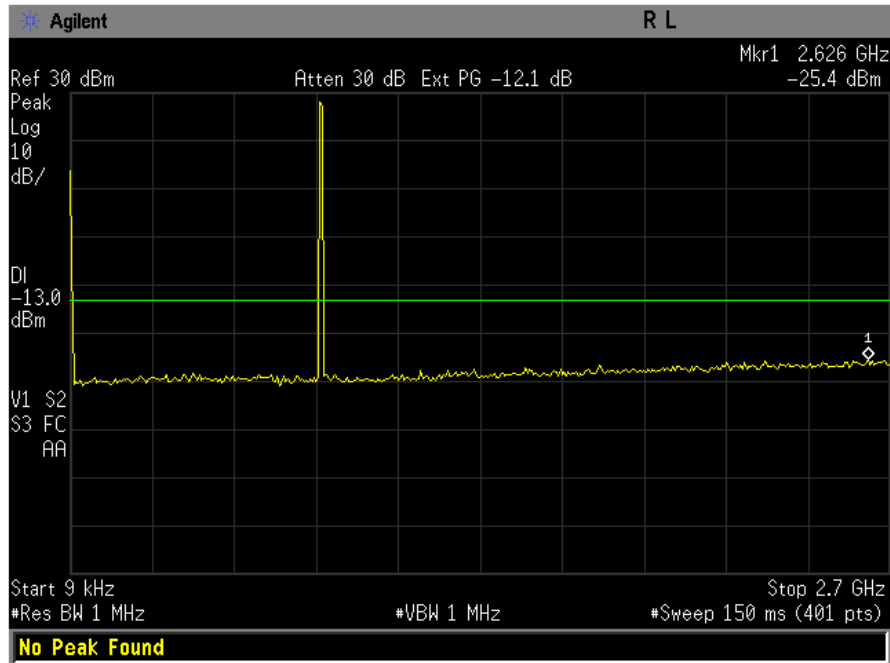

**Figure 9-1a CDMA 800 – Conducted Spurious Emission (CH 1013)**

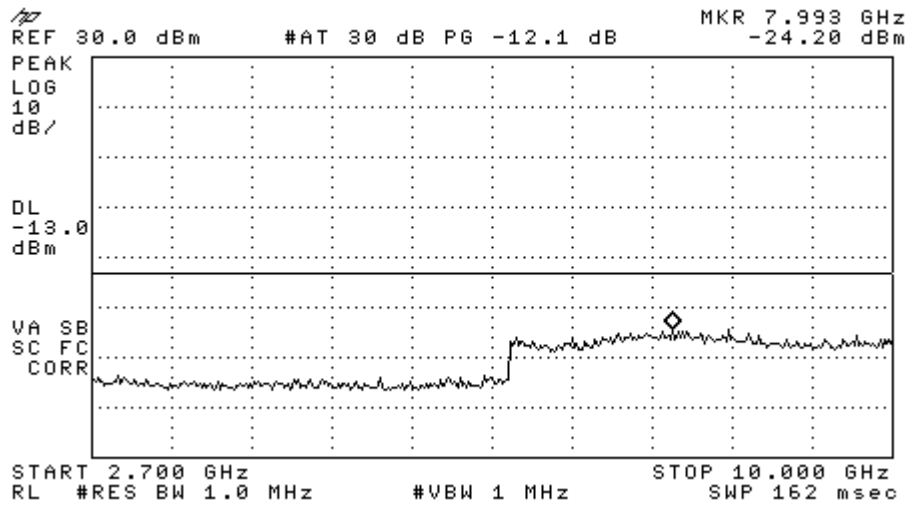

**Figure 9-1b CDMA 800 – Conducted Spurious Emission (CH 1013)**



|            |                        |
|------------|------------------------|
| Applicant: | Kyocera                |
| FCC ID:    | V65E4100               |
| Report #:  | CT-E4100-22_24-0810-R1 |

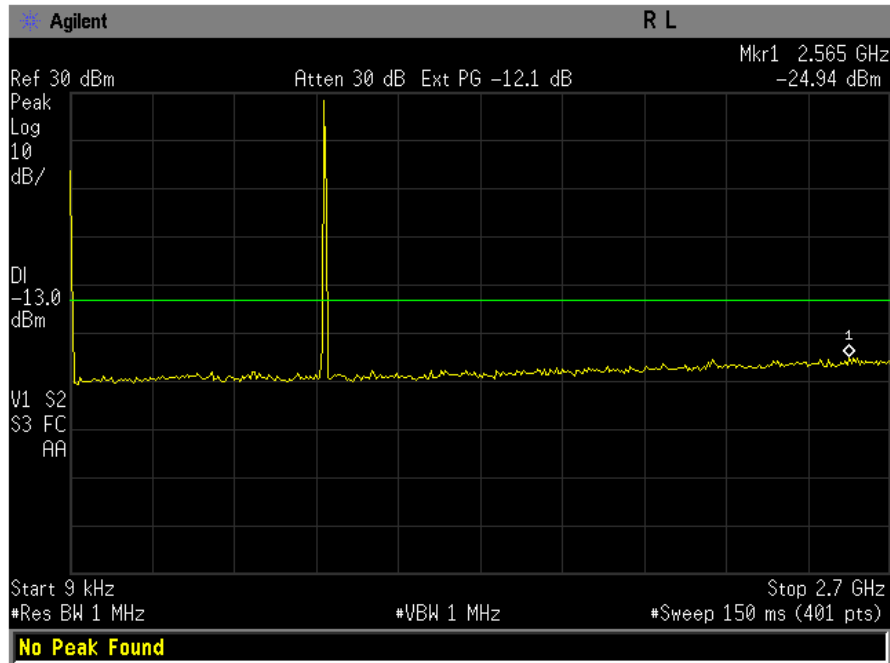

**Figure 9-2a CDMA 800 – Conducted Spurious Emission (CH 383)**

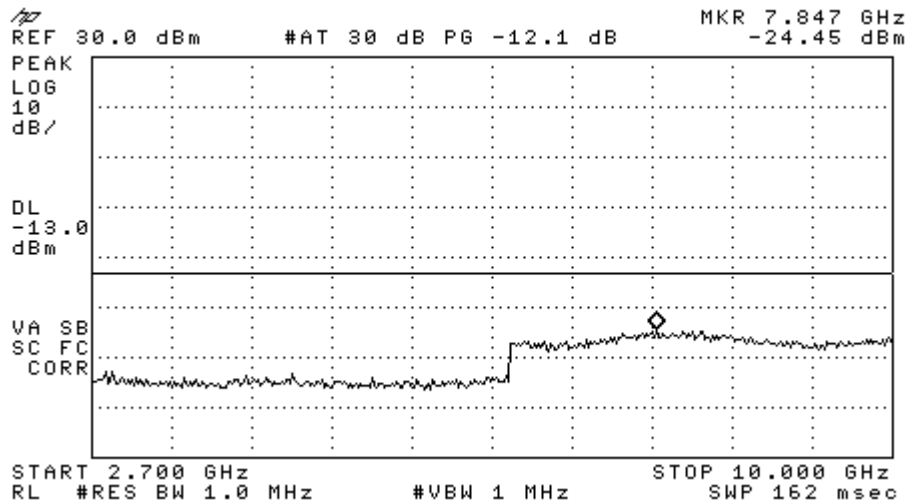
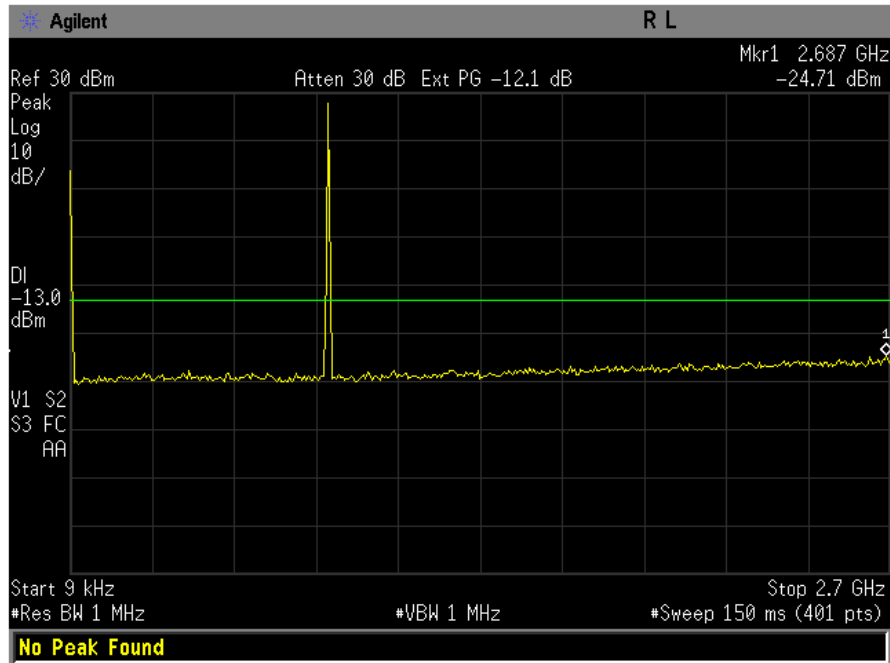

**Figure 9-2b CDMA 800 – Conducted Spurious Emission (CH 383)**





|            |                        |
|------------|------------------------|
| Applicant: | Kyocera                |
| FCC ID:    | V65E4100               |
| Report #:  | CT-E4100-22_24-0810-R1 |



**Figure 9-3a CDMA 800 – Conducted Spurious Emission (CH 777)**

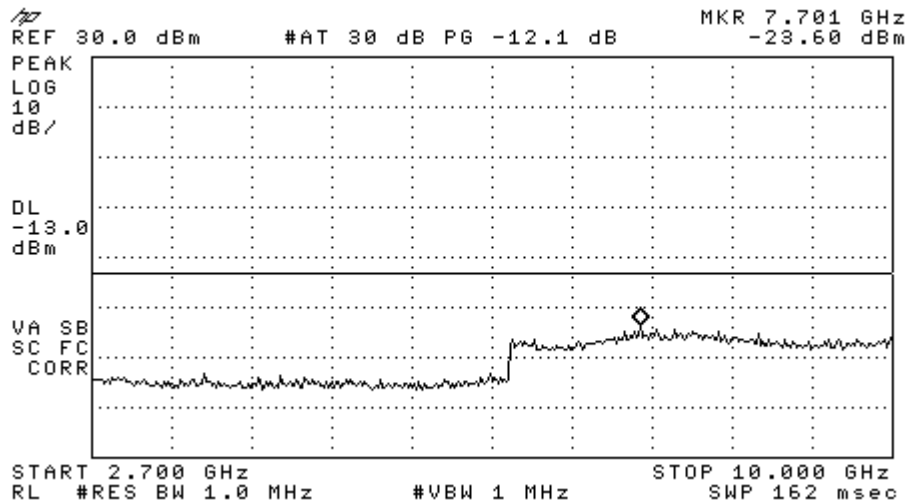

**Figure 9-3b CDMA 800 – Conducted Spurious Emission (CH 777)**



|            |                        |
|------------|------------------------|
| Applicant: | Kyocera                |
| FCC ID:    | V65E4100               |
| Report #:  | CT-E4100-22_24-0810-R1 |

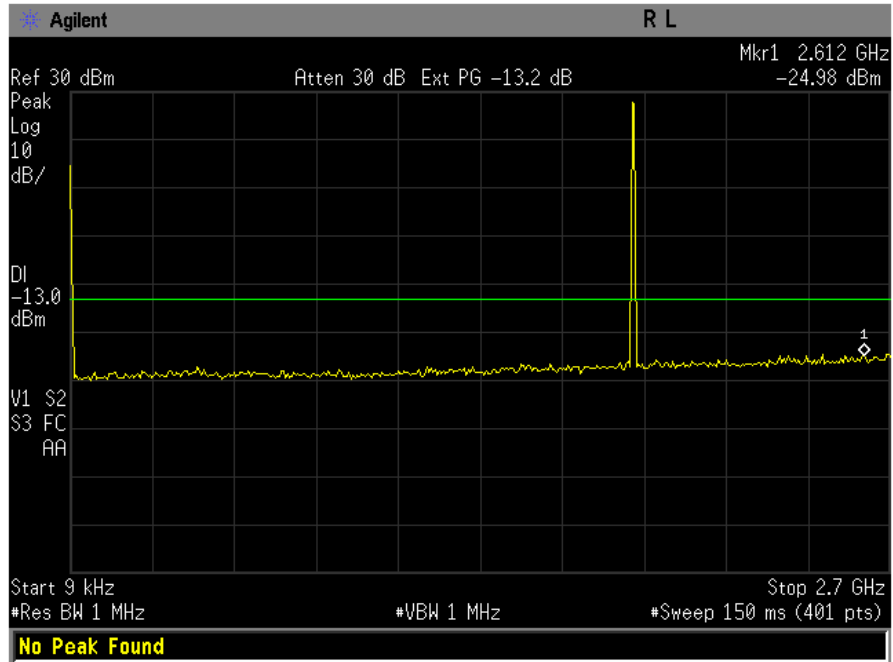

Figure 9-4a CDMA 1900 - Conducted Spurious Emission (CH 25)

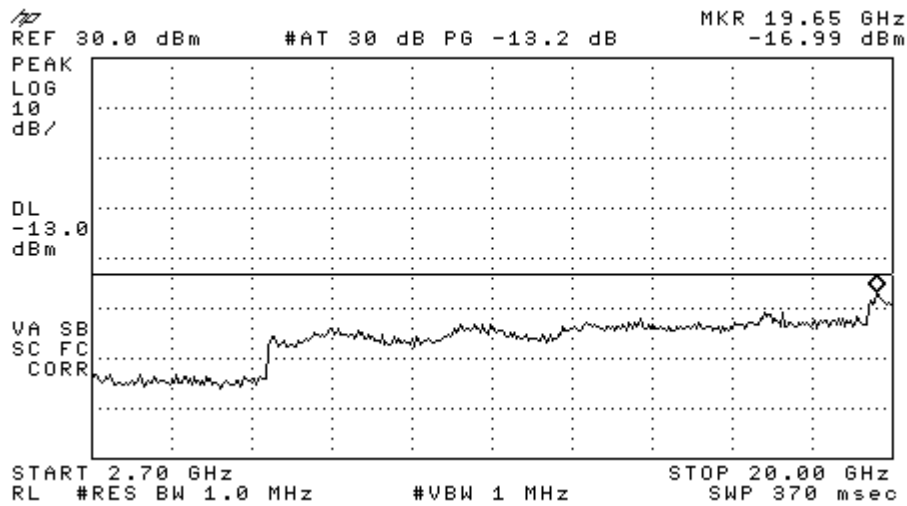

Figure 9-4b CDMA 1900 - Conducted Spurious Emission (CH 25)



|            |                        |
|------------|------------------------|
| Applicant: | Kyocera                |
| FCC ID:    | V65E4100               |
| Report #:  | CT-E4100-22_24-0810-R1 |

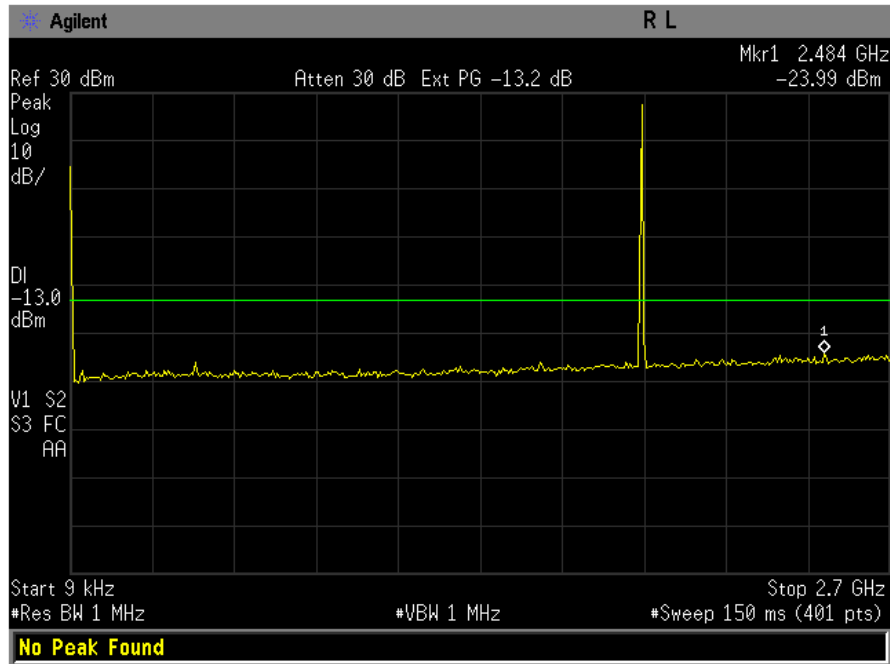

Figure 9-5a CDMA 1900 - Conducted Spurious Emission (CH 600)

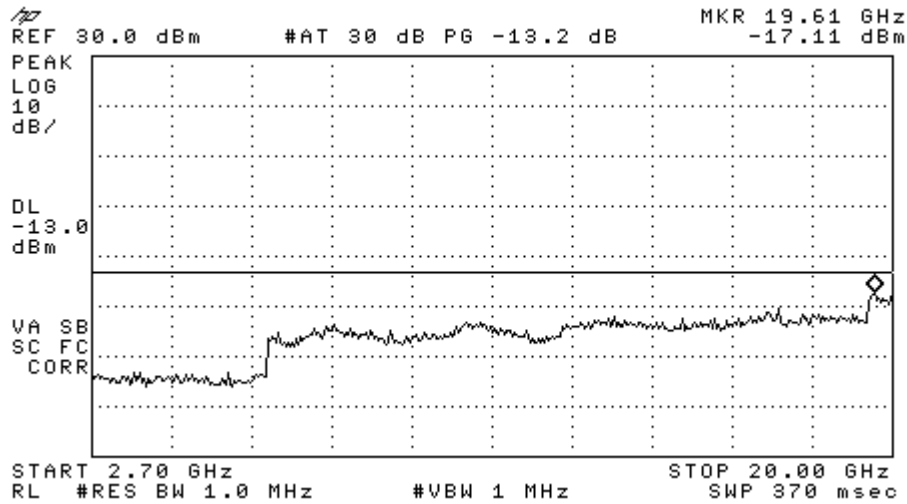
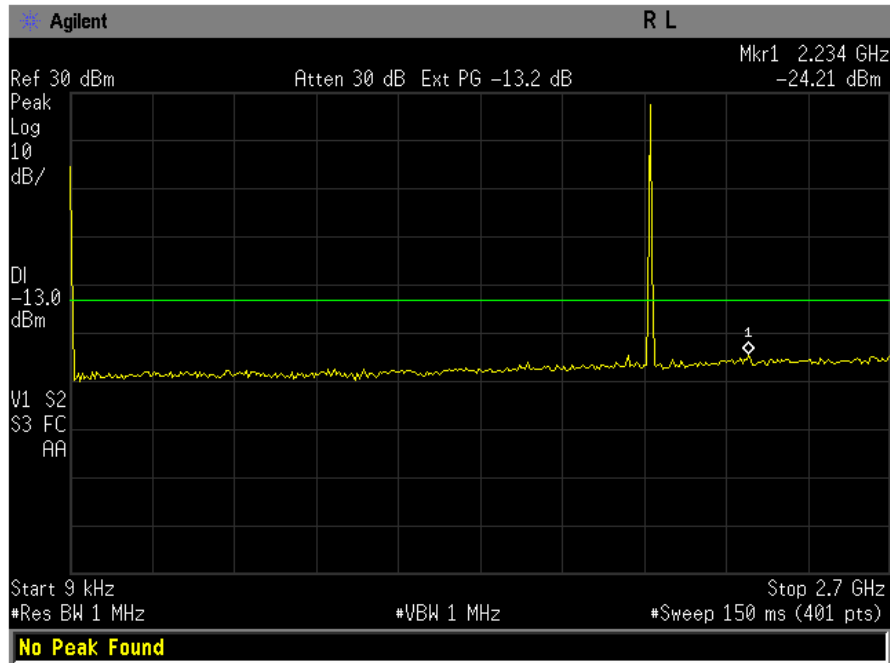

Figure 9-5b CDMA 1900 - Conducted Spurious Emission (CH 600)



|            |                        |
|------------|------------------------|
| Applicant: | Kyocera                |
| FCC ID:    | V65E4100               |
| Report #:  | CT-E4100-22_24-0810-R1 |



**Figure 9-6a CDMA 1900 - Conducted Spurious Emission (CH 1175)**

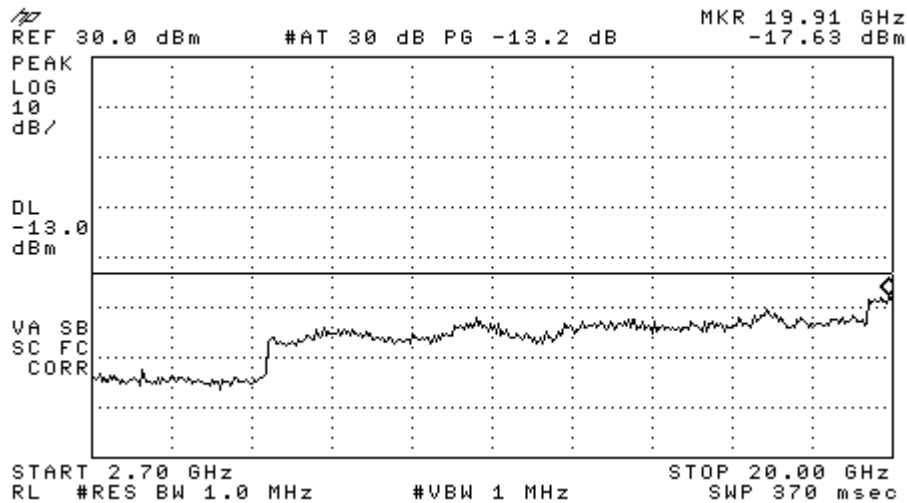

**Figure 9-6b CDMA 1900 - Conducted Spurious Emission (CH 1175)**

|            |                        |
|------------|------------------------|
| Applicant: | Kyocera                |
| FCC ID:    | V65E4100               |
| Report #:  | CT-E4100-22_24-0810-R1 |

## 10 TRANSMITTER RADIATED SPURIOUS EMISSIONS

**FCC:** § 2.1053, § 22.91, § 24.238, §27.53(g)

**IC:** RSS132 §4.5; RSS133 §6.5

The radiated spurious emission test was performed at Compliance Certification Service. The test report is attached in a separate attachment.

### 10.1 Test Configuration and Result

## 11 RECEIVER SPURIOUS EMISSIONS

### 11.1 Receiver Spurious Emissions

**FCC:** § 15.109

**IC:** RSS-GEN

The receiver radiated spurious emission test was performed at Compliance Certification Service. The test report is attached in a separate attachment.

|            |                        |
|------------|------------------------|
| Applicant: | Kyocera                |
| FCC ID:    | V65E4100               |
| Report #:  | CT-E4100-22_24-0810-R1 |

## 12 TRANSMITTER RF CARRIER FREQUENCY STABILITY

### 12.1 Test Configuration

**FCC:** § 2.1055, § 22.355, § 24.235, § 27.54

**IC:** RSS132 §4.3; RSS133 §6.3

The EUT was placed in an environmental chamber. The RF output of the EUT was connected to Agilent 8960 Series 10 E5515C. A power supplier was connected as primary voltage supply. Only the mid channel of each frequency band was investigated.

**Limits:**

| Tx Frequency | Channel | Limit                     |
|--------------|---------|---------------------------|
| 836.49 MHz   | 383     | +/- 2.5 ppm (+/- 2091 Hz) |
| 1880 MHz     | 600     | +/- 2.5 ppm (+/-4700 Hz)  |

|            |                        |
|------------|------------------------|
| Applicant: | Kyocera                |
| FCC ID:    | V65E4100               |
| Report #:  | CT-E4100-22_24-0810-R1 |

## 12.2 Test Result

| CDMA 800         |                           |              |              |                    |             |        |
|------------------|---------------------------|--------------|--------------|--------------------|-------------|--------|
| Temperature (°C) | Deviation of Carrier (Hz) |              |              | Specification (Hz) |             | Result |
|                  | 3.3V (Battery endpoint)   | 3.7V         | 4.2V (115%)  | Lower limit        | Upper limit |        |
| -30              |                           | -6.31        |              | -2091              | 2091        | Pass   |
| -20              |                           | 6.83         |              | -2091              | 2091        |        |
| -10              |                           | 7.46         |              | -2091              | 2091        |        |
| 0                |                           | -5.52        |              | -2091              | 2091        |        |
| 10               |                           | -4.72        |              | -2091              | 2091        |        |
| 20               | <b>-5.62</b>              | <b>-5.42</b> | <b>-7.09</b> | -2091              | 2091        |        |
| 30               |                           | 4.69         |              | -2091              | 2091        |        |
| 40               |                           | -5.52        |              | -2091              | 2091        |        |
| 50               |                           | -6.08        |              | -2091              | 2091        |        |
| 60               |                           | -9.37        |              | -2091              | 2091        |        |

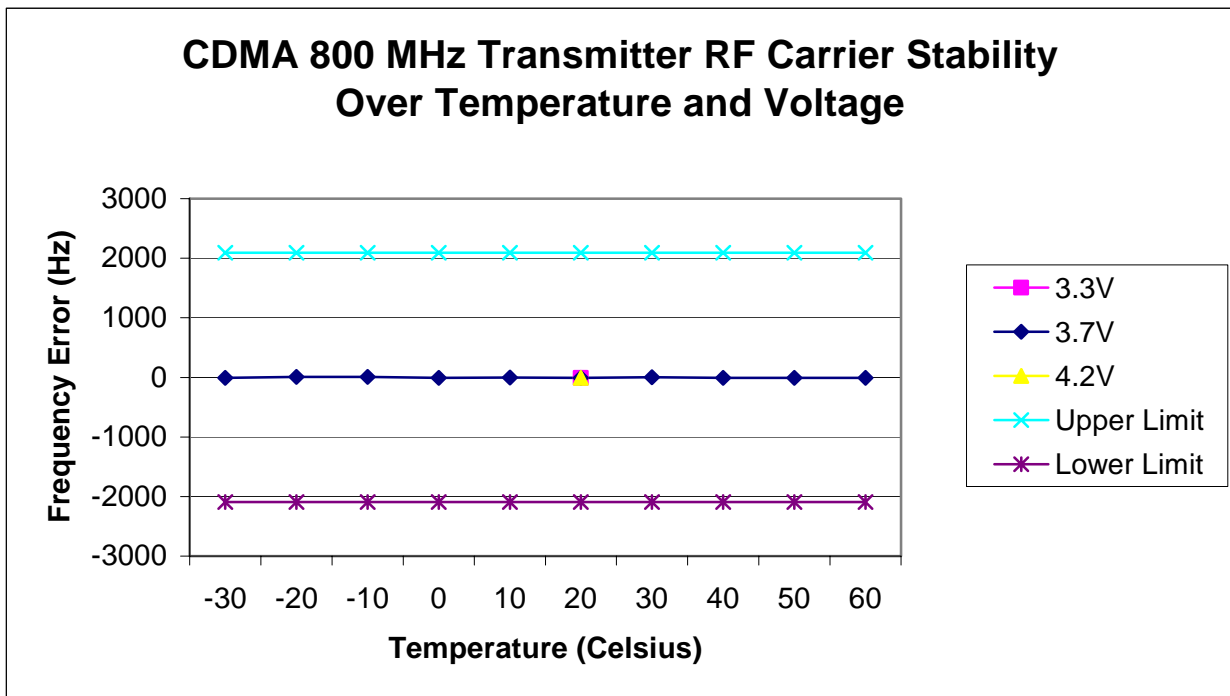



|            |                        |
|------------|------------------------|
| Applicant: | Kyocera                |
| FCC ID:    | V65E4100               |
| Report #:  | CT-E4100-22_24-0810-R1 |

| CDMA 1900        |                           |        |             |                    |             |        |
|------------------|---------------------------|--------|-------------|--------------------|-------------|--------|
| Temperature (°C) | Deviation of Carrier (Hz) |        |             | Specification (Hz) |             | Result |
|                  | 3.3V (Battery endpoint)   | 3.7V   | 4.2V (115%) | Lower limit        | Upper limit |        |
| -30              |                           | -6.66  |             | -4700              | 4700        | Pass   |
| -20              |                           | -6.47  |             | -4700              | 4700        |        |
| -10              |                           | 6.29   |             | -4700              | 4700        |        |
| 0                |                           | -6.98  |             | -4700              | 4700        |        |
| 10               |                           | -6.29  |             | -4700              | 4700        |        |
| 20               | -7.53                     | 8.22   | -9.37       | -4700              | 4700        |        |
| 30               |                           | -7.2   |             | -4700              | 4700        |        |
| 40               |                           | -7.77  |             | -4700              | 4700        |        |
| 50               |                           | -13.57 |             | -4700              | 4700        |        |
| 60               |                           | -5.25  |             | -4700              | 4700        |        |

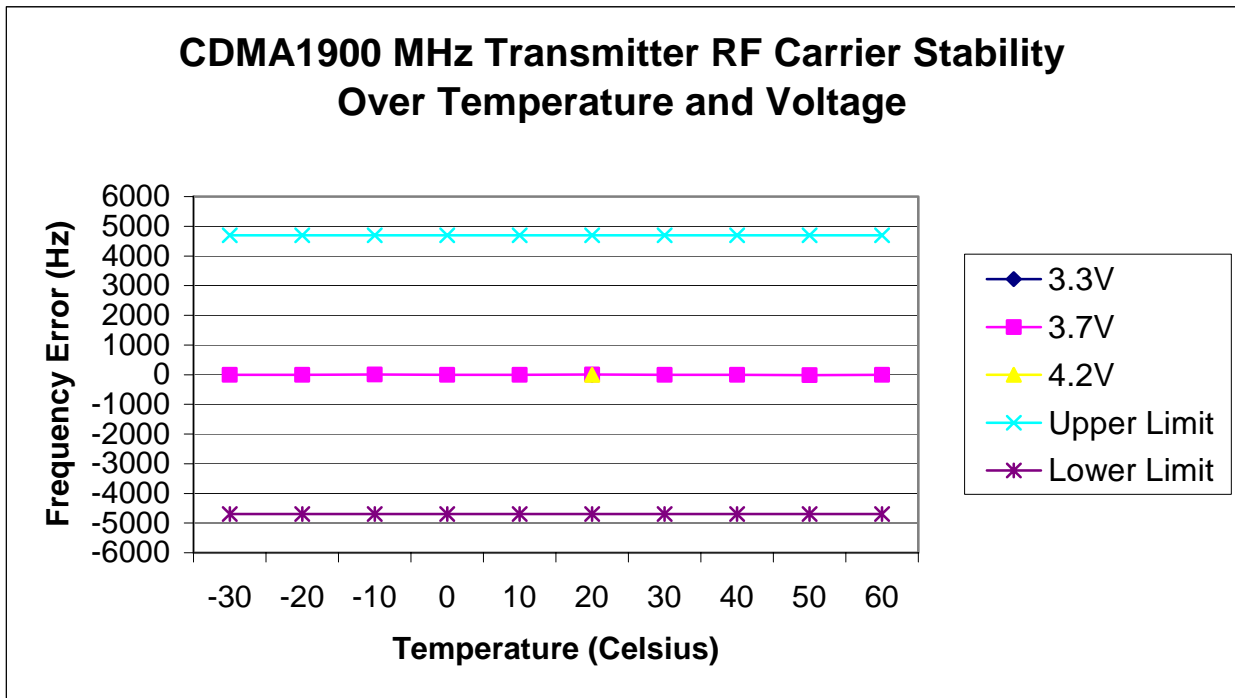



|            |                        |
|------------|------------------------|
| Applicant: | Kyocera                |
| FCC ID:    | V65E4100               |
| Report #:  | CT-E4100-22_24-0810-R1 |

## 13 EXPOSURE OF HUMANS TO RF FIELDS (SAR)

### 13.1 Test Configuration and Result

**FCC: § 2.1093**

**IC: RSS102**

The SAR test report is attached in a separate attachment.

## 14 TEST EQUIPMENT

The test equipment utilized to perform the tests documented in this report has been calibrated in accordance with the manufacturer's recommendations and is traceable to recognized national standards.

| Description                      | Manufacturer    | Model No.        | Serial No. | Cal Due Date |
|----------------------------------|-----------------|------------------|------------|--------------|
| Power Meter                      | Giga-tronics    | 8541C            | 1831306    | 03/29/11     |
| Spectrum Analyzer                | Agilent         | E4405B           | US41441217 | 05/26/12     |
| Spectrum Analyzer                | Hewlett Packard | 8593EM           | 3710A00203 | 06/09/12     |
| Wireless Communications Test Set | Agilent         | 8960             | GB44052789 | 08/17/11     |
| Temperature Chamber              | Test Equity     | ZH2-033-033-H/AC | ZZ9622421  | 06/03/11     |