

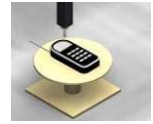

PCTEST ENGINEERING LABORATORY, INC.

7185 Oakland Mills Road, Columbia, MD 21046 USA
Tel. 410.290.6652 / Fax 410.290.6654
http://www.pctestlab.com



HEARING AID COMPATIBILITY

Applicant Name:
Kyocera Corporation
9520 Towne Centre Drive, Suite 200
San Diego, CA
United States, 92121

Date of Testing:
09/14/2015 - 09/15/2015
Test Site/Location:
PCTEST Lab, Columbia, MD, USA
Test Report Serial No.:
0Y1509141776-R1.V65

FCC ID: V65CD8100
APPLICANT: KYOCERA CORPORATION

Scope of Test: Audio Band Magnetic Testing (T-Coil)
Application Type: Certification
FCC Rule Part(s): CFR § 20.19(b)
HAC Standard: ANSI C63.19-2011
EUT Type: Portable Handset
Model(s): CD8100
Test Device Serial No.: Pre-Production Sample [S/N: 16275]

C63.19-2011 HAC Category: T4 (SIGNAL TO NOISE CATEGORY)

This revised Test Report (S/N: 0Y1509141776-R1.V65) supersedes and replaces the previously issued test report on the same subject device for the same type of testing as indicated. Please discard or destroy the previously issued test report(s) and dispose of it accordingly.

This wireless portable device has been shown to be hearing-aid compatible under the above rated category, specified in ANSI/IEEE Std. C63.19-2011 and has been tested in accordance with the specified measurement procedures. Hearing-Aid Compatibility is based on the assumption that all production units will be designed electrically identical to the device tested in this report. Test results reported herein relate only to the item(s) tested. For North American bands only.

I attest to the accuracy of data. All measurements reported herein were performed by me or were made under my supervision and are correct to the best of my knowledge and belief. I assume full responsibility for the completeness of these measurements and vouch for the qualifications of all persons taking them.

Randy Ortanez
President







FCC ID: V65CD8100		HAC (T-COIL) TEST REPORT		Reviewed by: Quality Manager
Filename: 0Y1509141776-R1.V65	Test Dates: 09/14/2015 - 09/15/2015	EUT Type: Portable Handset	Page 1 of 37	

TABLE OF CONTENTS

1.	INTRODUCTION	3
2.	TEST SITE LOCATION	4
3.	EUT DESCRIPTION	5
4.	ANSI C63.19-2011 PERFORMANCE CATEGORIES	6
5.	METHOD OF MEASUREMENT	8
6.	FCC 3G MEASUREMENTS	18
7.	TEST SUMMARY	19
8.	MEASUREMENT UNCERTAINTY	23
9.	EQUIPMENT LIST	24
10.	CALIBRATION CERTIFICATES.....	25
11.	CONCLUSION.....	32
12.	REFERENCES	33
13.	TEST SETUP PHOTOGRAPHS	35

FCC ID: V65CD8100	 <small>THE OFFICE OF DEVELOPMENT, INC.</small>	HAC (T-COIL) TEST REPORT		Reviewed by: Quality Manager
Filename: 0Y1509141776-R1.V65	Test Dates: 09/14/2015 - 09/15/2015	EUT Type: Portable Handset		Page 2 of 37

1. INTRODUCTION

On July 10, 2003, the Federal Communications Commission (FCC) adopted new rules requiring wireless manufacturers and service providers to provide digital wireless phones that are compatible with hearing aids. The FCC has modified the exemption for wireless phones under the Hearing Aid Compatibility Act of 1998 (HAC Act) in WT Docket 01-309 RM-8658¹ to extend the benefits of wireless telecommunications to individuals with hearing disabilities. These benefits encompass business, social and emergency communications, which increase the value of the wireless network for everyone. Approximately 500 million people worldwide and 30 million people in the United States suffer from hearing loss.

Compatibility Tests Involved:

The standard calls for wireless communications devices to be measured for:

- RF Electric-field emissions
- RF Magnetic-field emissions
- T-coil mode, magnetic-signal strength in the audio band
- T-coil mode, magnetic-signal frequency response through the audio band
- T-coil mode, magnetic-signal and noise articulation index

The hearing aid must be measured for:



- RF immunity in microphone mode
- RF immunity in T-coil mode

In the following tests and results, this report includes the evaluation for a wireless communications device.



Figure 1-1 Hearing Aid *in-vitu*

¹ FCC Rule & Order, WT Docket 01-309 RM-8658

FCC ID: V65CD8100	 PCTEST Engineering Laboratory, Inc.	HAC (T-COIL) TEST REPORT	 KYOCERA	Reviewed by: Quality Manager
Filename: 0Y1509141776-R1.V65	Test Dates: 09/14/2015 - 09/15/2015	EUT Type: Portable Handset	Page 3 of 37	

2. TEST SITE LOCATION



I. Introduction

The map at the right shows the location of the PCTEST LABORATORY in Columbia, Maryland. It is in proximity to the FCC Laboratory, the Baltimore-Washington International (BWI) airport, the city of Baltimore and Washington, DC (See Figure 2-1).

These measurement tests were conducted at the PCTEST Engineering Laboratory, Inc. facility in Stonewood Business Center, Guilford Industrial Park, Columbia, Maryland. The site address is 7185 Oakland Mills Road, Columbia, MD 21046. The test site is one of the highest points in the Columbia area with an elevation of 390 feet above mean sea level. The site coordinates are 39° 10' 24" N latitude and 76° 49' 50" W longitude. The facility is 0.4 miles North of the FCC laboratory, and the ambient signal and ambient signal strength are approximately equal to those of the FCC laboratory.



Figure 2-1
Map of the Greater Baltimore and Metropolitan Washington, D.C. area

FCC ID: V65CD8100		HAC (T-COIL) TEST REPORT		Reviewed by: Quality Manager
Filename: 0Y1509141776-R1.V65	Test Dates: 09/14/2015 - 09/15/2015	EUT Type: Portable Handset	Page 4 of 37	

3. EUT DESCRIPTION



FCC ID: V65CD8100
 Applicant: Kyocera Corporation
 9520 Towne Centre Drive, Suite 200
 San Diego, CA
 United States, 92121

Model(s): CD8100
 Serial Number: 16275
 HW Version: 0.700NL
 SW Version: 0101
 Antenna: Internal Antenna
 HAC Test Configurations: Cell. CDMA, 1013, 384, 777, BT Off, WLAN Off, LTE Off
 PCS CDMA, 25, 600, 1175, BT Off, WLAN Off, LTE Off
 EUT Type: Portable Handset

Air-Interface	Band (MHz)	Type Transport	HAC Tested	Simultaneous But Not Tested	Voice over Digital Transport OTT Capability	WIFI Low Power	Additional GSM Power Reduction
CDMA	835	VO	Yes	Yes: WIFI or BT	N/A	N/A	N/A
	1900						
	EVDO	DT	No	Yes: WIFI or BT	Yes	N/A	N/A
LTE (FDD)	780 (B13)	DT	No	Yes: WIFI or BT	Yes	N/A	N/A
	1700 (B4)						
WIFI	2450	DT	No	Yes: CDMA or LTE	Yes	N/A	N/A
BT	2450	DT	No	Yes: CDMA or LTE	N/A	N/A	N/A

Type Transport
 VO = Voice Only
 DT = Digital Data - Not intended for CMRS Service

Table 3: V65CD8100 HAC Air Interfaces

FCC ID: V65CD8100	PCTEST This office is in development, etc.	HAC (T-COIL) TEST REPORT		Reviewed by: Quality Manager
Filename: 0Y1509141776-R1.V65	Test Dates: 09/14/2015 - 09/15/2015	EUT Type: Portable Handset		Page 5 of 37

4. ANSI C63.19-2011 PERFORMANCE CATEGORIES

I. MAGNETIC COUPLING

Axial and Radial Field Intensity

All orientations of the magnetic field, in the axial, horizontal and vertical position along the measurement plane shall be ≥ -18 dB(A/m) at 1 kHz in a 1/3 octave band filter per §8.3.1.

Frequency Response

The frequency response of the axial component of the magnetic field shall follow the response curve specified in EIA RS-504-1983, over the frequency range 300 Hz – 3000 Hz per §8.3.2.

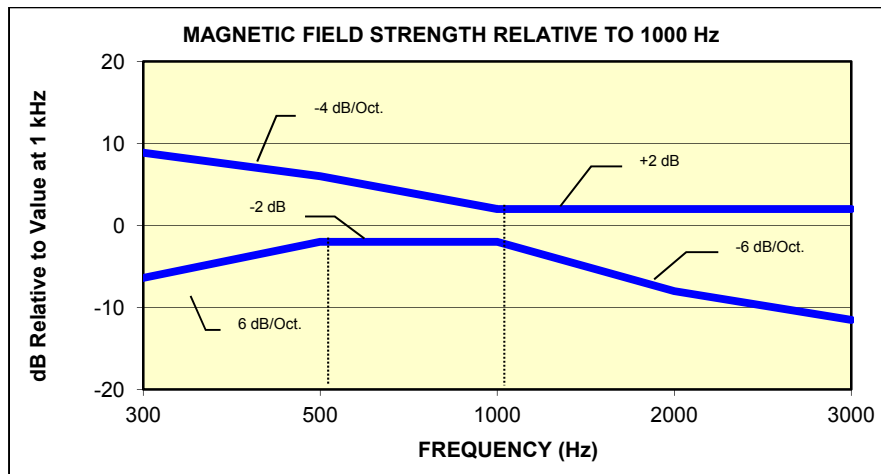

Figure 4-1
Magnetic field frequency response for Wireless Devices with an axial field ≤ -15 dB(A/m) at 1 kHz

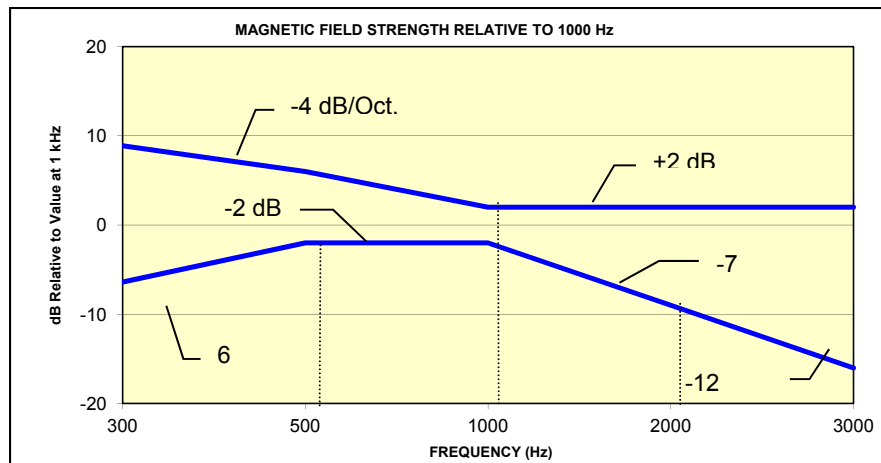



Figure 4-2
Magnetic Field frequency response for wireless devices with an axial field that exceeds -15 dB(A/m) at 1 kHz

FCC ID: V65CD8100	 PCTEST This office is a development, not a laboratory.	HAC (T-COIL) TEST REPORT	 KYOCERA	Reviewed by: Quality Manager
Filename: 0Y1509141776-R1.V65	Test Dates: 09/14/2015 - 09/15/2015	EUT Type: Portable Handset		Page 6 of 37



Signal Quality

The table below provides the signal quality requirement for the intended audio magnetic signal from a wireless device. Only the RF immunity of the hearing aid is measured in T-coil mode. It is assumed that a hearing aid can have no immunity to an interference signal in the audio band, which is the intended reception band for this mode. The only criterion that can be measured is the RF immunity in T-coil mode. This is measured using the same procedure as the audio coupling mode at the same levels.

The signal quality of the axial and radial components of the magnetic field was used to determine the T-coil mode category.

Category	Telephone RF Parameters
	Wireless Device Signal Quality (Signal + Noise-to-noise ratio in dB)
T1	0 to 10 dB
T2	10 to 20 dB
T3	20 to 30 dB
T4	> 30 dB

Table 4-1
Magnetic Coupling Parameters

FCC ID: V65CD8100	 PCTEST Engineering Laboratory, Inc.	HAC (T-COIL) TEST REPORT	 KYOCERA	Reviewed by: Quality Manager
Filename: 0Y1509141776-R1.V65	Test Dates: 09/14/2015 - 09/15/2015	EUT Type: Portable Handset	Page 7 of 37	

5. METHOD OF MEASUREMENT

I. Test Setup

The equipment was connected as shown in an acoustic/RF hemi-anechoic chamber:

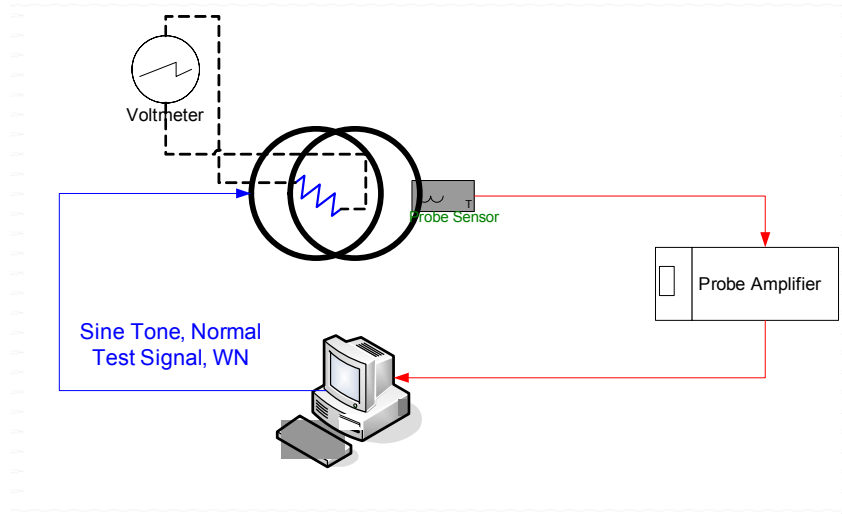

Figure 5-1
Validation Setup with Helmholtz Coil

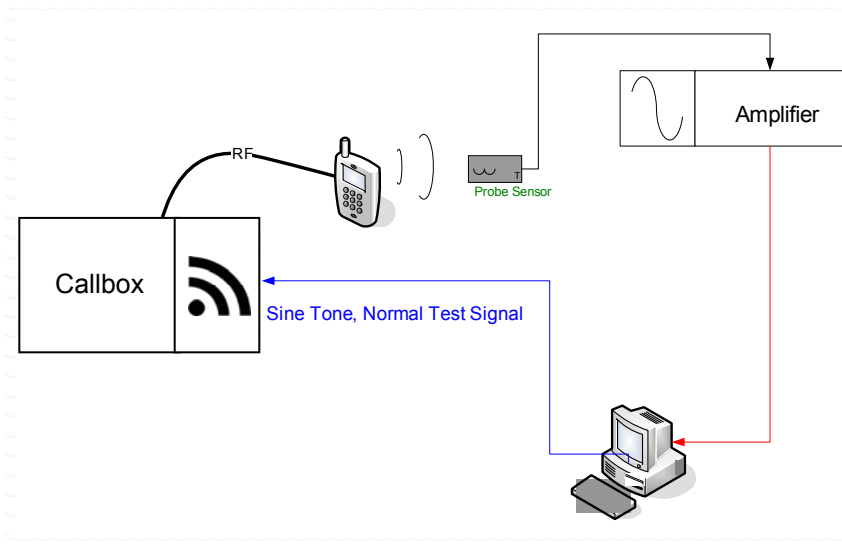



Figure 5-2
T-Coil Test Setup

FCC ID: V65CD8100	 PCTEST This office is in development, etc.	HAC (T-COIL) TEST REPORT	 KYOCERA	Reviewed by: Quality Manager
Filename: 0Y1509141776-R1.V65	Test Dates: 09/14/2015 - 09/15/2015	EUT Type: Portable Handset		Page 8 of 37

II. Scanning Mechanism

Manufacturer: TEM
 Accuracy: ± 0.83 cm/meter
 Minimum Step Size: 0.1 mm
 Maximum speed: 6.1 cm/sec
 Line Voltage: 115 VAC
 Line Frequency: 60 Hz
 Material Composite: Delrin (Acetal)
 Data Control: Parallel Port
 Dynamic Range (X-Y-Z): 45 x 31.75 x 47 cm
 Dimensions: 36" x 25" x 38"
 Operating Area: 36" x 49" x 55"
 Reflections: < -20 dB (in anechoic chamber)

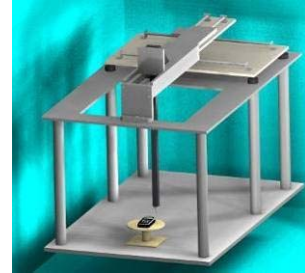

Figure 5-3
RF Near-Field Scanner

III. 3GPP2 Normal Test Signal (Speech)

Manufacturer: 3GPP2 (TIA 1042 §3.3.1)
 Stimulus Type: Modified-IRS weighted, multi-talker speech signal, 4 Male and 4 Female speakers (alternating)
 Single Sample Duration: 51.62 seconds
 Activity Level: 77.4%

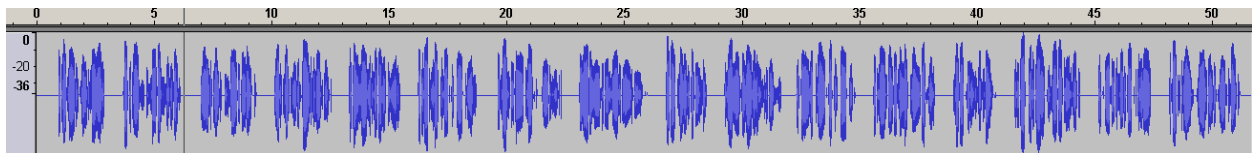

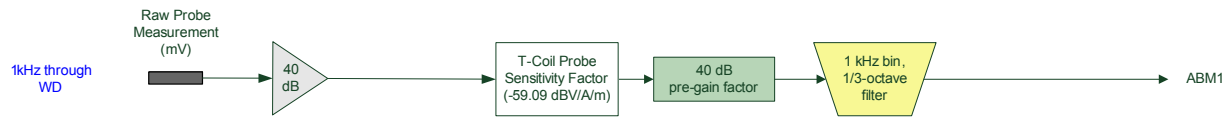

Figure 5-4
Temporal Characteristic of Normal Test Signal

FCC ID: V65CD8100	 PCTEST This office is in development, etc.	HAC (T-COIL) TEST REPORT	 KYOCERA	Reviewed by: Quality Manager
Filename: 0Y1509141776-R1.V65	Test Dates: 09/14/2015 - 09/15/2015	EUT Type: Portable Handset	Page 9 of 37	

ABM1 Measurement Block Diagram :



ABM2 Measurement Block Diagram :

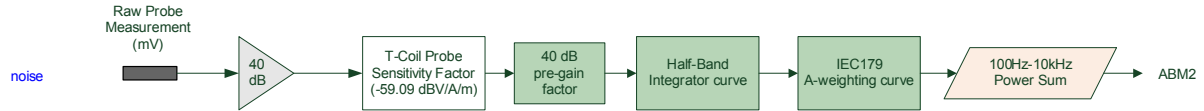

Figure 5-5 Magnetic Measurement Processing Steps

IV. Test Procedure

1. Ambient Noise Check per C63.19 §7.3.1
 - a. Ambient interference was monitored using a Real-Time Analyzer between 100-10,000 Hz with 1/3 octave filtering.
 - b. “A-weighting” and Half-Band Integration was applied to the measurements.
 - c. Since this measurement was measured in the same method as ABM2 measurements, this level was verified to be less than 10 dB below the lowest measurement signal (which is the highest ABM2 measurement for a T4 WD). Therefore the maximum noise level for a T4 WD with an ABM1 = -18 dBA/m is:

$$-18 - 30 - 10 = -58 \text{ dBA/m}$$
2. Measurement System Validation (See Figure 5-1)
 - a. The measurement system including the probe, pre-amplifier and acquisition system were validated as an entire system to ensure the reliability of test measurements.
 - b. ABM1 Validation
 The magnetic field at the center of the Helmholtz coil is given by the equation (per C63.19 Annex D.9.1):



$$H_c = \frac{NI}{r\sqrt{1.25^3}} = \frac{N\left(\frac{V}{R}\right)}{r\sqrt{1.25^3}}$$

Where H_c = magnetic field strength in amperes per meter
 N = number of turns per coil

For the Helmholtz Coil, $N=20$; $r=0.08\text{m}$; $R=10.2\Omega$ and using $V=18\text{mV}$:

$$H_c = \frac{20 \cdot \left(\frac{0.018}{10.2}\right)}{0.08 \cdot \sqrt{1.25^3}} = 0.316 \text{ A/m} \approx -10 \text{ dB(A/m)}$$

Therefore a pure tone of 1kHz was applied into the coils such that 18mV was observed across the resistor. The voltmeter used for measurement was verified to be capable of measurements in the audio band range. This theoretically generates an expected field of 1 A/m in the center of the Helmholtz coil which was used to validate the probe measurement at 1 A/m. This was verified to be within ± 0.5 dB of the 1 A/m value (see Page 22).

FCC ID: V65CD8100		HAC (T-COIL) TEST REPORT		Reviewed by: Quality Manager
Filename: 0Y1509141776-R1.V65	Test Dates: 09/14/2015 - 09/15/2015	EUT Type: Portable Handset	Page 10 of 37	

c. Frequency Response Validation

The frequency response through the Helmholtz Coil was verified to be within 0.5 dB relative to 1 kHz, between 300 – 3000 Hz using the Normal speech signal as shown below:

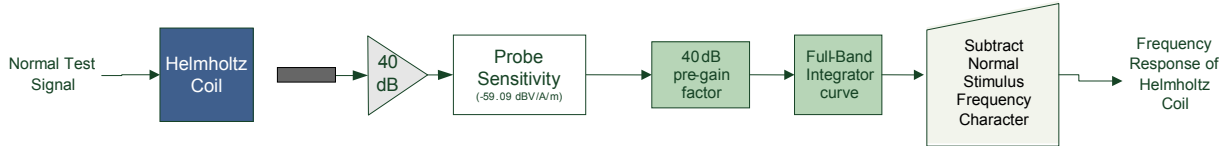



Figure 5-6 Frequency Response Validation

d. ABM2 Measurement Validation

WD noise measurements are filtered with A-weighting and Half-Band Integration over a frequency range of 100Hz – 10kHz to process ABM2 measurements. Below is the verification of the system processing A-weighting and Half-Band integration between system input to output within 0.5 dB of the theoretical result:

**Table 5-1
ABM2 Frequency Response Validation**

f (Hz)	HBI, A - Measured (dB re 1kHz)	HBI, A - Theoretical (dB re 1kHz)	dB Var.
100	-16.180	-16.170	-0.010
125	-13.257	-13.250	-0.007
160	-10.347	-10.340	-0.007
200	-8.017	-8.010	-0.007
250	-5.925	-5.920	-0.005
315	-4.045	-4.040	-0.005
400	-2.405	-2.400	-0.005
500	-1.212	-1.210	-0.002
630	-0.349	-0.350	0.001
800	0.071	0.070	0.001
1000	0.000	0.000	0.000
1250	-0.503	-0.500	-0.003
1600	-1.513	-1.510	-0.003
2000	-2.778	-2.780	0.002
2500	-4.316	-4.320	0.004
3150	-6.166	-6.170	0.004
4000	-8.322	-8.330	0.008
5000	-10.573	-10.590	0.017
6300	-13.178	-13.200	0.022
8000	-16.241	-16.270	0.029
10000	-19.495	-19.520	0.025

FCC ID: V65CD8100	 PCTEST This office is a development, etc.	HAC (T-COIL) TEST REPORT	 KYOCERA	Reviewed by: Quality Manager
Filename: 0Y1509141776-R1.V65	Test Dates: 09/14/2015 - 09/15/2015	EUT Type: Portable Handset	Page 11 of 37	

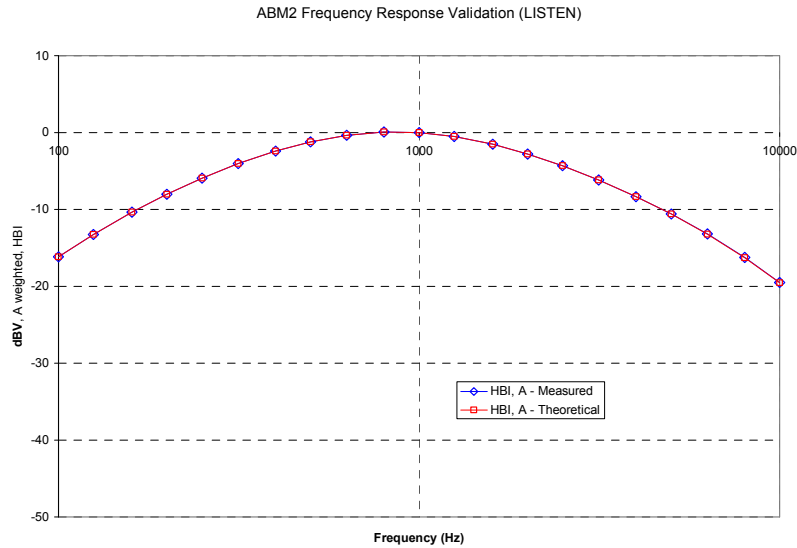

Figure 5-7
ABM2 Frequency Response Validation

The ABM2 result is a power sum from 100 Hz to 10 kHz with half-band integration and A-weighting. To verify the power sum measurement, a power sum over the full band was measured and verified to track with the source level (See Figure 5-8). Therefore the setup in this step was used to verify the power sum post-processing for ABM2 measurements. See below block diagram:

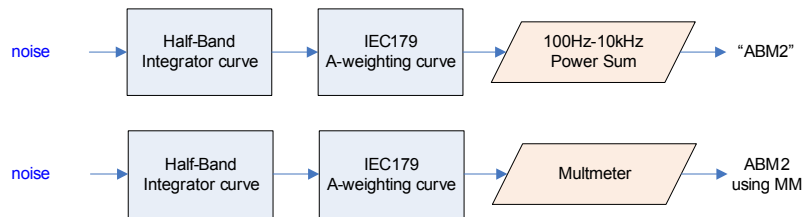

Figure 5-8
ABM2 Validation Block Diagram

The power summed output results for a known input were compared to the multi-meter results to verify any deviation in the post-processing implemented with the power-sum.

Table 5-2
ABM2 Power Sum Validation

WN Input (dBV)	Power Sum (dBV)	Multimeter-Full (dBV)	Dev (dB)
-60	-60.36	-60.2	0.16
-50	-50.19	-50.13	0.06
-40	-40.14	-40.03	0.11
-30	-30.13	-30.01	0.12
-20	-20.12	-20	0.12
-10	-10.14	-10	0.14

FCC ID: V65CD8100		HAC (T-COIL) TEST REPORT		Reviewed by: Quality Manager
Filename: 0Y1509141776-R1.V65	Test Dates: 09/14/2015 - 09/15/2015	EUT Type: Portable Handset	Page 12 of 37	

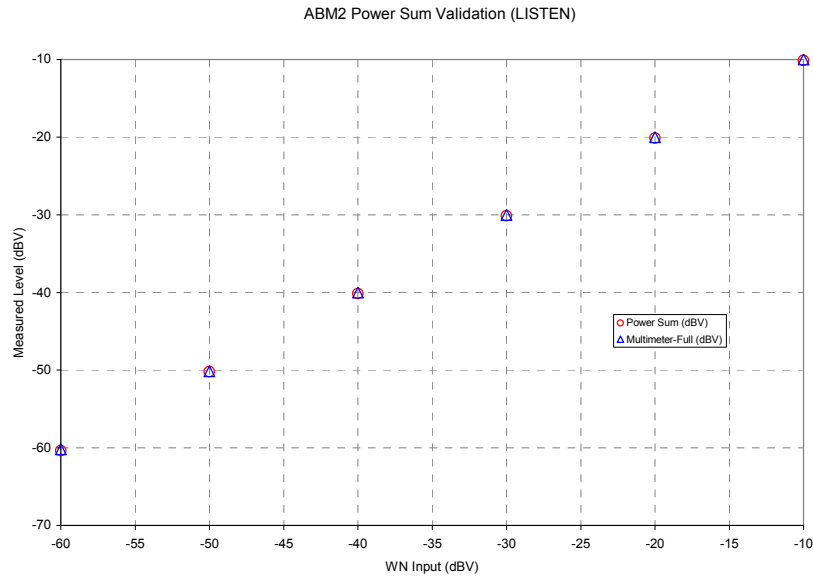

Figure 5-9
ABM2 Power Sum Validation

3. Measurement Test Setup

a. Fine scan above the WD (TEM)

- i. A multitone signal was applied to the handset such that the phone acoustic output was stable within 1dB over the probe settling time and with the acoustic output level at the C63.19 specified levels (below). The measurement step size was in 2 mm increments at a distance of 10 mm between the surface of the wireless device as shown below:

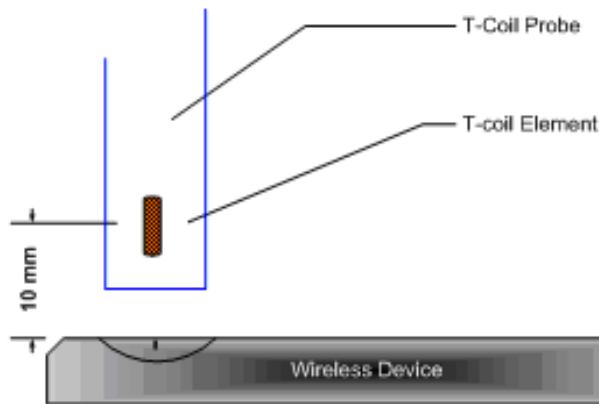



Figure 5-10
Measurement Distance

- ii. After scanning, the planar field maximum point was determined. The position of the probe was moved to this location to setup the test using the Sound Check system.
- iii. These steps were repeated for the other T-coil orientations (of axial or radial transverse) per Figure 5-14 after a T-coil orientation was fully measured with the Sound Check system.

FCC ID: V65CD8100		HAC (T-COIL) TEST REPORT		Reviewed by: Quality Manager
Filename: 0Y1509141776-R1.V65	Test Dates: 09/14/2015 - 09/15/2015	EUT Type: Portable Handset	Page 13 of 37	

- b. Speech Signal Setup to Base Station Simulator
 - i. C63.19 Table 7-1 states audio reference input levels for various technologies:

Standard	Technology	Input Level (dBm0)
TIA/EIA/IS-2000	CDMA	-18
J-STD-007	GSM (217 Hz)	-16
T1/T1P1/3GPP	UMTS (WCDMA)	-16
iDEN™	TDMA (22 and 11 Hz)	-18

The CMU200 audio levels were determined using base station simulator manufacturer calibration procedures resulting in the below corresponding voltages relative to handset test point level (in dBm0):

**Table 5-3
CMU200 Voltage Input Levels for Audio**

dBm0 Ref.	Input Voltage		Notes
3.14 dBm0	1052.0 mV	0.4 dBV	From CDMA2K "DECODER CAL". (What is needed through Encoder for FS)
-18 dBm0	92.260 mV	-20.7 dBV	For 8k Enhanced (Low)

- c. Real-Time Analyzer (RTA)
 - i. The Real-Time Analyzer was configured to analyze measurements using 1/3 Octave band weighted filtering.
- d. WD Radio Configuration Selection
 - i. The device was chosen to be tested in the worst-case ABM2 condition (see Section 6 for more information regarding worst-case configurations for CDMA.)

4. Signal Quality Data Analysis

- a. Narrow-band Magnetic Intensity
 - i. The standard specifies a 1 kHz 1/3 octave band minimum field intensity for a sine tone. The ABM1 measurements were evaluated at 1 kHz with 1/3 octave band filtering over an averaged period of 10 seconds.
- b. Frequency Response
 - i. The appropriate frequency response curve was measured to curves in Figure 4-1 or Figure 4-2 between 300 – 3000 Hz using digital linear averaging (limit lines chosen according to measurement found in step 4a.) A linear average over 3x the length of the speech signal (3x sampling) was performed. A 10 second delay was configured in the measurement process of the stimulus to ensure handset vocoder latency effects and echo cancellation devices (if any) were appropriately stabilized during measurements.
 - ii. The appropriate post-processing was applied according to the system processing chain illustrated in Figure 5-11. All R10 frequencies were plotted with respect to 0dB at 1 kHz value and aligned with respect to the EIA-504 mask.

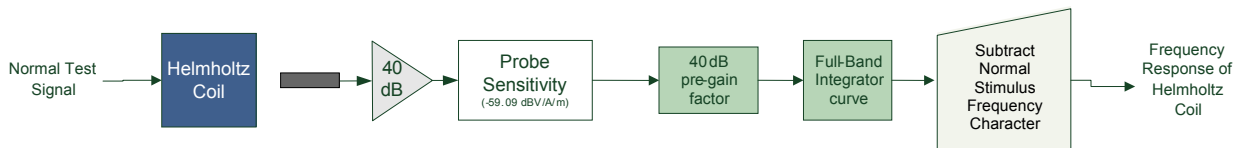



Figure 5-11 Frequency Response Block Diagram

FCC ID: V65CD8100	 PCTEST Engineering Laboratory, Inc.	HAC (T-COIL) TEST REPORT	 KYOCERA	Reviewed by: Quality Manager
Filename: 0Y1509141776-R1.V65	Test Dates: 09/14/2015 - 09/15/2015	EUT Type: Portable Handset	Page 14 of 37	

- iii. The margin is represented by the closest measured data point on the curve to the EIA-504 limit lines, in dB.
- c. Signal Quality Index
- i. Ensuring the WD was at maximum RF power, maximum volume, backlight on, display on, maximum contrast setting, keypad lights on (when possible) with no audio signal through the vocoder, the WD was measured over at least 100 Hz – 10,000 Hz, maximized over 5 seconds with a 50ms sample time for the ABM2 measurement (5 second time period is used in noise measurements under standards such as IEEE 269, etc.)
 - ii. After applying half-band integration and A-weighting to the result, a power sum was applied over each 1/3 octave bandwidth frequency to obtain an ABM2 value.
 - iii. This result was subtracted from the ABM1 result in step a, to obtain the Signal Quality.

V. Test Setup

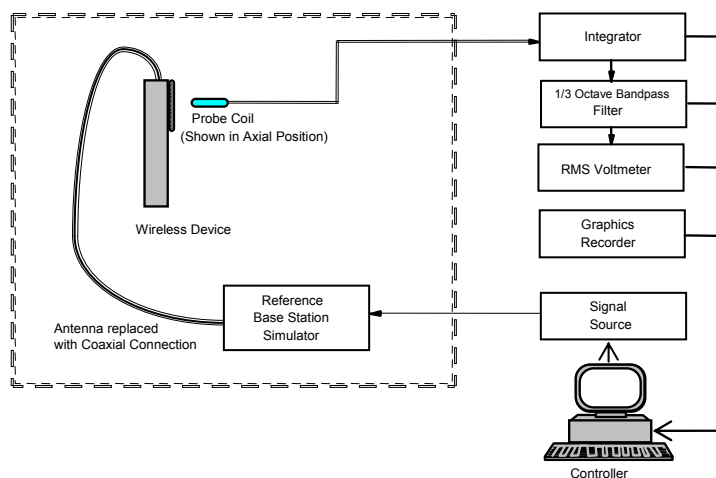



Figure 5-12
Audio Magnetic Field Test Setup

VI. Deviation from C63.19 Test Procedure

Non-conducted RF connection due to inaccessible RF ports.

FCC ID: V65CD8100	 PCTEST This office is in development, etc.	HAC (T-COIL) TEST REPORT	 KYOCERA	Reviewed by: Quality Manager
Filename: 0Y1509141776-R1.V65	Test Dates: 09/14/2015 - 09/15/2015	EUT Type: Portable Handset	Page 15 of 37	

VII. Air Interface Technologies Tested

All air interfaces which support voice capabilities over a managed CMRS were tested for T-coil. See Table 3-1 for more details regarding which modes were tested.

According to the April 2013 TCB workshop slides, WIFI and other OTT data services are outside the current definition of a managed CMRS service and are currently not required to be evaluated.

VIII. Wireless Device Channels and Frequencies

The frequencies listed in the table below are those that lie in the center of the bands used for cellular telephony. Low, middle and high channels were tested in each band for compliance evaluation to ensure the maximum emission is captured across the entire band.

To facilitate setting of a base station simulator for ABM measurements, specific band plan channel numbers are listed that may be used in lieu of the band center frequencies.

**Table 5-4
Center Channels and Frequencies**

Test frequencies & associated channels	
Channel	Frequency (MHz)
Cellular 850	
384 (CDMA)	836.52
PCS 1900	
600 (CDMA)	1880

IX. RF Emission Effect on T-coil Measurements

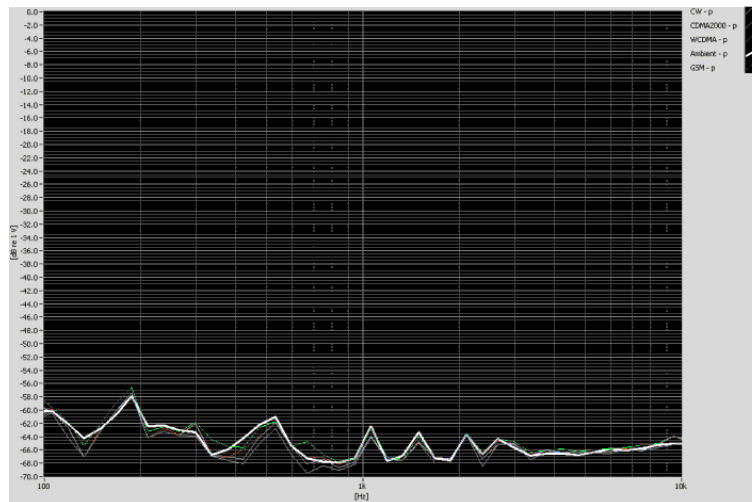



Figure 5-13

High power RF Emissions Effect with HAC Dipole on the T-coil Probe System 10mm between dipole maximum and magnetic probe

FCC ID: V65CD8100	 PCTEST This office is in development, etc.	HAC (T-COIL) TEST REPORT	 KYOCERA	Reviewed by: Quality Manager
Filename: 0Y1509141776-R1.V65	Test Dates: 09/14/2015 - 09/15/2015	EUT Type: Portable Handset	Page 16 of 37	

X. Test Flow

The flow diagram below was followed (From C63.19):

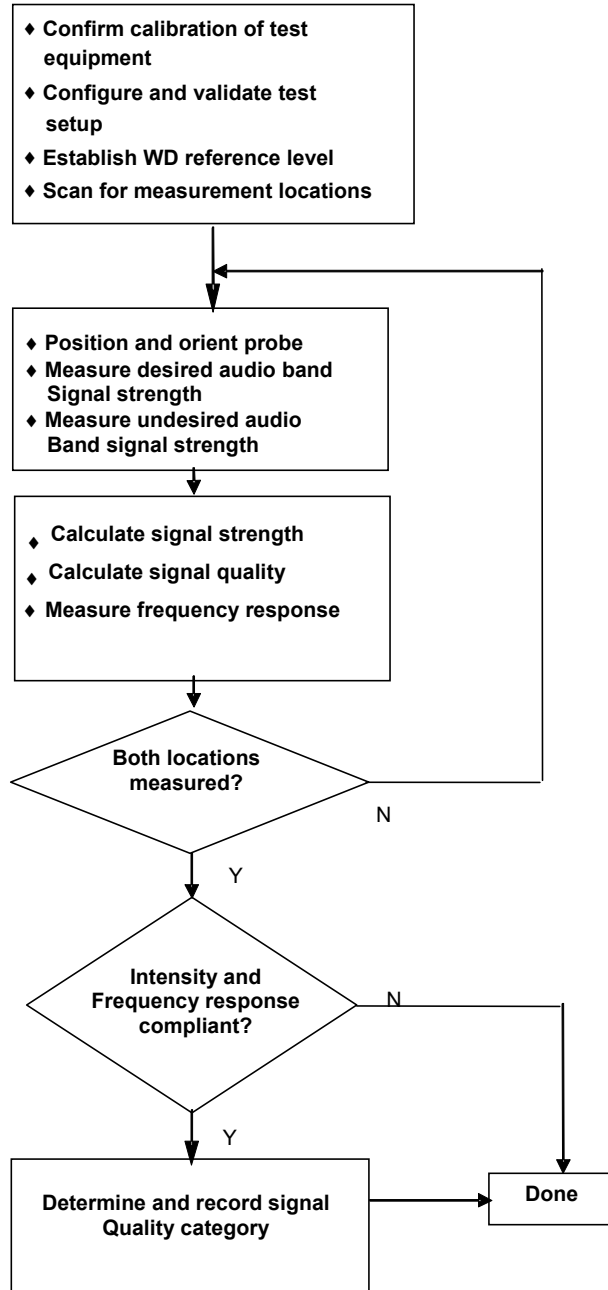



Figure 5-14
C63.19 T-Coil Signal Test Process

FCC ID: V65CD8100	 PCTEST This office is a development, not a	HAC (T-COIL) TEST REPORT	 KYOCERA	Reviewed by: Quality Manager
Filename: 0Y1509141776-R1.V65	Test Dates: 09/14/2015 - 09/15/2015	EUT Type: Portable Handset	Page 17 of 37	

6. FCC 3G MEASUREMENTS

I. CDMA Test Configurations

Radio Configuration 1, Service Option 68 was used for the testing as the worst-case configuration for the handset due to vocoder gating from the EVRC logic. See below plot for an example of ABM noise comparison between operational field service options and radio configurations for a CDMA2000 handset:

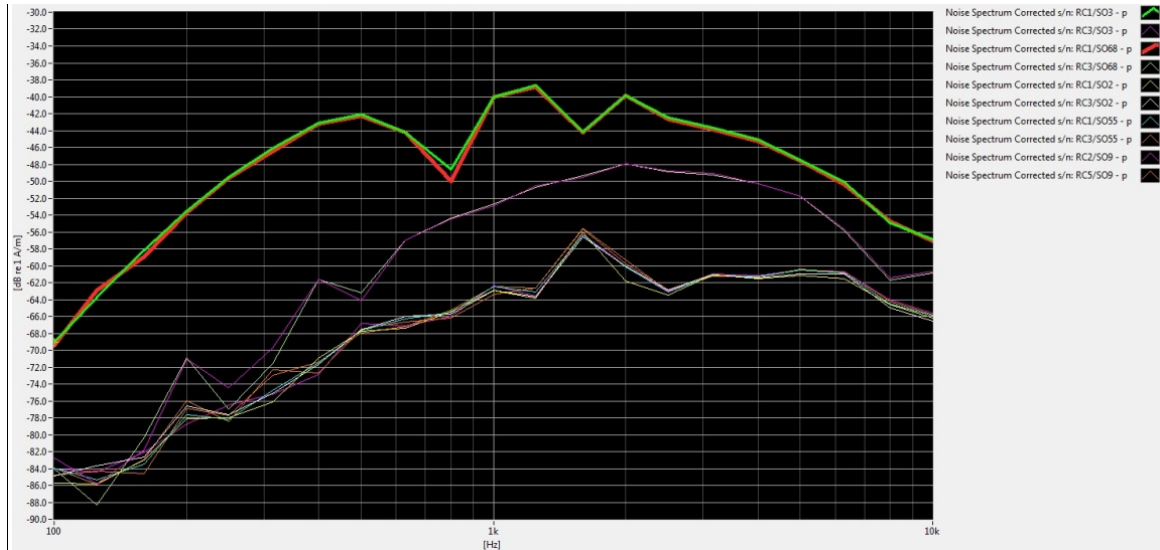

Figure 6-1
CDMA Audio Band Magnetic Noise

II. ABM Measurements



Table 6-1
FCC 3G ABM Measurements for V65CD8100 (CDMA)

Codec Setting:	RC1/SO68	RC3/SO68	RC4/SO68	Orientation	Channel
ABM1 Pre-test (dBA/m)	-3.99	-3.20	-3.15	Radial	600
ABM2 Pre-test (dBA/m) (A-weight, Half-Band Int.)	-48.39	-50.69	-51.00		
S+N/N (dB)	44.40	47.49	47.85		

- Mute on; Backlight on; Max Volume; Max Contrast
- Power Control Bits = "All Up"



Figure 6-2
Audio Band Magnetic Curve Measurement Block Diagram

FCC ID: V65CD8100		HAC (T-COIL) TEST REPORT		Reviewed by: Quality Manager
Filename: 0Y1509141776-R1.V65	Test Dates: 09/14/2015 - 09/15/2015	EUT Type: Portable Handset		Page 18 of 37

7. TEST SUMMARY

I. T-Coil Test Summary



**Table 7-1
Table of Results for CDMA**

C63.19 Sec.	Mode	Band	Test Description	Minimum Limit*	Measured	Verdict
				<i>dBa/m</i>	<i>dBa/m</i>	<i>PASS/FAIL</i>
8.3.1	CDMA	Cellular	Intensity, Axial	-18	4.7	PASS
8.3.1			Intensity, Radial	-18	-3.1	PASS
8.3.4			Signal-to-Noise/Noise, Axial	20	52.6	PASS
8.3.4			Signal-to-Noise/Noise, Radial	20	45.7	PASS
8.3.2			Frequency Response, Axial	0	1.4	PASS
8.3.1	CDMA	PCS	Intensity, Axial	-18	3.7	PASS
8.3.1			Intensity, Radial	-18	-4.2	PASS
8.3.4			Signal-to-Noise/Noise, Axial	20	51.9	PASS
8.3.4			Signal-to-Noise/Noise, Radial	20	44.0	PASS
8.3.2			Frequency Response, Axial	0	1.3	PASS

**Table 7-2
Consolidated Tabled Results**

		Freq. Response Margin		Magnetic Intensity Verdict		FCC SNR Verdict		C63.19-2011 RATING
		Axial	Radial	Axial	Radial	Axial	Radial	
CDMA	Cellular	PASS	NA	PASS	PASS	PASS	PASS	T4
	PCS	PASS	NA	PASS	PASS	PASS	PASS	

Note: Result shown is for T-coil category only.

FCC ID: V65CD8100	 PCTEST Engineering Laboratory, Inc.	HAC (T-COIL) TEST REPORT	 KYOCERA	Reviewed by: Quality Manager
Filename: 0Y1509141776-R1.V65	Test Dates: 09/14/2015 - 09/15/2015	EUT Type: Portable Handset		Page 19 of 37



II. Raw Handset Data

**Table 7-3
Raw Data Results for CDMA**

	Volume	Cellular Band					
		Axial			Radial		
		1013	384	777	1013	384	777
ABM1, dBA/m	Maximum	4.83	4.77	4.73	-2.83	-3.07	-2.97
ABM2, dBA/m		-48.07	-48.18	-47.90	-48.91	-48.74	-48.63
Ambient Noise, dBA/m		-61.92	-61.92	-61.92	-62.88	-62.88	-62.88
Freq. Response Margin (dB)		1.40	1.40	1.48	N/A	N/A	N/A
S+N/N (dB)		52.90	52.95	52.63	46.08	45.67	45.66
S+N/N per orientation (dB)		52.63			45.66		
C63.19-2011 Rating per orientation		T4			T4		
	Volume	PCS Band					
		Axial			Radial		
		25	600	1175	25	600	1175
ABM1, dBA/m	Maximum	3.66	4.00	3.82	-3.93	-4.17	-3.82
ABM2, dBA/m		-48.20	-48.32	-49.56	-48.33	-48.20	-48.56
Ambient Noise, dBA/m		-61.92	-61.92	-61.92	-62.88	-62.88	-62.88
Freq. Response Margin (dB)		1.32	1.48	1.56	N/A	N/A	N/A
S+N/N (dB)		51.86	52.32	53.38	44.40	44.03	44.74
S+N/N per orientation (dB)		51.86			44.03		
C63.19-2011 Rating per orientation		T4			T4		
T-coil Coordinates (cm)	[x,y] from bottom left	2.6, 2.6			2.6, 1.8		

Notes:

1. Power Configuration: Power Control Bits = "All Up"
2. Phone Condition: Mute on; Backlight on; Max Volume; Max Contrast
3. Vocoder Configuration: RC1/SO68 (CDMA – EVRC)
4. 'Radial' orientation refers to radial transverse.
5. Speech Signal: 3GPP2 Normal Test Signal.

FCC ID: V65CD8100	 PCTEST Engineering Laboratory, Inc.	HAC (T-COIL) TEST REPORT	 KYOCERA	Reviewed by: Quality Manager
Filename: 0Y1509141776-R1.V65	Test Dates: 09/14/2015 - 09/15/2015	EUT Type: Portable Handset	Page 20 of 37	

III. Frequency Response Graph

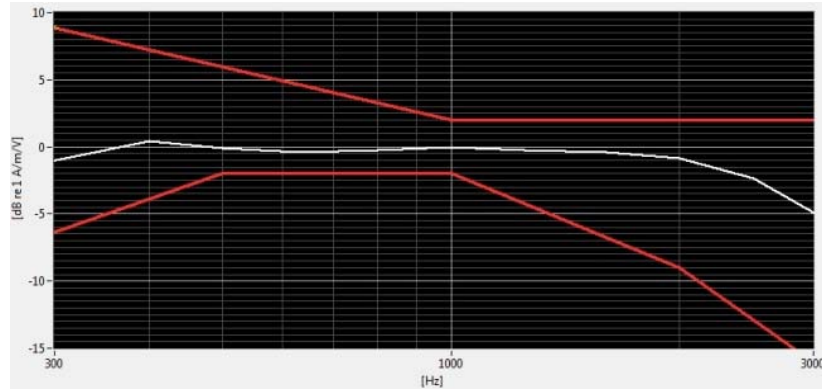
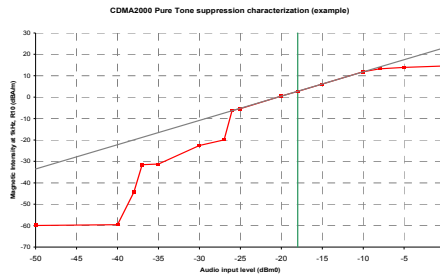

Figure 7-1

Axial Frequency Response

Note: User T-coil Mode (**Settings**→**Sound & notification**→**Other sounds** →**Hearing aid**) was set to ON for Frequency Response compliance. This frequency response represents the worst-case ABM2 test configuration according to Table 7-3.

IV. 1 kHz Vocoder Application Check



This model was verified to be within the linear region for ABM1 measurements at -18 dBm0 for CDMA. This measurement was taken in the axial configuration above the maximum location.

V. Undesirable Audio Magnetic Band Plot (ABM2)

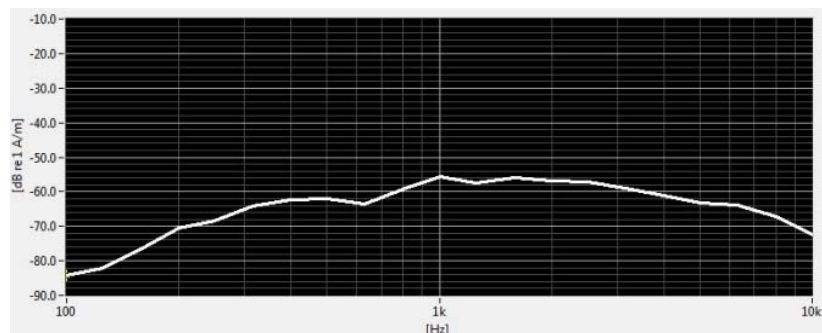



Figure 7-2

Worst-case ABM2 Plot for WD

Note: This plot represents the data from the location/configuration resulting in the highest ABM2 result shown in Table 7-3.

FCC ID: V65CD8100	 PCTEST This space is reserved.	HAC (T-COIL) TEST REPORT	 KYOCERA	Reviewed by: Quality Manager
Filename: 0Y1509141776-R1.V65	Test Dates: 09/14/2015 - 09/15/2015	EUT Type: Portable Handset	Page 21 of 37	

VI. T-Coil Validation Test Results

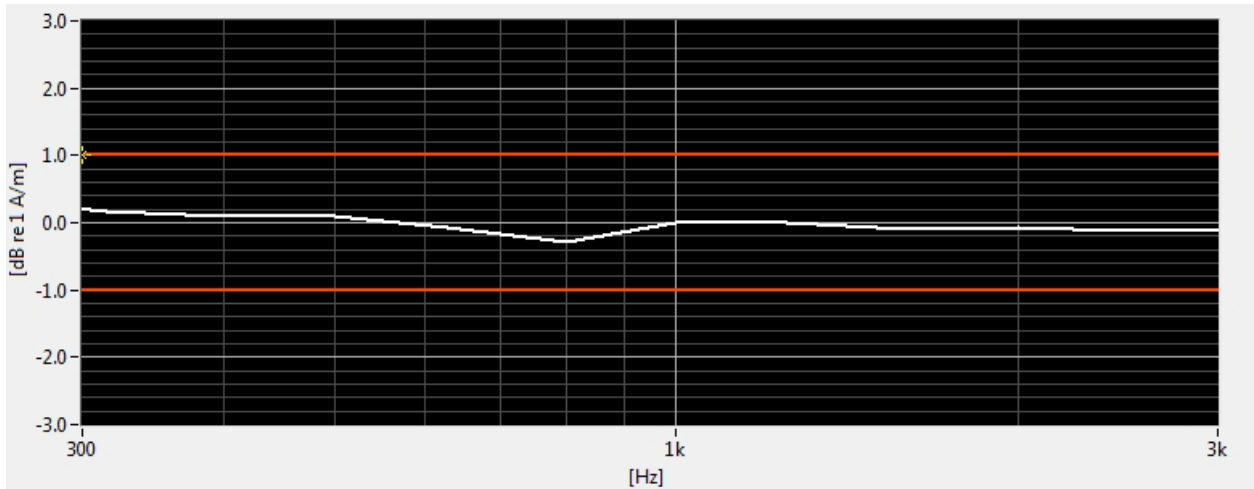



Figure 7-3
Helmholtz Coil Validation for Frequency Response

Table 7-4
Helmholtz Coil Validation Table of Results

Item	Target	Result	Verdict
Signal Validation			
Frequency Response, from limits	$> 0 \text{ dB}$	0.70	PASS
Magnetic Intensity, -10 dBA/m	$-10 \pm 0.5 \text{ dB}$	-10.181	PASS
Noise Validation			
Axial Environmental Noise	$< - 58 \text{ dBA/m}$	-61.92	PASS
Radial Environmental Noise	$< - 58 \text{ dBA/m}$	-62.88	PASS

FCC ID: V65CD8100	 PCTEST Engineering Laboratory, Inc.	HAC (T-COIL) TEST REPORT	 KYOCERA	Reviewed by: Quality Manager
Filename: 0Y1509141776-R1.V65	Test Dates: 09/14/2015 - 09/15/2015	EUT Type: Portable Handset	Page 22 of 37	

8. MEASUREMENT UNCERTAINTY



**Table 8-1
Uncertainty Estimation Table**

Contribution	Data +/- %	Data +/- dB	Data Type	Probability distribution	Divisor	Standard uncertainty	Standard Uncertainty (dB)
ABM Noise	7.0%	0.29	Std. Dev.	Normal k=1	1.00	7.0%	
RF Reflections	4.7%	0.20	Specification	Rectangular	1.73	2.7%	
Reference Signal Level	12.2%	0.50	Specification	Rectangular	1.73	7.0%	
Positioning Accuracy	10.0%	0.41	Uncertainty	Rectangular	1.73	5.8%	
Probe Coil Sensitivity	12.2%	0.50	Specification	Rectangular	1.73	7.0%	
Probe Linearity	2.4%	0.10	Std. Dev.	Normal k=1	1.00	2.4%	
Cable Loss	2.8%	0.12	Specification	Rectangular	1.73	1.6%	
Frequency Analyzer	5.0%	0.21	Specification	Rectangular	1.73	2.9%	
System Repeatability	5.0%	0.21	Std. Dev.	Normal k=1	1.00	5.0%	
WD Repeatability	9.0%	0.37	Std. Dev.	Normal k=1	1.00	9.0%	
Positioner Accuracy	1.0%	0.04	Specification	Rectangular	1.73	0.6%	
Combined standard uncertainty, uc (k=1)						17.7%	0.71
Expanded uncertainty (k=2), 95% confidence level						35.3%	1.31

Notes:

1. Test equipments are calibrated according to techniques outlined in NIS81, NIS3003 and NIST Tech Note 1297.
2. All equipments have traceability according to NIST. Measurement Uncertainties are defined in further detail in NIS 81 and NIST Tech Note 1297 and UKAS M3003.



Measurement uncertainty reflects the quality and accuracy of a measured result as compared to the true value. Such statements are generally required when stating results of measurements so that it is clear to the intended audience that the results may differ when reproduced by different facilities. Measurement results vary due to the measurement uncertainty of the instrumentation, measurement technique, and test engineer. Most uncertainties are calculated using the tolerances of the instrumentation used in the measurement, the measurement setup variability, and the technique used in performing the test. While not generally included, the variability of the equipment under test also figures into the overall measurement uncertainty. Another component of the overall uncertainty is based on the variability of repeated measurements (so-called Type A uncertainty). This may mean that the Hearing Aid compatibility tests may have to be repeated by taking down the test setup and resetting it up so that there are a statistically significant number of repeat measurements to identify the measurement uncertainty. By combining the repeat measurement results with that of the instrumentation chain using the technique contained in NIS 81 and NIS 3003, the overall measurement uncertainty was estimated.

FCC ID: V65CD8100		HAC (T-COIL) TEST REPORT		Reviewed by: Quality Manager
Filename: 0Y1509141776-R1.V65	Test Dates: 09/14/2015 - 09/15/2015	EUT Type: Portable Handset	Page 23 of 37	



9. EQUIPMENT LIST

**Table 9-1
Equipment List**

Manufacturer	Model	Description	Cal Date	Cal Interval	Cal Due	Serial Number
Control Company	36934-158	Wall-Mounted Thermometer	4/29/2014	Biennial	4/29/2016	122014488
Listen	SoundCheck	Acoustic Analyzer System	1/27/2015	Annual	1/27/2016	04-06-5876-SC2850
Listen	SoundConnect	Microphone Power Supply	1/22/2015	Annual	1/22/2016	0899-PS150
NI	4474	Data Acquisition Card	N/A		N/A	N/A
Rohde & Schwarz	CMU200	Base Station Simulator	3/23/2015	Annual	3/23/2016	836371/0079
TEM		HAC Positioner	N/A		N/A	N/A
TEM		HAC System Controller with Software	N/A		N/A	N/A
TEM	C63.19	Helmholtz Coil	1/29/2015	Annual	1/29/2016	925
TEM	Axial T-Coil Probe	Axial T-Coil Probe	1/29/2015	Annual	1/29/2016	TEM-1123
TEM	Radial T-Coil Probe	Radial T-Coil Probe	1/29/2015	Annual	1/29/2016	TEM-1129

FCC ID: V65CD8100	 PCTEST <small>THE BEST IN DEVELOPMENT, INC.</small>	HAC (T-COIL) TEST REPORT	 KYOCERA	Reviewed by: Quality Manager
Filename: 0Y1509141776-R1.V65	Test Dates: 09/14/2015 - 09/15/2015	EUT Type: Portable Handset	Page 24 of 37	

10. CALIBRATION CERTIFICATES

FCC ID: V65CD8100	 PCTEST <small>Engineering Laboratory, Inc.</small>	HAC (T-COIL) TEST REPORT	 KYOCERA	Reviewed by: Quality Manager
Filename: 0Y1509141776-R1.V65	Test Dates: 09/14/2015 - 09/15/2015	EUT Type: Portable Handset	Page 25 of 37	

West Caldwell Calibration Laboratories Inc.

Certificate of Calibration

for

Axial T Coil Probe

Manufactured by: TEM CONSULTING
Model No: Axial T Coil Probe
Serial No: TEM-1123
Calibration Recall No: 24931

Submitted By:

Customer: ANDREW HARWELL
Company: PCTEST ENGINEERING LAB
Address: 6660-B DOBBIN ROAD COLUMBIA MD 21045

The subject instrument was calibrated to the indicated specification using standards traceable to the National Institute of Standards and Technology or to accepted values of natural physical constants. This document certifies that the instrument met the following specification upon its return to the submitter.

West Caldwell Calibration Laboratories Procedure No. Axial T Coi TEM

Upon receipt for Calibration, the instrument was found to be:

Within (X)

ASH
3/17/2015

tolerance of the indicated specification. See attached Report of Calibration.

West Caldwell Calibration Laboratories' calibration control system meets the requirements, ISO 10012-1 MIL-STD-45662A, ANSI/NCSL Z540-1, IEC Guide 25, ISO 9001:2008 and ISO 17025.

Note: With this Certificate, Report of Calibration is included.

Approved by:

Calibration Date: 29-Jan-15

Certificate No: 24931 - 1

QA Doc. #1051 Rev. 2.0 10/1/01

Certificate Page 1 of 1

FC
Felix Christopher (QA Mgr.)
ISO/IEC 17025:2005

West Caldwell Calibration Laboratories, Inc.
uncompromised calibration
1575 State Route 96, Victor, NY 14564, U.S.A.



Calibration Lab. Cert. # 1533.01

FCC ID: V65CD8100	PCTEST Engineering Laboratory, Inc.	HAC (T-COIL) TEST REPORT	KYOCERA	Reviewed by: Quality Manager
Filename: 0Y1509141776-R1.V65	Test Dates: 09/14/2015 - 09/15/2015	EUT Type: Portable Handset	Page 26 of 37	



ISO/IEC 17025: 2005



Calibration Lab. Cert. # 1533.01

REPORT OF CALIBRATION

TEM Consulting LP Axial T Coil Probe

for
Model No.: Axial T Coil Probe

Serial No.: TEM-1123

Company : PCTEST Engineering Lab.

I. D. No: 80582

Calibration results:			Before data:	After data:
Probe Sensitivity measured with Helmholtz Coil			Before & after data same: ...X.....	
<i>Helmholtz Coil;</i>				
the number of turns on each coil;	10	No.	Laboratory Environment:	
the radius of each coil, in meters;	0.204	m	Ambient Temperature:	21.0 °C
the current in the coils, in amperes.;	0.09	A	Ambient Humidity:	25.4 % RH
<i>Helmholtz Coil Constant;</i>	7.09	A/m/V	Ambient Pressure:	99.5 kPa
<i>Helmholtz Coil magnetic field;</i>	6.08	A/m	Calibration Date:	29-Jan-15
 			Re-calibration Due:	29-Jan-16
Probe Sensitivity at	1000	Hz.	Report Number:	24931 -1
was	-60.13	dBV/A/m	Control Number:	24931
	0.985	mV/A/m		
Probe resistance	892	Ohms		

The above listed instrument meets or exceeds the tested manufacturer's specifications.

This Calibration is traceable through NIST test numbers: 683/284413-14

The expanded uncertainty of calibration: 0.30dB at 95% confidence level with a coverage factor of k=2.

Graph represents Probes Frequency Response.

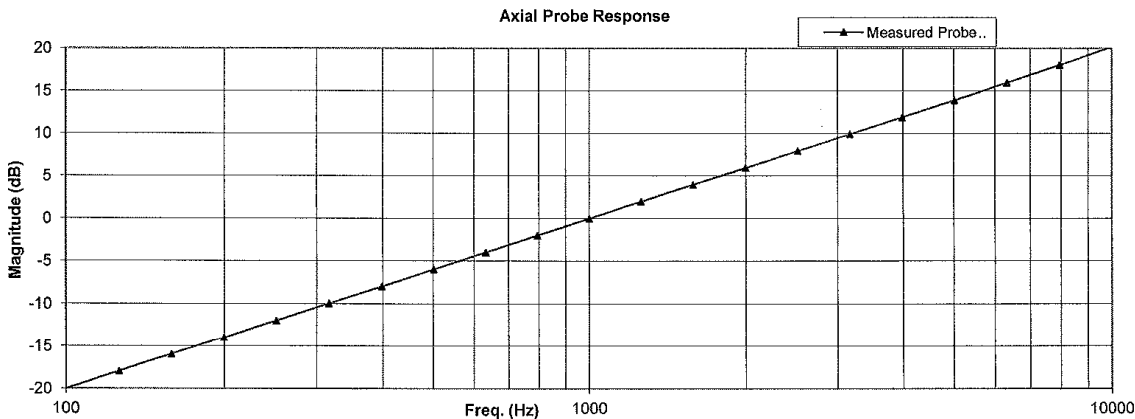

The above listed instrument was checked using calibration procedure documented in West Caldwell

Calibration Laboratories Inc. procedure :

Rev. 7.0 Jan. 24, 2014 Doc. # 1038 HCATEMC

Calibration was performed by West Caldwell Calibration Laboratories Inc. under Operating Procedures

intended to implement the requirements of ISO10012-1, IEC Guide 25, ANSI/NCSL Z540-1, (MIL-STD-45662A) and ISO 9001:2008, ISO 17025

Cal. Date: 29-Jan-2015

Measurements performed by:

Calibrated on WCCL system type 9700

Felix Christopher

This document shall not be reproduced, except in full, without the written approval from West Caldwell Cal. Labs. Inc.

Rev. 7.0 Jan. 24, 2014 Doc. # 1038 HCATEMC

FCC ID: V65CD8100		HAC (T-COIL) TEST REPORT		Reviewed by: Quality Manager
Filename: 0Y1509141776-R1.V65	Test Dates: 09/14/2015 - 09/15/2015	EUT Type: Portable Handset		Page 27 of 37

HCATEMC_TEM-1123_Jan-29-2015

West Caldwell Calibration Laboratories Inc.

1575 State Route 96, Victor NY 14564
Tel. (585) 586-3900 FAX (585) 586-4327



Calibration Data Record

TEM Consulting LP Axial T Coil Probe for Model No.: Axial T Coil Probe Serial No.: TEM-1123
Company : PCTEST Engineering Lab.

Test	Function	Tolerance	Measured values			
			Before	Out	Remarks	
1.0	Probe Sensitivity at	1000 Hz. dBV/A/m	-60.13			
2.0	Probe Level Linearity	dB	5.57			
		Ref. (0 dB)	0			
			-6			
			-12			
3.0	Probe Frequency Response	Hz				
			100	-20.0		
			126	-17.9		
			158	-15.9		
			200	-14.0		
			251	-12.0		
			316	-10.0		
			398	-8.0		
			501	-6.0		
			631	-4.0		
			794	-2.0		
			Ref. (0 dB)	1000	0.0	
				1259	2.0	
				1585	4.0	
				1995	6.0	
				2512	7.9	
				3162	9.9	
		3981	11.9			
		5012	13.9			
		6310	15.9			
		7943	18.0			
		10000	20.2			

Instruments used for calibration:			Date of Cal.	Traceability No.	Due Date
HP	34401A	S/N 36064102	6-Oct-2014	,287708	6-Oct-2015
HP	34401A	S/N 36102471	6-Oct-2014	,287708	6-Oct-2015
HP	33120A	S/N 36043716	6-Oct-2014	,287708	6-Oct-2015
B&K	2133	S/N 1583254	8-Jan-2015	683/284413-14	9-Jan-2016

Cal. Date: 29-Jan-2015 Tested by: Felix Christopher
Calibrated on WCCL system type 9700
This document shall not be reproduced, except in full, without the written approval from West Caldwell Cal. Labs. Inc. Rev. 7.0 Jan. 24, 2014 Doc. # 1038 HCATEMC

FCC ID: V65CD8100		HAC (T-COIL) TEST REPORT		Reviewed by: Quality Manager
Filename: 0Y1509141776-R1.V65	Test Dates: 09/14/2015 - 09/15/2015	EUT Type: Portable Handset	Page 28 of 37	

West Caldwell Calibration Laboratories Inc.

Certificate of Calibration

for

Radial T Coil Probe

Manufactured by: TEM CONSULTING
Model No: Radial T Coil Probe
Serial No: TEM-1129
Calibration Recall No: 24931

Submitted By:

Customer: ANDREW HARWELL
Company: PCTEST ENGINEERING LAB
Address: 6660-B DOBBIN ROAD
COLUMBIA MD 21045

The subject instrument was calibrated to the indicated specification using standards traceable to the National Institute of Standards and Technology or to accepted values of natural physical constants. This document certifies that the instrument met the following specification upon its return to the submitter.

West Caldwell Calibration Laboratories Procedure No. Radial T C TEM

Upon receipt for Calibration, the instrument was found to be:

Within (X)

✓ASH
3/17/2015

tolerance of the indicated specification. See attached Report of Calibration.

West Caldwell Calibration Laboratories' calibration control system meets the requirements, ISO 10012-1 MIL-STD-45662A, ANSI/NCSL Z540-1, IEC Guide 25, ISO 9001:2008 and ISO 17025.

Note: With this Certificate, Report of Calibration is included.

Approved by:

Calibration Date: 29-Jan-15

Certificate No: 24931 - 2

QA Doc. #1051 Rev. 2.0 10/1/01



Certificate Page 1 of 1

FC
Felix Christopher (QA Mgr.)
ISO/IEC 17025:2005

West Caldwell Calibration Laboratories, Inc.
uncompromised calibration
1575 State Route 96, Victor, NY 14564, U.S.A.



Calibration Lab. Cert. # 1533.01

FCC ID: V65CD8100	 PCTEST THE BEST IN DEVELOPMENT, NY	HAC (T-COIL) TEST REPORT	 KYOCERA	Reviewed by: Quality Manager
Filename: 0Y1509141776-R1.V65	Test Dates: 09/14/2015 - 09/15/2015	EUT Type: Portable Handset		Page 29 of 37



REPORT OF CALIBRATION

TEM Consulting LP Radial T Coil Probe for Model No.: Radial T Coil Probe Serial No.: TEM-1129
 Company : PCTEST Engineering Lab. I. D. No: 80583

Calibration results:			Before data:	After data:
Probe Sensitivity measured with Helmholtz Coil				
<i>Helmholtz Coil;</i>				
the number of turns on each coil;	10	No.	Before & after data same: ...X.....	
the radius of each coil, in meters;	0.204	m		
the current in the coils, in amperes.;	0.09	A		
<i>Helmholtz Coil Constant;</i>	7.09	A/m/V	Laboratory Environment:	
<i>Helmholtz Coil magnetic field;</i>	5.99	A/m	Ambient Temperature:	21.0 °C
			Ambient Humidity:	25.4 % RH
			Ambient Pressure:	99.5 kPa
			Calibration Date:	29-Jan-15
Probe Sensitivity at	1000	Hz.	Re-calibration Due:	29-Jan-16
was	-60.44	dBV/A/m	Report Number:	24931 -2
	0.950	mV/A/m	Control Number:	24931
Probe resistance	892	Ohms		

The above listed instrument meets or exceeds the tested manufacturer's specifications.

This Calibration is traceable through NIST test numbers: 683/284413-14
 The expanded uncertainty of calibration: 0.30dB at 95% confidence level with a coverage factor of k=2.
 Graph represents Probes Frequency Response.

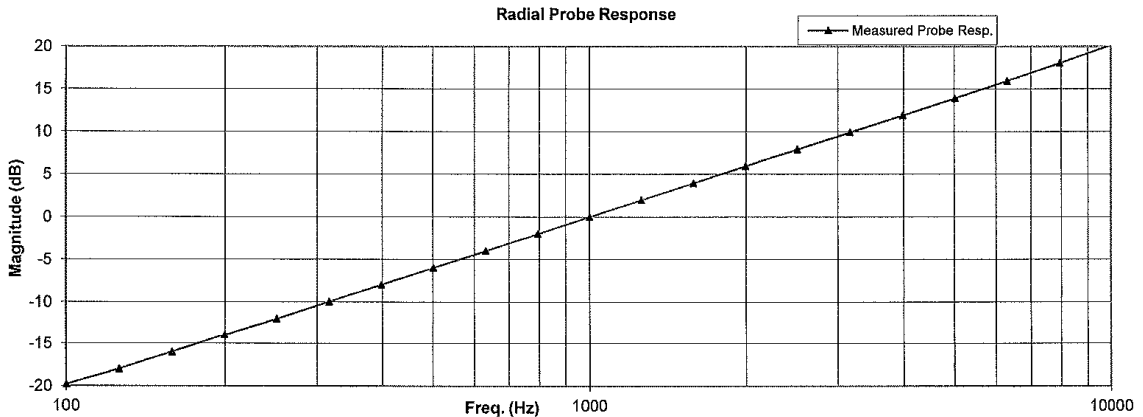

The above listed instrument was checked using calibration procedure documented in West Caldwell Calibration Laboratories Inc. procedure : **Rev. 7.0 Jan. 24, 2014 Doc. # 1038 HCRTEMC**
 Calibration was performed by West Caldwell Calibration Laboratories Inc. under Operating Procedures intended to implement the requirements of ISO10012-1, IEC Guide 25, ANSI/NCSL Z540-1, (MIL-STD-45662A) and ISO 9001:2008, ISO 17025

Cal. Date: 29-Jan-2015 Measurements performed by: *[Signature]*
 Calibrated on WCCL system type 9700 **Felix Christopher**
 This document shall not be reproduced, except in full, without the written approval from West Caldwell Cal. Labs. Inc. Rev. 7.0 Jan. 24, 2014 Doc. # 1038 HCRTEMC

FCC ID: V65CD8100		HAC (T-COIL) TEST REPORT		Reviewed by: Quality Manager
Filename: 0Y1509141776-R1.V65	Test Dates: 09/14/2015 - 09/15/2015	EUT Type: Portable Handset		Page 30 of 37

HCRTEMC_TEM-1129_Jan-29-2015

West Caldwell Calibration Laboratories Inc.

1575 State Route 96, Victor NY 14564
Tel. (585) 586-3900 FAX (585) 586-4327

Calibration Data Record

TEM Consulting LP Radial T Coil Probe for Model No.: Radial T Coil Probe Serial No.: TEM-1129
Company : PCTEST Engineering Lab.

Test	Function	Tolerance	Measured values				
			Before	Out	Remarks		
1.0	Probe Sensitivity at	1000 Hz. dBV/A/m	-60.44				
2.0	Probe Level Linearity						
			dB	5.99			
		Ref. (0 dB)	0	0.00			
			-6	-6.02			
		-12	-12.04				
3.0	Probe Frequency Response		Hz				
			100	-19.8			
			126	-18.0			
			158	-16.0			
			200	-13.9			
			251	-12.0			
			316	-10.0			
			398	-8.0			
			501	-6.0			
			631	-4.0			
			794	-2.0			
			Ref. (0 dB)	1000	0.0		
				1259	2.0		
				1585	4.0		
				1995	6.0		
				2512	7.9		
				3162	9.9		
		3981	11.9				
		5012	13.9				
		6310	16.0				
		7943	18.0				
		10000	20.2				



Instruments used for calibration:			Date of Cal.	Traceability No.	Due Date
HP	34401A	S/N 36064102	6-Oct-2014	,287708	6-Oct-2015
HP	34401A	S/N 36102471	6-Oct-2014	,287708	6-Oct-2015
HP	33120A	S/N 36043716	6-Oct-2014	,287708	6-Oct-2015
B&K	2133	S/N 1583254	8-Jan-2015	683/284413-14	9-Jan-2016

Cal. Date: 29-Jan-2015
Calibrated on WCCL system type 9700

Tested by: Felix Christopher

This document shall not be reproduced, except in full, without the written approval from West Caldwell Cal. Labs. Inc.



Rev. 7.0 Jan. 24, 2014 Doc. # 1038 HCRTEMC

FCC ID: V65CD8100		HAC (T-COIL) TEST REPORT		Reviewed by: Quality Manager
Filename: 0Y1509141776-R1.V65	Test Dates: 09/14/2015 - 09/15/2015	EUT Type: Portable Handset	Page 31 of 37	

11. CONCLUSION



The measurements indicate that the wireless communications device complies with the HAC limits specified in accordance with the ANSI C63.19 Standard and FCC WT Docket No. 01-309 RM-8658. Precise laboratory measures were taken to assure repeatability of the tests. The tested device complies with the requirements in respect to all parameters specific to the test. The test results and statements relate only to the item(s) tested.

The measurement system and techniques presented in this evaluation are proposed in the ANSI standard as a means of best approximating wireless device compatibility with a hearing-aid. The literature is under continual re-construction.



FCC ID: V65CD8100	 PCTEST <small>Engineering Laboratory, Inc.</small>	HAC (T-COIL) TEST REPORT	 KYOCERA	Reviewed by: Quality Manager
Filename: 0Y1509141776-R1.V65	Test Dates: 09/14/2015 - 09/15/2015	EUT Type: Portable Handset	Page 32 of 37	

12. REFERENCES

1. ANSI/IEEE C63.19-2011, "American National Standard for Methods of Measurement of Compatibility between Wireless communication devices and Hearing Aids.", New York, NY, IEEE, May 2011
2. FCC Office of Engineering and Technology KDB, "285076 D01 HAC Guidance v04," October 31, 2013
3. FCC Office of Engineering and Technology KDB, "285076 D02 T-Coil Testing for CMRS IP v01r01," October 31, 2013
4. FCC Public Notice DA 06-1215, *Wireless Telecommunications Bureau and Office of Engineering and Technology Clarify Use of Revised Wireless Phone Hearing Aid Compatibility Standard*, June 6, 2006
5. FCC 3G Review Guidance, Laboratory Division OET FCC, May/June 2006
6. Berger, H. S., "Compatibility Between Hearing Aids and Wireless Devices," Electronic Industries Forum, Boston, MA, May, 1997
7. Berger, H. S., "Hearing Aid and Cellular Phone Compatibility: Working Toward Solutions," *Wireless Telephones and Hearing Aids: New Challenges for Audiology*, Gallaudet University, Washington, D.C., May, 1997 (To be reprinted in the American Journal of Audiology).
8. Berger, H. S., "Hearing Aid Compatibility with Wireless Communications Devices," IEEE International Symposium on Electromagnetic Compatibility, Austin, TX, August, 1997.
9. Bronaugh, E. L., "Simplifying EMI Immunity (Susceptibility) Tests in TEM Cells," in the 1990 IEEE International Symposium on Electromagnetic Compatibility Symposium Record, Washington, D.C., August 1990, pp. 488-491
10. Byrne, D. and Dillon, H., The National Acoustics Laboratory (NAL) New Procedure for Selecting the Gain and Frequency Response of a Hearing Aid, *Ear and Hearing* 7:257-265, 1986.
11. Crawford, M. L., "Measurement of Electromagnetic Radiation from Electronic Equipment using TEM Transmission Cells," U.S. Department of Commerce, National Bureau of Standards, NBSIR 73-306, Feb. 1973.
12. Crawford, M. L., and Workman, J. L., "Using a TEM Cell for EMC Measurements of Electronic Equipment," U.S. Department of Commerce, National Bureau of Standards. Technical Note 1013, July 1981.
13. Decker, W. F., Crawford, M. L., and Wilson, W. A., "Construction of a Large Transverse Electromagnetic Cell", U.S. Department of Commerce, National Bureau of Standards, Technical Note 1011, Feb. 1979.
14. EHIMA GSM Project, Development phase, Project Report (1st part) Revision A. Technical-Audiological Laboratory and Telecom Denmark, October 1993.
15. EHIMA GSM Project, Development phase, Part II Project Report. Technical-Audiological Laboratory and Telecom Denmark, June 1994.

FCC ID: V65CD8100	 PCTEST Engineering Laboratory, Inc.	HAC (T-COIL) TEST REPORT	 KYOCERA	Reviewed by: Quality Manager
Filename: 0Y1509141776-R1.V65	Test Dates: 09/14/2015 - 09/15/2015	EUT Type: Portable Handset	Page 33 of 37	

16. EHIMA GSM Project Final Report, Hearing Aids and GSM Mobile Telephones: Interference Problems, Methods of Measurement and Levels of Immunity. Technical-Audiological Laboratory and Telecom Denmark, 1995.
17. HAMPIS Report, Comparison of Mobile phone electromagnetic near field with an upscaled electromagnetic far field, using hearing aid as reference, 21 October 1999.
18. Hearing Aids/GSM, Report from OTWIDAM, Technical-Audiological Laboratory and Telecom Denmark, April 1993.
19. IEEE 100, The Authoritative Dictionary of IEEE Standards Terms, Seventh Edition.
20. Joyner, K. H, et. al., Interference to Hearing Aids by the New Digital Mobile Telephone System, Global System for Mobile (GSM) Communication Standard, National Acoustic Laboratory, Australian Hearing Series, Sydney 1993.
21. Joyner, K. H., et. al., Interference to Hearing Aids by the Digital Mobile Telephone System, Global System for Mobile Communications (GSM), NAL Report #131, National Acoustic Laboratory, Australian Hearing Series, Sydney, 1995.
22. Konigstein, D., and Hansen, D., "A New Family of TEM Cells with enlarged bandwidth and Optimized working Volume," in the Proceedings of the 7th International Symposium on EMC, Zurich, Switzerland, March 1987; 50:9, pp. 127-132.
23. Kuk, F., and Hjorstgaard, N. K., "Factors affecting interference from digital cellular telephones," Hearing Journal, 1997; 50:9, pp 32-34.
24. Ma, M. A., and Kanda, M., "Electromagnetic Compatibility and Interference Metrology," U.S. Department of Commerce, National Bureau of Standards, Technical Note 1099, July 1986, pp. 17-43.
25. Ma, M. A., Sreenivashiah, I. , and Chang, D. C., "A Method of Determining the Emission and Susceptibility Levels of Electrically Small Objects Using a TEM Cell," U.S. Department of Commerce, National Bureau of Standards, Technial Note 1040, July 1981.
26. McCandless, G. A., and Lyregaard, P. E., Prescription of Gain/Output (POGO) for Hearing Aids, Hearing Instruments 1:16-21, 1983
27. Skopec, M., "Hearing Aid Electromagnetic Interference from Digital Wireless Telephones, "IEEE Transactions on Rehabilitation Engineering, vol. 6, no. 2, pp. 235-239, June 1998.
28. Technical Report, GSM 05.90, GSM EMC Considerations, European Telecommunications Standards Institute, January 1993.
29. Victorian, T. A., "Digital Cellular Telephone Interference and Hearing Aid Compatibility—an Update," Hearing Journal 1998; 51:10, pp. 53-60
30. Wong, G. S. K., and Embleton, T. F. W., eds., AIP Handbook of Condenser Microphones: Theory, Calibration and Measurements, AIP Press.

FCC ID: V65CD8100	 PCTEST THE OFFICE OF DEVELOPMENT, INC.	HAC (T-COIL) TEST REPORT	 KYOCERA	Reviewed by: Quality Manager
Filename: 0Y1509141776-R1.V65	Test Dates: 09/14/2015 - 09/15/2015	EUT Type: Portable Handset	Page 34 of 37	