



FCC HAC (T-Coil) Test Report

Report No. : SA151222C07-2
 Applicant : Kyocera Communications, Inc.
 Address : 8611 Balboa Ave., San Diego, CA 92123, USA
 Product : Smartphone
 FCC ID : V65C6743
 Brand : Kyocera
 Model No. : C6743
 Standards : FCC 47 CFR Part 20.19
 ANSI C63.19-2011
 Sample Received Date : Dec. 22, 2015
 Date of Testing : Jan. 13, 2016
 Summary T-Rating : T4

CERTIFICATION: The above equipment have been tested by **Bureau Veritas Consumer Products Services (H.K.) Ltd., Taoyuan Branch – Lin Kou Laboratories**, and found compliance with the requirement of the above standards. The test record, data evaluation & Equipment Under Test (EUT) configurations represented herein are true and accurate accounts of the measurements of the sample’s HAC characteristics under the conditions specified in this report. It should not be reproduced except in full, without the written approval of our laboratory. The client should not use it to claim product certification, approval, or endorsement by TAF or any government agencies.

Prepared By : Evonne Liu
 Evonne Liu / Specialist

Approved By : Eli Hsu
 Eli Hsu / Supervisor



This report is for your exclusive use. Any copying or replication of this report to or for any other person or entity, or use of our name or trademark, is permitted only with our prior written permission. This report sets forth our findings solely with respect to the test samples identified herein. The results set forth in this report are not indicative or representative of the quality or characteristics of the lot from which a test sample was taken or any similar or identical product unless specifically and expressly noted. Our report includes all of the tests requested by you and the results thereof based upon the information that you provided to us. You have 60 days from date of issuance of this report to notify us of any material error or omission caused by our negligence, provided, however, that such notice shall be in writing and shall specifically address the issue you wish to raise. A failure to raise such issue within the prescribed time shall constitute your unqualified acceptance of the completeness of this report, the tests conducted and the correctness of the report contents. Unless specific mention, the uncertainty of measurement has been explicitly taken into account to declare the compliance or non-compliance to the specification.



Table of Contents

Release Control Record	3
1. Summary of Maximum T-Rating	4
2. Description of Equipment Under Test	5
3. HAC RF Emission Measurement System	6
3.1 SPEAG DASY System	6
3.1.1 Robot.....	8
3.1.2 AM1D Probe.....	8
3.1.3 Audio Magnetic Calibration Coil (AMCC)	9
3.1.4 Audio Magnetic Measuring Instrument (AMMI)	9
3.1.5 Data Acquisition Electronics (DAE)	9
3.1.6 Phantoms	10
3.1.7 Device Holder.....	10
3.2 System Calibration	11
3.3 EUT Measurements Reference and Plane	12
3.4 HAC T-Coil Measurement Procedure	13
3.5 Audio Reference Input Level	15
4. HAC Measurement Evaluation.....	16
4.1 Measurement Criteria.....	16
4.1.1 Field Intensity	16
4.1.2 Frequency Response	16
4.1.3 Signal Quality	17
4.2 EUT Configuration and Setting.....	17
4.3 EUT Reference Level Calibration	17
4.4 HAC T-Coil Testing Results	18
5. Calibration of Test Equipment.....	19
6. Measurement Uncertainty.....	20
7. Information on the Testing Laboratories.....	21
Appendix A. Plots of HAC T-Coil Measurement	
Appendix B. Calibration Certificate for Probe	
Appendix C. Photographs of EUT and Setup	



Release Control Record

Report No.	Reason for Change	Date Issued
SA151222C07-2	Initial release	Jan. 21, 2016



1. Summary of Maximum T-Rating

Mode / Band	Test Item	Criterion	Test Results	T-Rating
CDMA BC0	Field Intensity	≥ -18 dB	-8.25	T4
	Frequency Response	Pass	Pass	
	Signal Quality	T3 : ≥ 20 dB	45.46	
CDMA BC1	Field Intensity	≥ -18 dB	-7.63	T4
	Frequency Response	Pass	Pass	
	Signal Quality	T3 : ≥ 20 dB	44.61	
CDMA BC10	Field Intensity	≥ -18 dB	-9.40	T4
	Frequency Response	Pass	Pass	
	Signal Quality	T3 : ≥ 20 dB	44.96	
Summary				T4

Note:

- 1. The HAC T-Coil limit (**T-Rating Category T3**) is specified in FCC 47 CFR part 20.19 and ANSI C63.19.
- 2. The device T-Coil rating is determined by the minimum rating.



FCC HAC (T-Coil) Test Report

2. Description of Equipment Under Test

EUT Type	Smartphone
FCC ID	V65C6743
Brand Name	Kyocera
Model Name	C6743
Tx Frequency Bands (Unit: MHz)	CDMA BC0 : 824.7 ~ 848.31 CDMA BC1 : 1851.25 ~ 1908.75 CDMA BC10 : 817.9 ~ 823.1
Uplink Modulations	QPSK
Antenna Type	Fixed Internal Antenna
EUT Stage	Identical Prototype

Note:

- The above EUT information is declared by manufacturer and for more detailed features description please refers to the manufacturer's specifications or User's Manual.

Air Interface and Operational Mode							
Air Interface	Bands	Type Transport	HAC Tested	Simultaneous But Not Tested	Voice Over Digital Transport OTT Capability	WiFi Low Power	Additional GSM Power Reduction
CDMA	BC0	VO	YES	WLAN or BT	N/A	N/A	N/A
	BC1						
	BC10						
	EVDO	DT	N/A	WLAN or BT	YES		
LTE	25	DT	N/A	WLAN or BT	YES	N/A	N/A
	26						
	41						
WLAN	2.4G	DT	N/A	WWAN	YES	N/A	N/A
Bluetooth	2.4G	DT	N/A	WWAN	N/A	N/A	N/A
Type Transport VO = Voice only DT = Digital Data – Not Indented for CMRS Service VD = CMRS and Data transport							

3. HAC RF Emission Measurement System

3.1 SPEAG DASY System

DASY system consists of high precision robot, probe alignment sensor, phantom, robot controller, controlled measurement server and near-field probe. The robot includes six axes that can move to the precision position of the DASY5 software defined. The DASY software can define the area that is detected by the probe. The robot is connected to controlled box. Controlled measurement server is connected to the controlled robot box. The DAE includes amplifier, signal multiplexing, AD converter, offset measurement and surface detection. It is connected to the Electro-optical coupler (ECO). The ECO performs the conversion from the optical into digital electric signal of the DAE and transfers data to the PC.

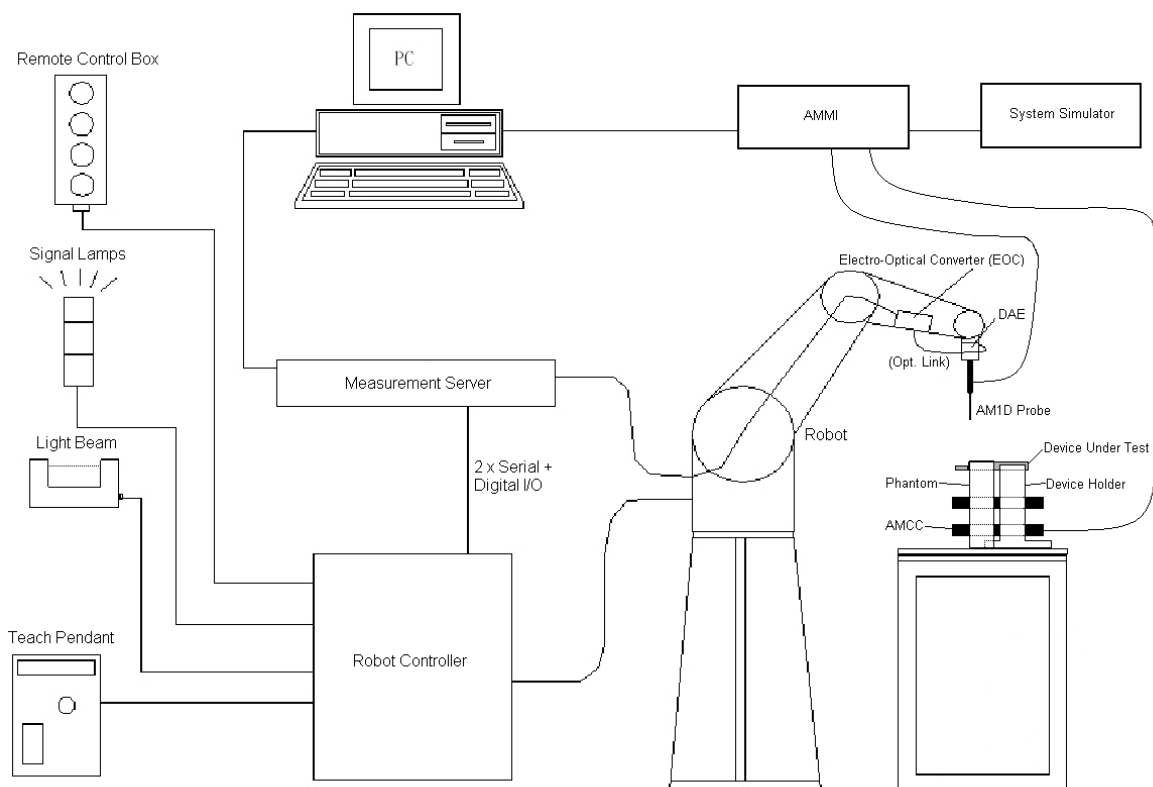

Fig-3.1 DASY System Setup

FCC HAC (T-Coil) Test Report

The principal cabling of the T-Coil setup is shown in below. All cables provided with the basic setup have a length of approximately 5 m.

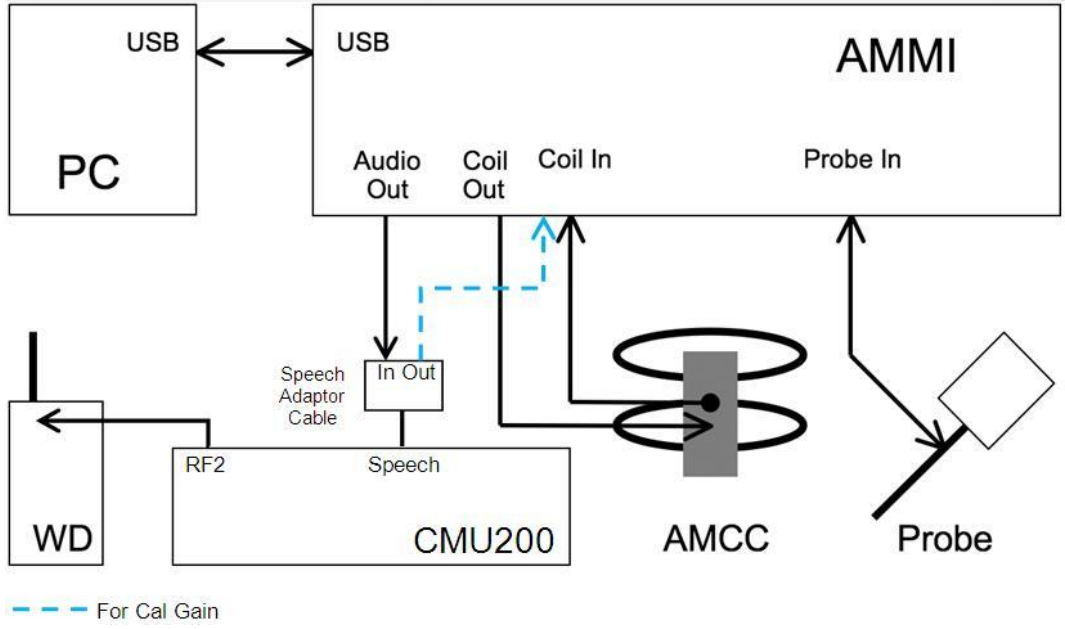

Fig-3.2a T-Coil Setup Cabling for 2G/3G

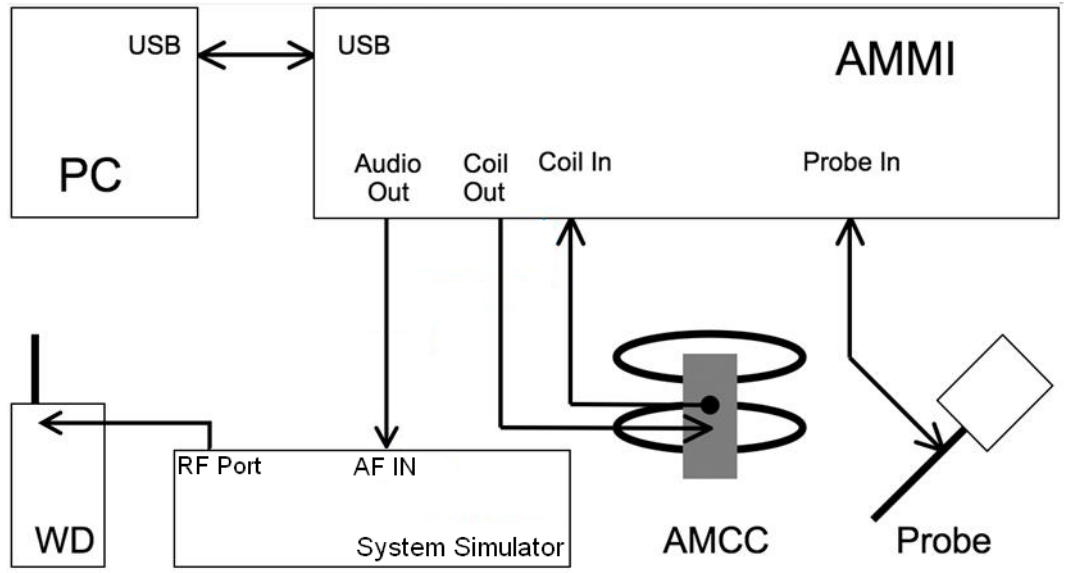

Fig-3.2b T-Coil Setup Cabling for VoLTE

FCC HAC (T-Coil) Test Report

3.1.1 Robot

The DASY system uses the high precision robots from Stäubli SA (France). For the 6-axis controller system, the robot controller version (DASY5: CS8c) from Stäubli is used. The Stäubli robot series have many features that are important for our application:

- High precision (repeatability ± 0.035 mm)
- High reliability (industrial design)
- Jerk-free straight movements
- Low ELF interference (the closed metallic construction shields against motor control fields)



Fig-3.3 DASY5

3.1.2 AM1D Probe

The AM1D probe is an active probe with a single sensor. It is fully RF-shielded and has a rounded tip 6 mm in diameter incorporating a pickup coil with its center offset 3 mm from the tip and the sides. The symmetric signal preamplifier in the probe is fed via the shielded symmetric output cable from the AMMI with a 48V “phantom” voltage supply. The 7-pin connector on the back in the axis of the probe does not carry any signals. It is mounted to the DAE for the correct orientation of the sensor. If the probe axis is tilted 54.7 degrees from the vertical, the sensor is approximately vertical when the signal connector is at the underside of the probe (cable hanging downwards).

Model	AM1DV3	
Sampling Rate	0.1 kHz to 20 kHz RF sensitivity < -100 dB	
Preamplifier	Symmetric, 40 dB	
Dynamic Range	-60 to 40 dB A/m	
Calibration	at 1kHz	
Dimensions	Tip diameter : 6 mm Length : 290 mm	

FCC HAC (T-Coil) Test Report

3.1.3 Audio Magnetic Calibration Coil (AMCC)

The AMCC is a Helmholtz Coil designed for calibration of the AM1D probe. The two horizontal coils generate a homogeneous magnetic field in the z direction. The DC input resistance is adjusted by a series resistor to approximately 50 Ohm, and a shunt resistor of 10 Ohm permits monitoring the current with a scale of 1:10.

Signal	Connector	Resistance
Coil In	BNC	Typically 50 Ohm
Coil Monitor	BNO	10 Ohm \pm 1% (100mV corresponding to 1 A/m)
Dimensions	370 x 370 x 196 mm	

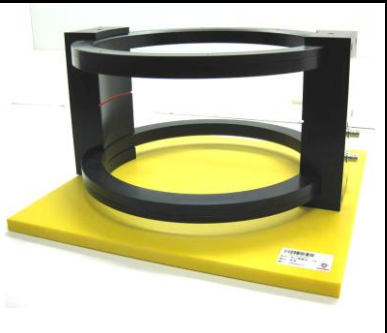

3.1.4 Audio Magnetic Measuring Instrument (AMMI)

The AMMI is a desktop 19-inch unit containing a sampling unit, a waveform generator for test and calibration signals, and a USB interface.

Sampling Rate	48 kHz / 24 bit
Dynamic Range	100 dB (with AM1DV3 probe)
Test Signal Generation	User selectable and predefined (via PC)
Calibration	Auto-calibration / full system calibration using AMCC with monitor output
Dimensions	482 x 65 x 270 mm

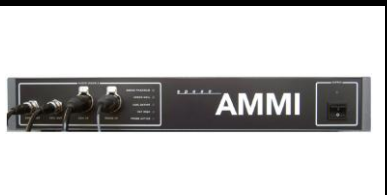

3.1.5 Data Acquisition Electronics (DAE)

Model	DAE3, DAE4
Construction	Signal amplifier, multiplexer, A/D converter and control logic. Serial optical link for communication with DASY embedded system (fully remote controlled). Two step probe touch detector for mechanical surface detection and emergency robot stop.
Measurement Range	-100 to +300 mV (16 bit resolution and two range settings: 4mV, 400mV)
Input Offset Voltage	< 5 μ V (with auto zero)
Input Bias Current	< 50 fA
Dimensions	60 x 60 x 68 mm



FCC HAC (T-Coil) Test Report

3.1.6 Phantoms

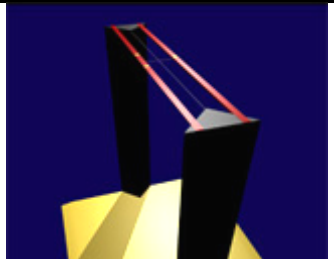
Model	Test Arch	
Construction	Enables easy and well defined positioning of the phone and validation dipoles as well as simple teaching of the robot.	
Dimensions	Length : 370 mm Width : 370 mm Height : 370 mm	

3.1.7 Device Holder

Model	Mounting Device	
Construction	The Mounting Device enables the rotation of the mounted transmitter device in spherical coordinates. Rotation point is the ear opening point. Transmitter devices can be easily and accurately positioned according to ANSI C63.19.	
Material	POM	

FCC HAC (T-Coil) Test Report

3.2 System Calibration

For correct and calibrated measurement of the voltages and ABM field, DASY will perform a calibration job as below. In phase 1, the audio output is switched off, and a 200 mV_{pp} symmetric rectangular signal of 1 kHz is generated and internally connected directly to both channels of the sampling unit (Coil in, Probe in).

In phase 2, the audio output is off, and a 20 mV_{pp} symmetric 100 Hz signal is internally connected. The signals during phases 1 and 2 are available at the output on the rear panel of the AMMI. However, the output must not be loaded, in order to avoid influencing the calibration. An RMS voltmeter would indicate 100 mV_{RMS} during the first phase and 10 mV_{RMS} during the second phase. After the first two phases, the two input channels are both calibrated for absolute measurements of voltages. The resulting factors are displayed above the multi-meter window.

After phases 1 and 2, the input channels are calibrated to measure exact voltages. This is required to use the inputs for measuring voltages with their peak and RMS value.

In phase 3, a multi-sine signal covering each third-octave band from 50 Hz to 10 kHz is generated and applied to both audio outputs. The probe should be positioned in the center of the AMCC and aligned in the z-direction, the field orientation of the AMCC. The "Coil In" channel is measuring the voltage over the AMCC internal shunt, which is proportional to the magnetic field in the AMCC. At the same time, the "Probe In" channel samples the amplified signal picked up by the probe coil and provides it to a numerical integrator. The ratio of the two voltages in each third-octave filter leads to the spectral representation over the frequency band of interest. The Coil signal is scaled in dBV, and the Probe signal is first integrated and normalized to show dB A/m. The ratio probe-to-coil at the frequency of 1 kHz is the sensitivity which will be used in the consecutive T-Coil jobs.

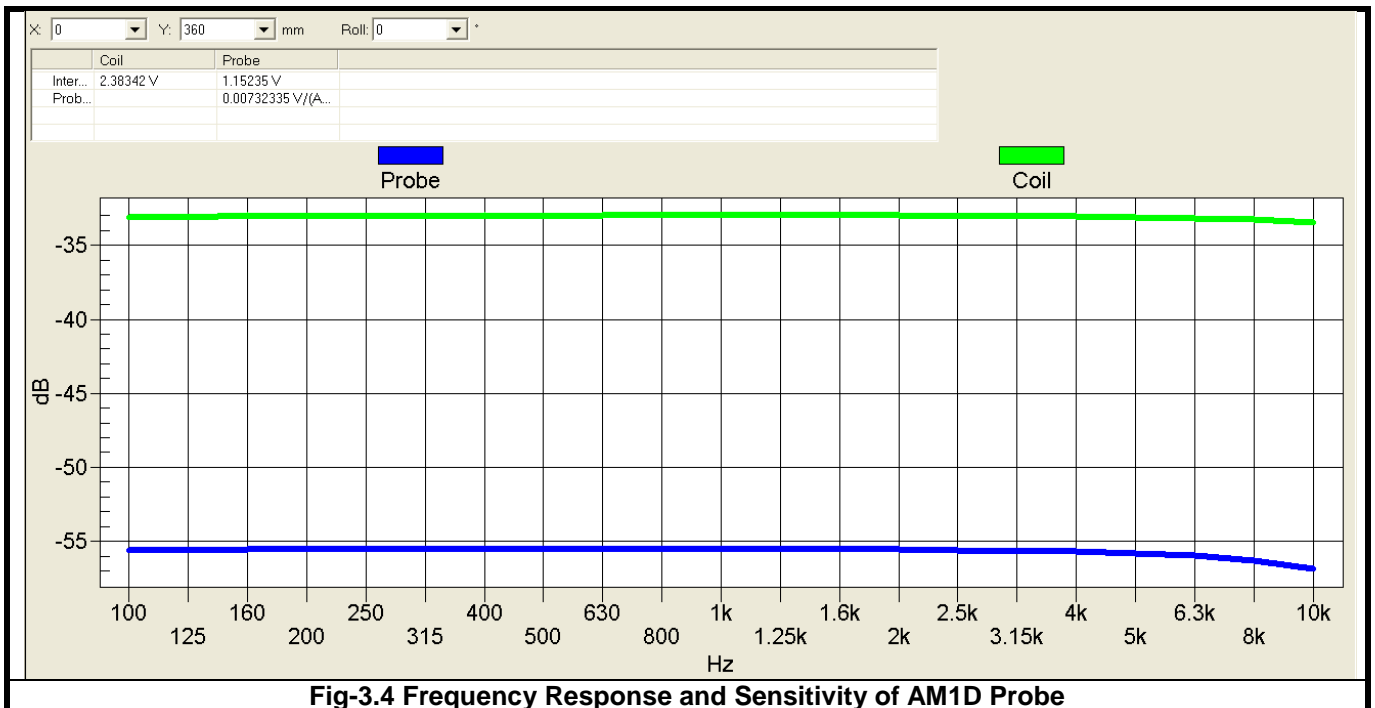

Fig-3.4 Frequency Response and Sensitivity of AM1D Probe

3.3 EUT Measurements Reference and Plane

The EUT is mounted in the device holder. The acoustic output of the EUT will coincide with the center point of the area formed by the dielectric wire and the middle bar of the arch's top frame. Then EUT will be moved vertically upwards until it touches the frame.

Figure 3.5 illustrates the three standard probe orientations. Position 1 is the perpendicular (axial) orientation of the probe coil. Orientation 2 is the transverse (radial) orientation. The space between the measurement positions is not fixed. It is recommended that a scan of the EUT be done for each probe coil orientation and that the maximum level recorded be used as the reading for that orientation of the probe coil.

- (1) The reference plane is the planar area that contains the highest point in the area of the phone that normally rests against the user's ear. It is parallel to the centerline of the receiver area of the phone and is defined by the points of the receiver-end of the EUT handset that, in normal handset use, rest against the ear.
- (2) The measurement plane is parallel to, and 10 mm in front of the reference plane.
- (3) The reference axis is normal to the reference plane and passes through the center of the receiver speaker section or it may be centered on a secondary inductive source.
- (4) The measurement points may be located where the perpendicular (axial) and transverse (radial) field intensity measurements are optimum with regard to the requirements. However, the measurement points should be near the acoustic output of the EUT and shall be located in the same half of the phone as the EUT receiver. In a EUT handset with a centered receiver and a circularly symmetrical magnetic field, the measurement axis and the reference axis would coincide.
- (5) The relative spacing of each measurement orientations is not fixed. The perpendicular (axial) and transverse (radial) orientations should be chosen to select the optimal position.
- (6) The measurement point for the axial position is located 10 mm from the reference plane on the measurement axis.

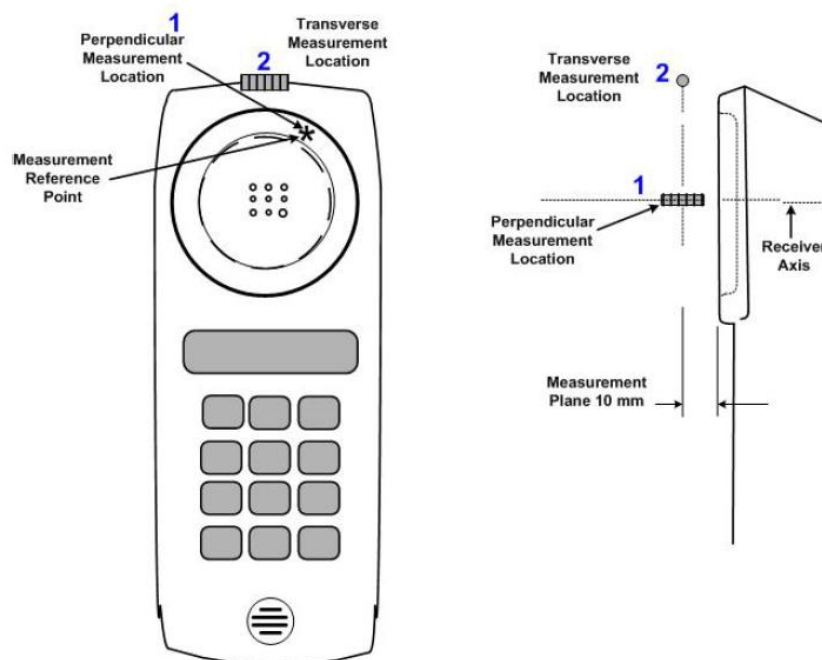

Fig-3.5 Axis and Planes

3.4 HAC T-Coil Measurement Procedure

According to ANSI C63.19-2011, the T-Coil test procedure for wireless communications device is as below.

1. Position the EUT in the test setup and connect the EUT RF connector to a base station simulator.
2. The drive level to the EUT is set such that the reference input level specified in Table 7.1 is input to the base station simulator in the 1 kHz, 1/3 octave band. This drive level shall be used for the T-Coil signal test (ABM1) at $f = 1$ kHz. Either a sine wave at 1025 Hz or a voice-like signal, band-limited to the 1 kHz 1/3 octave, as defined in 7.4.2, shall be used for the reference audio signal. If interference is found at 1025 Hz, an alternate nearby reference audio signal frequency may be used. The same drive level will be used for the ABM1 frequency response measurements at each 1/3 octave band center frequency. The EUT volume control may be set at any level up to maximum, provided that a signal at any frequency at maximum modulation would not result in clipping or signal overload.
3. Determine the magnetic measurement locations for the EUT, if not already specified by the manufacturer, as described in 7.4.4.1.1 and 7.4.4.2.
4. At each measurement location, measure and record the desired T-Coil magnetic signals (ABM1 at f_i) as described in 7.4.4.2 in each individual ISO 266-1975 R10 standard 1/3 octave band. The desired audio band input frequency (f_i) shall be centered in each 1/3 octave band maintaining the same drive level as determined in Step 2 and the reading taken for that band. Equivalent methods of determining the frequency response may also be employed, such as fast Fourier transform (FFT) analysis using noise excitation or input–output comparison using simulated speech. The full-band integrated or half-band integrated probe output, as described in D.9, may be used, as long as the appropriate calibration curve is applied to the measured result, so as to yield an accurate measurement of the field magnitude. (The resulting measurement shall be an accurate measurement in dB A/m.) All measurements of the desired signal shall be shown to be of the desired signal and not of an undesired signal. This may be shown by turning the desired signal on and off with the probe measuring the same location. If the scanning method is used, the scans shall show that all measurement points selected for the ABM1 measurement meet the ambient and test system noise criterion in 7.3.1.
5. At the measurement location for each orientation, measure and record the undesired broadband audio magnetic signal (ABM2) as described in 7.4.4.4 with no audio signal applied (or digital zero applied, if appropriate) using A-weighting, and the half-band integrator. Calculate the ratio of the desired to undesired signal strength (i.e., signal quality).
6. Determine the category that properly classifies the signal quality based on Table 8.5.

FCC HAC (T-Coil) Test Report

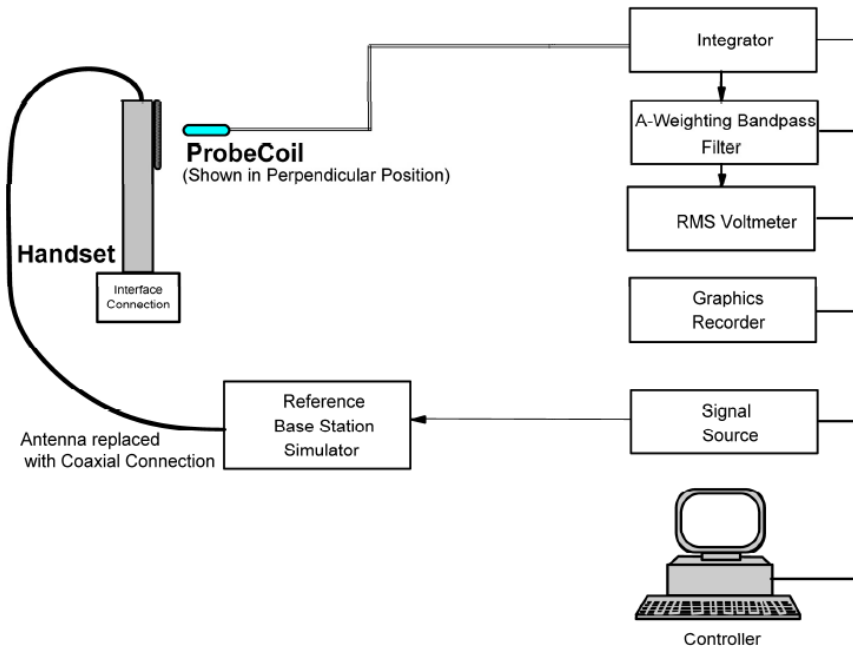

Fig-3.6 T-Coil Measurement Test Setup

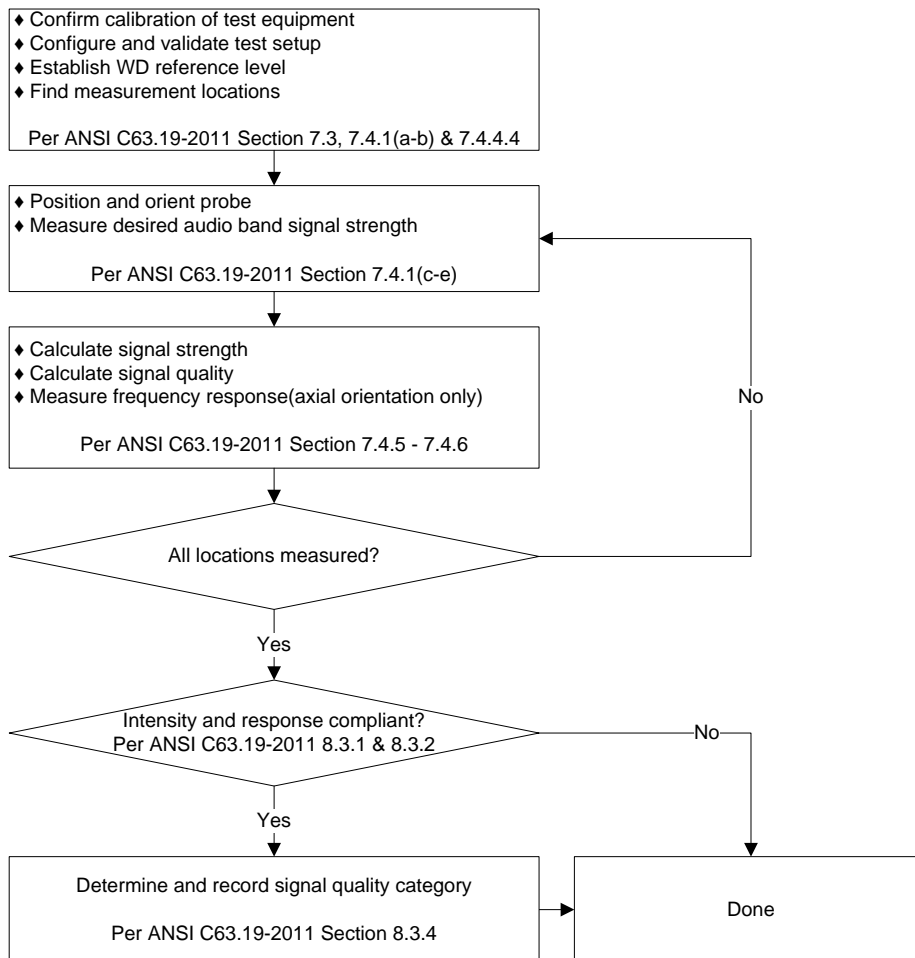

Fig-3.7 T-Coil Signal Test Flowchart

FCC HAC (T-Coil) Test Report

3.5 Audio Reference Input Level

According to ANSI C63.19-2011 section 7.4.2.1, the normal speech input level for HAC T-coil tests shall be set to -16 dBm0 for GSM and WCDMA, and to -18 dBm0 for CDMA. The technical description below shows a possibility to evaluate and set the correct level with the HAC T-Coil setup with a Rohde&Schwarz communication tester CMU200 with codec.

Establish a call from the CMU200 to a wireless device. Select CMU200 Network Bitstream "Decoder Cal" to obtain a 1 kHz signal from the internal generator with a level of 3.14 dBm0 at the speech output. Run the measurement job and read the voltage level at the multi-meter display RMS Coil signal. Read the RMS Coil signal voltage corresponding to 3.14 dBm0 and note it. Calculate the desired signal levels of -16 dBm0 and/or -18 dBm0.

$$3.14 \text{ dBm0} = X \text{ dBV}$$

$$-16 \text{ dBm0} = L_{-16\text{dBm0}} \text{ dBV}$$

$$L_{-16\text{dBm0}} = (-16) - (3.14) + X$$

$$-18 \text{ dBm0} = L_{-18\text{dBm0}} \text{ dBV}$$

$$L_{-18\text{dBm0}} = (-18) - (3.14) + X$$

Determine the 1 kHz gain level to generate the desired signal level of -16 dBm0 and/or -18 dBm0. Select CMU200 Network Bitstream "Encoder Cal" to loop the input via the codec to the output. Run the measurement job (AMMI 1 kHz signal with gain 10 inserted) and read the RMS voltage level at the multi-meter display RMS Coil signal. Calculate the required gain setting for the desired level.

$$\text{Gain } 10 = G \text{ dBV}$$

$$\text{Difference for } -16 \text{ dBm0} = D_{-16\text{dBm0}} = L_{-16\text{dBm0}} - G$$

$$\text{Resulting Gain for } -16 \text{ dBm0} = 10^{(D_{-16\text{dBm0}} / 20)} * 10$$

$$\text{Difference for } -18 \text{ dBm0} = D_{-18\text{dBm0}} = L_{-18\text{dBm0}} - G$$

$$\text{Resulting Gain for } -18 \text{ dBm0} = 10^{(D_{-18\text{dBm0}} / 20)} * 10$$

The gain setting for other signal types need to be adjusted to achieve the same average level. Those signal types have the following differences/factors compared to the 1 kHz sine signal:

Signal Type	Duration (s)	BWC (dB)	Required Gain Factor
1 kHz sine	-	0.0	1.00
48k_voice_1kHz	1	0.16	4.33
48k_voice_300-3000	2	10.8	8.48

Note: Gain Setting = Resulting Gain * Required Gain Factor

The result of calculated gain setting is shown in section 4.3 of this report.

4. HAC Measurement Evaluation

4.1 Measurement Criteria

The HAC Standard ANSI C63.19-2011 represents performance requirements for acceptable interoperability of hearing aids with wireless communications devices. When these parameters are met, a hearing aid operates acceptably in close proximity to a wireless communications device.

4.1.1 Field Intensity

When measured as specified in this standard, the T-Coil signal shall be ≥ -18 dB (A/m) at 1 kHz, in a 1/3 octave band filter for all orientations.

4.1.2 Frequency Response

The frequency response of the axial component of the magnetic field, measured in 1/3 octave bands, shall follow the below response curve, over the frequency range 300 Hz to 3000 Hz. Figure 4.1 and Figure 4.2 provide the boundaries for the specified frequency. These response curves are for true field strength measurements of the T-Coil signal. Thus the 6 dB/octave probe response has been corrected from the raw readings.

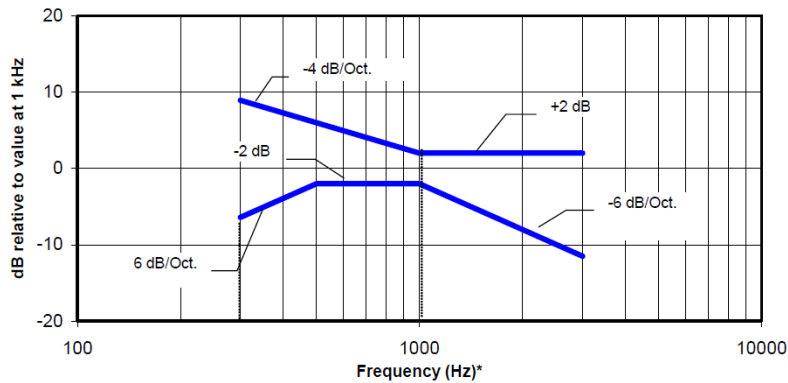

Fig-4.1 Boundaries for EUT with a field ≤ -15 dB (A/m) at 1 kHz

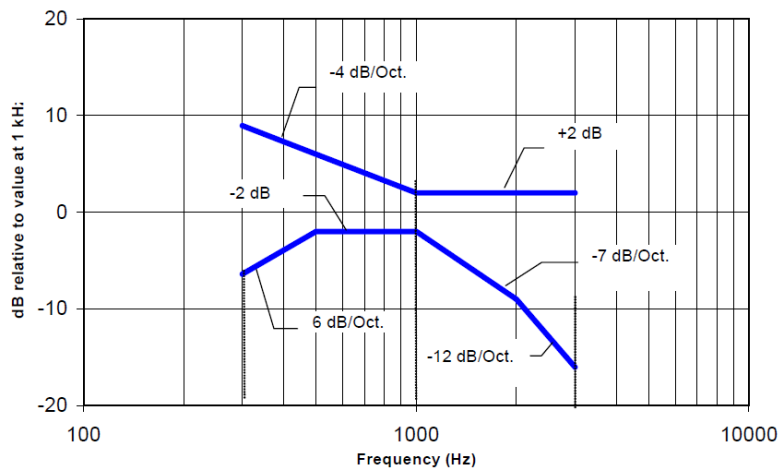

Fig-4.2 Boundaries for EUT with a field > -15 dB (A/m) at 1 kHz

FCC HAC (T-Coil) Test Report

4.1.3 Signal Quality

The worst signal quality of the three T-Coil signal measurements shall be used to determine the T-Coil mode category per below table.

Category	Telephone Parameters WD Signal Quality (Signal to Noise Ratio, in dB)
Category T1	0 – 10
Category T2	10 – 20
Category T3	20 – 30
Category T4	> 30

4.2 EUT Configuration and Setting

For HAC T-Coil testing, the EUT was linked and controlled by base station emulator. Communication between the EUT and the emulator was established by coaxial connection. The EUT was set from the emulator to radiate maximum output power during HAC testing.

4.3 EUT Reference Level Calibration

The predefined signal types have the following differences / factors compared to the 1 kHz sine signal:

Audio Signal Level (dBm0)	Signal Type	Duration (s)	Gain Factor	Measured / Desired Level (dBV)	Calculated Gain Setting	Adjusted Gain Setting
3.14	1 kHz sine	-	1.00	-2.50	-	-
-18	1 kHz sine	-	1.00	-23.64	6.42	6.42
-18	48k_voice_1kHz	1	4.33	-23.64	27.80	27.80
-18	48k_voice_300-3000	2	8.48	-23.64	54.44	54.44

Note:

1. The gain setting for the voice signal (1 kHz and 300-3000 Hz) will be multiplied by the gain factor to achieve approximately the same level as for the 1 kHz sine signal.
2. If the measurement for each signal type with calculated gain setting does not meet the desired level, the gain setting will be fine adjusted manually until the desired level is obtained.



FCC HAC (T-Coil) Test Report

A D T

4.4 HAC T-Coil Testing Results

Plot No.	Band	CH	Probe Orientation	Frequency Response	Coordinates (mm)	ABM2 (dB A/m)	ABM1 (dB A/m)	SNR (dB)	T-Rating
01	CDMA BC0	1013	Axial (Z)	Pass	-1, 0.5, 3.7	-45.03	0.83	45.86	T4
			Radial (Y)	-	-3.5, 10.5, 3.7	-54.36	-7.90	46.46	T4
		384	Axial (Z)	Pass	-1.5, 0.5, 3.7	-45.11	0.42	45.53	T4
			Radial (Y)	-	-1, 11, 3.7	-53.76	-8.25	45.51	T4
		777	Axial (Z)	Pass	0, 1.5, 3.7	-43.80	1.66	45.46	T4
			Radial (Y)	-	-1, 11.5, 3.7	-53.73	-7.84	45.89	T4
02	CDMA BC1	25	Axial (Z)	Pass	-0.5, -0.5, 3.7	-43.85	0.97	44.82	T4
			Radial (Y)	-	-1.5, 10, 3.7	-52.91	-7.35	45.56	T4
		600	Axial (Z)	Pass	-2, 0, 3.7	-44.54	0.07	44.61	T4
			Radial (Y)	-	-1, -10.5, 3.7	-52.32	-7.63	44.69	T4
		1175	Axial (Z)	Pass	-1.5, 0, 3.7	-44.69	1.19	45.88	T4
			Radial (Y)	-	-1.5, 10.5, 3.7	-53.24	-7.19	46.05	T4
03	CDMA BC10	476	Axial (Z)	Pass	-1, 0.5, 3.7	-44.82	0.87	45.69	T4
			Radial (Y)	-	-1, 12.5, 3.7	-53.80	-8.84	44.96	T4
		580	Axial (Z)	Pass	-0.5, 0, 3.7	-45.00	0.48	45.48	T4
			Radial (Y)	-	-4.5, 11, 3.7	-54.46	-9.40	45.06	T4
		684	Axial (Z)	Pass	-0.5, 0, 3.7	-44.91	0.05	44.96	T4
			Radial (Y)	-	-1, 10.5, 3.7	-54.04	-7.83	46.21	T4

Test Engineer : Willy Chang



5. Calibration of Test Equipment

Equipment	Manufacturer	Model	SN	Cal. Date	Cal. Interval
Audio Band Magnetic Probe	SPEAG	AM1DV3	3067	Dec. 10, 2015	1 Year
Data Acquisition Electronics	SPEAG	DAE3	579	Aug. 24, 2015	1 Year
Universal Radio Communication Tester	R&S	CMU200	104484	Mar. 11, 2015	1 Year



6. Measurement Uncertainty

Error Description	Uncertainty Value (±%)	Probability Distribution	Divisor	Ci (ABM1)	Ci (ABM2)	Standard Uncertainty (ABM1)	Standard Uncertainty (ABM2)
Probe Sensitivity							
Reference Level	3.0	Normal	1	1	1	± 3.0 %	± 3.0 %
AMCC Geometry	0.4	Rectangular	√3	1	1	± 0.2 %	± 0.2 %
AMCC Current	1.0	Rectangular	√3	1	1	± 0.6 %	± 0.6 %
Probe Positioning During Calibration	0.1	Rectangular	√3	1	1	± 0.1 %	± 0.1 %
Noise Contribution	0.7	Rectangular	√3	0.0143	1	± 0.0 %	± 0.4 %
Frequency Slope	5.9	Rectangular	√3	0.1	1	± 0.3 %	± 3.5 %
Probe System							
Repeatability / Drift	1.0	Rectangular	√3	1	1	± 0.6 %	± 0.6 %
Linearity / Dynamic Range	0.6	Rectangular	√3	1	1	± 0.4 %	± 0.4 %
Acoustic Noise	1.0	Rectangular	√3	0.1	1	± 0.1 %	± 0.6 %
Probe Angle	2.3	Rectangular	√3	1	1	± 1.4 %	± 1.4 %
Spectral Processing	0.9	Rectangular	√3	1	1	± 0.5 %	± 0.5 %
Integration Time	0.6	Normal	1	1	5	± 0.6 %	± 3.0 %
Field Distribution	0.2	Rectangular	√3	1	1	± 0.1 %	± 0.1 %
Test Signal							
Ref. Signal Spectral Response	0.6	Rectangular	√3	0	1	± 0.0 %	± 0.4 %
Positioning							
Probe Positioning	1.9	Rectangular	√3	1	1	± 1.1 %	± 1.1 %
Phantom Thickness	0.9	Rectangular	√3	1	1	± 0.5 %	± 0.5 %
EUT Positioning	1.9	Rectangular	√3	1	1	± 1.1 %	± 1.1 %
External Contributions							
RF Interference	0.0	Rectangular	√3	1	0.3	± 0.0 %	± 0.0 %
Test Signal Variation	2.0	Rectangular	√3	1	1	± 1.2 %	± 1.2 %
Combined Standard Uncertainty						± 4.1 %	± 6.1 %
Coverage Factor for 95 %						K = 2	
Expanded Uncertainty						± 8.1 %	± 12.3 %

Uncertainty Budget for HAC T-Coil



FCC HAC (T-Coil) Test Report

7. Information on the Testing Laboratories

We, Bureau Veritas Consumer Products Services (H.K.) Ltd., Taoyuan Branch, were founded in 1988 to provide our best service in EMC, Radio, Telecom and Safety consultation. Our laboratories are accredited and approved according to ISO/IEC 17025.

If you have any comments, please feel free to contact us at the following:

Taiwan HwaYa EMC/RF/Safety/Telecom Lab:

Add: No. 19, Hwa Ya 2nd Rd, Wen Hwa Vil., Kwei Shan Hsiang, Taoyuan Hsien 333, Taiwan, R.O.C.

Tel: 886-3-318-3232

Fax: 886-3-327-0892

Taiwan LinKo EMC/RF Lab:

Add: No. 47-2, 14th Ling, Chia Pau Vil., Linkou Dist., New Taipei City 244, Taiwan, R.O.C.

Tel: 886-2-2605-2180

Fax: 886-2-2605-1924

Taiwan HsinChu EMC/RF Lab:

Add: No. 81-1, Lu Liao Keng, 9th Ling, Wu Lung Vil., Chiung Lin Township, Hsinchu County 307, Taiwan, R.O.C.

Tel: 886-3-593-5343

Fax: 886-3-593-5342

Email: service.adt@tw.bureauveritas.com

Web Site: www.adt.com.tw

The road map of all our labs can be found in our web site also.

---END---



Appendix A. Plots of HAC T-Coil Measurement

The plots for HAC measurement are shown as follows.

P01 CDMA2000 BC0_RC1+SO3_Ch777_Axial (Z)

DUT: 151222C07

Communication System: CDMA2000; Frequency: 848.31 MHz; Duty Cycle: 1:1

Medium: Air Medium parameters used: $\sigma = 0 \text{ S/m}$, $\epsilon_r = 1$; $\rho = 1 \text{ kg/m}^3$

Ambient Temperature : 23.5 °C

DASY5 Configuration:

- Probe: AM1DV3 - 3067; ; Calibrated: 2015/12/10
- Sensor-Surface: 0mm (Fix Surface)
- Electronics: DAE3 Sn579; Calibrated: 2015/08/24
- Phantom: HAC Test Arch with AMCC; Type: SD HAC P01 BA;
- Measurement SW: DASY52, Version 52.8 (8); SEMCAD X Version 14.6.10 (7331)

T-Coil scan (scan for ANSI C63.19 compliance)/General Scans: Interpolated grid:

dx=1.000 mm, dy=1.000 mm

ABM1/ABM2 = 45.46 dB

ABM1 comp = 1.66 dBA/m

Location: 0, 1.5, 3.7 mm

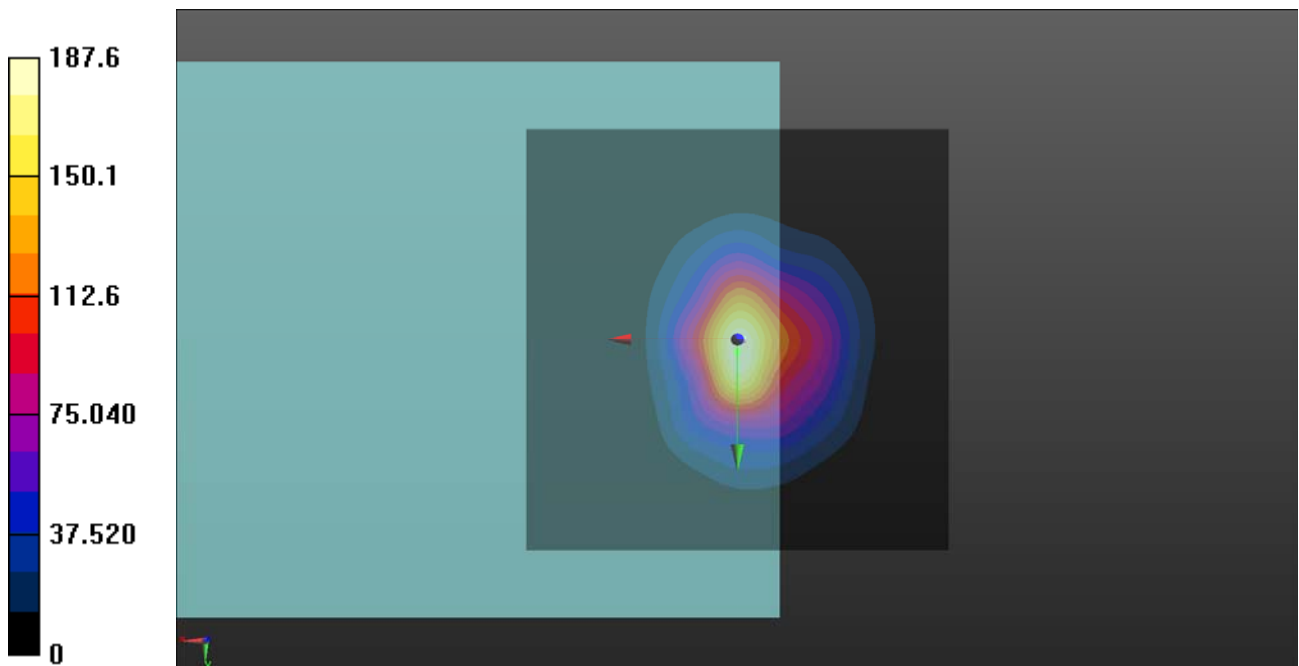

P01 CDMA2000 BC0_RC1+SO3_Ch777_Radial (Y)

DUT: 151222C07

Communication System: CDMA2000; Frequency: 848.31 MHz; Duty Cycle: 1:1

Medium: Air Medium parameters used: $\sigma = 0$ S/m, $\epsilon_r = 1$; $\rho = 1$ kg/m³

Ambient Temperature : 23.5 °C

DASY5 Configuration:

- Probe: AM1DV3 - 3067; ; Calibrated: 2015/12/10
- Sensor-Surface: 0mm (Fix Surface)
- Electronics: DAE3 Sn579; Calibrated: 2015/08/24
- Phantom: HAC Test Arch with AMCC; Type: SD HAC P01 BA;
- Measurement SW: DASY52, Version 52.8 (8); SEMCAD X Version 14.6.10 (7331)

T-Coil scan (scan for ANSI C63.19 compliance)/General Scans: Interpolated grid:

dx=1.000 mm, dy=1.000 mm

ABM1/ABM2 = 45.89 dB

ABM1 comp = -7.84 dBA/m

Location: -1, 11.5, 3.7 mm

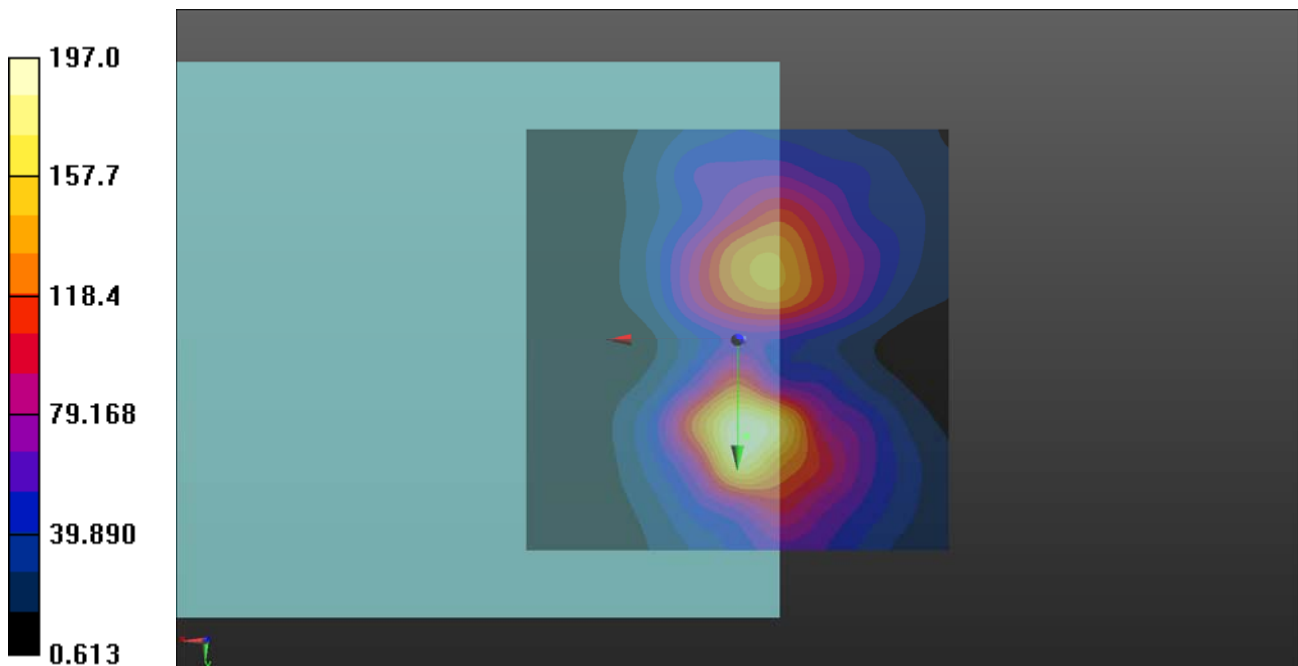

P01 CDMA2000 BC0_RC1+SO3_Ch777_Freq Resp

DUT: 151222C07

Communication System: CDMA2000; Frequency: 848.31 MHz; Duty Cycle: 1:1

Medium: Air Medium parameters used: $\sigma = 0 \text{ S/m}$, $\epsilon_r = 1$; $\rho = 1 \text{ kg/m}^3$

Ambient Temperature : 23.5 °C

DASY5 Configuration:

- Probe: AM1DV3 - 3067; ; Calibrated: 2015/12/10
- Sensor-Surface: 0mm (Fix Surface)
- Electronics: DAE3 Sn579; Calibrated: 2015/08/24
- Phantom: HAC Test Arch with AMCC; Type: SD HAC P01 BA;
- Measurement SW: DASY52, Version 52.8 (8); SEMCAD X Version 14.6.10 (7331)

T-Coil scan (scan for ANSI C63.19 compliance)/General Scans: Measurement grid: dx=10mm, dy=10mm

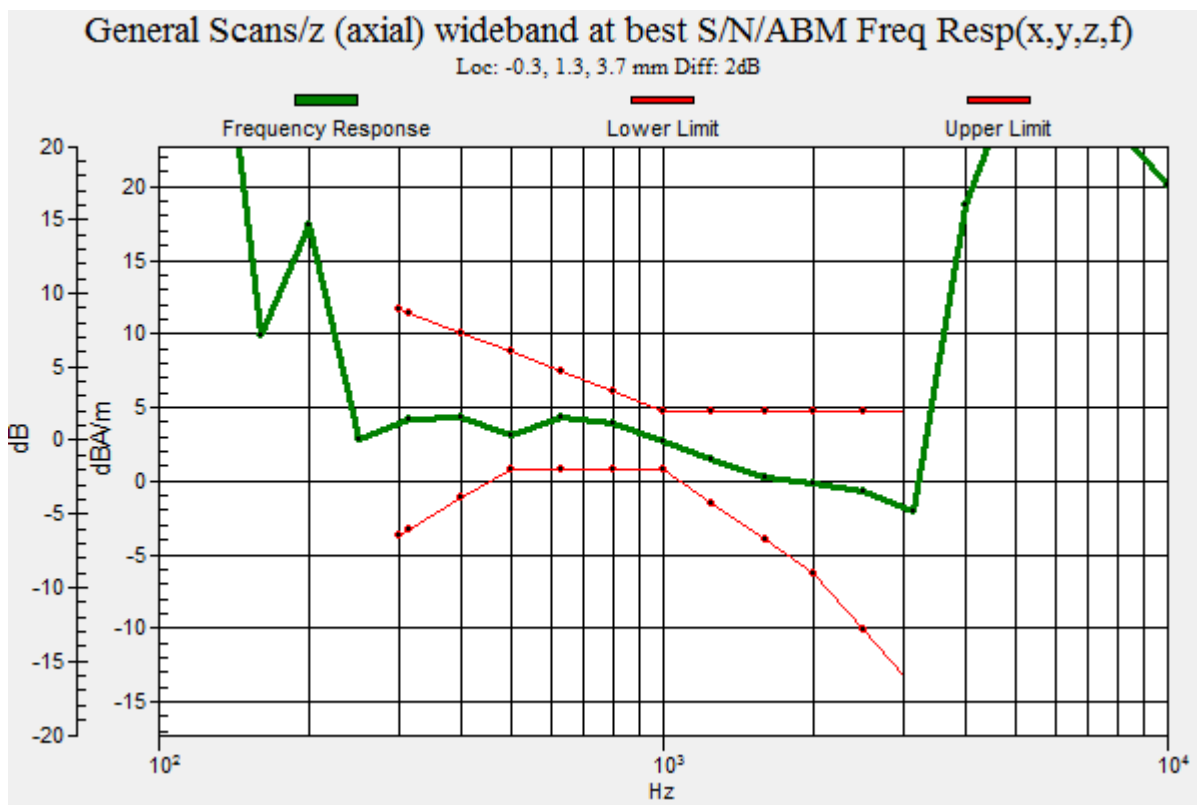

P02 CDMA2000 BC1_RC1+SO3_Ch600_Axial (Z)

DUT: 151222C07

Communication System: CDMA2000; Frequency: 1880 MHz; Duty Cycle: 1:1

Medium: Air Medium parameters used: $\sigma = 0$ S/m, $\epsilon_r = 1$; $\rho = 1$ kg/m³

Ambient Temperature : 23.5 °C

DASY5 Configuration:

- Probe: AM1DV3 - 3067; ; Calibrated: 2015/12/10
- Sensor-Surface: 0mm (Fix Surface)
- Electronics: DAE3 Sn579; Calibrated: 2015/08/24
- Phantom: HAC Test Arch with AMCC; Type: SD HAC P01 BA;
- Measurement SW: DASY52, Version 52.8 (8); SEMCAD X Version 14.6.10 (7331)

T-Coil scan (scan for ANSI C63.19 compliance)/General Scans: Interpolated grid:

dx=1.000 mm, dy=1.000 mm

ABM1/ABM2 = 44.61 dB

ABM1 comp = 0.07 dBA/m

Location: -2, 0, 3.7 mm

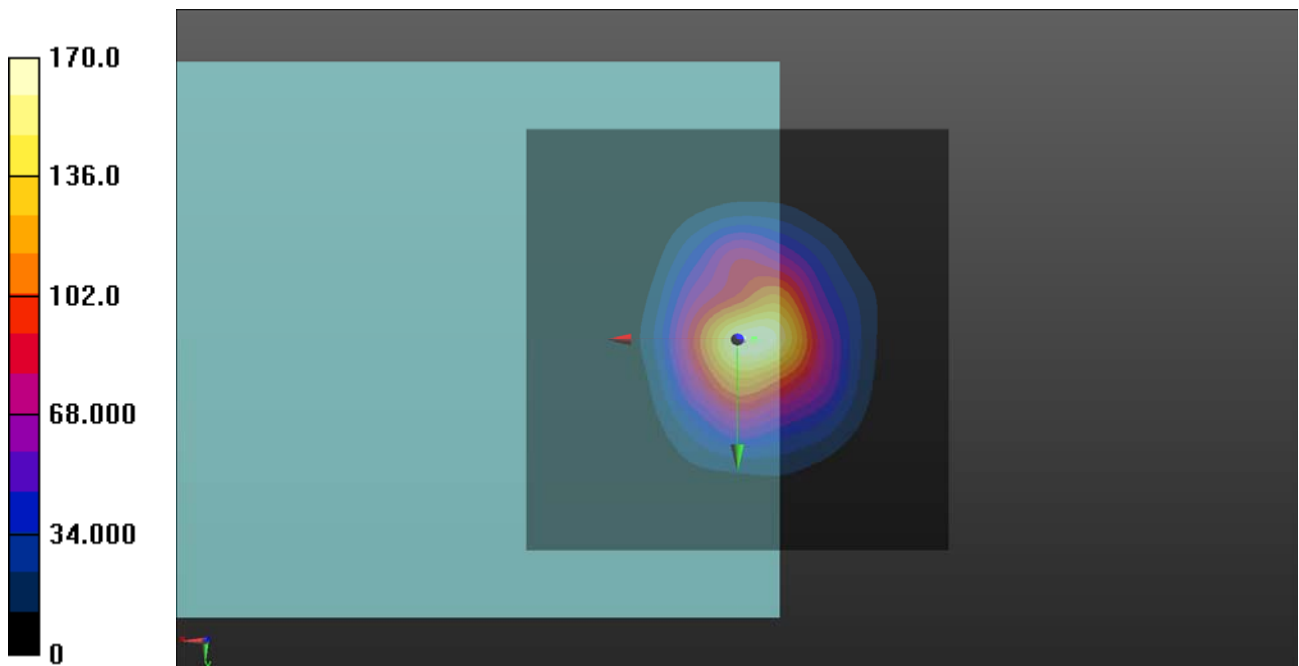

P02 CDMA2000 BC1_RC1+SO3_Ch600_Radial (Y)

DUT: 151222C07

Communication System: CDMA2000; Frequency: 1880 MHz; Duty Cycle: 1:1

Medium: Air Medium parameters used: $\sigma = 0$ S/m, $\epsilon_r = 1$; $\rho = 1$ kg/m³

Ambient Temperature : 23.5 °C

DASY5 Configuration:

- Probe: AM1DV3 - 3067; ; Calibrated: 2015/12/10
- Sensor-Surface: 0mm (Fix Surface)
- Electronics: DAE3 Sn579; Calibrated: 2015/08/24
- Phantom: HAC Test Arch with AMCC; Type: SD HAC P01 BA;
- Measurement SW: DASY52, Version 52.8 (8); SEMCAD X Version 14.6.10 (7331)

T-Coil scan (scan for ANSI C63.19 compliance)/General Scans: Interpolated grid:

dx=1.000 mm, dy=1.000 mm

ABM1/ABM2 = 44.69 dB

ABM1 comp = -7.63 dBA/m

Location: -1, -10.5, 3.7 mm

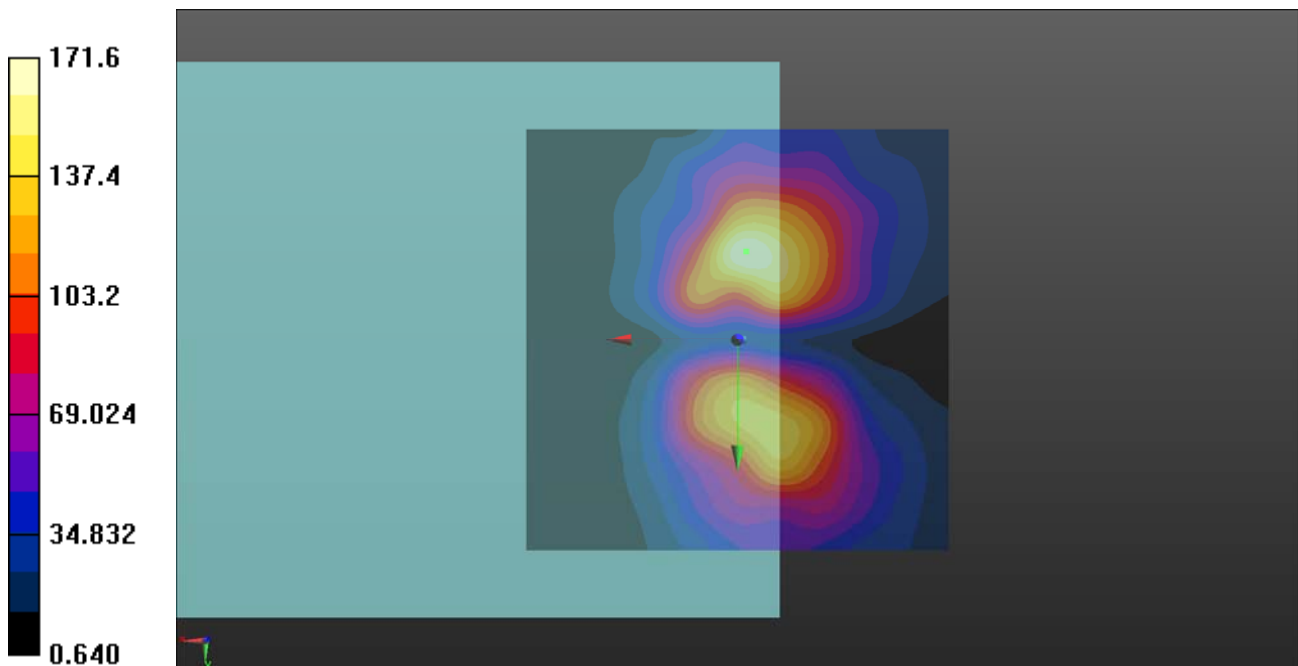

P02 CDMA2000 BC1_RC1+SO3_Ch600_Freq Resp

DUT: 151222C07

Communication System: CDMA2000; Frequency: 1880 MHz; Duty Cycle: 1:1

Medium: Air Medium parameters used: $\sigma = 0 \text{ S/m}$, $\epsilon_r = 1$; $\rho = 1 \text{ kg/m}^3$

Ambient Temperature : 23.5 °C

DASY5 Configuration:

- Probe: AM1DV3 - 3067; ; Calibrated: 2015/12/10
- Sensor-Surface: 0mm (Fix Surface)
- Electronics: DAE3 Sn579; Calibrated: 2015/08/24
- Phantom: HAC Test Arch with AMCC; Type: SD HAC P01 BA;
- Measurement SW: DASY52, Version 52.8 (8); SEMCAD X Version 14.6.10 (7331)

T-Coil scan (scan for ANSI C63.19 compliance)/General Scans: Measurement grid: dx=10mm, dy=10mm

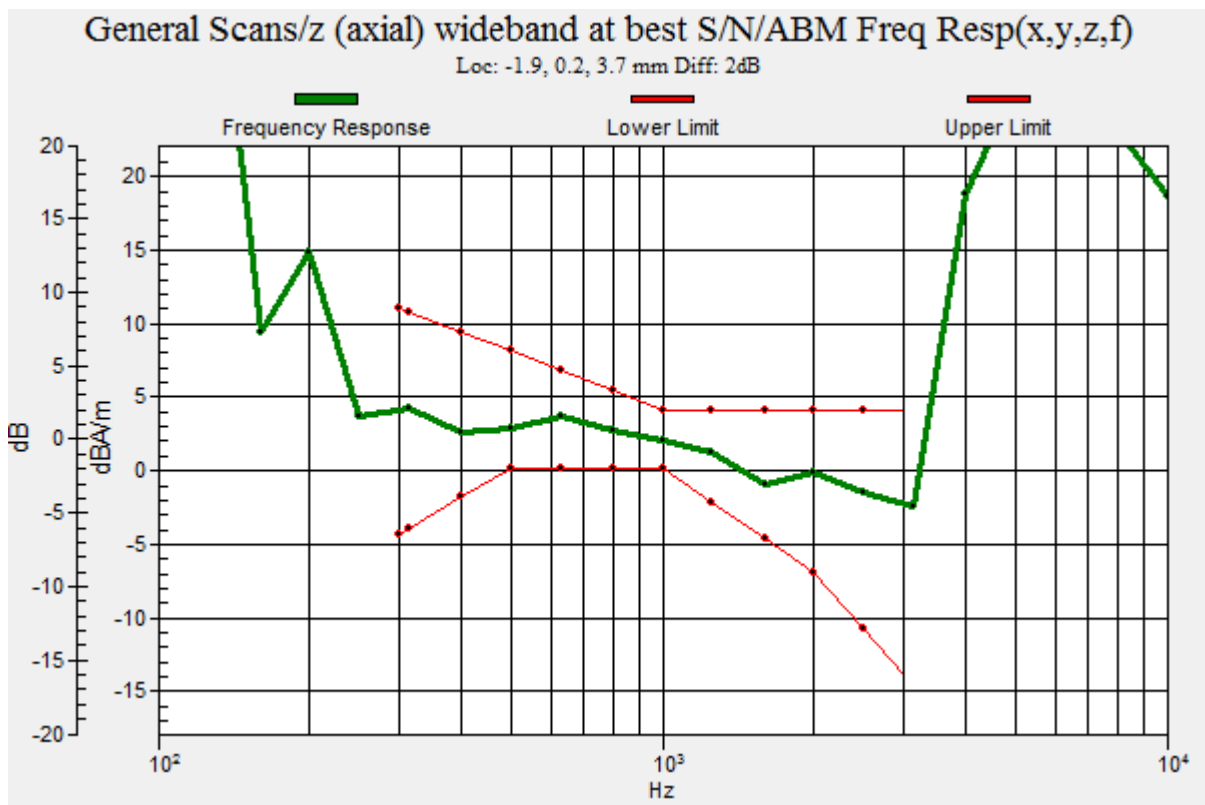

P03 CDMA2000 BC10_RC1+SO3_Ch476_Axial (Z)

DUT: 151222C07

Communication System: CDMA2000; Frequency: 817.9 MHz; Duty Cycle: 1:1

Medium: Air Medium parameters used: $\sigma = 0 \text{ S/m}$, $\epsilon_r = 1$; $\rho = 1 \text{ kg/m}^3$

Ambient Temperature : 23.5 °C

DASY5 Configuration:

- Probe: AM1DV3 - 3067; ; Calibrated: 2015/12/10
- Sensor-Surface: 0mm (Fix Surface)
- Electronics: DAE3 Sn579; Calibrated: 2015/08/24
- Phantom: HAC Test Arch with AMCC; Type: SD HAC P01 BA;
- Measurement SW: DASY52, Version 52.8 (8); SEMCAD X Version 14.6.10 (7331)

T-Coil scan (scan for ANSI C63.19 compliance)/General Scans: Interpolated grid:

dx=1.000 mm, dy=1.000 mm

ABM1/ABM2 = 45.69 dB

ABM1 comp = 0.87 dBA/m

Location: -1, 0.5, 3.7 mm

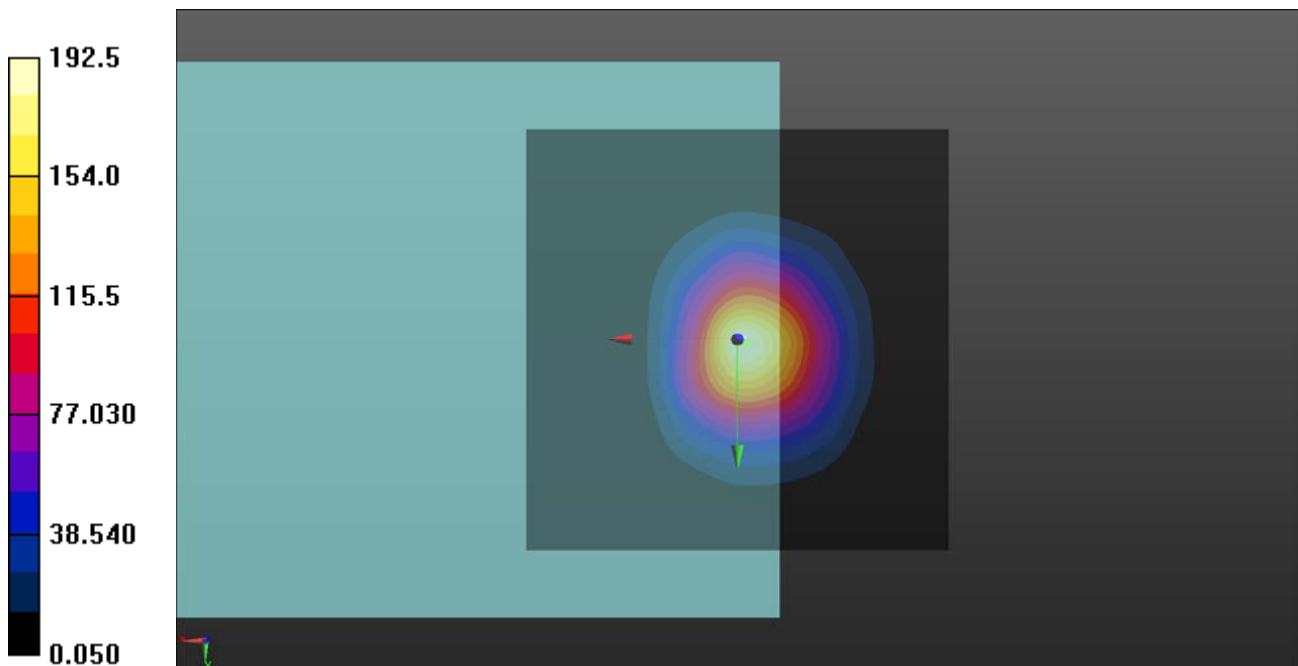

P03 CDMA2000 BC10_RC1+SO3_Ch476_Radial (Y)

DUT: 151222C07

Communication System: CDMA2000; Frequency: 817.9 MHz; Duty Cycle: 1:1

Medium: Air Medium parameters used: $\sigma = 0$ S/m, $\epsilon_r = 1$; $\rho = 1$ kg/m³

Ambient Temperature : 23.5 °C

DASY5 Configuration:

- Probe: AM1DV3 - 3067; ; Calibrated: 2015/12/10
- Sensor-Surface: 0mm (Fix Surface)
- Electronics: DAE3 Sn579; Calibrated: 2015/08/24
- Phantom: HAC Test Arch with AMCC; Type: SD HAC P01 BA;
- Measurement SW: DASY52, Version 52.8 (8); SEMCAD X Version 14.6.10 (7331)

T-Coil scan (scan for ANSI C63.19 compliance)/General Scans: Interpolated grid:

dx=1.000 mm, dy=1.000 mm

ABM1/ABM2 = 44.96 dB

ABM1 comp = -8.84 dBA/m

Location: -1, 12.5, 3.7 mm

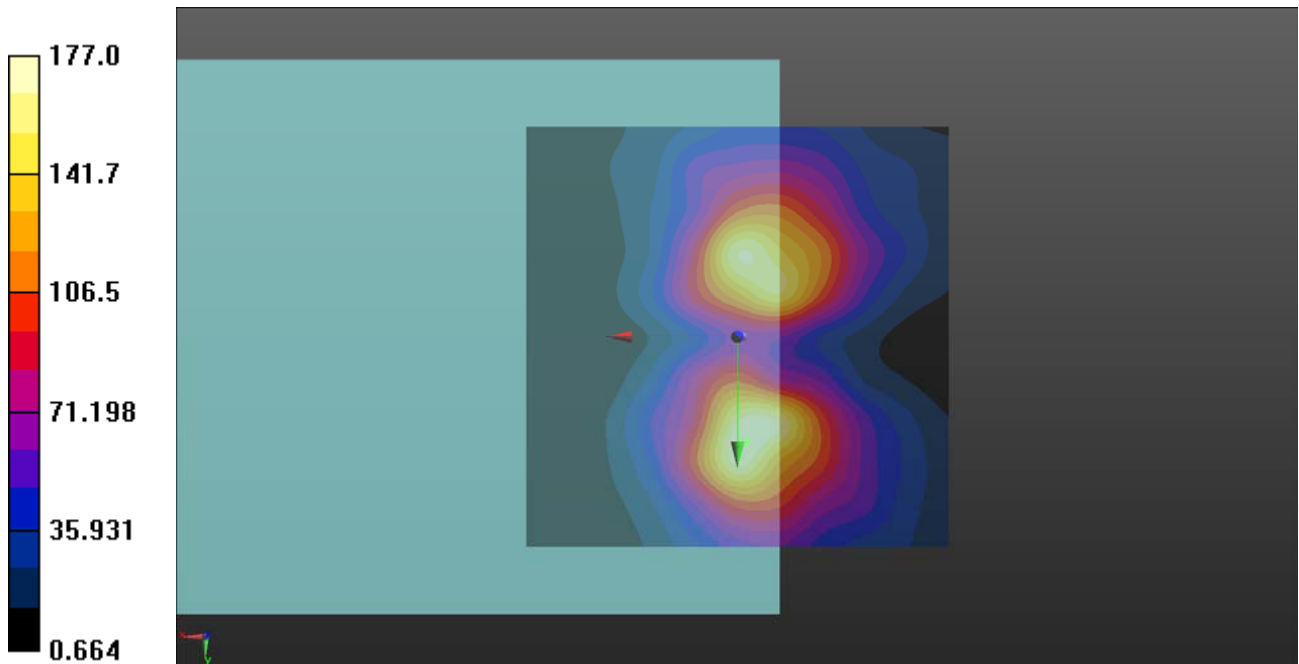

P03 CDMA2000 BC10_RC1+SO3_Ch476_Freq Resp

DUT: 151222C07

Communication System: CDMA2000; Frequency: 817.9 MHz; Duty Cycle: 1:1

Medium: Air Medium parameters used: $\sigma = 0 \text{ S/m}$, $\epsilon_r = 1$; $\rho = 1 \text{ kg/m}^3$

Ambient Temperature : 23.5 °C

DASY5 Configuration:

- Probe: AM1DV3 - 3067; ; Calibrated: 2015/12/10
- Sensor-Surface: 0mm (Fix Surface)
- Electronics: DAE3 Sn579; Calibrated: 2015/08/24
- Phantom: HAC Test Arch with AMCC; Type: SD HAC P01 BA;
- Measurement SW: DASY52, Version 52.8 (8); SEMCAD X Version 14.6.10 (7331)

T-Coil scan (scan for ANSI C63.19 compliance)/General Scans: Measurement grid: dx=10mm, dy=10mm

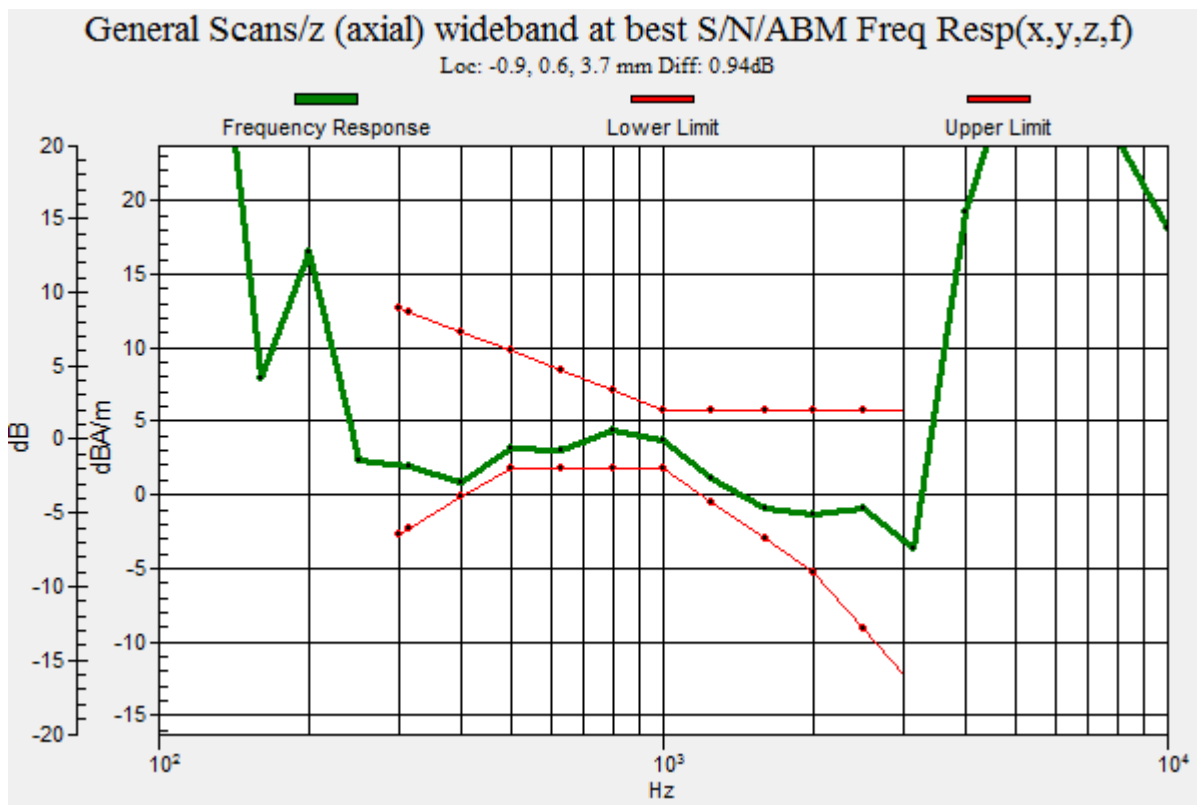



Appendix B. Calibration Certificate for Probe

The SPEAG calibration certificates are shown as follows.



Accredited by the Swiss Accreditation Service (SAS)
The Swiss Accreditation Service is one of the signatories to the EA
Multilateral Agreement for the recognition of calibration certificates

Accreditation No.: **SCS 0108**

Client **Auden**

Certificate No: **AM1DV3-3067_Dec15**

CALIBRATION CERTIFICATE

Object **AM1DV3 - SN: 3067**

Calibration procedure(s) **QA CAL-24.v4
Calibration procedure for AM1D magnetic field probes and TMFS in the
audio range**

Calibration date: **December 10, 2015**

This calibration certificate documents the traceability to national standards, which realize the physical units of measurements (SI).
The measurements and the uncertainties with confidence probability are given on the following pages and are part of the certificate.

All calibrations have been conducted in the closed laboratory facility: environment temperature (22 ± 3)°C and humidity < 70%.

Calibration Equipment used (M&TE critical for calibration)

Primary Standards	ID #	Cal Date (Certificate No.)	Scheduled Calibration
Keithley Multimeter Type 2001	SN: 0810278	09-Sep-15 (No. 17153)	Sep-16
Reference Probe AM1DV3	SN: 3000	07-Aug-15 (No. AM1D-3000_Aug15)	Aug-16
DAE4	SN: 781	04-Sep-15 (No. DAE4-781_Sep15)	Sep-16

Secondary Standards	ID #	Check Date (in house)	Scheduled Check
AMCC	1050	01-Oct-13 (in house check Sep-15)	Sep-18
AMMI Audio Measuring Instrument	1062	26-Sep-12 (in house check Sep-15)	Sep-18

Calibrated by: **Claudio Leubler** Name: Claudio Leubler Function: Laboratory Technician

Signature

Approved by: **Katja Pokovic** Name: Katja Pokovic Technical Manager

Issued: December 11, 2015

This calibration certificate shall not be reproduced except in full without written approval of the laboratory.

[References

- [1] ANSI-C63.19-2007
American National Standard for Methods of Measurement of Compatibility between Wireless Communications Devices and Hearing Aids.
- [2] ANSI-C63.19-2011
American National Standard, Methods of Measurement of Compatibility between Wireless Communications Devices and Hearing Aids.
- [3] DASY5 manual, Chapter: Hearing Aid Compatibility (HAC) T-Coil Extension

Description of the AM1D probe

The AM1D Audio Magnetic Field Probe is a fully shielded magnetic field probe for the frequency range from 100 Hz to 20 kHz. The pickup coil is compliant with the dimensional requirements of [1+2]. The probe includes a symmetric low noise amplifier for the signal available at the shielded 3 pin connector at the side. Power is supplied via the same connector (phantom power supply) and monitored via the LED near the connector. The 7 pin connector at the end of the probe does not carry any signals, but determines the angle of the sensor when mounted on the DAE. The probe supports mechanical detection of the surface.

The single sensor in the probe is arranged in a tilt angle allowing measurement of 3 orthogonal field components when rotating the probe by 120° around its axis. It is aligned with the perpendicular component of the field, if the probe axis is tilted nominally 35.3° above the measurement plane, using the connector rotation and sensor angle stated below.

The probe is fully RF shielded when operated with the matching signal cable (shielded) and allows measurement of audio magnetic fields in the close vicinity of RF emitting wireless devices according to [1+2] without additional shielding.

Handling of the item

The probe is manufactured from stainless steel. In order to maintain the performance and calibration of the probe, it must not be opened. The probe is designed for operation in air and shall not be exposed to humidity or liquids. For proper operation of the surface detection and emergency stop functions in a DASY system, the probe must be operated with the special probe cup provided (larger diameter).

Methods Applied and Interpretation of Parameters

- *Coordinate System:* The AM1D probe is mounted in the DASY system for operation with a HAC Test Arch phantom with AMCC Helmholtz calibration coil according to [3], with the tip pointing to “southwest” orientation.
- *Functional Test:* The functional test preceding calibration includes test of Noise level
RF immunity (1kHz AM modulated signal). The shield of the probe cable must be well connected.
Frequency response verification from 100 Hz to 10 kHz.
- *Connector Rotation:* The connector at the end of the probe does not carry any signals and is used for fixation to the DAE only. The probe is operated in the center of the AMCC Helmholtz coil using a 1 kHz magnetic field signal. Its angle is determined from the two minima at nominally +120° and –120° rotation, so the sensor in the tip of the probe is aligned to the vertical plane in z-direction, corresponding to the field maximum in the AMCC Helmholtz calibration coil.
- *Sensor Angle:* The sensor tilting in the vertical plane from the ideal vertical direction is determined from the two minima at nominally +120° and –120°. DASY system uses this angle to align the sensor for radial measurements to the x and y axis in the horizontal plane.

Sensitivity: With the probe sensor aligned to the z-field in the AMCC, the output of the probe is compared to the magnetic field in the AMCC at 1 kHz. The field in the AMCC Helmholtz coil is given by the geometry and the current through the coil, which is monitored on the precision shunt resistor of the coil.

AM1D probe identification and configuration data

Item	AM1DV3 Audio Magnetic 1D Field Probe
Type No	SP AM1 001 BA
Serial No	3067

Overall length	296 mm
Tip diameter	6.0 mm (at the tip)
Sensor offset	3.0 mm (centre of sensor from tip)
Internal Amplifier	20 dB

Manufacturer / Origin	Schmid & Partner Engineering AG, Zürich, Switzerland
Manufacturing date	February 17, 2009
Last calibration date	December 9, 2014

Calibration data

Connector rotation angle	(in DASY system)	264.2 °	+/- 3.6 ° (k=2)
Sensor angle	(in DASY system)	0.87 °	+/- 0.5 ° (k=2)
Sensitivity at 1 kHz	(in DASY system)	0.00738 V / (A/m)	+/- 2.2 % (k=2)

The reported uncertainty of measurement is stated as the standard uncertainty of measurement multiplied by the coverage factor $k=2$, which for a normal distribution corresponds to a coverage probability of approximately 95%.