



# FCC TEST REPORT (PART 27)

**REPORT NO.:** RF131114C03-2  
**MODEL NO.:** C6730  
**FCC ID:** V65C6730  
**RECEIVED:** Nov. 14, 2013  
**TESTED:** Nov. 29, 2013 ~ Feb. 14, 2014  
**ISSUED:** Feb. 25, 2014

**APPLICANT:** Kyocera Communications, Inc. c/o Kyocera Corporation

**ADDRESS:** 8611 Balboa Ave. San Diego, CA 92123

**ISSUED BY:** Bureau Veritas Consumer Products Services  
(H.K.) Ltd., Taoyuan Branch

**LAB ADDRESS:** No. 47, 14th Ling, Chia Pau Vil., Lin Kou Dist.,  
New Taipei City, Taiwan, R.O.C.

**TEST LOCATION:** No. 19, Hwa Ya 2nd Rd, Wen Hwa Tsuen, Kwei  
Shan Hsiang, Taoyuan Hsien 333, Taiwan, R.O.C.

This report should not be used by the client to claim product certification, approval, or endorsement by TAF or any government agencies.



This report is for your exclusive use. Any copying or replication of this report to or for any other person or entity, or use of our name or trademark, is permitted only with our prior written permission. This report sets forth our findings solely with respect to the test samples identified herein. The results set forth in this report are not indicative or representative of the quality or characteristics of the lot from which a test sample was taken or any similar or identical product unless specifically and expressly noted. Our report includes all of the tests requested by you and the results thereof based upon the information that you provided to us. You have 60 days from date of issuance of this report to notify us of any material error or omission caused by our negligence, provided, however, that such notice shall be in writing and shall specifically address the issue you wish to raise. A failure to raise such issue within the prescribed time shall constitute your unqualified acceptance of the completeness of this report, the tests conducted and the correctness of the report contents. Unless specific mention, the uncertainty of measurement has been explicitly taken into account to declare the compliance or non-compliance to the specification

## TABLE OF CONTENTS

RELEASE CONTROL RECORD.....	3
1 CERTIFICATION .....	4
2 SUMMARY OF TEST RESULTS.....	5
2.1 MEASUREMENT UNCERTAINTY .....	5
2.2 TEST SITE AND INSTRUMENTS .....	6
3 GENERAL INFORMATION .....	7
3.1 GENERAL DESCRIPTION OF EUT.....	7
3.2 CONFIGURATION OF SYSTEM UNDER TEST .....	8
3.3 DESCRIPTION OF SUPPORT UNITS.....	8
3.4 DESCRIPTION OF TEST MODES.....	9
3.5 GENERAL DESCRIPTION OF APPLIED STANDARDS .....	10
4 TEST TYPES AND RESULTS.....	11
4.1 OUTPUT POWER MEASUREMENT .....	11
4.1.1 LIMITS OF OUTPUT POWER MEASUREMENT .....	11
4.1.2 TEST PROCEDURES.....	11
4.1.3 TEST SETUP .....	12
4.1.4 TEST RESULTS .....	13
4.2 FREQUENCY STABILITY MEASUREMENT .....	17
4.2.1 LIMITS OF FREQUENCY STABILITY MEASUREMENT .....	17
4.2.2 TEST PROCEDURE .....	17
4.2.3 TEST SETUP .....	17
4.2.4 TEST RESULTS .....	18
4.3 OCCUPIED BANDWIDTH MEASUREMENT.....	19
4.3.1 LIMITS OF OCCUPIED BANDWIDTH MEASUREMENT.....	19
4.3.2 TEST SETUP .....	19
4.3.3 TEST PROCEDURES.....	19
4.3.4 TEST RESULTS .....	20
4.4 PEAK TO AVERAGE RATIO.....	22
4.4.1 LIMITS OF PEAK TO AVERAGE RATIO MEASUREMENT .....	22
4.4.2 TEST SETUP .....	22
4.4.3 TEST PROCEDURES.....	22
4.4.4 TEST RESULTS .....	23
4.5 BAND EDGE MEASUREMENT .....	25
4.5.1 LIMITS OF BAND EDGE MEASUREMENT .....	25
4.5.2 TEST SETUP .....	25
4.5.3 TEST PROCEDURES.....	26
4.5.4 TEST RESULTS .....	27
4.6 CONDUCTED SPURIOUS EMISSIONS.....	33
4.6.1 LIMITS OF CONDUCTED SPURIOUS EMISSIONS MEASUREMENT.....	33
4.6.2 TEST PROCEDURE .....	33
4.6.3 TEST SETUP .....	33
4.6.4 TEST RESULTS .....	34
4.7 RADIATED EMISSION MEASUREMENT .....	35
4.7.1 LIMITS OF RADIATED EMISSION MEASUREMENT .....	35
4.7.2 TEST PROCEDURES.....	35
4.7.3 DEVIATION FROM TEST STANDARD.....	35
4.7.4 TEST SETUP .....	36
4.7.5 TEST RESULTS .....	37
5 INFORMATION ON THE TESTING LABORATORIES .....	49
6 APPENDIX A – MODIFICATIONS RECORDERS FOR ENGINEERING CHANGES TO THE EUT BY THE LAB.....	50



A D T

## RELEASE CONTROL RECORD

ISSUE NO.	REASON FOR CHANGE	DATE ISSUED
RF131114C03-2	Original release	Feb. 25, 2014



# 1 CERTIFICATION

**PRODUCT:** Kyocera phone  
**MODEL NO.:** C6730  
**BRAND:** Kyocera  
**APPLICANT:** Kyocera Communications, Inc. c/o Kyocera Corporation  
**TESTED:** Nov. 29, 2013 ~ Feb. 14, 2014  
**TEST SAMPLE:** Identical Prototype  
**TEST STANDARDS:** **FCC Part 27, Subpart C, M**  
**FCC Part 2**  
**ANSI C63.4-2003**

The above equipment (model: C6730) has been tested by **Bureau Veritas Consumer Products Services (H.K.) Ltd., Taoyuan Branch**, and found compliance with the requirement of the above standards. The test record, data evaluation & Equipment Under Test (EUT) configurations represented herein are true and accurate accounts of the measurements of the sample's EMC characteristics under the conditions specified in this report.

**PREPARED BY** :  Vera Huang  , **DATE** :  Feb. 25, 2014   
Vera Huang / Specialist

**APPROVED BY** :  Sam chen  , **DATE** :  Feb. 25, 2014   
Sam Chen / Senior Project Engineer

## 2 SUMMARY OF TEST RESULTS

The EUT has been tested according to the following specifications:

STANDARD SECTION	TEST TYPE AND LIMIT	RESULT	REMARK
2.1046 27.50(h)	Equivalent isotropically radiated power	PASS	Meet the requirement of limit.
2.1055 27.54	Frequency Stability	PASS	Meet the requirement of limit.
2.1049	Occupied Bandwidth	PASS	Meet the requirement of limit.
	Peak to average ratio	PASS	Meet the requirement of limit.
2.1051 27.53(l)	Band Edge Measurements	PASS	Meet the requirement of limit.
2.1051 27.53(l)	Conducted Spurious Emissions	PASS	Meet the requirement of limit.
2.1053 27.53(l)	Radiated Spurious Emissions	PASS	Meet the requirement of limit. Minimum passing margin is -13.09dB at 5172.80MHz.

### 2.1 MEASUREMENT UNCERTAINTY

Where relevant, the following measurement uncertainty levels have been estimated for tests performed on the EUT as specified in CISPR 16-4-2:

MEASUREMENT	FREQUENCY	UNCERTAINTY
Conducted emissions	150kHz~30MHz	2.44 dB
Radiated emissions	30MHz ~ 200MHz	2.93 dB
	200MHz ~1000MHz	2.95 dB
	1GHz ~ 18GHz	2.26 dB
	18GHz ~ 40GHz	1.94 dB

This uncertainty represents an expanded uncertainty expressed at approximately the 95% confidence level using a coverage factor of k=2.

## 2.2 TEST SITE AND INSTRUMENTS

DESCRIPTION & MANUFACTURER	MODEL NO.	SERIAL NO.	DATE OF CALIBRATION	DUE DATE OF CALIBRATION
Test Receiver ROHDE & SCHWARZ	ESCI	100744	Apr. 15, 2013	Apr. 14, 2014
Spectrum Analyzer Agilent	E4446A	MY51100039	Jul. 31, 2013	Jul. 30, 2014
BILOG Antenna SCHWARZBECK	VULB9168	9168-472	Mar. 25, 2013	Mar. 24, 2014
HORN Antenna SCHWARZBECK	BBHA 9120 D	9120D- 209	Sep. 12, 2013	Sep. 11, 2014
HORN Antenna SCHWARZBECK	BBHA 9170	9170-480	Dec. 25, 2012	Dec. 24, 2013
HORN Antenna SCHWARZBECK	BBHA 9170	9170-480	Dec. 18, 2013	Dec. 17, 2014
Loop Antenna	3127-836	00099258	Aug. 09, 2013	Aug. 08, 2014
Preamplifier EMCI	EMC 330H	980112	Dec. 28, 2012	Dec. 27, 2013
Preamplifier EMCI	EMC 330H	980112	Dec. 27, 2013	Dec. 26, 2014
RF signal cable HUBER+SUHNNER	SUCOFLEX 104	309219/4 2950114	Oct. 18, 2013	Oct. 17, 2014
RF signal cable HUBER+SUHNNER	SUCOFLEX 104	250130/4	Oct. 18, 2013	Oct. 17, 2014
RF signal cable Worken	RG-213	NA	Nov. 07, 2013	Nov. 06, 2014
Software BV ADT	E3 6.120103	NA	NA	NA
Antenna Tower MF	MFA-440H	NA	NA	NA
Turn Table MF	MFT-201SS	NA	NA	NA
Antenna Tower & Turn Table Controller MF	MF-7802	NA	NA	NA
Mini-Circuits Power Splitter	ZN2PD-9G	NA	Jul. 18, 2013	Jul. 17, 2014
JFW 20dB attenuation	50HF-020-SMA	NA	NA	NA
Communications Tester-Wireless	E5515C	MY52102544	Sep. 05, 2012	Sep. 04, 2014
Radio Communication Analyzer	MT8820C	6201300640	Aug. 01, 2013	Jul. 31, 2014

- NOTE:**
1. The calibration interval of the above test instruments is 12 months and the calibrations are traceable to NML/ROC and NIST/USA.
  2. The test was performed in HwaYa Chamber 10.
  3. The horn antenna and HP preamplifier (model: 8449B) are used only for the measurement of emission frequency above 1GHz if tested.
  4. The FCC Site Registration No. is 690701.
  5. The IC Site Registration No. is IC 7450F-10.

### 3 GENERAL INFORMATION

#### 3.1 GENERAL DESCRIPTION OF EUT

<b>PRODUCT</b>	Kyocera phone	
<b>MODEL NO.</b>	C6730	
<b>POWER SUPPLY</b>	5.0Vdc (adapter or host equipment) 3.8Vdc (battery)	
<b>MODULATION TECHNOLOGY</b>	LTE Band 41	QPSK, 16QAM
<b>FREQUENCY RANGE</b>	LTE Band 41 Channel Bandwidth: 10MHz	2501.0MHz ~ 2685.0MHz
	LTE Band 41 Channel Bandwidth: 15MHz	2503.5MHz ~ 2682.5MHz
	LTE Band 41 Channel Bandwidth: 20MHz	2506.0MHz ~ 2680.0MHz
<b>EMISSION DESIGNATOR</b>	LTE Band 41 Channel Bandwidth: 10MHz	8M92W7D
	LTE Band 41 Channel Bandwidth: 15MHz	13M4G7D
	LTE Band 41 Channel Bandwidth: 20MHz	17M8G7D
<b>MAX. EIRP POWER</b>	LTE Band 41 Channel Bandwidth: 10MHz	178.24mW
	LTE Band 41 Channel Bandwidth: 15MHz	174.98mW
	LTE Band 41 Channel Bandwidth: 20MHz	187.50mW
<b>ANTENNA TYPE</b>	Fixed Internal Antenna with -1.5dBi gain	
<b>DATA CABLE</b>	Refer to Note as below	
<b>I/O PORTS</b>	Refer to users' manual	
<b>ACCESSORY DEVICES</b>	Refer to Note as below	

**NOTE:**

1. The EUT has following accessories.

ITEM	BRAND	MODEL	DESCRIPTION
AC Adapter	Kyocera	SCP-42ADT	I/P: 100-240Vac, 50/60Hz, 200mA O/P: 5Vdc, 1000mA
Li-ion Battery	Kyocera	SCP-59LBPS	Rating: 3.8Vdc, 2000mAh
USB cable	Kyocera	SCP-11SDC	1.2m non-shielded cable w/o ferrite core

2. The above EUT information is declared by the manufacturer and for more detailed features description, please refer to the manufacturer's specifications or User's Manual.

### 3.2 CONFIGURATION OF SYSTEM UNDER TEST

#### FOR RADIATION EMISSION TEST

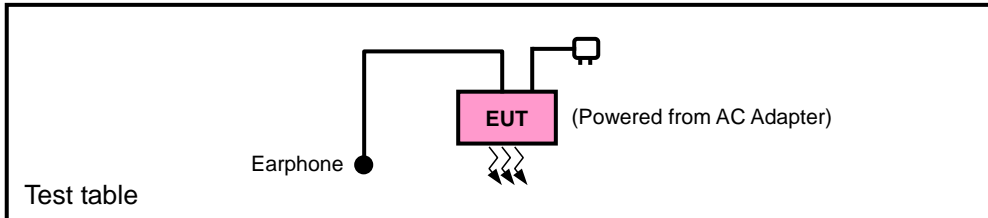

#### FOR E.I.R.P. TEST

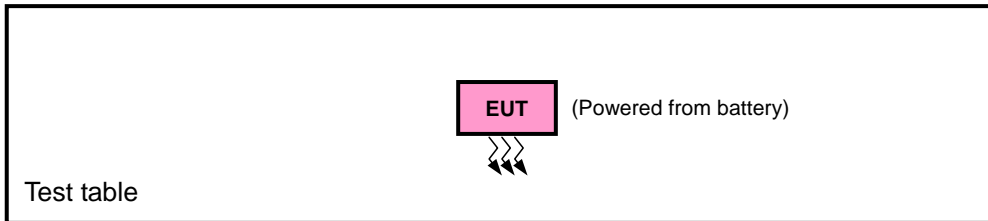

### 3.3 DESCRIPTION OF SUPPORT UNITS

The EUT has been tested as an independent unit together with other necessary accessories or support units. The following support units or accessories were used to form a representative test configuration during the tests.

NO.	PRODUCT	BRAND	MODEL NO.	SERIAL NO.	FCC ID
1	EARPHONE	GALIEN	HF-HB04D	N/A	N/A

NO.	SIGNAL CABLE DESCRIPTION OF THE ABOVE SUPPORT UNITS
1	N/A

**NOTE:**

1. All power cords of the above support units are non-shielded (1.8m).
2. Item 1 was provided by client.



### 3.4 DESCRIPTION OF TEST MODES

Pre-Scan has been conducted to determine the worst-case mode from all possible combinations between available modulations, data rates, XYZ axis and antenna ports. The worst case was found when positioned on Y-plane for EIRP and X-axis for radiated emission. Following channel(s) was (were) selected for the final test as listed below:

#### LTE Band 41

EUT CONFIGURE MODE	TEST ITEM	AVAILABLE CHANNEL	TESTED CHANNEL	CHANNEL BANDWIDTH	MODULATION	MODE
-	EIRP	39700 to 41540	39700, 40620, 41540	10MHz	QPSK, 16QAM	1 RB / 0 RB Offset
		39725 to 41515	39725, 40620, 41515	15MHz	QPSK, 16QAM	1 RB / 0 RB Offset
		39750 to 41490	39750, 40620, 41515	20MHz	QPSK, 16QAM	1 RB / 0 RB Offset
-	FREQUENCY STABILITY	39700 to 41540	40620	10MHz	QPSK	1 RB / 0 RB Offset
		39725 to 41515	40620	15MHz	QPSK	1 RB / 0 RB Offset
		39750 to 41490	40620	20MHz	QPSK	1 RB / 0 RB Offset
-	OCCUPIED BANDWIDTH	39700 to 41540	39700, 40620, 41540	10MHz	QPSK, 16QAM	50 RB / 0 RB Offset
		39725 to 41515	39725, 40620, 41515	15MHz	QPSK, 16QAM	75 RB / 0 RB Offset
		39750 to 41490	39750, 40620, 41515	20MHz	QPSK, 16QAM	100 RB / 0 RB Offset
-	PEAK TO AVERAGE RATIO	39700 to 41540	39700, 40620, 41540	10MHz	QPSK, 16QAM	1 RB / 0 RB Offset
		39725 to 41515	39725, 40620, 41515	15MHz	QPSK, 16QAM	1 RB / 0 RB Offset
		39750 to 41490	39750, 40620, 41515	20MHz	QPSK, 16QAM	1 RB / 0 RB Offset
-	BAND EDGE	39700 to 41540	39700, 41540	10MHz	QPSK, 16QAM	50 RB / 0 RB Offset
		39725 to 41515	39725, 41515	15MHz	QPSK, 16QAM	75 RB / 0 RB Offset
		39750 to 41490	39750, 41490	20MHz	QPSK, 16QAM	100 RB / 0 RB Offset
-	CONDCUDED EMISSION	39700 to 41540	40620	10MHz	QPSK	1 RB / 0 RB Offset
		39725 to 41515	40620	15MHz	QPSK	1 RB / 0 RB Offset
		39750 to 41490	40620	20MHz	QPSK	1 RB / 0 RB Offset
-	RADIATED EMISSION	39700 to 41540	40620	10MHz	QPSK	1 RB / 0 RB Offset
						50 RB / 0 RB Offset
		39725 to 41515	40620	15MHz	QPSK	1 RB / 0 RB Offset
						75 RB / 0 RB Offset
		39750 to 41490	40620	20MHz	QPSK	1 RB / 0 RB Offset
						100 RB / 0 RB Offset

**Note:** This device was tested under all bandwidths, RB configurations and modulations. The worst case was found in QPSK modulation.

**TEST CONDITION:**

TEST ITEM	ENVIRONMENTAL CONDITIONS	INPUT POWER	TESTED BY
ERP/EIRP	26deg. C, 58%RH	3.8Vdc	Howard Kao
FREQUENCY STABILITY	26deg. C, 58%RH	3.8Vdc	Howard Kao
OCCUPIED BANDWIDTH	26deg. C, 58%RH	3.8Vdc	Howard Kao
BAND EDGE	26deg. C, 58%RH	3.8Vdc	Howard Kao
CONDCUDED EMISSION	26deg. C, 58%RH	3.8Vdc	Howard Kao
RADIATED EMISSION	25deg. C, 65%RH	120Vac, 60Hz	Anson Lin

**3.5 GENERAL DESCRIPTION OF APPLIED STANDARDS**

The EUT is a RF product. According to the specifications of the manufacturer, it must comply with the requirements of the following standards:

**FCC 47 CFR Part 2**

**FCC 47 CFR Part 27**

**ANSI C63.4-2003**

**ANSI/TIA/EIA-603-C 2004**

**NOTE:** All test items have been performed and recorded as per the above standards.

## 4 TEST TYPES AND RESULTS

### 4.1 OUTPUT POWER MEASUREMENT

#### 4.1.1 LIMITS OF OUTPUT POWER MEASUREMENT

The radiated peak output power shall be according to the specific rule Part 27.50(h)(2) that “User stations are limited to 2 watts” and 27.50(i) specific that “Peak transmit power must be measure over any interval of continuous transmission using instrumentation calibration in terms of rms-equivalent voltage.”

#### 4.1.2 TEST PROCEDURES

- a. All measurements were done at low, middle and high operational frequency range. RBW and VBW is 10MHz for LTE mode.
- b. Substitution method is used for E.I.R.P measurement. In the semi-anechoic chamber, EUT placed on the 0.8m height of Turn Table, rotated the table around 360 degrees to search the maximum radiation power and receiver antenna shall be rotated vertical and horizontal polarization and moved height from 1m to 4m to find the maximum polar radiated power. The “Read Value” is the spectrum reading the maximum power value.
- c. The substitution horn antenna is substituted for EUT at the same position and signals generator export the CW signal to the substitution antenna via a tx cable. Rotated the Turn Table and moved receiving antenna to find the maximum radiation power. Adjust output power level of S.G to get a Value of spectrum reading equal to “Read Value” of step b. Record the power level of S.G
- d.  $EIRP = \text{Output power level of S.G} - \text{TX cable loss} + \text{Antenna gain of substitution horn}.$

#### CONDUCTED POWER MEASUREMENT:

- a. The EUT was set up for the maximum power with LTE link data modulation and link up with simulator.
- b. Set the EUT to transmit under low, middle and high channel and record the power level shown on simulator.

### 4.1.3 TEST SETUP

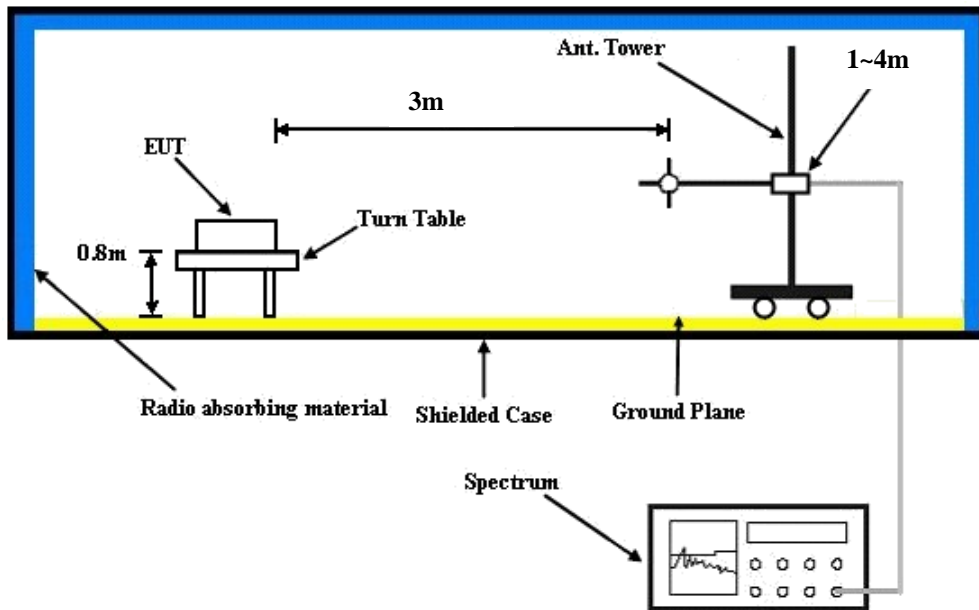

### CONDUCTED POWER MEASUREMENT:

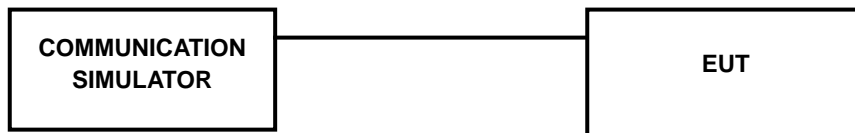



#### 4.1.4 TEST RESULTS

##### AVERAGE CONDUCTED OUTPUT POWER (dBm)

Band / BW	Modulation	RB Size	RB Offset	Low CH 39700	Mid CH 40160	Mid CH 40620	Mid CH 41080	High CH 41540	3PGG MPR (dB)
				Frequency 2501.0 MHz	Frequency 2547.0 MHz	Frequency 2593.0 MHz	Frequency 2639.0 MHz	Frequency 2685.0 MHz	
41 / 10M	QPSK	1	0	23.27	23.09	23.19	23.39	23.54	0
		1	24	23.44	23.23	23.39	23.47	23.53	0
		1	49	23.11	22.88	22.97	23.13	23.17	0
		25	0	22.43	22.06	22.09	22.37	22.45	1
		25	12	22.29	21.93	22.23	22.31	22.34	1
		25	25	22.16	21.84	22.13	22.15	22.14	1
	50	0	22.19	21.88	22.15	22.31	22.37	1	
	16QAM	1	0	22.17	21.99	22.09	22.29	22.44	1
		1	24	22.34	22.13	22.29	22.37	22.43	1
		1	49	22.01	21.87	21.87	22.03	22.07	1
		25	0	21.33	20.96	20.99	21.27	21.35	2
		25	12	21.19	20.83	21.13	21.21	21.24	2
25		25	21.06	20.85	21.03	21.05	21.04	2	
50	0	21.09	20.88	21.05	21.21	21.27	2		

Band / BW	Modulation	RB Size	RB Offset	Low CH 39725	Mid CH 40173	Mid CH 40620	Mid CH 41068	High CH 41515	3PGG MPR (dB)
				Frequency 2503.5 MHz	Frequency 2548.3 MHz	Frequency 2593.0 MHz	Frequency 2637.8 MHz	Frequency 2682.5 MHz	
41 / 15M	QPSK	1	0	23.40	23.22	23.32	23.52	23.67	0
		1	37	23.57	23.36	23.52	23.60	23.66	0
		1	74	23.24	22.90	23.10	23.26	23.30	0
		36	0	22.56	22.19	22.22	22.50	22.58	1
		36	19	22.42	22.06	22.36	22.44	22.47	1
		36	39	22.29	21.97	22.26	22.28	22.27	1
		75	0	22.32	21.90	22.28	22.44	22.50	1
	16QAM	1	0	22.30	22.12	22.22	22.42	22.57	1
		1	37	22.47	22.26	22.42	22.50	22.56	1
		1	74	22.14	21.89	22.00	22.16	22.20	1
		36	0	21.46	21.09	21.12	21.40	21.48	2
		36	19	21.32	20.96	21.26	21.34	21.37	2
		36	39	21.19	20.87	21.16	21.18	21.17	2
		75	0	21.22	20.90	21.18	21.34	21.40	2



A D T

Band / BW	Modulation	RB Size	RB Offset	Low CH 39750	Mid CH 40185	Mid CH 40620	Mid CH 41055	High CH 41490	3PGG MPR (dB)
				Frequency 2506.0 MHz	Frequency 2549.5 MHz	Frequency 2593.0 MHz	Frequency 2636.5 MHz	Frequency 2680.0 MHz	
41 / 20M	QPSK	1	0	23.51	23.33	23.43	23.63	<b>23.78</b>	0
		1	50	23.68	23.47	23.63	23.71	23.77	0
		1	99	23.35	23.01	23.21	23.37	23.41	0
		50	0	22.67	22.30	22.33	22.61	22.69	1
		50	25	22.53	22.17	22.47	22.55	22.58	1
		50	50	22.40	22.08	22.37	22.39	22.38	1
	16QAM	100	0	22.43	22.01	22.39	22.55	22.61	1
		1	0	22.41	22.23	22.33	22.53	22.68	1
		1	50	22.58	22.37	22.53	22.61	22.67	1
		1	99	22.25	21.91	22.11	22.27	22.31	1
		50	0	21.57	21.20	21.23	21.51	21.59	2
		50	25	21.43	21.07	21.37	21.45	21.48	2
	50	50	21.30	20.98	21.27	21.29	21.28	2	
	100	0	21.33	20.91	21.29	21.45	21.51	2	

**AVERAGE EIRP (dBm)**

**LTE BAND 41**

**CHANNEL BANDWIDTH: 10MHZ QPSK**

Plane	Channel	Frequency (MHz)	LVL (dBm)	Correction Factor(dB)	EIRP(dBm)	EIRP(mW)	Polarization (H/V)
Y	39700	2501.0	-16.47	38.98	22.51	178.24	H
	40620	2593.0	-16.61	38.17	21.56	143.22	H
	41540	2685.0	-16.33	38.45	22.12	162.93	H
	39700	2501.0	-24.05	39.04	14.99	31.55	V
	40620	2593.0	-23.94	38.68	14.74	29.79	V
	41540	2685.0	-24.48	38.60	14.12	25.82	V

**CHANNEL BANDWIDTH: 10MHZ 16QAM**

Plane	Channel	Frequency (MHz)	LVL (dBm)	Correction Factor(dB)	EIRP(dBm)	EIRP(mW)	Polarization (H/V)
Y	39700	2501.0	-17.53	38.98	21.45	139.64	H
	40620	2593.0	-17.76	38.17	20.41	109.90	H
	41540	2685.0	-17.30	38.45	21.15	130.32	H
	39700	2501.0	-25.96	39.04	13.08	20.32	V
	40620	2593.0	-25.82	38.68	12.86	19.32	V
	41540	2685.0	-26.24	38.60	12.36	17.22	V



A D T

**CHANNEL BANDWIDTH: 15MHZ QPSK**

Plane	Channel	Frequency (MHz)	LVL (dBm)	Correction Factor(dB)	EIRP(dBm)	EIRP(mW)	Polarization (H/V)
Y	39725	2503.5	-16.66	39.09	22.43	174.98	H
	40620	2593.0	-16.49	38.17	21.68	147.23	H
	41515	2682.5	-16.79	38.52	21.73	148.94	H
	39725	2503.5	-24.01	39.04	15.03	31.84	V
	40620	2593.0	-24.08	38.68	14.60	28.84	V
	41515	2682.5	-24.97	38.66	13.69	23.39	V

**CHANNEL BANDWIDTH: 15MHZ 16QAM**

Plane	Channel	Frequency (MHz)	LVL (dBm)	Correction Factor(dB)	EIRP(dBm)	EIRP(mW)	Polarization (H/V)
Y	39725	2503.5	-17.33	39.09	21.76	149.97	H
	40620	2593.0	-17.32	38.17	20.85	121.62	H
	41515	2682.5	-17.47	38.52	21.05	127.35	H
	39725	2503.5	-25.83	39.04	13.21	20.94	V
	40620	2593.0	-25.75	38.68	12.93	19.63	V
	41515	2682.5	-25.75	38.66	12.91	19.54	V



A D T

**CHANNEL BANDWIDTH: 20MHZ QPSK**

Plane	Channel	Frequency (MHz)	LVL (dBm)	Correction Factor(dB)	EIRP(dBm)	EIRP(mW)	Polarization (H/V)
Y	39750	2506.0	-16.53	39.26	22.73	187.50	H
	40620	2593.0	-16.49	38.17	21.68	147.23	H
	41490	2680.0	-16.46	38.71	22.25	167.88	H
	39750	2506.0	-23.98	39.33	15.35	34.28	V
	40620	2593.0	-24.07	38.68	14.61	28.91	V
	41490	2680.0	-25.02	38.76	13.74	23.66	V

**CHANNEL BANDWIDTH: 20MHZ 16QAM**

Plane	Channel	Frequency (MHz)	LVL (dBm)	Correction Factor(dB)	EIRP(dBm)	EIRP(mW)	Polarization (H/V)
Y	39750	2506.0	-17.29	39.26	21.97	157.40	H
	40620	2593.0	-17.00	38.17	21.17	130.92	H
	41490	2680.0	-17.08	38.71	21.63	145.55	H
	39750	2506.0	-25.92	39.33	13.41	21.93	V
	40620	2593.0	-25.06	38.68	13.62	23.01	V
	41490	2680.0	-24.85	38.76	13.91	24.60	V



## 4.2 FREQUENCY STABILITY MEASUREMENT

### 4.2.1 LIMITS OF FREQUENCY STABILITY MEASUREMENT

The frequency stability shall be sufficient to ensure that the fundamental emissions stay within the authorized bands of operation.

### 4.2.2 TEST PROCEDURE

- a. Device is placed at the oven room. The oven room could control the temperatures and humidity. Power warm up is at least 15 min and power applied should perform before recording frequency error.
- b. EUT is connected the external power supply to control the DC input power. The test voltage range is from minimum to maximum working voltage. Each step shall be record the frequency error rate.
- c. The temperature range step is 10 degrees in this test items. All temperature levels shall be hold the  $\pm 0.5^{\circ}\text{C}$  during the measurement testing. The each temperature step shall be at least 0.5 hours, consider the EUT could be test under the stability condition.

**NOTE:** The frequency error was recorded frequency error from the communication simulator.

### 4.2.3 TEST SETUP

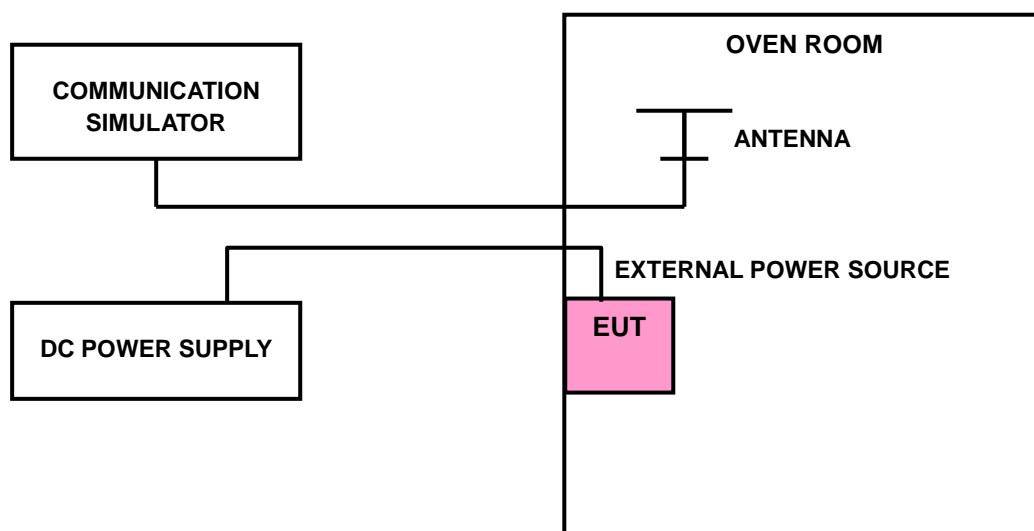

#### 4.2.4 TEST RESULTS

##### FREQUENCY ERROR vs. VOLTAGE

VOLTAGE (Volts)	FREQUENCY ERROR (ppm)			LIMIT (ppm)
	LTE BAND 41			
	10MHz	15MHz	20MHz	
3.7	-0.0019	-0.002	-0.005	2.5
3.3	-0.0041	0.002	0.005	2.5
4.2	0.0023	0.002	-0.003	2.5

**NOTE:** The applicant defined the normal working voltage of the battery is from 3.3Vdc to 4.2Vdc.

##### FREQUENCY ERROR vs. TEMPERATURE

TEMP. (°C)	FREQUENCY ERROR (ppm)			LIMIT (ppm)
	LTE BAND 41			
	10MHz	15MHz	20MHz	
-30	0.0034	0.006	0.009	2.5
-20	-0.0028	-0.003	0.004	2.5
-10	0.0039	0.009	0.005	2.5
0	0.0019	0.009	0.002	2.5
10	0.0008	0.004	-0.001	2.5
20	0.0021	0.002	0.004	2.5
30	0.0023	0.009	0.004	2.5
40	0.0014	0.002	0.004	2.5
50	0.0008	0.010	0.005	2.5

### 4.3 OCCUPIED BANDWIDTH MEASUREMENT

#### 4.3.1 LIMITS OF OCCUPIED BANDWIDTH MEASUREMENT

The width of a frequency band such that, below the lower and above the upper frequency limits, the mean powers emitted are each equal to a specified percentage 0.5 %of the total mean power of a given emission.

#### 4.3.2 TEST SETUP

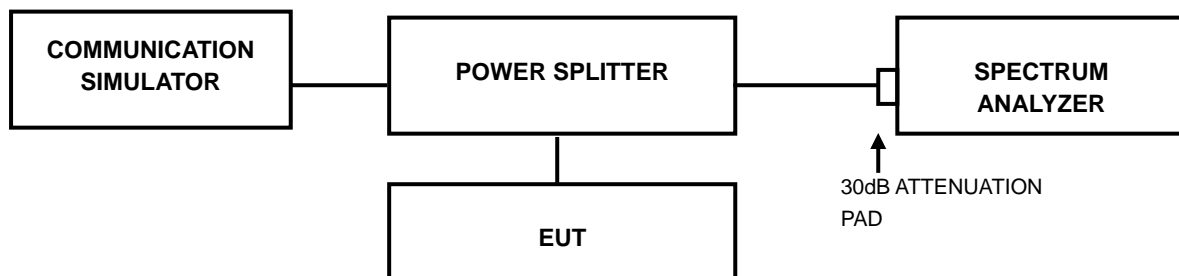

#### 4.3.3 TEST PROCEDURES

- a. The conducted occupied bandwidth used the power splitter via EUT RF power connector between simulation base station and spectrum analyzer.
- b. Use OBW measurement function of Spectrum analyzer to measure 99 % occupied bandwidth.



A D T

### 4.3.4 TEST RESULTS

LTE BAND 41							
CHANNEL BANDWIDTH: 10MHz				CHANNEL BANDWIDTH: 15MHz			
CHANNEL	FREQUENCY (MHz)	99% OCCUPIED BANDWIDTH (MHz)		CHANNEL	FREQUENCY (MHz)	99% OCCUPIED BANDWIDTH (MHz)	
		QPSK	16QAM			QPSK	16QAM
39700	2501.0	8.9131	8.9097	39725	2503.5	13.362	13.349
40620	2593.0	8.9125	8.9152	40620	2593.0	13.368	13.359
41540	2685.0	8.9150	8.9198	41515	2682.5	13.375	13.357

### SPECTRUM PLOT OF WORST VALUE

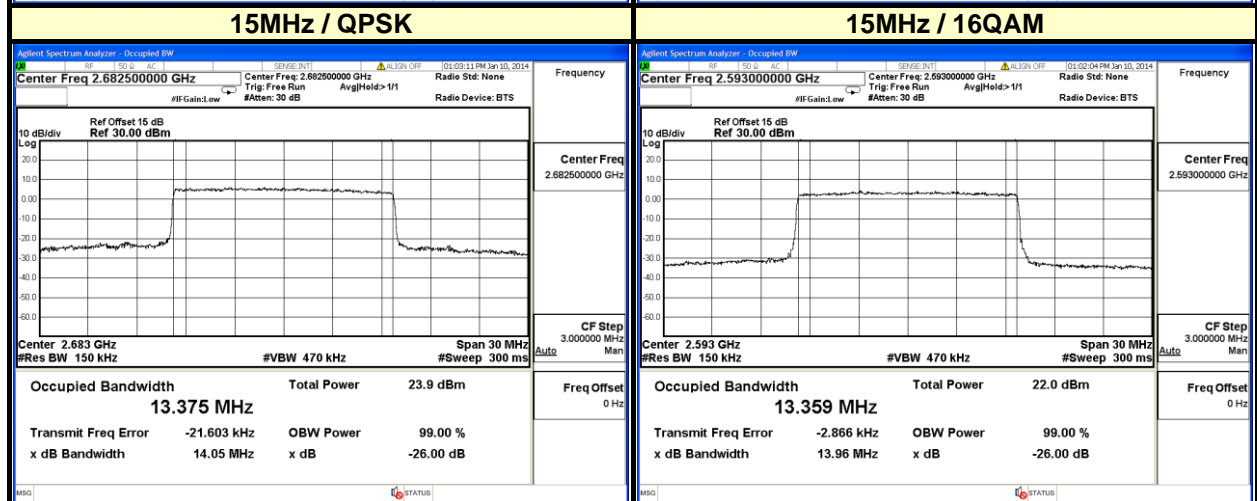
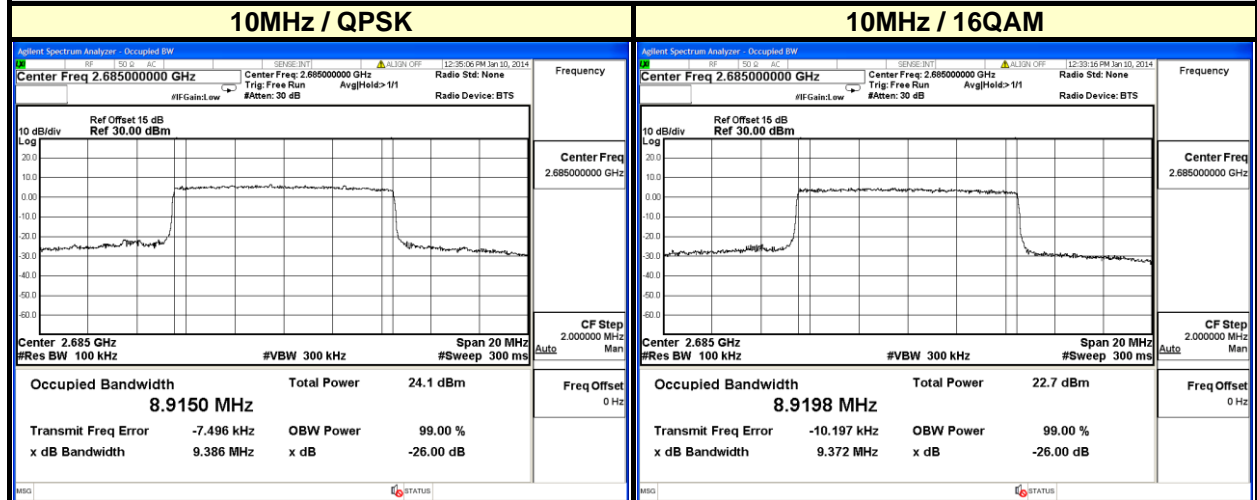



A D T

LTE BAND 41			
CHANNEL BANDWIDTH: 20MHz			
CHANNEL	FREQUENCY (MHz)	99% OCCUPIED BANDWIDTH (MHz)	
		QPSK	16QAM
39750	2506.0	17.777	17.773
40620	2593.0	17.790	17.775
41490	2680.0	17.785	17.775

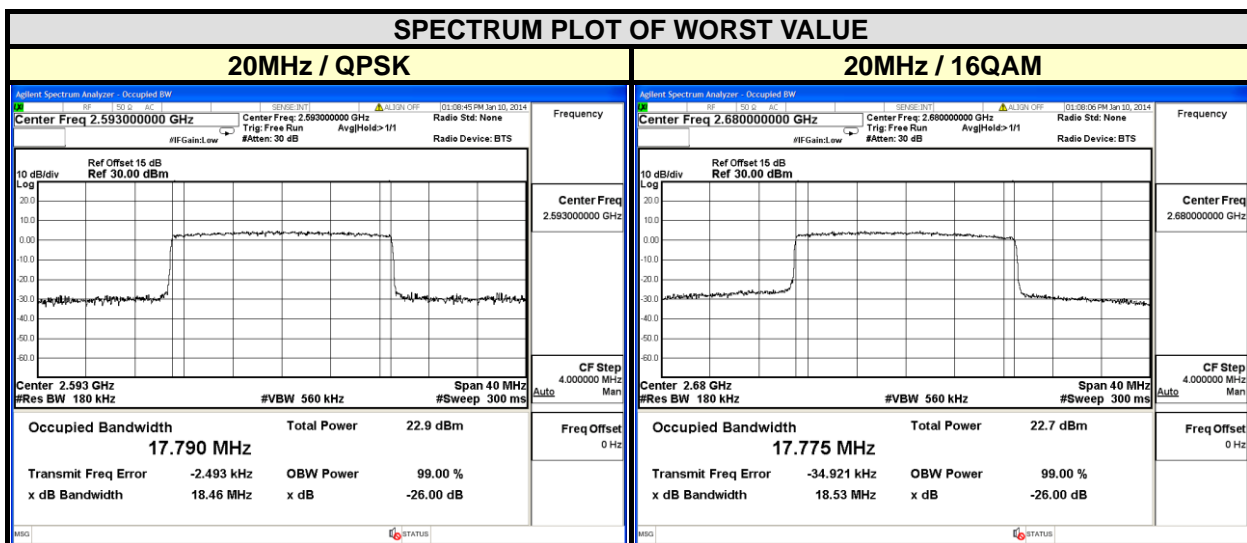

## 4.4 PEAK TO AVERAGE RATIO

### 4.4.1 LIMITS OF PEAK TO AVERAGE RATIO MEASUREMENT

In measuring transmissions in this band using an average power technique, the peak to-average ratio (PAR) of the transmission may not exceed 13 dB

### 4.4.2 TEST SETUP

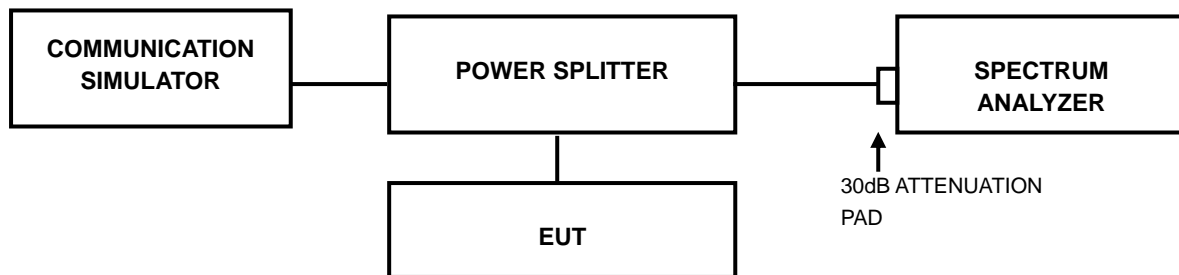

### 4.4.3 TEST PROCEDURES

1. Set resolution/measurement bandwidth  $\geq$  signal's occupied bandwidth;
2. Set the number of counts to a value that stabilizes the measured CCDF curve;
3. Record the maximum PAPR level associated with a probability of 0.1%.



A D T

### 4.4.4 TEST RESULTS

LTE BAND 41							
CHANNEL BANDWIDTH: 10MHz				CHANNEL BANDWIDTH: 15MHz			
CHANNEL	FREQUENCY (MHz)	PEAK TO AVERAGE RATIO (dB)		CHANNEL	FREQUENCY (MHz)	PEAK TO AVERAGE RATIO (dB)	
		QPSK	16QAM			QPSK	16QAM
39700	2501.0	8.22	10.15	39725	2503.5	6.64	9.56
40620	2593.0	7.59	9.70	40620	2593.0	7.97	9.53
41540	2685.0	7.17	8.75	41515	2682.5	7.28	8.32

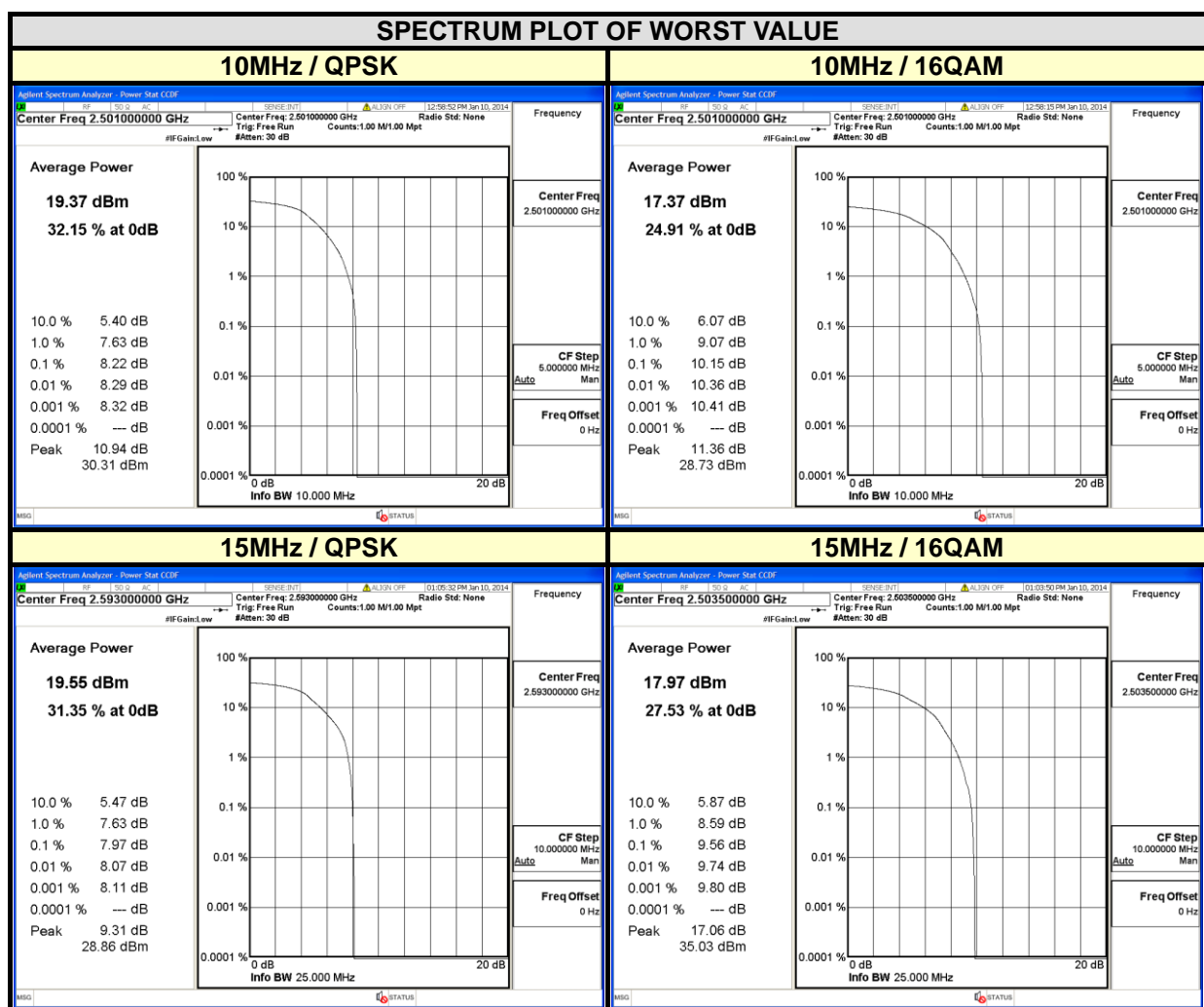



A D T

LTE BAND 41			
CHANNEL BANDWIDTH: 20MHz			
CHANNEL	FREQUENCY (MHz)	PEAK TO AVERAGE RATIO (dB)	
		QPSK	16QAM
39750	2506.0	7.25	7.58
40620	2593.0	8.46	9.87
41490	2680.0	11.56	9.16

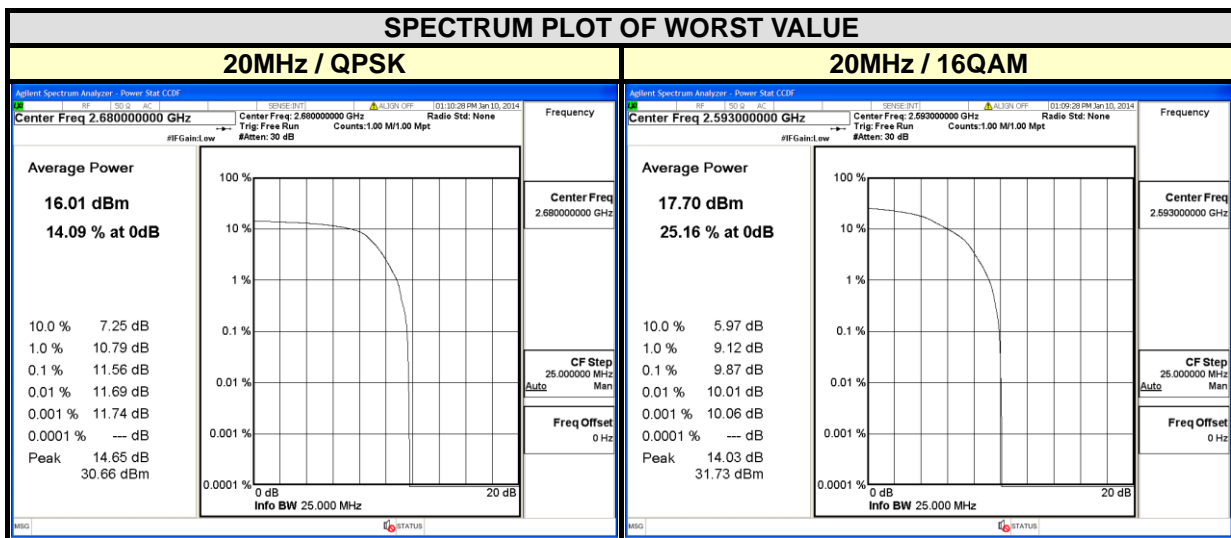



## 4.5 BAND EDGE MEASUREMENT

### 4.5.1 LIMITS OF BAND EDGE MEASUREMENT

According to FCC 27.53(l)(4) specified that power of any emission outside of the channel edge must be attenuated below the transmitting power (P) by a factor shall be not less than  $43 + 10 \log (P)$  dB at the channel edge, the limit of emission equal to  $-13\text{dBm}$ . And  $55 + 10 \log (P)$  dB at 5.5 MHz from the channel edges, the limit of emission equal to  $-25\text{dBm}$ . In the 1MHz bands immediately outside and adjacent to the frequency block a resolution bandwidth of at least one percent of the emission bandwidth of the fundamental emission of the transmitter may be employed.

### 4.5.2 TEST SETUP

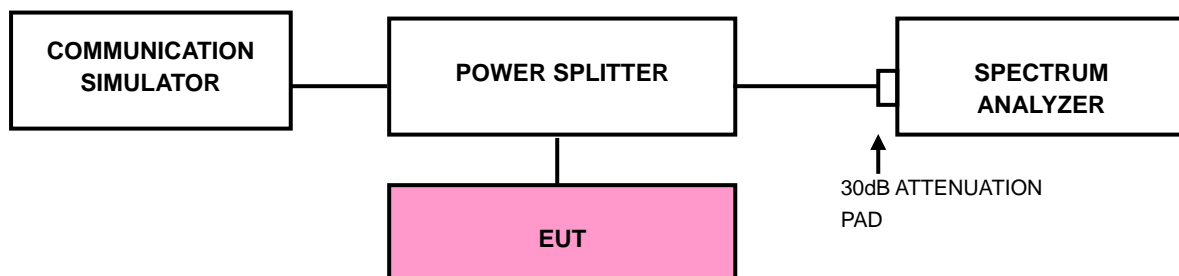

#### 4.5.3 TEST PROCEDURES

- a. The EUT was set up for the maximum peak power with LTE link data modulation. The power was measured with R&S Spectrum Analyzer. All measurements were done at 2 channels (low and high operational frequency range.).
- b. The band edge measurement used the power splitter via EUT RF power connector between simulation base station and spectrum analyzer.
- c. The center frequency of spectrum is the band edge frequency and span is 20 MHz. RB of the spectrum is 100kHz and VB of the spectrum is 300kHz (Channel bandwidth 5MHz).
- d. The center frequency of spectrum is the band edge frequency and span is 40 MHz. RB of the spectrum is 100kHz and VB of the spectrum is 300kHz (Channel bandwidth 10MHz).
- e. The center frequency of spectrum is the band edge frequency and span is 60 MHz. RB of the spectrum is 200kHz and VB of the spectrum is 1MHz (Channel bandwidth 15MHz).
- f. The center frequency of spectrum is the band edge frequency and span is 80 MHz. RB of the spectrum is 200kHz and VB of the spectrum is 1MHz (Channel bandwidth 20MHz).
- g. Record the max trace plot into the test report.

### 4.5.4 TEST RESULTS

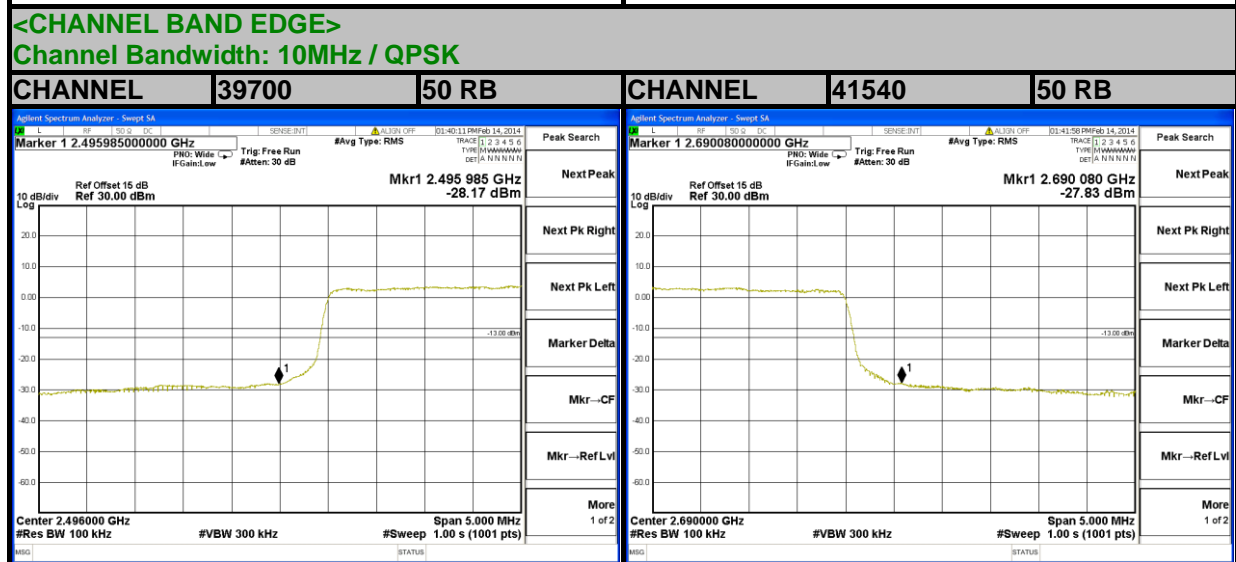
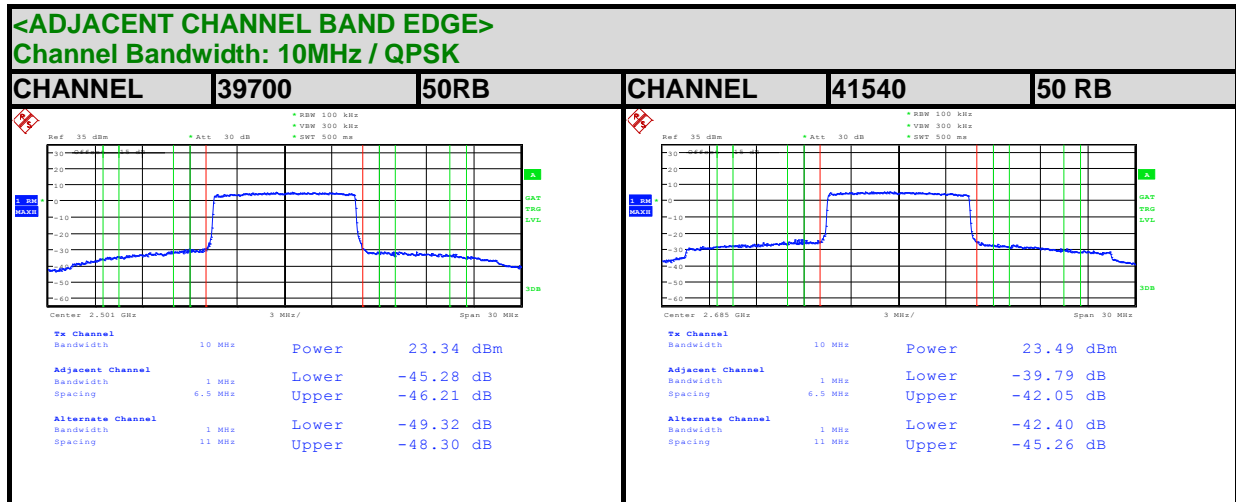



A D T

### <ADJACENT CHANNEL BAND EDGE> Channel Bandwidth: 10MHz / 16QAM

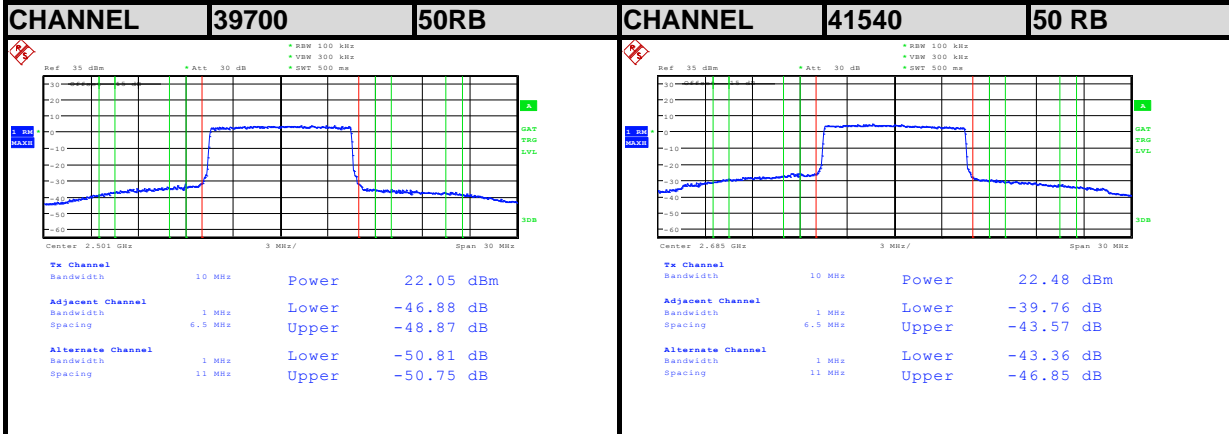

### <CHANNEL BAND EDGE> Channel Bandwidth: 10MHz / 16QAM

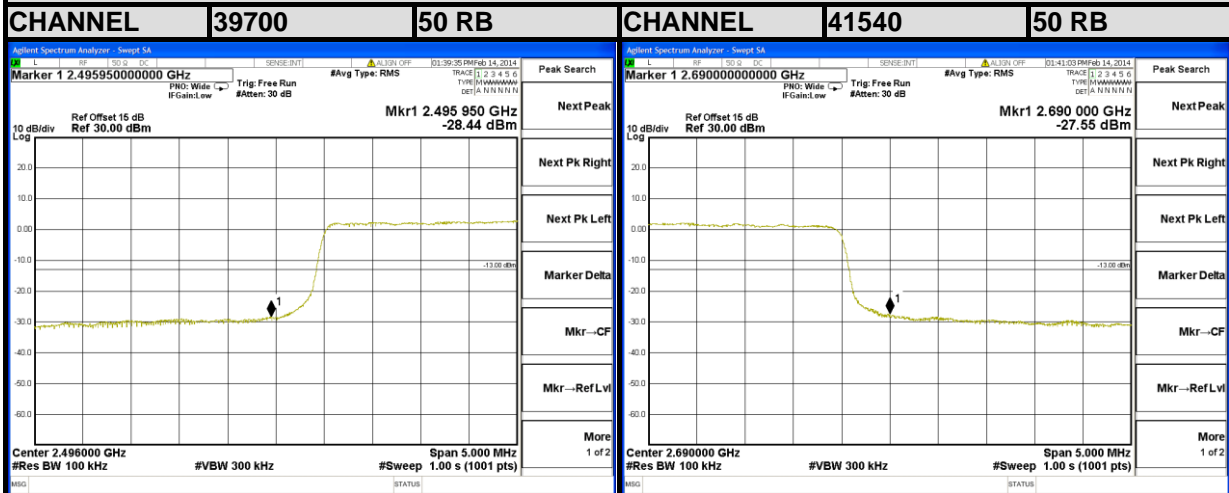



A D T

**<ADJACENT CHANNEL BAND EDGE>**  
**Channel Bandwidth: 15MHz / QPSK**

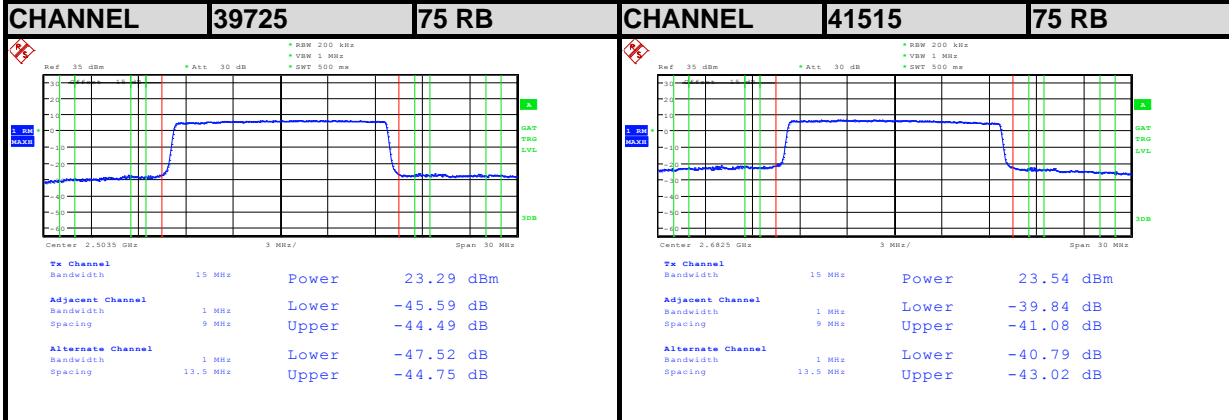

**<CHANNEL BAND EDGE>**  
**Channel Bandwidth: 15MHz / QPSK**

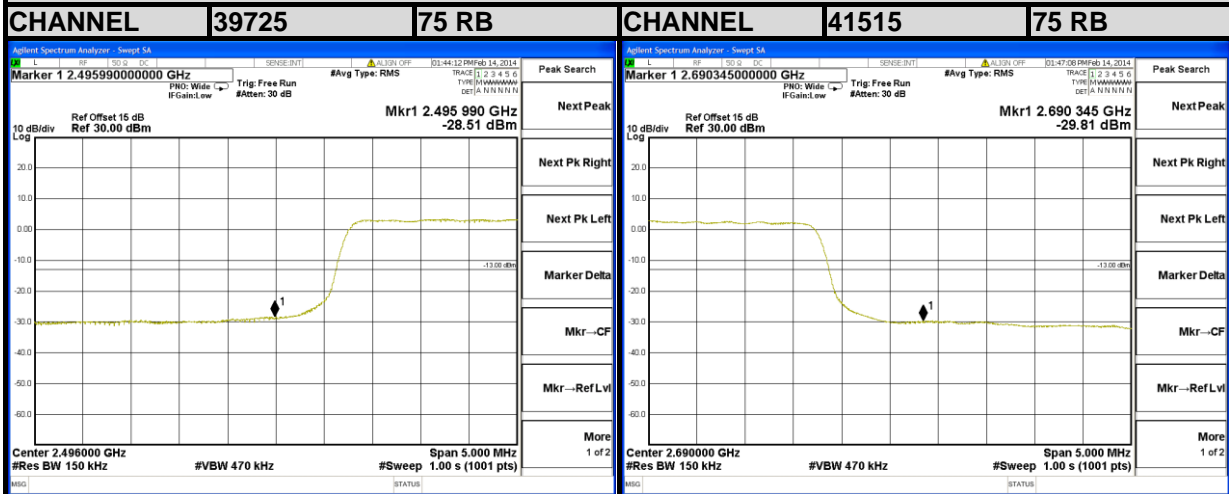



A D T

**<ADJACENT CHANNEL BAND EDGE>**  
**Channel Bandwidth: 15MHz / 16QAM**

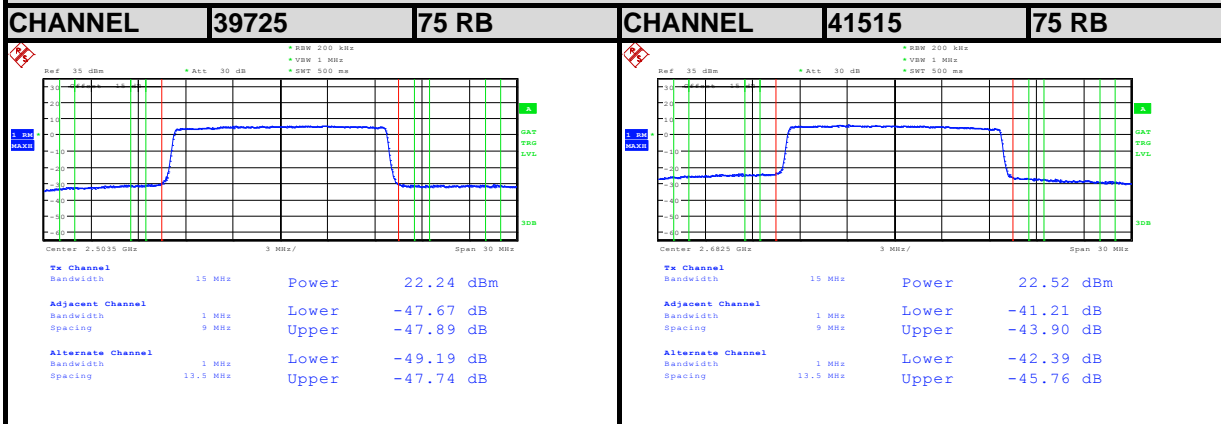

**<CHANNEL BAND EDGE>**  
**Channel Bandwidth: 15MHz / 16QAM**

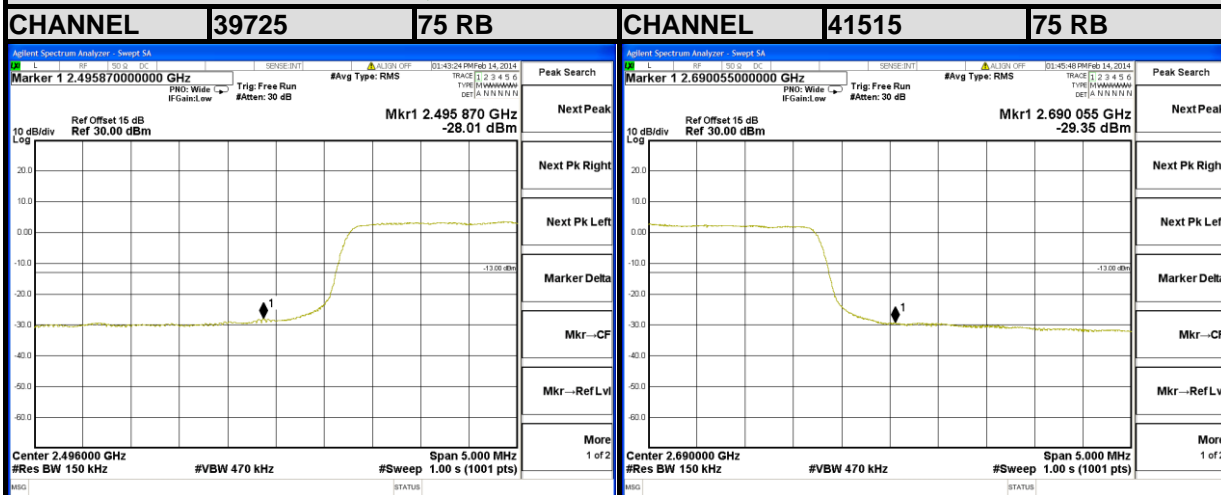



A D T

<ADJACENT CHANNEL BAND EDGE>  
Channel Bandwidth: 20MHz / QPSK

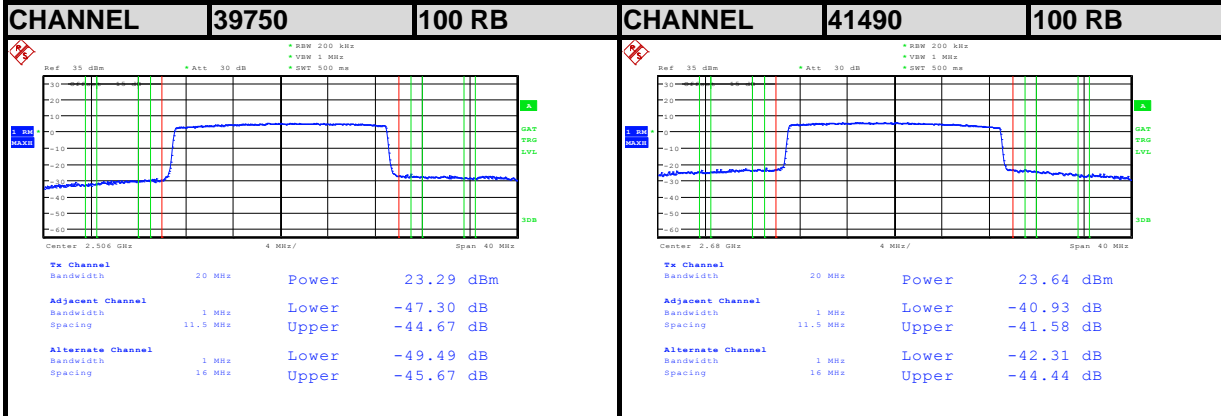

<CHANNEL BAND EDGE>  
Channel Bandwidth: 20MHz / QPSK

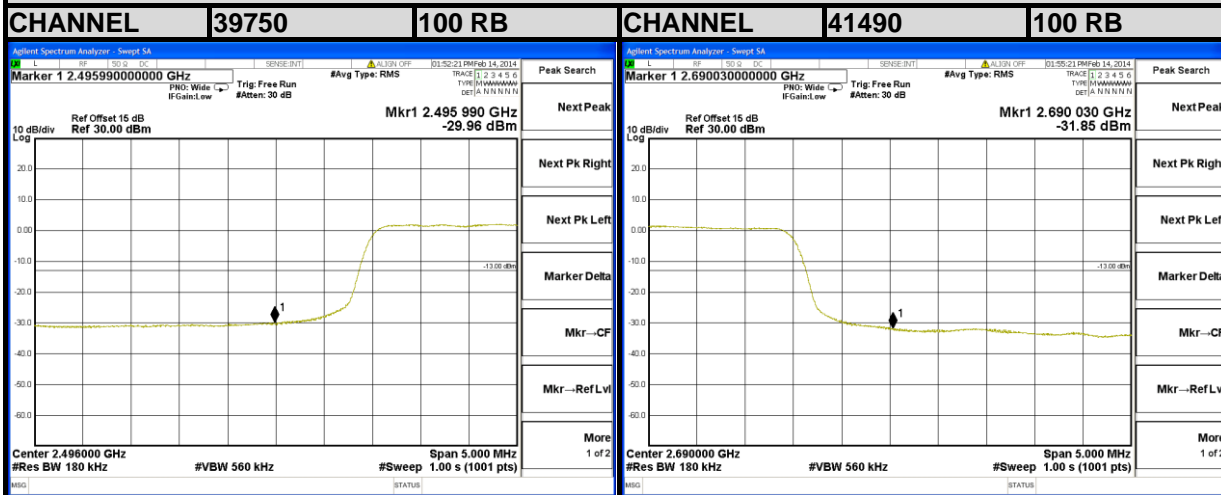



A D T

<ADJACENT CHANNEL BAND EDGE>  
Channel Bandwidth: 20MHz / 16QAM

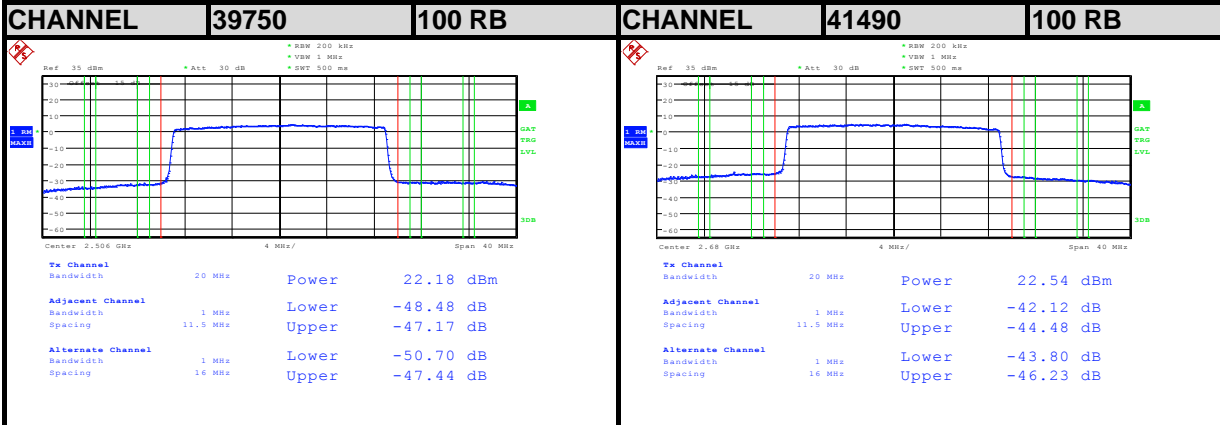

<CHANNEL BAND EDGE>  
Channel Bandwidth: 20MHz / 16QAM

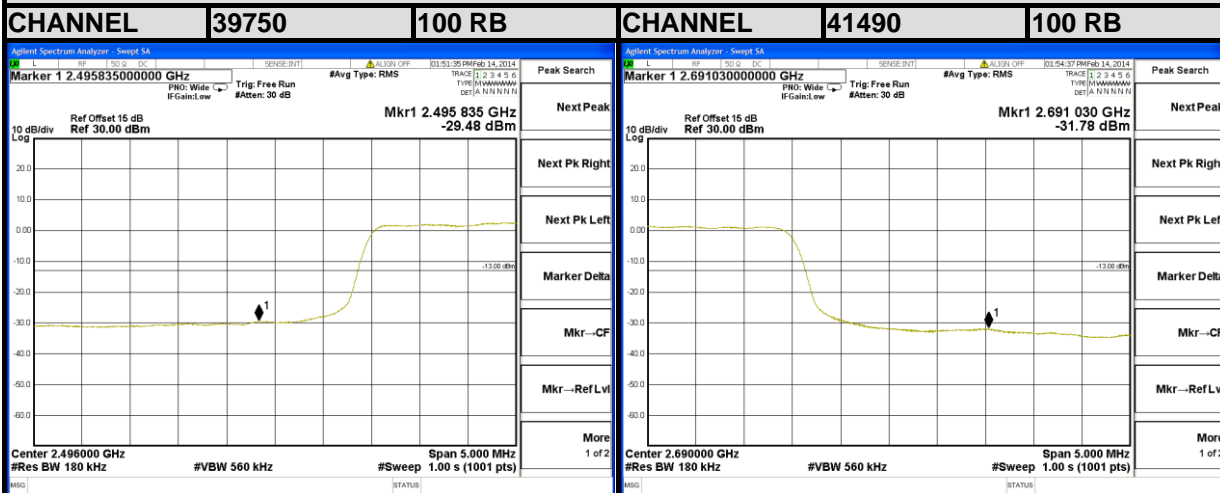



## 4.6 CONDUCTED SPURIOUS EMISSIONS

### 4.6.1 LIMITS OF CONDUCTED SPURIOUS EMISSIONS MEASUREMENT

The power of any emission outside a licensee's frequency block shall be attenuated below the transmitter power (P) by at least  $55 + 10 \log_{10}(P)$  dB. The limit of emission equal to  $-25\text{dBm}$

### 4.6.2 TEST PROCEDURE

- a. The EUT makes a phone call to the communication simulator. All measurements were done at low, middle and high operational frequency range.
- b. Measuring frequency range is from 30 MHz to 27GHz for LTE Band 41. 10dB attenuation pad is connected with spectrum. RBW=1MHz and VBW=3MHz are used for conducted emission measurement.

### 4.6.3 TEST SETUP

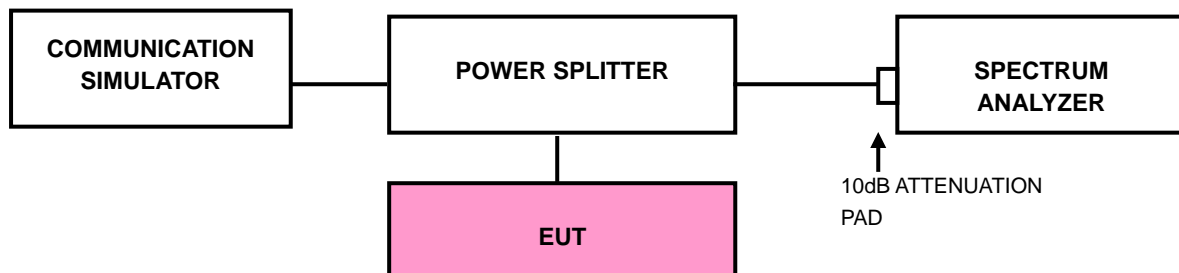



A D T

### 4.6.4 TEST RESULTS

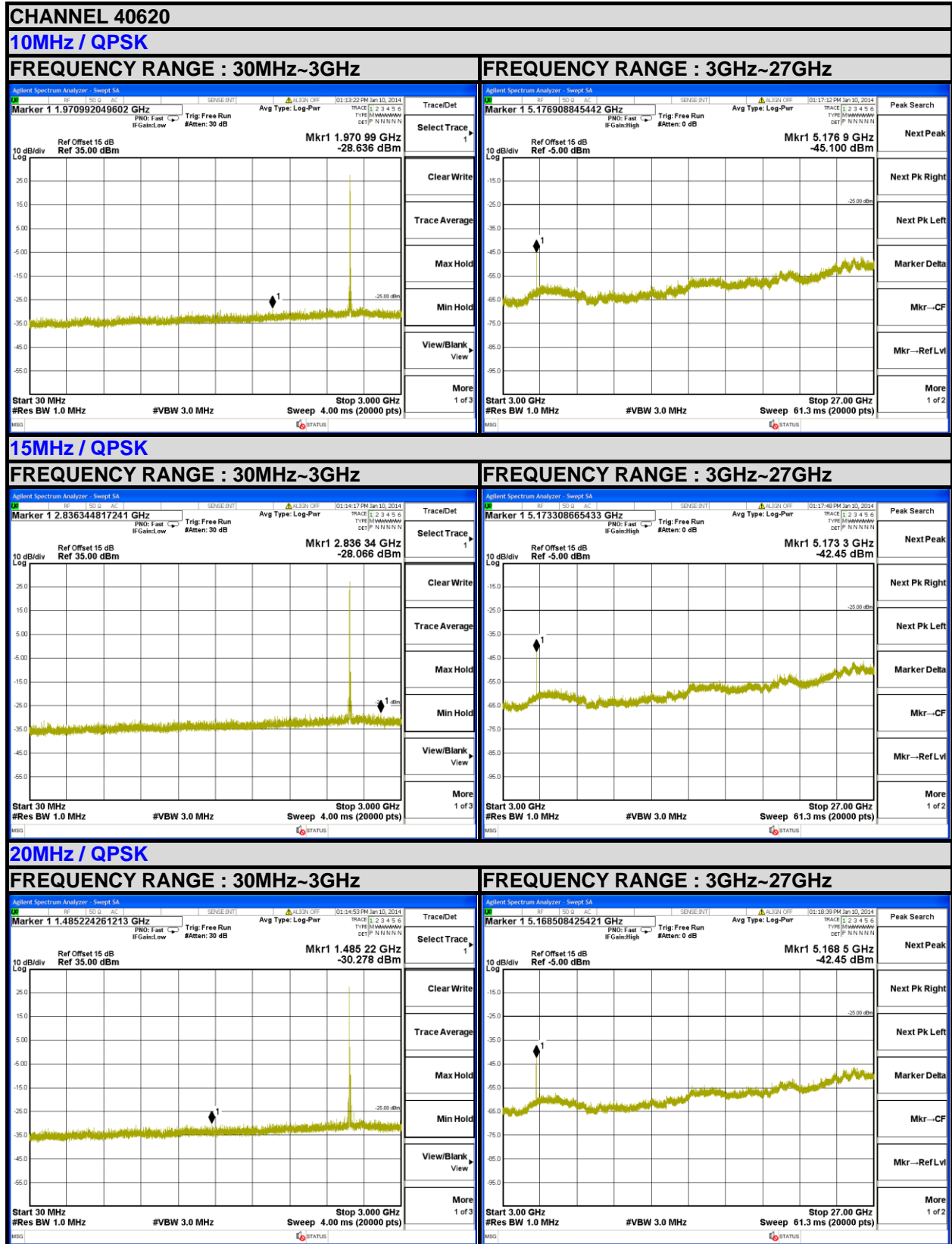

## 4.7 RADIATED EMISSION MEASUREMENT

### 4.7.1 LIMITS OF RADIATED EMISSION MEASUREMENT

The power of any emission outside a licensee's frequency block shall be attenuated below the transmitter power (P) by at least  $55 + 10 \log_{10}(P)$  dB. The limit of emission equal to  $-25\text{dBm}$

### 4.7.2 TEST PROCEDURES

- a. Substitution method is used for E.I.R.P measurement. In the semi-anechoic chamber, EUT placed on the 0.8m height of Turn Table, rotated the table around 360 degrees to search the maximum radiation power and receiver antenna shall be rotated vertical and horizontal polarization and moved height from 1m to 4m to find the maximum polar radiated power. The "Read Value" is the spectrum reading the maximum power value.
- b. The substitution horn antenna is substituted for EUT at the same position and signals generator export the CW signal to the substitution antenna via a TX cable. Rotated the Turn Table and moved receiving antenna to find the maximum radiation power. Adjust output power level of S.G to get a Value of spectrum reading equal to "Read Value" of step a. Record the power level of S.G
- c.  $\text{EIRP} = \text{Output power level of S.G} - \text{TX cable loss} + \text{Antenna gain of substitution horn.}$
- d. E.R.P power can be calculated form E.I.R.P power by subtracting the gain of dipole,  $\text{E.R.P power} = \text{E.I.P.R power} - 2.15\text{dBi.}$

**NOTE:** The resolution bandwidth of spectrum analyzer is 1 MHz and the video bandwidth is 3 MHz.

### 4.7.3 DEVIATION FROM TEST STANDARD

No deviation

#### 4.7.4 TEST SETUP

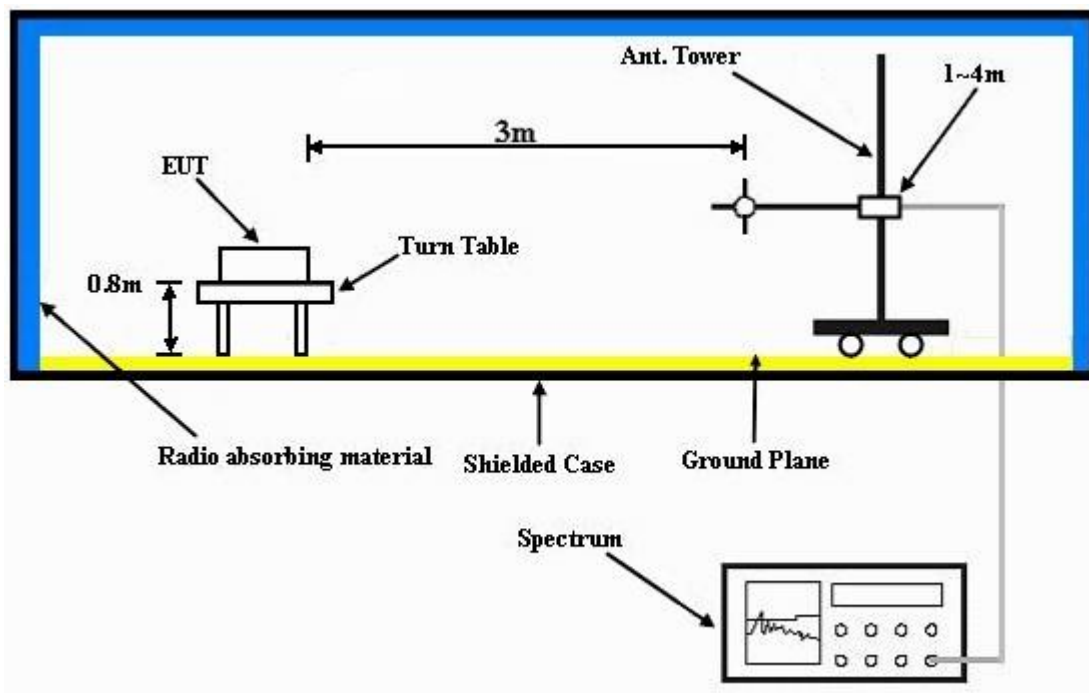

For the actual test configuration, please refer to the attached file (Test Setup Photo).



A D T

### 4.7.5 TEST RESULTS

#### LTE BAND 41

CHANNEL BANDWIDTH: 10MHz / QPSK (1 RB / 0 RB Offset)



Bureau Veritas Consumer Products Services Ltd., Taoyuan Branch

A D T

Data: 13

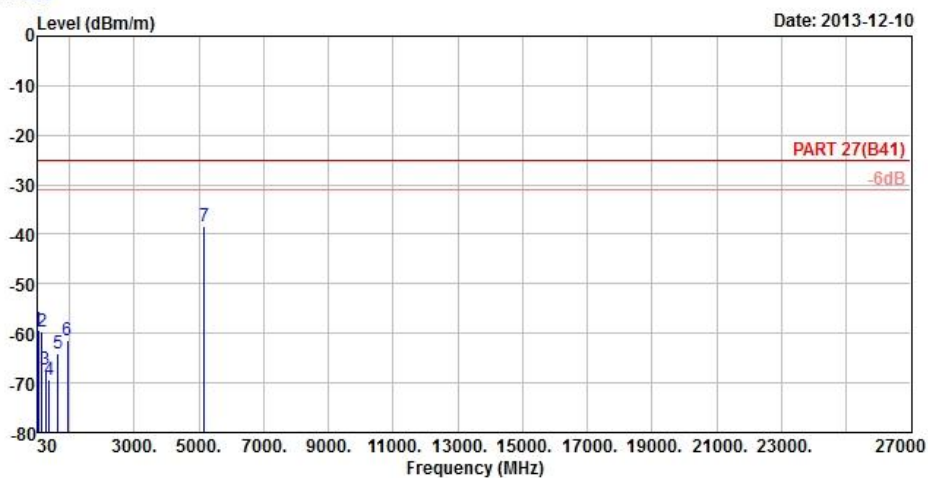

Site : 966 Chamber 5  
 Condition : PART 27(B41) 3m HORIZONTAL  
 Brand/Model: G81-C6730  
 Remark : Band 41 10M QPSK(1,0) Link  
 Tested by : Anson Lin  
 Temperature : 25°C  
 Humidity : 65%  
 Plane : X  
 Sample No : C131120-002-024-006

	Read	Limit	Over			
Freq	Level	Level	Line	Limit	Factor	Remark
MHz	dBm/m	dBm	dBm/m	dB	dB/m	
1	39.45	-59.20	-57.67	-25.00	-34.20	-1.53 Peak
2	146.10	-59.58	-53.47	-25.00	-34.58	-6.11 Peak
3	258.96	-67.23	-61.43	-25.00	-42.23	-5.80 Peak
4	379.10	-69.23	-63.44	-25.00	-44.23	-5.79 Peak
5	653.50	-64.06	-64.67	-25.00	-39.06	0.61 Peak
6	948.20	-61.35	-65.01	-25.00	-36.35	3.66 Peak
7 pp	5177.20	-38.36	-35.21	-25.00	-13.36	-3.15 Peak



A D T



Bureau Veritas Consumer Products Services Ltd., Taoyuan Branch

A D T

Data: 14

Date: 2013-12-10

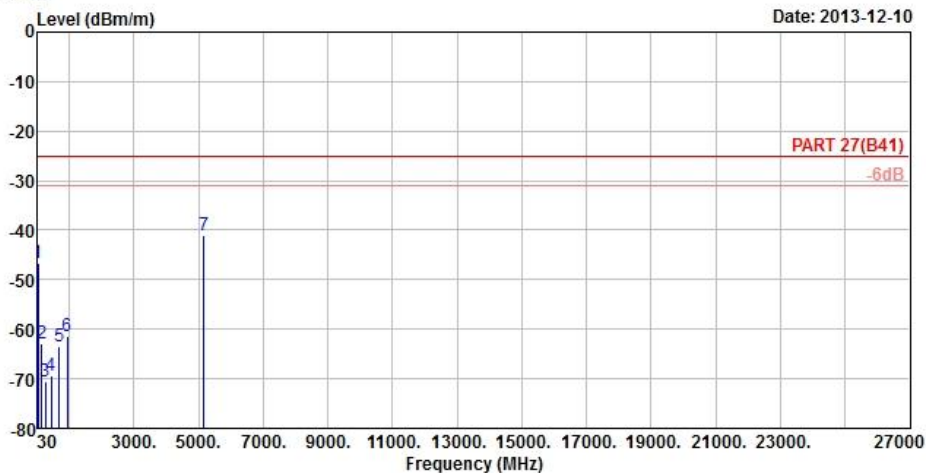

Site : 966 Chamber 5  
 Condition : PART 27(B41) 3m VERTICAL  
 Brand/Model: G81-C6730  
 Remark : Band 41 10M QPSK(1,0) Link  
 Tested by : Anson Lin  
 Temperature : 25°C  
 Humidity : 65%  
 Plane : X  
 Sample No : C131120-002-024-006

	Freq	Level	Read Level	Limit Line	Over Limit	Factor	Remark
	MHz	dBm/m	dBm	dBm/m	dB	dB/m	
1	40.80	-46.67	-45.21	-25.00	-21.67	-1.46	Peak
2	140.97	-62.81	-57.08	-25.00	-37.81	-5.73	Peak
3	261.66	-70.54	-64.70	-25.00	-45.54	-5.84	Peak
4	440.70	-69.52	-64.91	-25.00	-44.52	-4.61	Peak
5	685.70	-63.34	-64.53	-25.00	-38.34	1.19	Peak
6	932.80	-61.52	-64.87	-25.00	-36.52	3.35	Peak
7 pp	5177.20	-40.92	-37.77	-25.00	-15.92	-3.15	Peak

**CHANNEL BANDWIDTH: 10MHz / QPSK (50 RB / 0 RB Offset)**



Bureau Veritas Consumer Products Services Ltd., Taoyuan Branch

A D T

Data: 13

Date: 2013-12-10

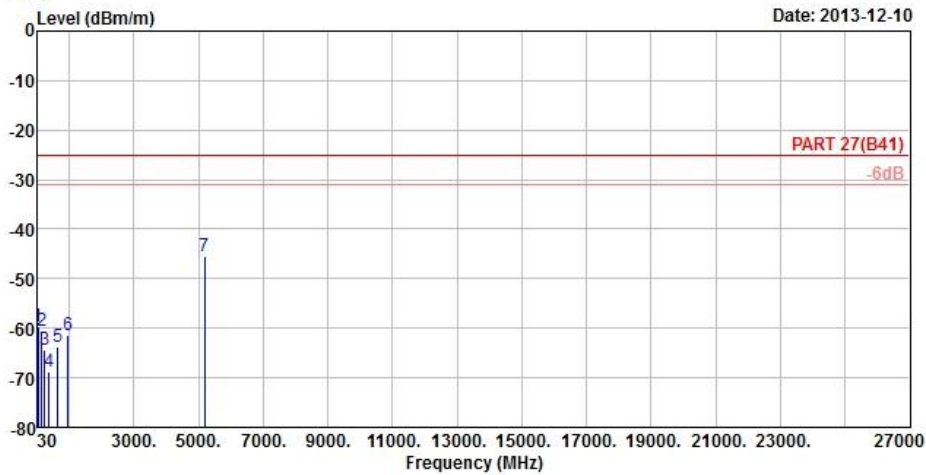

Site : 966 Chamber 5  
 Condition : PART 27(B41) 3m HORIZONTAL  
 Brand/Model: G81-C6730  
 Remark : Band 41 10M QPSK(50,0) Link  
 Tested by : Anson Lin  
 Temperature : 25°C  
 Humidity : 65%  
 Plane : X  
 Sample No : C131120-002-024-006

	Freq	Level	Read Level	Limit	Over	Factor	Remark
	MHz	dBm/m	dBm	dBm/m	dB	dB/m	
1	41.61	-59.58	-58.19	-25.00	-34.58	-1.39	Peak
2	146.10	-60.64	-54.53	-25.00	-35.64	-6.11	Peak
3	243.03	-64.21	-58.22	-25.00	-39.21	-5.99	Peak
4	374.90	-68.85	-63.03	-25.00	-43.85	-5.82	Peak
5	643.70	-63.62	-64.06	-25.00	-38.62	0.44	Peak
6	958.70	-61.43	-65.28	-25.00	-36.43	3.85	Peak
7 pp	5186.00	-45.54	-42.48	-25.00	-20.54	-3.06	Peak



A D T



Bureau Veritas Consumer Products Services Ltd., Taoyuan Branch

A D T

Data: 14

Date: 2013-12-10

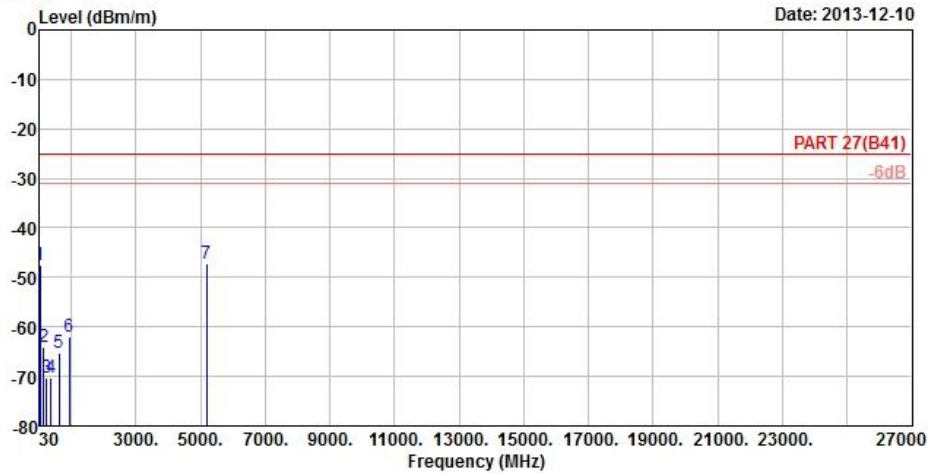

Site : 966 Chamber 5  
 Condition : PART 27(B41) 3m VERTICAL  
 Brand/Model: G81-C6730  
 Remark : Band 41 10M QPSK(50,0) Link  
 Tested by : Anson Lin  
 Temperature : 25°C  
 Humidity : 65%  
 Plane : X  
 Sample No : C131120-002-024-006

	Read	Limit	Over			
Freq	Level	Level	Line	Limit	Factor	Remark
MHz	dBm/m	dBm	dBm/m	dB	dB/m	
1	39.45	-47.57	-46.04	-25.00	-22.57	-1.53 Peak
2	140.16	-64.11	-58.38	-25.00	-39.11	-5.73 Peak
3	251.40	-70.25	-64.56	-25.00	-45.25	-5.69 Peak
4	371.40	-70.29	-64.44	-25.00	-45.29	-5.85 Peak
5	622.70	-65.22	-65.27	-25.00	-40.22	0.05 Peak
6	930.00	-61.98	-65.27	-25.00	-36.98	3.29 Peak
7 pp	5186.00	-47.11	-44.05	-25.00	-22.11	-3.06 Peak



**CHANNEL BANDWIDTH: 15MHz / QPSK (1 RB / 0 RB Offset)**



Bureau Veritas Consumer Products Services Ltd., Taoyuan Branch

A D T

Data: 9

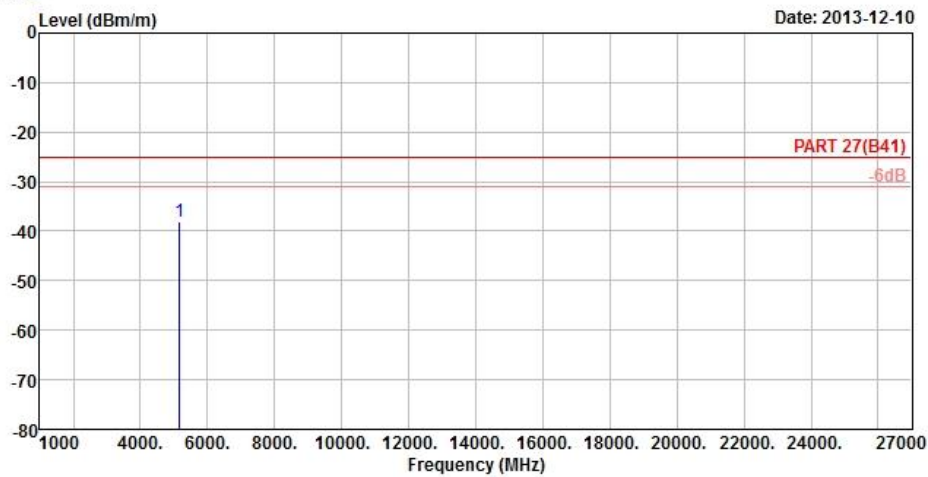

Site : 966 Chamber 5  
 Condition : PART 27(B41) 3m HORIZONTAL  
 Brand/Model: G81-C6730  
 Remark : Band 41 15M QPSK(1,0) Link  
 Tested by : Anson Lin  
 Temperature : 25°C  
 Humidity : 65%  
 Plane : X  
 Sample No : C131120-002-024-006

Freq	Level	Read Level	Limit Line	Over Limit	Factor	Remark
MHz	dBm/m	dBm	dBm/m	dB	dB/m	
1 pp 5172.80	-38.09	-34.94	-25.00	-13.09	-3.15	Peak



A D T



Bureau Veritas Consumer Products Services Ltd., Taoyuan Branch

A D T

Data: 10

Date: 2013-12-10

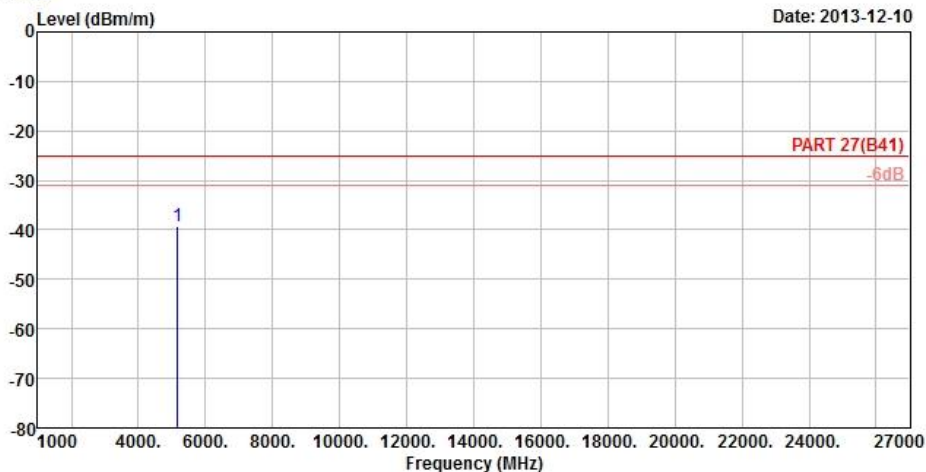

Site : 966 Chamber 5  
 Condition : PART 27(B41) 3m VERTICAL  
 Brand/Model: G81-C6730  
 Remark : Band 41 15M QPSK(1,0) Link  
 Tested by : Anson Lin  
 Temperature : 25°C  
 Humidity : 65%  
 Plane : X  
 Sample No : C131120-002-024-006

	Read	Limit	Over			
Freq	Level	Level	Line	Limit	Factor	Remark
MHz	dBm/m	dBm	dBm/m	dB	dB/m	
1 pp 5172.80	-39.17	-36.02	-25.00	-14.17	-3.15	Peak

**CHANNEL BANDWIDTH: 15MHz / QPSK (75 RB / 0 RB Offset)**



Bureau Veritas Consumer Products Services Ltd., Taoyuan Branch

A D T

Data: 9

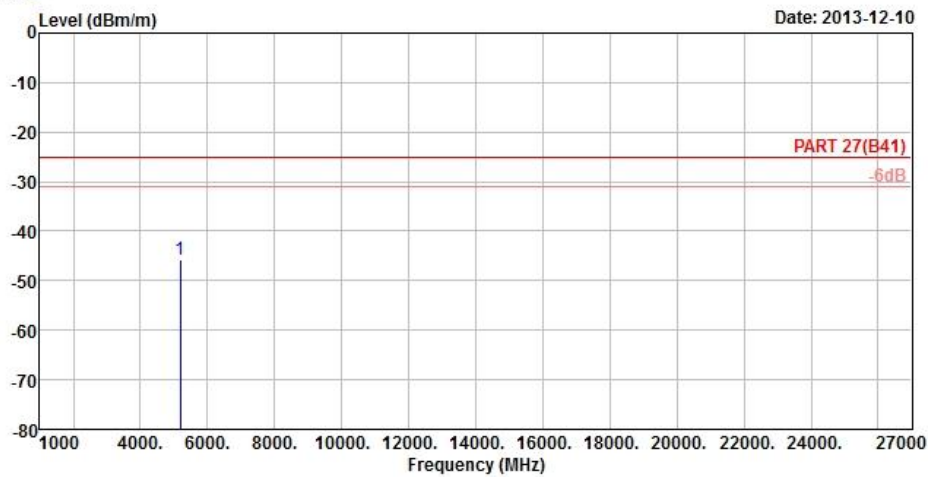

Site : 966 Chamber 5  
 Condition : PART 27(B41) 3m HORIZONTAL  
 Brand/Model: G81-C6730  
 Remark : Band 41 15M QPSK(75,0) Link  
 Tested by : Anson Lin  
 Temperature : 25°C  
 Humidity : 65%  
 Plane : X  
 Sample No : C131120-002-024-006

Freq	Level	Read Level	Limit	Over	Factor	Remark
MHz	dBm/m	dBm	dBm/m	dB	dB/m	
1 pp 5186.00	-45.79	-42.73	-25.00	-20.79	-3.06	Peak



A D T



Bureau Veritas Consumer Products Services Ltd., Taoyuan Branch

A D T

Data: 10

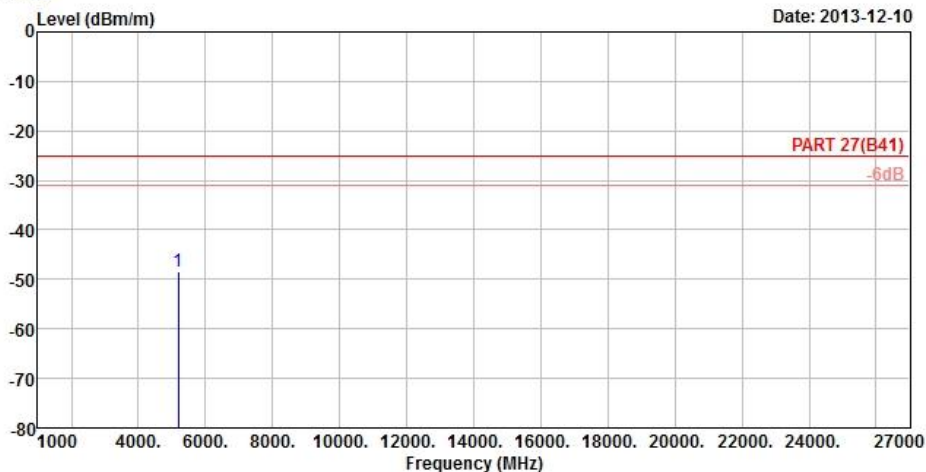

Site : 966 Chamber 5  
 Condition : PART 27(B41) 3m VERTICAL  
 Brand/Model: G81-C6730  
 Remark : Band 41 15M QPSK(75,0) Link  
 Tested by : Anson Lin  
 Temperature : 25°C  
 Humidity : 65%  
 Plane : X  
 Sample No : C131120-002-024-006

	Read	Limit	Over			
Freq	Level	Level	Line	Limit	Factor	Remark
MHz	dBm/m	dBm	dBm/m	dB	dB/m	
1 pp 5186.00	-48.32	-45.26	-25.00	-23.32	-3.06	Peak

**CHANNEL BANDWIDTH: 20MHz / QPSK (1 RB / 0 RB Offset)**



Bureau Veritas Consumer Products Services Ltd., Taoyuan Branch

A D T

Data: 9

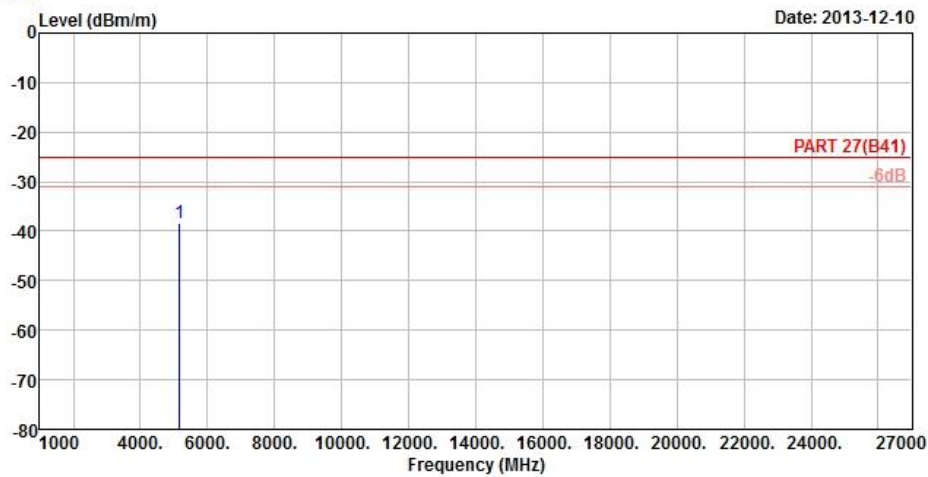

Site : 966 Chamber 5  
 Condition : PART 27(B41) 3m HORIZONTAL  
 Brand/Model: G81-C6730  
 Remark : Band 41 20M QPSK(1,0) Link  
 Tested by : Anson Lin  
 Temperature : 25°C  
 Humidity : 65%  
 Plane : X  
 Sample No : C131120-002-024-006

Freq	Level	Read Level	Limit	Over	Limit Factor	Remark
MHz	dBm/m	dBm	dBm/m	dB	dB/m	
1 pp 5168.40	-38.34	-35.19	-25.00	-13.34	-3.15	Peak



A D T



Bureau Veritas Consumer Products Services Ltd., Taoyuan Branch

A D T

Data: 10

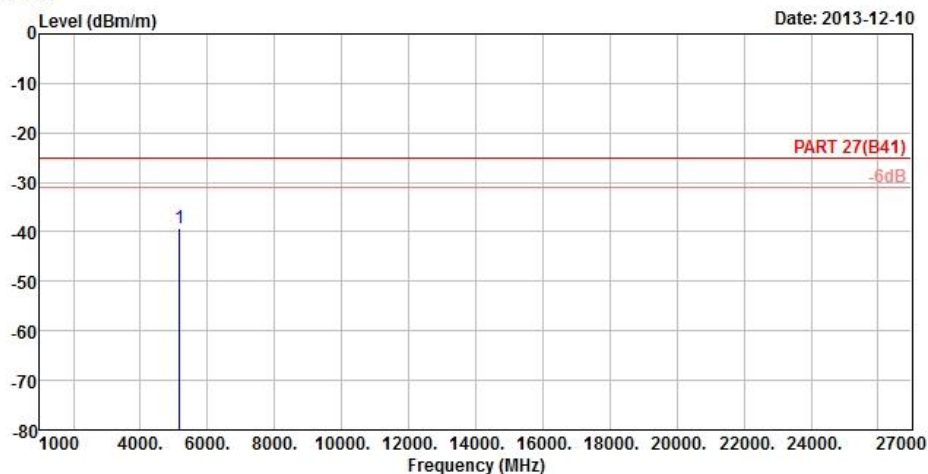

Site : 966 Chamber 5  
 Condition : PART 27(B41) 3m VERTICAL  
 Brand/Model: G81-C6730  
 Remark : Band 41 20M QPSK(1,0) Link  
 Tested by : Anson Lin  
 Temperature : 25°C  
 Humidity : 65%  
 Plane : X  
 Sample No : C131120-002-024-006

Freq	Level	Read Level	Limit Line	Over Limit	Factor	Remark
MHz	dBm/m	dBm	dBm/m	dB	dB/m	
1 pp 5168.40	-39.24	-36.09	-25.00	-14.24	-3.15	Peak



A D T

### CHANNEL BANDWIDTH: 20MHz / QPSK (100 RB / 0 RB Offset)



Bureau Veritas Consumer Products Services Ltd., Taoyuan Branch

A D T

Data: 9

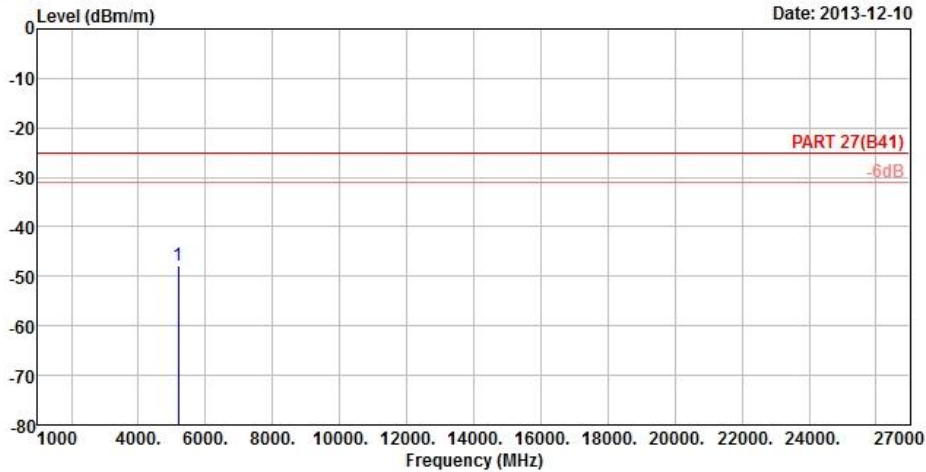

Site : 966 Chamber 5  
 Condition : PART 27(B41) 3m HORIZONTAL  
 Brand/Model: G81-C6730  
 Remark : Band 41 20M QPSK(100,0) Link  
 Tested by : Anson Lin  
 Temperature : 25°C  
 Humidity : 65%  
 Plane : X  
 Sample No : C131120-002-024-006

	Read	Limit	Over			
Freq	Level	Level	Line	Limit	Factor	Remark
MHz	dBm/m	dBm	dBm/m	dB	dB/m	
1 pp 5186.00	-47.97	-44.91	-25.00	-22.97	-3.06	Peak



A D T



Bureau Veritas Consumer Products Services Ltd., Taoyuan Branch

A D T

Data: 10

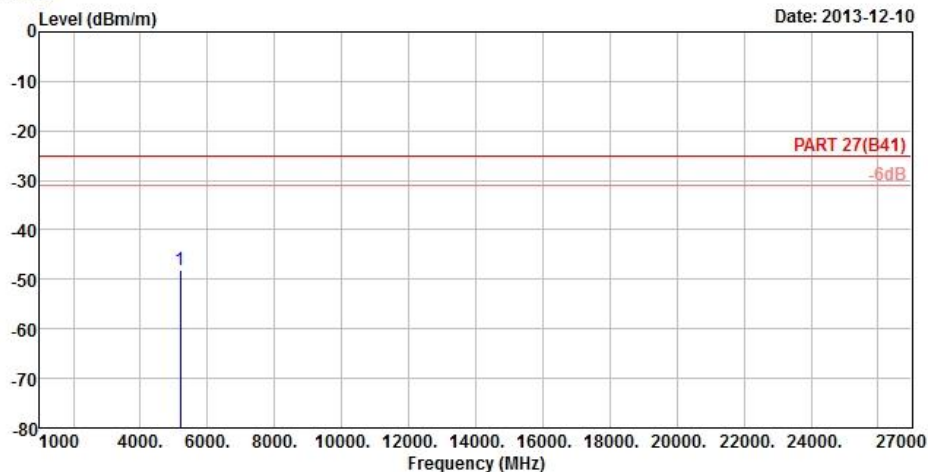

Site : 966 Chamber 5  
 Condition : PART 27(B41) 3m VERTICAL  
 Brand/Model: G81-C6730  
 Remark : Band 41 20M QPSK(100,0) Link  
 Tested by : Anson Lin  
 Temperature : 25°C  
 Humidity : 65%  
 Plane : X  
 Sample No : C131120-002-024-006

	Read	Limit	Over			
Freq	Level	Level	Line	Limit	Factor	Remark
MHz	dBm/m	dBm	dBm/m	dB	dB/m	
1 pp 5186.00	-48.06	-45.00	-25.00	-23.06	-3.06	Peak





## 5 INFORMATION ON THE TESTING LABORATORIES

We, Bureau Veritas Consumer Products Services (H.K.) Ltd., Taoyuan Branch, were founded in 1988 to provide our best service in EMC, Radio, Telecom and Safety consultation. Our laboratories are accredited and approved according to ISO/IEC 17025.

If you have any comments, please feel free to contact us at the following:

**Linko EMC/RF Lab:**

Tel: 886-2-26052180

Fax: 886-2-26051924

**Hsin Chu EMC/RF Lab:**

Tel: 886-3-5935343

Fax: 886-3-5935342

**Hwa Ya EMC/RF/Safety/Telecom Lab:**

Tel: 886-3-3183232

Fax: 886-3-3270892

**Email:** [service.adt@tw.bureauveritas.com](mailto:service.adt@tw.bureauveritas.com)

**Web Site:** [www.adt.com.tw](http://www.adt.com.tw)

The address and road map of all our labs can be found in our web site also.



A D T

## **6 APPENDIX A – MODIFICATIONS RECORDERS FOR ENGINEERING CHANGES TO THE EUT BY THE LAB**

No modifications were made to the EUT by the lab during the test.

**---END---**