



A D T

FCC TEST REPORT (BLUETOOTH)

REPORT NO.: RF131119C06-4
MODEL NO.: C6725
FCC ID: V65C6725
RECEIVED: Nov. 19, 2013
TESTED: Nov. 22, 2013 ~ Dec. 05, 2013
ISSUED: Dec. 18, 2013

APPLICANT: Kyocera Communications, Inc. c/o Kyocera Corporation

ADDRESS: 8611 Balboa Ave. San Diego, CA 92123

ISSUED BY: Bureau Veritas Consumer Products Services (H.K.) Ltd., Taoyuan Branch

LAB ADDRESS: No. 47, 14th Ling, Chia Pau Vil., Lin Kou Dist., New Taipei City, Taiwan (R.O.C)

TEST LOCATION: No. 19, Hwa Ya 2nd Rd, Wen Hwa Tsuen, Kwei Shan Hsiang, Taoyuan Hsien 333, Taiwan, R.O.C.

This report should not be used by the client to claim product certification, approval, or endorsement by TAF or any government agencies.



This report is for your exclusive use. Any copying or replication of this report to or for any other person or entity, or use of our name or trademark, is permitted only with our prior written permission. This report sets forth our findings solely with respect to the test samples identified herein. The results set forth in this report are not indicative or representative of the quality or characteristics of the lot from which a test sample was taken or any similar or identical product unless specifically and expressly noted. Our report includes all of the tests requested by you and the results thereof based upon the information that you provided to us. You have 60 days from date of issuance of this report to notify us of any material error or omission caused by our negligence, provided, however, that such notice shall be in writing and shall specifically address the issue you wish to raise. A failure to raise such issue within the prescribed time shall constitute your unqualified acceptance of the completeness of this report, the tests conducted and the correctness of the report contents. Unless specific mention, the uncertainty of measurement has been explicitly taken into account to declare the compliance or non-compliance to the specification.



TABLE OF CONTENTS

RELEASE CONTROL RECORD	5
1. CERTIFICATION.....	6
2. SUMMARY OF TEST RESULTS	7
2.1 MEASUREMENT UNCERTAINTY.....	8
3. GENERAL INFORMATION	9
3.1 GENERAL DESCRIPTION OF EUT	9
3.2 DESCRIPTION OF TEST MODES	10
3.2.1 TEST MODE APPLICABILITY AND TESTED CHANNEL DETAIL.....	11
3.3 DESCRIPTION OF SUPPORT UNITS	15
3.3.1 CONFIGURATION OF SYSTEM UNDER TEST	15
3.4 GENERAL DESCRIPTION OF APPLIED STANDARDS	16
4. TEST TYPES AND RESULTS (FOR BLUETOOTH EDR)	17
4.1 RADIATED EMISSION AND BANDEDGE MEASUREMENT	17
4.1.1 LIMITS OF RADIATED EMISSION AND BANDEDGE MEASUREMENT	17
4.1.2 TEST INSTRUMENTS.....	18
4.1.3 TEST PROCEDURES	19
4.1.4 DEVIATION FROM TEST STANDARD	19
4.1.5 TEST SETUP	20
4.1.6 EUT OPERATING CONDITIONS	21
4.1.7 TEST RESULTS.....	22
4.2 CONDUCTED EMISSION MEASUREMENT	26
4.2.1 LIMITS OF CONDUCTED EMISSION MEASUREMENT	26
4.2.2 TEST INSTRUMENTS.....	26
4.2.3 TEST PROCEDURES	27
4.2.4 DEVIATION FROM TEST STANDARD	27
4.2.5 TEST SETUP	28
4.2.6 EUT OPERATING CONDITIONS	28
4.2.7 TEST RESULTS.....	29
4.3 NUMBER OF HOPPING FREQUENCY USED	31
4.3.1 LIMIT OF HOPPING FREQUENCY USED	31
4.3.2 TEST SETUP	31
4.3.3 TEST INSTRUMENTS.....	31
4.3.4 TEST PROCEDURE	31
4.3.5 DEVIATION FROM TEST STANDARD	31
4.3.6 TEST RESULTS.....	31
4.4 DWELL TIME ON EACH CHANNEL	33
4.4.1 LIMITS OF DWELL TIME USED	33
4.4.2 TEST SETUP	33
4.4.3 TEST INSTRUMENTS.....	33
4.4.4 TEST PROCEDURES	33
4.4.5 DEVIATION FROM TEST STANDARD	33
4.4.6 TEST RESULTS.....	34
4.5 CHANNEL BANDWIDTH.....	37
4.5.1 LIMITS OF CHANNEL BANDWIDTH	37
4.5.2 TEST SETUP	37
4.5.3 TEST INSTRUMENTS.....	37
4.5.4 TEST PROCEDURE	37
4.5.5 DEVIATION FROM TEST STANDARD	37
4.5.6 EUT OPERATING CONDITION.....	37
4.5.7 TEST RESULTS.....	38
4.6 HOPPING CHANNEL SEPARATION	39
4.6.1 LIMITS OF HOPPING CHANNEL SEPARATION.....	39



- 4.6.2 TEST SETUP 39
- 4.6.3 TEST INSTRUMENTS 39
- 4.6.4 TEST PROCEDURE 39
- 4.6.5 DEVIATION FROM TEST STANDARD 39
- 4.6.6 TEST RESULTS..... 40
- 4.7 MAXIMUM OUTPUT POWER 41
 - 4.7.1 LIMITS OF MAXIMUM OUTPUT POWER MEASUREMENT 41
 - 4.7.2 TEST SETUP 41
 - 4.7.3 TEST INSTRUMENTS 41
 - 4.7.4 TEST PROCEDURE 41
 - 4.7.5 DEVIATION FROM TEST STANDARD 41
 - 4.7.6 EUT OPERATING CONDITION..... 41
 - 4.7.7 TEST RESULTS..... 42
- 4.8 CONDUCTED OUT OF BAND EMISSION MEASUREMENT 43
 - 4.8.1 LIMITS OF CONDUCTED OUT OF BAND EMISSION MEASUREMENT 43
 - 4.8.2 TEST INSTRUMENTS..... 43
 - 4.8.3 TEST PROCEDURE 43
 - 4.8.4 DEVIATION FROM TEST STANDARD 43
 - 4.8.5 EUT OPERATING CONDITION..... 43
 - 4.8.6 TEST RESULTS..... 43
- 5. TEST TYPES AND RESULTS (FOR BLUETOOTH LE 4.0)..... 47
 - 5.1 RADIATED EMISSION AND BANDEDGE MEASUREMENT 47
 - 5.1.1 LIMITS OF RADIATED EMISSION AND BANDEDGE MEASUREMENT 47
 - 5.1.2 TEST INSTRUMENTS..... 47
 - 5.1.3 TEST PROCEDURES 48
 - 5.1.4 DEVIATION FROM TEST STANDARD 48
 - 5.1.5 TEST SETUP 49
 - 5.1.6 EUT OPERATING CONDITIONS 49
 - 5.1.7 TEST RESULTS..... 50
 - 5.2 CONDUCTED EMISSION MEASUREMENT 54
 - 5.2.1 LIMITS OF CONDUCTED EMISSION MEASUREMENT 54
 - 5.2.2 TEST INSTRUMENTS..... 54
 - 5.2.3 TEST PROCEDURES 54
 - 5.2.4 DEVIATION FROM TEST STANDARD 54
 - 5.2.5 TEST SETUP 54
 - 5.2.6 EUT OPERATING CONDITIONS 54
 - 5.2.7 TEST RESULTS..... 55
 - 5.3 6dB BANDWIDTH MEASUREMENT 57
 - 5.3.1 LIMITS OF 6dB BANDWIDTH MEASUREMENT 57
 - 5.3.2 TEST SETUP 57
 - 5.3.3 TEST INSTRUMENTS..... 57
 - 5.3.4 TEST PROCEDURE 57
 - 5.3.5 DEVIATION FROM TEST STANDARD 57
 - 5.3.6 EUT OPERATING CONDITIONS 57
 - 5.3.7 TEST RESULTS..... 58
 - 5.4 CONDUCTED OUTPUT POWER 59
 - 5.4.1 LIMITS OF MAXIMUM OUTPUT POWER MEASUREMENT 59
 - 5.4.2 TEST SETUP 59
 - 5.4.3 INSTRUMENTS 59
 - 5.4.4 TEST PROCEDURES 59
 - 5.4.5 DEVIATION FROM TEST STANDARD 59
 - 5.4.6 EUT OPERATING CONDITIONS 59
 - 5.4.7 TEST RESULTS..... 59
 - 5.5 POWER SPECTRAL DENSITY MEASUREMENT..... 60
 - 5.5.1 LIMITS OF POWER SPECTRAL DENSITY MEASUREMENT 60



A D T

5.5.2	TEST SETUP	60
5.5.3	TEST INSTRUMENTS	60
5.5.4	TEST PROCEDURE	60
5.5.5	DEVIATION FROM TEST STANDARD	60
5.5.6	EUT OPERATING CONDITION.....	60
5.5.7	TEST RESULTS.....	61
5.6	CONDUCTED OUT OF BAND EMISSION MEASUREMENT	62
5.6.1	LIMITS OF OUT OF BAND EMISSION MEASUREMENT	62
5.6.2	TEST SETUP	62
5.6.3	TEST INSTRUMENTS	62
5.6.4	TEST PROCEDURE	62
5.6.5	DEVIATION FROM TEST STANDARD	63
5.6.6	EUT OPERATING CONDITION.....	63
5.6.7	TEST RESULTS.....	63
6.	PHOTOGRAPHS OF THE TEST CONFIGURATION.....	65
7.	INFORMATION ON THE TESTING LABORATORIES	66
8.	APPENDIX A - MODIFICATIONS RECORDERS FOR ENGINEERING CHANGES TO THE EUT BY THE LAB	67



A D T

RELEASE CONTROL RECORD

ISSUE NO.	REASON FOR CHANGE	DATE ISSUED
RF131119C06-4	Original release	Dec. 18, 2013



1. CERTIFICATION

PRODUCT: Kyocera phone
MODEL NO.: C6725
BRAND: Kyocera
APPLICANT: Kyocera Communications, Inc. c/o Kyocera Corporation
TESTED: Nov. 22, 2013 ~ Dec. 05, 2013
TEST SAMPLE: Identical Prototype
STANDARDS: **FCC Part 15, Subpart C (Section 15.247)**
ANSI C63.10-2009

The above equipment (model: C6725) has been tested by **Bureau Veritas Consumer Products Services (H.K.) Ltd., Taoyuan Branch**, and found compliance with the requirement of the above standards. The test record, data evaluation & Equipment Under Test (EUT) configurations represented herein are true and accurate accounts of the measurements of the sample's EMC characteristics under the conditions specified in this report.

PREPARED BY : Gina Liu , **DATE :** Dec. 18, 2013
Gina Liu / Specialist

APPROVED BY : Sam chen , **DATE :** Dec. 18, 2013
Sam Chen / Assistant Manager



2. SUMMARY OF TEST RESULTS

The EUT has been tested according to the following specifications:

APPLIED STANDARD: FCC Part 15, Subpart C (Bluetooth EDR)			
STANDARD SECTION	TEST TYPE AND LIMIT	RESULT	REMARK
15.207	AC Power Conducted Emission	PASS	Meet the requirement of limit. Minimum passing margin is -6.77dB at 13.55859MHz.
15.247(a)(1) (iii)	Number of Hopping Frequency Used	PASS	Meet the requirement of limit.
15.247(a)(1) (iii)	Dwell Time on Each Channel	PASS	Meet the requirement of limit.
15.247(a)(1)	1. Hopping Channel Separation 2. Spectrum Bandwidth of a Frequency Hopping Sequence Spread Spectrum System	PASS	Meet the requirement of limit.
15.247(b)	Maximum Peak Output Power	PASS	Meet the requirement of limit.
15.247(d)	Transmitter Radiated Emissions	PASS	Meet the requirement of limit. Minimum passing margin is -13.94dB at 2494MHz.
15.247(d)	Band Edge Measurement	PASS	Meet the requirement of limit.
15.203	Antenna Requirement	PASS	No antenna connector is used.

NOTE: If The Frequency Hopping System operating in 2400-2483.5MHz band and the output power less than 125mW. The hopping channel carrier frequencies separated by a minimum of 25kHz or two-thirds of the 20dB bandwidth of hopping channel whichever is greater.

APPLIED STANDARD: FCC PART 15, SUBPART C (SECTION 15.247) (Bluetooth LE 4.0)			
STANDARD SECTION	TEST TYPE AND LIMIT	RESULT	REMARK
15.207	AC Power Conducted Emission	PASS	Meet the requirement of limit. Minimum passing margin is -8.78dB at 13.56250MHz.
15.247(d) 15.209	Radiated Emissions	PASS	Meet the requirement of limit. Minimum passing margin is -12.00dB at 2484MHz.
15.247(d)	Band Edge Measurement	PASS	Meet the requirement of limit.
15.247(a)(2)	6dB bandwidth	PASS	Meet the requirement of limit.
15.247(b)	Conducted power	PASS	Meet the requirement of limit.
15.247(e)	Power Spectral Density	PASS	Meet the requirement of limit.
15.203	Antenna Requirement	PASS	No antenna connector is used.



A D T

2.1 MEASUREMENT UNCERTAINTY

Where relevant, the following measurement uncertainty levels have been estimated for tests performed on the EUT as specified in CISPR 16-4-2:

MEASUREMENT	FREQUENCY	UNCERTAINTY
Conducted emissions	9kHz~30MHz	2.44 dB
Radiated emissions	30MHz ~ 200MHz	2.93 dB
	200MHz ~1000MHz	2.95 dB
	1GHz ~ 18GHz	2.26 dB
	18GHz ~ 40GHz	1.94 dB

This uncertainty represents an expanded uncertainty expressed at approximately the 95% confidence level using a coverage factor of $k = 2$.



3. GENERAL INFORMATION

3.1 GENERAL DESCRIPTION OF EUT

EUT	Kyocera phone	
MODEL NO.	C6725	
POWER SUPPLY	5.0Vdc (adapter or host equipment) 3.8Vdc (Li-ion battery)	
MODULATION TYPE	Bluetooth EDR	GFSK, $\pi/4$ -DQPSK, 8DPSK
	Bluetooth LE 4.0	GFSK
TRANSFER RATE	Bluetooth EDR	1/2/3Mbps
	Bluetooth LE 4.0	1Mbps
OPERATING FREQUENCY	2402 ~ 2480MHz	
NUMBER OF CHANNEL	Bluetooth EDR	79
	Bluetooth LE 4.0	40
CHANNEL SPACING	Bluetooth EDR	1MHz
	Bluetooth LE 4.0	2MHz
OUTPUT POWER	Bluetooth EDR	1.578mW
	Bluetooth LE 4.0	1.452mW
ANTENNA TYPE	monopole antenna with -1dBi gain	
ANTENNA CONNECTOR	NA	
DATA CABLE	Refer to Note as below	
I/O PORTS	Refer to user's manual	
ACCESSORY DEVICES	Refer to Note as below	

NOTE:

1. The EUT contains following accessory devices.

ITEM	BRAND	MODEL	SPECIFICATION
AC Adapter	Kyocera	SCP-42ADT	I/P: 100-240Vac, 50/60Hz, 200mA O/P: 5Vdc, 1000mA
Battery	Kyocera	SCP-59LBPS	3.8Vdc, 2000mAh
Earphone	GALIEN	HF-HB04D	--
USB Cable	Kyocera	SCP-11SDC	1.2m non-shielded cable w/o core

2. The above EUT information is declared by the manufacturer and for more detailed features description, please refer to the manufacturer's specifications or User's Manual.

3.2 DESCRIPTION OF TEST MODES

FOR Bluetooth EDR:

79 channels are provided to this EUT:

CHANNEL	FREQ. (MHz)	CHANNEL	FREQ. (MHz)	CHANNEL	FREQ. (MHz)	CHANNEL	FREQ. (MHz)
0	2402	20	2422	40	2442	60	2462
1	2403	21	2423	41	2443	61	2463
2	2404	22	2424	42	2444	62	2464
3	2405	23	2425	43	2445	63	2465
4	2406	24	2426	44	2446	64	2466
5	2407	25	2427	45	2447	65	2467
6	2408	26	2428	46	2448	66	2468
7	2409	27	2429	47	2449	67	2469
8	2410	28	2430	48	2450	68	2470
9	2411	29	2431	49	2451	69	2471
10	2412	30	2432	50	2452	70	2472
11	2413	31	2433	51	2453	71	2473
12	2414	32	2434	52	2454	72	2474
13	2415	33	2435	53	2455	73	2475
14	2416	34	2436	54	2456	74	2476
15	2417	35	2437	55	2457	75	2477
16	2418	36	2438	56	2458	76	2478
17	2419	37	2439	57	2459	77	2479
18	2420	38	2440	58	2460	78	2480
19	2421	39	2441	59	2461		

FOR Bluetooth LE 4.0:

40 channels are provided to this EUT:

CHANNEL	FREQ. (MHz)	CHANNEL	FREQ. (MHz)	CHANNEL	FREQ. (MHz)	CHANNEL	FREQ. (MHz)
0	2402	10	2422	20	2442	30	2462
1	2404	11	2424	21	2444	31	2464
2	2406	12	2426	22	2446	32	2466
3	2408	13	2428	23	2448	33	2468
4	2410	14	2430	24	2450	34	2470
5	2412	15	2432	25	2452	35	2472
6	2414	16	2434	26	2454	36	2474
7	2416	17	2436	27	2456	37	2476
8	2418	18	2438	28	2458	38	2478
9	2420	19	2440	29	2460	39	2480

3.2.1 TEST MODE APPLICABILITY AND TESTED CHANNEL DETAIL

FOR Bluetooth EDR:

EUT CONFIGURE MODE	APPLICABLE TO				DESCRIPTION
	RE≥1G	RE<1G	PLC	APCM	
-	√	√	√	√	-

Where **RE≥1G**: Radiated Emission above 1GHz **RE<1G**: Radiated Emission below 1GHz
PLC: Power Line Conducted Emission **APCM**: Antenna Port Conducted Measurement

NOTE: 1. For Radiated emission test, pre-tested GFSK, π/4-DQPSK, 8DPSK modulation type and found GFSK was the worse, therefore chosen for the final test and presented in the test report.

2. The EUT had been pre-tested on the positioned of each 3 axis. The worst case was found when positioned on **Z-plane**.

RADIATED EMISSION TEST (ABOVE 1GHz):

- Pre-Scan has been conducted to determine the worst-case mode from all possible combinations between available modulations, data rates and antenna ports (if EUT with antenna diversity architecture).
- Following channel(s) was (were) selected for the final test as listed below.

AVAILABLE CHANNEL	TESTED CHANNEL	MODULATION TYPE	PACKET TYPE
0 to 78	0, 39, 78	GFSK	DH5

RADIATED EMISSION TEST (BELOW 1GHz):

- Pre-Scan has been conducted to determine the worst-case mode from all possible combinations between available modulations, data rates and antenna ports (if EUT with antenna diversity architecture).
- Following channel(s) was (were) selected for the final test as listed below.

AVAILABLE CHANNEL	TESTED CHANNEL	MODULATION TYPE	PACKET TYPE
0 to 78	39	GFSK	DH5

POWER LINE CONDUCTED EMISSION TEST:

- Pre-Scan has been conducted to determine the worst-case mode from all possible combinations between available modulations, data rates and antenna ports (if EUT with antenna diversity architecture).
- Following channel(s) was (were) selected for the final test as listed below.

AVAILABLE CHANNEL	TESTED CHANNEL	MODULATION TYPE	PACKET TYPE
0 to 78	39	GFSK	DH5



A D T

ANTENNA PORT CONDUCTED MEASUREMENT:

- This item includes all test value of each mode, but only includes spectrum plot of worst value of each mode.
- Pre-Scan has been conducted to determine the worst-case mode from all possible combinations between available modulations, data rates and antenna ports (if EUT with antenna diversity architecture).
- Following channel(s) was (were) selected for the final test as listed below.

AVAILABLE CHANNEL	TESTED CHANNEL	MODULATION TYPE	PACKET TYPE
0 to 78	0, 39, 78	GFSK	DH5
0 to 78	0, 39, 78	$\pi/4$ -DQPSK	DH5
0 to 78	0, 39, 78	8DPSK	DH5

TEST CONDITION:

APPLICABLE TO	ENVIRONMENTAL CONDITIONS	INPUT POWER	TESTED BY
RE \geq 1G	25deg. C, 65%RH	120Vac, 60Hz	Kay Wu
RE $<$ 1G	25deg. C, 65%RH	120Vac, 60Hz	Kay Wu
PLC	25deg. C, 65%RH	120Vac, 60Hz	Johnson Liao
APCM	25deg. C, 65%RH	120Vac, 60Hz	Howard Kao



A D T

FOR Bluetooth LE 4.0:

EUT CONFIGURE MODE	APPLICABLE TO				DESCRIPTION
	RE≥1G	RE<1G	PLC	APCM	
-	√	√	√	√	-

Where **RE≥1G:** Radiated Emission above 1GHz **RE<1G:** Radiated Emission below 1GHz
PLC: Power Line Conducted Emission **APCM:** Antenna Port Conducted Measurement

NOTE: The EUT had been pre-tested on the positioned of each 3 axis. The worst case was found when positioned on X-plane.

RADIATED EMISSION TEST (ABOVE 1GHz):

- Pre-Scan has been conducted to determine the worst-case mode from all possible combinations between available modulations, data rates and antenna ports (if EUT with antenna diversity architecture).
- Following channel(s) was (were) selected for the final test as listed below.

AVAILABLE CHANNEL	TESTED CHANNEL	MODULATION TYPE	DATA RATE (Mbps)
0 to 39	0, 19, 39	GFSK	1.0

RADIATED EMISSION TEST (BELOW 1GHz):

- Pre-Scan has been conducted to determine the worst-case mode from all possible combinations between available modulations, data rates and antenna ports (if EUT with antenna diversity architecture).
- Following channel(s) was (were) selected for the final test as listed below.

AVAILABLE CHANNEL	TESTED CHANNEL	MODULATION TYPE	DATA RATE (Mbps)
0 to 39	19	GFSK	1.0

POWER LINE CONDUCTED EMISSION TEST:

- Pre-Scan has been conducted to determine the worst-case mode from all possible combinations between available modulations, data rates and antenna ports (if EUT with antenna diversity architecture).
- Following channel(s) was (were) selected for the final test as listed below.

AVAILABLE CHANNEL	TESTED CHANNEL	MODULATION TYPE	DATA RATE (Mbps)
0 to 39	19	GFSK	1.0



A D T

ANTENNA PORT CONDUCTED MEASUREMENT:

- Pre-Scan has been conducted to determine the worst-case mode from all possible combinations between available modulations, data rates and antenna ports (if EUT with antenna diversity architecture).
- Following channel(s) was (were) selected for the final test as listed below.

AVAILABLE CHANNEL	TESTED CHANNEL	MODULATION TYPE	DATA RATE (Mbps)
0 to 39	0, 19, 39	GFSK	1.0

TEST CONDITION:

APPLICABLE TO	ENVIRONMENTAL CONDITIONS	INPUT POWER	TESTED BY
RE \geq 1G	25deg. C, 65%RH	120Vac, 60Hz	Kay Wu
RE $<$ 1G	25deg. C, 65%RH	120Vac, 60Hz	Kay Wu
PLC	25deg. C, 65%RH	120Vac, 60Hz	Johnson Liao
APCM	25deg. C, 65%RH	120Vac, 60Hz	Howard Kao

3.3 DESCRIPTION OF SUPPORT UNITS

The EUT has been tested as an independent unit together with other necessary accessories or support units. The following support units or accessories were used to form a representative test configuration during the tests.

NO.	PRODUCT	BRAND	MODEL NO.	SERIAL NO.	FCC ID
1	BLUETOOTH TESTER	R&S	CBT	100870	N/A

NO.	SIGNAL CABLE DESCRIPTION OF THE ABOVE SUPPORT UNITS
	N/A

NOTE: 1. All power cords of the above support units are non shielded (1.8m).
 2. Item 1 as a communication partner to transfer data.

3.3.1 CONFIGURATION OF SYSTEM UNDER TEST

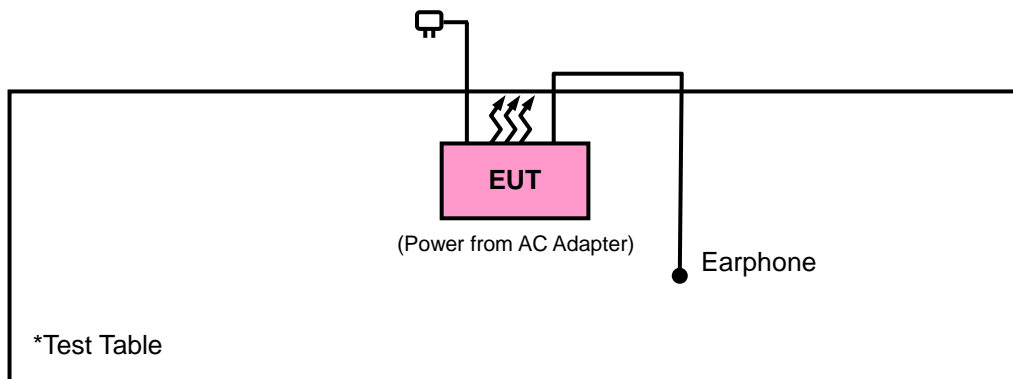



A D T

3.4 GENERAL DESCRIPTION OF APPLIED STANDARDS

The EUT is a RF Product. According to the specifications of the manufacturer, it must comply with the requirements of the following standards:

FCC Part 15, Subpart C (15.247)

ANSI C63.10-2009

558074 D01 DTS Meas Guidance v03r01

FCC Public Notice DA 00-705

All test items have been performed and recorded as per the above standards.

4. TEST TYPES AND RESULTS (FOR BLUETOOTH EDR)

4.1 RADIATED EMISSION AND BANDEDGE MEASUREMENT

4.1.1 LIMITS OF RADIATED EMISSION AND BANDEDGE MEASUREMENT

Radiated emissions which fall in the restricted bands must comply with the radiated emission limits specified as below table. Other emissions shall be at least 20dB below the highest level of the desired power:

FREQUENCIES (MHz)	FIELD STRENGTH (microvolts/meter)	MEASUREMENT DISTANCE (meters)
0.009 ~ 0.490	2400/F(kHz)	300
0.490 ~ 1.705	24000/F(kHz)	30
1.705 ~ 30.0	30	30
30 ~ 88	100	3
88 ~ 216	150	3
216 ~ 960	200	3
Above 960	500	3

NOTE:

1. The lower limit shall apply at the transition frequencies.
2. Emission level (dBuV/m) = 20 log Emission level (uV/m).
3. For frequencies above 1000MHz, the field strength limits are based on average detector, however, the peak field strength of any emission shall not exceed the maximum permitted average limits, specified above by more than 20dB under any condition of modulation.



4.1.2 TEST INSTRUMENTS

DESCRIPTION & MANUFACTURER	MODEL NO.	SERIAL NO.	DATE OF CALIBRATION	DUE DATE OF CALIBRATION
Test Receiver ROHDE & SCHWARZ	ESCI	100744	Apr. 15, 2013	Apr. 14, 2014
Spectrum Analyzer ROHDE & SCHWARZ	FSU43	101261	Dec. 17, 2012	Dec. 16, 2013
BILOG Antenna SCHWARZBECK	VULB9168	9168-472	Mar. 25, 2013	Mar. 24, 2014
HORN Antenna SCHWARZBECK	BBHA 9120 D	9120D-969	Jan. 07, 2013	Jan. 06, 2014
HORN Antenna SCHWARZBECK	BBHA 9170	9170-480	Dec. 25, 2012	Dec. 24, 2013
Loop Antenna	HFH2-Z2	100070	Jan. 31, 2013	Jan. 30, 2014
Preamplifier EMCI	EMC 012645	980115	Dec. 28, 2012	Dec. 27, 2013
Preamplifier EMCI	EMC 184045	980116	Dec. 28, 2012	Dec. 27, 2013
Preamplifier EMCI	EMC 330H	980112	Dec. 28, 2012	Dec. 27, 2013
RF signal cable HUBER+SUHNNER	SUCOFLEX 104	309219/4	Oct. 18, 2013	Oct. 17, 2014
RF signal cable HUBER+SUHNNER	SUCOFLEX 104	250130/4	Oct. 18, 2013	Oct. 17, 2014
RF signal cable Worken	RG-213	NA	Dec. 29, 2012	Dec. 28, 2013
Software BV ADT	E3 6.120103	NA	NA	NA
Antenna Tower MF	MFA-440H	NA	NA	NA
Turn Table MF	MFT-201SS	NA	NA	NA
Antenna Tower & Turn Table Controller MF	MF-7802	NA	NA	NA
Bluetooth Tester	CBT	100980	Apr. 18, 2013	Apr. 17, 2014
Power Meter	ML2495A	1232002	Aug. 23, 2013	Aug. 22, 2014
Power Sensor	MA2411B	1207325	Aug. 23, 2013	Aug. 22, 2014

- NOTE:**
1. The calibration interval of the above test instruments is 12 months and the calibrations are traceable to NML/ROC and NIST/USA.
 2. The calibration interval of the loop antenna is 24 months and the calibrations are traceable to NML/ROC and NIST/USA.
 3. The test was performed in HwaYa Chamber 10.
 4. The horn antenna and HP preamplifier (model: 8449B) are used only for the measurement of emission frequency above 1GHz if tested.
 5. The FCC Site Registration No. is 690701.
 6. The IC Site Registration No. is IC 7450F-10.

4.1.3 TEST PROCEDURES

- a. The EUT was placed on the top of a rotating table 0.8 meters above the ground at a 3 meters semi-anechoic chamber. The table was rotated 360 degrees to determine the position of the highest radiation.
- b. The EUT was set 3 meters away from the interference-receiving antenna, which was mounted on the top of a variable-height antenna tower.
- c. The antenna is a broadband antenna, and its height is varied from one meter to four meters above the ground to determine the maximum value of the field strength. Both horizontal and vertical polarizations of the antenna are set to make the measurement.
- d. For each suspected emission, the EUT was arranged to its worst case and then the antenna was tuned to heights from 1 meter to 4 meters and the rotatable table was turned from 0 degrees to 360 degrees to find the maximum reading.
- e. The test-receiver system was set to Peak Detect Function and Specified Bandwidth with Maximum Hold Mode.
- f. If the emission level of the EUT in peak mode was lower than the limit specified, then testing could be stopped and the peak values of the EUT would be reported. Otherwise the emissions would be re-tested one by one using peak, quasi-peak or average method as specified and then reported in a data sheet.

NOTE:

1. The resolution bandwidth and video bandwidth of test receiver/spectrum analyzer is 120kHz for Quasi-peak detection at frequency below 1GHz.
2. The resolution bandwidth of test receiver/spectrum analyzer is 1MHz and video bandwidth is 3MHz for Peak detection at frequency above 1GHz.
3. The resolution bandwidth of test receiver/spectrum analyzer is 1MHz and the video bandwidth is 10Hz for Average detection (AV) at frequency above 1GHz.
4. All modes of operation were investigated and worst-case emissions are reported.

4.1.4 DEVIATION FROM TEST STANDARD

No deviation.

4.1.5 TEST SETUP

Frequency Range 30MHz ~ 1GHz

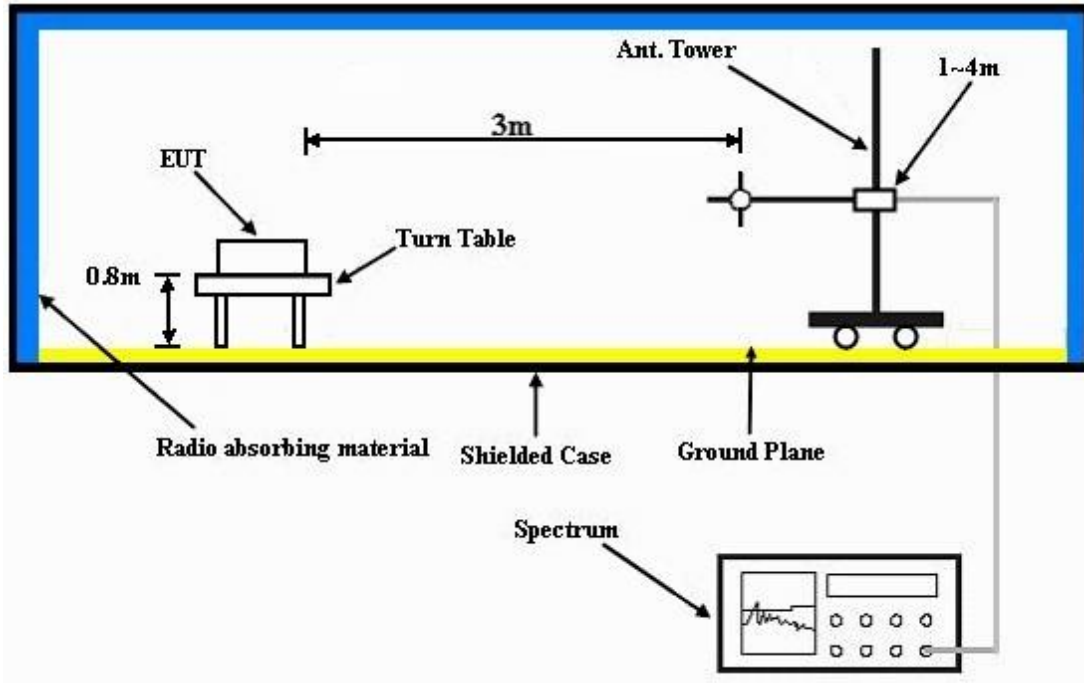

Frequency Range above 1GHz

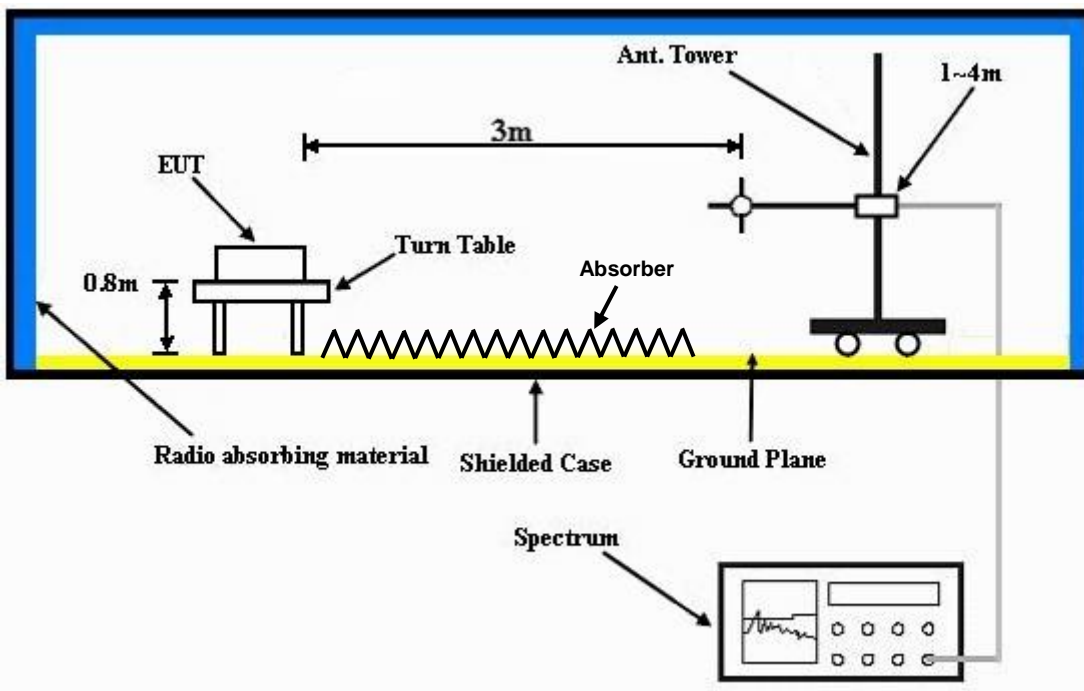

For the actual test configuration, please refer to the attached file (Test Setup Photo).



A D T

4.1.6 EUT OPERATING CONDITIONS

- a. Placed the EUT on a testing table.
- b. Use the software to control the EUT under transmission condition continuously at specific channel frequency.



4.1.7 TEST RESULTS

ABOVE 1GHz WORST-CASE DATA

GFSK

EUT TEST CONDITION		MEASUREMENT DETAIL	
CHANNEL	Channel 0	FREQUENCY RANGE	1GHz ~ 25GHz
INPUT POWER (SYSTEM)	120Vac, 60 Hz	DETECTOR FUNCTION	Peak (PK) Average (AV)
ENVIRONMENTAL CONDITIONS	25deg. C, 65%RH	TESTED BY	Kay Wu

ANTENNA POLARITY & TEST DISTANCE: HORIZONTAL AT 3 M										
FREQ. (MHz)	EMISSION LEVEL (dBuV/m)	READ LEVEL (dBuV)	LIMIT (dBuV/m)	MARGIN (dB)	ANTENNA FACTOR (dB/m)	CABLE LOSS (dB)	PREAMP FACTOR (dB)	ANTENNA HEIGHT (cm)	TABLE ANGLE (Degree)	REMARK
2386	39.49	37.65	54	-14.51	31.93	5.4	35.49	126	236	Average
2386	51.39	49.55	74	-22.61	31.93	5.4	35.49	126	236	Peak
2402	90.15	88.26			31.96	5.4	35.47	126	236	Average
2402	95.7	93.81			31.96	5.4	35.47	126	236	Peak
2494	40.04	37.82	54	-13.96	32.1	5.53	35.41	126	236	Average
2494	51.29	49.07	74	-22.71	32.1	5.53	35.41	126	236	Peak
ANTENNA POLARITY & TEST DISTANCE: VERTICAL AT 3 M										
FREQ. (MHz)	EMISSION LEVEL (dBuV/m)	READ LEVEL (dBuV)	LIMIT (dBuV/m)	MARGIN (dB)	ANTENNA FACTOR (dB/m)	CABLE LOSS (dB)	PREAMP FACTOR (dB)	ANTENNA HEIGHT (cm)	TABLE ANGLE (Degree)	REMARK
2314	39.29	37.7	54	-14.71	31.81	5.3	35.52	120	148	Average
2314	51.33	49.74	74	-22.67	31.81	5.3	35.52	120	148	Peak
2402	82.59	80.7			31.96	5.4	35.47	120	148	Average
2402	88.13	86.24			31.96	5.4	35.47	120	148	Peak
2494	40.03	37.81	54	-13.97	32.1	5.53	35.41	120	148	Average
2494	51.56	49.34	74	-22.44	32.1	5.53	35.41	120	148	Peak

REMARKS:

- Emission Level = Read Level + Antenna Factor + Cable Loss - Preamp Factor
Margin value = Emission level – Limit value
- 2402MHz: Fundamental frequency.



A D T

EUT TEST CONDITION		MEASUREMENT DETAIL	
CHANNEL	Channel 39	FREQUENCY RANGE	1GHz ~ 25GHz
INPUT POWER (SYSTEM)	120Vac, 60 Hz	DETECTOR FUNCTION	Peak (PK) Average (AV)
ENVIRONMENTAL CONDITIONS	25deg. C, 65%RH	TESTED BY	Kay Wu

ANTENNA POLARITY & TEST DISTANCE: HORIZONTAL AT 3 M										
FREQ. (MHz)	EMISSION LEVEL (dBuV/m)	READ LEVEL (dBuV)	LIMIT (dBuV/m)	MARGIN (dB)	ANTENNA FACTOR (dB/m)	CABLE LOSS (dB)	PREAMP FACTOR (dB)	ANTENNA HEIGHT (cm)	TABLE ANGLE (Degree)	REMARK
2390	39.47	37.61	54	-14.53	31.93	5.4	35.47	150	192	Average
2390	51.67	49.81	74	-22.33	31.93	5.4	35.47	150	192	Peak
2441	93.61	91.58			32.01	5.46	35.44	150	192	Average
2441	99.21	97.18			32.01	5.46	35.44	150	192	Peak
2500	40.05	37.83	54	-13.95	32.1	5.53	35.41	150	192	Average
2500	52.08	49.86	74	-21.92	32.1	5.53	35.41	150	192	Peak

ANTENNA POLARITY & TEST DISTANCE: VERTICAL AT 3 M										
FREQ. (MHz)	EMISSION LEVEL (dBuV/m)	READ LEVEL (dBuV)	LIMIT (dBuV/m)	MARGIN (dB)	ANTENNA FACTOR (dB/m)	CABLE LOSS (dB)	PREAMP FACTOR (dB)	ANTENNA HEIGHT (cm)	TABLE ANGLE (Degree)	REMARK
2388	39.47	37.63	54	-14.53	31.93	5.4	35.49	132	90	Average
2388	51.55	49.71	74	-22.45	31.93	5.4	35.49	132	90	Peak
2441	88.06	86.03			32.01	5.46	35.44	132	90	Average
2441	93.69	91.66			32.01	5.46	35.44	132	90	Peak
2484	40.03	37.85	54	-13.97	32.1	5.5	35.42	132	90	Average
2484	51.76	49.58	74	-22.24	32.1	5.5	35.42	132	90	Peak

REMARKS:

- Emission Level = Read Level + Antenna Factor + Cable Loss - Preamp Factor
Margin value = Emission level – Limit value
- 2441MHz: Fundamental frequency.



A D T

EUT TEST CONDITION		MEASUREMENT DETAIL	
CHANNEL	Channel 78	FREQUENCY RANGE	1GHz ~ 25GHz
INPUT POWER (SYSTEM)	120Vac, 60 Hz	DETECTOR FUNCTION	Peak (PK) Average (AV)
ENVIRONMENTAL CONDITIONS	25deg. C, 65%RH	TESTED BY	Kay Wu

ANTENNA POLARITY & TEST DISTANCE: HORIZONTAL AT 3 M										
FREQ. (MHz)	EMISSION LEVEL (dBuV/m)	READ LEVEL (dBuV)	LIMIT (dBuV/m)	MARGIN (dB)	ANTENNA FACTOR (dB/m)	CABLE LOSS (dB)	PREAMP FACTOR (dB)	ANTENNA HEIGHT (cm)	TABLE ANGLE (Degree)	REMARK
2380	39.42	37.64	54	-14.58	31.9	5.37	35.49	180	240	Average
2380	51.61	49.83	74	-22.39	31.9	5.37	35.49	180	240	Peak
2480	89.15	87			32.07	5.5	35.42	180	240	Average
2480	94.9	92.75			32.07	5.5	35.42	180	240	Peak
2494	40.06	37.84	54	-13.94	32.1	5.53	35.41	180	240	Average
2494	51.66	49.44	74	-22.34	32.1	5.53	35.41	180	240	Peak

ANTENNA POLARITY & TEST DISTANCE: VERTICAL AT 3 M										
FREQ. (MHz)	EMISSION LEVEL (dBuV/m)	READ LEVEL (dBuV)	LIMIT (dBuV/m)	MARGIN (dB)	ANTENNA FACTOR (dB/m)	CABLE LOSS (dB)	PREAMP FACTOR (dB)	ANTENNA HEIGHT (cm)	TABLE ANGLE (Degree)	REMARK
2332	39.34	37.69	54	-14.66	31.84	5.33	35.52	131	316	Average
2332	51.45	49.8	74	-22.55	31.84	5.33	35.52	131	316	Peak
2480	83.43	81.28			32.07	5.5	35.42	131	316	Average
2480	89.2	87.05			32.07	5.5	35.42	131	316	Peak
2484	39.99	37.81	54	-14.01	32.1	5.5	35.42	131	316	Average
2484	51.94	49.76	74	-22.06	32.1	5.5	35.42	131	316	Peak

REMARKS:

- Emission Level = Read Level + Antenna Factor + Cable Loss - Preamp Factor
Margin value = Emission level – Limit value
- 2480MHz: Fundamental frequency.



A D T

BELOW 1GHz WORST-CASE DATA:

GFSK

EUT TEST CONDITION		MEASUREMENT DETAIL	
CHANNEL	Channel 39	FREQUENCY RANGE	30MHz ~ 1GHz
INPUT POWER (SYSTEM)	120Vac, 60 Hz	DETECTOR FUNCTION	Peak (PK) Quasi-peak (QP)
ENVIRONMENTAL CONDITIONS	25deg. C, 65%RH	TESTED BY	Kay Wu

ANTENNA POLARITY & TEST DISTANCE: HORIZONTAL AT 3 M										
FREQ. (MHz)	EMISSION LEVEL (dBuV/m)	READ LEVEL (dBuV)	LIMIT (dBuV/m)	MARGIN (dB)	ANTENNA FACTOR (dB/m)	CABLE LOSS (dB)	PREAMP FACTOR (dB)	ANTENNA HEIGHT (cm)	TABLE ANGLE (Degree)	REMARK
91.56	19.73	41.37	43.5	-23.77	9.02	1.11	31.77	102	154	Peak
146.37	16.76	37.8	43.5	-26.74	9.85	1.38	32.27	155	178	Peak
189.57	16.05	36.29	43.5	-27.45	10.4	1.61	32.25	123	157	Peak
439.3	27.85	39.63	46	-18.15	17.89	2.49	32.16	103	277	Peak
696.2	28.76	34.6	46	-17.24	23.14	3.11	32.09	174	157	Peak
732.6	35.58	41.22	46	-10.42	23.33	3.16	32.13	115	215	Peak
ANTENNA POLARITY & TEST DISTANCE: VERTICAL AT 3 M										
FREQ. (MHz)	EMISSION LEVEL (dBuV/m)	READ LEVEL (dBuV)	LIMIT (dBuV/m)	MARGIN (dB)	ANTENNA FACTOR (dB/m)	CABLE LOSS (dB)	PREAMP FACTOR (dB)	ANTENNA HEIGHT (cm)	TABLE ANGLE (Degree)	REMARK
30.27	28.92	42.9	40	-11.08	17.55	0.74	32.27	156	214	Peak
48.36	19.93	42.94	40	-20.07	8.31	0.9	32.22	155	285	Peak
91.02	19.05	40.73	43.5	-24.45	8.98	1.11	31.77	145	147	Peak
428.8	25.31	37.33	46	-20.69	17.75	2.41	32.18	155	215	Peak
538.7	21.04	29.98	46	-24.96	20.48	2.76	32.18	174	258	Peak
732.6	31.85	37.49	46	-14.15	23.33	3.16	32.13	152	235	Peak

REMARKS: Emission Level = Read Level + Antenna Factor + Cable Loss - Preamp Factor
 Margin value = Emission level – Limit value

4.2 CONDUCTED EMISSION MEASUREMENT

4.2.1 LIMITS OF CONDUCTED EMISSION MEASUREMENT

FREQUENCY OF EMISSION (MHz)	CONDUCTED LIMIT (dB μ V)	
	Quasi-peak	Average
0.15 ~ 0.5	66 to 56	56 to 46
0.5 ~ 5	56	46
5 ~ 30	60	50

- NOTE:** 1. The lower limit shall apply at the transition frequencies.
2. The limit decreases in line with the logarithm of the frequency in the range of 0.15 to 0.50MHz.
3. All emanations from a class A/B digital device or system, including any network of conductors and apparatus connected thereto, shall not exceed the level of field strengths specified above.

4.2.2 TEST INSTRUMENTS

DESCRIPTION & MANUFACTURER	MODEL NO.	SERIAL NO.	DATE OF CALIBRATION	DUE DATE OF CALIBRATION
Test Receiver ROHDE & SCHWARZ	ESCS30	100288	Nov. 17, 2013	Nov. 16, 2014
RF signal cable Woken	5D-FB	Cable-HYCO2-01	Dec. 28, 2012	Dec. 27, 2013
LISN ROHDE & SCHWARZ (EUT)	ESH2-Z5	100100	Dec. 21, 2012	Dec. 20, 2013
LISN ROHDE & SCHWARZ (Peripheral)	ESH3-Z5	100311	Jul. 17, 2013	Jul. 16, 2014
Software ADT	BV ADT_Cond_ V7.3.7.3	NA	NA	NA

- NOTE:** 1. The calibration interval of the above test instruments is 12 months and the calibrations are traceable to NML/ROC and NIST/USA.
2. The test was performed in HwaYa Shielded Room 2.
3. The VCCI Site Registration No. is C-2047.



A D T

4.2.3 TEST PROCEDURES

- a. The EUT was placed 0.4 meters from the conducting wall of the shielded room with EUT being connected to the power mains through a line impedance stabilization network (LISN). Other support units were connected to the power mains through another LISN. The two LISNs provide 50 ohm/ 50uH of coupling impedance for the measuring instrument.
- b. Both lines of the power mains connected to the EUT were checked for maximum conducted interference.
- c. The frequency range from 150kHz to 30MHz was searched. Emission levels under (Limit - 20dB) was not recorded.

NOTE: All modes of operation were investigated and the worst-case emissions are reported.

4.2.4 DEVIATION FROM TEST STANDARD

No deviation.

4.2.5 TEST SETUP

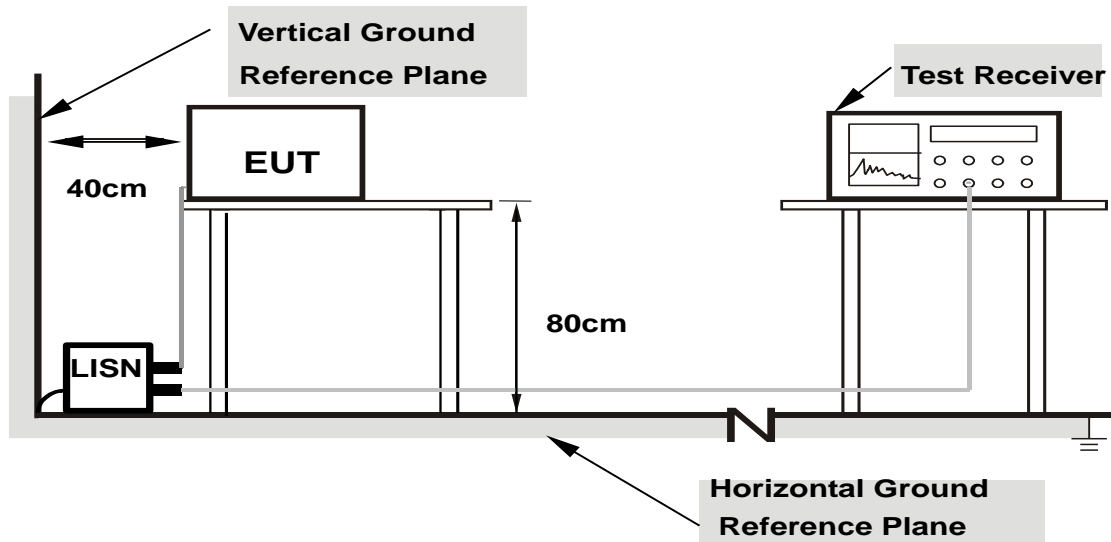

- Note:**
1. Support units were connected to second LISN.
 2. Both of LISNs (AMN) are 80 cm from EUT and at least 80 from other units and other metal planes

For the actual test configuration, please refer to the attached file (Test Setup Photo).

4.2.6 EUT OPERATING CONDITIONS

Same as 4.1.6.

4.2.7 TEST RESULTS

CONDUCTED WORST-CASE DATA :

PHASE	Line 1	6dB BANDWIDTH	9kHz
--------------	--------	----------------------	------

No	Freq.	Corr. Factor	Reading Value		Emission Level		Limit		Margin	
	[MHz]		[dB (uV)]		[dB (uV)]		[dB (uV)]		(dB)	
			Q.P.	AV.	Q.P.	AV.	Q.P.	AV.	Q.P.	AV.
1	0.29844	0.19	40.59	32.53	40.78	32.72	60.29	50.29	-19.51	-17.57
2	0.40000	0.21	44.04	36.23	44.25	36.44	57.85	47.85	-13.60	-11.41
3	0.95078	0.27	43.01	33.31	43.28	33.58	56.00	46.00	-12.72	-12.42
4	2.29297	0.29	41.35	30.37	41.64	30.66	56.00	46.00	-14.36	-15.34
5	6.62109	0.40	34.97	23.77	35.37	24.17	60.00	50.00	-24.63	-25.83
6	13.55859	0.50	46.83	41.05	47.33	41.55	60.00	50.00	-12.67	-8.45

REMARKS:

1. Q.P. and AV. are abbreviations of quasi-peak and average individually.
2. The emission levels of other frequencies were very low against the limit.
3. Margin value = Emission level - Limit value
4. Correction factor = Insertion loss + Cable loss
5. Emission Level = Correction Factor + Reading Value

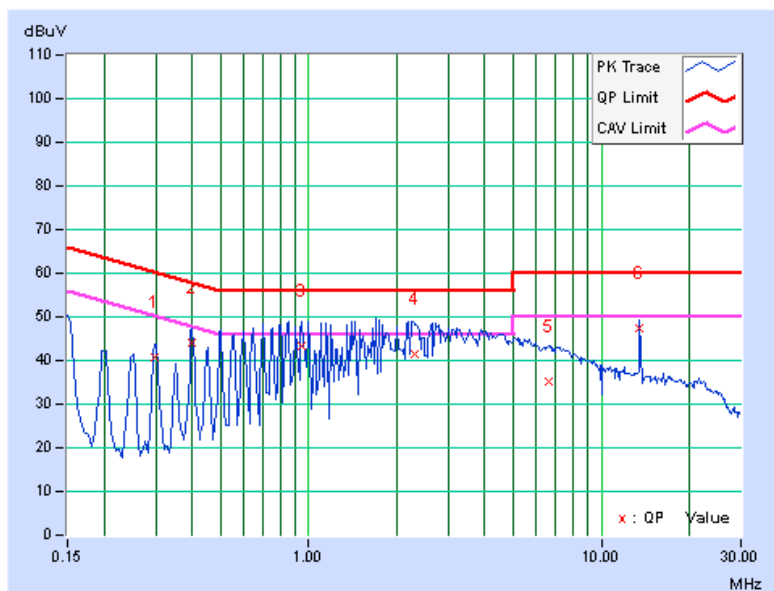

PHASE	Line 2	6dB BANDWIDTH	9kHz
-------	--------	---------------	------

No	Freq. [MHz]	Corr. Factor (dB)	Reading Value [dB (uV)]		Emission Level [dB (uV)]		Limit [dB (uV)]		Margin (dB)	
			Q.P.	AV.	Q.P.	AV.	Q.P.	AV.	Q.P.	AV.
			1	0.30234	0.22	41.34	36.03	41.56	36.25	60.18
2	0.40391	0.25	43.47	38.24	43.72	38.49	57.77	47.77	-14.05	-9.28
3	0.95469	0.23	42.00	35.58	42.23	35.81	56.00	46.00	-13.77	-10.19
4	2.67578	0.32	42.34	33.59	42.66	33.91	56.00	46.00	-13.34	-12.09
5	13.55859	0.57	47.33	42.66	47.90	43.23	60.00	50.00	-12.10	-6.77
6	24.44141	0.69	36.44	24.82	37.13	25.51	60.00	50.00	-22.87	-24.49

REMARKS:

1. Q.P. and AV. are abbreviations of quasi-peak and average individually.
2. The emission levels of other frequencies were very low against the limit.
3. Margin value = Emission level - Limit value
4. Correction factor = Insertion loss + Cable loss
5. Emission Level = Correction Factor + Reading Value

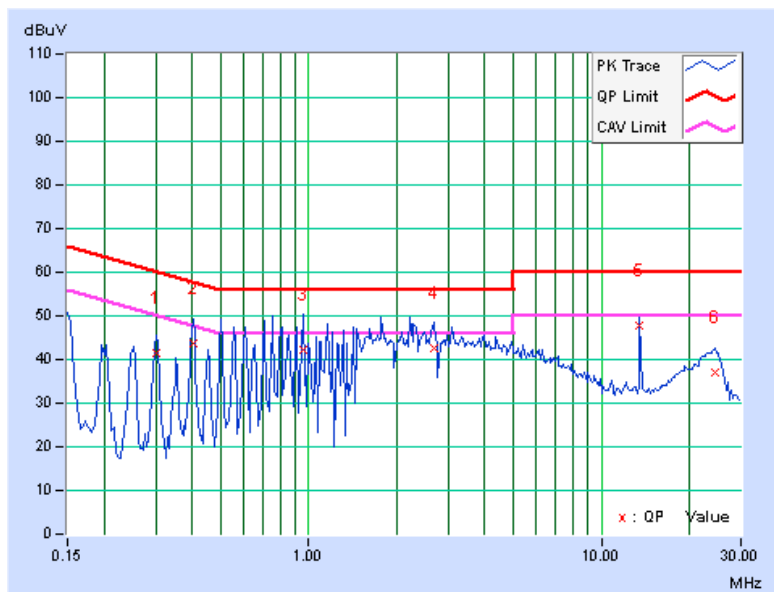

4.3 NUMBER OF HOPPING FREQUENCY USED

4.3.1 LIMIT OF HOPPING FREQUENCY USED

At least 15 channels frequencies, and should be equally spaced.

4.3.2 TEST SETUP

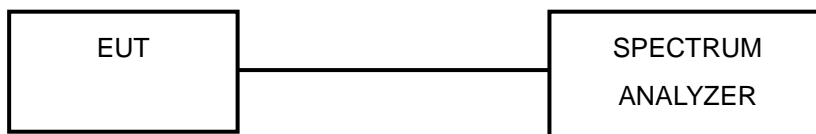

4.3.3 TEST INSTRUMENTS

Refer to section 4.1.2 to get information of above instrument.

4.3.4 TEST PROCEDURE

- a. Check the calibration of the measuring instrument (SA) using either an internal calibrator or a known signal from an external generator.
- b. Turn on the EUT and connect its antenna terminal to measurement via a low loss cable. Then set it to any one measured frequency within its operating range and make sure the instrument is operated in its linear range.
- c. Set the SA on MaxHold Mode, and then keep the EUT in hopping mode. Record all the signals from each channel until each one has been recorded.
- d. Set the SA on View mode and then plot the result on SA screen.
- e. Repeat above procedures until all frequencies measured were complete.

4.3.5 DEVIATION FROM TEST STANDARD

No deviation.

4.3.6 TEST RESULTS

There are 79 hopping frequencies in the hopping mode. Please refer to next page for the test result. On the plot, it shows that the hopping frequencies are equally spaced.



A D T

GFSK

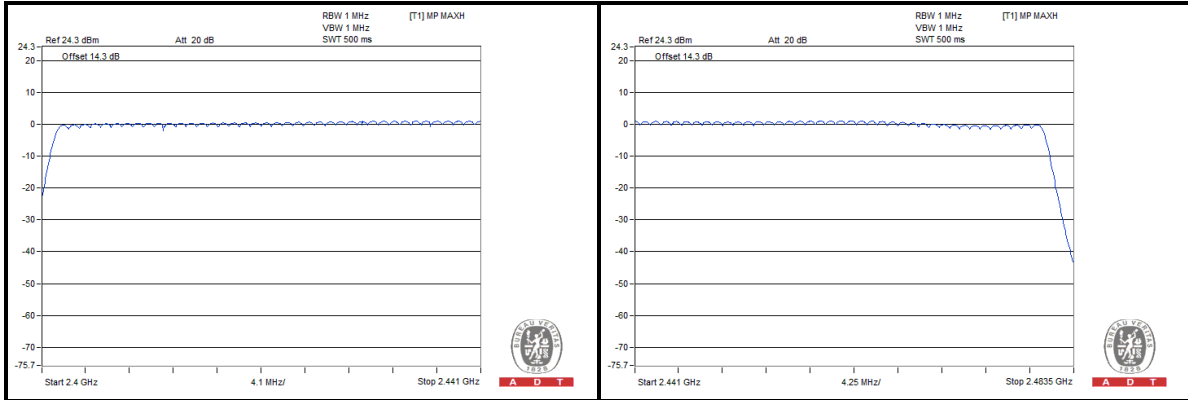

4.4 DWELL TIME ON EACH CHANNEL

4.4.1 LIMITS OF DWELL TIME USED

The average time of occupancy on any channel shall not be greater than 0.4 seconds within a period of 0.4 seconds multiplied by the number of hopping channels employed.

4.4.2 TEST SETUP

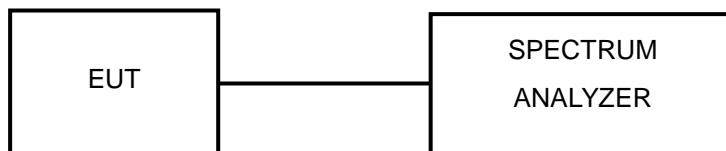

4.4.3 TEST INSTRUMENTS

Refer to section 4.1.2 to get information of above instrument.

4.4.4 TEST PROCEDURES

- a. Check the calibration of the measuring instrument (SA) using either an internal calibrator or a known signal from an external generator.
- b. Turn on the EUT and connect its antenna terminal to measurement via a low loss cable. Then set it to any one measured frequency within its operating range and make sure the instrument is operated in its linear range.
- c. Adjust the center frequency of SA on any frequency be measured and set SA to zero span mode. And then, set RBW and VBW of spectrum analyzer to proper value.
- d. Measure the time duration of one transmission on the measured frequency. And then plot the result with time difference of this time duration.
- e. Repeat above procedures until all different time-slot modes have been completed.

4.4.5 DEVIATION FROM TEST STANDARD

No deviation.



A D T

4.4.6 TEST RESULTS

GFSK

Mode	Average Hopping Channel	Package Transfer Time (usec)	Result (sec)	Limit (sec)
DH1	9.20	407.05	0.12	0.4
DH3	5.00	1674.68	0.26	0.4
DH5	2.90	2932.69	0.27	0.4

NOTE:

1. Dwell Time=79(channels) x 0.4(s) x average hopping channel x package transfer time
2. 79 channels come from the Hopping Channel number
3. Average Hopping Channel = hops/sweep time
4. t: Package Transfer Time(us)
5. Test plots of the transmitting time slot are shown as below.

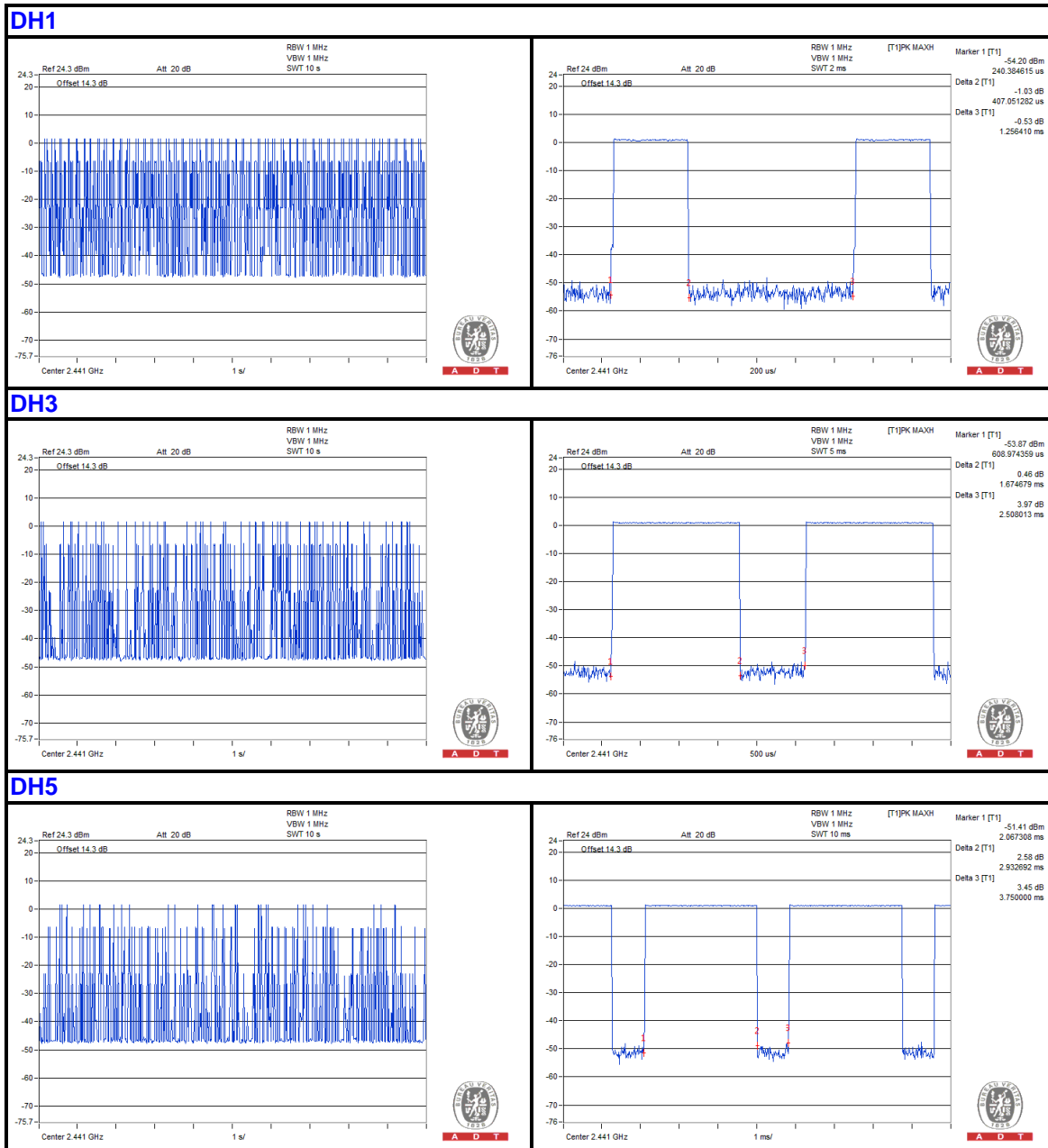



A D T

π/4-DQPSK

Mode	Average Hopping Channel	Package Transfer Time (usec)	Result (sec)	Limit (sec)
DH1	9.30	410.26	0.12	0.4
DH3	4.70	1668.26	0.25	0.4
DH5	3.20	2934.29	0.30	0.4

NOTE:

1. Dwell Time=79(channels) x 0.4(s) x average hopping channel x package transfer time
2. 79 channels come from the Hopping Channel number
3. Average Hopping Channel = hops/sweep time
4. t: Package Transfer Time(us)
5. Test plots of the transmitting time slot are shown as below.

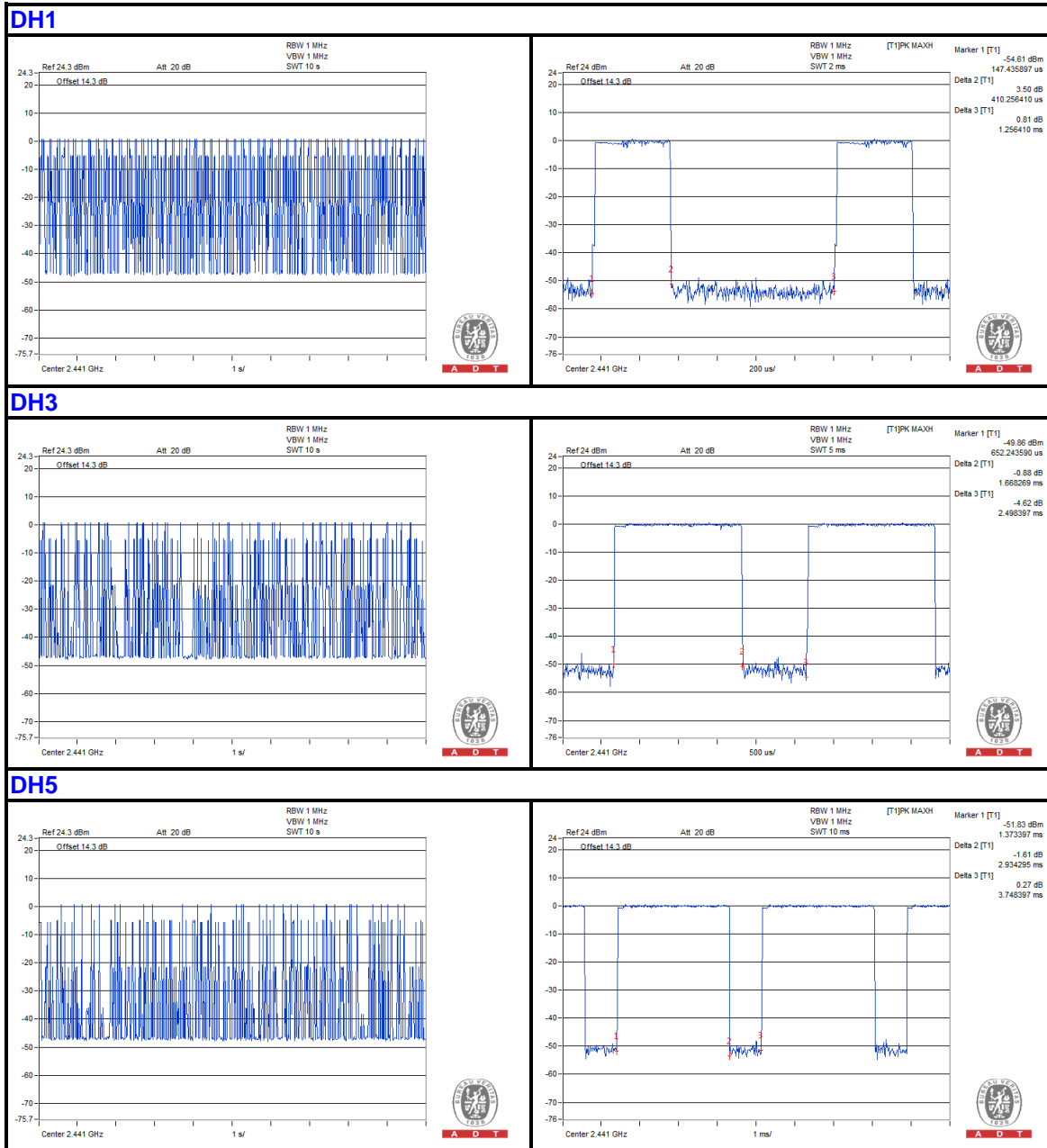



A D T

8DPSK

Mode	Average Hopping Channel	Package Transfer Time (usec)	Result (sec)	Limit (sec)
DH1	9.30	415.06	0.12	0.4
DH3	5.20	1673.08	0.27	0.4
DH5	3.00	2955.12	0.28	0.4

NOTE:

1. Dwell Time=79(channels) x 0.4(s) x average hopping channel x package transfer time
2. 79 channels come from the Hopping Channel number
3. Average Hopping Channel = hops/sweep time
4. t: Package Transfer Time(us)
5. Test plots of the transmitting time slot are shown as below.

DH1

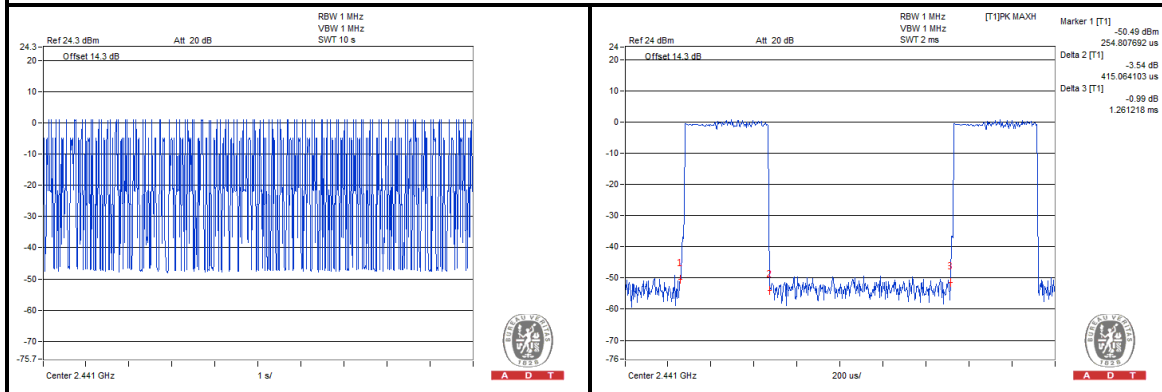

DH3

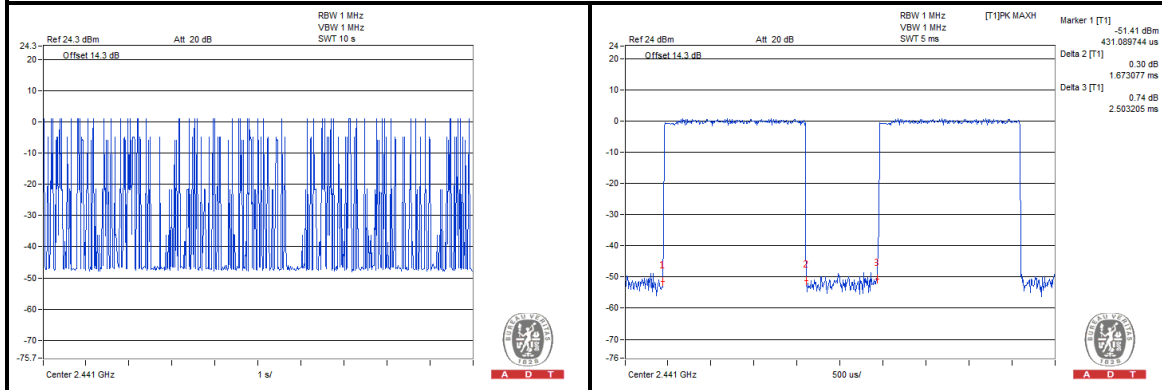

DH5

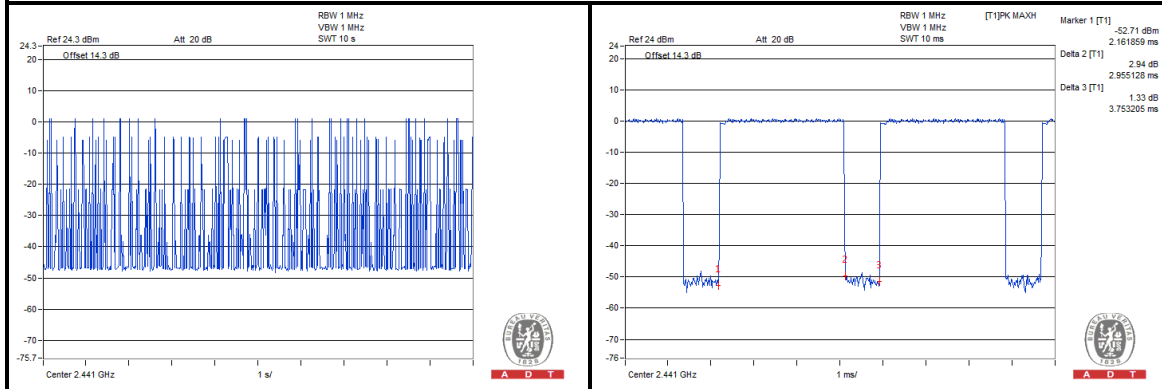

4.5 CHANNEL BANDWIDTH

4.5.1 LIMITS OF CHANNEL BANDWIDTH

For frequency hopping system operating in the 2400-2483.5MHz, If the 20dB bandwidth of hopping channel is greater than 25kHz, two-thirds 20dB bandwidth of hopping channel shall be a minimum limit for the hopping channel separation.

4.5.2 TEST SETUP

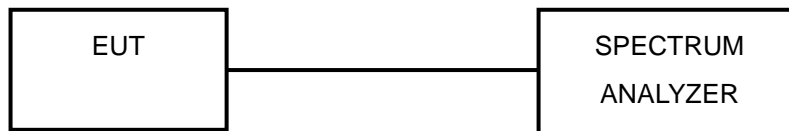

4.5.3 TEST INSTRUMENTS

Refer to section 4.1.2 to get information of above instrument.

4.5.4 TEST PROCEDURE

- a. Check the calibration of the measuring instrument using either an internal calibrator or a known signal from an external generator.
- b. Turn on the EUT and connect it to measurement instrument. Then set it to any one convenient frequency within its operating range. Set a reference level on the measuring instrument equal to the highest peak value.
- c. Measure the frequency difference of two frequencies that were attenuated 20dB from the reference level. Record the frequency difference as the emission bandwidth.
- d. Repeat above procedures until all frequencies measured were complete.

4.5.5 DEVIATION FROM TEST STANDARD

No deviation.

4.5.6 EUT OPERATING CONDITION

The software provided by client enabled the EUT to transmit and receive data at lowest, middle and highest channel frequencies individually.



A D T

4.5.7 TEST RESULTS

CHANNEL	FREQUENCY (MHz)	20dB BANDWIDTH (MHz)		
		GFSK	$\pi/4$ -DQPSK	8DPSK
0	2402	0.96	1.29	1.25
39	2441	1.02	1.30	1.24
78	2480	0.96	1.29	1.24

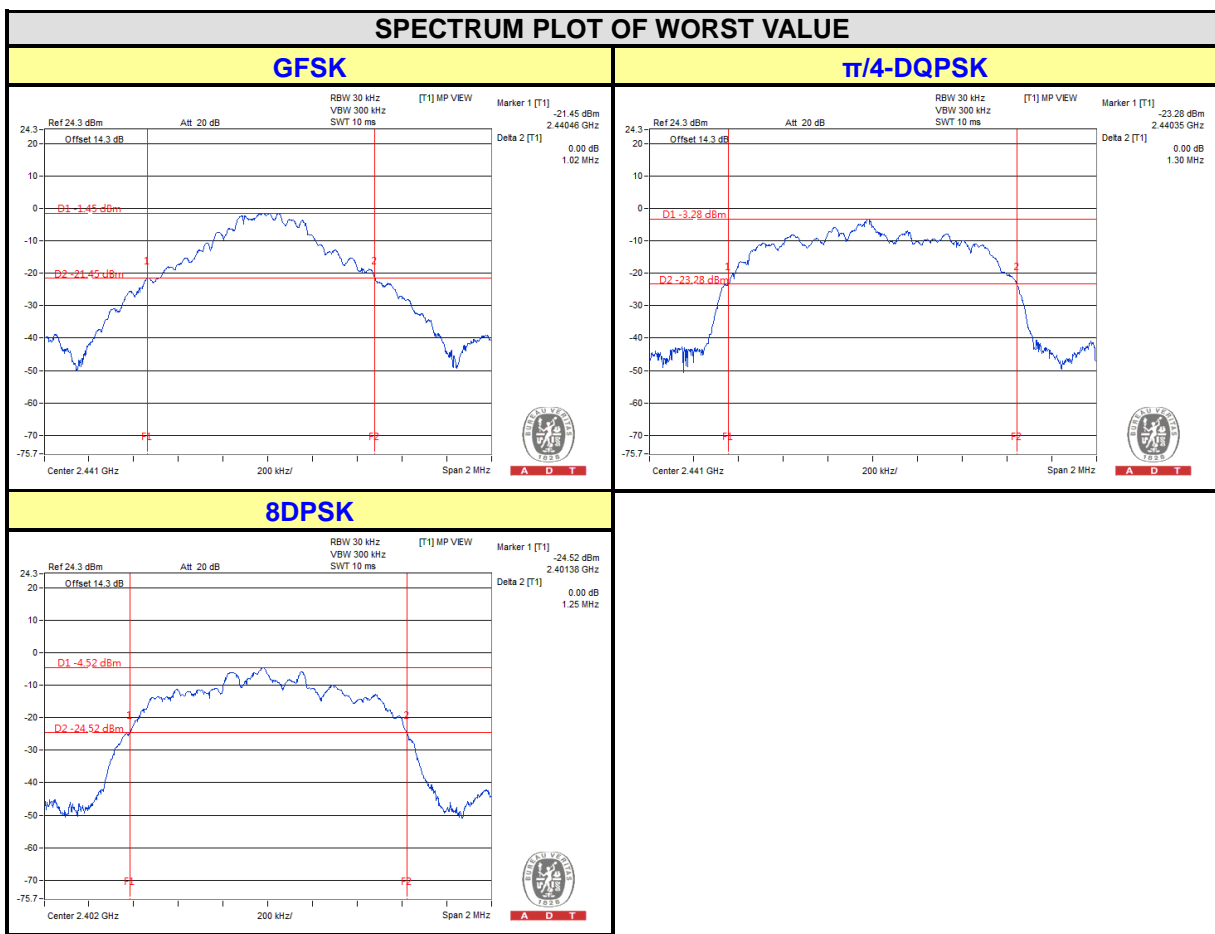

4.6 HOPPING CHANNEL SEPARATION

4.6.1 LIMITS OF HOPPING CHANNEL SEPARATION

At least 25kHz or two-third of 20dB hopping channel bandwidth (whichever is greater).

4.6.2 TEST SETUP

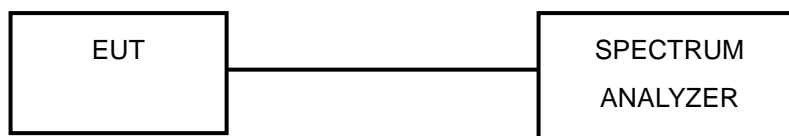

4.6.3 TEST INSTRUMENTS

Refer to section 4.1.2 to get information of above instrument.

4.6.4 TEST PROCEDURE

- a. Check the calibration of the measuring instrument using either an internal calibrator or a known signal from an external generator.
- b. Turn on the EUT and connect it to measurement instrument. Then set it to any one convenient frequency within its operating range.
- c. By using the MaxHold function record the separation of two adjacent channels.
- d. Measure the frequency difference of these two adjacent channels by SA MARK function. And then plot the result on SA screen.
- e. Repeat above procedures until all frequencies measured were complete.

4.6.5 DEVIATION FROM TEST STANDARD

No deviation.



A D T

4.6.6 TEST RESULTS

CHAN.	FREQ. (MHz)	ADJACENT CHANNEL SEPARATION (MHz)			20dB BANDWIDTH (MHz)			MINIMUM LIMIT (MHz)			PASS / FAIL
		GFSK	$\pi/4$ -DQPSK	8DPSK	GFSK	$\pi/4$ -DQPSK	8DPSK	GFSK	$\pi/4$ -DQPSK	8DPSK	
0	2402	1.01	1.00	1.01	0.96	1.29	1.25	0.639	0.860	0.833	PASS
39	2441	1.00	1.01	1.00	1.02	1.30	1.24	0.680	0.867	0.827	PASS
78	2480	1.00	1.01	1.01	0.96	1.29	1.24	0.639	0.860	0.827	PASS

NOTE:

- The minimum limit is two-third 20dB bandwidth.

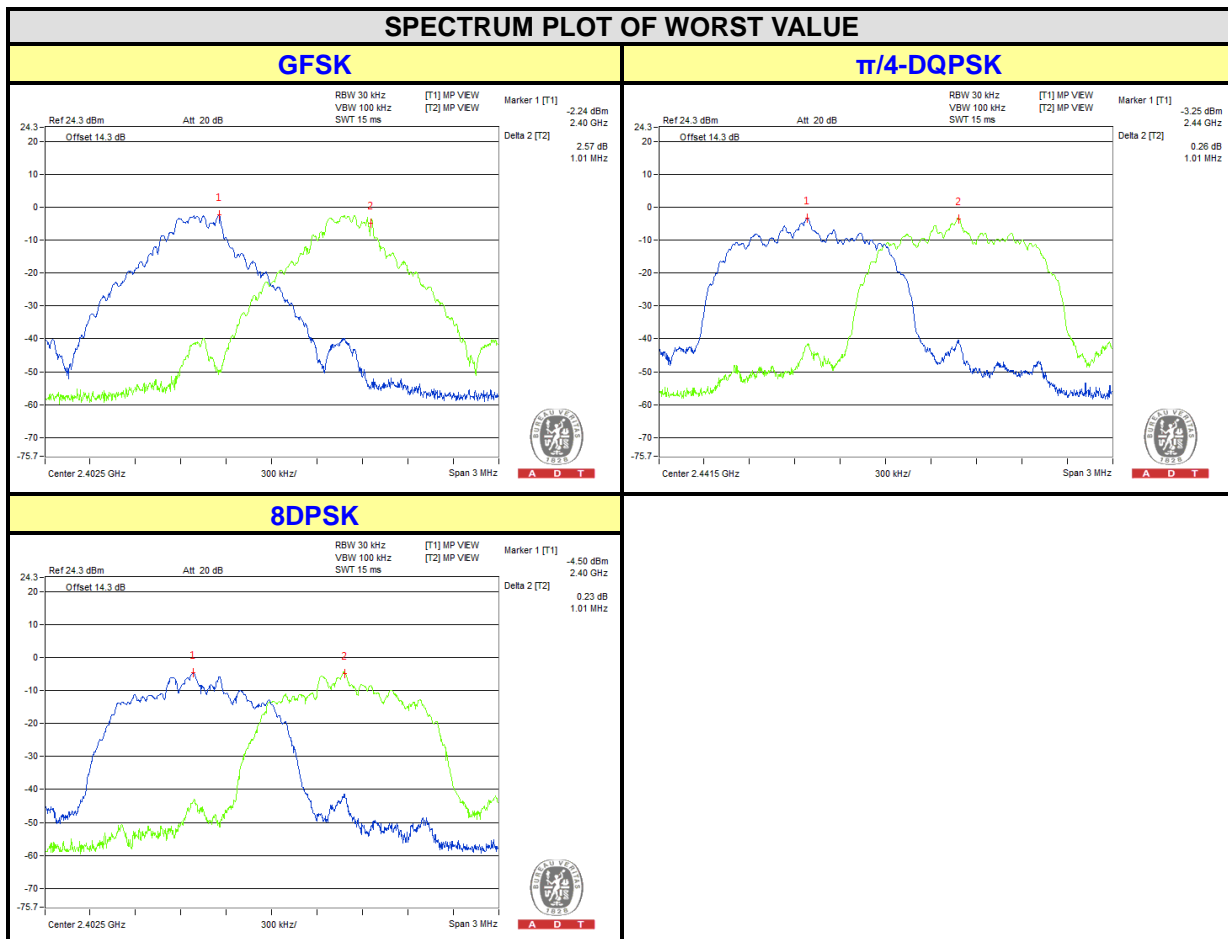

4.7 MAXIMUM OUTPUT POWER

4.7.1 LIMITS OF MAXIMUM OUTPUT POWER MEASUREMENT

The Maximum Output Power Measurement is 125mW.

4.7.2 TEST SETUP

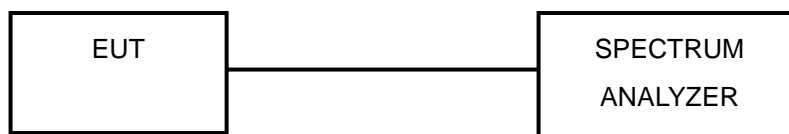

4.7.3 TEST INSTRUMENTS

Refer to section 4.1.2 to get information of above instrument.

4.7.4 TEST PROCEDURE

- a. Check the calibration of the measuring instrument using either an internal calibrator or a known signal from an external generator.
- b. Turn on the EUT and connect it to measurement instrument. Then set it to any one convenient frequency within its operating range. Set a reference level on the measuring instrument equal to the highest peak value.
- c. The center frequency of the spectrum analyzer is set to the fundamental frequency and using 3MHz RBW and 10 MHz VBW.
- d. Measure the captured power within the band and recording the plot.
- e. Repeat above procedures until all frequencies required were complete.

4.7.5 DEVIATION FROM TEST STANDARD

No deviation.

4.7.6 EUT OPERATING CONDITION

The software provided by client enabled the EUT to transmit and receive data at lowest, middle and highest channel frequencies individually.



A D T

4.7.7 TEST RESULTS

CHANNEL	FREQUENCY (MHz)	OUTPUT POWER (mW)			OUTPUT POWER (dBm)			POWER LIMIT (mW)	PASS / FAIL
		GFSK	$\pi/4$ -DQPSK	8DPSK	GFSK	$\pi/4$ -DQPSK	8DPSK		
0	2402	1.050	0.998	1.074	0.21	-0.01	0.31	125	PASS
39	2441	1.528	1.439	1.578	1.84	1.58	1.98	125	PASS
78	2480	1.119	1.057	1.140	0.49	0.24	0.57	125	PASS





A D T

4.8 CONDUCTED OUT OF BAND EMISSION MEASUREMENT

4.8.1 LIMITS OF CONDUCTED OUT OF BAND EMISSION MEASUREMENT

Below -20dB of the highest emission level of operating band (in 100kHz RBW).

4.8.2 TEST INSTRUMENTS

Refer to section 4.1.2 to get information of above instrument.

4.8.3 TEST PROCEDURE

1. Set RBW = 100 kHz .
2. Set VBW = 300 kHz .
3. Set span to encompass the spectrum to be examined.
4. Detector = peak.
5. Trace Mode = max hold.
6. Sweep = auto couple.

4.8.4 DEVIATION FROM TEST STANDARD

No deviation.

4.8.5 EUT OPERATING CONDITION

The software provided by client enabled the EUT to transmit continuously.

4.8.6 TEST RESULTS

The spectrum plots are attached on the following images. D1 line indicates the highest level, D2 line indicates the 20dB offset below D1. It shows compliance with the requirement.



A D T

GFSK

Hopping disabled_ Low Channel

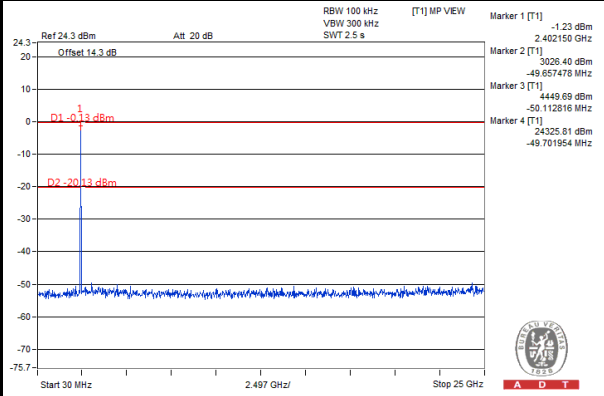
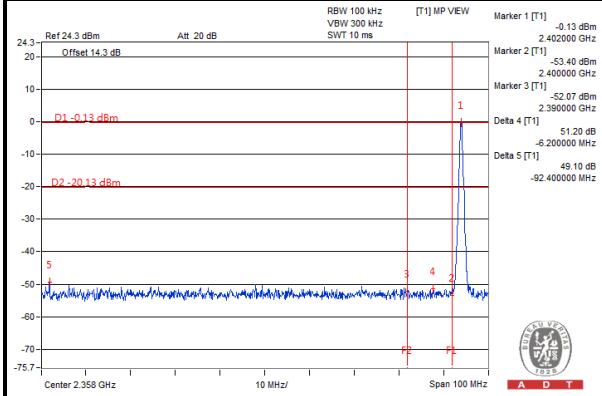

Hopping disabled_ High Channel

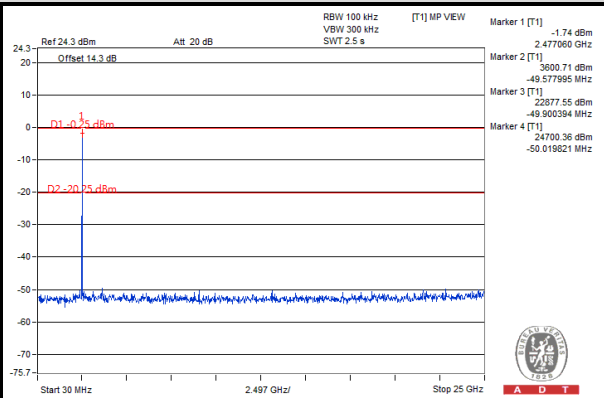
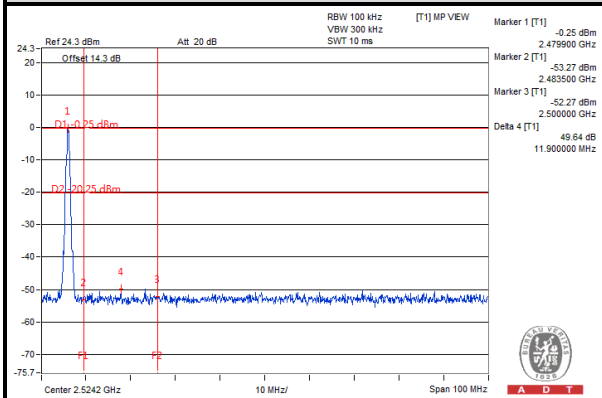

Hopping enabled_ Low Channel

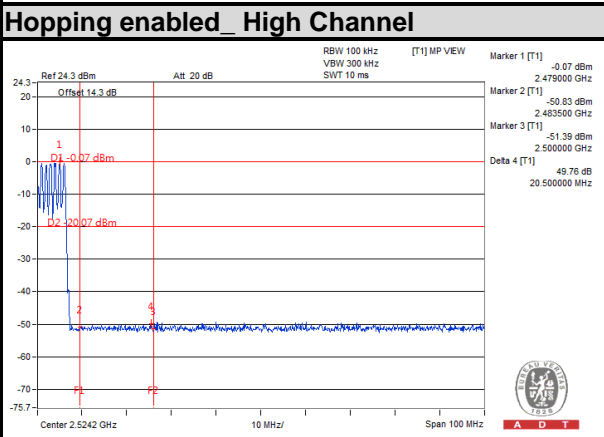
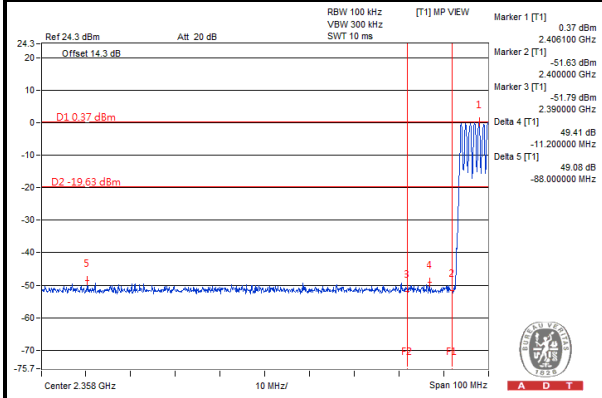



A D T

$\pi/4$ -DQPSK

Hopping disabled_ Low Channel

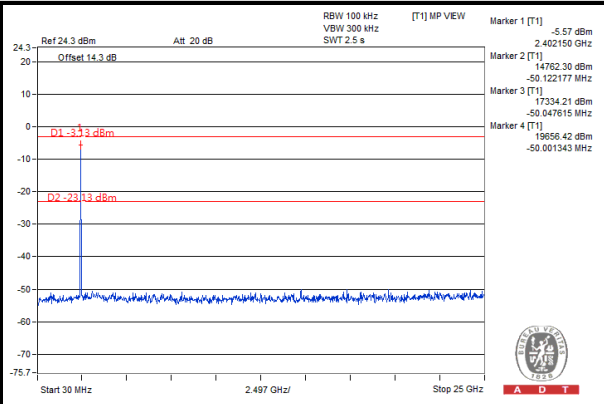
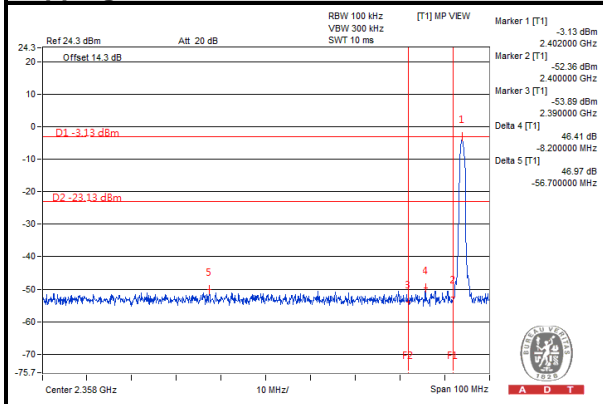

Hopping disabled_ High Channel

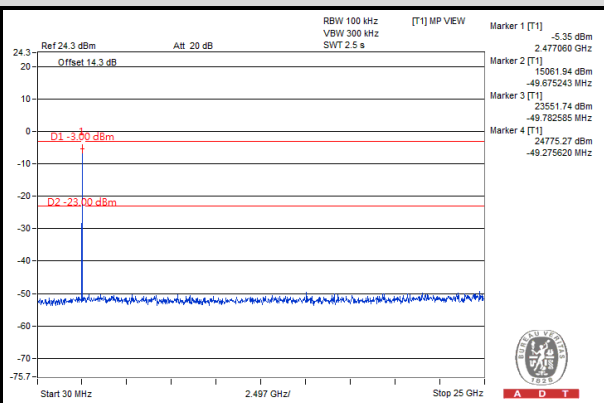
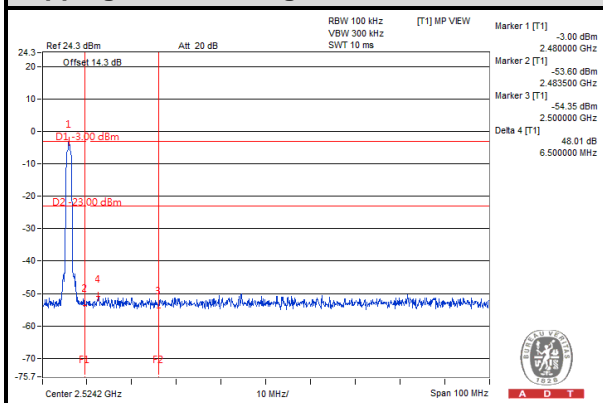

Hopping enabled_ Low Channel

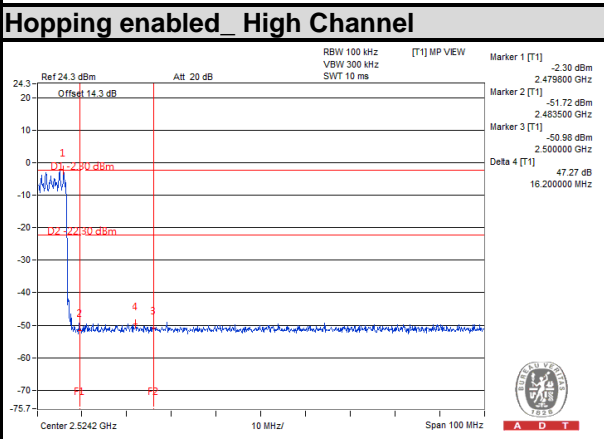
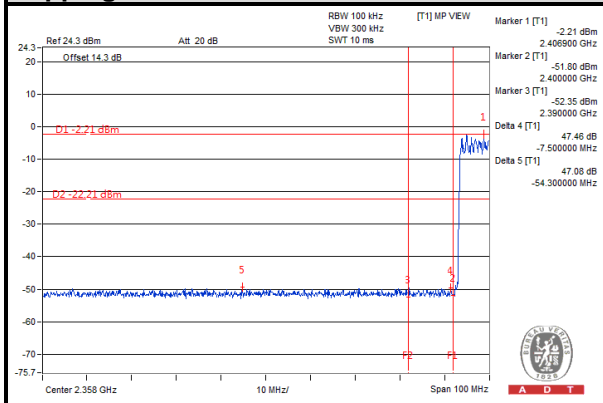



A D T

8DPSK

Hopping disabled_ Low Channel

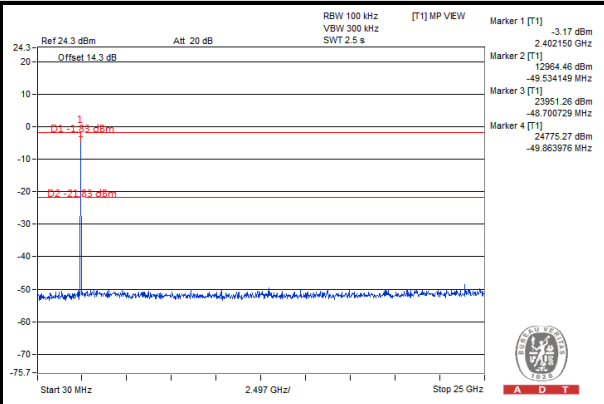
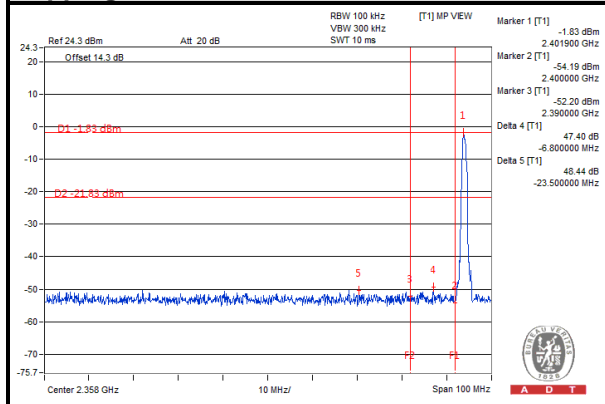

Hopping disabled_ High Channel

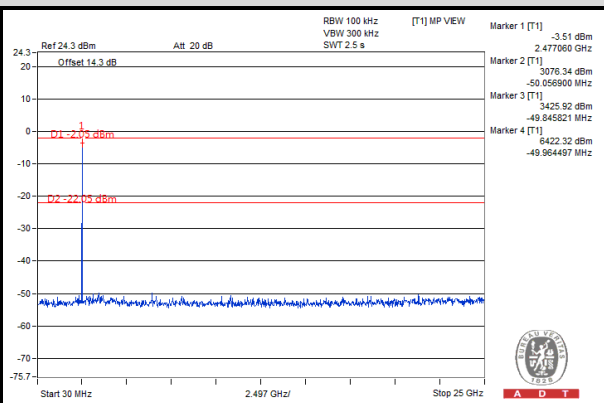
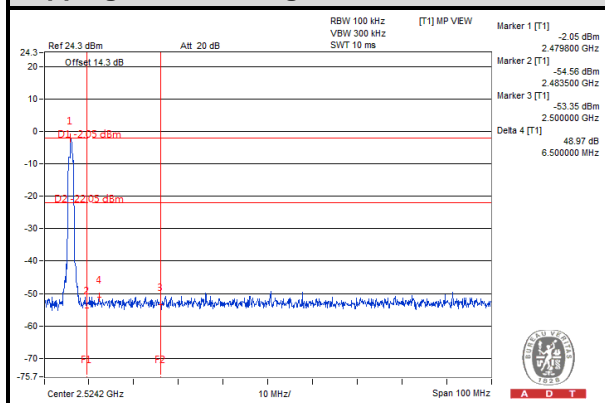

Hopping enabled_ Low Channel

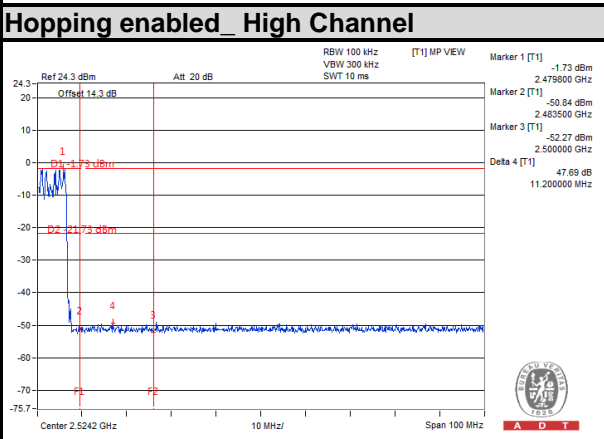
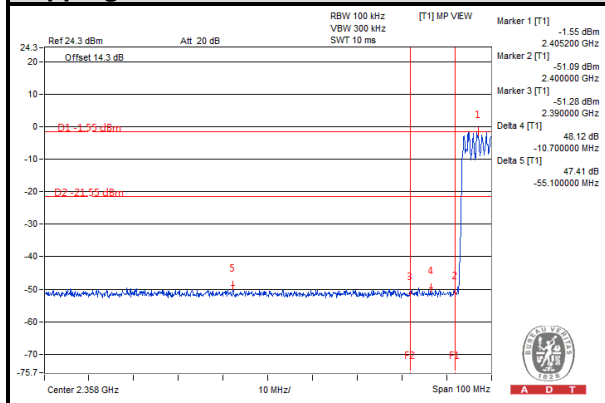

5. TEST TYPES AND RESULTS (FOR BLUETOOTH LE 4.0)

5.1 RADIATED EMISSION AND BANDEDGE MEASUREMENT

5.1.1 LIMITS OF RADIATED EMISSION AND BANDEDGE MEASUREMENT

Radiated emissions which fall in the restricted bands must comply with the radiated emission limits specified as below table. Other emissions shall be at least 20dB below the highest level of the desired power:

FREQUENCIES (MHz)	FIELD STRENGTH (microvolts/meter)	MEASUREMENT DISTANCE (meters)
0.009 ~ 0.490	2400/F(kHz)	300
0.490 ~ 1.705	24000/F(kHz)	30
1.705 ~ 30.0	30	30
30 ~ 88	100	3
88 ~ 216	150	3
216 ~ 960	200	3
Above 960	500	3

NOTE:

1. The lower limit shall apply at the transition frequencies.
2. Emission level (dBuV/m) = 20 log Emission level (uV/m).
3. For frequencies above 1000MHz, the field strength limits are based on average detector, however, the peak field strength of any emission shall not exceed the maximum permitted average limits, specified above by more than 20dB under any condition of modulation.

5.1.2 TEST INSTRUMENTS

Same as item 4.1.2.

5.1.3 TEST PROCEDURES

- a. The EUT was placed on the top of a rotating table 0.8 meters above the ground at a 3 meters semi-anechoic chamber. The table was rotated 360 degrees to determine the position of the highest radiation.
- b. The EUT was set 3 meters away from the interference-receiving antenna, which was mounted on the top of a variable-height antenna tower.
- c. Height of receiving antenna is varied from one meter to four meters above the ground to determine the maximum value of the field strength. Both horizontal and vertical polarizations of the antenna are set to make the measurement.
- d. For each suspected emission, the EUT was arranged to its worst case and then the antenna was tuned to heights from 1 meter to 4 meters and the rotatable table was turned from 0 degrees to 360 degrees to find the maximum reading.
- e. The test-receiver system was set to Peak Detect Function and Specified Bandwidth with Maximum Hold Mode.
- f. If the emission level of the EUT in peak mode was lower than the limit specified, then testing could be stopped and the peak values of the EUT would be reported. Otherwise the emissions would be re-tested one by one using peak, quasi-peak or average method as specified and then reported in a data sheet.

NOTE:

1. The resolution bandwidth and video bandwidth of test receiver/spectrum analyzer is 120kHz for Quasi-peak detection at frequency below 1GHz.
2. The resolution bandwidth of test receiver/spectrum analyzer is 1MHz and video bandwidth is 3MHz for Peak detection at frequency above 1GHz.
3. The resolution bandwidth of test receiver/spectrum analyzer is 1MHz and the video bandwidth is 10Hz for Average detection (AV) at frequency above 1GHz.
4. All modes of operation were investigated and the worst-case emissions are reported.

5.1.4 DEVIATION FROM TEST STANDARD

No deviation.

5.1.5 TEST SETUP

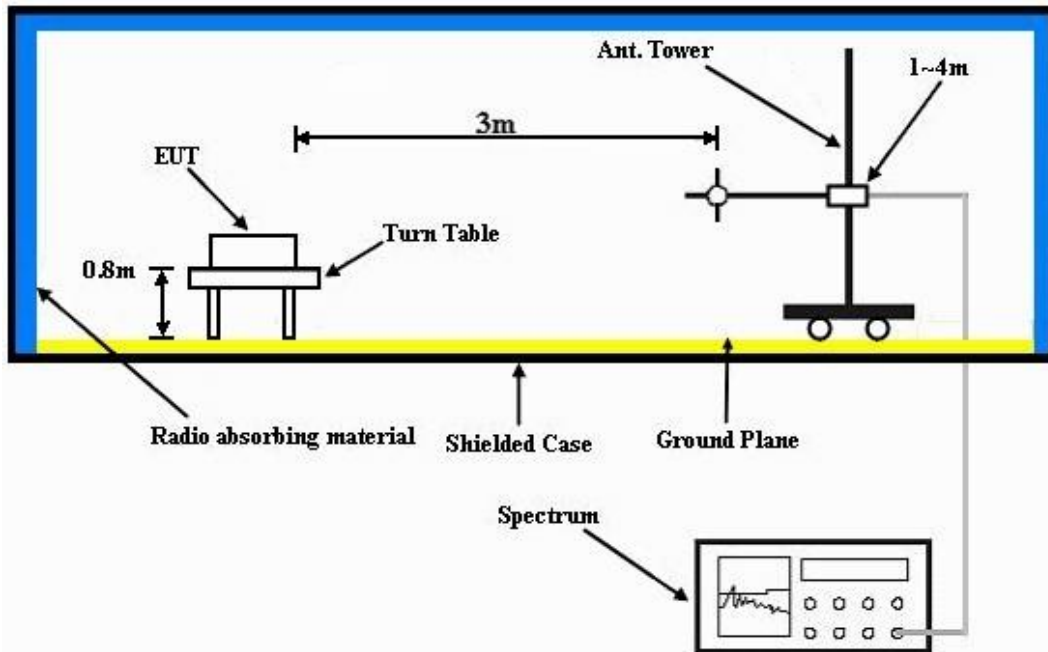

For the actual test configuration, please refer to the attached file (Test Setup Photo).

5.1.6 EUT OPERATING CONDITIONS

- a. Placed the EUT on a testing table.
- b. Use the software to control the EUT under transmission condition continuously at specific channel frequency.



A D T

5.1.7 TEST RESULTS

ABOVE 1GHz WORST-CASE DATA

EUT TEST CONDITION		MEASUREMENT DETAIL	
CHANNEL	Channel 0	FREQUENCY RANGE	1GHz ~ 25GHz
INPUT POWER (SYSTEM)	120Vac, 60 Hz	DETECTOR FUNCTION	Peak (PK) Average (AV)
ENVIRONMENTAL CONDITIONS	25deg. C, 65%RH	TESTED BY	Kay Wu

ANTENNA POLARITY & TEST DISTANCE: HORIZONTAL AT 3 M										
FREQ. (MHz)	EMISSION LEVEL (dBuV/m)	READ LEVEL (dBuV)	LIMIT (dBuV/m)	MARGIN (dB)	ANTENNA FACTOR (dB/m)	CABLE LOSS (dB)	PREAMP FACTOR (dB)	ANTENNA HEIGHT (cm)	TABLE ANGLE (Degree)	REMARK
2386	41.15	39.31	54	-12.85	31.93	5.4	35.49	153	190	Average
2386	51.53	49.69	74	-22.47	31.93	5.4	35.49	153	190	Peak
2402	97.43	95.54			31.96	5.4	35.47	153	190	Average
2402	98.55	96.66			31.96	5.4	35.47	153	190	Peak
2486	41.94	39.73	54	-12.06	32.1	5.53	35.42	153	190	Average
2486	51.72	49.51	74	-22.28	32.1	5.53	35.42	153	190	Peak
ANTENNA POLARITY & TEST DISTANCE: VERTICAL AT 3 M										
FREQ. (MHz)	EMISSION LEVEL (dBuV/m)	READ LEVEL (dBuV)	LIMIT (dBuV/m)	MARGIN (dB)	ANTENNA FACTOR (dB/m)	CABLE LOSS (dB)	PREAMP FACTOR (dB)	ANTENNA HEIGHT (cm)	TABLE ANGLE (Degree)	REMARK
2344	41.02	39.35	54	-12.98	31.84	5.33	35.5	103	270	Average
2344	52.29	50.62	74	-21.71	31.84	5.33	35.5	103	270	Peak
2402	92.21	90.32			31.96	5.4	35.47	103	270	Average
2402	93.29	91.4			31.96	5.4	35.47	103	270	Peak
2496	41.85	39.63	54	-12.15	32.1	5.53	35.41	103	270	Average
2496	51.88	49.66	74	-22.12	32.1	5.53	35.41	103	270	Peak

REMARKS:

- Emission Level = Read Level + Antenna Factor + Cable Loss - Preamp Factor
Margin value = Emission level – Limit value
- 2402MHz: Fundamental frequency.



A D T

EUT TEST CONDITION		MEASUREMENT DETAIL	
CHANNEL	Channel 19	FREQUENCY RANGE	1GHz ~ 25GHz
INPUT POWER (SYSTEM)	120Vac, 60 Hz	DETECTOR FUNCTION	Peak (PK) Average (AV)
ENVIRONMENTAL CONDITIONS	25deg. C, 65%RH	TESTED BY	Kay Wu

ANTENNA POLARITY & TEST DISTANCE: HORIZONTAL AT 3 M										
FREQ. (MHz)	EMISSION LEVEL (dBuV/m)	READ LEVEL (dBuV)	LIMIT (dBuV/m)	MARGIN (dB)	ANTENNA FACTOR (dB/m)	CABLE LOSS (dB)	PREAMP FACTOR (dB)	ANTENNA HEIGHT (cm)	TABLE ANGLE (Degree)	REMARK
2356	41.14	39.4	54	-12.86	31.87	5.37	35.5	152	193	Average
2356	51.95	50.21	74	-22.05	31.87	5.37	35.5	152	193	Peak
2440	98.94	96.93			32.01	5.46	35.46	152	193	Average
2440	100.05	98.04			32.01	5.46	35.46	152	193	Peak
2486	41.72	39.51	54	-12.28	32.1	5.53	35.42	152	193	Average
2486	52.23	50.02	74	-21.77	32.1	5.53	35.42	152	193	Peak

ANTENNA POLARITY & TEST DISTANCE: VERTICAL AT 3 M										
FREQ. (MHz)	EMISSION LEVEL (dBuV/m)	READ LEVEL (dBuV)	LIMIT (dBuV/m)	MARGIN (dB)	ANTENNA FACTOR (dB/m)	CABLE LOSS (dB)	PREAMP FACTOR (dB)	ANTENNA HEIGHT (cm)	TABLE ANGLE (Degree)	REMARK
2382	41.27	39.43	54	-12.73	31.93	5.4	35.49	104	270	Average
2382	51.61	49.77	74	-22.39	31.93	5.4	35.49	104	270	Peak
2440	92.24	90.23			32.01	5.46	35.46	104	270	Average
2440	93.42	91.41			32.01	5.46	35.46	104	270	Peak
2496	41.84	39.62	54	-12.16	32.1	5.53	35.41	104	270	Average
2496	51.46	49.24	74	-22.54	32.1	5.53	35.41	104	270	Peak
2382	41.27	39.43	54	-12.73	31.93	5.4	35.49	104	270	Average

REMARKS:

- Emission Level = Read Level + Antenna Factor + Cable Loss - Preamp Factor
Margin value = Emission level – Limit value
- 2441MHz: Fundamental frequency.



A D T

EUT TEST CONDITION		MEASUREMENT DETAIL	
CHANNEL	Channel 39	FREQUENCY RANGE	1GHz ~ 25GHz
INPUT POWER (SYSTEM)	120Vac, 60 Hz	DETECTOR FUNCTION	Peak (PK) Average (AV)
ENVIRONMENTAL CONDITIONS	25deg. C, 65%RH	TESTED BY	Kay Wu

ANTENNA POLARITY & TEST DISTANCE: HORIZONTAL AT 3 M										
FREQ. (MHz)	EMISSION LEVEL (dBuV/m)	READ LEVEL (dBuV)	LIMIT (dBuV/m)	MARGIN (dB)	ANTENNA FACTOR (dB/m)	CABLE LOSS (dB)	PREAMP FACTOR (dB)	ANTENNA HEIGHT (cm)	TABLE ANGLE (Degree)	REMARK
2328	40.87	39.28	54	-13.13	31.81	5.3	35.52	180	242	Average
2328	51.51	49.92	74	-22.49	31.81	5.3	35.52	180	242	Peak
2480	94.84	92.69			32.07	5.5	35.42	180	242	Average
2480	96.02	93.87			32.07	5.5	35.42	180	242	Peak
2484	42	39.82	54	-12	32.1	5.5	35.42	180	242	Average
2484	53.33	51.15	74	-20.67	32.1	5.5	35.42	180	242	Peak
ANTENNA POLARITY & TEST DISTANCE: VERTICAL AT 3 M										
FREQ. (MHz)	EMISSION LEVEL (dBuV/m)	READ LEVEL (dBuV)	LIMIT (dBuV/m)	MARGIN (dB)	ANTENNA FACTOR (dB/m)	CABLE LOSS (dB)	PREAMP FACTOR (dB)	ANTENNA HEIGHT (cm)	TABLE ANGLE (Degree)	REMARK
2358	41.1	39.36	54	-12.9	31.87	5.37	35.5	103	271	Average
2358	51.87	50.13	74	-22.13	31.87	5.37	35.5	103	271	Peak
2480	91.28	89.13			32.07	5.5	35.42	103	271	Average
2480	92.55	90.4			32.07	5.5	35.42	103	271	Peak
2500	41.83	39.61	54	-12.17	32.1	5.53	35.41	103	271	Average
2500	51.88	49.66	74	-22.12	32.1	5.53	35.41	103	271	Peak

REMARKS:

- Emission Level = Read Level + Antenna Factor + Cable Loss - Preamp Factor
Margin value = Emission level – Limit value
- 2480MHz: Fundamental frequency.



A D T

BELOW 1GHz WORST-CASE DATA :

EUT TEST CONDITION		MEASUREMENT DETAIL	
CHANNEL	Channel 19	FREQUENCY RANGE	30MHz ~ 1GHz
INPUT POWER (SYSTEM)	120Vac, 60 Hz	DETECTOR FUNCTION	Peak (PK) Quasi-peak (QP)
ENVIRONMENTAL CONDITIONS	25deg. C, 65%RH	TESTED BY	Kay Wu

ANTENNA POLARITY & TEST DISTANCE: HORIZONTAL AT 3 M

FREQ. (MHz)	EMISSION LEVEL (dBuV/m)	READ LEVEL (dBuV)	LIMIT (dBuV/m)	MARGIN (dB)	ANTENNA FACTOR (dB/m)	CABLE LOSS (dB)	PREAMP FACTOR (dB)	ANTENNA HEIGHT (cm)	TABLE ANGLE (Degree)	REMARK
91.56	14.38	36.02	43.5	-29.12	9.02	1.11	31.77	155	26	Peak
146.37	17.82	38.86	43.5	-25.68	9.85	1.38	32.27	157	82	Peak
221.16	17.54	36.38	46	-28.46	11.72	1.65	32.21	102	325	Peak
439.3	26.75	38.53	46	-19.25	17.89	2.49	32.16	174	158	Peak
606.6	21.76	29.69	46	-24.24	21.39	2.87	32.19	102	144	Peak
732.6	34.23	39.87	46	-11.77	23.33	3.16	32.13	156	235	Peak

ANTENNA POLARITY & TEST DISTANCE: VERTICAL AT 3 M

FREQ. (MHz)	EMISSION LEVEL (dBuV/m)	READ LEVEL (dBuV)	LIMIT (dBuV/m)	MARGIN (dB)	ANTENNA FACTOR (dB/m)	CABLE LOSS (dB)	PREAMP FACTOR (dB)	ANTENNA HEIGHT (cm)	TABLE ANGLE (Degree)	REMARK
30.27	28.97	42.95	40	-11.03	17.55	0.74	32.27	123	215	Peak
90.21	18.68	40.34	43.5	-24.82	8.94	1.11	31.71	185	265	Peak
172.02	10.36	31.01	43.5	-33.14	10.07	1.52	32.24	105	219	Peak
439.3	25.27	37.05	46	-20.73	17.89	2.49	32.16	103	218	Peak
588.4	22.07	30.79	46	-23.93	20.6	2.87	32.19	174	152	Peak
732.6	31.5	37.14	46	-14.5	23.33	3.16	32.13	116	225	Peak

REMARKS: Emission Level = Read Level + Antenna Factor + Cable Loss - Preamp Factor
Margin value = Emission level – Limit value



A D T

5.2 CONDUCTED EMISSION MEASUREMENT

5.2.1 LIMITS OF CONDUCTED EMISSION MEASUREMENT

Same as item 4.2.1.

5.2.2 TEST INSTRUMENTS

Same as item 4.2.2.

5.2.3 TEST PROCEDURES

Same as item 4.2.3.

5.2.4 DEVIATION FROM TEST STANDARD

No deviation.

5.2.5 TEST SETUP

Same as item 4.2.5.

5.2.6 EUT OPERATING CONDITIONS

Same as 4.1.6

5.2.7 TEST RESULTS

CONDUCTED WORST-CASE DATA :

PHASE	Line 1	6dB BANDWIDTH	9kHz
--------------	--------	----------------------	------

No	Freq. [MHz]	Corr. Factor (dB)	Reading Value [dB (uV)]		Emission Level [dB (uV)]		Limit [dB (uV)]		Margin (dB)	
			Q.P.	AV.	Q.P.	AV.	Q.P.	AV.	Q.P.	AV.
			1	0.19687	0.17	40.03	31.48	40.20	31.65	63.74
2	0.39219	0.21	43.82	36.11	44.03	36.32	58.02	48.02	-13.99	-11.70
3	0.83750	0.25	41.79	32.14	42.04	32.39	56.00	46.00	-13.96	-13.61
4	2.60156	0.31	39.78	30.41	40.09	30.72	56.00	46.00	-15.91	-15.28
5	6.41016	0.39	35.46	24.34	35.85	24.73	60.00	50.00	-24.15	-25.27
6	13.56250	0.50	44.31	38.43	44.81	38.93	60.00	50.00	-15.19	-11.07

REMARKS:

1. Q.P. and AV. are abbreviations of quasi-peak and average individually.
2. The emission levels of other frequencies were very low against the limit.
3. Margin value = Emission level - Limit value
4. Correction factor = Insertion loss + Cable loss
5. Emission Level = Correction Factor + Reading Value

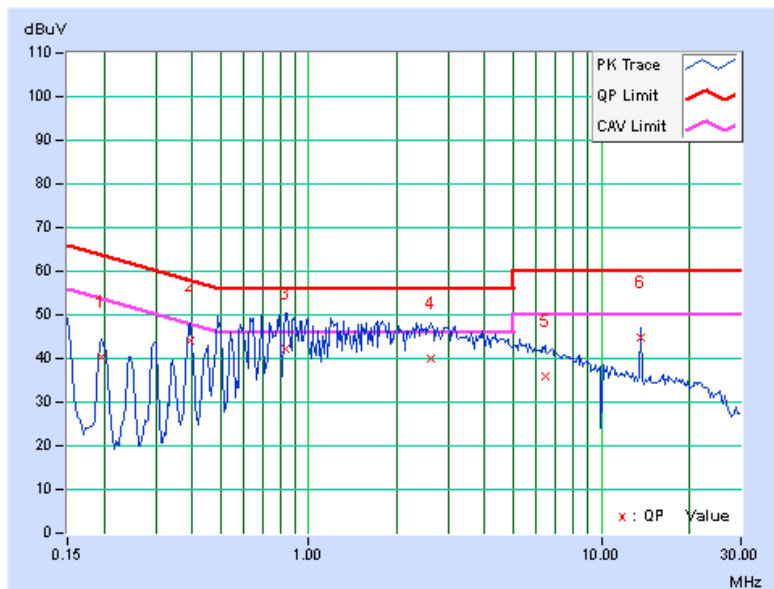

PHASE	Line 2	6dB BANDWIDTH	9kHz
-------	--------	---------------	------

No	Freq. [MHz]	Corr. Factor (dB)	Reading Value [dB (uV)]		Emission Level [dB (uV)]		Limit [dB (uV)]		Margin (dB)	
			Q.P.	AV.	Q.P.	AV.	Q.P.	AV.	Q.P.	AV.
			1	0.19297	0.18	41.78	32.75	41.96	32.93	63.91
2	0.48594	0.25	43.56	36.75	43.81	37.00	56.24	46.24	-12.43	-9.24
3	1.12891	0.24	38.47	26.88	38.71	27.12	56.00	46.00	-17.29	-18.88
4	2.14453	0.29	38.22	29.55	38.51	29.84	56.00	46.00	-17.49	-16.16
5	13.56250	0.57	45.30	40.65	45.87	41.22	60.00	50.00	-14.13	-8.78
6	27.11719	0.65	35.54	26.99	36.19	27.64	60.00	50.00	-23.81	-22.36

REMARKS:

1. Q.P. and AV. are abbreviations of quasi-peak and average individually.
2. The emission levels of other frequencies were very low against the limit.
3. Margin value = Emission level - Limit value
4. Correction factor = Insertion loss + Cable loss
5. Emission Level = Correction Factor + Reading Value

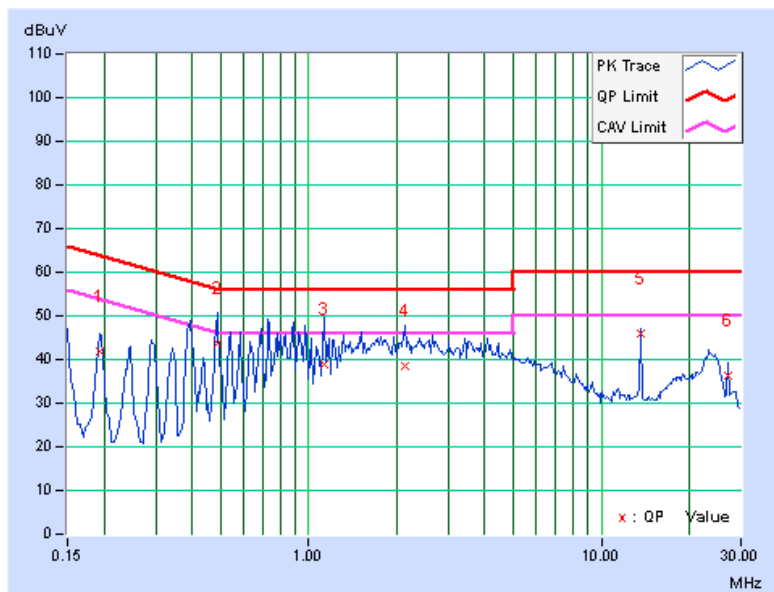

5.3 6dB BANDWIDTH MEASUREMENT

5.3.1 LIMITS OF 6dB BANDWIDTH MEASUREMENT

The minimum of 6dB Bandwidth Measurement is 0.5MHz.

5.3.2 TEST SETUP

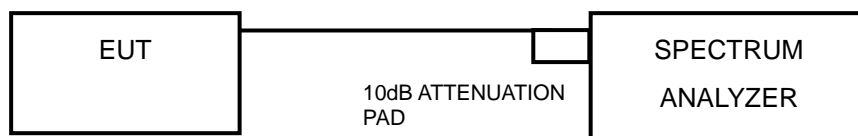

5.3.3 TEST INSTRUMENTS

Refer to section 4.1.2 to get information of above instrument.

5.3.4 TEST PROCEDURE

1. Set resolution bandwidth (RBW) = approximately 1% of the emission bandwidth
2. Set the video bandwidth (VBW) $\geq 3 \times$ RBW, Detector = Peak.
3. Trace mode = max hold.
4. Sweep = auto couple.
5. Measure the maximum width of the emission that is constrained by the frequencies associated with the two amplitude points (upper and lower) that are attenuated by 6 dB relative to the maximum level measured in the fundamental emission.

5.3.5 DEVIATION FROM TEST STANDARD

No deviation.

5.3.6 EUT OPERATING CONDITIONS

The software provided by client to enable the EUT under transmission condition continuously at lowest, middle and highest channel frequencies individually.



A D T

5.3.7 TEST RESULTS

CHANNEL	FREQUENCY (MHz)	6dB BANDWIDTH (KHz)	MINIMUM LIMIT (MHz)	PASS / FAIL
0	2402	675.56	0.5	PASS
19	2440	680.66	0.5	PASS
39	2480	671.65	0.5	PASS

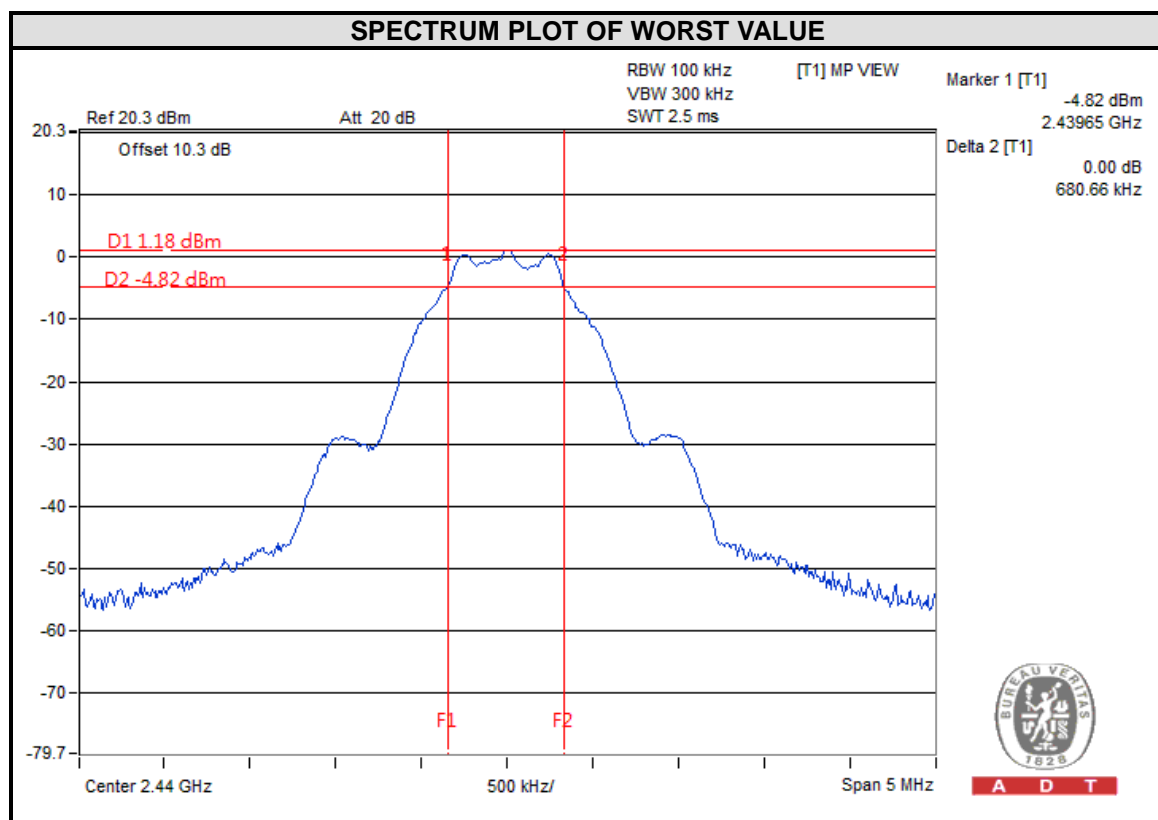

A D T

5.4 CONDUCTED OUTPUT POWER

5.4.1 LIMITS OF MAXIMUM OUTPUT POWER MEASUREMENT

For systems using digital modulation in the 2400-2483.5 MHz bands: 1 Watt (30dBm)

5.4.2 TEST SETUP

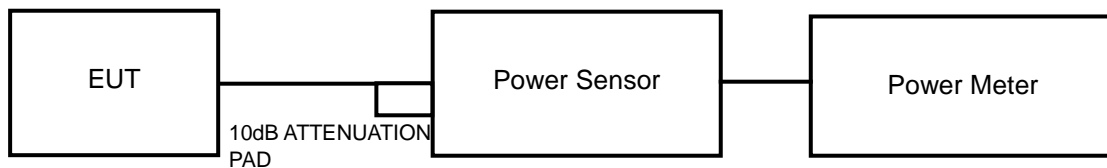

5.4.3 INSTRUMENTS

Refer to section 4.1.2 to get information of above instrument.

5.4.4 TEST PROCEDURES

A peak power sensor was used on the output port of the EUT. A power meter was used to read the response of the peak power sensor. Record the peak power level.

5.4.5 DEVIATION FROM TEST STANDARD

No deviation.

5.4.6 EUT OPERATING CONDITIONS

Same as Item 4.3.6.

5.4.7 TEST RESULTS

CHANNEL	FREQUENCY (MHz)	PEAK POWER (mW)	PEAK POWER (dBm)	LIMIT (dBm)	PASS/FAIL
0	2402	1.033	0.14	30	PASS
19	2440	1.452	1.62	30	PASS
39	2480	1.084	0.35	30	PASS

5.5 POWER SPECTRAL DENSITY MEASUREMENT

5.5.1 LIMITS OF POWER SPECTRAL DENSITY MEASUREMENT

The Maximum of Power Spectral Density Measurement is 8dBm.

5.5.2 TEST SETUP

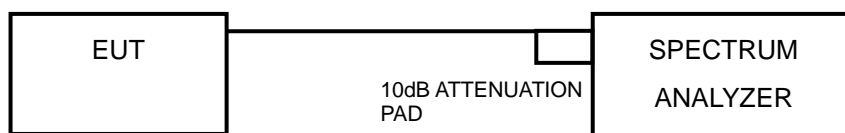

5.5.3 TEST INSTRUMENTS

Refer to section 4.1.2 to get information of above instrument.

5.5.4 TEST PROCEDURE.

- a. Set the RBW = 3 kHz, VBW =10 kHz, Detector = peak.
- b. Sweep time = auto couple, Trace mode = max hold, allow trace to fully stabilize.
- c. Use the peak marker function to determine the maximum power level in any 100 kHz band segment within the fundamental EBW.

5.5.5 DEVIATION FROM TEST STANDARD

No deviation.

5.5.6 EUT OPERATING CONDITION

Same as item 4.3.6.



A D T

5.5.7 TEST RESULTS

Channel	FREQ. (MHz)	PSD (dBm/3kHz)	Limit (dBm/3kHz)	PASS /FAIL
0	2402	-15.43	8	PASS
19	2440	-13.81	8	PASS
39	2480	-15.21	8	PASS

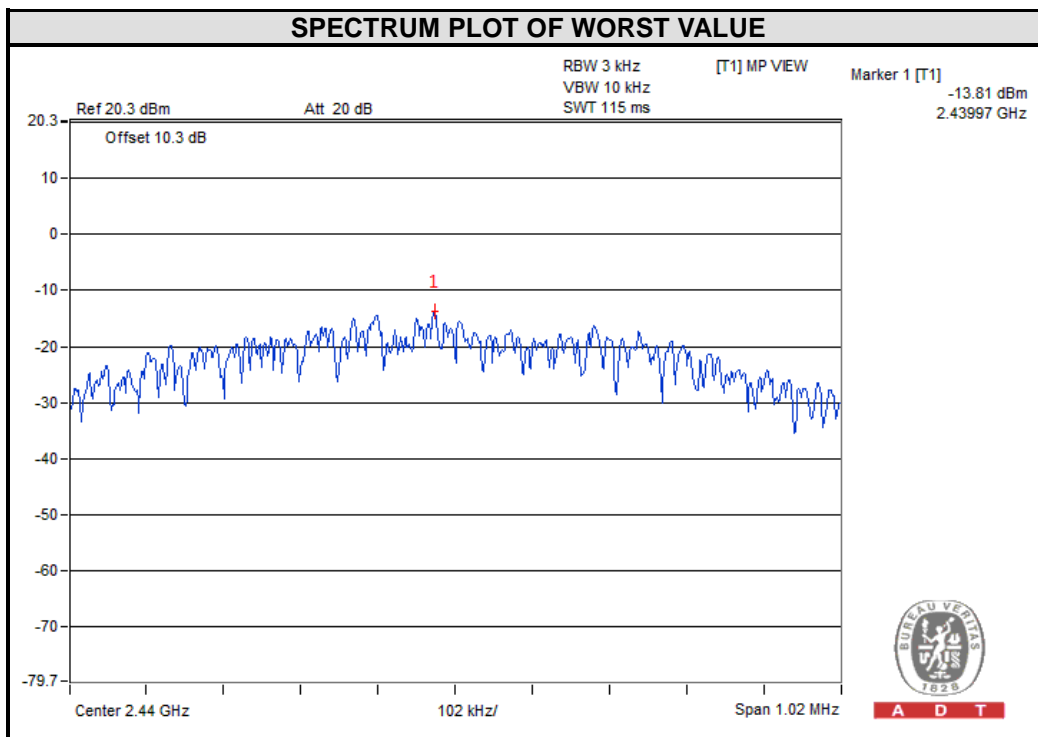

5.6 CONDUCTED OUT OF BAND EMISSION MEASUREMENT

5.6.1 LIMITS OF OUT OF BAND EMISSION MEASUREMENT

Below -20dB of the highest emission level of operating band (in 100kHz Resolution Bandwidth).

5.6.2 TEST SETUP

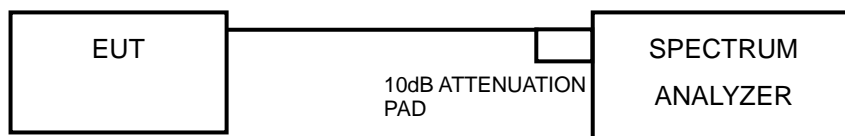

5.6.3 TEST INSTRUMENTS

Refer to section 4.1.2 to get information of above instrument.

5.6.4 TEST PROCEDURE

MEASUREMENT PROCEDURE REF

1. Set the RBW = 100 kHz.
2. Set the VBW \geq 300 kHz.
3. Detector = peak.
4. Sweep time = auto couple.
5. Trace mode = max hold.
6. Allow trace to fully stabilize.
7. Use the peak marker function to determine the maximum power level in any 100 kHz band segment within the fundamental EBW.

MEASUREMENT PROCEDURE OOB

1. Set RBW = 100 kHz.
2. Set VBW \geq 300 kHz.
3. Ensure that the number of measurement points \geq span/RBW
4. According to measurement points to set differ measurement span.
5. Detector = peak.
6. Trace Mode = max hold.
7. Sweep = auto couple.

5.6.5 DEVIATION FROM TEST STANDARD

No deviation.

5.6.6 EUT OPERATING CONDITION

Same as Item 4.3.6

5.6.7 TEST RESULTS

The spectrum plots are attached on the following pages. D1 line indicates the highest level, and D2 line indicates the 20dB offset below D1. It shows compliance with the requirement.



A D T

CH 0

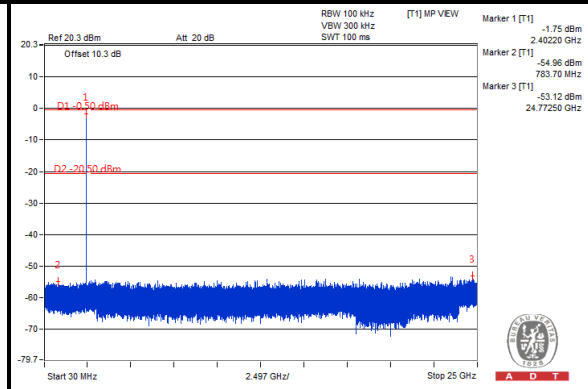
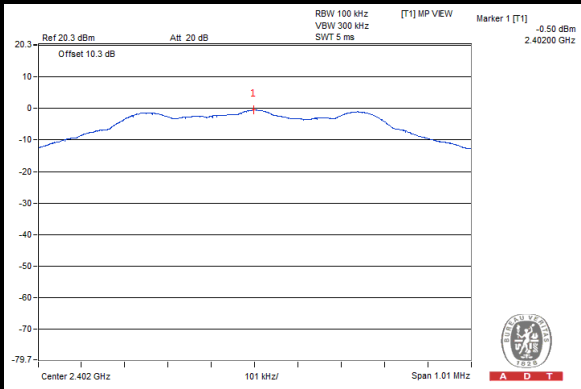

CH 19

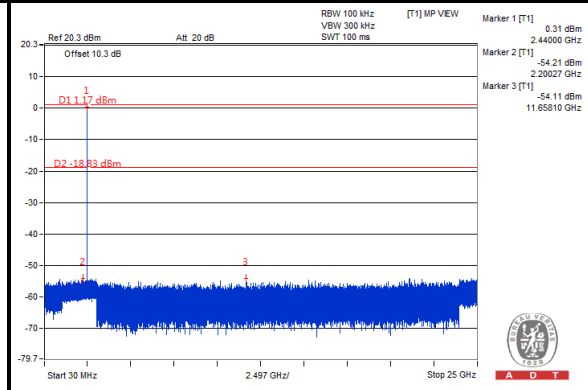
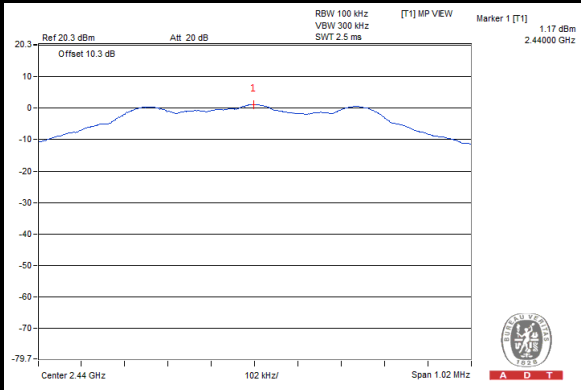

CH 39

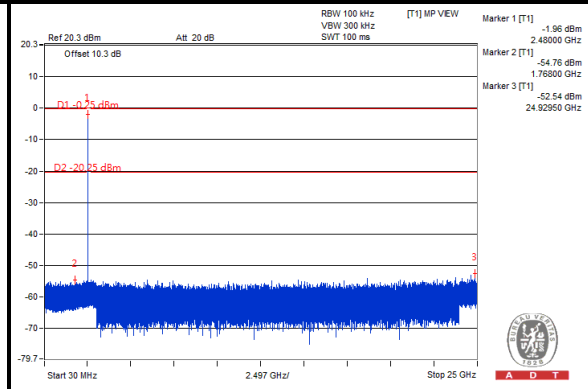
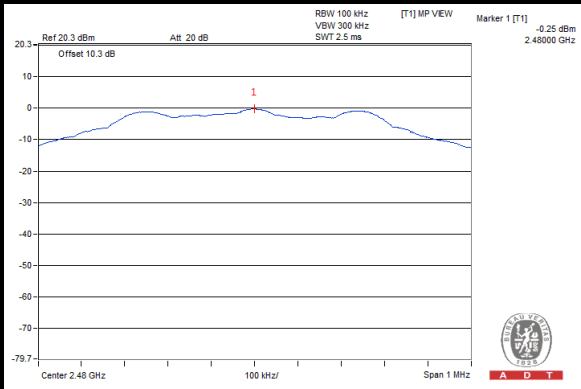



A D T

6. PHOTOGRAPHS OF THE TEST CONFIGURATION

Please refer to the attached file (Test Setup Photo).



7. INFORMATION ON THE TESTING LABORATORIES

We, Bureau Veritas Consumer Products Services (H.K.) Ltd., Taoyuan Branch, were founded in 1988 to provide our best service in EMC, Radio, Telecom and Safety consultation. Our laboratories are accredited and approved according to ISO/IEC 17025.

If you have any comments, please feel free to contact us at the following:

Linko EMC/RF Lab:

Tel: 886-2-26052180

Fax: 886-2-26051924

Hsin Chu EMC/RF Lab:

Tel: 886-3-5935343

Fax: 886-3-5935342

Hwa Ya EMC/RF/Safety Telecom Lab:

Tel: 886-3-3183232

Fax: 886-3-3270892

Email: service.adt@tw.bureauveritas.com

Web Site: www.bureauveritas-adt.com

The address and road map of all our labs can be found in our web site also.



A D T

8. APPENDIX A - MODIFICATIONS RECORDERS FOR ENGINEERING CHANGES TO THE EUT BY THE LAB

No any modifications are made to the EUT by the lab during the test.

---END---