



FCC SAR Test Report

Report No. : SA131119C06

Applicant : Kyocera Communications, Inc. c/o Kyocera Corporation

Address : 8611 Balboa Ave. San Diego, CA 92123

Product : Kyocera phone

FCC ID : V65C6725

Brand : Kyocera

Model No. : C6725

Standards : FCC 47 CFR Part 2 (2.1093) / IEEE C95.1:1992 / IEEE 1528:2003
 IEEE 1528a-2005 / KDB 865664 D01 v01r03 / KDB 248227 D01 v01r02
 KDB 447498 D01 v05r02 / KDB 648474 D04 v01r02 / KDB 941225 D01 v02
 KDB 941225 D05 v02r03 / KDB 941225 D06 v01r01

Sample Received Date : Nov. 19, 2013

Date of Testing : Dec. 06, 2013 ~ Dec. 13, 2013

CERTIFICATION: The above equipment have been tested by **Bureau Veritas Consumer Products Services (H.K.) Ltd., Taoyuan Branch – Lin Kou Laboratories**, and found compliance with the requirement of the above standards. The test record, data evaluation & Equipment Under Test (EUT) configurations represented herein are true and accurate accounts of the measurements of the sample’s SAR characteristics under the conditions specified in this report. It should not be reproduced except in full, without the written approval of our laboratory. The client should not use it to claim product certification, approval, or endorsement by TAF or any government agencies.

Prepared By : Evonne Liu
 Evonne Liu / Specialist

Approved By : Roy Wu
 Roy Wu / Manager



This report is for your exclusive use. Any copying or replication of this report to or for any other person or entity, or use of our name or trademark, is permitted only with our prior written permission. This report sets forth our findings solely with respect to the test samples identified herein. The results set forth in this report are not indicative or representative of the quality or characteristics of the lot from which a test sample was taken or any similar or identical product unless specifically and expressly noted. Our report includes all of the tests requested by you and the results thereof based upon the information that you provided to us. You have 60 days from date of issuance of this report to notify us of any material error or omission caused by our negligence, provided, however, that such notice shall be in writing and shall specifically address the issue you wish to raise. A failure to raise such issue within the prescribed time shall constitute your unqualified acceptance of the completeness of this report, the tests conducted and the correctness of the report contents. Unless specific mention, the uncertainty of measurement has been explicitly taken into account to declare the compliance or non-compliance to the specification.



Table of Contents

Release Control Record	3
1. Summary of Maximum SAR Value	4
2. Description of Equipment Under Test	5
3. SAR Measurement System	6
3.1 Definition of Specific Absorption Rate (SAR)	6
3.2 SPEAG DASY System	6
3.2.1 Robot.....	7
3.2.2 Probes.....	8
3.2.3 Data Acquisition Electronics (DAE)	8
3.2.4 Phantoms	9
3.2.5 Device Holder.....	10
3.2.6 System Validation Dipoles.....	10
3.2.7 Tissue Simulating Liquids.....	11
3.3 SAR System Verification	14
3.4 SAR Measurement Procedure	15
3.4.1 Area & Zoom Scan Procedure	15
3.4.2 Volume Scan Procedure.....	15
3.4.3 Power Drift Monitoring.....	16
3.4.4 Spatial Peak SAR Evaluation	16
3.4.5 SAR Averaged Methods	16
4. SAR Measurement Evaluation	17
4.1 EUT Configuration and Setting.....	17
4.2 EUT Testing Position	20
4.2.1 Head Exposure Conditions.....	20
4.2.2 Body-Worn Accessory Exposure Conditions	22
4.2.3 Hotspot Mode Exposure conditions.....	23
4.2.4 SAR Test Exclusions	23
4.3 Tissue Verification	24
4.4 System Validation.....	24
4.5 System Verification.....	25
4.6 Maximum Output Power.....	25
4.6.1 Maximum Conducted Power	25
4.6.2 Measured Conducted Power Result.....	26
4.7 SAR Testing Results	30
4.7.1 SAR Results for Head	30
4.7.2 SAR Results for Body-Worn (Separation Distance is 1.0 cm Gap)	32
4.7.3 SAR Results for Hotspot (Separation Distance is 1.0 cm Gap).....	33
4.7.4 SAR Measurement Variability.....	35
4.7.5 Simultaneous Multi-band Transmission Evaluation	36
5. Calibration of Test Equipment.....	41
6. Measurement Uncertainty.....	42
7. Information on the Testing Laboratories.....	43

- Appendix A. SAR Plots of System Verification
- Appendix B. SAR Plots of SAR Measurement
- Appendix C. Calibration Certificate for Probe and Dipole
- Appendix D. Photographs of EUT and Setup



Release Control Record

Issue No.	Reason for Change	Date Issued
R01	Initial release	Feb. 18, 2014



FCC SAR Test Report

1. Summary of Maximum SAR Value

Equipment Class	Mode	Highest Reported Head SAR _{1g} (W/kg)	Highest Reported Body SAR _{1g} (1.0 cm Gap) (W/kg)	Highest Reported Hotspot SAR _{1g} (1.0 cm Gap) (W/kg)
PCE	CDMA BC0	0.47	0.62	0.79
	CDMA BC1	0.80	0.95	1.48
	CDMA BC10	0.45	0.63	0.73
	LTE 25	0.57	0.72	1.22
	LTE 26	0.36	0.43	0.57
	LTE 41	1.29	0.43	0.43
DTS	2.4G WLAN	0.15	0.28	0.28
DSS	Bluetooth	N/A	N/A	N/A
DXX	NFC	N/A	N/A	N/A
Highest Simultaneous Transmission SAR		Head (W/kg)	Body-Worn (W/kg)	Hotspot (W/kg)
PCE+DTS		1.35	1.22	1.48
PCE+DSS		N/A	0.98	N/A

Note:

- The SAR limit (**Head & Body: SAR_{1g} 1.6 W/kg**) for general population / uncontrolled exposure is specified in FCC 47 CFR part 2 (2.1093) and ANSI/IEEE C95.1-1992.

FCC SAR Test Report

2. Description of Equipment Under Test

EUT Type	Kyocera phone
FCC ID	V65C6725
Brand Name	Kyocera
Model Name	C6725
HW Version	0101
SW Version	0.511NS
Tx Frequency Bands (Unit: MHz)	CDMA BC0 : 824.7 ~ 848.31 CDMA BC1 : 1851.25 ~ 1908.75 CDMA BC10 : 817.9 ~ 823.1 LTE Band 25 : 1851.5 ~ 1913.5 LTE Band 26 : 814.7 ~ 848.3 LTE Band 41 : 2501 ~ 2685 WLAN : 2412 ~ 2462 Bluetooth : 2402 ~ 2480 NFC : 13.56
Uplink Modulations	CDMA : QPSK LTE : QPSK, 16QAM 802.11b : DSSS 802.11g/n : OFDM Bluetooth : GFSK NFC : ASK
Maximum Tune-up Conducted Power (Unit: dBm)	CDMA BC0 : 25.2 CDMA BC1 : 25.2 CDMA BC10 : 25.2 LTE Band 25 : 24.2 LTE Band 26 : 23.7 LTE Band 41 : 24.2 WLAN 2.4G : 17.5 Bluetooth : 2.00
Antenna Type	Fixed Internal Antenna
EUT Stage	Identical Prototype

Note:

- The above EUT information is declared by manufacturer and for more detailed features description please refers to the manufacturer's specifications or User's Manual.

List of Accessory:

Battery	Brand Name	Kyocera
	Model Name	SCP-59LBPS
	Power Rating	3.8Vdc, 2000mAh
	Type	Li-ion

3. SAR Measurement System

3.1 Definition of Specific Absorption Rate (SAR)

SAR is related to the rate at which energy is absorbed per unit mass in an object exposed to a radio field. The SAR distribution in a biological body is complicated and is usually carried out by experimental techniques or numerical modeling. The standard recommends limits for two tiers of groups, occupational/controlled and general population/uncontrolled, based on a person's awareness and ability to exercise control over his or her exposure. In general, occupational/controlled exposure limits are higher than the limits for general population/uncontrolled.

The SAR definition is the time derivative (rate) of the incremental energy (dW) absorbed by (dissipated in) an incremental mass (dm) contained in a volume element (dv) of a given density (ρ). The equation description is as below:

$$SAR = \frac{d}{dt} \left(\frac{dW}{dm} \right) = \frac{d}{dt} \left(\frac{dW}{\rho dv} \right)$$

SAR is expressed in units of Watts per kilogram (W/kg)

SAR measurement can be related to the electrical field in the tissue by

$$SAR = \frac{\sigma |E|^2}{\rho}$$

Where: σ is the conductivity of the tissue, ρ is the mass density of the tissue and E is the RMS electrical field strength.

3.2 SPEAG DASY System

DASY system consists of high precision robot, probe alignment sensor, phantom, robot controller, controlled measurement server and near-field probe. The robot includes six axes that can move to the precision position of the DASY4/5 software defined. The DASY software can define the area that is detected by the probe. The robot is connected to controlled box. Controlled measurement server is connected to the controlled robot box. The DAE includes amplifier, signal multiplexing, AD converter, offset measurement and surface detection. It is connected to the Electro-optical coupler (ECO). The ECO performs the conversion from the optical into digital electric signal of the DAE and transfers data to the PC.

FCC SAR Test Report

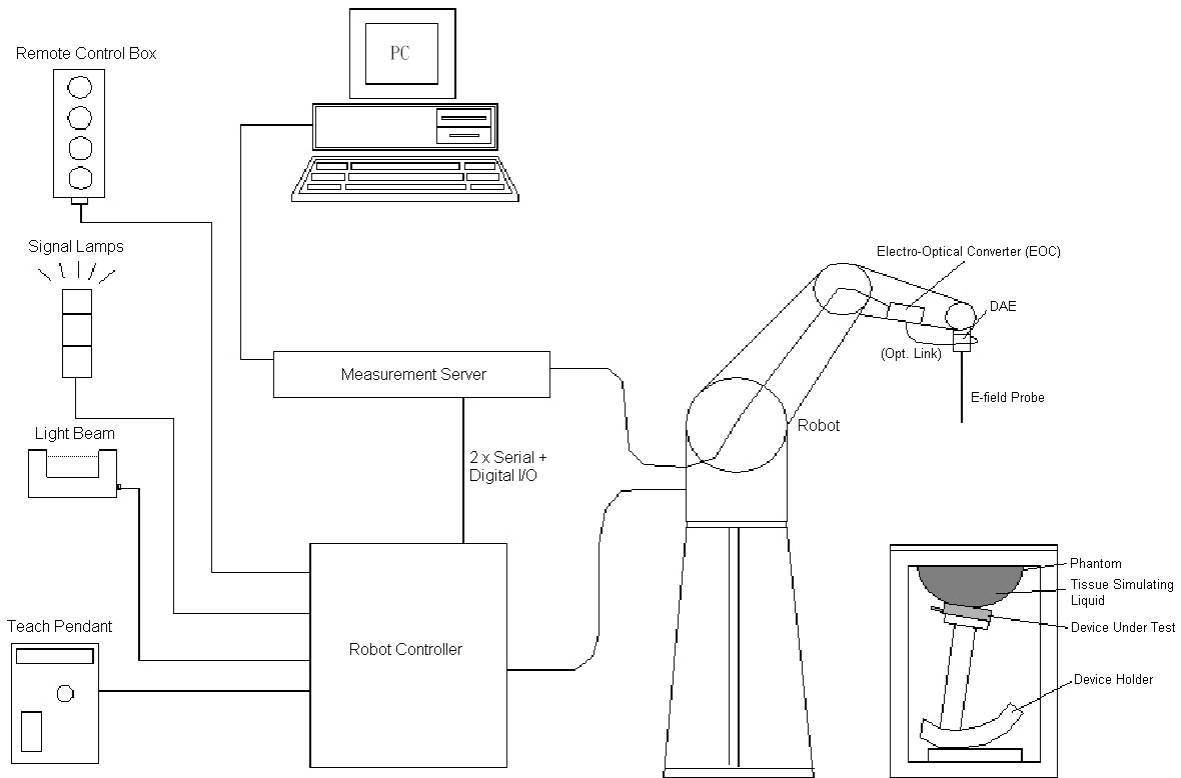

Fig-3.1 DASY System Setup

3.2.1 Robot

The DASY system uses the high precision robots from Stäubli SA (France). For the 6-axis controller system, the robot controller version (DASY4: CS7MB; DASY5: CS8c) from Stäubli is used. The Stäubli robot series have many features that are important for our application:

- High precision (repeatability ± 0.035 mm)
- High reliability (industrial design)
- Jerk-free straight movements
- Low ELF interference (the closed metallic construction shields against motor control fields)



Fig-3.2 DASY4





Fig-3.3 DASY5

FCC SAR Test Report

3.2.2 Probes

The SAR measurement is conducted with the dosimetric probe. The probe is specially designed and calibrated for use in liquid with high permittivity. The dosimetric probe has special calibration in liquid at different frequency.

Model	EX3DV4	
Construction	Symmetrical design with triangular core. Built-in shielding against static charges. PEEK enclosure material (resistant to organic solvents, e.g., DGBE).	
Frequency	10 MHz to 6 GHz Linearity: ± 0.2 dB	
Directivity	± 0.3 dB in HSL (rotation around probe axis) ± 0.5 dB in tissue material (rotation normal to probe axis)	
Dynamic Range	10 μ W/g to 100 mW/g Linearity: ± 0.2 dB (noise: typically < 1 μ W/g)	
Dimensions	Overall length: 337 mm (Tip: 20 mm) Tip diameter: 2.5 mm (Body: 12 mm) Typical distance from probe tip to dipole centers: 1 mm	

Model	ES3DV3	
Construction	Symmetrical design with triangular core. Interleaved sensors. Built-in shielding against static charges. PEEK enclosure material (resistant to organic solvents, e.g., DGBE).	
Frequency	10 MHz to 4 GHz Linearity: ± 0.2 dB	
Directivity	± 0.2 dB in HSL (rotation around probe axis) ± 0.3 dB in tissue material (rotation normal to probe axis)	
Dynamic Range	5 μ W/g to 100 mW/g Linearity: ± 0.2 dB	
Dimensions	Overall length: 337 mm (Tip: 20 mm) Tip diameter: 3.9 mm (Body: 12 mm) Distance from probe tip to dipole centers: 2.0 mm	

3.2.3 Data Acquisition Electronics (DAE)

Model	DAE3, DAE4	
Construction	Signal amplifier, multiplexer, A/D converter and control logic. Serial optical link for communication with DASY4/5 embedded system (fully remote controlled). Two step probe touch detector for mechanical surface detection and emergency robot stop.	
Measurement Range	-100 to +300 mV (16 bit resolution and two range settings: 4mV, 400mV)	
Input Offset Voltage	< 5 μ V (with auto zero)	
Input Bias Current	< 50 fA	
Dimensions	60 x 60 x 68 mm	

FCC SAR Test Report

3.2.4 Phantoms

Model	Twin SAM	
Construction	The shell corresponds to the specifications of the Specific Anthropomorphic Mannequin (SAM) phantom defined in IEEE 1528 and IEC 62209-1. It enables the dosimetric evaluation of left and right hand phone usage as well as body mounted usage at the flat phantom region. A cover prevents evaporation of the liquid. Reference markings on the phantom allow the complete setup of all predefined phantom positions and measurement grids by teaching three points with the robot.	
Material	Vinylester, glass fiber reinforced (VE-GF)	
Shell Thickness	2 ± 0.2 mm (6 ± 0.2 mm at ear point)	
Dimensions	Length: 1000 mm Width: 500 mm Height: adjustable feet	
Filling Volume	approx. 25 liters	

Model	ELI	
Construction	Phantom for compliance testing of handheld and body-mounted wireless devices in the frequency range of 30 MHz to 6 GHz. ELI is fully compatible with the IEC 62209-2 standard and all known tissue simulating liquids. ELI has been optimized regarding its performance and can be integrated into our standard phantom tables. A cover prevents evaporation of the liquid. Reference markings on the phantom allow installation of the complete setup, including all predefined phantom positions and measurement grids, by teaching three points. The phantom is compatible with all SPEAG dosimetric probes and dipoles.	
Material	Vinylester, glass fiber reinforced (VE-GF)	
Shell Thickness	2.0 ± 0.2 mm (bottom plate)	
Dimensions	Major axis: 600 mm Minor axis: 400 mm	
Filling Volume	approx. 30 liters	

FCC SAR Test Report

3.2.5 Device Holder

Model	Mounting Device	
Construction	In combination with the Twin SAM Phantom or ELI4, the Mounting Device enables the rotation of the mounted transmitter device in spherical coordinates. Rotation point is the ear opening point. Transmitter devices can be easily and accurately positioned according to IEC, IEEE, FCC or other specifications. The device holder can be locked for positioning at different phantom sections (left head, right head, flat).	
Material	POM	

Model	Laptop Extensions Kit	
Construction	Simple but effective and easy-to-use extension for Mounting Device that facilitates the testing of larger devices according to IEC 62209-2 (e.g., laptops, cameras, etc.). It is lightweight and fits easily on the upper part of the Mounting Device in place of the phone positioner.	
Material	POM, Acrylic glass, Foam	

3.2.6 System Validation Dipoles

Model	D-Serial	
Construction	Symmetrical dipole with 1/4 balun. Enables measurement of feed point impedance with NWA. Matched for use near flat phantoms filled with tissue simulating solutions.	
Frequency	750 MHz to 5800 MHz	
Return Loss	> 20 dB	
Power Capability	> 100 W (f < 1GHz), > 40 W (f > 1GHz)	

FCC SAR Test Report

3.2.7 Tissue Simulating Liquids

For SAR measurement of the field distribution inside the phantom, the phantom must be filled with homogeneous tissue simulating liquid to a depth of at least 15 cm. For head SAR testing, the liquid height from the ear reference point (ERP) of the phantom to the liquid top surface is larger than 15 cm. For body SAR testing, the liquid height from the center of the flat phantom to the liquid top surface is larger than 15 cm. The nominal dielectric values of the tissue simulating liquids in the phantom and the tolerance of 5% are listed in Table-3.1.

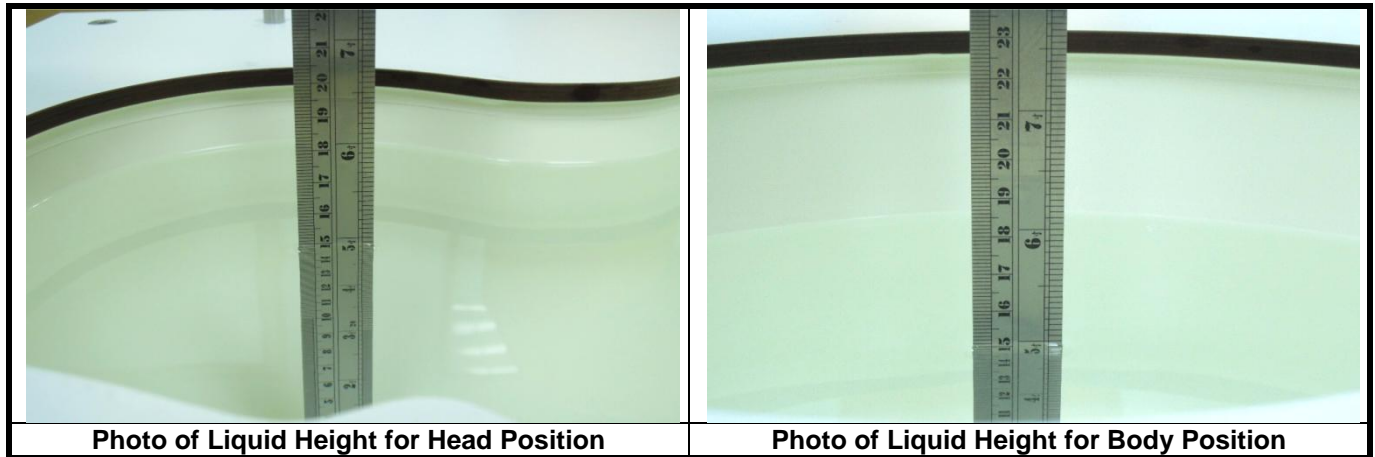

The dielectric properties of the head tissue simulating liquids are defined in IEEE 1528, and KDB 865664 D01 Appendix A. For the body tissue simulating liquids, the dielectric properties are defined in KDB 865664 D01 Appendix A. The dielectric properties of the tissue simulating liquids were verified prior to the SAR evaluation using an Agilent 85070D Dielectric Probe Kit and an Agilent Network Analyzer.



FCC SAR Test Report

Table-3.1 Targets of Tissue Simulating Liquid

Frequency (MHz)	Target Permittivity	Range of $\pm 5\%$	Target Conductivity	Range of $\pm 5\%$
For Head				
750	41.9	39.8 ~ 44.0	0.89	0.85 ~ 0.93
835	41.5	39.4 ~ 43.6	0.90	0.86 ~ 0.95
900	41.5	39.4 ~ 43.6	0.97	0.92 ~ 1.02
1450	40.5	38.5 ~ 42.5	1.20	1.14 ~ 1.26
1640	40.3	38.3 ~ 42.3	1.29	1.23 ~ 1.35
1750	40.1	38.1 ~ 42.1	1.37	1.30 ~ 1.44
1800	40.0	38.0 ~ 42.0	1.40	1.33 ~ 1.47
1900	40.0	38.0 ~ 42.0	1.40	1.33 ~ 1.47
2000	40.0	38.0 ~ 42.0	1.40	1.33 ~ 1.47
2300	39.5	37.5 ~ 41.5	1.67	1.59 ~ 1.75
2450	39.2	37.2 ~ 41.2	1.80	1.71 ~ 1.89
2600	39.0	37.1 ~ 41.0	1.96	1.86 ~ 2.06
3500	37.9	36.0 ~ 39.8	2.91	2.76 ~ 3.06
5200	36.0	34.2 ~ 37.8	4.66	4.43 ~ 4.89
5300	35.9	34.1 ~ 37.7	4.76	4.52 ~ 5.00
5500	35.6	33.8 ~ 37.4	4.96	4.71 ~ 5.21
5600	35.5	33.7 ~ 37.3	5.07	4.82 ~ 5.32
5800	35.3	33.5 ~ 37.1	5.27	5.01 ~ 5.53
For Body				
750	55.5	52.7 ~ 58.3	0.96	0.91 ~ 1.01
835	55.2	52.4 ~ 58.0	0.97	0.92 ~ 1.02
900	55.0	52.3 ~ 57.8	1.05	1.00 ~ 1.10
1450	54.0	51.3 ~ 56.7	1.30	1.24 ~ 1.37
1640	53.8	51.1 ~ 56.5	1.40	1.33 ~ 1.47
1750	53.4	50.7 ~ 56.1	1.49	1.42 ~ 1.56
1800	53.3	50.6 ~ 56.0	1.52	1.44 ~ 1.60
1900	53.3	50.6 ~ 56.0	1.52	1.44 ~ 1.60
2000	53.3	50.6 ~ 56.0	1.52	1.44 ~ 1.60
2300	52.9	50.3 ~ 55.5	1.81	1.72 ~ 1.90
2450	52.7	50.1 ~ 55.3	1.95	1.85 ~ 2.05
2600	52.5	49.9 ~ 55.1	2.16	2.05 ~ 2.27
3500	51.3	48.7 ~ 53.9	3.31	3.14 ~ 3.48
5200	49.0	46.6 ~ 51.5	5.30	5.04 ~ 5.57
5300	48.9	46.5 ~ 51.3	5.42	5.15 ~ 5.69
5500	48.6	46.2 ~ 51.0	5.65	5.37 ~ 5.93
5600	48.5	46.1 ~ 50.9	5.77	5.48 ~ 6.06
5800	48.2	45.8 ~ 50.6	6.00	5.70 ~ 6.30



FCC SAR Test Report

The following table gives the recipes for tissue simulating liquids.

Table-3.2 Recipes of Tissue Simulating Liquid

Tissue Type	Bactericide	DGBE	HEC	NaCl	Sucrose	Triton X-100	Water	Diethylene Glycol Mono-hexylether
H750	0.2	-	0.2	1.5	56.0	-	42.1	-
H835	0.2	-	0.2	1.5	57.0	-	41.1	-
H900	0.2	-	0.2	1.4	58.0	-	40.2	-
H1450	-	43.3	-	0.6	-	-	56.1	-
H1640	-	45.8	-	0.5	-	-	53.7	-
H1750	-	47.0	-	0.4	-	-	52.6	-
H1800	-	44.5	-	0.3	-	-	55.2	-
H1900	-	44.5	-	0.2	-	-	55.3	-
H2000	-	44.5	-	0.1	-	-	55.4	-
H2300	-	44.9	-	0.1	-	-	55.0	-
H2450	-	45.0	-	0.1	-	-	54.9	-
H2600	-	45.1	-	0.1	-	-	54.8	-
H3500	-	8.0	-	0.2	-	20.0	71.8	-
H5G	-	-	-	-	-	17.2	65.5	17.3
B750	0.2	-	0.2	0.8	48.8	-	50.0	-
B835	0.2	-	0.2	0.9	48.5	-	50.2	-
B900	0.2	-	0.2	0.9	48.2	-	50.5	-
B1450	-	34.0	-	0.3	-	-	65.7	-
B1640	-	32.5	-	0.3	-	-	67.2	-
B1750	-	31.0	-	0.2	-	-	68.8	-
B1800	-	29.5	-	0.4	-	-	70.1	-
B1900	-	29.5	-	0.3	-	-	70.2	-
B2000	-	30.0	-	0.2	-	-	69.8	-
B2300	-	31.0	-	0.1	-	-	68.9	-
B2450	-	31.4	-	0.1	-	-	68.5	-
B2600	-	31.8	-	0.1	-	-	68.1	-
B3500	-	28.8	-	0.1	-	-	71.1	-
B5G	-	-	-	-	-	10.7	78.6	10.7

FCC SAR Test Report

3.3 SAR System Verification

The system check verifies that the system operates within its specifications. It is performed daily or before every SAR measurement. The system check uses normal SAR measurements in the flat section of the phantom with a matched dipole at a specified distance. The system verification setup is shown as below.

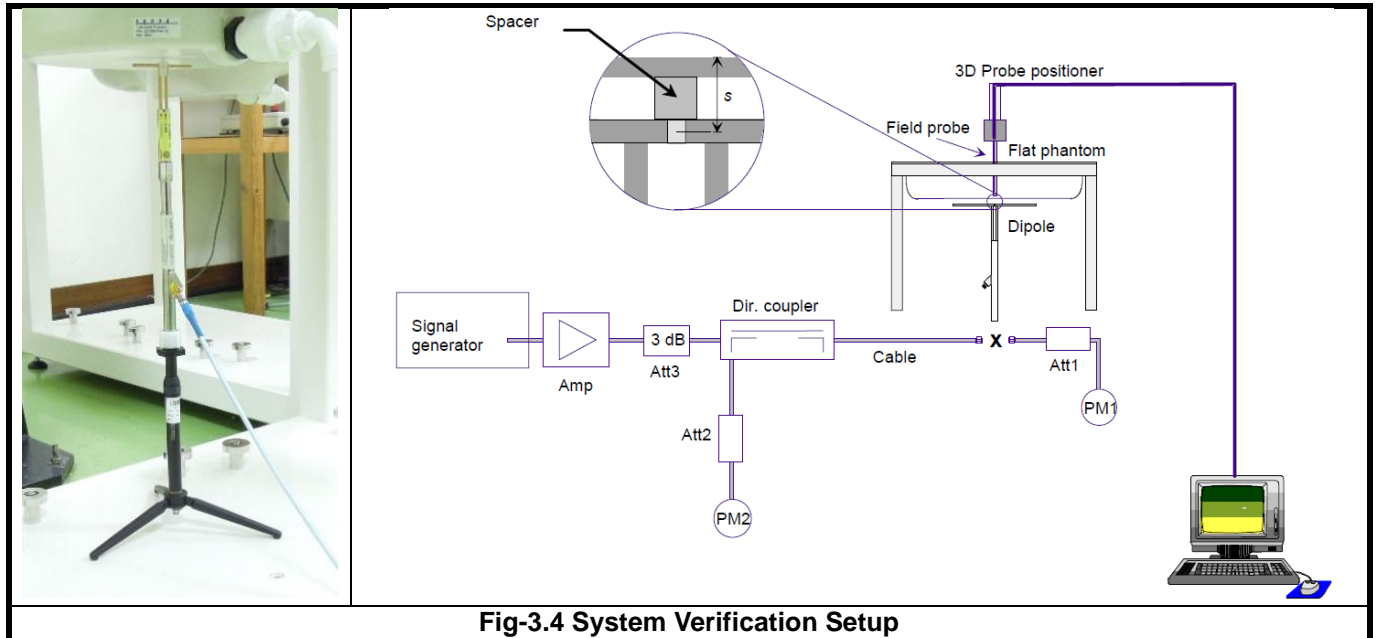

Fig-3.4 System Verification Setup

The validation dipole is placed beneath the flat phantom with the specific spacer in place. The distance spacer is touch the phantom surface with a light pressure at the reference marking and be oriented parallel to the long side of the phantom. The power meter PM1 measures the forward power at the location of the system check dipole connector. The signal generator is adjusted for the desired forward power (250 mW is used for 700 MHz to 3 GHz, 100 mW is used for 3.5 GHz to 6 GHz) at the dipole connector and the power meter PM2 is read at that level. After connecting the cable to the dipole, the signal generator is readjusted for the same reading at power meter PM2.

After system check testing, the SAR result will be normalized to 1W forward input power and compared with the reference SAR value derived from validation dipole certificate report. The deviation of system check should be within 10 %.

3.4 SAR Measurement Procedure

According to the SAR test standard, the recommended procedure for assessing the peak spatial-average SAR value consists of the following steps:

- (a) Power reference measurement
- (b) Area scan
- (c) Zoom scan
- (d) Power drift measurement

The SAR measurement procedures for each of test conditions are as follows:

- (a) Make EUT to transmit maximum output power
- (b) Measure conducted output power through RF cable
- (c) Place the EUT in the specific position of phantom
- (d) Perform SAR testing steps on the DASY system
- (e) Record the SAR value

3.4.1 Area & Zoom Scan Procedure

First Area Scan is used to locate the approximate location(s) of the local peak SAR value(s). The measurement grid within an Area Scan is defined by the grid extent, grid step size and grid offset. Next, in order to determine the EM field distribution in a three-dimensional spatial extension, Zoom Scan is required. The Zoom Scan is performed around the highest E-field value to determine the averaged SAR-distribution over 10 g. According to KDB 865664 D01 v01r03, the resolution for Area and Zoom scan is specified in the table below.

Items	<= 2 GHz	2-3 GHz	3-4 GHz	4-5 GHz	5-6 GHz
Area Scan ($\Delta x, \Delta y$)	<= 15 mm	<= 12 mm	<= 12 mm	<= 10 mm	<= 10 mm
Zoom Scan ($\Delta x, \Delta y$)	<= 8 mm	<= 5 mm	<= 5 mm	<= 4 mm	<= 4 mm
Zoom Scan (Δz)	<= 5 mm	<= 5 mm	<= 4 mm	<= 3 mm	<= 2 mm
Zoom Scan Volume	>= 30 mm	>= 30 mm	>= 28 mm	>= 25 mm	>= 22 mm

Note:

When zoom scan is required and report SAR is <= 1.4 W/kg, the zoom scan resolution of $\Delta x / \Delta y$ (2-3GHz: <= 8 mm, 3-4GHz: <= 7 mm, 4-6GHz: <= 5 mm) may be applied.

3.4.2 Volume Scan Procedure

The volume scan is used for assess overlapping SAR distributions for antennas transmitting in different frequency bands. It is equivalent to an oversized zoom scan used in standalone measurements. The measurement volume will be used to enclose all the simultaneous transmitting antennas. For antennas transmitting simultaneously in different frequency bands, the volume scan is measured separately in each frequency band. In order to sum correctly to compute the 1g aggregate SAR, the EUT remain in the same test position for all measurements and all volume scan use the same spatial resolution and grid spacing. When all volume scan were completed, the software, SEMCAD postprocessor can combine and subsequently superpose these measurement data to calculating the multiband SAR.

FCC SAR Test Report

3.4.3 Power Drift Monitoring

All SAR testing is under the EUT install full charged battery and transmit maximum output power. In DASY measurement software, the power reference measurement and power drift measurement procedures are used for monitoring the power drift of EUT during SAR test. Both these procedures measure the field at a specified reference position before and after the SAR testing. The software will calculate the field difference in dB. If the power drift more than 5%, the SAR will be retested.

3.4.4 Spatial Peak SAR Evaluation

The procedure for spatial peak SAR evaluation has been implemented according to the test standard. It can be conducted for 1g and 10g, as well as for user-specific masses. The DASY software includes all numerical procedures necessary to evaluate the spatial peak SAR value.

The base for the evaluation is a "cube" measurement. The measured volume must include the 1g and 10g cubes with the highest averaged SAR values. For that purpose, the center of the measured volume is aligned to the interpolated peak SAR value of a previously performed area scan.

The entire evaluation of the spatial peak values is performed within the post-processing engine (SEMCAD). The system always gives the maximum values for the 1g and 10g cubes. The algorithm to find the cube with highest averaged SAR is divided into the following stages:

- (a) Extraction of the measured data (grid and values) from the Zoom Scan
- (b) Calculation of the SAR value at every measurement point based on all stored data (A/D values and measurement parameters)
- (c) Generation of a high-resolution mesh within the measured volume
- (d) Interpolation of all measured values from the measurement grid to the high-resolution grid
- (e) Extrapolation of the entire 3-D field distribution to the phantom surface over the distance from sensor to surface
- (f) Calculation of the averaged SAR within masses of 1g and 10g

3.4.5 SAR Averaged Methods

In DASY, the interpolation and extrapolation are both based on the modified Quadratic Shepard's method. The interpolation scheme combines a least-square fitted function method and a weighted average method which are the two basic types of computational interpolation and approximation.

Extrapolation routines are used to obtain SAR values between the lowest measurement points and the inner phantom surface. The extrapolation distance is determined by the surface detection distance and the probe sensor offset. The uncertainty increases with the extrapolation distance. To keep the uncertainty within 1% for the 1 g and 10 g cubes, the extrapolation distance should not be larger than 5 mm.

4. SAR Measurement Evaluation

4.1 EUT Configuration and Setting

The EUT is a voice/data transmitter device that contains one WWAN transmitter (CDMA2000 / LTE), and two WWAN antennas (one is for CDMA/LTE B25&B26, and the other is for LTE B41). Confirming the LTE transmitter follows 3GPP standards, is category 3, FDD-LTE band 25 (BW 3/5/10 MHz), FDD-LTE band 26 (BW 1.4/3/5/10 MHz), TDD-LTE band 41 (BW 10/15/20 MHz), supports QPSK / 16QAM modulations, and supports data transmission only. Tested per 3GPP 36.521 maximum transmit procedures for both QPSK / 16QAM.

LTE Maximum Power Reduction in accordance with 3GPP 36.101: Power Reduction in accordance to 3GPP is active all times during LTE operation.

Modulation	Channel Bandwidth / RB Configurations						LTE MPR Setting (dB)
	BW 1.4 MHz	BW 3 MHz	BW 5 MHz	BW 10 MHz	BW 15 MHz	BW 20 MHz	
QPSK	> 5	> 4	> 8	> 12	> 16	> 18	1
16QAM	<= 5	<= 4	<= 8	<= 12	<= 16	<= 18	1
16QAM	> 5	> 4	> 8	> 12	> 16	> 18	2

Note: MPR is according to the standard and implemented in the circuit (mandatory).

In addition, the device is compliant with A-MPR requirements defined in 36.101 section 6.2.4 that may be required to meet 3GPP Adjacent Channel Leakage Ratio (“ACLR”) requirements. A-MPR was disabled for all FCC compliance testing.

The simultaneous transmission possibilities are listed as below.

Simultaneous TX Combination	Configuration	Head (Voice / VoIP)	Body Worn (Voice / VoIP)	Hotspot (Data)
1	CDMA2000 BC0 (Voice / Data) + WLAN (Data)	Yes	Yes	Yes
2	CDMA2000 BC1 (Voice / Data) + WLAN (Data)	Yes	Yes	Yes
3	CDMA2000 BC10 (Voice / Data) + WLAN (Data)	Yes	Yes	Yes
4	LTE 25 (Data) + WLAN (Data)	Yes	Yes	Yes
5	LTE 26 (Data) + WLAN (Data)	Yes	Yes	Yes
6	LTE 41 (Data) + WLAN (Data)	Yes	Yes	Yes
7	CDMA2000 BC0 (Voice / Data) + BT (Data)	No	Yes	No
8	CDMA2000 BC1 (Voice / Data) + BT (Data)	No	Yes	No
9	CDMA2000 BC10 (Voice / Data) + BT (Data)	No	Yes	No
10	LTE 25 (Data) + BT (Data)	No	Yes	No
11	LTE 26 (Data) + BT (Data)	No	Yes	No
12	LTE 41 (Data) + BT (Data)	No	Yes	No

Note :

1. CDMA/LTE B25&B26 and LTE B41 cannot transmit simultaneously.
2. WLAN and Bluetooth cannot transmit simultaneously.



FCC SAR Test Report

For WWAN SAR testing, the EUT was linked and controlled by base station emulator (Agilent E5515C is used for CDMA2000, and Anritsu MT8820C is used for LTE). Communication between the EUT and the emulator was established by air link. The distance between the EUT and the communicating antenna of the emulator is larger than 50 cm and the output power radiated from the emulator antenna is at least 30 dB smaller than the output power of EUT. The EUT was set from the emulator to radiate maximum output power during SAR testing.

For CDMA, SAR is tested under 1xRTT mode using RC3 with the EUT configured to transmit at full rate using Loopback Service Option SO55 on head position, and RC3 with the EUT configured using TDSO/SO32, to transmit at full rate on FCH with all other code channels disabled on body position. SAR for RC1 is not required when the maximum power is less than 1/4 dB higher than RC3. SAR for multiple code channels (FCH+SCH_n) is not required when the maximum power is less than 1/4 dB higher than that measured with FCH only. SAR for EVDO Rev.0 is not required when the maximum power is less than 1/4 dB higher than RC3 (1xRTT). SAR for EVDO Rev.A is not required when the maximum power is less than Rev.0 or less than 1/4 dB higher than RC3. The steps for system simulator (Agilent E5515C) setup are as below.

1. Set the System ID and Network ID
2. Set the Cell Band and connecting Channel
3. Set the power control to All Up Bits
4. Press "Originate Call" button

The hotspot SAR is tested under EVDO Rev.0 mode using Reverse Data Channel rate of 153.6 kbps in subtype 0/1 Physical Layer Configurations, and the power control set "All Up Bits". SAR for EVDO Rev.A is not required since its power is less than EVDO Rev.0. SAR for 1xRTT is not required since its power is less than 1/4 dB higher than EVDO Rev.0. The steps for system simulator (Agilent E5515C) setup are as below.

1. Set the Sector ID
2. Set the Protocol Release
3. Set the Cell Band and connecting Channel
4. Set the RTAP Rate
5. Set the power control
6. Press "Start Data Connection" button

FCC SAR Test Report

For LTE, set the related parameters of operating band, channel bandwidth, uplink channel number, modulation type, and RB in base station simulator. When the EUT has registered and communicated to base station simulator, set the simulator to make EUT transmitting the maximum radiated power. The steps for system simulator (Anritsu MT8820C) setup are as below.

1. Press the "Std" button to select "LTE 22.20S" function
2. Choose the "Screen Select" item to "Fundamental Measurement"
3. Enter the "Common" item
4. Set the Operating Band
5. Set the Channel Bandwidth
6. Set the UL Channel & Frequency
7. Set the Modulation
8. Set the RB number and RB shift
9. Press "Start Call" button when EUT register to the system simulator
10. Set the TX-1 Max. Power to make the EUT transmit maximum output power

In addition, the TDD-LTE for this device supports Uplink-Downlink configuration 0 only. Therefore, SAR is tested with fixed periodic duty at the highest duty factor using Uplink-Downlink configuration 0 with special sub-frame configuration 5 per KDB 941225 D05 and 3GPP TS 36.211.

For WLAN SAR testing, the EUT has installed WLAN engineering testing software which can provide continuous transmitting RF signal. According to KDB 248227 D01, WLAN SAR should tested at the lowest data rate, and testing at higher data rate is not required when the maximum average output power is less than 1/4 dB higher than those measured at the lowest data rate. Since the WLAN power at lowest data rate has highest output power, WLAN SAR for this device was performed at the lowest data rate as set in 1 Mbps for 802.11b.

4.2 EUT Testing Position

According to KDB 648474 D04, handsets are tested for SAR compliance in head, body-worn accessory and other use configurations described in the following subsections.

4.2.1 Head Exposure Conditions

Head exposure is limited to next to the ear voice mode operations. Head SAR compliance is tested according to the test positions defined in IEEE Std 1528-2003 using the SAM phantom illustrated as below.

1. Define two imaginary lines on the handset
 - (a) The vertical centerline passes through two points on the front side of the handset - the midpoint of the width w_t of the handset at the level of the acoustic output, and the midpoint of the width w_b of the bottom of the handset.
 - (b) The horizontal line is perpendicular to the vertical centerline and passes through the center of the acoustic output. The horizontal line is also tangential to the face of the handset at point A.
 - (c) The two lines intersect at point A. Note that for many handsets, point A coincides with the center of the acoustic output; however, the acoustic output may be located elsewhere on the horizontal line. Also note that the vertical centerline is not necessarily parallel to the front face of the handset, especially for clamshell handsets, handsets with flip covers, and other irregularly shaped handsets.

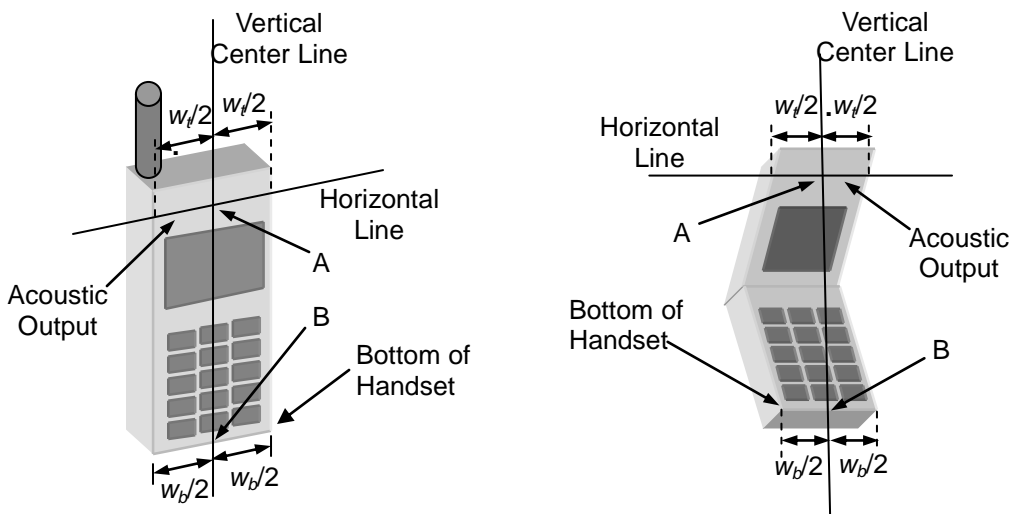

Fig-4.1 Illustration for Handset Vertical and Horizontal Reference Lines

FCC SAR Test Report

2. Cheek Position

- (a) To position the device with the vertical center line of the body of the device and the horizontal line crossing the center piece in a plane parallel to the sagittal plane of the phantom. While maintaining the device in this plane, align the vertical center line with the reference plane containing the three ear and mouth reference point (M: Mouth, RE: Right Ear, and LE: Left Ear) and align the center of the ear piece with the line RE-LE.
- (b) To move the device towards the phantom with the ear piece aligned with the line LE-RE until the phone touched the ear. While maintaining the device in the reference plane and maintaining the phone contact with the ear, move the bottom of the phone until any point on the front side is in contact with the cheek of the phantom or until contact with the ear is lost (see Fig-4.2).

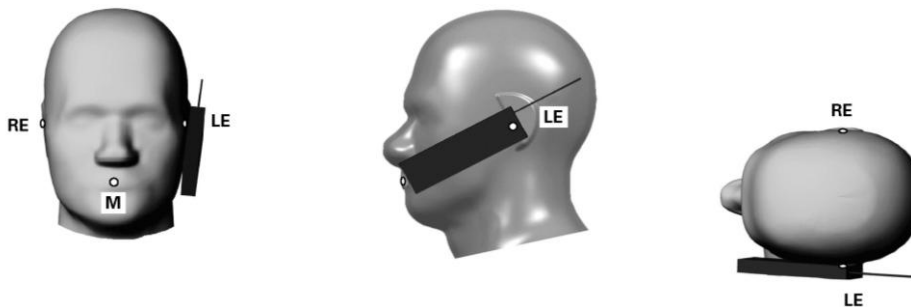

Fig-4.2 Illustration for Cheek Position

3. Tilted Position

- (a) To position the device in the "cheek" position described above.
- (b) While maintaining the device the reference plane described above and pivoting against the ear, moves it outward away from the mouth by an angle of 15 degrees or until contact with the ear is lost (see Fig-4.3).

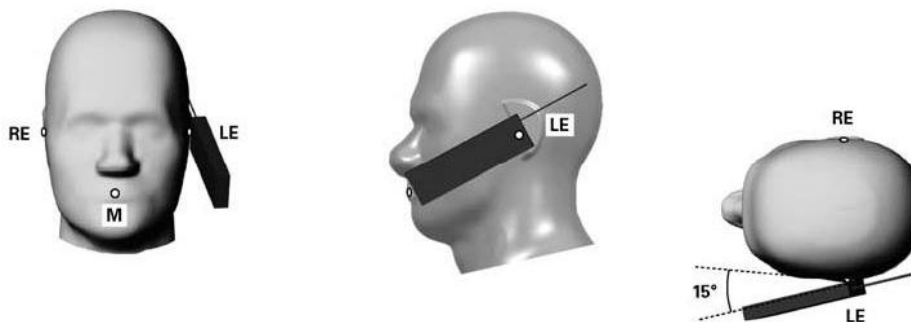

Fig-4.3 Illustration for Tilted Position

4.2.2 Body-Worn Accessory Exposure Conditions

Body-worn accessory exposure is typically related to voice mode operations when handsets are carried in body-worn accessories. The body-worn accessory procedures in KDB 447498 D01 are used to test for body-worn accessory SAR compliance, without a headset connected to it. This enables the test results for such configuration to be compatible with that required for hotspot mode when the body-worn accessory test separation distance is greater than or equal to that required for hotspot mode. When the reported SAR for a body-worn accessory, measured without a headset connected to the handset, is $> 1.2 \text{ W/kg}$, the highest reported SAR configuration for that wireless mode and frequency band should be repeated for that body-worn accessory with a headset attached to the handset.

Body-worn accessories that do not contain metallic or conductive components may be tested according to worst-case exposure configurations, typically according to the smallest test separation distance required for the group of body-worn accessories with similar operating and exposure characteristics. All body-worn accessories containing metallic components are tested in conjunction with the host device.

Body-worn accessory SAR compliance is based on a single minimum test separation distance for all wireless and operating modes applicable to each body-worn accessory used by the host, and according to the relevant voice and/or data mode transmissions and operations. If a body-worn accessory supports voice only operations in its normal and expected use conditions, testing of data mode for body-worn compliance is not required.

A conservative minimum test separation distance for supporting off-the-shelf body-worn accessories that may be acquired by users of consumer handsets is used to test for body-worn accessory SAR compliance. This distance is determined by the handset manufacturer, according to the requirements of Supplement C 01-01. Devices that are designed to operate on the body of users using lanyards and straps, or without requiring additional body-worn accessories, will be tested using a conservative minimum test separation distance $\leq 5 \text{ mm}$ to support compliance.

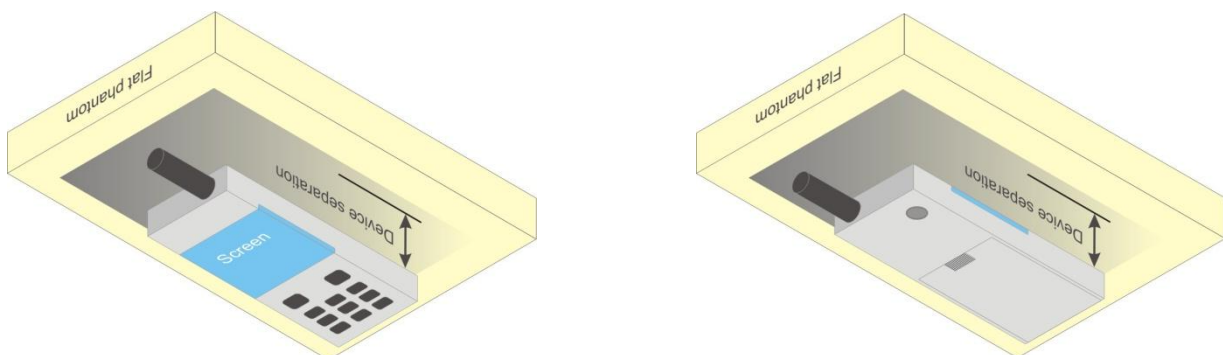
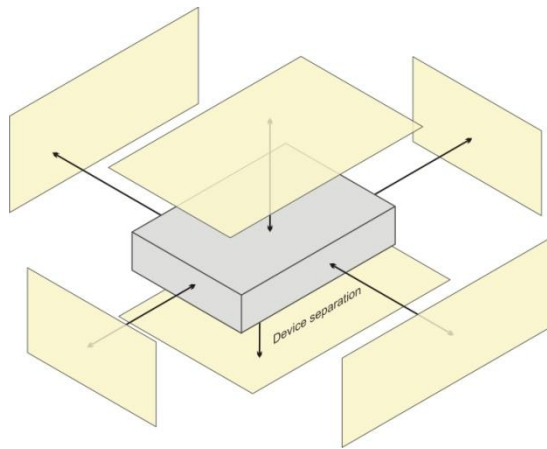

Fig-4.4 Illustration for Body Worn Position

FCC SAR Test Report

4.2.3 Hotspot Mode Exposure conditions

For handsets that support hotspot mode operations, with wireless router capabilities and various web browsing functions, the relevant hand and body exposure conditions are tested according to the hotspot SAR procedures in KDB 941225 D06. A test separation distance of 10 mm is required between the phantom and all surfaces and edges with a transmitting antenna located within 25 mm from that surface or edge. When the form factor of a handset is smaller than 9 cm x 5 cm, a test separation distance of 5 mm (instead of 10 mm) is required for testing hotspot mode. When the separation distance required for body-worn accessory testing is larger than or equal to that tested for hotspot mode, in the same wireless mode and for the same surface of the phone, the hotspot mode SAR data may be used to support body-worn accessory SAR compliance for that particular configuration (surface).



Based on the antenna location shown on appendix D, the SAR testing required for hotspot mode is listed as below.

Antenna	Front Face	Rear Face	Left Side	Right Side	Top Side	Bottom Side
CDMA / LTE B25&B26	V	V	V	V	-	V
LTE B41	V	V	-	V	-	V
WLAN / BT	V	V	-	V	-	-

4.2.4 SAR Test Exclusions

According to KDB 447498 D01, the SAR test exclusion condition is based on source-based time-averaged maximum conducted output power, adjusted for tune-up tolerance, and the minimum test separation distance required for the exposure conditions. The SAR exclusion threshold is determined by the following formula.

$$\frac{\text{Max. Tune up Power}_{(mW)}}{\text{Min. Test Separation Distance}_{(mm)}} \times \sqrt{f_{(GHz)}} \leq 3.0 \text{ for SAR-1g}, \leq 7.5 \text{ for SAR-10g}$$

When the minimum test separation distance is < 5 mm, a distance of 5 mm is applied to determine SAR test exclusion.

Mode	Max. Tune-up Power (dBm)	Max. Tune-up Power (mW)	Body-Worn		
			Ant. to Surface (mm)	Calculated Result	Require SAR Testing?
BT	2.0	3	10	0.3	No

FCC SAR Test Report

4.3 Tissue Verification

The measuring results for tissue simulating liquid are shown as below.

Test Date	Tissue Type	Frequency (MHz)	Liquid Temp. (°C)	Measured Conductivity (σ)	Measured Permittivity (ϵ_r)	Target Conductivity (σ)	Target Permittivity (ϵ_r)	Conductivity Deviation (%)	Permittivity Deviation (%)
Dec. 08, 2013	Head	835	20.5	0.888	42.835	0.90	41.5	-1.33	3.22
Dec. 06, 2013	Head	1900	20.7	1.406	39.596	1.40	40.0	0.43	-1.01
Dec. 08, 2013	Head	2450	20.6	1.887	38.789	1.80	39.2	4.83	-1.05
Dec. 07, 2013	Head	2600	21.2	2.049	37.739	1.96	39.0	4.54	-3.23
Dec. 09, 2013	Body	835	20.8	0.972	54.017	0.97	55.2	0.21	-2.14
Dec. 13, 2013	Body	835	20.8	0.973	54.214	0.97	55.2	0.31	-1.79
Dec. 09, 2013	Body	1900	20.7	1.552	52.952	1.52	53.3	2.11	-0.65
Dec. 13, 2013	Body	1900	21.6	1.553	53.382	1.52	53.3	2.17	0.15
Dec. 13, 2013	Body	2450	20.3	1.972	51.404	1.95	52.7	1.13	-2.46
Dec. 10, 2013	Body	2600	20.2	2.196	52.352	2.16	52.5	1.67	-0.28

Note:

The dielectric properties of the tissue simulating liquid must be measured within 24 hours before the SAR testing and within $\pm 5\%$ of the target values. Liquid temperature during the SAR testing must be within $\pm 2^\circ\text{C}$.

4.4 System Validation

The SAR measurement system was validated according to procedures in KDB 865664 D01 v01r01. The validation status in tabulated summary is as below.

Test Date	Probe S/N	Calibration Point		Measured Conductivity (σ)	Measured Permittivity (ϵ_r)	Validation for CW			Validation for Modulation		
						Sensitivity Range	Probe Linearity	Probe Isotropy	Modulation Type	Duty Factor	PAR
Dec. 08, 2013	3650	Head	835	0.888	42.835	Pass	Pass	Pass	N/A	N/A	N/A
Dec. 06, 2013	3650	Head	1900	1.406	39.596	Pass	Pass	Pass	N/A	N/A	N/A
Dec. 08, 2013	3650	Head	2450	1.887	38.789	Pass	Pass	Pass	OFDM	N/A	Pass
Dec. 07, 2013	3650	Head	2600	2.049	37.739	Pass	Pass	Pass	N/A	N/A	N/A
Dec. 09, 2013	3650	Body	835	0.972	54.017	Pass	Pass	Pass	N/A	N/A	N/A
Dec. 13, 2013	3590	Body	835	0.973	54.214	Pass	Pass	Pass	N/A	N/A	N/A
Dec. 09, 2013	3650	Body	1900	1.552	52.952	Pass	Pass	Pass	N/A	N/A	N/A
Dec. 13, 2013	3590	Body	1900	1.553	53.382	Pass	Pass	Pass	N/A	N/A	N/A
Dec. 13, 2013	3650	Body	2450	1.972	51.404	Pass	Pass	Pass	OFDM	N/A	Pass
Dec. 10, 2013	3650	Body	2600	2.196	52.352	Pass	Pass	Pass	N/A	N/A	N/A



FCC SAR Test Report

4.5 System Verification

The measuring result for system verification is tabulated as below.

Test Date	Mode	Frequency (MHz)	1W Target SAR-1g (W/kg)	Measured SAR-1g (W/kg)	Normalized to 1W SAR-1g (W/kg)	Deviation (%)	Dipole S/N	Probe S/N	DAE S/N
Dec. 08, 2013	Head	835	9.68	2.29	9.16	-5.37	4d121	3650	360
Dec. 06, 2013	Head	1900	40.60	10.10	40.40	-0.49	5d036	3650	360
Dec. 08, 2013	Head	2450	52.50	13.60	54.40	3.62	737	3650	360
Dec. 07, 2013	Head	2600	57.80	15.00	60.00	3.81	1020	3650	360
Dec. 09, 2013	Body	835	9.69	2.49	9.96	2.79	4d121	3650	360
Dec. 13, 2013	Body	835	9.69	2.34	9.36	-3.41	4d121	3590	861
Dec. 09, 2013	Body	1900	41.00	10.20	40.80	-0.49	5d036	3650	360
Dec. 13, 2013	Body	1900	41.00	9.44	37.76	-7.90	5d036	3590	861
Dec. 13, 2013	Body	2450	49.60	13.20	52.80	6.45	737	3650	360
Dec. 10, 2013	Body	2600	55.80	12.90	51.60	-7.53	1020	3650	360

Note:

Comparing to the reference SAR value provided by SPEAG, the validation data should be within its specification of 10 %. The result indicates the system check can meet the variation criterion and the plots can be referred to Appendix A of this report.

4.6 Maximum Output Power

4.6.1 Maximum Conducted Power

The maximum conducted average power (Unit: dBm) including tune-up tolerance is shown as below.

Mode	CDMA BC0	CDMA BC1	CDMA BC10
1xRTT / EVDO	25.2	25.2	25.2

Mode	LTE 25	LTE 26	LTE 41
QPSK / 16QAM	24.2	23.7	24.2

Mode	2.4G WLAN
802.11b	17.5
802.11g	17.0
802.11n HT20	17.0

Mode	Bluetooth
All	2.0

FCC SAR Test Report

4.6.2 Measured Conducted Power Result

The measuring conducted average power (Unit: dBm) is shown as below.

Band Channel	CDMA BC0			CDMA BC1		
	1013	384	777	25	600	1175
Frequency (MHz)	824.70	836.52	848.31	1851.25	1880.00	1908.75
1xRTT RC1+SO55	24.57	24.65	24.48	24.87	24.71	24.31
1xRTT RC3+SO55	24.59	24.67	24.50	24.88	24.72	24.32
1xRTT RC3+SO32 (FCH)	24.52	24.60	24.43	24.83	24.67	24.27
1xRTT RC3+SO32 (SCH)	24.53	24.61	24.44	24.84	24.68	24.28
1xEVDO Rev.0 RTAP 153.6	24.54	24.62	24.45	24.86	24.70	24.30
1xEVDO Rev.A RETAP 4096	24.51	24.59	24.42	24.82	24.66	24.26

Band Channel	CDMA BC10		
	476	580	684
Frequency (MHz)	817.9	820.5	823.1
1xRTT RC1+SO55	24.51	24.58	24.54
1xRTT RC3+SO55	24.54	24.61	24.57
1xRTT RC3+SO32 (FCH)	24.46	24.53	24.49
1xRTT RC3+SO32 (SCH)	24.47	24.54	24.50
1xEVDO Rev.0 RTAP 153.6	24.50	24.57	24.53
1xEVDO Rev.A RETAP 4096	24.45	24.52	24.48

Band / BW	Modulation	RB Size	RB Offset	Low CH 26055	Mid CH 26365	High CH 26675	3GPP MPR (dB)
				Frequency 1851.5 MHz	Frequency 1882.5 MHz	Frequency 1913.5 MHz	
25 / 3M	QPSK	1	0	23.30	23.17	23.31	0
		1	7	23.16	22.98	23.22	0
		1	14	23.06	23.01	23.16	0
		8	0	22.31	22.28	22.39	1
		8	3	22.26	22.08	22.30	1
		8	7	22.18	22.16	22.23	1
		15	0	22.26	22.12	22.29	1
	16QAM	1	0	22.20	22.07	22.21	1
		1	7	22.06	21.88	22.12	1
		1	14	21.96	21.91	22.06	1
		8	0	21.21	21.18	21.39	2
		8	3	21.16	20.98	21.20	2
		8	7	21.08	21.06	21.13	2
		15	0	21.16	21.02	21.19	2



FCC SAR Test Report

Band / BW	Modulation	RB Size	RB Offset	Low CH 26065	Mid CH 26365	High CH 26665	3GPP MPR (dB)
				Frequency 1852.5 MHz	Frequency 1882.5 MHz	Frequency 1912.5 MHz	
25 / 5M	QPSK	1	0	23.33	23.20	23.34	0
		1	12	23.19	23.01	23.25	0
		1	24	23.09	23.04	23.19	0
		12	0	22.34	22.31	22.32	1
		12	6	22.29	22.11	22.33	1
		12	13	22.21	22.19	22.26	1
		25	0	22.29	22.15	22.32	1
	16QAM	1	0	22.23	22.10	22.24	1
		1	12	22.09	21.91	22.15	1
		1	24	21.99	21.94	22.09	1
		12	0	21.24	21.21	21.40	2
		12	6	21.19	21.01	21.23	2
		12	13	21.11	21.09	21.16	2
		25	0	21.19	21.05	21.22	2

Band / BW	Modulation	RB Size	RB Offset	Low CH 26090	Mid CH 26365	High CH 26640	3GPP MPR (dB)
				Frequency 1855.0 MHz	Frequency 1882.5 MHz	Frequency 1910.0 MHz	
25 / 10M	QPSK	1	0	23.37	23.24	23.38	0
		1	24	23.23	23.05	23.29	0
		1	49	23.13	23.08	23.23	0
		25	0	22.38	22.35	22.39	1
		25	12	22.33	22.15	22.37	1
		25	25	22.25	22.23	22.30	1
		50	0	22.33	22.19	22.36	1
	16QAM	1	0	22.27	22.14	22.28	1
		1	24	22.13	21.95	22.19	1
		1	49	22.03	21.98	22.13	1
		25	0	21.28	21.25	21.40	2
		25	12	21.23	21.05	21.27	2
		25	25	21.15	21.13	21.20	2
		50	0	21.23	21.09	21.26	2

Band / BW	Modulation	RB Size	RB Offset	Low CH 26697	Mid CH 26865	High CH 27033	3GPP MPR (dB)
				Frequency 814.7 MHz	Frequency 831.0 MHz	Frequency 848.3 MHz	
26 / 1.4M	QPSK	1	0	22.53	22.55	23.08	0
		1	2	22.61	22.99	23.24	0
		1	5	22.69	22.71	23.21	0
		3	0	22.58	22.60	23.10	0
		3	1	22.47	22.49	22.99	0
		3	3	22.41	22.42	22.88	0
		6	0	21.69	22.01	22.06	1
	16QAM	1	0	21.46	21.48	22.01	1
		1	2	21.54	21.92	21.57	1
		1	5	21.62	21.64	22.14	1
		3	0	21.51	21.53	22.07	1
		3	1	21.41	21.42	22.00	1
		3	3	21.48	21.51	21.93	1
		6	0	20.62	20.94	20.99	2



FCC SAR Test Report

A D T

Band / BW	Modulation	RB Size	RB Offset	Low CH 26705	Mid CH 26865	High CH 27025	3GPP MPR (dB)
				Frequency 815.5 MHz	Frequency 831.0 MHz	Frequency 847.5 MHz	
26 / 3M	QPSK	1	0	22.53	22.55	23.10	0
		1	7	22.61	22.99	23.26	0
		1	14	22.69	22.71	23.23	0
		8	0	21.79	21.81	22.27	1
		8	3	21.65	22.10	22.14	1
		8	7	21.71	21.94	22.33	1
		15	0	21.69	22.01	22.08	1
	16QAM	1	0	21.46	21.48	22.03	1
		1	7	21.54	21.92	22.19	1
		1	14	21.62	21.64	22.16	1
		8	0	20.72	20.74	21.20	2
		8	3	20.58	21.03	21.07	2
		8	7	20.64	20.87	21.26	2
		15	0	20.62	20.94	21.01	2

Band / BW	Modulation	RB Size	RB Offset	Low CH 26715	Mid CH 26865	High CH 27015	3GPP MPR (dB)
				Frequency 816.5 MHz	Frequency 831.0 MHz	Frequency 846.5 MHz	
26 / 5M	QPSK	1	0	22.54	22.56	23.13	0
		1	12	22.62	23.00	23.29	0
		1	24	22.70	22.72	23.26	0
		12	0	21.80	21.82	22.30	1
		12	6	21.66	22.11	22.17	1
		12	13	21.72	21.95	22.36	1
		25	0	21.70	22.02	22.11	1
	16QAM	1	0	21.47	21.49	22.06	1
		1	12	21.55	21.93	22.22	1
		1	24	21.63	21.65	22.19	1
		12	0	20.73	20.75	21.23	2
		12	6	20.59	21.04	21.10	2
		12	13	20.65	20.88	21.29	2
		25	0	20.63	20.95	21.04	2

Band / BW	Modulation	RB Size	RB Offset	Low CH 26740	Mid CH 26865	High CH 26990	3GPP MPR (dB)
				Frequency 819.0 MHz	Frequency 831.0 MHz	Frequency 844.0 MHz	
26 / 10M	QPSK	1	0	22.55	22.57	23.17	0
		1	24	22.63	23.01	23.33	0
		1	49	22.71	22.73	23.30	0
		25	0	21.81	21.83	22.34	1
		25	12	21.67	22.12	22.21	1
		25	25	21.73	21.96	22.40	1
		50	0	21.71	22.03	22.15	1
	16QAM	1	0	21.48	21.50	22.10	1
		1	24	21.56	21.94	22.26	1
		1	49	21.64	21.66	22.23	1
		25	0	20.74	20.76	21.27	2
		25	12	20.60	21.05	21.14	2
		25	25	20.66	20.89	21.33	2
		50	0	20.64	20.96	21.08	2



FCC SAR Test Report

Band / BW	Modulation	RB Size	RB Offset	Low CH	Mid CH	Mid CH	Mid CH	High CH	3PGG MPR (dB)
				39700	40160	40620	41080	41540	
				Frequency	Frequency	Frequency	Frequency	Frequency	
				2501.0 MHz	2547.0 MHz	2593.0 MHz	2639.0 MHz	2685.0 MHz	
41 / 10M	QPSK	1	0	23.21	23.19	23.29	23.59	23.25	0
		1	24	23.45	23.38	23.67	23.98	23.65	0
		1	49	23.21	23.13	23.48	23.54	23.23	0
		25	0	22.46	22.34	22.76	22.82	22.51	1
		25	12	22.40	22.34	22.78	22.88	22.75	1
		25	25	22.53	22.37	22.76	22.89	22.74	1
		50	0	22.44	22.38	22.78	22.80	22.75	1
	16QAM	1	0	22.16	22.14	22.24	22.54	22.20	1
		1	24	22.40	22.33	22.62	22.93	22.60	1
		1	49	22.16	22.11	22.43	22.49	22.18	1
		25	0	21.41	21.29	21.71	21.77	21.46	2
		25	12	21.35	21.29	21.73	21.83	21.70	2
		25	25	21.48	21.32	21.71	21.84	21.69	2
		50	0	21.39	21.33	21.73	21.75	21.70	2

Band / BW	Modulation	RB Size	RB Offset	Low CH	Mid CH	Mid CH	Mid CH	High CH	3PGG MPR (dB)
				39725	40173	40620	41068	41515	
				Frequency	Frequency	Frequency	Frequency	Frequency	
				2503.5 MHz	2548.3 MHz	2593.0 MHz	2637.8 MHz	2682.5 MHz	
41 / 15M	QPSK	1	0	23.23	23.21	23.31	23.61	23.27	0
		1	37	23.47	23.40	23.69	24.00	23.67	0
		1	74	23.23	23.15	23.50	23.56	23.25	0
		36	0	22.48	22.36	22.78	22.84	22.53	1
		36	19	22.42	22.36	22.80	22.90	22.77	1
		36	39	22.55	22.39	22.78	22.91	22.76	1
		75	0	22.46	22.40	22.80	22.82	22.77	1
	16QAM	1	0	22.18	22.16	22.26	22.56	22.22	1
		1	37	22.42	22.35	22.64	22.95	22.62	1
		1	74	22.18	22.14	22.45	22.51	22.20	1
		36	0	21.43	21.31	21.73	21.79	21.48	2
		36	19	21.37	21.31	21.75	21.85	21.72	2
		36	39	21.50	21.34	21.73	21.86	21.71	2
		75	0	21.41	21.35	21.75	21.77	21.72	2

Band / BW	Modulation	RB Size	RB Offset	Low CH	Mid CH	Mid CH	Mid CH	High CH	3PGG MPR (dB)
				39750	40185	40620	41055	41490	
				Frequency	Frequency	Frequency	Frequency	Frequency	
				2506.0 MHz	2549.5 MHz	2593.0 MHz	2636.5 MHz	2680.0 MHz	
41 / 20M	QPSK	1	0	23.30	23.28	23.38	23.68	23.34	0
		1	50	23.54	23.47	23.76	24.07	23.74	0
		1	99	23.30	23.22	23.57	23.63	23.32	0
		50	0	22.55	22.43	22.85	22.91	22.60	1
		50	25	22.49	22.43	22.87	22.97	22.84	1
		50	50	22.62	22.46	22.85	22.98	22.83	1
		100	0	22.53	22.47	22.87	22.89	22.84	1
	16QAM	1	0	22.25	22.23	22.33	22.63	22.29	1
		1	50	22.49	22.42	22.71	23.02	22.69	1
		1	99	22.25	22.17	22.52	22.58	22.27	1
		50	0	21.50	21.38	21.80	21.86	21.55	2
		50	25	21.44	21.38	21.82	21.92	21.79	2
		50	50	21.57	21.41	21.80	21.93	21.78	2
		100	0	21.48	21.42	21.82	21.84	21.79	2



FCC SAR Test Report

<WLAN 2.4G>

Mode		802.11b		
Channel / Frequency (MHz)		1 (2412)	6 (2437)	11 (2462)
Average Power		15.61	17.25	16.52
Mode		802.11g		
Channel / Frequency (MHz)		1 (2412)	6 (2437)	11 (2462)
Average Power		13.77	16.94	14.77
Mode		802.11n (HT20)		
Channel / Frequency (MHz)		1 (2412)	6 (2437)	11 (2462)
Average Power		13.75	16.95	14.74

4.7 SAR Testing Results

4.7.1 SAR Results for Head

Plot No.	Band	Mode	Test Position	Ch.	Max. Tune-up Power (dBm)	Measured Conducted Power (dBm)	Scaling Factor	Power Drift (dB)	Measured SAR-1g (W/kg)	Scaled SAR-1g (W/kg)
01	CDMA BC0	RC3+SO55	Right Cheek	384	25.2	24.67	1.13	-0.01	0.323	0.36
	CDMA BC0	RC3+SO55	Right Tilted	384	25.2	24.67	1.13	0.08	0.321	0.36
	CDMA BC0	RC3+SO55	Left Cheek	384	25.2	24.67	1.13	0.12	0.413	0.47
	CDMA BC0	RC3+SO55	Left Tilted	384	25.2	24.67	1.13	-0.02	0.316	0.36
02	CDMA BC1	RC3+SO55	Right Cheek	25	25.2	24.88	1.08	0.02	0.56	0.60
	CDMA BC1	RC3+SO55	Right Tilted	25	25.2	24.88	1.08	-0.04	0.397	0.43
	CDMA BC1	RC3+SO55	Left Cheek	25	25.2	24.88	1.08	0.13	0.745	0.80
	CDMA BC1	RC3+SO55	Left Tilted	25	25.2	24.88	1.08	0.04	0.378	0.41
03	CDMA BC1	RC3+SO55	Left Cheek	600	25.2	24.72	1.12	0.05	0.55	0.61
	CDMA BC1	RC3+SO55	Left Cheek	1175	25.2	24.32	1.22	0.08	0.426	0.52
	CDMA BC10	RC3+SO55	Right Cheek	580	25.2	24.61	1.15	-0.15	0.323	0.37
	CDMA BC10	RC3+SO55	Right Tilted	580	25.2	24.61	1.15	0.05	0.312	0.36
07	CDMA BC10	RC3+SO55	Left Cheek	580	25.2	24.61	1.15	0.08	0.393	0.45
	CDMA BC10	RC3+SO55	Left Tilted	580	25.2	24.61	1.15	0.04	0.313	0.36
	802.11b	-	Right Cheek	6	17.5	17.25	1.06	0.03	0.057	0.06
	802.11b	-	Right Tilted	6	17.5	17.25	1.06	0.08	0.026	0.03
07	802.11b	-	Left Cheek	6	17.5	17.25	1.06	0.06	0.141	0.15
	802.11b	-	Left Tilted	6	17.5	17.25	1.06	0.07	0.055	0.06

Note:

- SAR is performed on the highest power channel. When the reported SAR value of highest power channel is <= 0.8 W/kg, SAR testing for optional channel is not required.
- According to KDB 248227, when the extrapolated maximum peak SAR for the maximum output power channel is <= 1.6 W/kg and the 1g averaged SAR is <= 0.8 W/kg, WLAN SAR testing for other channels is not required.
- SAR testing for 802.11g/n is not required when its maximum power is less than 1/4 dB higher than 802.11b.



FCC SAR Test Report

Plot No.	Band	Mode	Test Position	Ch.	RB#	RB Offset	Max. Tune-up Power (dBm)	Measured Conducted Power (dBm)	Scaling Factor	Power Drift (dB)	Measured SAR-1g (W/kg)	Scaled SAR-1g (W/kg)
	LTE 25	QPSK10M	Right Cheek	26640	1	0	24.2	23.38	1.21	0.09	0.267	0.32
	LTE 25	QPSK10M	Right Tilted	26640	1	0	24.2	23.38	1.21	0.08	0.219	0.26
04	LTE 25	QPSK10M	Left Cheek	26640	1	0	24.2	23.38	1.21	0.06	0.474	0.57
	LTE 25	QPSK10M	Left Tilted	26640	1	0	24.2	23.38	1.21	0.12	0.293	0.35
	LTE 25	QPSK10M	Right Cheek	26640	25	0	23.2	22.39	1.21	-0.13	0.201	0.24
	LTE 25	QPSK10M	Right Tilted	26640	25	0	23.2	22.39	1.21	0.17	0.146	0.18
	LTE 25	QPSK10M	Left Cheek	26640	25	0	23.2	22.39	1.21	-0.08	0.352	0.42
	LTE 25	QPSK10M	Left Tilted	26640	25	0	23.2	22.39	1.21	-0.01	0.179	0.22
	LTE 26	QPSK10M	Right Cheek	26990	1	24	23.7	23.33	1.09	0.03	0.251	0.27
	LTE 26	QPSK10M	Right Tilted	26990	1	24	23.7	23.33	1.09	0.01	0.246	0.27
05	LTE 26	QPSK10M	Left Cheek	26990	1	24	23.7	23.33	1.09	-0.04	0.328	0.36
	LTE 26	QPSK10M	Left Tilted	26990	1	24	23.7	23.33	1.09	0.01	0.257	0.28
	LTE 26	QPSK10M	Right Cheek	26990	25	25	22.7	22.40	1.07	0.15	0.189	0.20
	LTE 26	QPSK10M	Right Tilted	26990	25	25	22.7	22.40	1.07	0.07	0.181	0.19
	LTE 26	QPSK10M	Left Cheek	26990	25	25	22.7	22.40	1.07	0.01	0.244	0.26
	LTE 26	QPSK10M	Left Tilted	26990	25	25	22.7	22.40	1.07	0.12	0.19	0.20
	LTE 41	QPSK20M	Right Cheek	41055	1	50	24.2	24.07	1.03	0.08	1.14	1.17
	LTE 41	QPSK20M	Right Tilted	41055	1	50	24.2	24.07	1.03	-0.15	0.239	0.25
	LTE 41	QPSK20M	Left Cheek	41055	1	50	24.2	24.07	1.03	0.05	0.494	0.51
	LTE 41	QPSK20M	Left Tilted	41055	1	50	24.2	24.07	1.03	0.10	0.274	0.28
	LTE 41	QPSK20M	Right Cheek	41055	50	50	23.2	22.98	1.05	0.04	0.919	0.97
	LTE 41	QPSK20M	Right Tilted	41055	50	50	23.2	22.98	1.05	0.16	0.192	0.20
	LTE 41	QPSK20M	Left Cheek	41055	50	50	23.2	22.98	1.05	0.07	0.41	0.43
	LTE 41	QPSK20M	Left Tilted	41055	50	50	23.2	22.98	1.05	0.05	0.228	0.24
	LTE 41	QPSK20M	Right Cheek	39750	1	50	24.2	23.54	1.16	0.18	0.919	1.07
	LTE 41	QPSK20M	Right Cheek	40185	1	50	24.2	23.47	1.18	0.04	0.904	1.07
	LTE 41	QPSK20M	Right Cheek	40620	1	50	24.2	23.76	1.11	0.07	0.916	1.01
06	LTE 41	QPSK20M	Right Cheek	41490	1	50	24.2	23.74	1.11	0.14	1.16	1.29
	LTE 41	QPSK20M	Right Cheek	39750	50	50	23.2	22.62	1.14	0.18	0.731	0.84
	LTE 41	QPSK20M	Right Cheek	40185	50	50	23.2	22.46	1.19	0.14	0.724	0.86
	LTE 41	QPSK20M	Right Cheek	40620	50	50	23.2	22.85	1.08	0.01	0.732	0.79
	LTE 41	QPSK20M	Right Cheek	41490	50	50	23.2	22.83	1.09	0.07	0.989	1.08
	LTE 41	QPSK20M	Right Cheek	41055	100	0	23.2	22.89	1.07	0.03	0.912	0.98
	LTE 41	QPSK20M	Right Cheek	41490	1	50	24.2	23.74	1.14	0.08	1.14	1.27

Note:

1. According to KDB 941225, LTE SAR testing for remaining RB offset configurations and required test channels is not required when the reported SAR of highest power 1RB configuration is less than 0.8 W/kg.
2. According to KDB 941225, LTE SAR testing for remaining RB offset configurations and required test channels is not required when the reported SAR of highest power 50% RB configuration is less than 0.8 W/kg.
3. According to KDB 941225, LTE SAR testing for 100% RB is not required when the maximum power of 100% RB is less than the maximum power of 1RB and 50% RB, and the highest reported SAR for 1RB and 50% RB is less than 0.8 W/kg.
4. According to KDB 941225, LTE SAR testing for 16QAM is not required when the maximum power of 16QAM is less 1/2 dB higher than QPSK, and the highest reported SAR of QPSK is less than 1.45 W/kg.
5. According to KDB 941225, LTE SAR testing for smaller channel bandwidth is not required when the maximum power of smaller channel bandwidth is less 1/2 dB higher than largest channel bandwidth, and the highest reported SAR of largest channel bandwidth is less than 1.45 W/kg.



FCC SAR Test Report

4.7.2 SAR Results for Body-Worn (Separation Distance is 1.0 cm Gap)

Plot No.	Band	Mode	Test Position	Ch.	Max. Tune-up Power (dBm)	Measured Conducted Power (dBm)	Scaling Factor	Power Drift (dB)	Measured SAR-1g (W/kg)	Scaled SAR-1g (W/kg)
08	CDMA BC0	RTAP 153.6	Front Face	384	25.2	24.62	1.14	0.06	0.541	0.62
	CDMA BC0	RTAP 153.6	Rear Face	384	25.2	24.62	1.14	-0.01	0.526	0.60
09	CDMA BC1	RTAP 153.6	Front Face	25	25.2	24.86	1.08	0.14	0.883	0.95
	CDMA BC1	RTAP 153.6	Rear Face	25	25.2	24.86	1.08	0.07	0.868	0.94
	CDMA BC1	RTAP 153.6	Front Face	600	25.2	24.70	1.12	0.07	0.757	0.85
	CDMA BC1	RTAP 153.6	Front Face	1175	25.2	24.30	1.23	0.04	0.55	0.68
	CDMA BC1	RTAP 153.6	Rear Face	600	25.2	24.70	1.12	-0.12	0.831	0.93
	CDMA BC1	RTAP 153.6	Rear Face	1175	25.2	24.30	1.23	0.03	0.617	0.76
	CDMA BC1	RTAP 153.6	Front Face	25	25.2	24.86	1.08	0.05	0.875	0.95
	CDMA BC10	RTAP 153.6	Front Face	580	25.2	24.57	1.16	0.03	0.454	0.52
10	CDMA BC10	RTAP 153.6	Rear Face	580	25.2	24.57	1.16	-0.01	0.545	0.63
	802.11b	-	Front Face	6	17.5	17.25	1.06	0.01	0.036	0.04
14	802.11b	-	Rear Face	6	17.5	17.25	1.06	0.04	0.265	0.28

Note:

- SAR is performed on the highest power channel. When the reported SAR value of highest power channel is <= 0.8 W/kg, SAR testing for optional channel is not required.
- According to KDB 248227, when the extrapolated maximum peak SAR for the maximum output power channel is <= 1.6 W/kg and the 1g averaged SAR is <= 0.8 W/kg, WLAN SAR testing for other channels is not required.
- SAR testing for 802.11g/n is not required when its maximum power is less than 1/4 dB higher than 802.11b.

Plot No.	Band	Mode	Test Position	Ch.	RB#	RB Offset	Max. Tune-up Power (dBm)	Measured Conducted Power (dBm)	Scaling Factor	Power Drift (dB)	Measured SAR-1g (W/kg)	Scaled SAR-1g (W/kg)
11	LTE 25	QPSK10M	Front Face	26640	1	0	24.2	23.38	1.21	0.12	0.469	0.57
	LTE 25	QPSK10M	Rear Face	26640	1	0	24.2	23.38	1.21	-0.06	0.592	0.72
	LTE 25	QPSK10M	Front Face	26640	25	0	23.2	22.39	1.21	0.10	0.336	0.40
	LTE 25	QPSK10M	Rear Face	26640	25	0	23.2	22.39	1.21	0.08	0.4	0.48
12	LTE 26	QPSK10M	Front Face	26990	1	24	23.7	23.33	1.09	-0.03	0.389	0.42
	LTE 26	QPSK10M	Rear Face	26990	1	24	23.7	23.33	1.09	0.11	0.397	0.43
	LTE 26	QPSK10M	Front Face	26990	25	25	22.7	22.40	1.07	0.00	0.332	0.36
	LTE 26	QPSK10M	Rear Face	26990	25	25	22.7	22.40	1.07	0.05	0.331	0.35
13	LTE 41	QPSK20M	Front Face	41055	1	50	24.2	24.07	1.03	0.15	0.422	0.43
	LTE 41	QPSK20M	Rear Face	41055	1	50	24.2	24.07	1.03	0.11	0.358	0.37
	LTE 41	QPSK20M	Front Face	41055	50	50	23.2	22.98	1.05	-0.09	0.368	0.39
	LTE 41	QPSK20M	Rear Face	41055	50	50	23.2	22.98	1.05	0.13	0.264	0.28

Note:

- According to KDB 941225, LTE SAR testing for remaining RB offset configurations and required test channels is not required when the reported SAR of highest power 1RB configuration is less than 0.8 W/kg.
- According to KDB 941225, LTE SAR testing for remaining RB offset configurations and required test channels is not required when the reported SAR of highest power 50% RB configuration is less than 0.8 W/kg.
- According to KDB 941225, LTE SAR testing for 100% RB is not required when the maximum power of 100% RB is less than the maximum power of 1RB and 50% RB, and the highest reported SAR for 1RB and 50% RB is less than 0.8 W/kg.
- According to KDB 941225, LTE SAR testing for 16QAM is not required when the maximum power of 16QAM is less 1/2 dB higher than QPSK, and the highest reported SAR of QPSK is less than 1.45 W/kg.
- According to KDB 941225, LTE SAR testing for smaller channel bandwidth is not required when the maximum power of smaller channel bandwidth is less 1/2 dB higher than largest channel bandwidth, and the highest reported SAR of largest channel bandwidth is less than 1.45 W/kg.

4.7.3 SAR Results for Hotspot (Separation Distance is 1.0 cm Gap)

Plot No.	Band	Mode	Test Position	Ch.	Max. Tune-up Power (dBm)	Measured Conducted Power (dBm)	Scaling Factor	Power Drift (dB)	Measured SAR-1g (W/kg)	Scaled SAR-1g (W/kg)
15	CDMA BC0	RTAP 153.6	Front Face	384	25.2	24.62	1.14	0.06	0.541	0.62
	CDMA BC0	RTAP 153.6	Rear Face	384	25.2	24.62	1.14	-0.01	0.526	0.60
	CDMA BC0	RTAP 153.6	Left Side	384	25.2	24.62	1.14	0.10	0.689	0.79
	CDMA BC0	RTAP 153.6	Right Side	384	25.2	24.62	1.14	0.06	0.517	0.59
	CDMA BC0	RTAP 153.6	Bottom Side	384	25.2	24.62	1.14	0.07	0.169	0.19
16	CDMA BC1	RTAP 153.6	Front Face	25	25.2	24.86	1.08	0.08	0.883	0.95
	CDMA BC1	RTAP 153.6	Rear Face	25	25.2	24.86	1.08	0.07	0.868	0.94
	CDMA BC1	RTAP 153.6	Left Side	25	25.2	24.86	1.08	0.01	0.622	0.67
	CDMA BC1	RTAP 153.6	Right Side	25	25.2	24.86	1.08	0.08	0.147	0.16
	CDMA BC1	RTAP 153.6	Bottom Side	25	25.2	24.86	1.08	-0.01	1.37	1.48
	CDMA BC1	RTAP 153.6	Front Face	600	25.2	24.70	1.12	0.07	0.757	0.85
	CDMA BC1	RTAP 153.6	Front Face	1175	25.2	24.30	1.23	0.04	0.55	0.68
	CDMA BC1	RTAP 153.6	Rear Face	600	25.2	24.70	1.12	-0.12	0.831	0.93
	CDMA BC1	RTAP 153.6	Rear Face	1175	25.2	24.30	1.23	0.03	0.617	0.76
	CDMA BC1	RTAP 153.6	Bottom Side	600	25.2	24.70	1.12	0.06	1.24	1.39
17	CDMA BC10	RTAP 153.6	Front Face	580	25.2	24.57	1.16	0.03	0.454	0.52
	CDMA BC10	RTAP 153.6	Rear Face	580	25.2	24.57	1.16	-0.01	0.545	0.63
	CDMA BC10	RTAP 153.6	Left Side	580	25.2	24.57	1.16	0.07	0.628	0.73
	CDMA BC10	RTAP 153.6	Right Side	580	25.2	24.57	1.16	0.05	0.409	0.47
	CDMA BC10	RTAP 153.6	Bottom Side	580	25.2	24.57	1.16	0.15	0.146	0.17
14	802.11b	-	Front Face	6	17.5	17.25	1.06	0.01	0.036	0.04
	802.11b	-	Rear Face	6	17.5	17.25	1.06	0.04	0.265	0.28
	802.11b	-	Right Side	6	17.5	17.25	1.06	0.01	0.158	0.17

Note:

- SAR is performed on the highest power channel. When the reported SAR value of highest power channel is <= 0.8 W/kg, SAR testing for optional channel is not required.
- According to KDB 248227, when the extrapolated maximum peak SAR for the maximum output power channel is <= 1.6 W/kg and the 1g averaged SAR is <= 0.8 W/kg, WLAN SAR testing for other channels is not required.
- SAR testing for 802.11g/n is not required when its maximum power is less than 1/4 dB higher than 802.11b.



FCC SAR Test Report

A D T

Plot No.	Band	Mode	Test Position	Ch.	RB#	RB Offset	Max. Tune-up Power (dBm)	Measured Conducted Power (dBm)	Scaling Factor	Power Drift (dB)	Measured SAR-1g (W/kg)	Scaled SAR-1g (W/kg)
	LTE 25	QPSK10M	Front Face	26640	1	0	24.2	23.38	1.21	0.12	0.469	0.57
	LTE 25	QPSK10M	Rear Face	26640	1	0	24.2	23.38	1.21	-0.06	0.592	0.72
	LTE 25	QPSK10M	Left Side	26640	1	0	24.2	23.38	1.21	-0.15	0.348	0.42
	LTE 25	QPSK10M	Right Side	26640	1	0	24.2	23.38	1.21	-0.01	0.109	0.13
	LTE 25	QPSK10M	Bottom Side	26640	1	0	24.2	23.38	1.21	0.03	0.854	1.03
	LTE 25	QPSK10M	Front Face	26640	25	0	23.2	22.39	1.21	0.10	0.336	0.40
	LTE 25	QPSK10M	Rear Face	26640	25	0	23.2	22.39	1.21	0.08	0.4	0.48
	LTE 25	QPSK10M	Left Side	26640	25	0	23.2	22.39	1.21	0.04	0.244	0.29
	LTE 25	QPSK10M	Right Side	26640	25	0	23.2	22.39	1.21	0.07	0.08	0.10
	LTE 25	QPSK10M	Bottom Side	26640	25	0	23.2	22.39	1.21	-0.04	0.616	0.74
18	LTE 25	QPSK10M	Bottom Side	26090	1	0	24.2	23.37	1.21	0.01	1.01	1.22
	LTE 25	QPSK10M	Bottom Side	26365	1	0	24.2	23.24	1.25	0.05	0.978	1.22
	LTE 25	QPSK10M	Bottom Side	26640	50	0	23.2	22.36	1.21	-0.03	0.628	0.76
	LTE 25	QPSK10M	Bottom Side	26090	1	0	24.2	23.37	1.21	0.01	0.998	1.21
	LTE 26	QPSK10M	Front Face	26990	1	24	23.7	23.33	1.09	-0.03	0.389	0.42
	LTE 26	QPSK10M	Rear Face	26990	1	24	23.7	23.33	1.09	0.11	0.397	0.43
19	LTE 26	QPSK10M	Left Side	26990	1	24	23.7	23.33	1.09	0.03	0.528	0.57
	LTE 26	QPSK10M	Right Side	26990	1	24	23.7	23.33	1.09	-0.01	0.398	0.43
	LTE 26	QPSK10M	Bottom Side	26990	1	24	23.7	23.33	1.09	0.07	0.162	0.18
	LTE 26	QPSK10M	Front Face	26990	25	25	22.7	22.40	1.07	0.00	0.332	0.36
	LTE 26	QPSK10M	Rear Face	26990	25	25	22.7	22.40	1.07	0.05	0.331	0.35
	LTE 26	QPSK10M	Left Side	26990	25	25	22.7	22.40	1.07	0.05	0.387	0.41
	LTE 26	QPSK10M	Right Side	26990	25	25	22.7	22.40	1.07	-0.03	0.299	0.32
	LTE 26	QPSK10M	Bottom Side	26990	25	25	22.7	22.40	1.07	0.03	0.122	0.13
20	LTE 41	QPSK20M	Front Face	41055	1	50	24.2	24.07	1.03	0.15	0.422	0.43
	LTE 41	QPSK20M	Rear Face	41055	1	50	24.2	24.07	1.03	0.11	0.358	0.37
	LTE 41	QPSK20M	Right Side	41055	1	50	24.2	24.07	1.03	-0.05	0.351	0.36
	LTE 41	QPSK20M	Bottom Side	41055	1	50	24.2	24.07	1.03	0.01	0.185	0.19
	LTE 41	QPSK20M	Front Face	41055	50	50	23.2	22.98	1.05	-0.09	0.368	0.39
	LTE 41	QPSK20M	Rear Face	41055	50	50	23.2	22.98	1.05	0.13	0.264	0.28
	LTE 41	QPSK20M	Right Side	41055	50	50	23.2	22.98	1.05	0.05	0.292	0.31
	LTE 41	QPSK20M	Bottom Side	41055	50	50	23.2	22.98	1.05	0.01	0.144	0.15

Note:

1. According to KDB 941225, LTE SAR testing for remaining RB offset configurations and required test channels is not required when the reported SAR of highest power 1RB configuration is less than 0.8 W/kg.
2. According to KDB 941225, LTE SAR testing for remaining RB offset configurations and required test channels is not required when the reported SAR of highest power 50% RB configuration is less than 0.8 W/kg.
3. According to KDB 941225, LTE SAR testing for 100% RB is not required when the maximum power of 100% RB is less than the maximum power of 1RB and 50% RB, and the highest reported SAR for 1RB and 50% RB is less than 0.8 W/kg.
4. According to KDB 941225, LTE SAR testing for 16QAM is not required when the maximum power of 16QAM is less 1/2 dB higher than QPSK, and the highest reported SAR of QPSK is less than 1.45 W/kg.
5. According to KDB 941225, LTE SAR testing for smaller channel bandwidth is not required when the maximum power of smaller channel bandwidth is less 1/2 dB higher than largest channel bandwidth, and the highest reported SAR of largest channel bandwidth is less than 1.45 W/kg.

FCC SAR Test Report

4.7.4 SAR Measurement Variability

According to KDB 865664 D01 v01r01, SAR measurement variability was assessed for each frequency band, which is determined by the SAR probe calibration point and tissue-equivalent medium used for the device measurements. When both head and body tissue-equivalent media are required for SAR measurements in a frequency band, the variability measurement procedures should be applied to the tissue medium with the highest measured SAR, using the highest measured SAR configuration for that tissue-equivalent medium. Alternatively, if the highest measured SAR for both head and body tissue-equivalent media are ≤ 1.45 W/kg and the ratio of these highest SAR values, i.e., largest divided by smallest value, is ≤ 1.10 , the highest SAR configuration for either head or body tissue-equivalent medium may be used to perform the repeated measurement. These additional measurements are repeated after the completion of all measurements requiring the same head or body tissue-equivalent medium in a frequency band. The test device should be returned to ambient conditions (normal room temperature) with the battery fully charged before it is re-mounted on the device holder for the repeated measurement(s) to minimize any unexpected variations in the repeated results.

SAR repeated measurement procedure:

1. When the highest measured SAR is < 0.80 W/kg, repeated measurement is not required.
2. When the highest measured SAR is ≥ 0.80 W/kg, repeat that measurement once.
3. If the ratio of largest to smallest SAR for the original and first repeated measurements is > 1.20 , or when the original or repeated measurement is ≥ 1.45 W/kg, perform a second repeated measurement.
4. If the ratio of largest to smallest SAR for the original, first and second repeated measurements is > 1.20 , and the original, first or second repeated measurement is ≥ 1.5 W/kg, perform a third repeated measurement.

Band	Mode	Test Position	Ch.	Original Measured SAR-1g (W/kg)	1st Repeated SAR-1g (W/kg)	L/S Ratio	2nd Repeated SAR-1g (W/kg)	L/S Ratio	3rd Repeated SAR-1g (W/kg)	L/S Ratio
LTE 41	QPSK20M	Right Cheek	41490	1.16	1.14	1.02	N/A	N/A	N/A	N/A
CDMA BC1	RTAP 153.6	Front Face	25	0.883	0.875	1.01	N/A	N/A	N/A	N/A
CDMA BC1	RTAP 153.6	Bottom Side	25	1.37	1.33	1.03	N/A	N/A	N/A	N/A
LTE 25	QPSK10M	Bottom Side	26090	1.01	0.998	1.01	N/A	N/A	N/A	N/A

FCC SAR Test Report

4.7.5 Simultaneous Multi-band Transmission Evaluation

<Estimated SAR Calculation>

According to KDB 447498 D01, when standalone SAR test exclusion applies to an antenna that transmits simultaneously with other antennas, the standalone SAR was estimated according to following formula to result in substantially conservative SAR values of ≤ 0.4 W/kg to determine simultaneous transmission SAR test exclusion.

$$\text{Estimated SAR} = \frac{\text{Max. Tune up Power}_{(mW)}}{\text{Min. Test Separation Distance}_{(mm)}} \times \frac{\sqrt{f_{(GHz)}}}{7.5}$$

If the minimum test separation distance is < 5 mm, a distance of 5 mm is used for estimated SAR calculation. When the test separation distance is > 50 mm, the 0.4 W/kg is used for SAR-1g.

Mode / Band	Frequency (GHz)	Max. Tune-up Power (dBm)	Test Position	Separation Distance (mm)	Estimated SAR (W/kg)
BT (DSS)	2.48	2.0	Body-worn	10	0.03

Note:

1. The separation distance is determined from the outer housing of the EUT to the user.
2. When standalone SAR testing is not required, an estimated SAR can be applied to determine simultaneous transmission SAR test exclusion.



FCC SAR Test Report

<SAR Summation Analysis>

Simultaneous transmission SAR test exclusion is determined for each operating configuration and exposure condition according to the reported standalone SAR of each applicable simultaneous transmitting antenna. When the sum of SAR_{1g} of all simultaneously transmitting antennas in an operating mode and exposure condition combination is within the SAR limit (SAR_{1g} 1.6 W/kg), the simultaneous transmission SAR is not required. When the sum of SAR_{1g} is greater than the SAR limit (SAR_{1g} 1.6 W/kg), SAR test exclusion is determined by the SPLSR.

No.	Conditions (SAR1 + SAR2)	Exposure Condition	Test Position	Max. SAR1	Max. SAR2	SAR Summation	SPLSR Analysis
1	CDMA BC0 + WLAN (DTS)	Head	Right Cheek	0.36	0.06	0.42	Σ SAR < 1.6, Not required
			Right Tilted	0.36	0.03	0.39	Σ SAR < 1.6, Not required
			Left Cheek	0.47	0.15	0.62	Σ SAR < 1.6, Not required
			Left Tilted	0.36	0.06	0.42	Σ SAR < 1.6, Not required
		Body-Worn	Front Face	0.62	0.04	0.66	Σ SAR < 1.6, Not required
			Rear Face	0.60	0.28	0.88	Σ SAR < 1.6, Not required
		Hotspot	Front Face	0.62	0.04	0.66	Σ SAR < 1.6, Not required
			Rear Face	0.60	0.28	0.88	Σ SAR < 1.6, Not required
			Left Side	0.79	-	0.79	Σ SAR < 1.6, Not required
			Right Side	0.59	0.17	0.76	Σ SAR < 1.6, Not required
			Top Side	-	-	0.00	Σ SAR < 1.6, Not required
				Bottom Side	0.19	-	0.19
2	CDMA BC0 + BT (DSS)	Body-Worn	Front Face	0.62	0.03	0.65	Σ SAR < 1.6, Not required
			Rear Face	0.60	0.03	0.63	Σ SAR < 1.6, Not required



FCC SAR Test Report

No.	Conditions (SAR1 + SAR2)	Exposure Condition	Test Position	Max. SAR1	Max. SAR2	SAR Summation	SPLSR Analysis
3	CDMA BC1 + WLAN (DTS)	Head	Right Cheek	0.60	0.06	0.66	Σ SAR < 1.6, Not required
			Right Tilted	0.43	0.03	0.46	Σ SAR < 1.6, Not required
			Left Cheek	0.80	0.15	0.95	Σ SAR < 1.6, Not required
			Left Tilted	0.41	0.06	0.47	Σ SAR < 1.6, Not required
		Body-Worn	Front Face	0.95	0.04	0.99	Σ SAR < 1.6, Not required
			Rear Face	0.94	0.28	1.22	Σ SAR < 1.6, Not required
		Hotspot	Front Face	0.95	0.04	0.99	Σ SAR < 1.6, Not required
			Rear Face	0.94	0.28	1.22	Σ SAR < 1.6, Not required
			Left Side	0.67	-	0.67	Σ SAR < 1.6, Not required
			Right Side	0.16	0.17	0.33	Σ SAR < 1.6, Not required
			Top Side	-	-	0.00	Σ SAR < 1.6, Not required
Bottom Side	1.48	-	1.48	Σ SAR < 1.6, Not required			
4	CDMA BC1 + BT (DSS)	Body-Worn	Front Face	0.95	0.03	0.98	Σ SAR < 1.6, Not required
			Rear Face	0.94	0.03	0.97	Σ SAR < 1.6, Not required

No.	Conditions (SAR1 + SAR2)	Exposure Condition	Test Position	Max. SAR1	Max. SAR2	SAR Summation	SPLSR Analysis
5	CDMA BC10 + WLAN (DTS)	Head	Right Cheek	0.37	0.06	0.43	Σ SAR < 1.6, Not required
			Right Tilted	0.36	0.03	0.39	Σ SAR < 1.6, Not required
			Left Cheek	0.45	0.15	0.60	Σ SAR < 1.6, Not required
			Left Tilted	0.36	0.06	0.42	Σ SAR < 1.6, Not required
		Body-Worn	Front Face	0.52	0.04	0.56	Σ SAR < 1.6, Not required
			Rear Face	0.63	0.28	0.91	Σ SAR < 1.6, Not required
		Hotspot	Front Face	0.52	0.04	0.56	Σ SAR < 1.6, Not required
			Rear Face	0.63	0.28	0.91	Σ SAR < 1.6, Not required
			Left Side	0.73	-	0.73	Σ SAR < 1.6, Not required
			Right Side	0.47	0.17	0.64	Σ SAR < 1.6, Not required
			Top Side	-	-	0.00	Σ SAR < 1.6, Not required
Bottom Side	0.17	-	0.17	Σ SAR < 1.6, Not required			
6	CDMA BC10 + BT (DSS)	Body-Worn	Front Face	0.52	0.03	0.55	Σ SAR < 1.6, Not required
			Rear Face	0.63	0.03	0.66	Σ SAR < 1.6, Not required



FCC SAR Test Report

A D T

No.	Conditions (SAR1 + SAR2)	Exposure Condition	Test Position	Max. SAR1	Max. SAR2	SAR Summation	SPLSR Analysis
7	LTE B25 + WLAN (DTS)	Head	Right Cheek	0.32	0.06	0.38	Σ SAR < 1.6, Not required
			Right Tilted	0.26	0.03	0.29	Σ SAR < 1.6, Not required
			Left Cheek	0.57	0.15	0.72	Σ SAR < 1.6, Not required
			Left Tilted	0.35	0.06	0.41	Σ SAR < 1.6, Not required
		Body-Worn	Front Face	0.57	0.04	0.61	Σ SAR < 1.6, Not required
			Rear Face	0.72	0.28	1.00	Σ SAR < 1.6, Not required
		Hotspot	Front Face	0.57	0.04	0.61	Σ SAR < 1.6, Not required
			Rear Face	0.72	0.28	1.00	Σ SAR < 1.6, Not required
			Left Side	0.42	-	0.42	Σ SAR < 1.6, Not required
			Right Side	0.13	0.17	0.30	Σ SAR < 1.6, Not required
			Top Side	-	-	0.00	Σ SAR < 1.6, Not required
Bottom Side	1.22	-	1.22	Σ SAR < 1.6, Not required			
8	LTE B25 + BT (DSS)	Body-Worn	Front Face	0.57	0.03	0.60	Σ SAR < 1.6, Not required
			Rear Face	0.72	0.03	0.75	Σ SAR < 1.6, Not required

No.	Conditions (SAR1 + SAR2)	Exposure Condition	Test Position	Max. SAR1	Max. SAR2	SAR Summation	SPLSR Analysis
9	LTE B26 + WLAN (DTS)	Head	Right Cheek	0.27	0.06	0.33	Σ SAR < 1.6, Not required
			Right Tilted	0.27	0.03	0.30	Σ SAR < 1.6, Not required
			Left Cheek	0.36	0.15	0.51	Σ SAR < 1.6, Not required
			Left Tilted	0.28	0.06	0.34	Σ SAR < 1.6, Not required
		Body-Worn	Front Face	0.42	0.04	0.46	Σ SAR < 1.6, Not required
			Rear Face	0.43	0.28	0.71	Σ SAR < 1.6, Not required
		Hotspot	Front Face	0.42	0.04	0.46	Σ SAR < 1.6, Not required
			Rear Face	0.43	0.28	0.71	Σ SAR < 1.6, Not required
			Left Side	0.57	-	0.57	Σ SAR < 1.6, Not required
			Right Side	0.43	0.17	0.60	Σ SAR < 1.6, Not required
			Top Side	-	-	0.00	Σ SAR < 1.6, Not required
Bottom Side	0.18	-	0.18	Σ SAR < 1.6, Not required			
10	LTE B26 + BT (DSS)	Body-Worn	Front Face	0.42	0.03	0.45	Σ SAR < 1.6, Not required
			Rear Face	0.43	0.03	0.46	Σ SAR < 1.6, Not required



FCC SAR Test Report

A D T

No.	Conditions (SAR1 + SAR2)	Exposure Condition	Test Position	Max. SAR1	Max. SAR2	SAR Summation	SPLSR Analysis
11	LTE B41 + WLAN (DTS)	Head	Right Cheek	1.29	0.06	1.35	Σ SAR < 1.6, Not required
			Right Tilted	0.25	0.03	0.28	Σ SAR < 1.6, Not required
			Left Cheek	0.51	0.15	0.66	Σ SAR < 1.6, Not required
			Left Tilted	0.28	0.06	0.34	Σ SAR < 1.6, Not required
		Body-Worn	Front Face	0.43	0.04	0.47	Σ SAR < 1.6, Not required
			Rear Face	0.37	0.28	0.65	Σ SAR < 1.6, Not required
		Hotspot	Front Face	0.43	0.04	0.47	Σ SAR < 1.6, Not required
			Rear Face	0.37	0.28	0.65	Σ SAR < 1.6, Not required
			Left Side	-	-	0.00	Σ SAR < 1.6, Not required
			Right Side	0.36	0.17	0.53	Σ SAR < 1.6, Not required
			Top Side	-	-	0.00	Σ SAR < 1.6, Not required
		Bottom Side	0.19	-	0.19	Σ SAR < 1.6, Not required	
12	LTE B41 + BT (DSS)	Body-Worn	Front Face	0.43	0.03	0.46	Σ SAR < 1.6, Not required
			Rear Face	0.37	0.03	0.40	Σ SAR < 1.6, Not required

Test Engineer : Jim Lei, and Way Huang

5. Calibration of Test Equipment

Equipment	Manufacturer	Model	SN	Cal. Date	Cal. Interval
System Validation Kit	SPEAG	D835V2	4d121	Apr. 25, 2013	Annual
System Validation Kit	SPEAG	D1900V2	5d036	Jan. 21, 2013	Annual
System Validation Kit	SPEAG	D2450V2	737	Jan. 21, 2013	Annual
System Validation Kit	SPEAG	D2600V2	1020	Jan. 18, 2013	Annual
Dosimetric E-Field Probe	SPEAG	EX3DV4	3590	Feb. 20, 2013	Annual
Dosimetric E-Field Probe	SPEAG	EX3DV4	3650	Apr. 30, 2013	Annual
Data Acquisition Electronics	SPEAG	DAE3	360	Jan. 30, 2013	Annual
Data Acquisition Electronics	SPEAG	DAE4	861	Mar. 19, 2013	Annual
SAM Phantom	SPEAG	QD000P40CD	TP-1202	N/A	N/A
SAM Phantom	SPEAG	QD000P40CD	TP-1653	N/A	N/A
SAM Phantom	SPEAG	QD000P40CD	TP-1654	N/A	N/A
ELI Phantom	SPEAG	QDOVA001B	TP-1039	N/A	N/A
ELI Phantom	SPEAG	QDOVA002AA	1206	N/A	N/A
Radio Communication Tester	Agilent	E5515C	MY50266630	Oct. 02, 2013	Biennial
Radio Communication Analyzer	Anritsu	MT8820C	6201010285	Aug. 06, 2013	Biennial
ENA Series Network Analyzer	Agilent	E5071C	MY46214281	Jun. 10, 2013	Annual
MXG Analog Signal Generator	Agilent	N5181A	MY50143868	Jun. 06, 2013	Annual
Power Meter	Anritsu	ML2495A	1218009	Jun. 11, 2013	Annual
Power Sensor	Anritsu	MA2411B	1207252	Jun. 11, 2013	Annual
EXA Spectrum Analyzer	Agilent	N9010A	MY52100136	Jun. 26, 2013	Annual
Dielectric Probe Kit	Agilent	85070D	E2-020018	May 13, 2013	Annual
Thermometer	YFE	YF-160A	110600361	Feb. 20, 2013	Annual
Directional Coupler	Woken	0110A05602O-10	11122702	Apr. 18, 2013	Annual
Power Amplifier	AR	5S1G4	0339656	Apr. 18, 2013	Annual
Attenuator	Woken	00800A1G01L-03	N/A	Apr. 18, 2013	Annual

6. Measurement Uncertainty

Error Description	Uncertainty Value (±%)	Probability Distribution	Divisor	Ci (1g)	Standard Uncertainty (1g)	Vi
Measurement System						
Probe Calibration	6.0	Normal	1	1	± 6.0 %	∞
Axial Isotropy	4.7	Rectangular	√3	0.7	± 1.9 %	∞
Hemispherical Isotropy	9.6	Rectangular	√3	0.7	± 3.9 %	∞
Boundary Effects	1.0	Rectangular	√3	1	± 0.6 %	∞
Linearity	4.7	Rectangular	√3	1	± 2.7 %	∞
System Detection Limits	1.0	Rectangular	√3	1	± 0.6 %	∞
Readout Electronics	0.6	Normal	1	1	± 0.6 %	∞
Response Time	0.0	Rectangular	√3	1	± 0.0 %	∞
Integration Time	1.7	Rectangular	√3	1	± 1.0 %	∞
RF Ambient Noise	3.0	Rectangular	√3	1	± 1.7 %	∞
RF Ambient Reflections	3.0	Rectangular	√3	1	± 1.7 %	∞
Probe Positioner	0.5	Rectangular	√3	1	± 0.3 %	∞
Probe Positioning	2.9	Rectangular	√3	1	± 1.7 %	∞
Max. SAR Eval.	2.3	Rectangular	√3	1	± 1.3 %	∞
Test Sample Related						
Device Positioning	3.9	Normal	1	1	± 3.9 %	31
Device Holder	2.7	Normal	1	1	± 2.7 %	19
Power Drift	5.0	Rectangular	√3	1	± 2.9 %	∞
Phantom and Setup						
Phantom Uncertainty	4.0	Rectangular	√3	1	± 2.3 %	∞
Liquid Conductivity (Target)	5.0	Rectangular	√3	0.64	± 1.8 %	∞
Liquid Conductivity (Meas.)	5.0	Normal	1	0.64	± 3.2 %	29
Liquid Permittivity (Target)	5.0	Rectangular	√3	0.6	± 1.7 %	∞
Liquid Permittivity (Meas.)	5.0	Normal	1	0.6	± 3.0 %	29
Combined Standard Uncertainty					± 11.7 %	
Expanded Uncertainty (K=2)					± 23.4 %	

Uncertainty budget for frequency range 300 MHz to 3 GHz



7. Information on the Testing Laboratories

We, Bureau Veritas Consumer Products Services (H.K.) Ltd., Taoyuan Branch, were founded in 1988 to provide our best service in EMC, Radio, Telecom and Safety consultation. Our laboratories are accredited and approved according to ISO/IEC 17025.

If you have any comments, please feel free to contact us at the following:

Taiwan HwaYa EMC/RF/Safety/Telecom Lab:

Add: No. 19, Hwa Ya 2nd Rd, Wen Hwa Vil., Kwei Shan Hsiang, Taoyuan Hsien 333, Taiwan, R.O.C.
Tel: 886-3-318-3232
Fax: 886-3-327-0892

Taiwan LinKo EMC/RF Lab:

Add: No. 47, 14th Ling, Chia Pau Vil., Linkou Dist., New Taipei City 244, Taiwan, R.O.C.
Tel: 886-2-2605-2180
Fax: 886-2-2605-1924

Taiwan HsinChu EMC/RF Lab:

Add: No. 81-1, Lu Liao Keng, 9th Ling, Wu Lung Vil., Chiung Lin Township, Hsinchu County 307, Taiwan, R.O.C.
Tel: 886-3-593-5343
Fax: 886-3-593-5342

Email: service.adt@tw.bureauveritas.com

Web Site: www.adt.com.tw

The road map of all our labs can be found in our web site also.

---END---



Appendix A. SAR Plots of System Verification

The plots for system verification with largest deviation for each SAR system combination are shown as follows.

System Check_H835_131208

DUT: Dipole 835 MHz; Type: D835V2; SN: 4d121

Communication System: CW; Frequency: 835 MHz; Duty Cycle: 1:1

Medium: H835_1208 Medium parameters used: $f = 835 \text{ MHz}$; $\sigma = 0.888 \text{ S/m}$; $\epsilon_r = 42.835$; $\rho = 1000 \text{ kg/m}^3$

Ambient Temperature : 21.6 °C; Liquid Temperature : 20.5 °C

DASY5 Configuration:

- Probe: EX3DV4 - SN3650; ConvF(9.37, 9.37, 9.37); Calibrated: 2013/04/30;
- Sensor-Surface: 2mm (Mechanical Surface Detection)
- Electronics: DAE3 Sn360; Calibrated: 2013/01/30
- Phantom: SAM Phantom_Left; Type: SAM V4.0; Serial: TP 1653
- Measurement SW: DASY52, Version 52.8 (7); SEMCAD X Version 14.6.10 (7164)

Pin=250mW/Area Scan (61x61x1): Interpolated grid: $dx=1.500 \text{ mm}$, $dy=1.500 \text{ mm}$
 Maximum value of SAR (interpolated) = 2.91 W/kg

Pin=250mW/Zoom Scan (5x5x7)/Cube 0: Measurement grid: $dx=8\text{mm}$, $dy=8\text{mm}$, $dz=5\text{mm}$
 Reference Value = 55.220 V/m; Power Drift = -0.01 dB
 Peak SAR (extrapolated) = 3.44 W/kg
SAR(1 g) = 2.29 W/kg; SAR(10 g) = 1.5 W/kg
 Maximum value of SAR (measured) = 2.92 W/kg

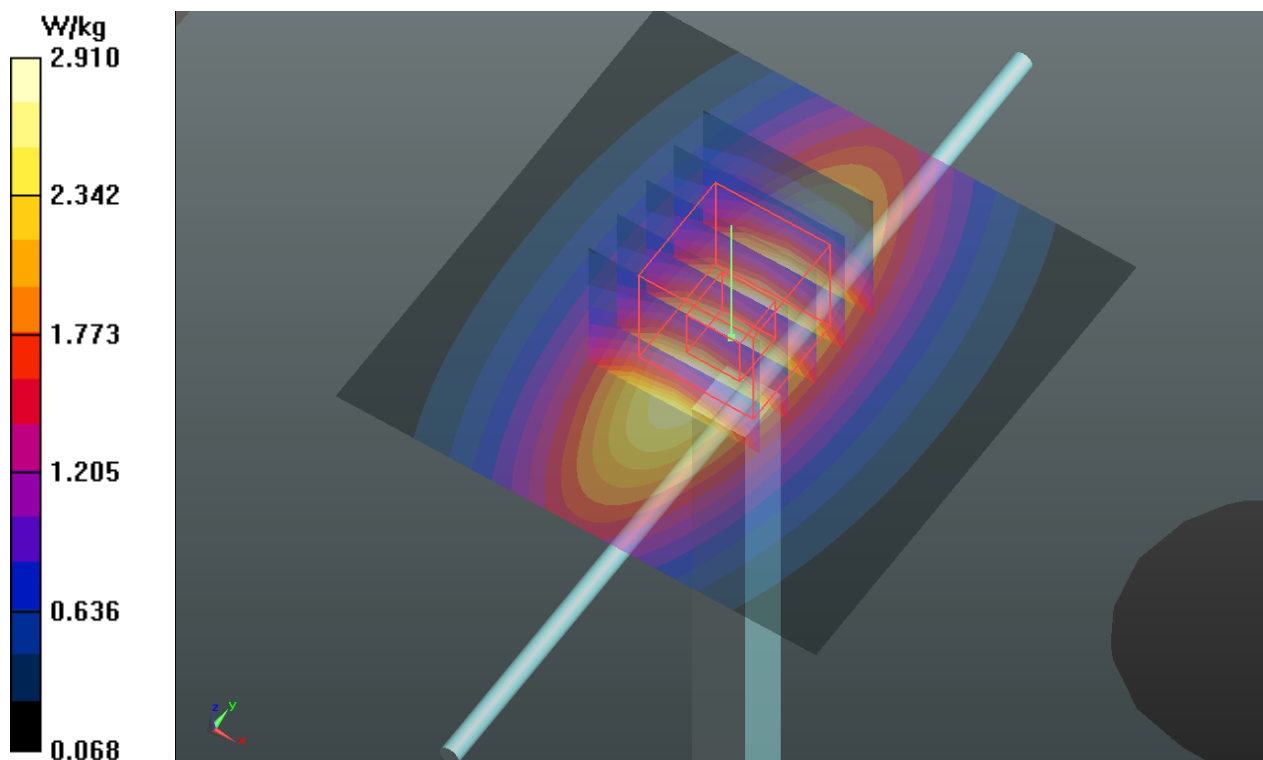

System Check_H1900_131206

DUT: Dipole 1900 MHz; Type: D1900V2; SN: 5d036

Communication System: CW; Frequency: 1900 MHz; Duty Cycle: 1:1

Medium: H1900_1206 Medium parameters used: $f = 1900$ MHz; $\sigma = 1.406$ S/m; $\epsilon_r = 39.596$; $\rho = 1000$ kg/m³

Ambient Temperature : 21.1 °C; Liquid Temperature : 20.7 °C

DASY5 Configuration:

- Probe: EX3DV4 - SN3650; ConvF(7.73, 7.73, 7.73); Calibrated: 2013/04/30;
- Sensor-Surface: 2mm (Mechanical Surface Detection)
- Electronics: DAE3 Sn360; Calibrated: 2013/01/30
- Phantom: SAM Phantom_Left; Type: SAM V4.0; Serial: TP 1653
- Measurement SW: DASY52, Version 52.8 (7); SEMCAD X Version 14.6.10 (7164)

Pin=250mW/Area Scan (61x61x1): Interpolated grid: dx=1.500 mm, dy=1.500 mm

Maximum value of SAR (interpolated) = 15.6 W/kg

Pin=250mW/Zoom Scan (5x5x7)/Cube 0: Measurement grid: dx=8mm, dy=8mm, dz=5mm

Reference Value = 102.6 V/m; Power Drift = 0.01 dB

Peak SAR (extrapolated) = 18.3 W/kg

SAR(1 g) = 10.1 W/kg; SAR(10 g) = 5.31 W/kg

Maximum value of SAR (measured) = 14.2 W/kg

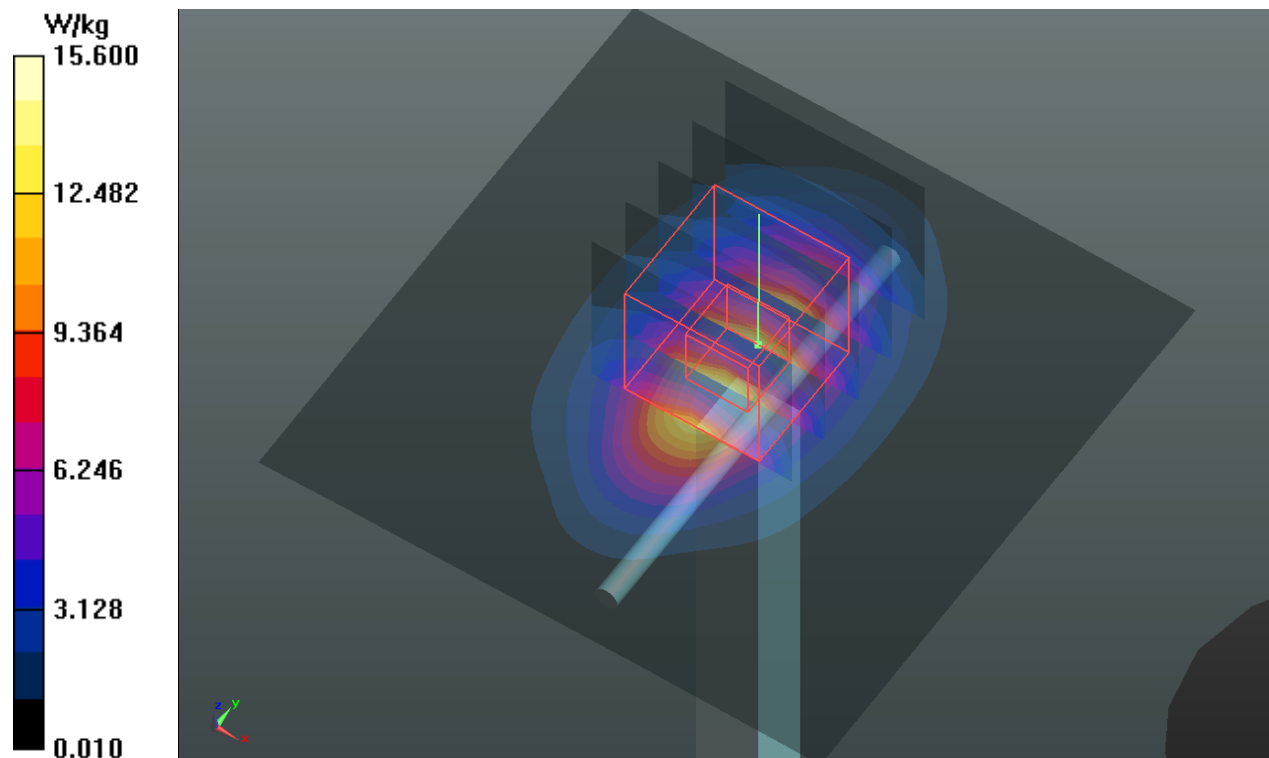

System Check_H2450_131208

DUT: Dipole 2450 MHz; Type: D2450V2; SN: 737

Communication System: CW; Frequency: 2450 MHz; Duty Cycle: 1:1

Medium: H2450_1208 Medium parameters used: $f = 2450$ MHz; $\sigma = 1.887$ S/m; $\epsilon_r = 38.789$; $\rho = 1000$ kg/m³

Ambient Temperature : 21.6 °C; Liquid Temperature : 20.6 °C

DASY5 Configuration:

- Probe: EX3DV4 - SN3650; ConvF(6.99, 6.99, 6.99); Calibrated: 2013/04/30;
- Sensor-Surface: 2mm (Mechanical Surface Detection)
- Electronics: DAE3 Sn360; Calibrated: 2013/01/30
- Phantom: SAM Phantom_Front; Type: SAM V4.0; Serial: TP 1654
- Measurement SW: DASY52, Version 52.8 (7); SEMCAD X Version 14.6.10 (7164)

Pin=250mW/Area Scan (81x81x1): Interpolated grid: dx=1.200 mm, dy=1.200 mm

Maximum value of SAR (interpolated) = 20.2 W/kg

Pin=250mW/Zoom Scan (7x7x7)/Cube 0: Measurement grid: dx=5mm, dy=5mm, dz=5mm

Reference Value = 104.7 V/m; Power Drift = 0.01 dB

Peak SAR (extrapolated) = 26.9 W/kg

SAR(1 g) = 13.6 W/kg; SAR(10 g) = 6.73 W/kg

Maximum value of SAR (measured) = 20.2 W/kg

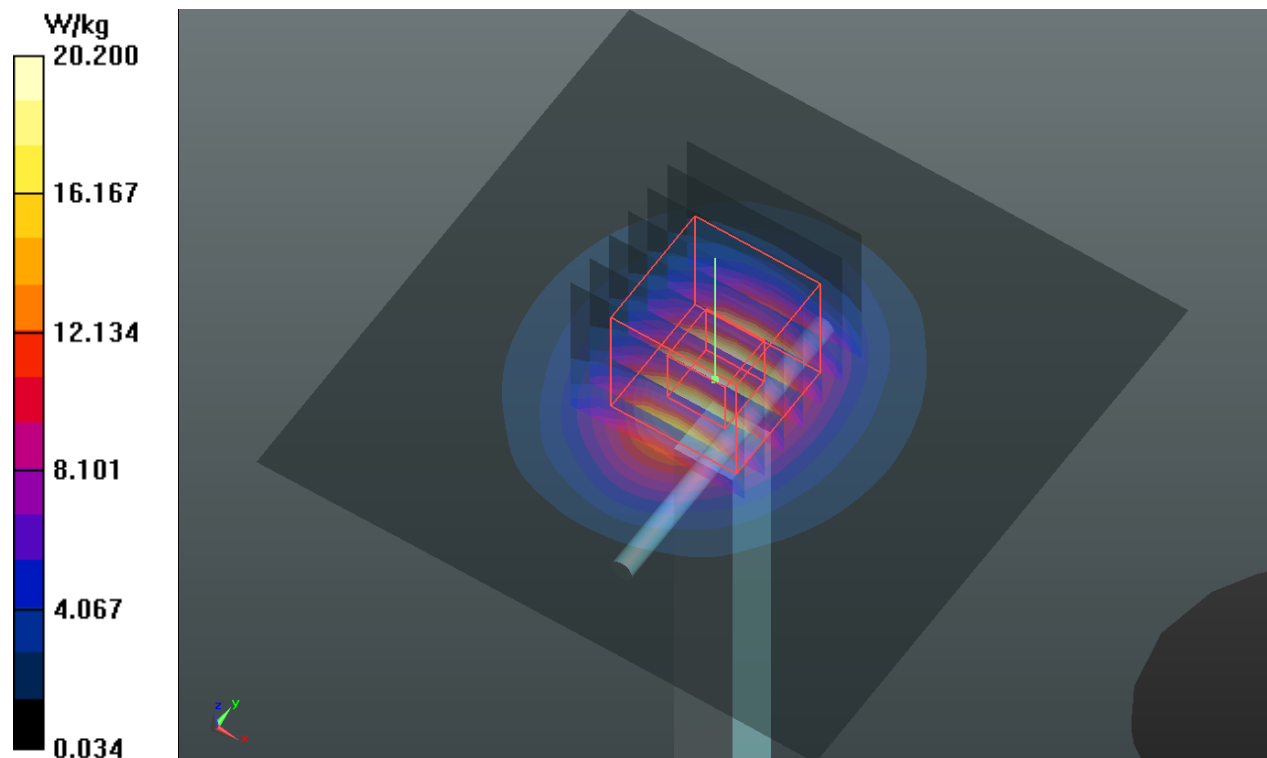

System Check_H2600_131207

DUT: Dipole 2600 MHz; Type: D2600V2; SN: 1020

Communication System: CW; Frequency: 2600 MHz; Duty Cycle: 1:1
Medium: H2600_1207 Medium parameters used: $f = 2600$ MHz; $\sigma = 2.049$ S/m; $\epsilon_r = 37.739$; $\rho = 1000$ kg/m³
Ambient Temperature : 21.7 °C; Liquid Temperature : 21.2 °C

DASY5 Configuration:

- Probe: EX3DV4 - SN3650; ConvF(6.85, 6.85, 6.85); Calibrated: 2013/04/30;
- Sensor-Surface: 2mm (Mechanical Surface Detection)
- Electronics: DAE3 Sn360; Calibrated: 2013/01/30
- Phantom: SAM Phantom_Front; Type: SAM V4.0; Serial: TP 1654
- Measurement SW: DASY52, Version 52.8 (7); SEMCAD X Version 14.6.10 (7164)

Pin=250mW/Area Scan (81x81x1): Interpolated grid: dx=1.200 mm, dy=1.200 mm
Maximum value of SAR (interpolated) = 22.3 W/kg

Pin=250mW/Zoom Scan (7x7x7)/Cube 0: Measurement grid: dx=5mm, dy=5mm, dz=5mm
Reference Value = 105.3 V/m; Power Drift = 0.03 dB
Peak SAR (extrapolated) = 30.9 W/kg
SAR(1 g) = 15 W/kg; SAR(10 g) = 7.14 W/kg
Maximum value of SAR (measured) = 22.7 W/kg

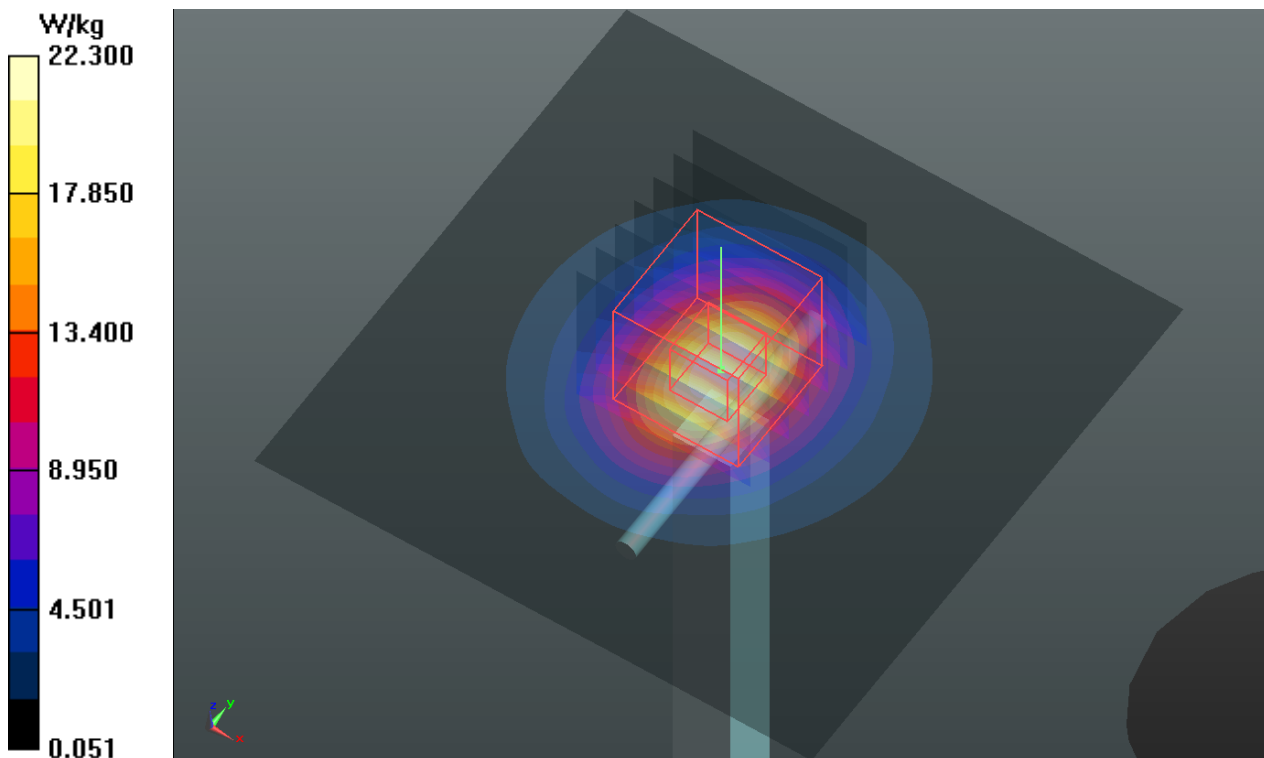

System Check_B835_131213

DUT: Dipole 835 MHz; Type: D835V2; SN: 4d121

Communication System: CW; Frequency: 835 MHz; Duty Cycle: 1:1

Medium: B835_1213 Medium parameters used: $f = 835$ MHz; $\sigma = 0.973$ S/m; $\epsilon_r = 54.214$; $\rho = 1000$ kg/m³

Ambient Temperature : 21.6 °C ; Liquid Temperature : 20.8 °C

DASY5 Configuration:

- Probe: EX3DV4 - SN3590; ConvF(10.43, 10.43, 10.43); Calibrated: 2013/02/20;
- Sensor-Surface: 2mm (Mechanical Surface Detection)
- Electronics: DAE4 Sn861; Calibrated: 2013/03/19
- Phantom: SAM Phantom_Front; Type: SAM V4.0; Serial: TP 1202
- Measurement SW: DASY52, Version 52.8 (7); SEMCAD X Version 14.6.10 (7164)

Pin=250mW/Area Scan (61x81x1): Interpolated grid: dx=1.500 mm, dy=1.500 mm
Maximum value of SAR (interpolated) = 2.93 W/kg

Pin=250mW/Zoom Scan (5x5x7)/Cube 0: Measurement grid: dx=8mm, dy=8mm, dz=5mm
Reference Value = 55.377 V/m; Power Drift = 0.09 dB
Peak SAR (extrapolated) = 3.46 W/kg
SAR(1 g) = 2.34 W/kg; SAR(10 g) = 1.54 W/kg
Maximum value of SAR (measured) = 2.96 W/kg

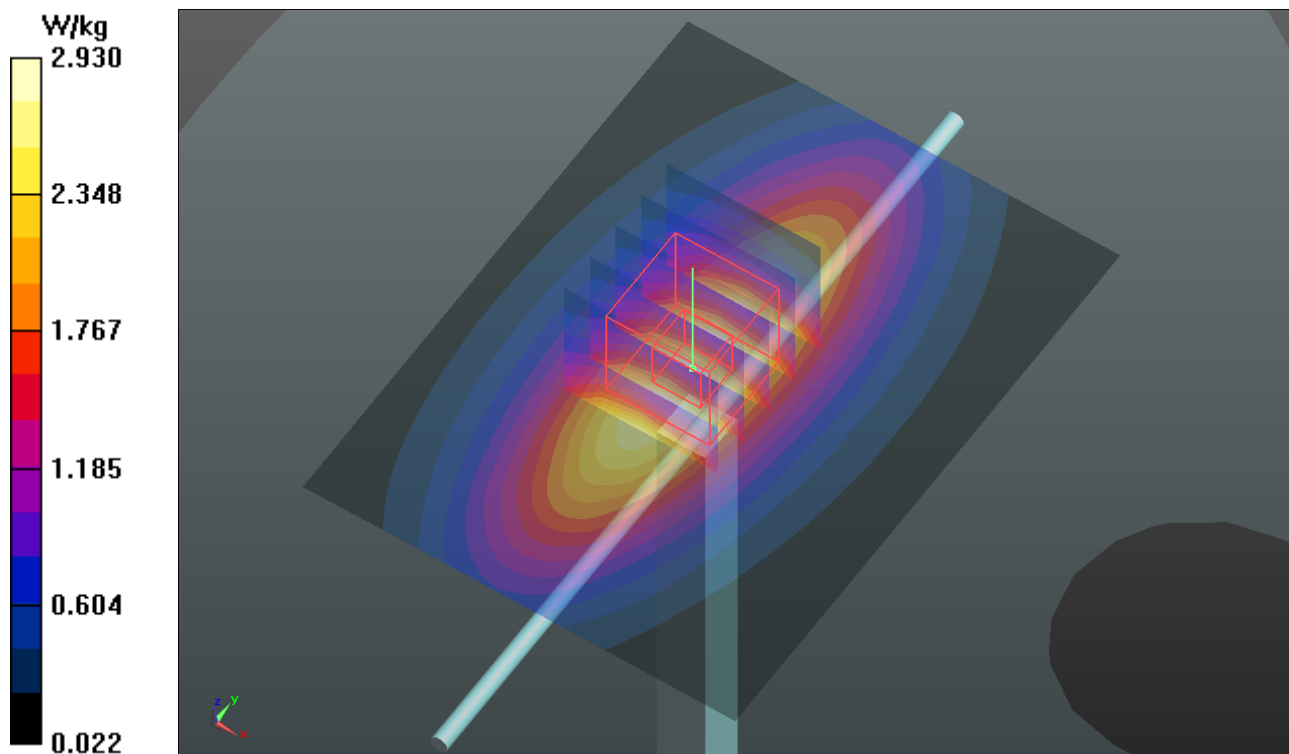

System Check_B1900_131213

DUT: Dipole 1900 MHz; Type: D1900V2; SN: 5d036

Communication System: CW; Frequency: 1900 MHz; Duty Cycle: 1:1

Medium: B1900_1213 Medium parameters used: $f = 1900$ MHz; $\sigma = 1.553$ S/m; $\epsilon_r = 53.382$; $\rho = 1000$ kg/m³

Ambient Temperature : 21.4 °C ; Liquid Temperature : 21.6 °C

DASY5 Configuration:

- Probe: EX3DV4 - SN3590; ConvF(8.39, 8.39, 8.39); Calibrated: 2013/02/20;
- Sensor-Surface: 2mm (Mechanical Surface Detection)
- Electronics: DAE4 Sn861; Calibrated: 2013/03/19
- Phantom: ELI v4.0_Left; Type: QDOVA001BB; Serial: TP:1039
- Measurement SW: DASY52, Version 52.8 (7); SEMCAD X Version 14.6.10 (7164)

Pin=250mW/Area Scan (61x61x1): Interpolated grid: dx=1.500 mm, dy=1.500 mm
Maximum value of SAR (interpolated) = 13.6 W/kg

Pin=250mW/Zoom Scan (5x5x7)/Cube 0: Measurement grid: dx=8mm, dy=8mm, dz=5mm
Reference Value = 94.677 V/m; Power Drift = 0.04 dB
Peak SAR (extrapolated) = 17.4 W/kg
SAR(1 g) = 9.44 W/kg; SAR(10 g) = 4.83 W/kg
Maximum value of SAR (measured) = 13.7 W/kg

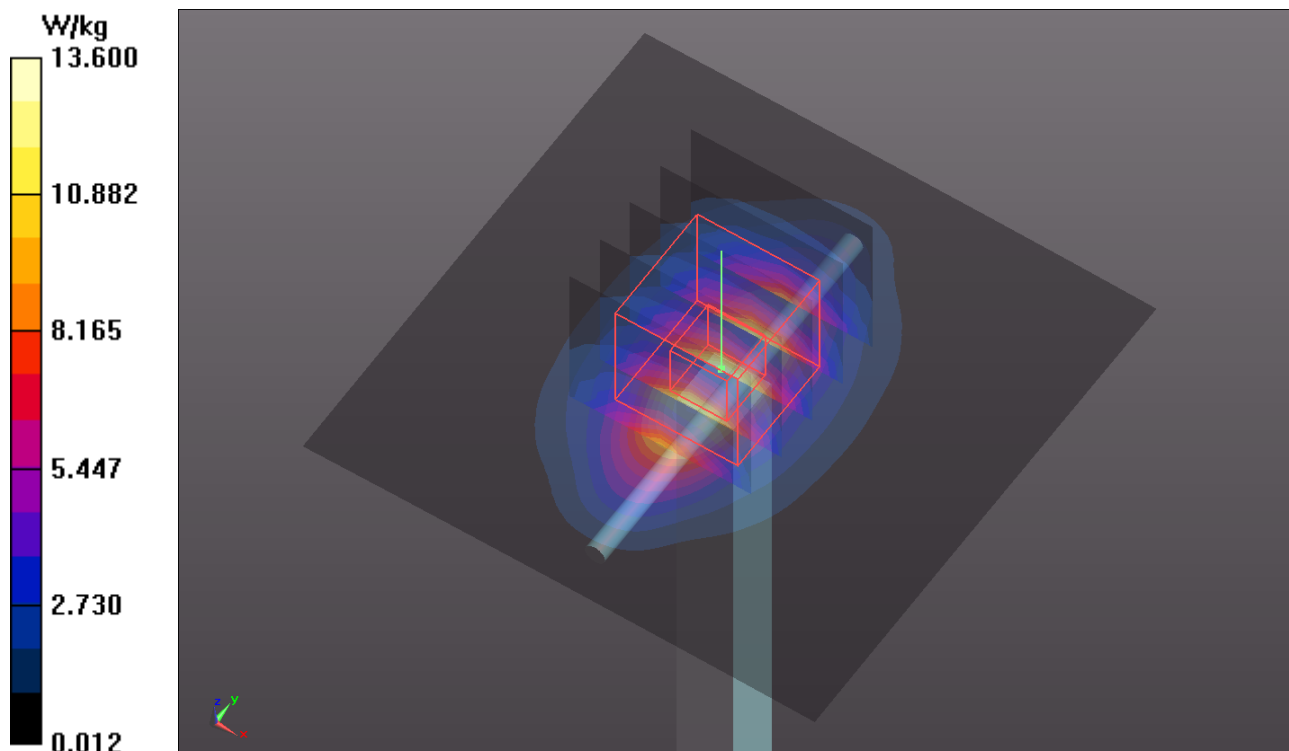

System Check_B2450_131213

DUT: Dipole 2450 MHz; Type: D2450V2; SN: 737

Communication System: CW; Frequency: 2450 MHz; Duty Cycle: 1:1

Medium: B2450_1213 Medium parameters used: $f = 2450$ MHz; $\sigma = 1.972$ S/m; $\epsilon_r = 51.404$; $\rho = 1000$ kg/m³

Ambient Temperature : 20.9 °C; Liquid Temperature : 20.3 °C

DASY5 Configuration:

- Probe: EX3DV4 - SN3650; ConvF(7.09, 7.09, 7.09); Calibrated: 2013/04/30;
- Sensor-Surface: 2mm (Mechanical Surface Detection)
- Electronics: DAE3 Sn360; Calibrated: 2013/01/30
- Phantom: ELI 4.0; Type: QDOVA001BA; Serial: TP:1206
- Measurement SW: DASY52, Version 52.8 (7); SEMCAD X Version 14.6.10 (7164)

Pin=250mW/Area Scan (81x81x1): Interpolated grid: dx=1.200 mm, dy=1.200 mm

Maximum value of SAR (interpolated) = 20.6 W/kg

Pin=250mW/Zoom Scan (7x7x7)/Cube 0: Measurement grid: dx=5mm, dy=5mm, dz=5mm

Reference Value = 101.5 V/m; Power Drift = -0.03 dB

Peak SAR (extrapolated) = 27.5 W/kg

SAR(1 g) = 13.2 W/kg; SAR(10 g) = 6.12 W/kg

Maximum value of SAR (measured) = 20.2 W/kg

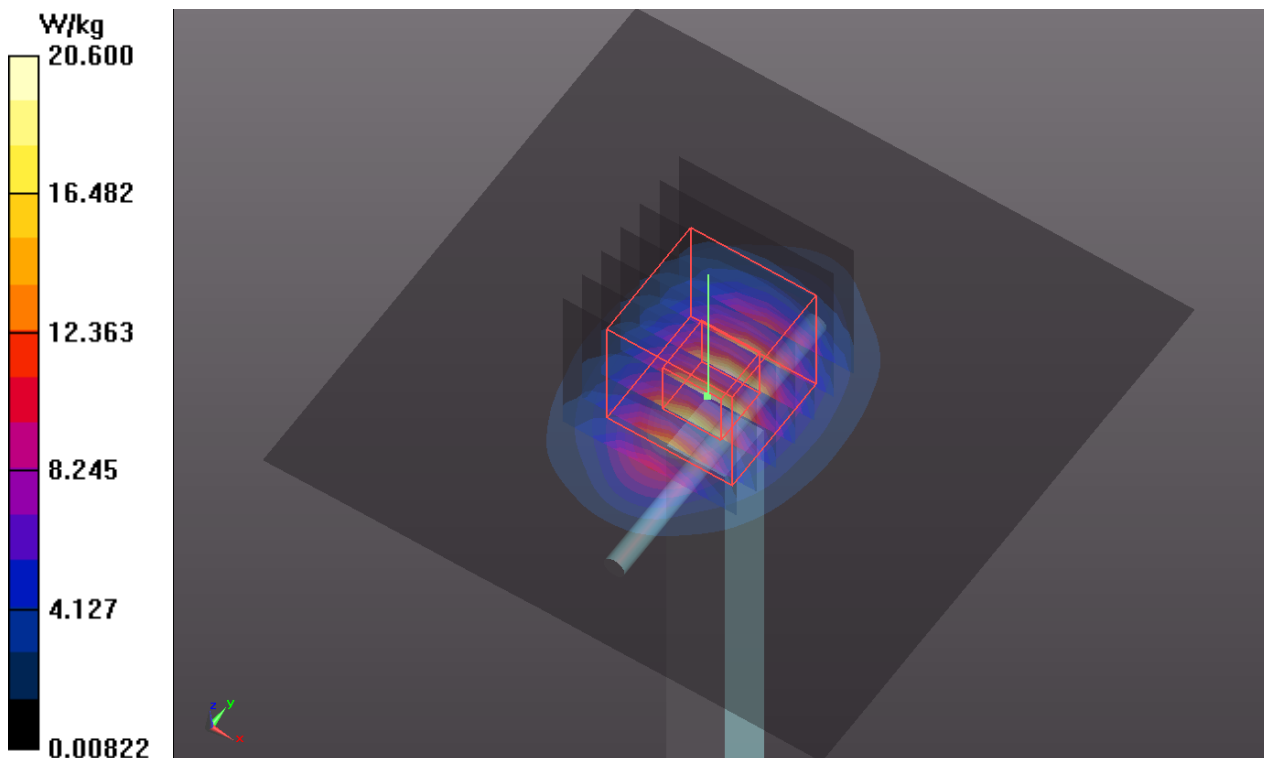

System Check_B2600_131210

DUT: Dipole 2600 MHz; Type: D2600V2; SN: 1020

Communication System: CW; Frequency: 2600 MHz; Duty Cycle: 1:1

Medium: B2600_1210 Medium parameters used: $f = 2600$ MHz; $\sigma = 2.196$ S/m; $\epsilon_r = 52.352$; $\rho = 1000$ kg/m³

Ambient Temperature : 20.7 °C; Liquid Temperature : 20.2 °C

DASY5 Configuration:

- Probe: EX3DV4 - SN3650; ConvF(6.91, 6.91, 6.91); Calibrated: 2013/04/30;
- Sensor-Surface: 2mm (Mechanical Surface Detection)
- Electronics: DAE3 Sn360; Calibrated: 2013/01/30
- Phantom: SAM Phantom_Left; Type: SAM V4.0; Serial: TP 1653
- Measurement SW: DASY52, Version 52.8 (7); SEMCAD X Version 14.6.10 (7164)

Pin=250mW/Area Scan (81x81x1): Interpolated grid: dx=1.200 mm, dy=1.200 mm

Maximum value of SAR (interpolated) = 20.1 W/kg

Pin=250mW/Zoom Scan (7x7x7)/Cube 0: Measurement grid: dx=5mm, dy=5mm, dz=5mm

Reference Value = 95.452 V/m; Power Drift = -0.01 dB

Peak SAR (extrapolated) = 28.4 W/kg

SAR(1 g) = 12.9 W/kg; SAR(10 g) = 5.68 W/kg

Maximum value of SAR (measured) = 20.4 W/kg

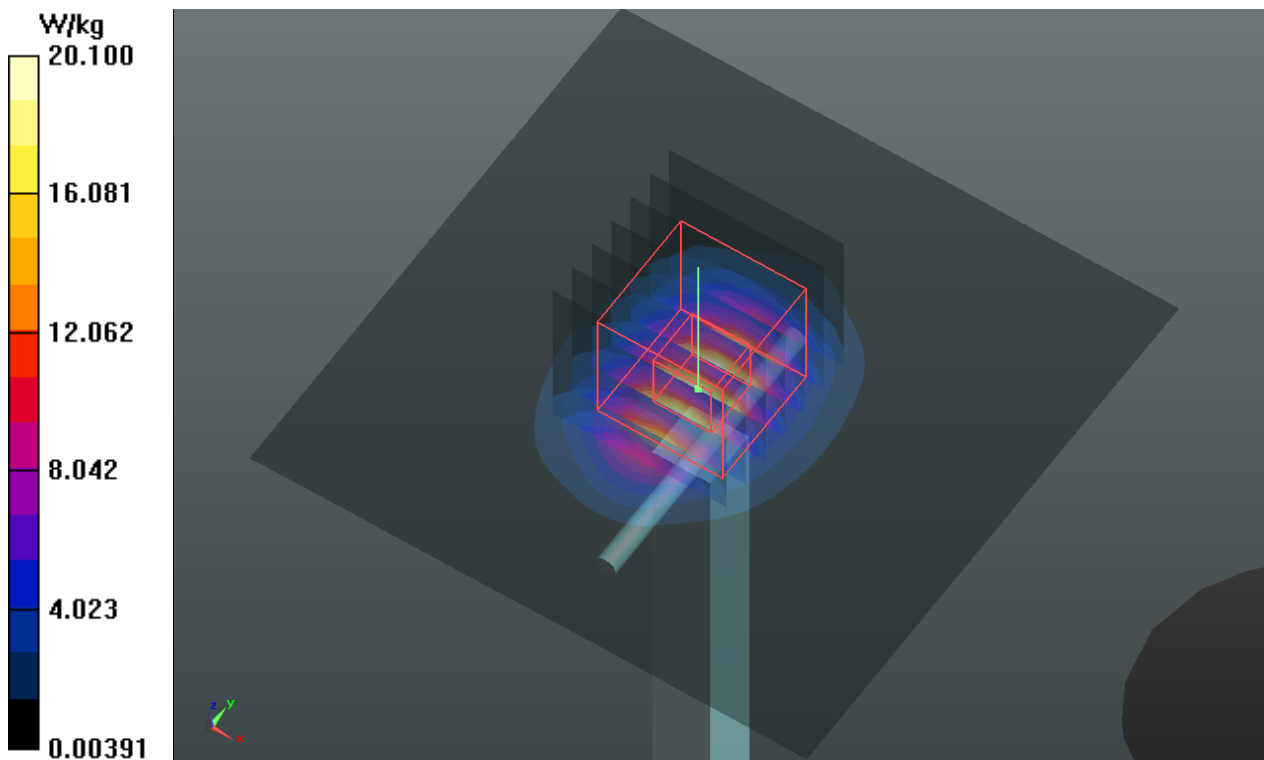



Appendix B. SAR Plots of SAR Measurement

The SAR plots for highest measured SAR in each exposure configuration, wireless mode and frequency band combination, and measured SAR > 1.5 W/kg are shown as follows.

P01 CDMA2000 BC0_RC3+SO55_Left Cheek_Ch384

DUT: 131119C06

Communication System: CDMA2000; Frequency: 836.52 MHz; Duty Cycle: 1:1
Medium: H835_1208 Medium parameters used: $f = 837$ MHz; $\sigma = 0.89$ S/m; $\epsilon_r = 42.812$; $\rho = 1000$ kg/m³
Ambient Temperature : 21.6 °C; Liquid Temperature : 20.5 °C

DASY5 Configuration:

- Probe: EX3DV4 - SN3650; ConvF(9.37, 9.37, 9.37); Calibrated: 2013/04/30;
- Sensor-Surface: 2mm (Mechanical Surface Detection)
- Electronics: DAE3 Sn360; Calibrated: 2013/01/30
- Phantom: SAM Phantom_Left; Type: SAM V4.0; Serial: TP 1653
- Measurement SW: DASY52, Version 52.8 (7); SEMCAD X Version 14.6.10 (7164)

- **Area Scan (51x101x1):** Interpolated grid: dx=1.500 mm, dy=1.500 mm
Maximum value of SAR (interpolated) = 0.495 W/kg

- **Zoom Scan (5x5x7)/Cube 0:** Measurement grid: dx=8mm, dy=8mm, dz=5mm
Reference Value = 8.466 V/m; Power Drift = 0.12 dB
Peak SAR (extrapolated) = 0.544 W/kg
SAR(1 g) = 0.413 W/kg; SAR(10 g) = 0.298 W/kg
Maximum value of SAR (measured) = 0.483 W/kg

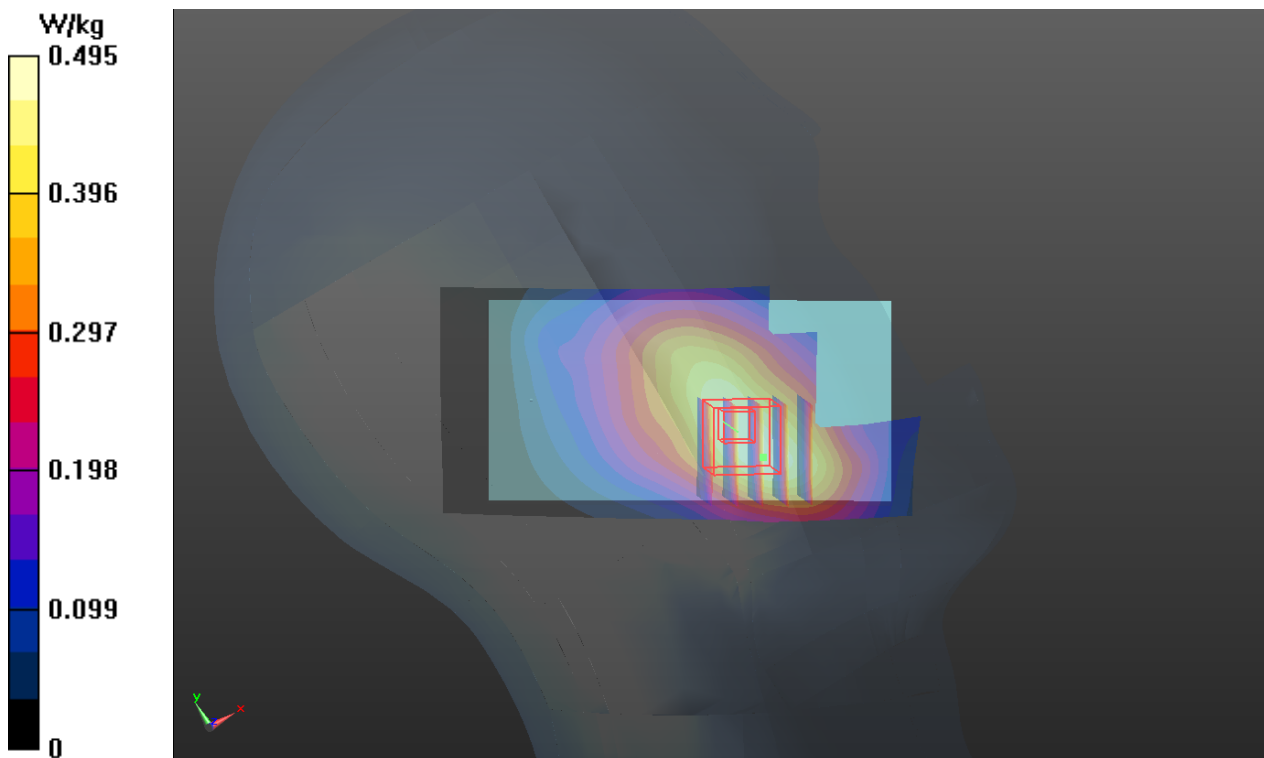

P02 CDMA2000 BC1_RC3+SO55_Left Cheek_Ch25

DUT: 131119C06

Communication System: CDMA2000; Frequency: 1851.25 MHz; Duty Cycle: 1:1
Medium: H1900_1206 Medium parameters used: $f = 1851.25$ MHz; $\sigma = 1.339$ S/m; $\epsilon_r = 39.873$; $\rho = 1000$ kg/m³
Ambient Temperature : 21.1 °C; Liquid Temperature : 20.7 °C

DASY5 Configuration:

- Probe: EX3DV4 - SN3650; ConvF(7.73, 7.73, 7.73); Calibrated: 2013/04/30;
- Sensor-Surface: 2mm (Mechanical Surface Detection)
- Electronics: DAE3 Sn360; Calibrated: 2013/01/30
- Phantom: SAM Phantom_Left; Type: SAM V4.0; Serial: TP 1653
- Measurement SW: DASY52, Version 52.8 (7); SEMCAD X Version 14.6.10 (7164)

- **Area Scan (51x91x1):** Interpolated grid: dx=1.500 mm, dy=1.500 mm
Maximum value of SAR (interpolated) = 0.800 W/kg

- **Zoom Scan (5x5x7)/Cube 0:** Measurement grid: dx=8mm, dy=8mm, dz=5mm

Reference Value = 8.923 V/m; Power Drift = 0.13 dB

Peak SAR (extrapolated) = 1.09 W/kg

SAR(1 g) = 0.745 W/kg; SAR(10 g) = 0.472 W/kg

Maximum value of SAR (measured) = 0.892 W/kg

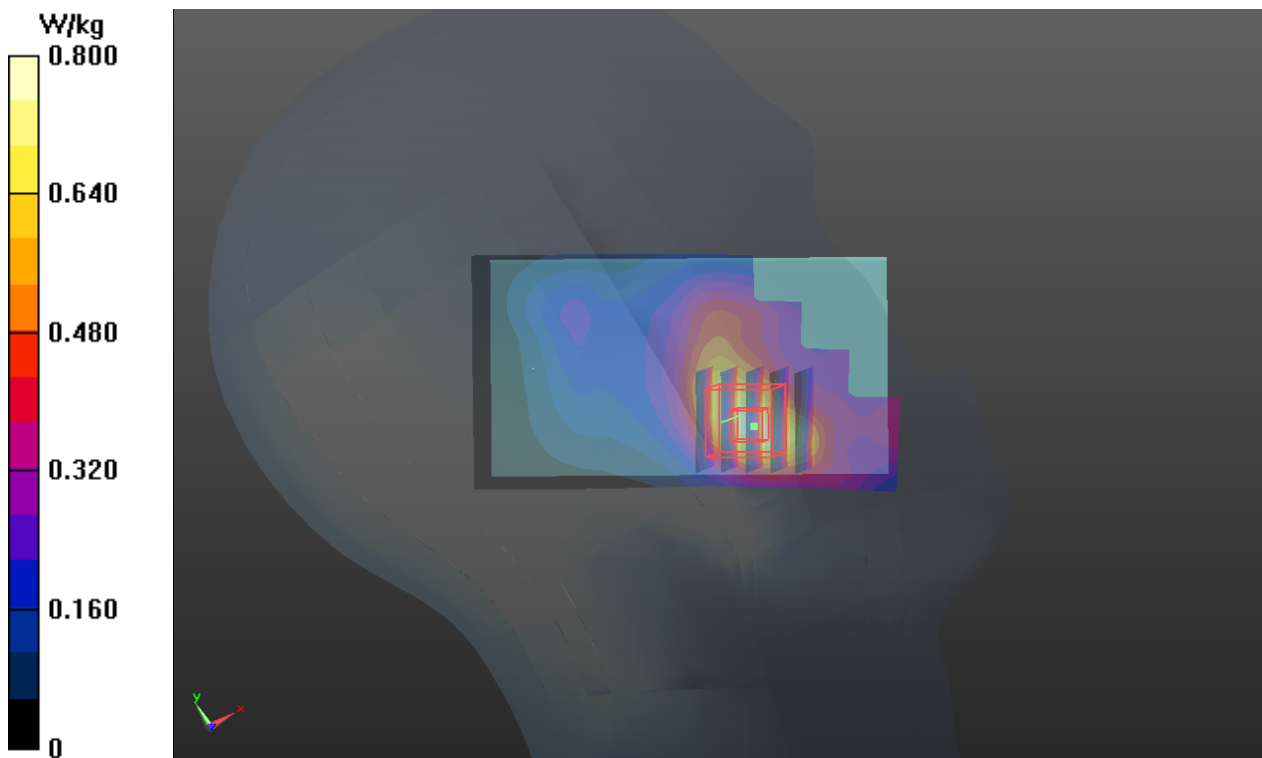

P03 CDMA2000 BC10_RC3+SO55_Left Cheek_Ch580

DUT: 131119C06

Communication System: CDMA2000; Frequency: 820.5 MHz; Duty Cycle: 1:1
Medium: H835_1208 Medium parameters used: $f = 820.5$ MHz; $\sigma = 0.873$ S/m; $\epsilon_r = 42.99$; $\rho = 1000$ kg/m³
Ambient Temperature : 21.6 °C; Liquid Temperature : 20.5 °C

DASY5 Configuration:

- Probe: EX3DV4 - SN3650; ConvF(9.37, 9.37, 9.37); Calibrated: 2013/04/30;
- Sensor-Surface: 2mm (Mechanical Surface Detection)
- Electronics: DAE3 Sn360; Calibrated: 2013/01/30
- Phantom: SAM Phantom_Left; Type: SAM V4.0; Serial: TP 1653
- Measurement SW: DASY52, Version 52.8 (7); SEMCAD X Version 14.6.10 (7164)

- **Area Scan (51x101x1):** Interpolated grid: dx=1.500 mm, dy=1.500 mm
Maximum value of SAR (interpolated) = 0.440 W/kg

- **Zoom Scan (5x5x7)/Cube 0:** Measurement grid: dx=8mm, dy=8mm, dz=5mm
Reference Value = 8.048 V/m; Power Drift = 0.08 dB
Peak SAR (extrapolated) = 0.522 W/kg
SAR(1 g) = 0.393 W/kg; SAR(10 g) = 0.284 W/kg
Maximum value of SAR (measured) = 0.461 W/kg

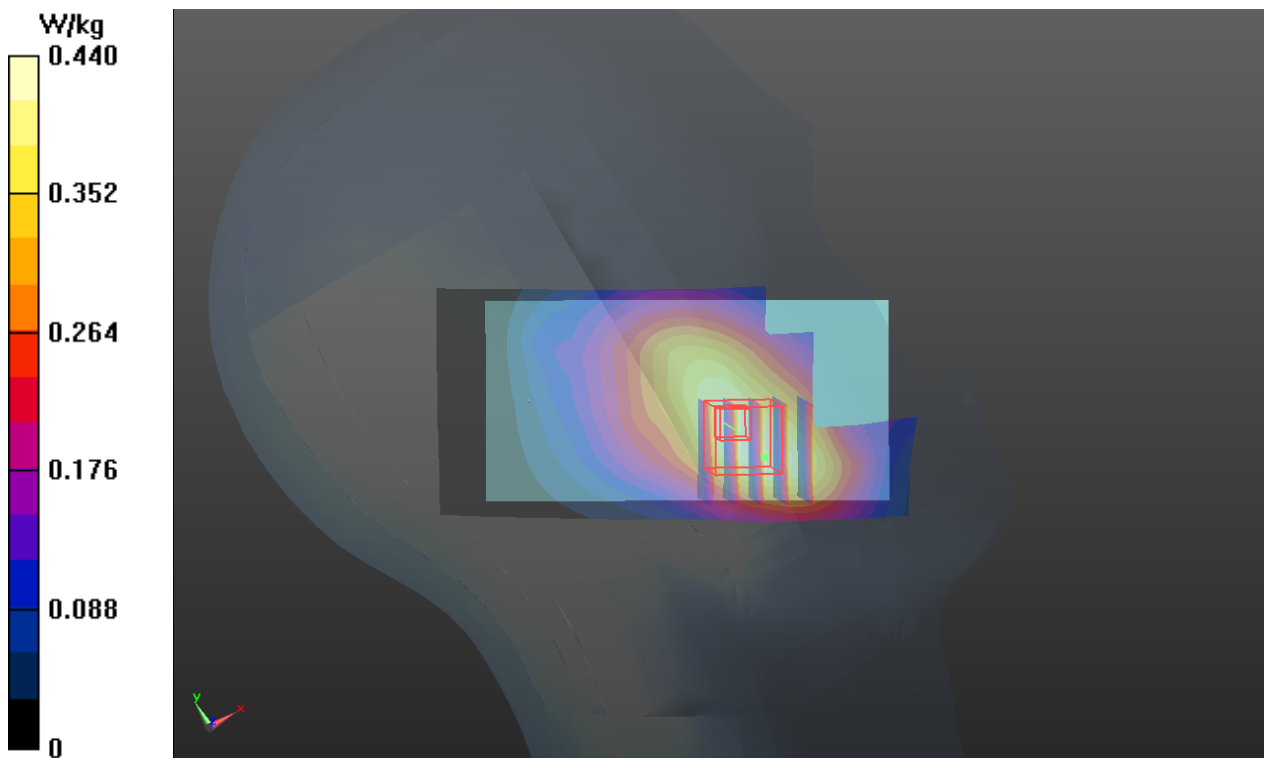

P04 LTE 25_QPSK10M_Left Cheek_Ch26640_1RB_offset 0

DUT: 131119C06

Communication System: LTE; Frequency: 1910 MHz; Duty Cycle: 1:1

Medium: H1900_1206 Medium parameters used: $f = 1910$ MHz; $\sigma = 1.419$ S/m; $\epsilon_r = 39.565$; $\rho = 1000$ kg/m³

Ambient Temperature : 21.1 °C; Liquid Temperature : 20.7 °C

DASY5 Configuration:

- Probe: EX3DV4 - SN3650; ConvF(7.73, 7.73, 7.73); Calibrated: 2013/04/30;
- Sensor-Surface: 2mm (Mechanical Surface Detection)
- Electronics: DAE3 Sn360; Calibrated: 2013/01/30
- Phantom: SAM Phantom_Left; Type: SAM V4.0; Serial: TP 1653
- Measurement SW: DASY52, Version 52.8 (7); SEMCAD X Version 14.6.10 (7164)

- **Area Scan (51x91x1):** Interpolated grid: dx=1.500 mm, dy=1.500 mm

Maximum value of SAR (interpolated) = 0.572 W/kg

- **Zoom Scan (5x5x7)/Cube 0:** Measurement grid: dx=8mm, dy=8mm, dz=5mm

Reference Value = 6.788 V/m; Power Drift = 0.06 dB

Peak SAR (extrapolated) = 0.691 W/kg

SAR(1 g) = 0.474 W/kg; SAR(10 g) = 0.299 W/kg

Maximum value of SAR (measured) = 0.572 W/kg

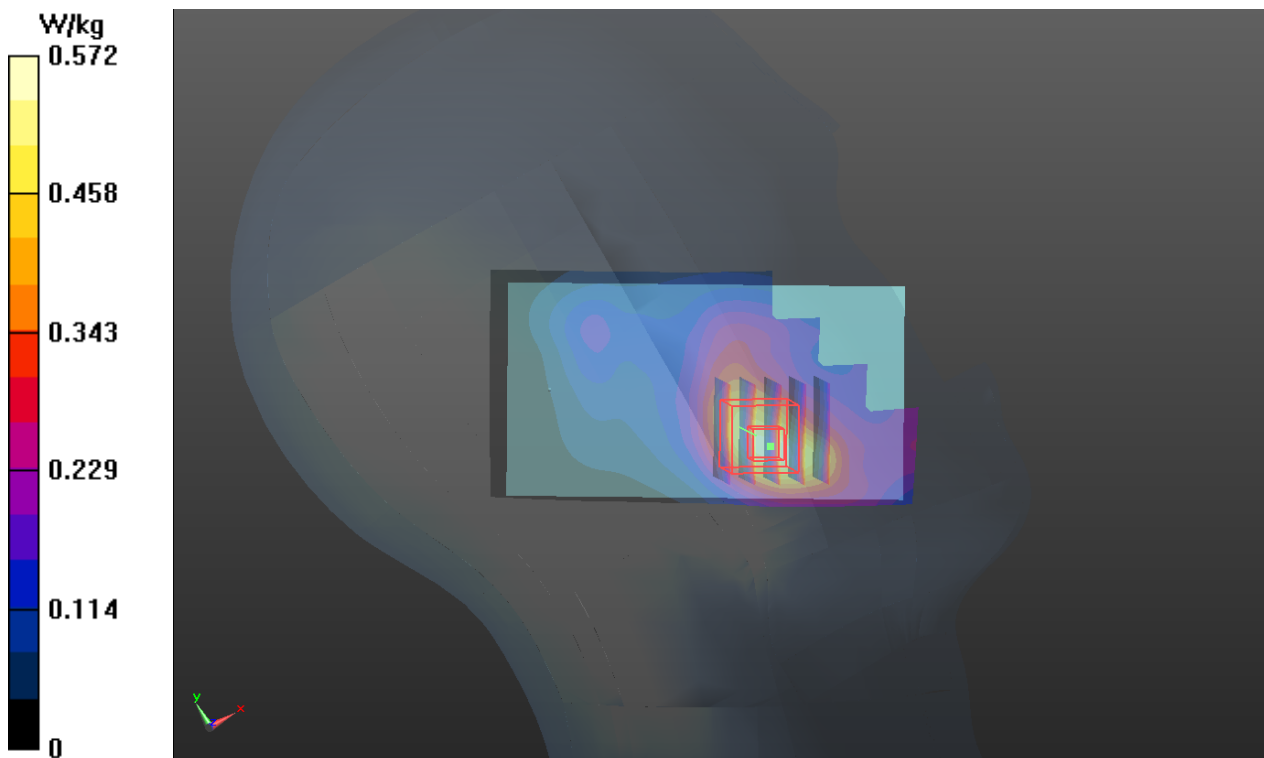

P05 LTE 26_QPSK10M_Left Cheek_Ch26990_1RB_offset 24

DUT: 131119C06

Communication System: LTE; Frequency: 844 MHz; Duty Cycle: 1:1

Medium: H835_1208 Medium parameters used: $f = 844$ MHz; $\sigma = 0.898$ S/m; $\epsilon_r = 42.728$; $\rho = 1000$ kg/m³

Ambient Temperature : 21.6 °C; Liquid Temperature : 20.5 °C

DASY5 Configuration:

- Probe: EX3DV4 - SN3650; ConvF(9.37, 9.37, 9.37); Calibrated: 2013/04/30;
- Sensor-Surface: 2mm (Mechanical Surface Detection)
- Electronics: DAE3 Sn360; Calibrated: 2013/01/30
- Phantom: SAM Phantom_Left; Type: SAM V4.0; Serial: TP 1653
- Measurement SW: DASY52, Version 52.8 (7); SEMCAD X Version 14.6.10 (7164)

- **Area Scan (51x101x1):** Interpolated grid: dx=1.500 mm, dy=1.500 mm

Maximum value of SAR (interpolated) = 0.378 W/kg

- **Zoom Scan (5x5x7)/Cube 0:** Measurement grid: dx=8mm, dy=8mm, dz=5mm

Reference Value = 7.435 V/m; Power Drift = -0.04 dB

Peak SAR (extrapolated) = 0.433 W/kg

SAR(1 g) = 0.328 W/kg; SAR(10 g) = 0.238 W/kg

Maximum value of SAR (measured) = 0.382 W/kg

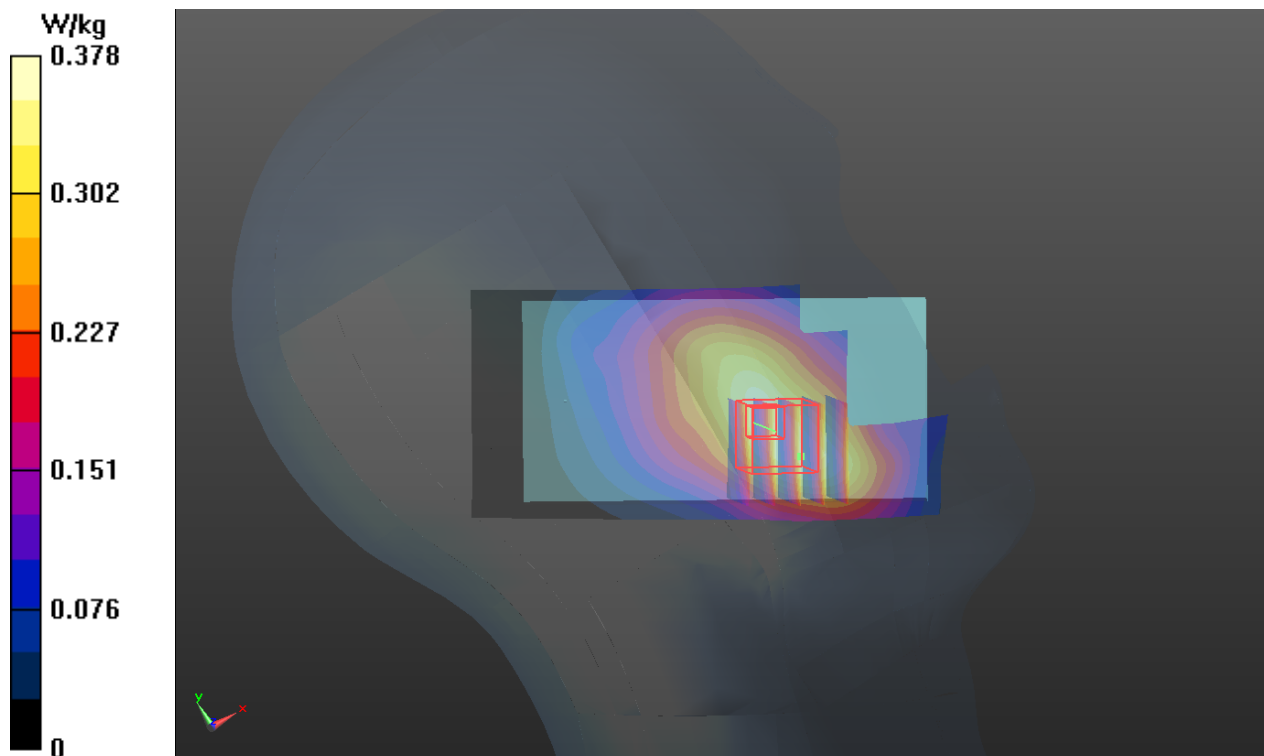

P06 LTE 41_QPSK20M_Right Cheek_Ch41490_1RB_offset 50

DUT: 131114C03

Communication System: LTE TDD CF0; Frequency: 2680 MHz; Duty Cycle: 1:1.58
Medium: H2600_1207 Medium parameters used: $f = 2680$ MHz; $\sigma = 2.146$ S/m; $\epsilon_r = 37.441$; $\rho = 1000$ kg/m³
Ambient Temperature : 21.7 °C; Liquid Temperature : 21.2 °C

DASY5 Configuration:

- Probe: EX3DV4 - SN3650; ConvF(6.85, 6.85, 6.85); Calibrated: 2013/04/30;
- Sensor-Surface: 2mm (Mechanical Surface Detection)
- Electronics: DAE3 Sn360; Calibrated: 2013/01/30
- Phantom: SAM Phantom_Front; Type: SAM V4.0; Serial: TP 1654
- Measurement SW: DASY52, Version 52.8 (7); SEMCAD X Version 14.6.10 (7164)

- **Area Scan (61x131x1):** Interpolated grid: dx=1.200 mm, dy=1.200 mm
Maximum value of SAR (interpolated) = 1.77 W/kg

- **Zoom Scan (5x5x7)/Cube 0:** Measurement grid: dx=8mm, dy=8mm, dz=5mm
Reference Value = 6.007 V/m; Power Drift = 0.14 dB
Peak SAR (extrapolated) = 2.20 W/kg
SAR(1 g) = 1.16 W/kg; SAR(10 g) = 0.596 W/kg
Maximum value of SAR (measured) = 1.66 W/kg

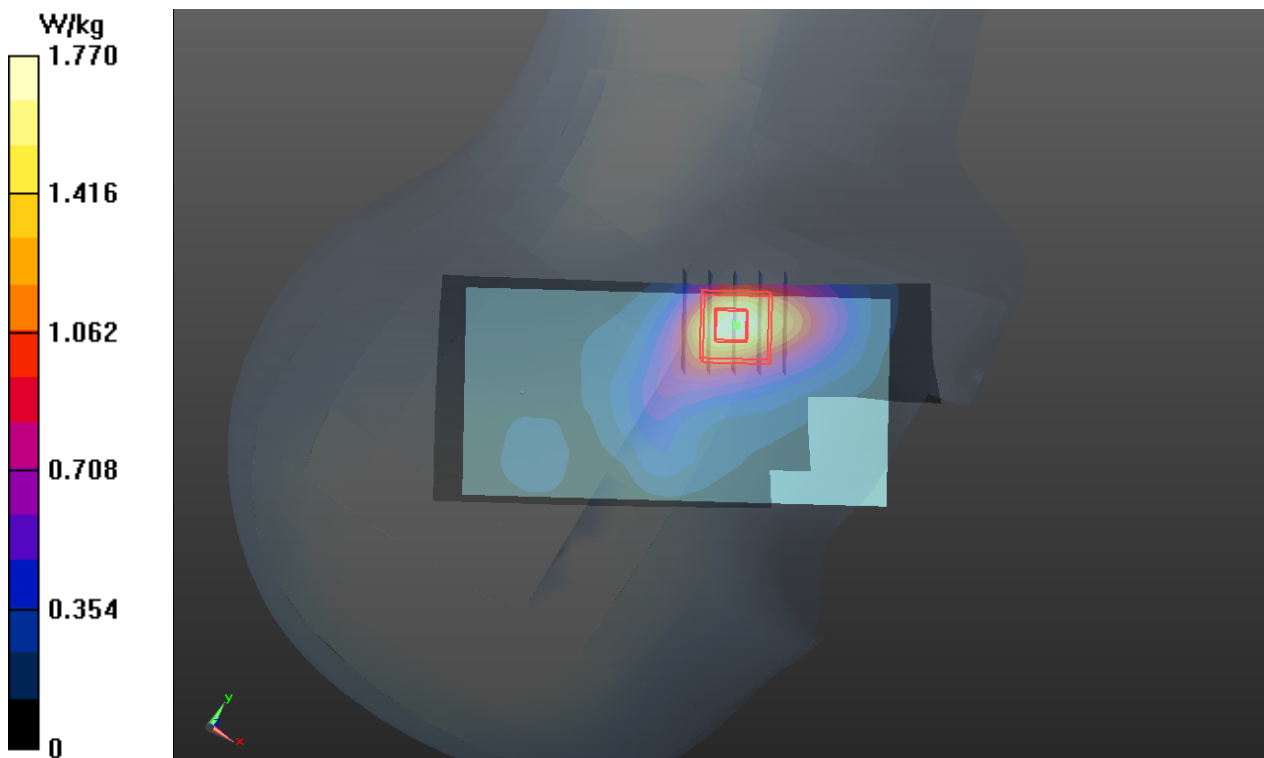

P07 802.11b_Left Cheek_Ch6

DUT: 131114C03

Communication System: WLAN_2.4G; Frequency: 2437 MHz; Duty Cycle: 1:1
Medium: H2450_1208 Medium parameters used: $f = 2437$ MHz; $\sigma = 1.864$ S/m; $\epsilon_r = 38.724$; $\rho = 1000$ kg/m³
Ambient Temperature : 21.6 °C; Liquid Temperature : 20.6 °C

DASY5 Configuration:

- Probe: EX3DV4 - SN3650; ConvF(6.99, 6.99, 6.99); Calibrated: 2013/04/30;
- Sensor-Surface: 2mm (Mechanical Surface Detection)
- Electronics: DAE3 Sn360; Calibrated: 2013/01/30
- Phantom: SAM Phantom_Front; Type: SAM V4.0; Serial: TP 1654
- Measurement SW: DASY52, Version 52.8 (7); SEMCAD X Version 14.6.10 (7164)

- **Area Scan (71x131x1):** Interpolated grid: dx=1.200 mm, dy=1.200 mm
Maximum value of SAR (interpolated) = 0.231 W/kg

- **Zoom Scan (5x5x7)/Cube 0:** Measurement grid: dx=8mm, dy=8mm, dz=5mm
Reference Value = 3.001 V/m; Power Drift = 0.06 dB
Peak SAR (extrapolated) = 0.313 W/kg
SAR(1 g) = 0.141 W/kg; SAR(10 g) = 0.070 W/kg
Maximum value of SAR (measured) = 0.220 W/kg

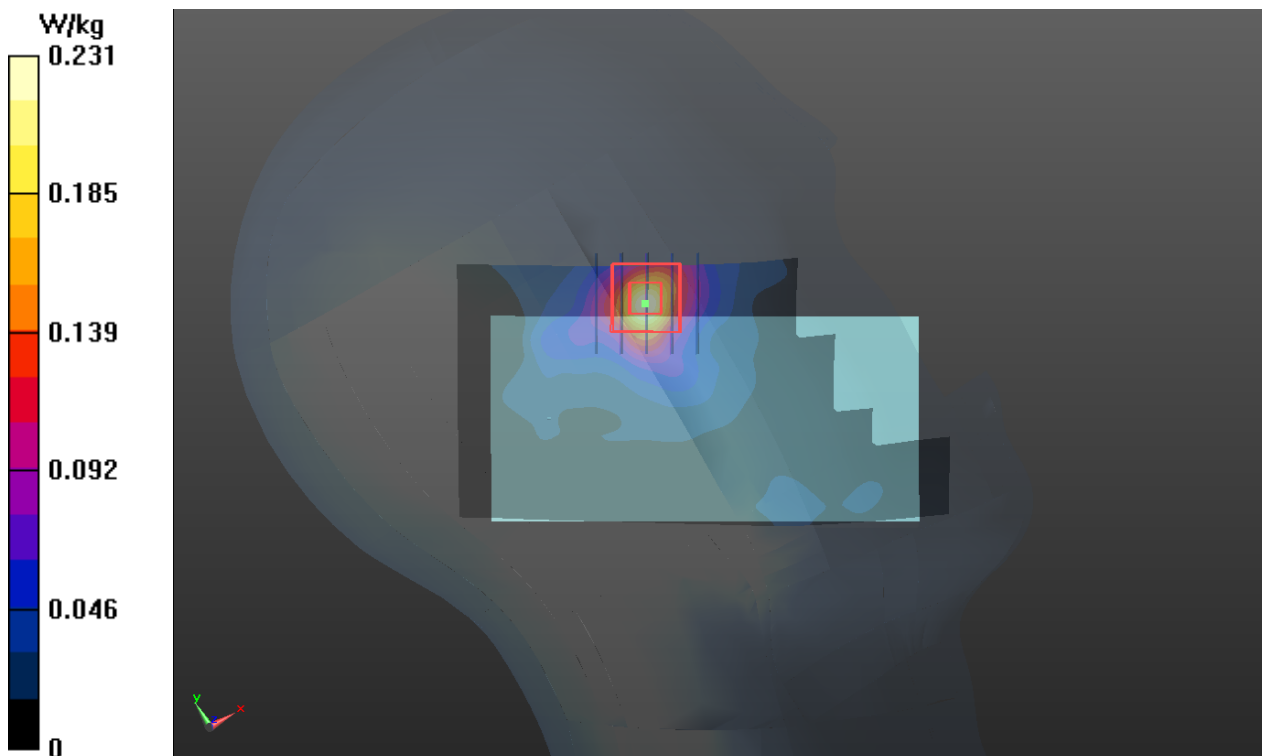

P08 CDMA2000 BC0_RTAP 153.6_Front Face_1cm_Ch384

DUT: 131119C06

Communication System: CDMA2000; Frequency: 836.52 MHz; Duty Cycle: 1:1
Medium: B835_1209 Medium parameters used: $f = 837$ MHz; $\sigma = 0.974$ S/m; $\epsilon_r = 53.996$; $\rho = 1000$ kg/m³
Ambient Temperature : 21.3 °C; Liquid Temperature : 20.8 °C

DASY5 Configuration:

- Probe: EX3DV4 - SN3650; ConvF(9.35, 9.35, 9.35); Calibrated: 2013/04/30;
- Sensor-Surface: 2mm (Mechanical Surface Detection)
- Electronics: DAE3 Sn360; Calibrated: 2013/01/30
- Phantom: SAM Phantom_Front; Type: SAM V4.0; Serial: TP 1654
- Measurement SW: DASY52, Version 52.8 (7); SEMCAD X Version 14.6.10 (7164)

- **Area Scan (51x101x1):** Interpolated grid: dx=1.500 mm, dy=1.500 mm
Maximum value of SAR (interpolated) = 0.648 W/kg

- **Zoom Scan (5x5x7)/Cube 0:** Measurement grid: dx=8mm, dy=8mm, dz=5mm
Reference Value = 24.049 V/m; Power Drift = 0.06 dB
Peak SAR (extrapolated) = 0.727 W/kg
SAR(1 g) = 0.541 W/kg; SAR(10 g) = 0.413 W/kg
Maximum value of SAR (measured) = 0.633 W/kg

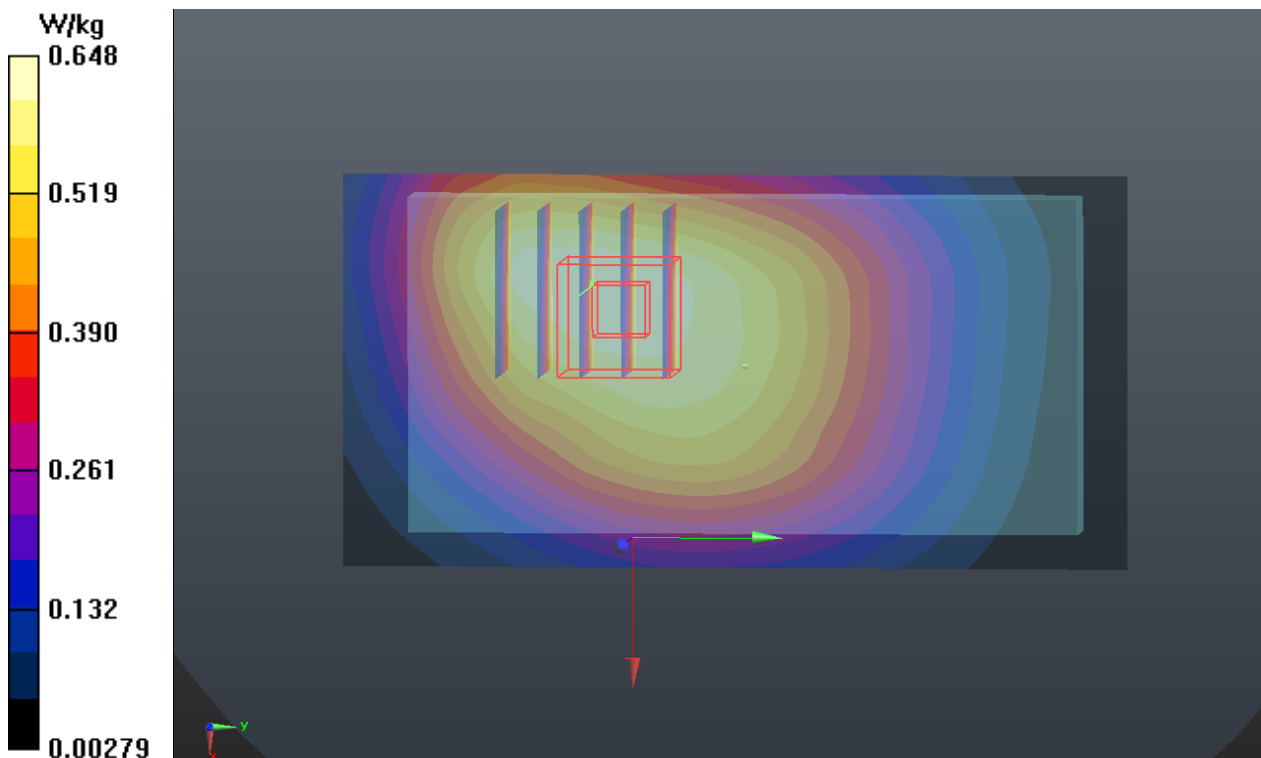

P09 CDMA2000 BC1_RTAP 153.6_Front Face_1cm_Ch25

DUT: 131119C06

Communication System: CDMA2000; Frequency: 1851.25 MHz; Duty Cycle: 1:1
Medium: B1900_1209 Medium parameters used: $f = 1851.25$ MHz; $\sigma = 1.49$ S/m; $\epsilon_r = 52.12$; $\rho = 1000$ kg/m³
Ambient Temperature : 21.2 °C; Liquid Temperature : 20.7 °C

DASY5 Configuration:

- Probe: EX3DV4 - SN3650; ConvF(7.39, 7.39, 7.39); Calibrated: 2013/04/30;
- Sensor-Surface: 2mm (Mechanical Surface Detection)
- Electronics: DAE3 Sn360; Calibrated: 2013/01/30
- Phantom: ELI 4.0; Type: QDOVA001BA; Serial: TP:1206
- Measurement SW: DASY52, Version 52.8 (7); SEMCAD X Version 14.6.10 (7164)

- **Area Scan (51x101x1):** Interpolated grid: dx=1.500 mm, dy=1.500 mm
Maximum value of SAR (interpolated) = 1.18 W/kg

- **Zoom Scan (5x5x7)/Cube 0:** Measurement grid: dx=8mm, dy=8mm, dz=5mm
Reference Value = 9.828 V/m; Power Drift = 0.14 dB
Peak SAR (extrapolated) = 1.56 W/kg
SAR(1 g) = 0.883 W/kg; SAR(10 g) = 0.492 W/kg
Maximum value of SAR (measured) = 1.19 W/kg

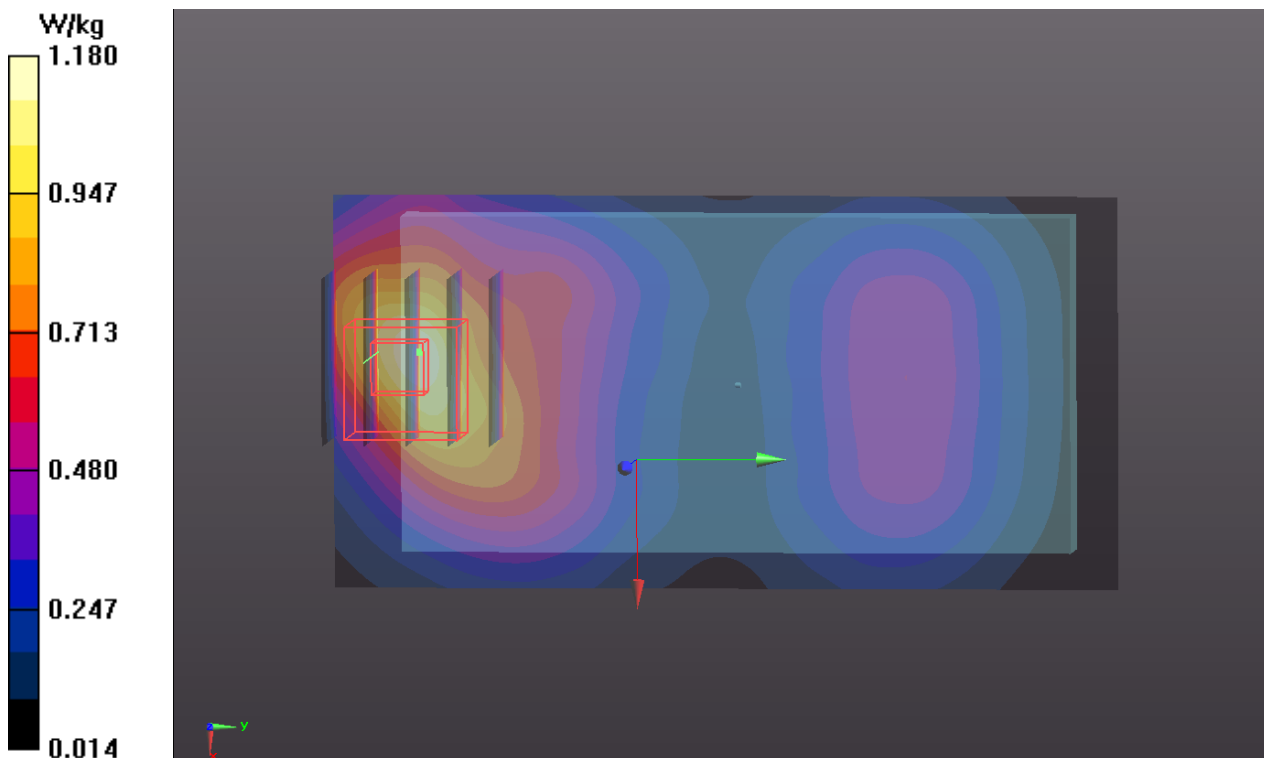

P10 CDMA2000 BC10_RTAP 153.6_Rear Face_1cm_Ch580

DUT: 131119C06

Communication System: CDMA2000; Frequency: 820.5 MHz; Duty Cycle: 1:1
Medium: B835_1209 Medium parameters used: $f = 820.5$ MHz; $\sigma = 0.956$ S/m; $\epsilon_r = 54.13$; $\rho = 1000$ kg/m³
Ambient Temperature : 21.3 °C; Liquid Temperature : 20.8 °C

DASY5 Configuration:

- Probe: EX3DV4 - SN3650; ConvF(9.35, 9.35, 9.35); Calibrated: 2013/04/30;
- Sensor-Surface: 2mm (Mechanical Surface Detection)
- Electronics: DAE3 Sn360; Calibrated: 2013/01/30
- Phantom: SAM Phantom_Front; Type: SAM V4.0; Serial: TP 1654
- Measurement SW: DASY52, Version 52.8 (7); SEMCAD X Version 14.6.10 (7164)

- **Area Scan (51x101x1):** Interpolated grid: dx=1.500 mm, dy=1.500 mm
Maximum value of SAR (interpolated) = 0.630 W/kg

- **Zoom Scan (5x5x7)/Cube 0:** Measurement grid: dx=8mm, dy=8mm, dz=5mm
Reference Value = 25.316 V/m; Power Drift = -0.01 dB
Peak SAR (extrapolated) = 0.720 W/kg
SAR(1 g) = 0.545 W/kg; SAR(10 g) = 0.416 W/kg
Maximum value of SAR (measured) = 0.640 W/kg

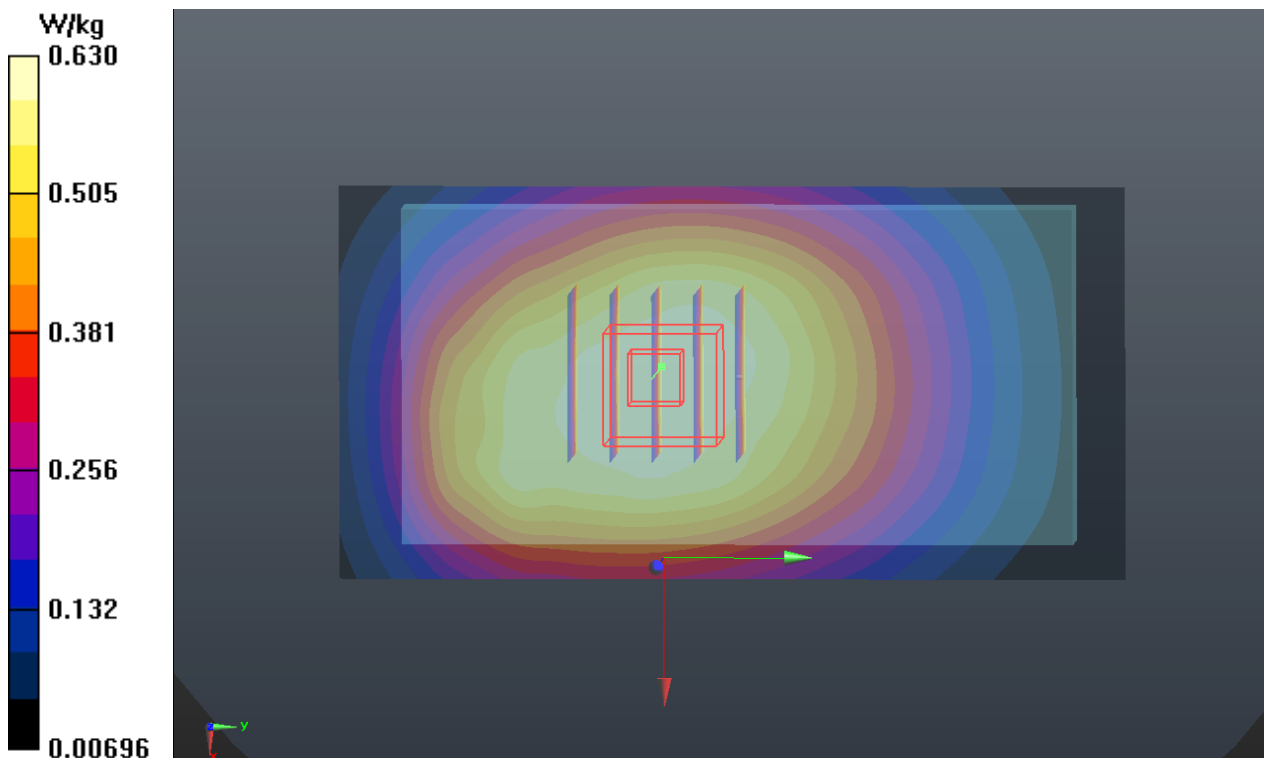

P11 LTE 25_QPSK10M_Rear Face_1cm_Ch26640_1RB_offset 0

DUT: 131119C06

Communication System: LTE; Frequency: 1910 MHz; Duty Cycle: 1:1

Medium: B1900_1213 Medium parameters used: $f = 1910$ MHz; $\sigma = 1.565$ S/m; $\epsilon_r = 53.371$; $\rho = 1000$ kg/m³

Ambient Temperature : 21.4 °C ; Liquid Temperature : 21.6 °C

DASY5 Configuration:

- Probe: EX3DV4 - SN3590; ConvF(8.39, 8.39, 8.39); Calibrated: 2013/02/20;
- Sensor-Surface: 2mm (Mechanical Surface Detection)
- Electronics: DAE4 Sn861; Calibrated: 2013/03/19
- Phantom: ELI v4.0_Left; Type: QDOVA001BB; Serial: TP:1039
- Measurement SW: DASY52, Version 52.8 (7); SEMCAD X Version 14.6.10 (7164)

- **Area Scan (61x101x1):** Interpolated grid: dx=1.500 mm, dy=1.500 mm

Maximum value of SAR (interpolated) = 0.808 W/kg

- **Zoom Scan (5x5x7)/Cube 0:** Measurement grid: dx=8mm, dy=8mm, dz=5mm

Reference Value = 6.118 V/m; Power Drift = -0.06 dB

Peak SAR (extrapolated) = 1.07 W/kg

SAR(1 g) = 0.592 W/kg; SAR(10 g) = 0.299 W/kg

Maximum value of SAR (measured) = 0.792 W/kg

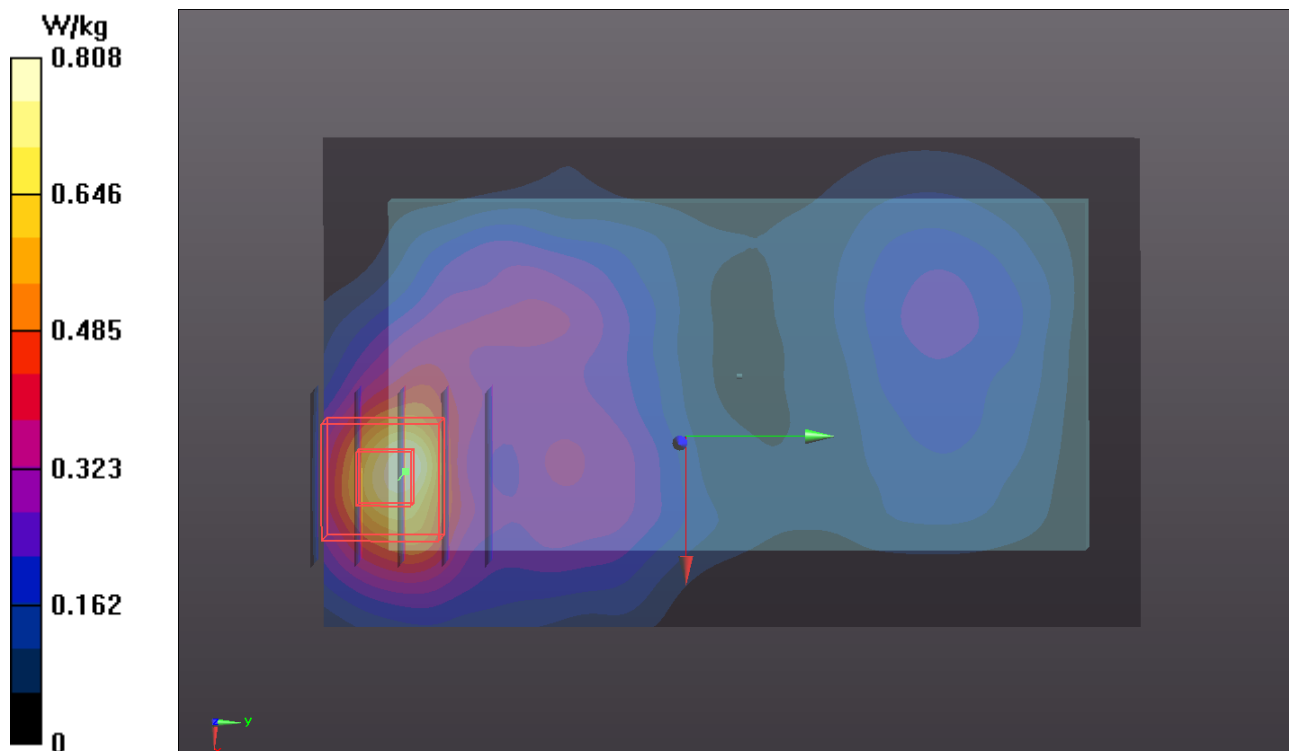

P12 LTE 26_QPSK10M_Rear Face_1cm_Ch26990_1RB_offset 24

DUT: 131119C06

Communication System: LTE; Frequency: 844 MHz; Duty Cycle: 1:1

Medium: B835_1213 Medium parameters used: $f = 844$ MHz; $\sigma = 0.983$ S/m; $\epsilon_r = 54.125$; $\rho = 1000$ kg/m³

Ambient Temperature : 21.6 °C ; Liquid Temperature : 21.8 °C

DASY5 Configuration:

- Probe: EX3DV4 - SN3590; ConvF(10.43, 10.43, 10.43); Calibrated: 2013/02/20;
- Sensor-Surface: 2mm (Mechanical Surface Detection)
- Electronics: DAE4 Sn861; Calibrated: 2013/03/19
- Phantom: SAM Phantom_Front; Type: SAM V4.0; Serial: TP 1202
- Measurement SW: DASY52, Version 52.8 (7); SEMCAD X Version 14.6.10 (7164)

- **Area Scan (51x101x1):** Interpolated grid: dx=1.500 mm, dy=1.500 mm
Maximum value of SAR (interpolated) = 0.460 W/kg

- **Zoom Scan (5x5x7)/Cube 0:** Measurement grid: dx=8mm, dy=8mm, dz=5mm
Reference Value = 21.812 V/m; Power Drift = 0.11 dB
Peak SAR (extrapolated) = 0.521 W/kg
SAR(1 g) = 0.397 W/kg; SAR(10 g) = 0.302 W/kg
Maximum value of SAR (measured) = 0.464 W/kg

- **Zoom Scan (5x5x7)/Cube 1:** Measurement grid: dx=8mm, dy=8mm, dz=5mm
Reference Value = 21.812 V/m; Power Drift = 0.11 dB
Peak SAR (extrapolated) = 0.472 W/kg
SAR(1 g) = 0.350 W/kg; SAR(10 g) = 0.249 W/kg
Maximum value of SAR (measured) = 0.428 W/kg

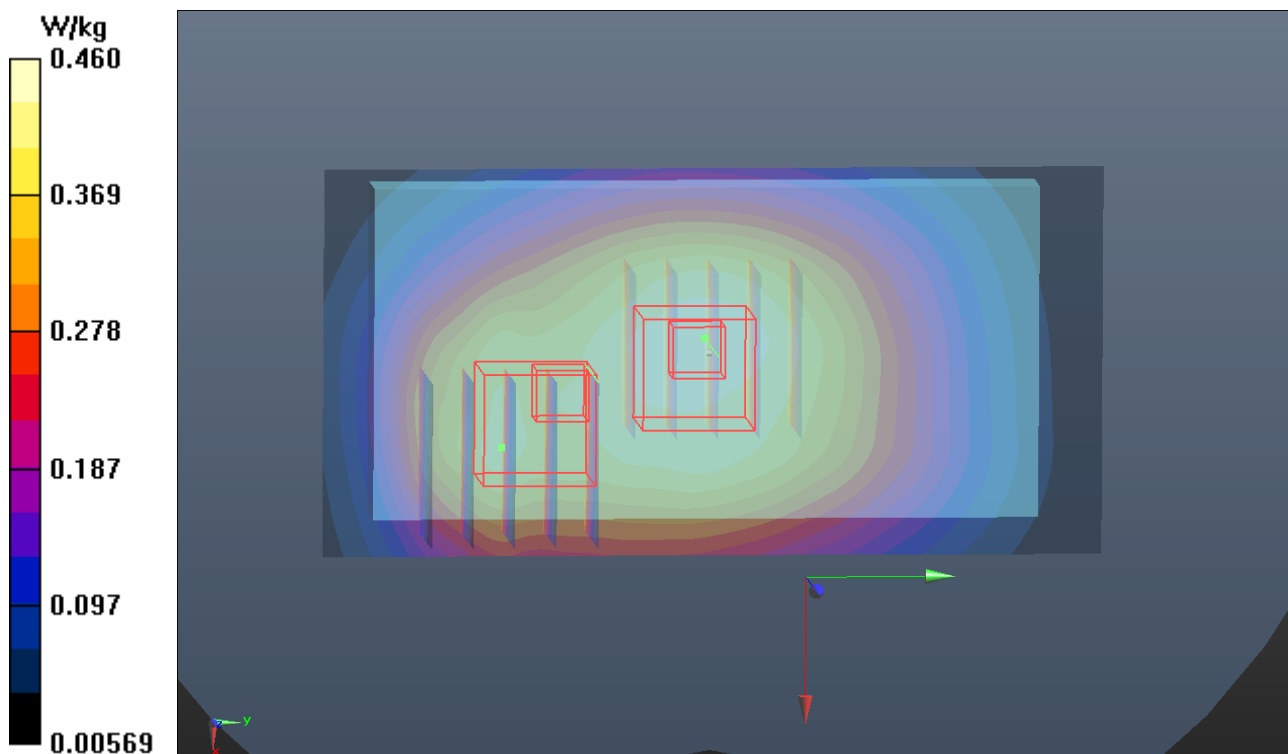

P13 LTE 41_QPSK20M_Front Face_1cm_Ch41055_1RB_offset 50

DUT: 131119C06

Communication System: LTE; Frequency: 2636.5 MHz; Duty Cycle: 1:1.58
Medium: B2600_1210 Medium parameters used: $f = 2636.5$ MHz; $\sigma = 2.247$ S/m; $\epsilon_r = 52.245$; $\rho = 1000$ kg/m³
Ambient Temperature : 20.7 °C; Liquid Temperature : 20.2 °C

DASY5 Configuration:

- Probe: EX3DV4 - SN3650; ConvF(6.91, 6.91, 6.91); Calibrated: 2013/04/30;
- Sensor-Surface: 2mm (Mechanical Surface Detection)
- Electronics: DAE3 Sn360; Calibrated: 2013/01/30
- Phantom: SAM Phantom_Left; Type: SAM V4.0; Serial: TP 1653
- Measurement SW: DASY52, Version 52.8 (7); SEMCAD X Version 14.6.10 (7164)

- **Area Scan (71x121x1):** Interpolated grid: dx=1.200 mm, dy=1.200 mm
Maximum value of SAR (interpolated) = 0.576 W/kg

- **Zoom Scan (5x5x7)/Cube 0:** Measurement grid: dx=8mm, dy=8mm, dz=5mm
Reference Value = 8.612 V/m; Power Drift = 0.15 dB
Peak SAR (extrapolated) = 0.862 W/kg
SAR(1 g) = 0.422 W/kg; SAR(10 g) = 0.223 W/kg
Maximum value of SAR (measured) = 0.606 W/kg

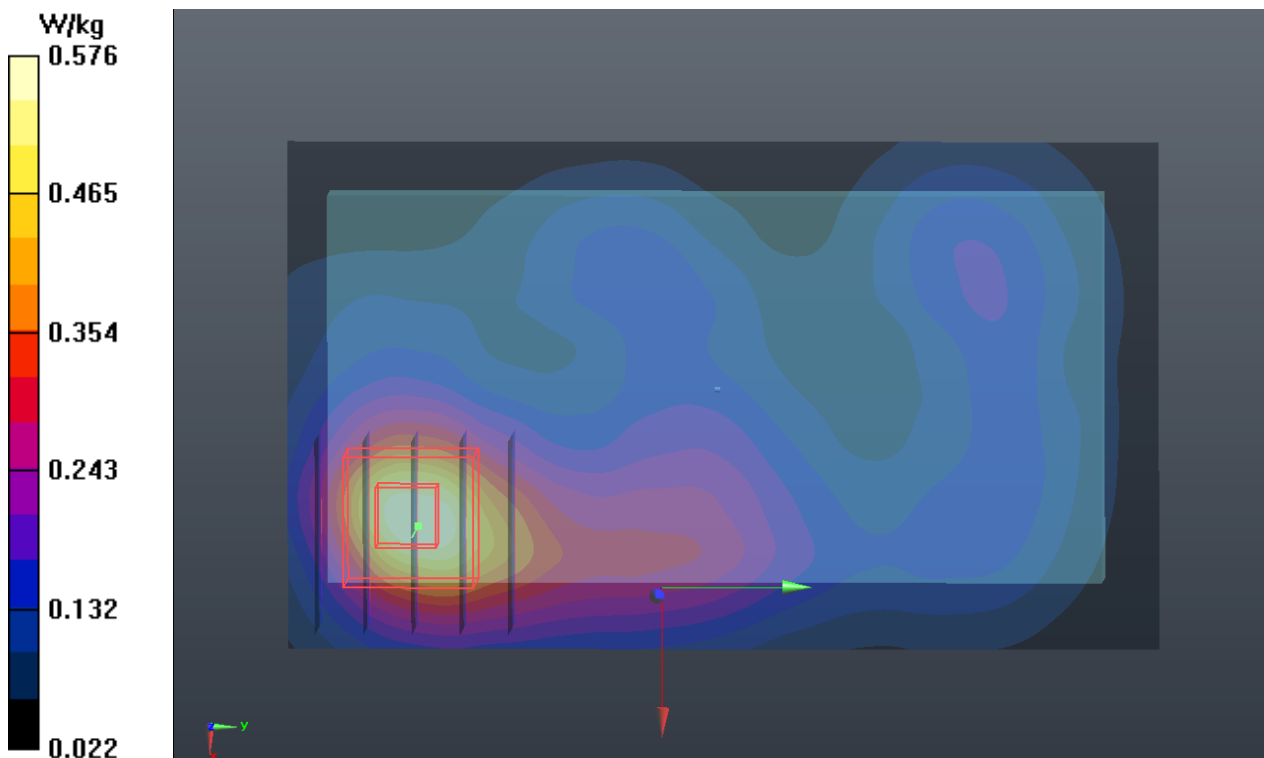

P14 802.11b_Rear Face_1cm_Ch6

DUT: 131119C06

Communication System: WLAN_2.4G; Frequency: 2437 MHz; Duty Cycle: 1:1
Medium: B2450_1213 Medium parameters used: $f = 2437$ MHz; $\sigma = 1.951$ S/m; $\epsilon_r = 51.41$; $\rho = 1000$ kg/m³
Ambient Temperature : 20.9 °C; Liquid Temperature : 20.3 °C

DASY5 Configuration:

- Probe: EX3DV4 - SN3650; ConvF(7.09, 7.09, 7.09); Calibrated: 2013/04/30;
- Sensor-Surface: 2mm (Mechanical Surface Detection)
- Electronics: DAE3 Sn360; Calibrated: 2013/01/30
- Phantom: ELI 4.0; Type: QDOVA001BA; Serial: TP:1206
- Measurement SW: DASY52, Version 52.8 (7); SEMCAD X Version 14.6.10 (7164)

- **Area Scan (71x121x1):** Interpolated grid: dx=1.200 mm, dy=1.200 mm
Maximum value of SAR (interpolated) = 0.359 W/kg

- **Zoom Scan (5x5x7)/Cube 0:** Measurement grid: dx=8mm, dy=8mm, dz=5mm
Reference Value = 6.164 V/m; Power Drift = 0.04 dB
Peak SAR (extrapolated) = 0.604 W/kg
SAR(1 g) = 0.265 W/kg; SAR(10 g) = 0.118 W/kg
Maximum value of SAR (measured) = 0.437 W/kg

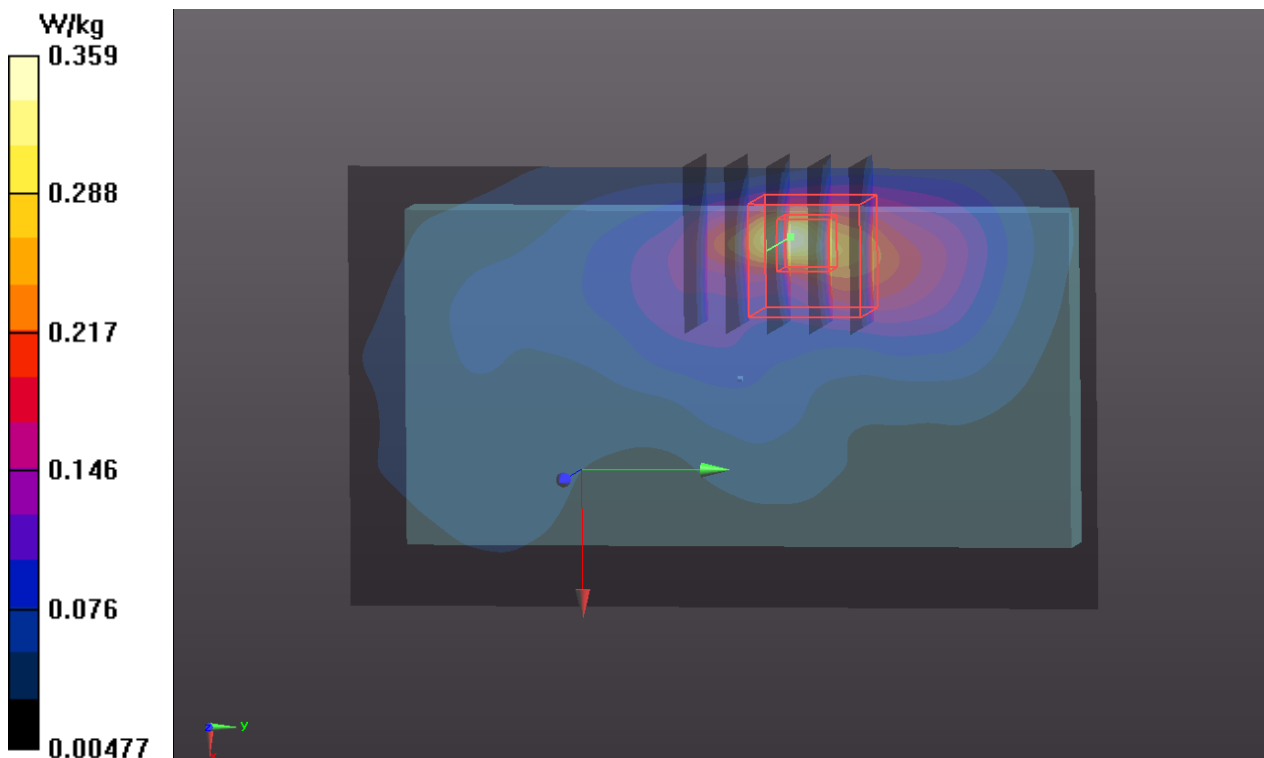

P15 CDMA2000 BC0_RTAP 153.6_Left Side_1cm_Ch384

DUT: 131119C06

Communication System: CDMA2000; Frequency: 836.52 MHz; Duty Cycle: 1:1
Medium: B835_1209 Medium parameters used: $f = 837$ MHz; $\sigma = 0.974$ S/m; $\epsilon_r = 53.996$; $\rho = 1000$ kg/m³
Ambient Temperature : 21.3 °C; Liquid Temperature : 20.8 °C

DASY5 Configuration:

- Probe: EX3DV4 - SN3650; ConvF(9.35, 9.35, 9.35); Calibrated: 2013/04/30;
- Sensor-Surface: 2mm (Mechanical Surface Detection)
- Electronics: DAE3 Sn360; Calibrated: 2013/01/30
- Phantom: SAM Phantom_Front; Type: SAM V4.0; Serial: TP 1654
- Measurement SW: DASY52, Version 52.8 (7); SEMCAD X Version 14.6.10 (7164)

- **Area Scan (41x101x1):** Interpolated grid: dx=1.500 mm, dy=1.500 mm
Maximum value of SAR (interpolated) = 0.820 W/kg

- **Zoom Scan (5x5x7)/Cube 0:** Measurement grid: dx=8mm, dy=8mm, dz=5mm
Reference Value = 28.609 V/m; Power Drift = 0.10 dB
Peak SAR (extrapolated) = 1.02 W/kg
SAR(1 g) = 0.689 W/kg; SAR(10 g) = 0.472 W/kg
Maximum value of SAR (measured) = 0.866 W/kg

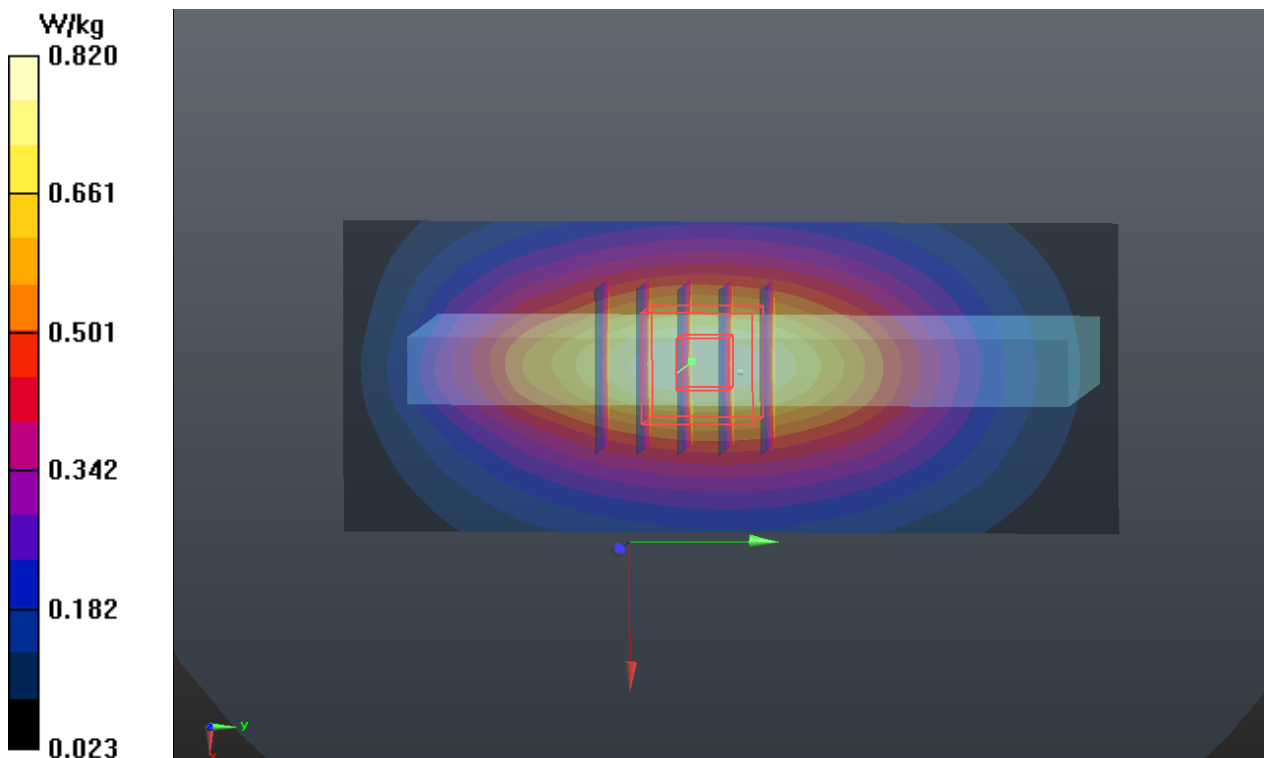

P16 CDMA2000 BC1_RTAP 153.6_Bottom Side_1cm_Ch25

DUT: 131119C06

Communication System: CDMA2000; Frequency: 1851.25 MHz; Duty Cycle: 1:1
Medium: B1900_1209 Medium parameters used: $f = 1851.25$ MHz; $\sigma = 1.49$ S/m; $\epsilon_r = 52.12$; $\rho = 1000$ kg/m³
Ambient Temperature : 21.2 °C; Liquid Temperature : 20.7 °C

DASY5 Configuration:

- Probe: EX3DV4 - SN3650; ConvF(7.39, 7.39, 7.39); Calibrated: 2013/04/30;
- Sensor-Surface: 2mm (Mechanical Surface Detection)
- Electronics: DAE3 Sn360; Calibrated: 2013/01/30
- Phantom: ELI 4.0; Type: QDOVA001BA; Serial: TP:1206
- Measurement SW: DASY52, Version 52.8 (7); SEMCAD X Version 14.6.10 (7164)

- **Area Scan (41x81x1):** Interpolated grid: $dx=1.500$ mm, $dy=1.500$ mm
Maximum value of SAR (interpolated) = 2.06 W/kg

- **Zoom Scan (5x5x7)/Cube 0:** Measurement grid: $dx=8$ mm, $dy=8$ mm, $dz=5$ mm
Reference Value = 28.477 V/m; Power Drift = -0.01 dB
Peak SAR (extrapolated) = 2.53 W/kg
SAR(1 g) = 1.37 W/kg; SAR(10 g) = 0.663 W/kg
Maximum value of SAR (measured) = 2.00 W/kg

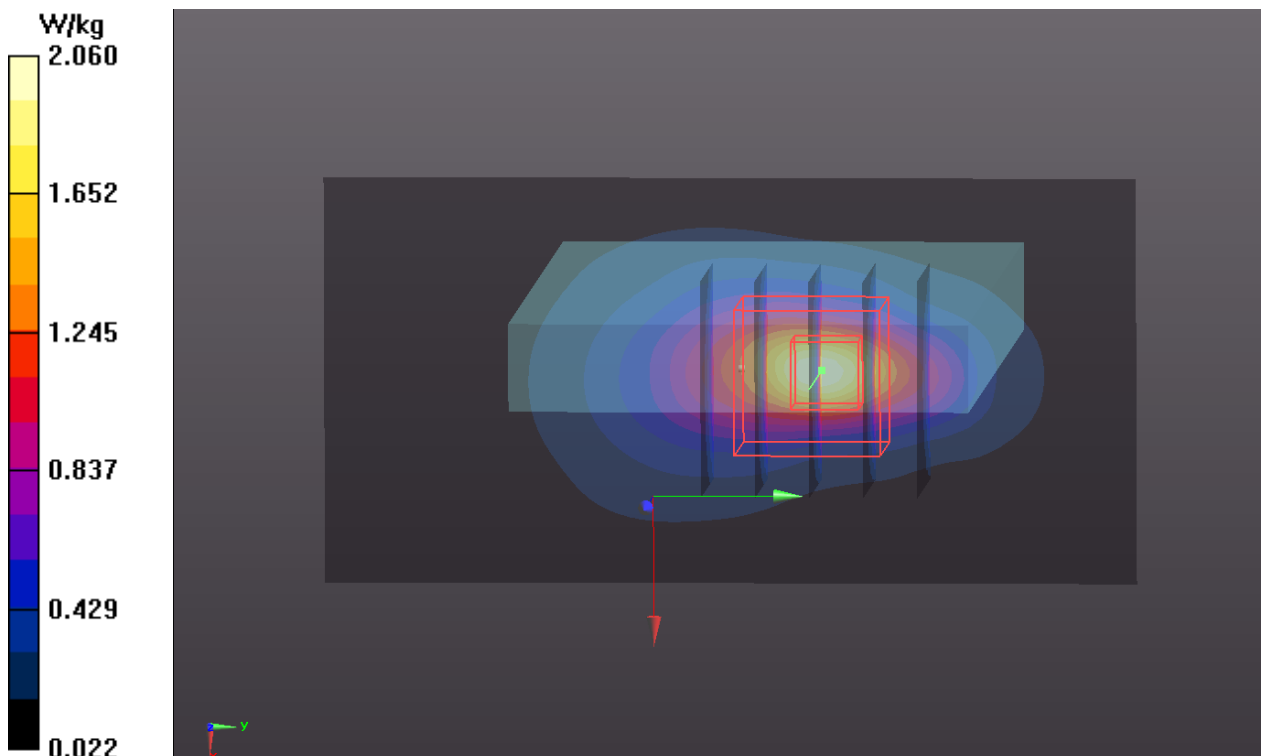

P17 CDMA2000 BC10_RTAP 153.6_Left Side_1cm_Ch580

DUT: 131119C06

Communication System: CDMA2000; Frequency: 820.5 MHz; Duty Cycle: 1:1
Medium: B835_1209 Medium parameters used: $f = 820.5$ MHz; $\sigma = 0.956$ S/m; $\epsilon_r = 54.13$; $\rho = 1000$ kg/m³
Ambient Temperature : 21.3 °C; Liquid Temperature : 20.8 °C

DASY5 Configuration:

- Probe: EX3DV4 - SN3650; ConvF(9.35, 9.35, 9.35); Calibrated: 2013/04/30;
- Sensor-Surface: 2mm (Mechanical Surface Detection)
- Electronics: DAE3 Sn360; Calibrated: 2013/01/30
- Phantom: SAM Phantom_Front; Type: SAM V4.0; Serial: TP 1654
- Measurement SW: DASY52, Version 52.8 (7); SEMCAD X Version 14.6.10 (7164)

- **Area Scan (41x101x1):** Interpolated grid: dx=1.500 mm, dy=1.500 mm
Maximum value of SAR (interpolated) = 0.828 W/kg

- **Zoom Scan (5x5x7)/Cube 0:** Measurement grid: dx=8mm, dy=8mm, dz=5mm
Reference Value = 29.070 V/m; Power Drift = 0.07 dB
Peak SAR (extrapolated) = 0.922 W/kg
SAR(1 g) = 0.628 W/kg; SAR(10 g) = 0.434 W/kg
Maximum value of SAR (measured) = 0.780 W/kg

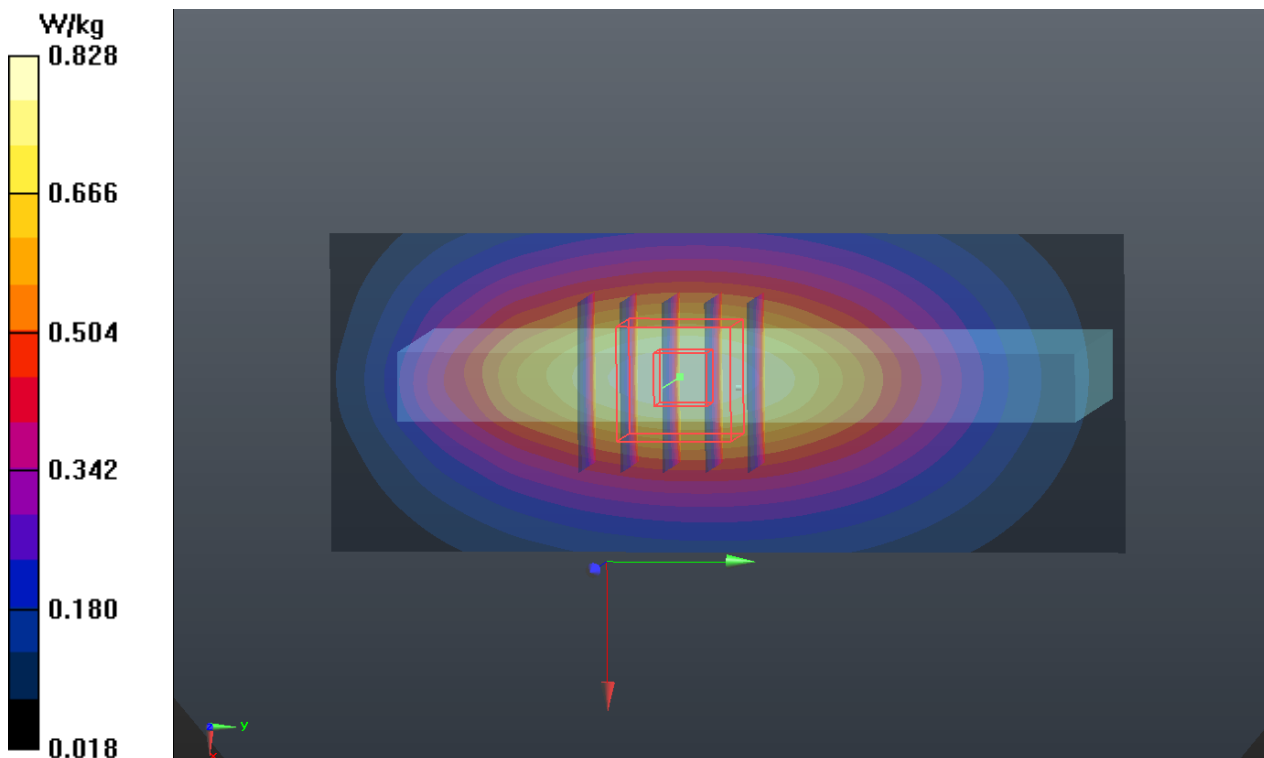

P18 LTE 25_QPSK10M_Bottom Side_1cm_Ch26090_1RB_offset 0

DUT: 131119C06

Communication System: LTE; Frequency: 1855 MHz; Duty Cycle: 1:1
Medium: B1900_1209 Medium parameters used: $f = 1855$ MHz; $\sigma = 1.494$ S/m; $\epsilon_r = 52.108$; $\rho = 1000$ kg/m³
Ambient Temperature : 21.2 °C; Liquid Temperature : 20.7 °C

DASY5 Configuration:

- Probe: EX3DV4 - SN3650; ConvF(7.39, 7.39, 7.39); Calibrated: 2013/04/30;
- Sensor-Surface: 2mm (Mechanical Surface Detection)
- Electronics: DAE3 Sn360; Calibrated: 2013/01/30
- Phantom: ELI 4.0; Type: QDOVA001BA; Serial: TP:1206
- Measurement SW: DASY52, Version 52.8 (7); SEMCAD X Version 14.6.10 (7164)

- **Area Scan (41x61x1):** Interpolated grid: $dx=1.500$ mm, $dy=1.500$ mm
Maximum value of SAR (interpolated) = 1.47 W/kg

- **Zoom Scan (5x5x7)/Cube 0:** Measurement grid: $dx=8$ mm, $dy=8$ mm, $dz=5$ mm
Reference Value = 22.851 V/m; Power Drift = 0.01 dB
Peak SAR (extrapolated) = 1.88 W/kg
SAR(1 g) = 1.01 W/kg; SAR(10 g) = 0.490 W/kg
Maximum value of SAR (measured) = 1.42 W/kg

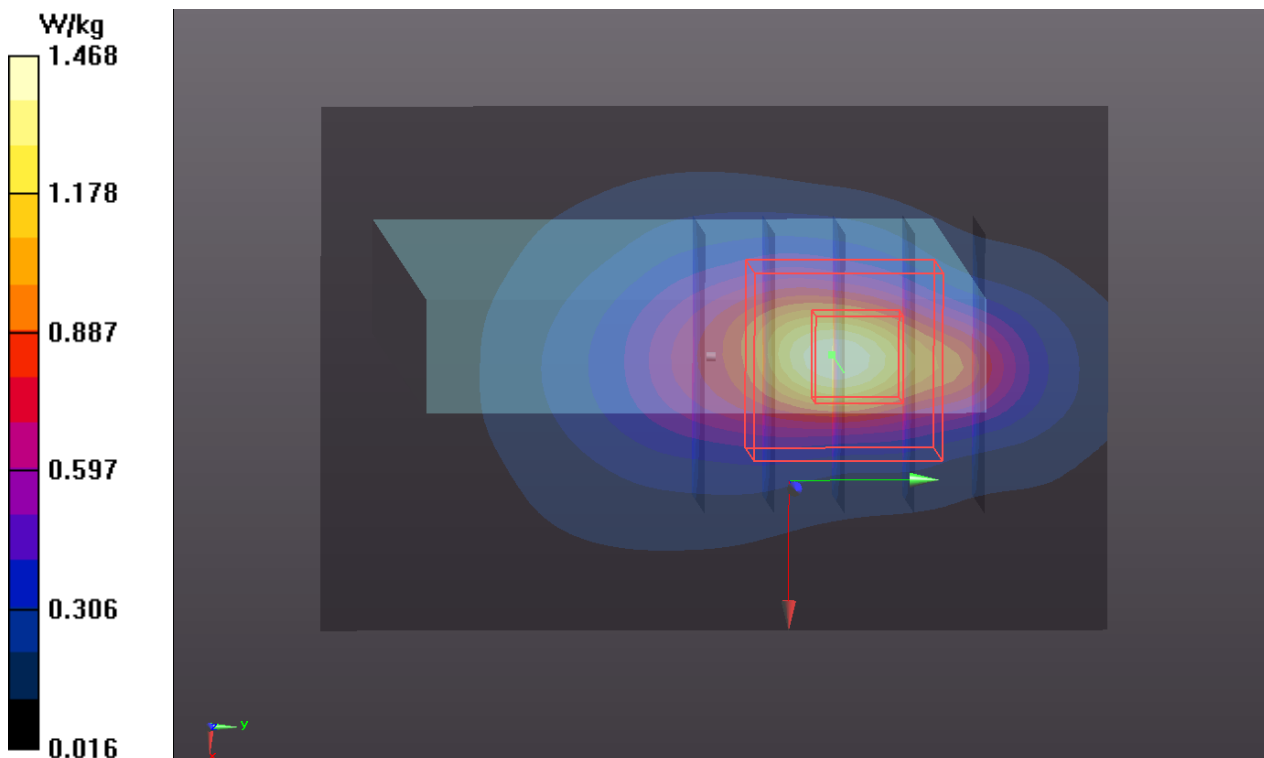

P19 LTE 26_QPSK10M_Left Side_1cm_Ch26990_1RB_offset 24

DUT: 131119C06

Communication System: LTE; Frequency: 844 MHz; Duty Cycle: 1:1
Medium: B835_1209 Medium parameters used: $f = 844 \text{ MHz}$; $\sigma = 0.982 \text{ S/m}$; $\epsilon_r = 53.928$; $\rho = 1000 \text{ kg/m}^3$
Ambient Temperature : $21.3 \text{ }^\circ\text{C}$; Liquid Temperature : $20.8 \text{ }^\circ\text{C}$

DASY5 Configuration:

- Probe: EX3DV4 - SN3650; ConvF(9.35, 9.35, 9.35); Calibrated: 2013/04/30;
- Sensor-Surface: 2mm (Mechanical Surface Detection)
- Electronics: DAE3 Sn360; Calibrated: 2013/01/30
- Phantom: SAM Phantom_Front; Type: SAM V4.0; Serial: TP 1654
- Measurement SW: DASY52, Version 52.8 (7); SEMCAD X Version 14.6.10 (7164)

- **Area Scan (41x101x1):** Interpolated grid: $dx=1.500 \text{ mm}$, $dy=1.500 \text{ mm}$
Maximum value of SAR (interpolated) = 0.579 W/kg

- **Zoom Scan (5x5x7)/Cube 0:** Measurement grid: $dx=8\text{mm}$, $dy=8\text{mm}$, $dz=5\text{mm}$
Reference Value = 24.339 V/m ; Power Drift = 0.03 dB
Peak SAR (extrapolated) = 0.775 W/kg
SAR(1 g) = 0.528 W/kg ; SAR(10 g) = 0.365 W/kg
Maximum value of SAR (measured) = 0.651 W/kg

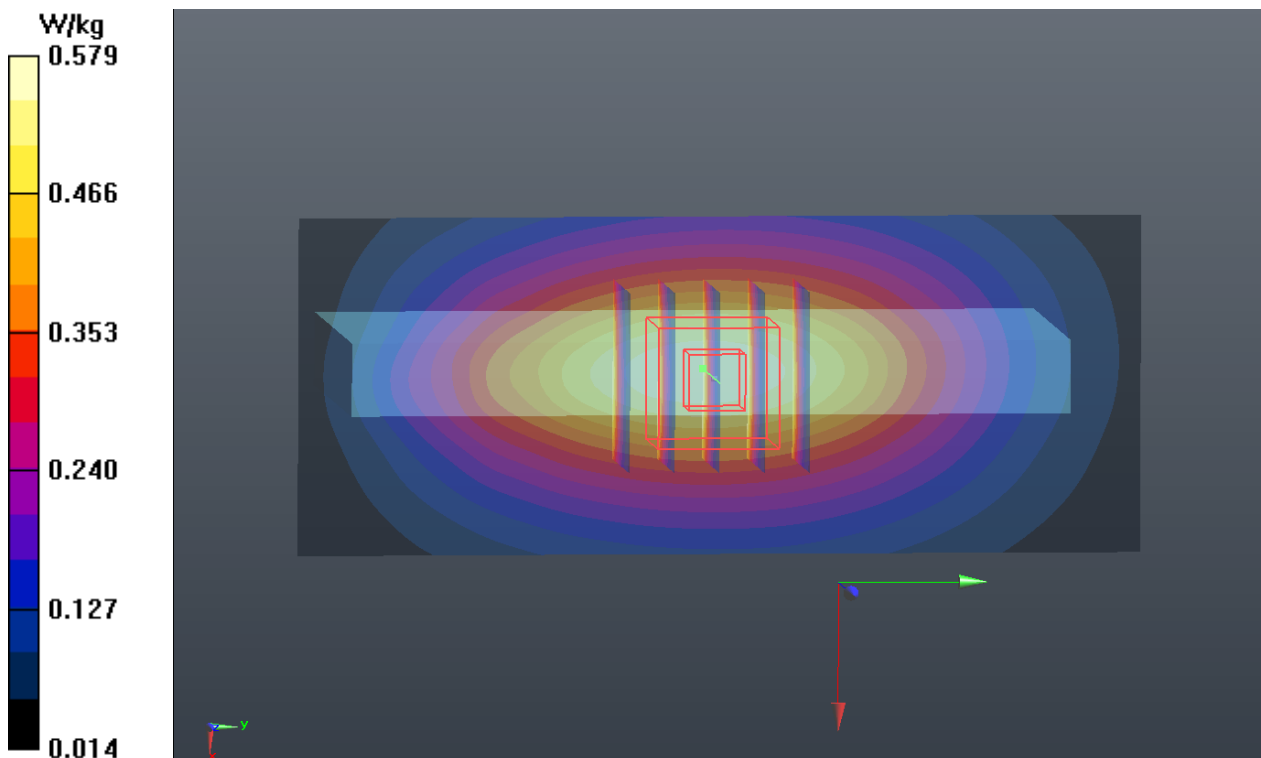

P20 LTE 41_QPSK20M_Front Face_1cm_Ch41055_1RB_offset 50

DUT: 131119C06

Communication System: LTE; Frequency: 2636.5 MHz; Duty Cycle: 1:1.58
Medium: B2600_1210 Medium parameters used: $f = 2636.5$ MHz; $\sigma = 2.247$ S/m; $\epsilon_r = 52.245$; $\rho = 1000$ kg/m³
Ambient Temperature : 20.7 °C; Liquid Temperature : 20.2 °C

DASY5 Configuration:

- Probe: EX3DV4 - SN3650; ConvF(6.91, 6.91, 6.91); Calibrated: 2013/04/30;
- Sensor-Surface: 2mm (Mechanical Surface Detection)
- Electronics: DAE3 Sn360; Calibrated: 2013/01/30
- Phantom: SAM Phantom_Left; Type: SAM V4.0; Serial: TP 1653
- Measurement SW: DASY52, Version 52.8 (7); SEMCAD X Version 14.6.10 (7164)

- **Area Scan (71x121x1):** Interpolated grid: dx=1.200 mm, dy=1.200 mm
Maximum value of SAR (interpolated) = 0.576 W/kg

- **Zoom Scan (5x5x7)/Cube 0:** Measurement grid: dx=8mm, dy=8mm, dz=5mm
Reference Value = 8.612 V/m; Power Drift = 0.15 dB
Peak SAR (extrapolated) = 0.862 W/kg
SAR(1 g) = 0.422 W/kg; SAR(10 g) = 0.223 W/kg
Maximum value of SAR (measured) = 0.606 W/kg

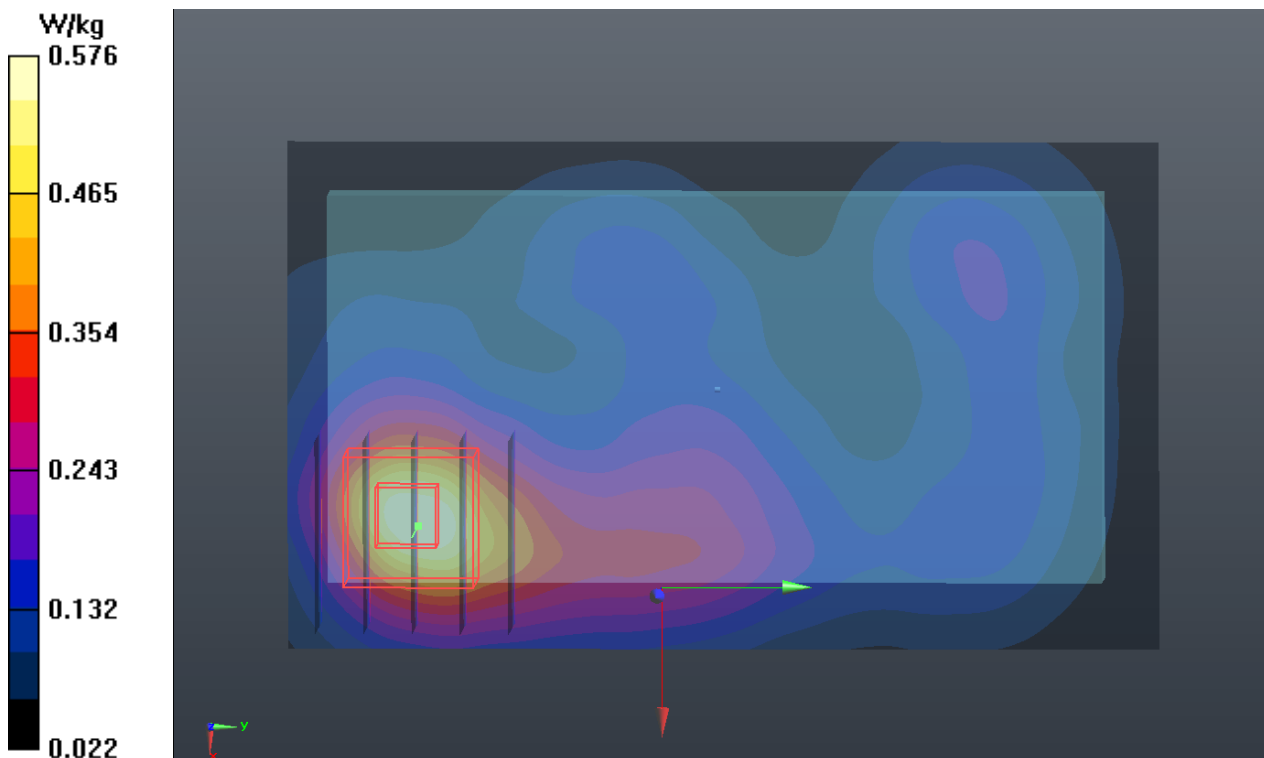



Appendix C. Calibration Certificate for Probe and Dipole

The SPEAG calibration certificates are shown as follows.



Accredited by the Swiss Accreditation Service (SAS)
The Swiss Accreditation Service is one of the signatories to the EA
Multilateral Agreement for the recognition of calibration certificates

Accreditation No.: **SCS 108**

Client **B.V. ADT (Auden)**

Certificate No: **D835V2-4d121_Apr13**

CALIBRATION CERTIFICATE

Object **D835V2 - SN: 4d121**

Calibration procedure(s) **QA CAL-05.v9
Calibration procedure for dipole validation kits above 700 MHz**

Calibration date: **April 25, 2013**

This calibration certificate documents the traceability to national standards, which realize the physical units of measurements (SI).
The measurements and the uncertainties with confidence probability are given on the following pages and are part of the certificate.

All calibrations have been conducted in the closed laboratory facility: environment temperature (22 ± 3)°C and humidity < 70%.

Calibration Equipment used (M&TE critical for calibration)

Primary Standards	ID #	Cal Date (Certificate No.)	Scheduled Calibration
Power meter EPM-442A	GB37480704	01-Nov-12 (No. 217-01640)	Oct-13
Power sensor HP 8481A	US37292783	01-Nov-12 (No. 217-01640)	Oct-13
Reference 20 dB Attenuator	SN: 5058 (20k)	04-Apr-13 (No. 217-01736)	Apr-14
Type-N mismatch combination	SN: 5047.3 / 06327	04-Apr-13 (No. 217-01739)	Apr-14
Reference Probe ES3DV3	SN: 3205	28-Dec-12 (No. ES3-3205_Dec12)	Dec-13
DAE4	SN: 909	11-Sep-12 (No. DAE4-909_Sep12)	Sep-13
Secondary Standards	ID #	Check Date (in house)	Scheduled Check
Power sensor HP 8481A	MY41092317	18-Oct-02 (in house check Oct-11)	In house check: Oct-13
RF generator R&S SMT-06	100005	04-Aug-99 (in house check Oct-11)	In house check: Oct-13
Network Analyzer HP 8753E	US37390585 S4206	18-Oct-01 (in house check Oct-12)	In house check: Oct-13

Calibrated by: **Claudio Leubler** Name: Claudio Leubler Function: Laboratory Technician

Approved by: **Katja Pokovic** Name: Katja Pokovic Function: Technical Manager

Signature

Issued: April 26, 2013

This calibration certificate shall not be reproduced except in full without written approval of the laboratory.



Accredited by the Swiss Accreditation Service (SAS)

The Swiss Accreditation Service is one of the signatories to the EA
Multilateral Agreement for the recognition of calibration certificates

Accreditation No.: **SCS 108**

Glossary:

TSL	tissue simulating liquid
ConvF	sensitivity in TSL / NORM x,y,z
N/A	not applicable or not measured

Calibration is Performed According to the Following Standards:

- IEEE Std 1528-2003, "IEEE Recommended Practice for Determining the Peak Spatial-Averaged Specific Absorption Rate (SAR) in the Human Head from Wireless Communications Devices: Measurement Techniques", December 2003
- IEC 62209-1, "Procedure to measure the Specific Absorption Rate (SAR) for hand-held devices used in close proximity to the ear (frequency range of 300 MHz to 3 GHz)", February 2005
- Federal Communications Commission Office of Engineering & Technology (FCC OET), "Evaluating Compliance with FCC Guidelines for Human Exposure to Radiofrequency Electromagnetic Fields; Additional Information for Evaluating Compliance of Mobile and Portable Devices with FCC Limits for Human Exposure to Radiofrequency Emissions", Supplement C (Edition 01-01) to Bulletin 65

Additional Documentation:

- DASY4/5 System Handbook

Methods Applied and Interpretation of Parameters:

- Measurement Conditions:** Further details are available from the Validation Report at the end of the certificate. All figures stated in the certificate are valid at the frequency indicated.
- Antenna Parameters with TSL:** The dipole is mounted with the spacer to position its feed point exactly below the center marking of the flat phantom section, with the arms oriented parallel to the body axis.
- Feed Point Impedance and Return Loss:** These parameters are measured with the dipole positioned under the liquid filled phantom. The impedance stated is transformed from the measurement at the SMA connector to the feed point. The Return Loss ensures low reflected power. No uncertainty required.
- Electrical Delay:** One-way delay between the SMA connector and the antenna feed point. No uncertainty required.
- SAR measured:** SAR measured at the stated antenna input power.
- SAR normalized:** SAR as measured, normalized to an input power of 1 W at the antenna connector.
- SAR for nominal TSL parameters:** The measured TSL parameters are used to calculate the nominal SAR result.

The reported uncertainty of measurement is stated as the standard uncertainty of measurement multiplied by the coverage factor $k=2$, which for a normal distribution corresponds to a coverage probability of approximately 95%.

Measurement Conditions

DASY system configuration, as far as not given on page 1.

DASY Version	DASY5	V52.8.6
Extrapolation	Advanced Extrapolation	
Phantom	Modular Flat Phantom	
Distance Dipole Center - TSL	15 mm	with Spacer
Zoom Scan Resolution	dx, dy, dz = 5 mm	
Frequency	835 MHz \pm 1 MHz	

Head TSL parameters

The following parameters and calculations were applied.

	Temperature	Permittivity	Conductivity
Nominal Head TSL parameters	22.0 °C	41.5	0.90 mho/m
Measured Head TSL parameters	(22.0 \pm 0.2) °C	40.8 \pm 6 %	0.94 mho/m \pm 6 %
Head TSL temperature change during test	< 0.5 °C	----	----

SAR result with Head TSL

SAR averaged over 1 cm³ (1 g) of Head TSL	Condition	
SAR measured	250 mW input power	2.51 W/kg
SAR for nominal Head TSL parameters	normalized to 1W	9.68 W/kg \pm 17.0 % (k=2)

SAR averaged over 10 cm³ (10 g) of Head TSL	condition	
SAR measured	250 mW input power	1.62 W/kg
SAR for nominal Head TSL parameters	normalized to 1W	6.30 W/kg \pm 16.5 % (k=2)

Body TSL parameters

The following parameters and calculations were applied.

	Temperature	Permittivity	Conductivity
Nominal Body TSL parameters	22.0 °C	55.2	0.97 mho/m
Measured Body TSL parameters	(22.0 \pm 0.2) °C	54.0 \pm 6 %	1.01 mho/m \pm 6 %
Body TSL temperature change during test	< 0.5 °C	----	----

SAR result with Body TSL

SAR averaged over 1 cm³ (1 g) of Body TSL	Condition	
SAR measured	250 mW input power	2.51 W/kg
SAR for nominal Body TSL parameters	normalized to 1W	9.69 W/kg \pm 17.0 % (k=2)

SAR averaged over 10 cm³ (10 g) of Body TSL	condition	
SAR measured	250 mW input power	1.64 W/kg
SAR for nominal Body TSL parameters	normalized to 1W	6.38 W/kg \pm 16.5 % (k=2)

Appendix

Antenna Parameters with Head TSL

Impedance, transformed to feed point	52.4 Ω - 2.1 j Ω
Return Loss	- 30.2 dB

Antenna Parameters with Body TSL

Impedance, transformed to feed point	47.4 Ω - 3.8 j Ω
Return Loss	- 26.6 dB

General Antenna Parameters and Design

Electrical Delay (one direction)	1.395 ns
----------------------------------	----------

After long term use with 100W radiated power, only a slight warming of the dipole near the feedpoint can be measured.

The dipole is made of standard semirigid coaxial cable. The center conductor of the feeding line is directly connected to the second arm of the dipole. The antenna is therefore short-circuited for DC-signals. On some of the dipoles, small end caps are added to the dipole arms in order to improve matching when loaded according to the position as explained in the "Measurement Conditions" paragraph. The SAR data are not affected by this change. The overall dipole length is still according to the Standard.

No excessive force must be applied to the dipole arms, because they might bend or the soldered connections near the feedpoint may be damaged.

Additional EUT Data

Manufactured by	SPEAG
Manufactured on	June 29, 2010

DASY5 Validation Report for Head TSL

Date: 25.04.2013

Test Laboratory: SPEAG, Zurich, Switzerland

DUT: Dipole 835 MHz; Type: D835V2; Serial: D835V2 - SN: 4d121

Communication System: UID 0 - CW; Frequency: 835 MHz

Medium parameters used: $f = 835$ MHz; $\sigma = 0.94$ S/m; $\epsilon_r = 40.8$; $\rho = 1000$ kg/m³

Phantom section: Flat Section

Measurement Standard: DASY5 (IEEE/IEC/ANSI C63.19-2007)

DASY52 Configuration:

- Probe: ES3DV3 - SN3205; ConvF(6.05, 6.05, 6.05); Calibrated: 28.12.2012;
- Sensor-Surface: 3mm (Mechanical Surface Detection)
- Electronics: DAE4 Sn909; Calibrated: 11.09.2012
- Phantom: Flat Phantom 4.9L; Type: QD000P49AA; Serial: 1001
- DASY52 52.8.6(1115); SEMCAD X 14.6.9(7117)

Dipole Calibration for Head Tissue/Pin=250 mW, d=15mm/Zoom Scan (7x7x7)/Cube 0:

Measurement grid: dx=5mm, dy=5mm, dz=5mm

Reference Value = 57.380 V/m; Power Drift = 0.02 dB

Peak SAR (extrapolated) = 3.86 W/kg

SAR(1 g) = 2.51 W/kg; SAR(10 g) = 1.62 W/kg

Maximum value of SAR (measured) = 2.94 W/kg

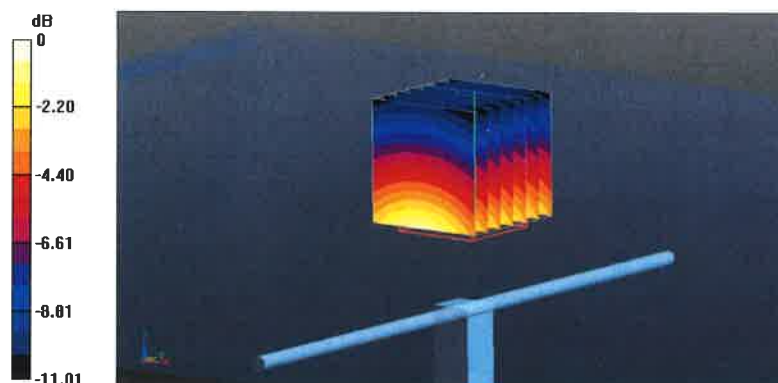

0 dB = 2.94 W/kg = 4.68 dBW/kg

Impedance Measurement Plot for Head TSL

25 Apr 2013 09:13:26

[CH1] S11 1 U FS

1: 52.387 Ω -2.0566 Ω 92.678 pF

835.000 000 MHz

*

De1

CA

Avg

16

H1d

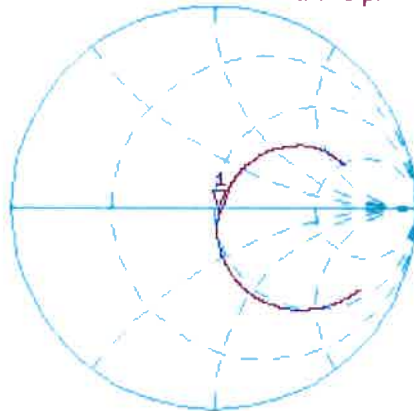

CH2 S11 LOG 5 dB/REF -20 dB 1:-30.231 dB 835.000 000 MHz

CA

Avg

16

H1d

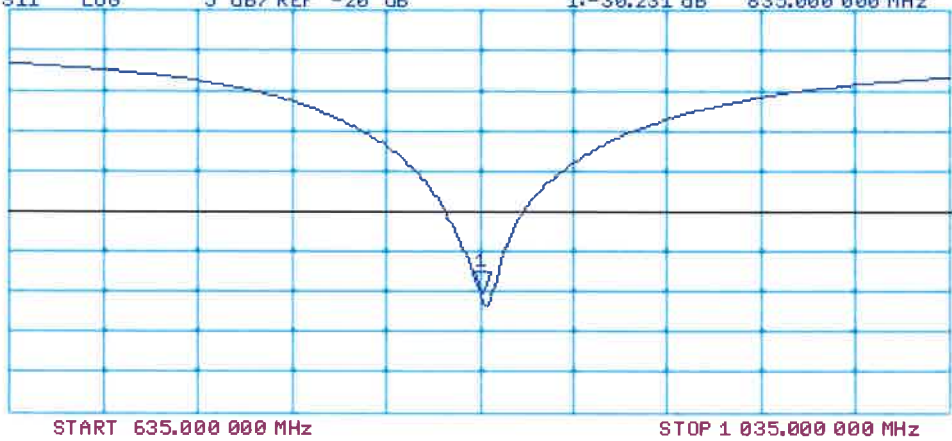

DASY5 Validation Report for Body TSL

Date: 24.04.2013

Test Laboratory: SPEAG, Zurich, Switzerland

DUT: Dipole 835 MHz; Type: D835V2; Serial: D835V2 - SN: 4d121

Communication System: UID 0 - CW; Frequency: 835 MHz

Medium parameters used: $f = 835$ MHz; $\sigma = 1.01$ S/m; $\epsilon_r = 54$; $\rho = 1000$ kg/m³

Phantom section: Flat Section

Measurement Standard: DASY5 (IEEE/IEC/ANSI C63.19-2007)

DASY52 Configuration:

- Probe: ES3DV3 - SN3205; ConvF(6.04, 6.04, 6.04); Calibrated: 28.12.2012;
- Sensor-Surface: 3mm (Mechanical Surface Detection)
- Electronics: DAE4 Sn909; Calibrated: 11.09.2012
- Phantom: Flat Phantom 4.9L; Type: QD000P49AA; Serial: 1001
- DASY52 52.8.6(1115); SEMCAD X 14.6.9(7117)

Dipole Calibration for Body Tissue/Pin=250 mW, d=15mm/Zoom Scan (7x7x7)/Cube 0:

Measurement grid: dx=5mm, dy=5mm, dz=5mm

Reference Value = 55.573 V/m; Power Drift = 0.02 dB

Peak SAR (extrapolated) = 3.72 W/kg

SAR(1 g) = 2.51 W/kg; SAR(10 g) = 1.64 W/kg

Maximum value of SAR (measured) = 2.93 W/kg

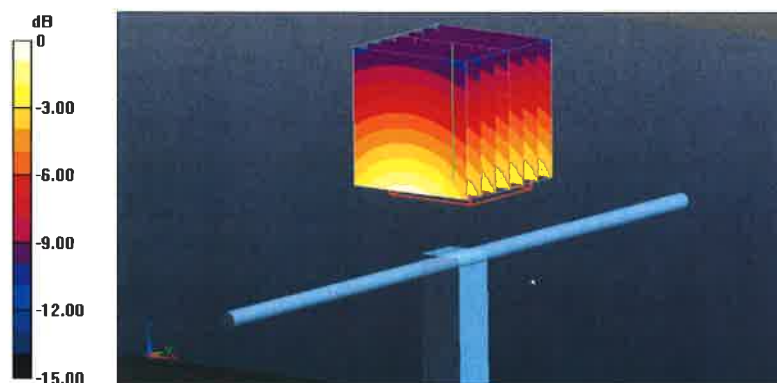

Impedance Measurement Plot for Body TSL

24 Apr 2013 11:36:25

CH1 S11 1 U FS 2: 47.438 Ω -3.7910 Ω 50.278 pF 835.000 000 MHz

*
De 1

CA

Avg
16

H1 d

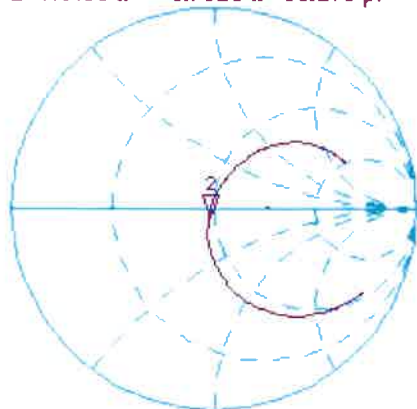

CH2 S11 LOG 5 dB/ REF -20 dB 2: -26.570 dB 835.000 000 MHz

CA

Avg
16

H1 d

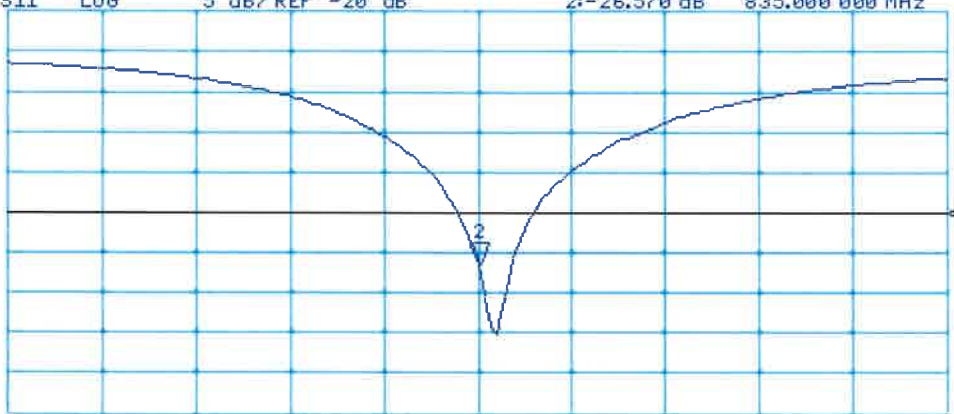

START 635.000 000 MHz

STOP 1 035.000 000 MHz



Accredited by the Swiss Accreditation Service (SAS)
The Swiss Accreditation Service is one of the signatories to the EA
Multilateral Agreement for the recognition of calibration certificates

Accreditation No.: **SCS 108**

Client **B.V. ADT (Auden)**

Certificate No: **D1900V2-5d036_Jan13**

CALIBRATION CERTIFICATE

Object **D1900V2 - SN: 5d036**

Calibration procedure(s) **QA CAL-05.v9
Calibration procedure for dipole validation kits above 700 MHz**

Calibration date: **January 21, 2013**

This calibration certificate documents the traceability to national standards, which realize the physical units of measurements (SI).
The measurements and the uncertainties with confidence probability are given on the following pages and are part of the certificate.

All calibrations have been conducted in the closed laboratory facility: environment temperature (22 ± 3)°C and humidity < 70%.

Calibration Equipment used (M&TE critical for calibration)

Primary Standards	ID #	Cal Date (Certificate No.)	Scheduled Calibration
Power meter EPM-442A	GB37480704	01-Nov-12 (No. 217-01640)	Oct-13
Power sensor HP 8481A	US37292783	01-Nov-12 (No. 217-01640)	Oct-13
Reference 20 dB Attenuator	SN: 5058 (20k)	27-Mar-12 (No. 217-01530)	Apr-13
Type-N mismatch combination	SN: 5047.3 / 06327	27-Mar-12 (No. 217-01533)	Apr-13
Reference Probe ES3DV3	SN: 3205	28-Dec-12 (No. ES3-3205_Dec12)	Dec-13
DAE4	SN: 601	27-Jun-12 (No. DAE4-601_Jun12)	Jun-13
Secondary Standards	ID #	Check Date (in house)	Scheduled Check
Power sensor HP 8481A	MY41092317	18-Oct-02 (in house check Oct-11)	In house check: Oct-13
RF generator R&S SMT-06	100005	04-Aug-99 (in house check Oct-11)	In house check: Oct-13
Network Analyzer HP 8753E	US37390585 S4206	18-Oct-01 (in house check Oct-12)	In house check: Oct-13

Calibrated by: **Israe El-Naouq** Name: **Israe El-Naouq** Function: **Laboratory Technician**

Approved by: **Fin Bomholt** Name: **Fin Bomholt** Function: **Deputy Technical Manager**

Signature
Israe El-Naouq
F. Bomholt

Issued: January 22, 2013

This calibration certificate shall not be reproduced except in full without written approval of the laboratory.



Accredited by the Swiss Accreditation Service (SAS)

The Swiss Accreditation Service is one of the signatories to the EA
Multilateral Agreement for the recognition of calibration certificates

Accreditation No.: **SCS 108**

Glossary:

TSL	tissue simulating liquid
ConvF	sensitivity in TSL / NORM x,y,z
N/A	not applicable or not measured

Calibration is Performed According to the Following Standards:

- IEEE Std 1528-2003, "IEEE Recommended Practice for Determining the Peak Spatial-Averaged Specific Absorption Rate (SAR) in the Human Head from Wireless Communications Devices: Measurement Techniques", December 2003
- IEC 62209-1, "Procedure to measure the Specific Absorption Rate (SAR) for hand-held devices used in close proximity to the ear (frequency range of 300 MHz to 3 GHz)", February 2005
- Federal Communications Commission Office of Engineering & Technology (FCC OET), "Evaluating Compliance with FCC Guidelines for Human Exposure to Radiofrequency Electromagnetic Fields; Additional Information for Evaluating Compliance of Mobile and Portable Devices with FCC Limits for Human Exposure to Radiofrequency Emissions", Supplement C (Edition 01-01) to Bulletin 65

Additional Documentation:

- DASY4/5 System Handbook

Methods Applied and Interpretation of Parameters:

- Measurement Conditions:** Further details are available from the Validation Report at the end of the certificate. All figures stated in the certificate are valid at the frequency indicated.
- Antenna Parameters with TSL:** The dipole is mounted with the spacer to position its feed point exactly below the center marking of the flat phantom section, with the arms oriented parallel to the body axis.
- Feed Point Impedance and Return Loss:** These parameters are measured with the dipole positioned under the liquid filled phantom. The impedance stated is transformed from the measurement at the SMA connector to the feed point. The Return Loss ensures low reflected power. No uncertainty required.
- Electrical Delay:** One-way delay between the SMA connector and the antenna feed point. No uncertainty required.
- SAR measured:** SAR measured at the stated antenna input power.
- SAR normalized:** SAR as measured, normalized to an input power of 1 W at the antenna connector.
- SAR for nominal TSL parameters:** The measured TSL parameters are used to calculate the nominal SAR result.

The reported uncertainty of measurement is stated as the standard uncertainty of measurement multiplied by the coverage factor $k=2$, which for a normal distribution corresponds to a coverage probability of approximately 95%.

Measurement Conditions

DASY system configuration, as far as not given on page 1.

DASY Version	DASY5	V52.8.5
Extrapolation	Advanced Extrapolation	
Phantom	Modular Flat Phantom	
Distance Dipole Center - TSL	10 mm	with Spacer
Zoom Scan Resolution	dx, dy, dz = 5 mm	
Frequency	1900 MHz \pm 1 MHz	

Head TSL parameters

The following parameters and calculations were applied.

	Temperature	Permittivity	Conductivity
Nominal Head TSL parameters	22.0 °C	40.0	1.40 mho/m
Measured Head TSL parameters	(22.0 \pm 0.2) °C	39.4 \pm 6 %	1.38 mho/m \pm 6 %
Head TSL temperature change during test	< 0.5 °C	----	----

SAR result with Head TSL

SAR averaged over 1 cm³ (1 g) of Head TSL	Condition	
SAR measured	250 mW input power	10.1 W/kg
SAR for nominal Head TSL parameters	normalized to 1W	40.6 W/kg \pm 17.0 % (k=2)

SAR averaged over 10 cm³ (10 g) of Head TSL	condition	
SAR measured	250 mW input power	5.31 W/kg
SAR for nominal Head TSL parameters	normalized to 1W	21.3 W/kg \pm 16.5 % (k=2)

Body TSL parameters

The following parameters and calculations were applied.

	Temperature	Permittivity	Conductivity
Nominal Body TSL parameters	22.0 °C	53.3	1.52 mho/m
Measured Body TSL parameters	(22.0 \pm 0.2) °C	52.2 \pm 6 %	1.52 mho/m \pm 6 %
Body TSL temperature change during test	< 0.5 °C	----	----

SAR result with Body TSL

SAR averaged over 1 cm³ (1 g) of Body TSL	Condition	
SAR measured	250 mW input power	10.3 W/kg
SAR for nominal Body TSL parameters	normalized to 1W	41.0 W/kg \pm 17.0 % (k=2)

SAR averaged over 10 cm³ (10 g) of Body TSL	condition	
SAR measured	250 mW input power	5.42 W/kg
SAR for nominal Body TSL parameters	normalized to 1W	21.6 W/kg \pm 16.5 % (k=2)

Appendix

Antenna Parameters with Head TSL

Impedance, transformed to feed point	51.1 Ω + 5.0 j Ω
Return Loss	- 26.0 dB

Antenna Parameters with Body TSL

Impedance, transformed to feed point	47.5 Ω + 5.2 j Ω
Return Loss	- 24.5 dB

General Antenna Parameters and Design

Electrical Delay (one direction)	1.197 ns
----------------------------------	----------

After long term use with 100W radiated power, only a slight warming of the dipole near the feedpoint can be measured.

The dipole is made of standard semirigid coaxial cable. The center conductor of the feeding line is directly connected to the second arm of the dipole. The antenna is therefore short-circuited for DC-signals. On some of the dipoles, small end caps are added to the dipole arms in order to improve matching when loaded according to the position as explained in the "Measurement Conditions" paragraph. The SAR data are not affected by this change. The overall dipole length is still according to the Standard.

No excessive force must be applied to the dipole arms, because they might bend or the soldered connections near the feedpoint may be damaged.

Additional EUT Data

Manufactured by	SPEAG
Manufactured on	May 08, 2003

DASY5 Validation Report for Head TSL

Date: 21.01.2013

Test Laboratory: SPEAG, Zurich, Switzerland

DUT: Dipole 1900 MHz; Type: D1900V2; Serial: D1900V2 - SN: 5d036

Communication System: CW; Frequency: 1900 MHz

Medium parameters used: $f = 1900$ MHz; $\sigma = 1.38$ S/m; $\epsilon_r = 39.4$; $\rho = 1000$ kg/m³

Phantom section: Flat Section

Measurement Standard: DASY5 (IEEE/IEC/ANSI C63.19-2007)

DASY52 Configuration:

- Probe: ES3DV3 - SN3205; ConvF(4.98, 4.98, 4.98); Calibrated: 28.12.2012;
- Sensor-Surface: 3mm (Mechanical Surface Detection)
- Electronics: DAE4 Sn601; Calibrated: 27.06.2012
- Phantom: Flat Phantom 5.0 (front); Type: QD000P50AA; Serial: 1001
- DASY52 52.8.5(1059); SEMCAD X 14.6.8(7028)

Dipole Calibration for Head Tissue/Pin=250 mW, d=10mm/Zoom Scan (7x7x7)/Cube 0:

Measurement grid: dx=5mm, dy=5mm, dz=5mm

Reference Value = 98.363 V/m; Power Drift = 0.05 dB

Peak SAR (extrapolated) = 18.4 W/kg

SAR(1 g) = 10.1 W/kg; SAR(10 g) = 5.31 W/kg

Maximum value of SAR (measured) = 12.6 W/kg

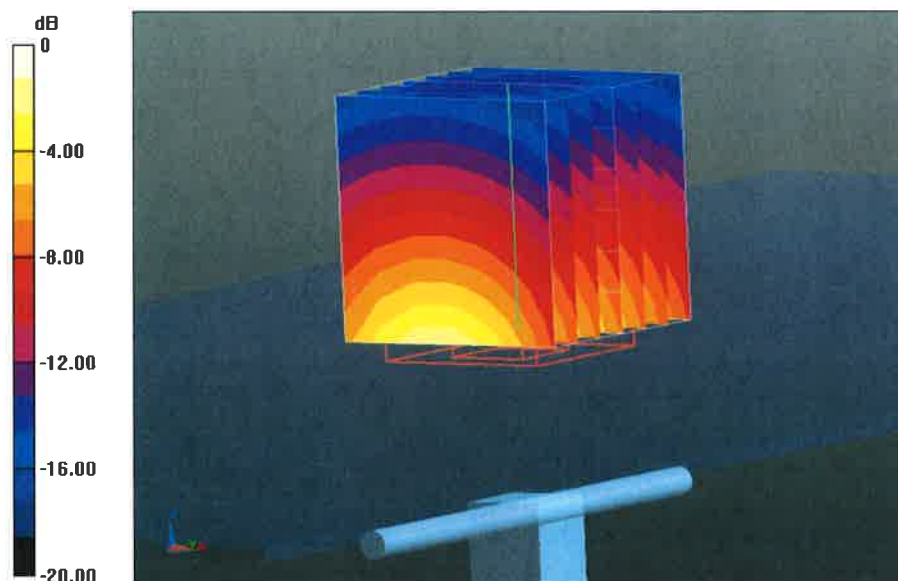

0 dB = 12.6 W/kg = 11.00 dBW/kg

Impedance Measurement Plot for Head TSL

21 Jan 2013 11:06:43

CH1 S11 1 U FS 1: 51.111 Ω 4.9570 Ω 415.23 pH 1 900.000 000 MHz

*
De1
Cor
Avg
16
H1d

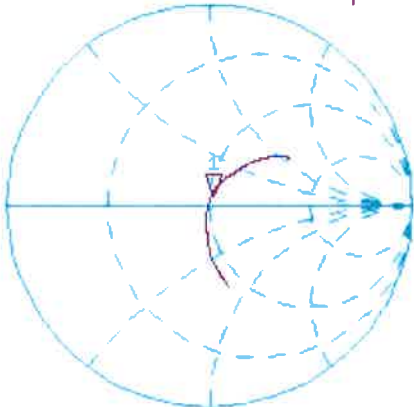

CH2 S11 LOG 5 dB/REF -20 dB 1: -25.996 dB 1 900.000 000 MHz

Cor
Avg
16
H1d



DASY5 Validation Report for Body TSL

Date: 21.01.2013

Test Laboratory: SPEAG, Zurich, Switzerland

DUT: Dipole 1900 MHz; Type: D1900V2; Serial: D1900V2 - SN: 5d036

Communication System: CW; Frequency: 1900 MHz

Medium parameters used: $f = 1900$ MHz; $\sigma = 1.52$ S/m; $\epsilon_r = 52.2$; $\rho = 1000$ kg/m³

Phantom section: Flat Section

Measurement Standard: DASY5 (IEEE/IEC/ANSI C63.19-2007)

DASY52 Configuration:

- Probe: ES3DV3 - SN3205; ConvF(4.6, 4.6, 4.6); Calibrated: 28.12.2012;
- Sensor-Surface: 3mm (Mechanical Surface Detection)
- Electronics: DAE4 Sn601; Calibrated: 27.06.2012
- Phantom: Flat Phantom 5.0 (back); Type: QD000P50AA; Serial: 1002
- DASY52 52.8.5(1059); SEMCAD X 14.6.8(7028)

Dipole Calibration for Body Tissue/Pin=250 mW, d=10mm/Zoom Scan (7x7x7)/Cube 0:

Measurement grid: dx=5mm, dy=5mm, dz=5mm

Reference Value = 96.692 V/m; Power Drift = 0.05 dB

Peak SAR (extrapolated) = 18.0 W/kg

SAR(1 g) = 10.3 W/kg; SAR(10 g) = 5.42 W/kg

Maximum value of SAR (measured) = 13.0 W/kg

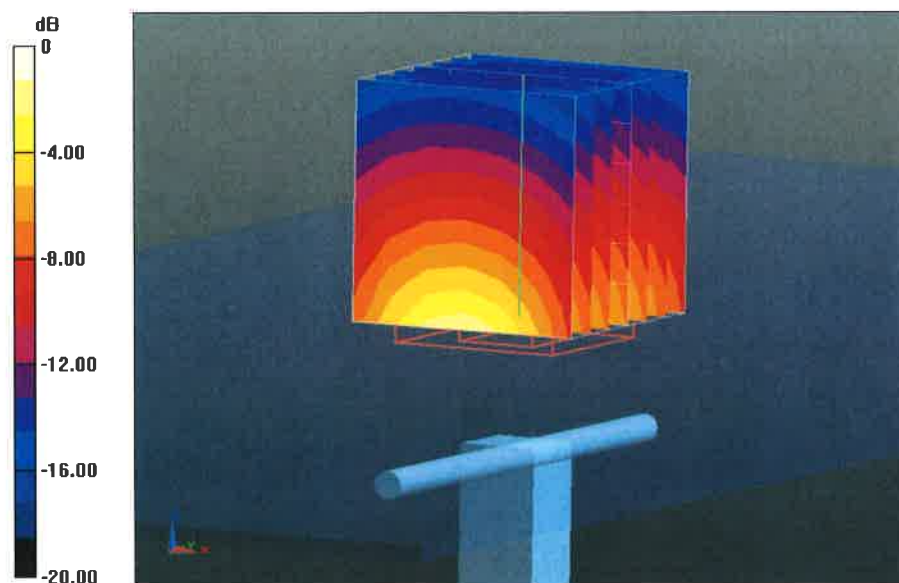

Impedance Measurement Plot for Body TSL

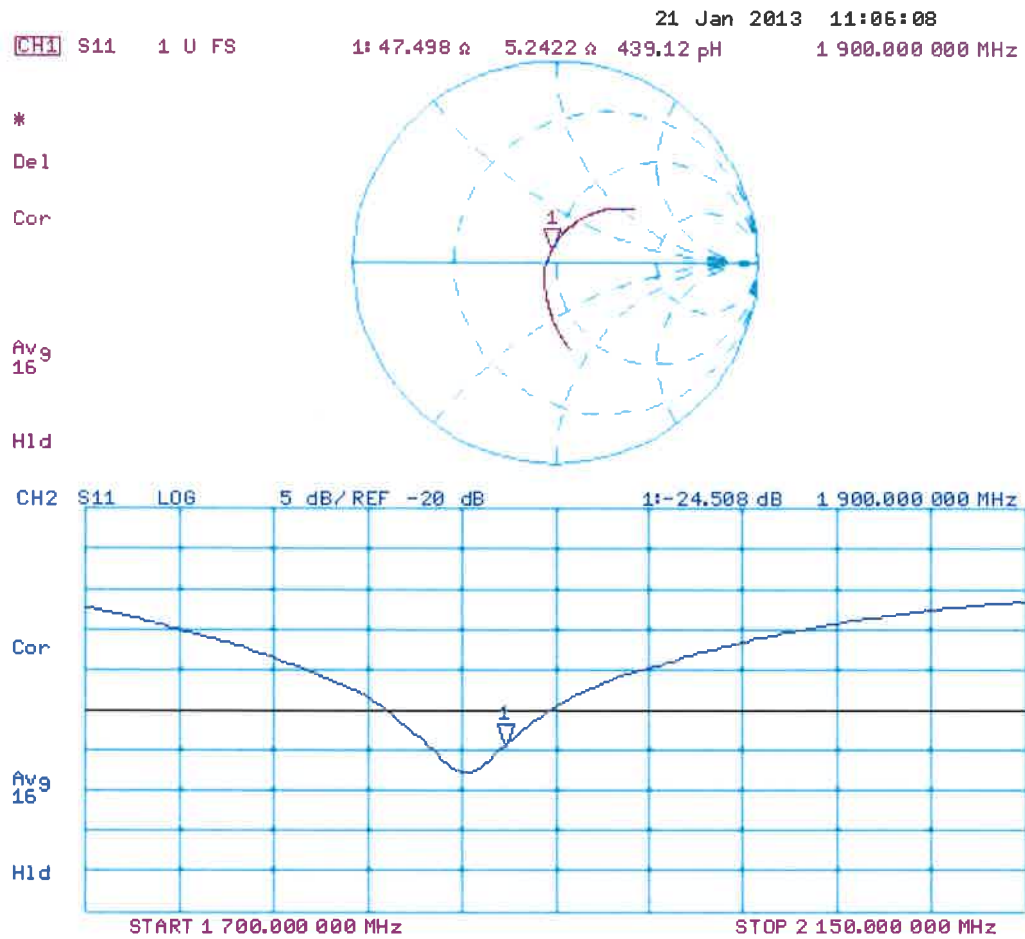



Accredited by the Swiss Accreditation Service (SAS)
 The Swiss Accreditation Service is one of the signatories to the EA
 Multilateral Agreement for the recognition of calibration certificates

Accreditation No.: **SCS 108**

Client **B.V. ADT (Auden)**

Certificate No: **D2450V2-737_Jan13**

CALIBRATION CERTIFICATE

Object **D2450V2 - SN: 737**

Calibration procedure(s) **QA CAL-05.v9**
Calibration procedure for dipole validation kits above 700 MHz

Calibration date: **January 21, 2013**

This calibration certificate documents the traceability to national standards, which realize the physical units of measurements (SI).
 The measurements and the uncertainties with confidence probability are given on the following pages and are part of the certificate.

All calibrations have been conducted in the closed laboratory facility: environment temperature (22 ± 3)°C and humidity < 70%.

Calibration Equipment used (M&TE critical for calibration)

Primary Standards	ID #	Cal Date (Certificate No.)	Scheduled Calibration
Power meter EPM-442A	GB37480704	01-Nov-12 (No. 217-01640)	Oct-13
Power sensor HP 8481A	US37292783	01-Nov-12 (No. 217-01640)	Oct-13
Reference 20 dB Attenuator	SN: 5058 (20k)	27-Mar-12 (No. 217-01530)	Apr-13
Type-N mismatch combination	SN: 5047.3 / 06327	27-Mar-12 (No. 217-01533)	Apr-13
Reference Probe ES3DV3	SN: 3205	28-Dec-12 (No. ES3-3205_Dec12)	Dec-13
DAE4	SN: 601	27-Jun-12 (No. DAE4-601_Jun12)	Jun-13
Secondary Standards	ID #	Check Date (in house)	Scheduled Check
Power sensor HP 8481A	MY41092317	18-Oct-02 (in house check Oct-11)	In house check: Oct-13
RF generator R&S SMT-06	100005	04-Aug-99 (in house check Oct-11)	In house check: Oct-13
Network Analyzer HP 8753E	US37390585 S4206	18-Oct-01 (in house check Oct-12)	In house check: Oct-13

Calibrated by: **Leif Klynsner** **Laboratory Technician** *Leif Klynsner*

Approved by: **Fin Bomholt** **Deputy Technical Manager** *F. Bomholt*

Issued: January 21, 2013

This calibration certificate shall not be reproduced except in full without written approval of the laboratory.



Accredited by the Swiss Accreditation Service (SAS)

The Swiss Accreditation Service is one of the signatories to the EA Multilateral Agreement for the recognition of calibration certificates

Accreditation No.: **SCS 108**

Glossary:

TSL	tissue simulating liquid
ConvF	sensitivity in TSL / NORM x,y,z
N/A	not applicable or not measured

Calibration is Performed According to the Following Standards:

- IEEE Std 1528-2003, "IEEE Recommended Practice for Determining the Peak Spatial-Averaged Specific Absorption Rate (SAR) in the Human Head from Wireless Communications Devices: Measurement Techniques", December 2003
- IEC 62209-1, "Procedure to measure the Specific Absorption Rate (SAR) for hand-held devices used in close proximity to the ear (frequency range of 300 MHz to 3 GHz)", February 2005
- Federal Communications Commission Office of Engineering & Technology (FCC OET), "Evaluating Compliance with FCC Guidelines for Human Exposure to Radiofrequency Electromagnetic Fields; Additional Information for Evaluating Compliance of Mobile and Portable Devices with FCC Limits for Human Exposure to Radiofrequency Emissions", Supplement C (Edition 01-01) to Bulletin 65

Additional Documentation:

- DASY4/5 System Handbook

Methods Applied and Interpretation of Parameters:

- Measurement Conditions:** Further details are available from the Validation Report at the end of the certificate. All figures stated in the certificate are valid at the frequency indicated.
- Antenna Parameters with TSL:** The dipole is mounted with the spacer to position its feed point exactly below the center marking of the flat phantom section, with the arms oriented parallel to the body axis.
- Feed Point Impedance and Return Loss:** These parameters are measured with the dipole positioned under the liquid filled phantom. The impedance stated is transformed from the measurement at the SMA connector to the feed point. The Return Loss ensures low reflected power. No uncertainty required.
- Electrical Delay:** One-way delay between the SMA connector and the antenna feed point. No uncertainty required.
- SAR measured:** SAR measured at the stated antenna input power.
- SAR normalized:** SAR as measured, normalized to an input power of 1 W at the antenna connector.
- SAR for nominal TSL parameters:** The measured TSL parameters are used to calculate the nominal SAR result.

The reported uncertainty of measurement is stated as the standard uncertainty of measurement multiplied by the coverage factor $k=2$, which for a normal distribution corresponds to a coverage probability of approximately 95%.

Measurement Conditions

DASY system configuration, as far as not given on page 1.

DASY Version	DASY5	V52.8.5
Extrapolation	Advanced Extrapolation	
Phantom	Modular Flat Phantom	
Distance Dipole Center - TSL	10 mm	with Spacer
Zoom Scan Resolution	dx, dy, dz = 5 mm	
Frequency	2450 MHz ± 1 MHz	

Head TSL parameters

The following parameters and calculations were applied.

	Temperature	Permittivity	Conductivity
Nominal Head TSL parameters	22.0 °C	39.2	1.80 mho/m
Measured Head TSL parameters	(22.0 ± 0.2) °C	37.9 ± 6 %	1.85 mho/m ± 6 %
Head TSL temperature change during test	< 0.5 °C	----	----

SAR result with Head TSL

SAR averaged over 1 cm³ (1 g) of Head TSL	Condition	
SAR measured	250 mW input power	13.4 W/kg
SAR for nominal Head TSL parameters	normalized to 1W	52.5 W/kg ± 17.0 % (k=2)

SAR averaged over 10 cm³ (10 g) of Head TSL	condition	
SAR measured	250 mW input power	6.17 W/kg
SAR for nominal Head TSL parameters	normalized to 1W	24.4 W/kg ± 16.5 % (k=2)

Body TSL parameters

The following parameters and calculations were applied.

	Temperature	Permittivity	Conductivity
Nominal Body TSL parameters	22.0 °C	52.7	1.95 mho/m
Measured Body TSL parameters	(22.0 ± 0.2) °C	50.5 ± 6 %	2.01 mho/m ± 6 %
Body TSL temperature change during test	< 0.5 °C	----	----

SAR result with Body TSL

SAR averaged over 1 cm³ (1 g) of Body TSL	Condition	
SAR measured	250 mW input power	12.7 W/kg
SAR for nominal Body TSL parameters	normalized to 1W	49.6 W/kg ± 17.0 % (k=2)

SAR averaged over 10 cm³ (10 g) of Body TSL	condition	
SAR measured	250 mW input power	5.86 W/kg
SAR for nominal Body TSL parameters	normalized to 1W	23.1 W/kg ± 16.5 % (k=2)

Appendix

Antenna Parameters with Head TSL

Impedance, transformed to feed point	53.4 Ω + 3.7 j Ω
Return Loss	- 26.3 dB

Antenna Parameters with Body TSL

Impedance, transformed to feed point	50.1 Ω + 5.3 j Ω
Return Loss	- 25.5 dB

General Antenna Parameters and Design

Electrical Delay (one direction)	1.161 ns
----------------------------------	----------

After long term use with 100W radiated power, only a slight warming of the dipole near the feedpoint can be measured.

The dipole is made of standard semirigid coaxial cable. The center conductor of the feeding line is directly connected to the second arm of the dipole. The antenna is therefore short-circuited for DC-signals. On some of the dipoles, small end caps are added to the dipole arms in order to improve matching when loaded according to the position as explained in the "Measurement Conditions" paragraph. The SAR data are not affected by this change. The overall dipole length is still according to the Standard.

No excessive force must be applied to the dipole arms, because they might bend or the soldered connections near the feedpoint may be damaged.

Additional EUT Data

Manufactured by	SPEAG
Manufactured on	August 26, 2003

DASY5 Validation Report for Head TSL

Date: 21.01.2013

Test Laboratory: SPEAG, Zurich, Switzerland

DUT: Dipole 2450 MHz; Type: D2450V2; Serial: D2450V2 - SN: 737

Communication System: CW; Frequency: 2450 MHz

Medium parameters used: $f = 2450$ MHz; $\sigma = 1.85$ S/m; $\epsilon_r = 37.9$; $\rho = 1000$ kg/m³

Phantom section: Flat Section

Measurement Standard: DASY5 (IEEE/IEC/ANSI C63.19-2007)

DASY52 Configuration:

- Probe: ES3DV3 - SN3205; ConvF(4.52, 4.52, 4.52); Calibrated: 28.12.2012;
- Sensor-Surface: 3mm (Mechanical Surface Detection)
- Electronics: DAE4 Sn601; Calibrated: 27.06.2012
- Phantom: Flat Phantom 5.0 (front); Type: QD000P50AA; Serial: 1001
- DASY52 52.8.5(1059); SEMCAD X 14.6.8(7028)

Dipole Calibration for Head Tissue/Pin=250 mW, d=10mm/Zoom Scan (7x7x7)/Cube 0:

Measurement grid: dx=5mm, dy=5mm, dz=5mm

Reference Value = 99.892 V/m; Power Drift = 0.05 dB

Peak SAR (extrapolated) = 28.0 W/kg

SAR(1 g) = 13.4 W/kg; SAR(10 g) = 6.17 W/kg

Maximum value of SAR (measured) = 17.2 W/kg

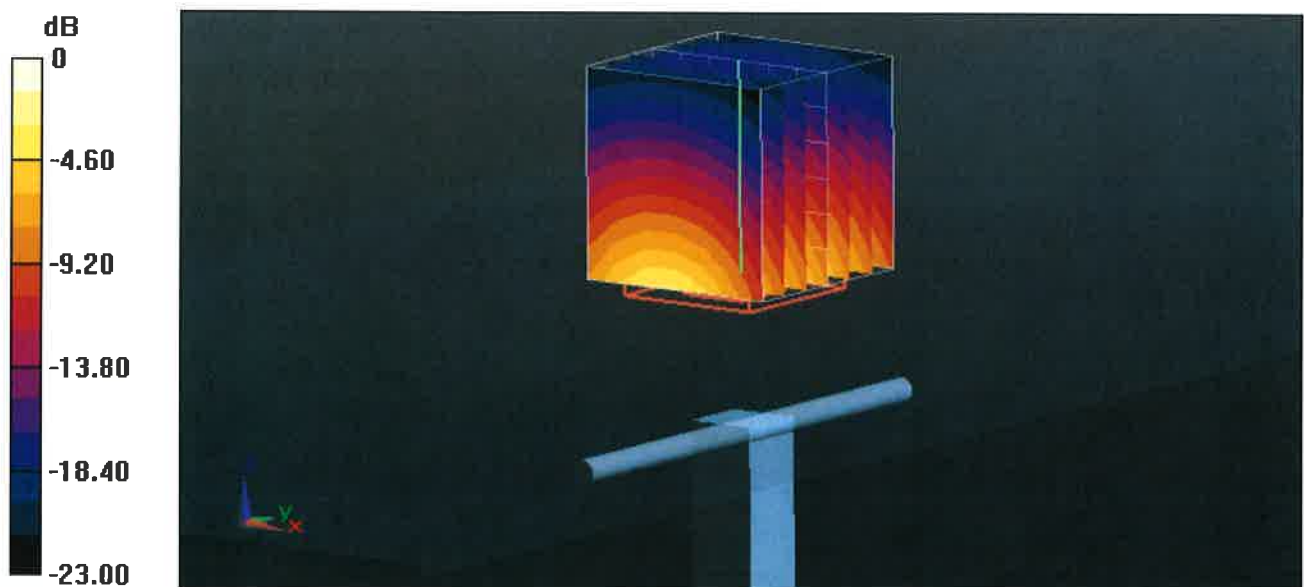

Impedance Measurement Plot for Head TSL

18 Jan 2013 12:34:33
 CH1 S11 1 U FS 3: 53.387 Δ 3.7109 Δ 241.07 pH 2 450.000 000 MHz

*
 De l

CA

Avg
 16

H1d

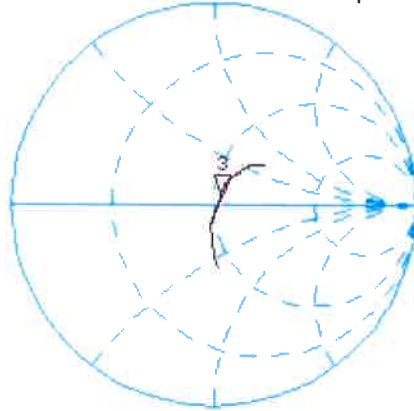

CH2 S11 LOG 5 dB/REF -20 dB 3:-26.268 dB 2 450.000 000 MHz

CA

Avg
 16

H1d

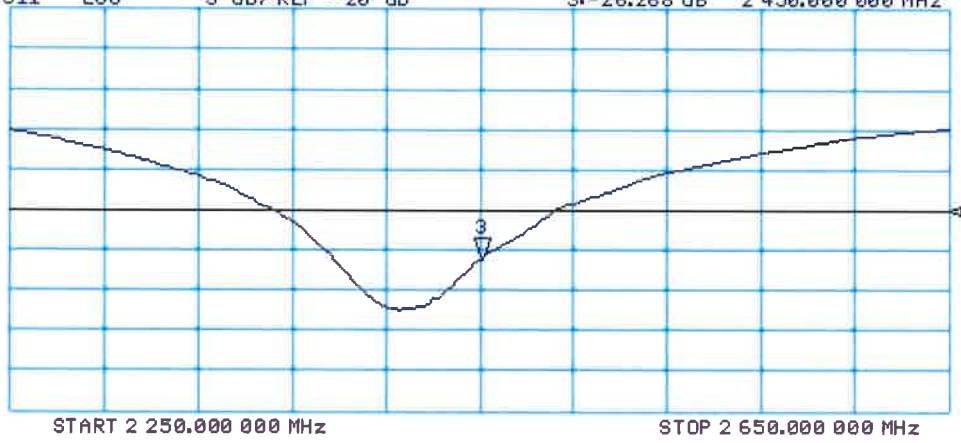

DASY5 Validation Report for Body TSL

Date: 18.01.2013

Test Laboratory: SPEAG, Zurich, Switzerland

DUT: Dipole 2450 MHz; Type: D2450V2; Serial: D2450V2 - SN: 737

Communication System: CW; Frequency: 2450 MHz

Medium parameters used: $f = 2450$ MHz; $\sigma = 2.01$ S/m; $\epsilon_r = 50.5$; $\rho = 1000$ kg/m³

Phantom section: Flat Section

Measurement Standard: DASY5 (IEEE/IEC/ANSI C63.19-2007)

DASY52 Configuration:

- Probe: ES3DV3 - SN3205; ConvF(4.42, 4.42, 4.42); Calibrated: 28.12.2012;
- Sensor-Surface: 3mm (Mechanical Surface Detection)
- Electronics: DAE4 Sn601; Calibrated: 27.06.2012
- Phantom: Flat Phantom 5.0 (back); Type: QD000P50AA; Serial: 1002
- DASY52 52.8.5(1059); SEMCAD X 14.6.8(7028)

Dipole Calibration for Body Tissue/Pin=250 mW, d=10mm/Zoom Scan (7x7x7)/Cube 0:

Measurement grid: dx=5mm, dy=5mm, dz=5mm

Reference Value = 94.076 V/m; Power Drift = 0.01 dB

Peak SAR (extrapolated) = 26.9 W/kg

SAR(1 g) = 12.7 W/kg; SAR(10 g) = 5.86 W/kg

Maximum value of SAR (measured) = 16.8 W/kg



0 dB = 16.8 W/kg = 12.25 dBW/kg

Impedance Measurement Plot for Body TSL

18 Jan 2013 12:34:02
[CH1] S11 1 U FS 3: 50.123 Δ 5.3340 Δ 346.50 pH 2 450.000 000 MHz

*
De1

C Δ

Avg
16

H1d

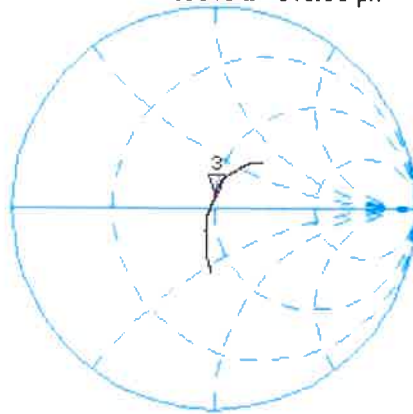

CH2 S11 LOG 5 dB/REF -20 dB 3:-25.479 dB 2 450.000 000 MHz

C Δ

Avg
16

H1d





Accredited by the Swiss Accreditation Service (SAS)
The Swiss Accreditation Service is one of the signatories to the EA
Multilateral Agreement for the recognition of calibration certificates

Accreditation No.: **SCS 108**

Client **B.V. ADT (Auden)**

Certificate No: **D2600V2-1020_Jan13**

CALIBRATION CERTIFICATE

Object **D2600V2 - SN: 1020**

Calibration procedure(s) **QA CAL-05.v9
Calibration procedure for dipole validation kits above 700 MHz**

Calibration date: **January 18, 2013**

This calibration certificate documents the traceability to national standards, which realize the physical units of measurements (SI).
The measurements and the uncertainties with confidence probability are given on the following pages and are part of the certificate.

All calibrations have been conducted in the closed laboratory facility: environment temperature (22 ± 3)°C and humidity < 70%.

Calibration Equipment used (M&TE critical for calibration)

Primary Standards	ID #	Cal Date (Certificate No.)	Scheduled Calibration
Power meter EPM-442A	GB37480704	01-Nov-12 (No. 217-01640)	Oct-13
Power sensor HP 8481A	US37292783	01-Nov-12 (No. 217-01640)	Oct-13
Reference 20 dB Attenuator	SN: 5058 (20k)	27-Mar-12 (No. 217-01530)	Apr-13
Type-N mismatch combination	SN: 5047.3 / 06327	27-Mar-12 (No. 217-01533)	Apr-13
Reference Probe ES3DV3	SN: 3205	28-Dec-12 (No. ES3-3205_Dec12)	Dec-13
DAE4	SN: 601	27-Jun-12 (No. DAE4-601_Jun12)	Jun-13
Secondary Standards	ID #	Check Date (in house)	Scheduled Check
Power sensor HP 8481A	MY41092317	18-Oct-02 (in house check Oct-11)	In house check: Oct-13
RF generator R&S SMT-06	100005	04-Aug-99 (in house check Oct-11)	In house check: Oct-13
Network Analyzer HP 8753E	US37390585 S4206	18-Oct-01 (in house check Oct-12)	In house check: Oct-13

Calibrated by:	Name Israe El-Naouq	Function Laboratory Technician	Signature
Approved by:	Katja Pokovic	Technical Manager	

Issued: January 18, 2013

This calibration certificate shall not be reproduced except in full without written approval of the laboratory.



Accredited by the Swiss Accreditation Service (SAS)

The Swiss Accreditation Service is one of the signatories to the EA Multilateral Agreement for the recognition of calibration certificates

Accreditation No.: **SCS 108**

Glossary:

TSL	tissue simulating liquid
ConvF	sensitivity in TSL / NORM x,y,z
N/A	not applicable or not measured

Calibration is Performed According to the Following Standards:

- a) IEEE Std 1528-2003, "IEEE Recommended Practice for Determining the Peak Spatial-Averaged Specific Absorption Rate (SAR) in the Human Head from Wireless Communications Devices: Measurement Techniques", December 2003
- b) IEC 62209-1, "Procedure to measure the Specific Absorption Rate (SAR) for hand-held devices used in close proximity to the ear (frequency range of 300 MHz to 3 GHz)", February 2005
- c) Federal Communications Commission Office of Engineering & Technology (FCC OET), "Evaluating Compliance with FCC Guidelines for Human Exposure to Radiofrequency Electromagnetic Fields; Additional Information for Evaluating Compliance of Mobile and Portable Devices with FCC Limits for Human Exposure to Radiofrequency Emissions", Supplement C (Edition 01-01) to Bulletin 65

Additional Documentation:

- d) DASY4/5 System Handbook

Methods Applied and Interpretation of Parameters:

- *Measurement Conditions:* Further details are available from the Validation Report at the end of the certificate. All figures stated in the certificate are valid at the frequency indicated.
- *Antenna Parameters with TSL:* The dipole is mounted with the spacer to position its feed point exactly below the center marking of the flat phantom section, with the arms oriented parallel to the body axis.
- *Feed Point Impedance and Return Loss:* These parameters are measured with the dipole positioned under the liquid filled phantom. The impedance stated is transformed from the measurement at the SMA connector to the feed point. The Return Loss ensures low reflected power. No uncertainty required.
- *Electrical Delay:* One-way delay between the SMA connector and the antenna feed point. No uncertainty required.
- *SAR measured:* SAR measured at the stated antenna input power.
- *SAR normalized:* SAR as measured, normalized to an input power of 1 W at the antenna connector.
- *SAR for nominal TSL parameters:* The measured TSL parameters are used to calculate the nominal SAR result.

The reported uncertainty of measurement is stated as the standard uncertainty of measurement multiplied by the coverage factor $k=2$, which for a normal distribution corresponds to a coverage probability of approximately 95%.

Measurement Conditions

DASY system configuration, as far as not given on page 1.

DASY Version	DASY5	V52.8.5
Extrapolation	Advanced Extrapolation	
Phantom	Modular Flat Phantom	
Distance Dipole Center - TSL	10 mm	with Spacer
Zoom Scan Resolution	dx, dy, dz = 5 mm	
Frequency	2600 MHz ± 1 MHz	

Head TSL parameters

The following parameters and calculations were applied.

	Temperature	Permittivity	Conductivity
Nominal Head TSL parameters	22.0 °C	39.0	1.96 mho/m
Measured Head TSL parameters	(22.0 ± 0.2) °C	37.4 ± 6 %	2.02 mho/m ± 6 %
Head TSL temperature change during test	< 0.5 °C	----	----

SAR result with Head TSL

SAR averaged over 1 cm³ (1 g) of Head TSL	Condition	
SAR measured	250 mW input power	14.8 W/kg
SAR for nominal Head TSL parameters	normalized to 1W	57.8 W/kg ± 17.0 % (k=2)

SAR averaged over 10 cm³ (10 g) of Head TSL	condition	
SAR measured	250 mW input power	6.58 W/kg
SAR for nominal Head TSL parameters	normalized to 1W	26.0 W/kg ± 16.5 % (k=2)

Body TSL parameters

The following parameters and calculations were applied.

	Temperature	Permittivity	Conductivity
Nominal Body TSL parameters	22.0 °C	52.5	2.16 mho/m
Measured Body TSL parameters	(22.0 ± 0.2) °C	50.1 ± 6 %	2.19 mho/m ± 6 %
Body TSL temperature change during test	< 0.5 °C	----	----

SAR result with Body TSL

SAR averaged over 1 cm³ (1 g) of Body TSL	Condition	
SAR measured	250 mW input power	14.2 W/kg
SAR for nominal Body TSL parameters	normalized to 1W	55.8 W/kg ± 17.0 % (k=2)

SAR averaged over 10 cm³ (10 g) of Body TSL	condition	
SAR measured	250 mW input power	6.25 W/kg
SAR for nominal Body TSL parameters	normalized to 1W	24.7 W/kg ± 16.5 % (k=2)

Appendix

Antenna Parameters with Head TSL

Impedance, transformed to feed point	48.4 Ω - 4.3 j Ω
Return Loss	- 26.5 dB

Antenna Parameters with Body TSL

Impedance, transformed to feed point	45.2 Ω - 3.4 j Ω
Return Loss	- 24.2 dB

General Antenna Parameters and Design

Electrical Delay (one direction)	1.152 ns
----------------------------------	----------

After long term use with 100W radiated power, only a slight warming of the dipole near the feedpoint can be measured.

The dipole is made of standard semirigid coaxial cable. The center conductor of the feeding line is directly connected to the second arm of the dipole. The antenna is therefore short-circuited for DC-signals. On some of the dipoles, small end caps are added to the dipole arms in order to improve matching when loaded according to the position as explained in the "Measurement Conditions" paragraph. The SAR data are not affected by this change. The overall dipole length is still according to the Standard.

No excessive force must be applied to the dipole arms, because they might bend or the soldered connections near the feedpoint may be damaged.

Additional EUT Data

Manufactured by	SPEAG
Manufactured on	May 13, 2008

DASY5 Validation Report for Head TSL

Date: 18.01.2013

Test Laboratory: SPEAG, Zurich, Switzerland

DUT: Dipole 2600 MHz; Type: D2600V2; Serial: D2600V2 - SN: 1020

Communication System: CW; Frequency: 2600 MHz

Medium parameters used: $f = 2600$ MHz; $\sigma = 2.02$ S/m; $\epsilon_r = 37.4$; $\rho = 1000$ kg/m³

Phantom section: Flat Section

Measurement Standard: DASY5 (IEEE/IEC/ANSI C63.19-2007)

DASY52 Configuration:

- Probe: ES3DV3 - SN3205; ConvF(4.45, 4.45, 4.45); Calibrated: 28.12.2012;
- Sensor-Surface: 3mm (Mechanical Surface Detection)
- Electronics: DAE4 Sn601; Calibrated: 27.06.2012
- Phantom: Flat Phantom 5.0 (front); Type: QD000P50AA; Serial: 1001
- DASY52 52.8.5(1059); SEMCAD X 14.6.8(7028)

Dipole Calibration for Head Tissue/Pin=250 mW, d=10mm/Zoom Scan (7x7x7)/Cube 0:

Measurement grid: dx=5mm, dy=5mm, dz=5mm

Reference Value = 101.1 V/m; Power Drift = 0.07 dB

Peak SAR (extrapolated) = 32.3 W/kg

SAR(1 g) = 14.8 W/kg; SAR(10 g) = 6.58 W/kg

Maximum value of SAR (measured) = 19.0 W/kg

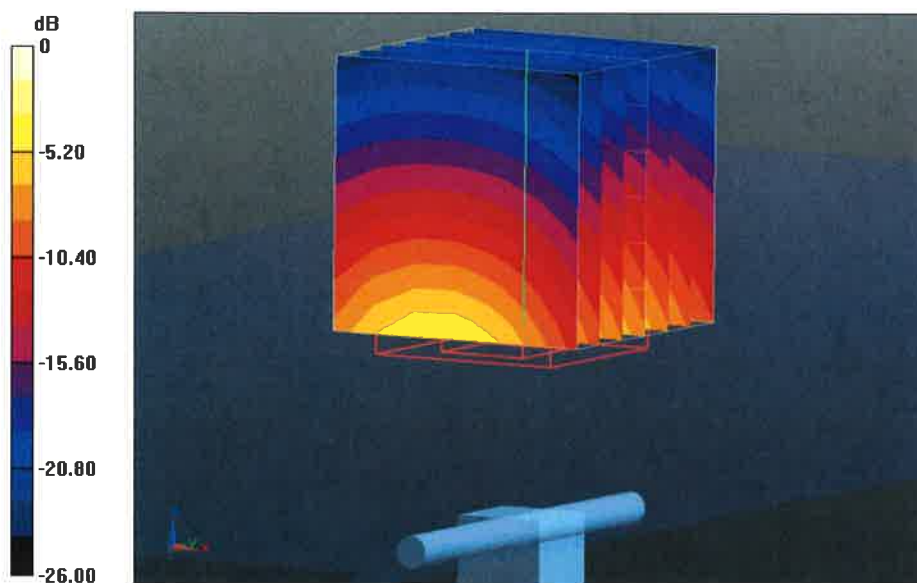

0 dB = 19.0 W/kg = 12.79 dBW/kg

Impedance Measurement Plot for Head TSL

18 Jan 2013 12:47:14

CH1 S11 1 U FS 4: 48.357 Ω -4.3340 Ω 14.124 pF 2 600.000 000 MHz

*
De1
CA

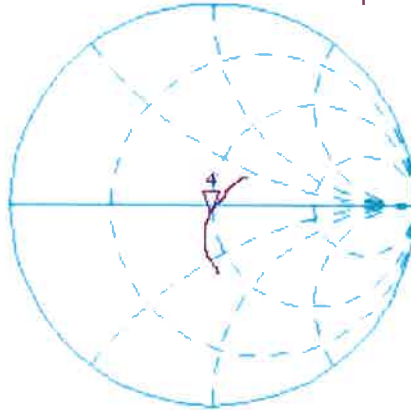

Avg
16

H1d

CH2 S11 LOG 5 dB/REF -20 dB 4:-26.541 dB 2 600.000 000 MHz

CA

Avg
16

H1d



START 2 400.000 000 MHz

STOP 2 800.000 000 MHz

DASY5 Validation Report for Body TSL

Date: 18.01.2013

Test Laboratory: SPEAG, Zurich, Switzerland

DUT: Dipole 2600 MHz; Type: D2600V2; Serial: D2600V2 - SN: 1020

Communication System: CW; Frequency: 2600 MHz

Medium parameters used: $f = 2600$ MHz; $\sigma = 2.19$ S/m; $\epsilon_r = 50.1$; $\rho = 1000$ kg/m³

Phantom section: Flat Section

Measurement Standard: DASY5 (IEEE/IEC/ANSI C63.19-2007)

DASY52 Configuration:

- Probe: ES3DV3 - SN3205; ConvF(4.32, 4.32, 4.32); Calibrated: 28.12.2012;
- Sensor-Surface: 3mm (Mechanical Surface Detection)
- Electronics: DAE4 Sn601; Calibrated: 27.06.2012
- Phantom: Flat Phantom 5.0 (back); Type: QD000P50AA; Serial: 1002
- DASY52 52.8.5(1059); SEMCAD X 14.6.8(7028)

Dipole Calibration for Body Tissue/Pin=250 mW, d=10mm/Zoom Scan (7x7x7)/Cube 0:

Measurement grid: dx=5mm, dy=5mm, dz=5mm

Reference Value = 95.715 V/m; Power Drift = 0.03 dB

Peak SAR (extrapolated) = 31.3 W/kg

SAR(1 g) = 14.2 W/kg; SAR(10 g) = 6.25 W/kg

Maximum value of SAR (measured) = 18.8 W/kg

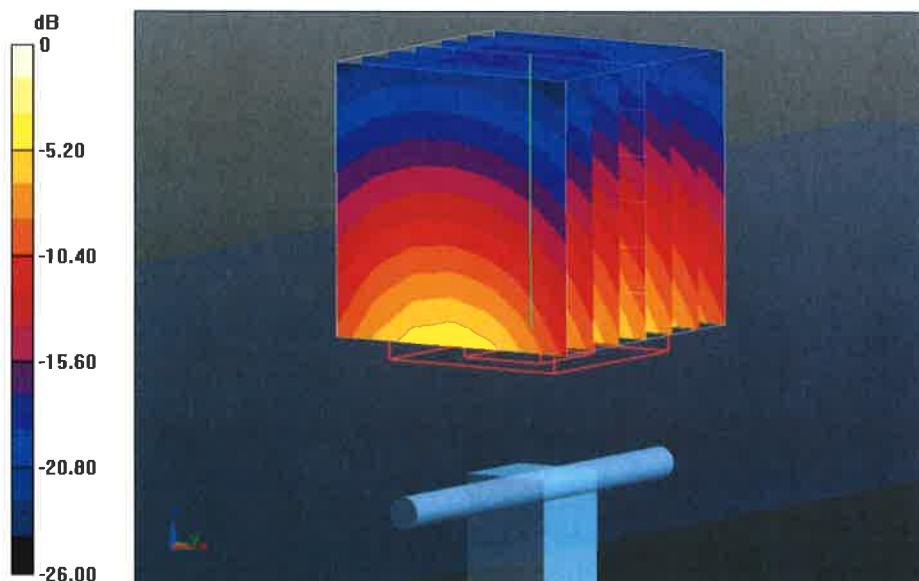

0 dB = 18.8 W/kg = 12.74 dBW/kg

Impedance Measurement Plot for Body TSL

18 Jan 2013 12:46:50

CH1 S11 1 U FS 4: 45.199 ω -3.4297 ω 17.848 pF 2 500.000 000 MHz

*
De1
CA

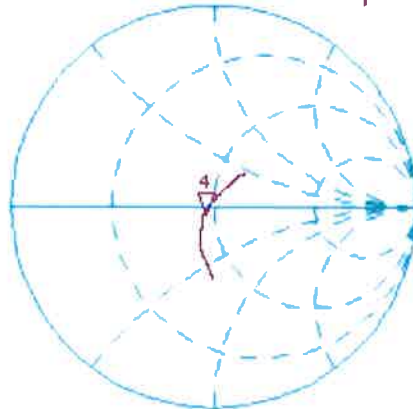

Avg
16

H1d

CH2 S11 LOG 5 dB/REF -20 dB 4: -24.162 dB 2 500.000 000 MHz

CA

Avg
16

H1d





Accredited by the Swiss Accreditation Service (SAS)
The Swiss Accreditation Service is one of the signatories to the EA
Multilateral Agreement for the recognition of calibration certificates

Accreditation No.: **SCS 108**

Client **B.V. ADT (Auden)**

Certificate No: **EX3-3590_Feb13/3**

CALIBRATION CERTIFICATE (Replacement of No: EX3-3590_Feb13/2)

Object **EX3DV4 - SN:3590**

Calibration procedure(s) **QA CAL-01.v8, QA CAL-14.v3, QA CAL-23.v4, QA CAL-25.v4
Calibration procedure for dosimetric E-field probes**

Calibration date: **February 20, 2013**

This calibration certificate documents the traceability to national standards, which realize the physical units of measurements (SI).
The measurements and the uncertainties with confidence probability are given on the following pages and are part of the certificate.

All calibrations have been conducted in the closed laboratory facility: environment temperature (22 ± 3)°C and humidity < 70%.

Calibration Equipment used (M&TE critical for calibration)

Primary Standards	ID	Cal Date (Certificate No.)	Scheduled Calibration
Power meter E4419B	GB41293874	29-Mar-12 (No. 217-01508)	Apr-13
Power sensor E4412A	MY41498087	29-Mar-12 (No. 217-01508)	Apr-13
Reference 3 dB Attenuator	SN: S5054 (3c)	27-Mar-12 (No. 217-01531)	Apr-13
Reference 20 dB Attenuator	SN: S5086 (20b)	27-Mar-12 (No. 217-01529)	Apr-13
Reference 30 dB Attenuator	SN: S5129 (30b)	27-Mar-12 (No. 217-01532)	Apr-13
Reference Probe ES3DV2	SN: 3013	28-Dec-12 (No. ES3-3013_Dec12)	Dec-13
DAE4	SN: 660	31-Jan-13 (No. DAE4-660_Jan13)	Jan-14
Secondary Standards	ID	Check Date (in house)	Scheduled Check
RF generator HP 8648C	US3642U01700	4-Aug-99 (in house check Apr-11)	In house check: Apr-13
Network Analyzer HP 8753E	US37390585	18-Oct-01 (in house check Oct-12)	In house check: Oct-13

Calibrated by: **Name** Claudio Leubler **Function** Laboratory Technician **Signature**

Approved by: **Name** Katja Pokovic **Function** Technical Manager **Signature**

Issued: April 22, 2013

This calibration certificate shall not be reproduced except in full without written approval of the laboratory.



Accredited by the Swiss Accreditation Service (SAS)

Accreditation No.: **SCS 108**

The Swiss Accreditation Service is one of the signatories to the EA
Multilateral Agreement for the recognition of calibration certificates

Glossary:

TSL	tissue simulating liquid
NORM _{x,y,z}	sensitivity in free space
ConvF	sensitivity in TSL / NORM _{x,y,z}
DCP	diode compression point
CF	crest factor (1/duty_cycle) of the RF signal
A, B, C, D	modulation dependent linearization parameters
Polarization φ	φ rotation around probe axis
Polarization ϑ	ϑ rotation around an axis that is in the plane normal to probe axis (at measurement center), i.e., $\vartheta = 0$ is normal to probe axis

Calibration is Performed According to the Following Standards:

- IEEE Std 1528-2003, "IEEE Recommended Practice for Determining the Peak Spatial-Averaged Specific Absorption Rate (SAR) in the Human Head from Wireless Communications Devices: Measurement Techniques", December 2003
- IEC 62209-1, "Procedure to measure the Specific Absorption Rate (SAR) for hand-held devices used in close proximity to the ear (frequency range of 300 MHz to 3 GHz)", February 2005

Methods Applied and Interpretation of Parameters:

- NORM_{x,y,z}**: Assessed for E-field polarization $\vartheta = 0$ ($f \leq 900$ MHz in TEM-cell; $f > 1800$ MHz: R22 waveguide). NORM_{x,y,z} are only intermediate values, i.e., the uncertainties of NORM_{x,y,z} does not affect the E^2 -field uncertainty inside TSL (see below *ConvF*).
- NORM(f)_{x,y,z}** = NORM_{x,y,z} * *frequency_response* (see Frequency Response Chart). This linearization is implemented in DASY4 software versions later than 4.2. The uncertainty of the frequency response is included in the stated uncertainty of *ConvF*.
- DCP_{x,y,z}**: DCP are numerical linearization parameters assessed based on the data of power sweep with CW signal (no uncertainty required). DCP does not depend on frequency nor media.
- PAR**: PAR is the Peak to Average Ratio that is not calibrated but determined based on the signal characteristics
- A_{x,y,z}; B_{x,y,z}; C_{x,y,z}; D_{x,y,z}; VR_{x,y,z}**: A, B, C, D are numerical linearization parameters assessed based on the data of power sweep for specific modulation signal. The parameters do not depend on frequency nor media. VR is the maximum calibration range expressed in RMS voltage across the diode.
- ConvF and Boundary Effect Parameters**: Assessed in flat phantom using E-field (or Temperature Transfer Standard for $f \leq 800$ MHz) and inside waveguide using analytical field distributions based on power measurements for $f > 800$ MHz. The same setups are used for assessment of the parameters applied for boundary compensation (alpha, depth) of which typical uncertainty values are given. These parameters are used in DASY4 software to improve probe accuracy close to the boundary. The sensitivity in TSL corresponds to NORM_{x,y,z} * *ConvF* whereby the uncertainty corresponds to that given for *ConvF*. A frequency dependent *ConvF* is used in DASY version 4.4 and higher which allows extending the validity from ± 50 MHz to ± 100 MHz.
- Spherical isotropy (3D deviation from isotropy)**: in a field of low gradients realized using a flat phantom exposed by a patch antenna.
- Sensor Offset**: The sensor offset corresponds to the offset of virtual measurement center from the probe tip (on probe axis). No tolerance required.

Probe EX3DV4

SN:3590

Manufactured: March 23, 2009
Calibrated: February 20, 2013

Calibrated for DASY/EASY Systems
(Note: non-compatible with DASY2 system!)

DASY/EASY - Parameters of Probe: EX3DV4 - SN:3590

Basic Calibration Parameters

	Sensor X	Sensor Y	Sensor Z	Unc (k=2)
Norm ($\mu\text{V}/(\text{V}/\text{m})^2$) ^A	0.50	0.47	0.50	$\pm 10.1 \%$
DCP (mV) ^B	94.4	97.2	92.1	

Modulation Calibration Parameters

UID	Communication System Name		A dB	B dB $\sqrt{\mu\text{V}}$	C	D dB	VR mV	Unc ^E (k=2)
0	CW	X	0.0	0.0	1.0	0.00	122.9	$\pm 3.0 \%$
		Y	0.0	0.0	1.0		144.4	
		Z	0.0	0.0	1.0		120.3	

The reported uncertainty of measurement is stated as the standard uncertainty of measurement multiplied by the coverage factor $k=2$, which for a normal distribution corresponds to a coverage probability of approximately 95%.

^A The uncertainties of NormX,Y,Z do not affect the E^2 -field uncertainty inside TSL (see Pages 5 and 6).

^B Numerical linearization parameter: uncertainty not required.

^E Uncertainty is determined using the max. deviation from linear response applying rectangular distribution and is expressed for the square of the field value.

DASY/EASY - Parameters of Probe: EX3DV4 - SN:3590

Calibration Parameter Determined in Head Tissue Simulating Media

f (MHz) ^C	Relative Permittivity ^F	Conductivity (S/m) ^F	ConvF X	ConvF Y	ConvF Z	Alpha	Depth (mm)	Unct. (k=2)
750	41.9	0.89	10.91	10.91	10.91	0.31	0.89	± 12.0 %
835	41.5	0.90	10.52	10.52	10.52	0.48	0.75	± 12.0 %
900	41.5	0.97	10.53	10.53	10.53	0.63	0.62	± 12.0 %
1450	40.5	1.20	9.08	9.08	9.08	0.17	1.62	± 12.0 %
1640	40.3	1.29	9.10	9.10	9.10	0.55	0.66	± 12.0 %
1750	40.1	1.37	8.89	8.89	8.89	0.54	0.67	± 12.0 %
1900	40.0	1.40	8.70	8.70	8.70	0.67	0.61	± 12.0 %
2000	40.0	1.40	8.67	8.67	8.67	0.73	0.59	± 12.0 %
2300	39.5	1.67	8.32	8.32	8.32	0.55	0.67	± 12.0 %
2450	39.2	1.80	7.88	7.88	7.88	0.46	0.74	± 12.0 %
2600	39.0	1.96	7.69	7.69	7.69	0.28	1.02	± 12.0 %
3500	37.9	2.91	7.75	7.75	7.75	0.57	0.81	± 13.1 %
5200	36.0	4.66	5.79	5.79	5.79	0.35	1.80	± 13.1 %
5300	35.9	4.76	5.61	5.61	5.61	0.32	1.80	± 13.1 %
5500	35.6	4.96	5.20	5.20	5.20	0.36	1.80	± 13.1 %
5600	35.5	5.07	5.05	5.05	5.05	0.40	1.80	± 13.1 %
5800	35.3	5.27	4.92	4.92	4.92	0.35	1.80	± 13.1 %

^C Frequency validity of ± 100 MHz only applies for DASY v4.4 and higher (see Page 2), else it is restricted to ± 50 MHz. The uncertainty is the RSS of the ConvF uncertainty at calibration frequency and the uncertainty for the indicated frequency band.

^F At frequencies below 3 GHz, the validity of tissue parameters (ϵ and σ) can be relaxed to ± 10% if liquid compensation formula is applied to measured SAR values. At frequencies above 3 GHz, the validity of tissue parameters (ϵ and σ) is restricted to ± 5%. The uncertainty is the RSS of the ConvF uncertainty for indicated target tissue parameters.

DASY/EASY - Parameters of Probe: EX3DV4 - SN:3590

Calibration Parameter Determined in Body Tissue Simulating Media

f (MHz) ^C	Relative Permittivity ^F	Conductivity (S/m) ^F	ConvF X	ConvF Y	ConvF Z	Alpha	Depth (mm)	Unct. (k=2)
750	55.5	0.96	10.60	10.60	10.60	0.80	0.62	± 12.0 %
835	55.2	0.97	10.43	10.43	10.43	0.60	0.71	± 12.0 %
900	55.0	1.05	10.32	10.32	10.32	0.69	0.66	± 12.0 %
1450	54.0	1.30	9.03	9.03	9.03	0.76	0.55	± 12.0 %
1640	53.8	1.40	9.42	9.42	9.42	0.62	0.68	± 12.0 %
1750	53.4	1.49	8.63	8.63	8.63	0.44	0.82	± 12.0 %
1900	53.3	1.52	8.39	8.39	8.39	0.34	0.86	± 12.0 %
2000	53.3	1.52	8.55	8.55	8.55	0.32	0.87	± 12.0 %
2300	52.9	1.81	8.20	8.20	8.20	0.69	0.60	± 12.0 %
2450	52.7	1.95	8.08	8.08	8.08	0.76	0.57	± 12.0 %
2600	52.5	2.16	7.83	7.83	7.83	0.58	0.50	± 12.0 %
3500	51.3	3.31	7.38	7.38	7.38	0.55	0.88	± 13.1 %
5200	49.0	5.30	5.15	5.15	5.15	0.40	1.90	± 13.1 %
5300	48.9	5.42	4.94	4.94	4.94	0.40	1.90	± 13.1 %
5500	48.6	5.65	4.57	4.57	4.57	0.46	1.90	± 13.1 %
5600	48.5	5.77	4.46	4.46	4.46	0.40	1.90	± 13.1 %
5800	48.2	6.00	4.72	4.72	4.72	0.46	1.90	± 13.1 %

^C Frequency validity of ± 100 MHz only applies for DASY v4.4 and higher (see Page 2), else it is restricted to ± 50 MHz. The uncertainty is the RSS of the ConvF uncertainty at calibration frequency and the uncertainty for the indicated frequency band.

^F At frequencies below 3 GHz, the validity of tissue parameters (ϵ and σ) can be relaxed to ± 10% if liquid compensation formula is applied to measured SAR values. At frequencies above 3 GHz, the validity of tissue parameters (ϵ and σ) is restricted to ± 5%. The uncertainty is the RSS of the ConvF uncertainty for indicated target tissue parameters.

Frequency Response of E-Field (TEM-Cell:ifi110 EXX, Waveguide: R22)

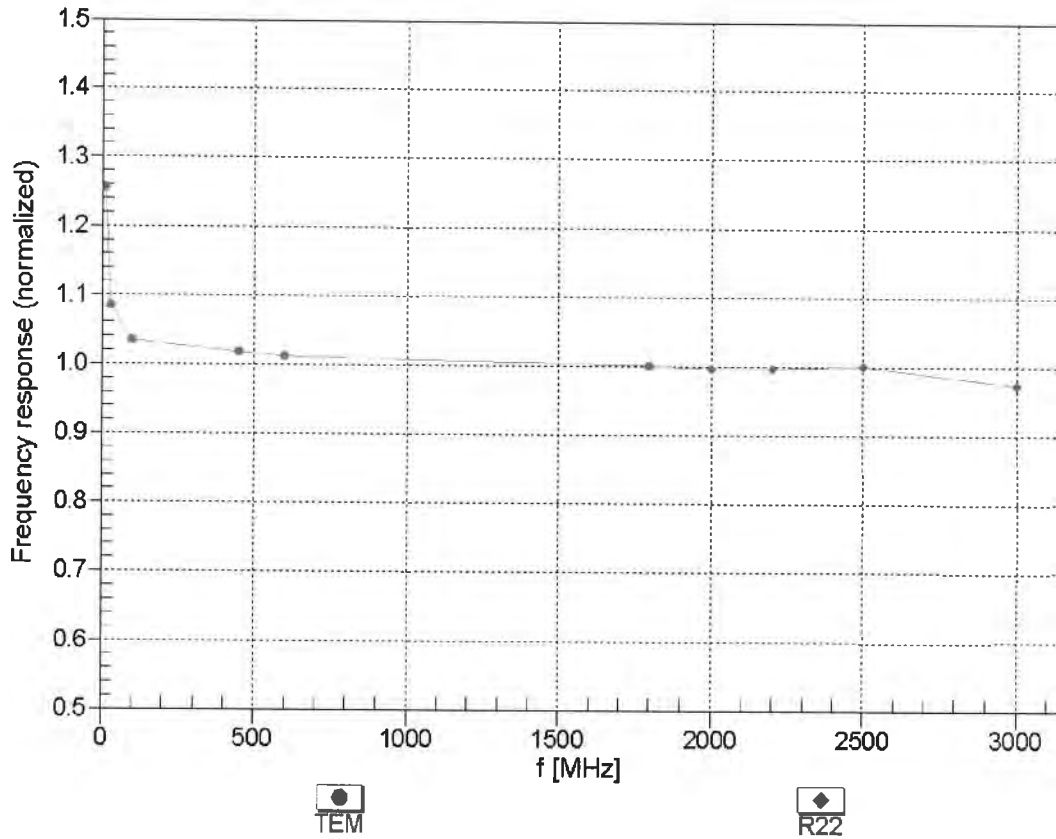

Uncertainty of Frequency Response of E-field: $\pm 6.3\%$ (k=2)

Receiving Pattern (ϕ), $\theta = 0^\circ$

f=600 MHz,TEM

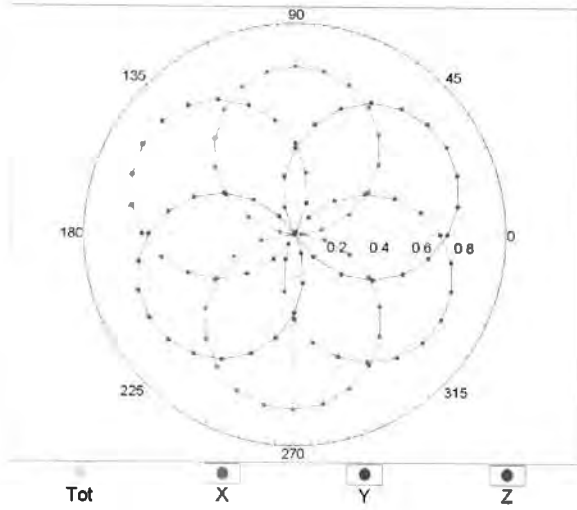

f=1800 MHz,R22

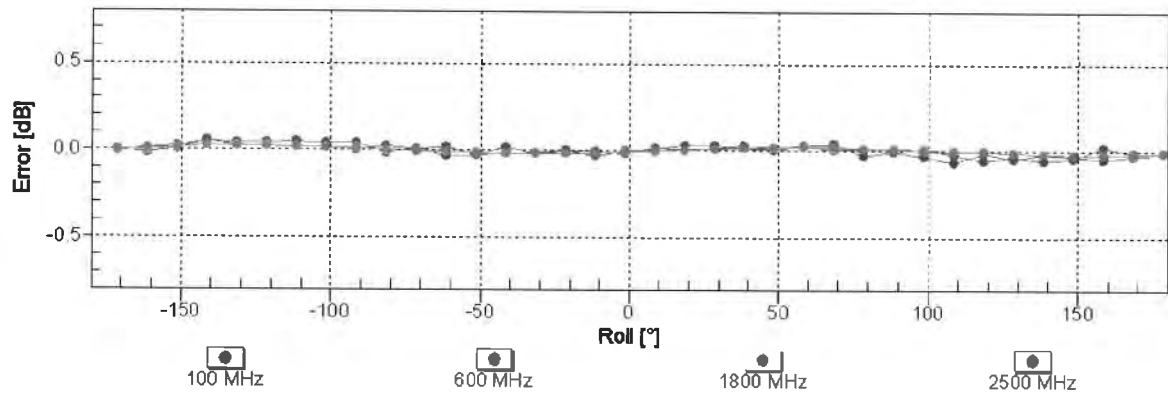
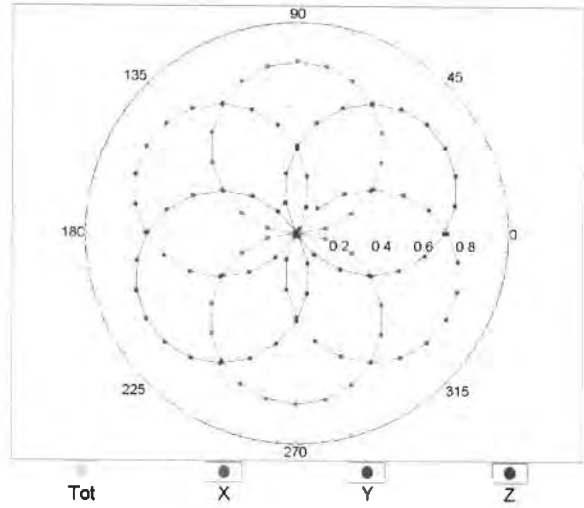

Uncertainty of Axial Isotropy Assessment: $\pm 0.5\%$ (k=2)

Dynamic Range $f(SAR_{head})$ (TEM cell , $f = 900$ MHz)

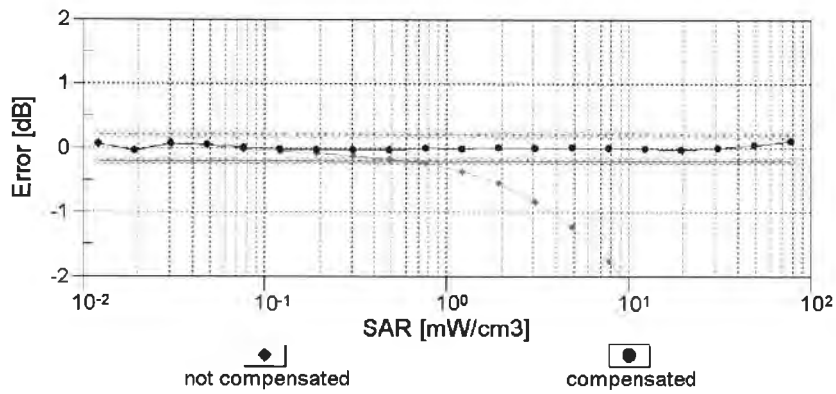
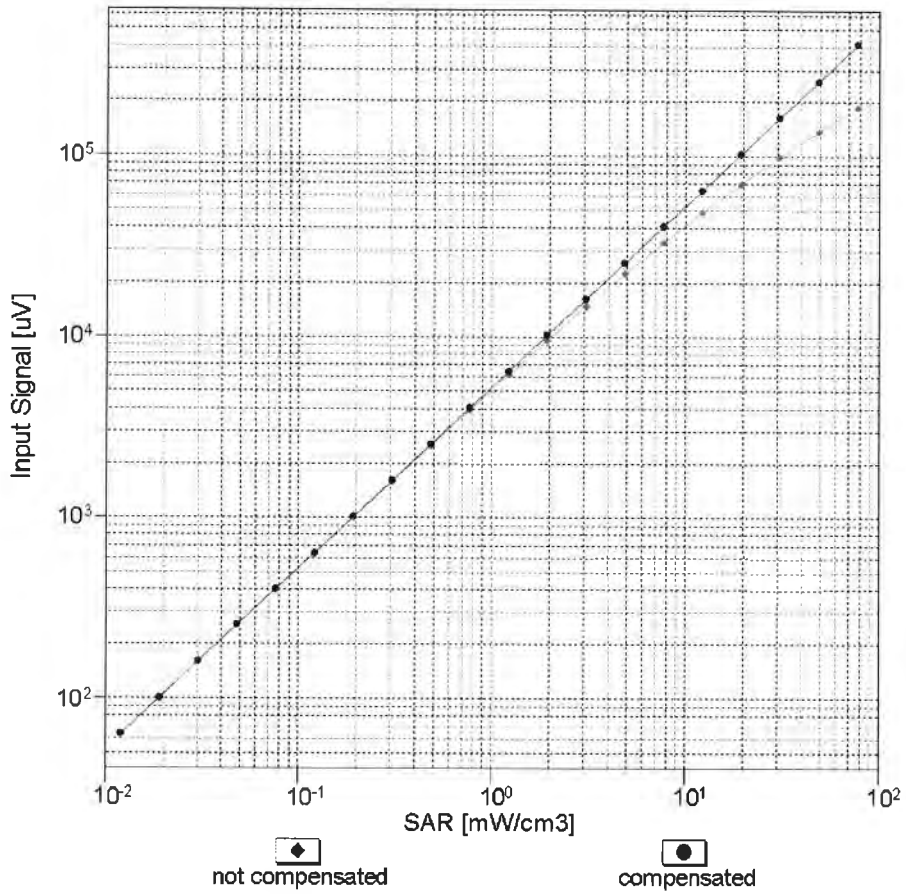

Uncertainty of Linearity Assessment: $\pm 0.6\%$ (k=2)

Conversion Factor Assessment

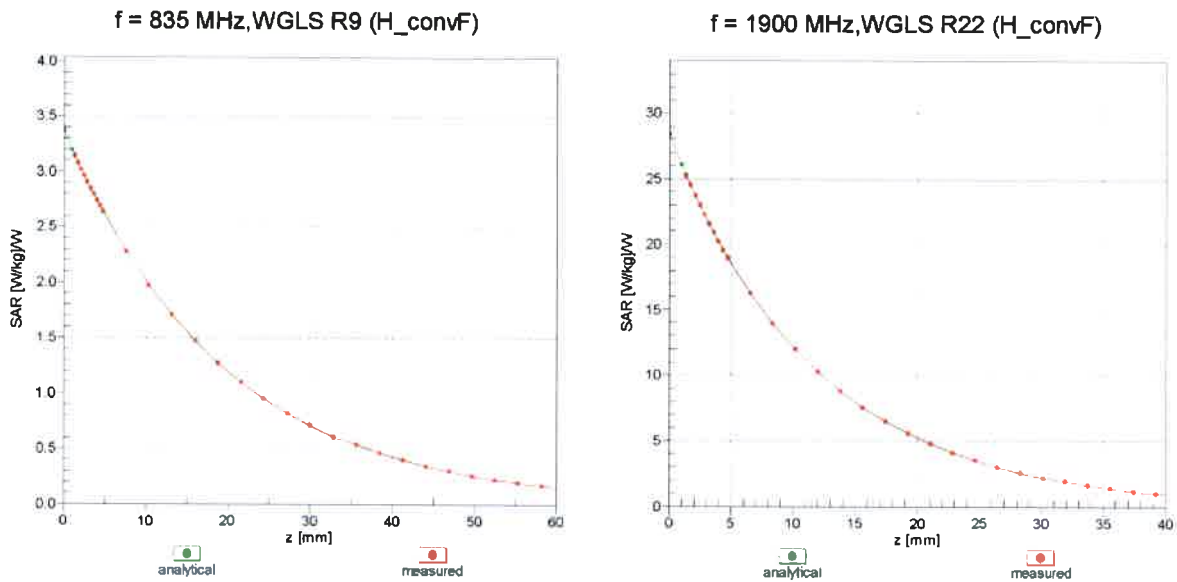

Deviation from Isotropy in Liquid Error (ϕ, θ), f = 900 MHz

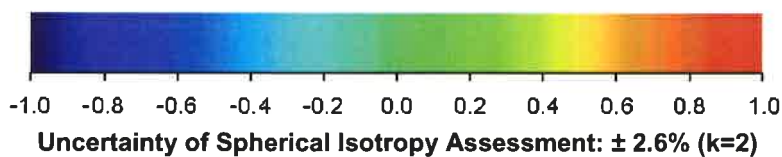
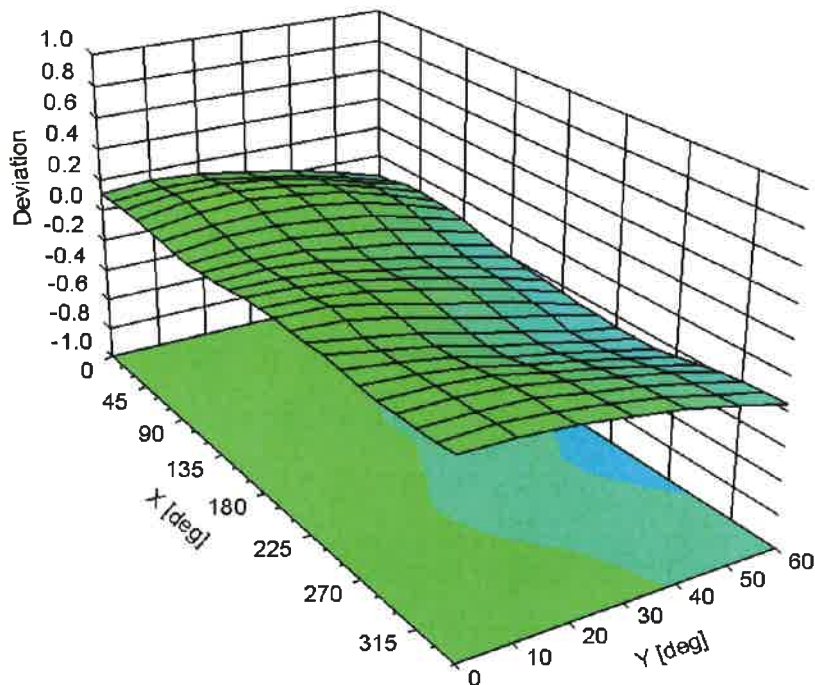

DASY/EASY - Parameters of Probe: EX3DV4 - SN:3590

Other Probe Parameters

Sensor Arrangement	Triangular
Connector Angle (°)	38.4
Mechanical Surface Detection Mode	enabled
Optical Surface Detection Mode	disabled
Probe Overall Length	337 mm
Probe Body Diameter	10 mm
Tip Length	9 mm
Tip Diameter	2.5 mm
Probe Tip to Sensor X Calibration Point	1 mm
Probe Tip to Sensor Y Calibration Point	1 mm
Probe Tip to Sensor Z Calibration Point	1 mm
Recommended Measurement Distance from Surface	2 mm



Accredited by the Swiss Accreditation Service (SAS)
The Swiss Accreditation Service is one of the signatories to the EA
Multilateral Agreement for the recognition of calibration certificates

Accreditation No.: **SCS 108**

Client **B.V. ADT (Auden)**

Certificate No: **EX3-3650_Apr13**

CALIBRATION CERTIFICATE

Object **EX3DV4 - SN:3650**

Calibration procedure(s) **QA CAL-01.v8, QA CAL-14.v3, QA CAL-23.v4, QA CAL-25.v4
Calibration procedure for dosimetric E-field probes**

Calibration date: **April 30, 2013**

This calibration certificate documents the traceability to national standards, which realize the physical units of measurements (SI).
The measurements and the uncertainties with confidence probability are given on the following pages and are part of the certificate.

All calibrations have been conducted in the closed laboratory facility: environment temperature (22 ± 3)°C and humidity < 70%.

Calibration Equipment used (M&TE critical for calibration)

Primary Standards	ID	Cal Date (Certificate No.)	Scheduled Calibration
Power meter E4419B	GB41293874	04-Apr-13 (No. 217-01733)	Apr-14
Power sensor E4412A	MY41498087	04-Apr-13 (No. 217-01733)	Apr-14
Reference 3 dB Attenuator	SN: S5054 (3c)	04-Apr-13 (No. 217-01737)	Apr-14
Reference 20 dB Attenuator	SN: S5277 (20x)	04-Apr-13 (No. 217-01735)	Apr-14
Reference 30 dB Attenuator	SN: S5129 (30b)	04-Apr-13 (No. 217-01738)	Apr-14
Reference Probe ES3DV2	SN: 3013	28-Dec-12 (No. ES3-3013_Dec12)	Dec-13
DAE4	SN: 660	31-Jan-13 (No. DAE4-660_Jan13)	Jan-14
Secondary Standards	ID	Check Date (in house)	Scheduled Check
RF generator HP 8648C	US3642U01700	4-Aug-99 (in house check Apr-13)	In house check: Apr-15
Network Analyzer HP 8753E	US37390585	18-Oct-01 (in house check Oct-12)	In house check: Oct-13

Calibrated by:	Name Israe El-Naouq	Function Laboratory Technician	Signature
Approved by:	Name Katja Pokovic	Function Technical Manager	

Issued: May 1, 2013

This calibration certificate shall not be reproduced except in full without written approval of the laboratory.



Accredited by the Swiss Accreditation Service (SAS)

Accreditation No.: **SCS 108**

The Swiss Accreditation Service is one of the signatories to the EA Multilateral Agreement for the recognition of calibration certificates

Glossary:

TSL	tissue simulating liquid
NORM _{x,y,z}	sensitivity in free space
ConvF	sensitivity in TSL / NORM _{x,y,z}
DCP	diode compression point
CF	crest factor (1/duty_cycle) of the RF signal
A, B, C, D	modulation dependent linearization parameters
Polarization φ	φ rotation around probe axis
Polarization ϑ	ϑ rotation around an axis that is in the plane normal to probe axis (at measurement center), i.e., $\vartheta = 0$ is normal to probe axis

Calibration is Performed According to the Following Standards:

- IEEE Std 1528-2003, "IEEE Recommended Practice for Determining the Peak Spatial-Averaged Specific Absorption Rate (SAR) in the Human Head from Wireless Communications Devices: Measurement Techniques", December 2003
- IEC 62209-1, "Procedure to measure the Specific Absorption Rate (SAR) for hand-held devices used in close proximity to the ear (frequency range of 300 MHz to 3 GHz)", February 2005

Methods Applied and Interpretation of Parameters:

- NORM_{x,y,z}**: Assessed for E-field polarization $\vartheta = 0$ ($f \leq 900$ MHz in TEM-cell; $f > 1800$ MHz: R22 waveguide). NORM_{x,y,z} are only intermediate values, i.e., the uncertainties of NORM_{x,y,z} does not affect the E²-field uncertainty inside TSL (see below ConvF).
- NORM(f)_{x,y,z}** = NORM_{x,y,z} * frequency_response (see Frequency Response Chart). This linearization is implemented in DASY4 software versions later than 4.2. The uncertainty of the frequency response is included in the stated uncertainty of ConvF.
- DCP_{x,y,z}**: DCP are numerical linearization parameters assessed based on the data of power sweep with CW signal (no uncertainty required). DCP does not depend on frequency nor media.
- PAR**: PAR is the Peak to Average Ratio that is not calibrated but determined based on the signal characteristics
- A_{x,y,z}; B_{x,y,z}; C_{x,y,z}; D_{x,y,z}; VR_{x,y,z}**: A, B, C, D are numerical linearization parameters assessed based on the data of power sweep for specific modulation signal. The parameters do not depend on frequency nor media. VR is the maximum calibration range expressed in RMS voltage across the diode.
- ConvF and Boundary Effect Parameters**: Assessed in flat phantom using E-field (or Temperature Transfer Standard for $f \leq 800$ MHz) and inside waveguide using analytical field distributions based on power measurements for $f > 800$ MHz. The same setups are used for assessment of the parameters applied for boundary compensation (alpha, depth) of which typical uncertainty values are given. These parameters are used in DASY4 software to improve probe accuracy close to the boundary. The sensitivity in TSL corresponds to NORM_{x,y,z} * ConvF whereby the uncertainty corresponds to that given for ConvF. A frequency dependent ConvF is used in DASY version 4.4 and higher which allows extending the validity from ± 50 MHz to ± 100 MHz.
- Spherical isotropy (3D deviation from isotropy)**: in a field of low gradients realized using a flat phantom exposed by a patch antenna.
- Sensor Offset**: The sensor offset corresponds to the offset of virtual measurement center from the probe tip (on probe axis). No tolerance required.

Probe EX3DV4

SN:3650

Manufactured:	March 18, 2008
Repaired:	April 22, 2013
Calibrated:	April 30, 2013

Calibrated for DASY/EASY Systems
(Note: non-compatible with DASY2 system!)

DASY/EASY - Parameters of Probe: EX3DV4 - SN:3650

Basic Calibration Parameters

	Sensor X	Sensor Y	Sensor Z	Unc (k=2)
Norm ($\mu\text{V}/(\text{V}/\text{m})^2$) ^A	0.39	0.37	0.40	± 10.1 %
DCP (mV) ^B	99.0	98.4	98.6	

Modulation Calibration Parameters

UID	Communication System Name		A dB	B dB $\sqrt{\mu\text{V}}$	C	D dB	VR mV	Unc ^E (k=2)
0	CW	X	0.0	0.0	1.0	0.00	103.4	±3.5 %
		Y	0.0	0.0	1.0		132.3	
		Z	0.0	0.0	1.0		108.8	

The reported uncertainty of measurement is stated as the standard uncertainty of measurement multiplied by the coverage factor k=2, which for a normal distribution corresponds to a coverage probability of approximately 95%.

^A The uncertainties of NormX,Y,Z do not affect the E²-field uncertainty inside TSL (see Pages 5 and 6).

^B Numerical linearization parameter: uncertainty not required.

^E Uncertainty is determined using the max. deviation from linear response applying rectangular distribution and is expressed for the square of the field value.

DASY/EASY - Parameters of Probe: EX3DV4 - SN:3650

Calibration Parameter Determined in Head Tissue Simulating Media

f (MHz) ^C	Relative Permittivity ^F	Conductivity (S/m) ^F	ConvF X	ConvF Y	ConvF Z	Alpha	Depth (mm)	Unct. (k=2)
750	41.9	0.89	9.69	9.69	9.69	0.41	0.87	± 12.0 %
835	41.5	0.90	9.37	9.37	9.37	0.66	0.67	± 12.0 %
900	41.5	0.97	9.22	9.22	9.22	0.46	0.72	± 12.0 %
1450	40.5	1.20	8.04	8.04	8.04	0.31	1.01	± 12.0 %
1640	40.3	1.29	8.07	8.07	8.07	0.40	0.80	± 12.0 %
1750	40.1	1.37	7.91	7.91	7.91	0.80	0.50	± 12.0 %
1900	40.0	1.40	7.73	7.73	7.73	0.35	0.88	± 12.0 %
2000	40.0	1.40	7.59	7.59	7.59	0.80	0.57	± 12.0 %
2300	39.5	1.67	7.34	7.34	7.34	0.67	0.62	± 12.0 %
2450	39.2	1.80	6.99	6.99	6.99	0.47	0.74	± 12.0 %
2600	39.0	1.96	6.85	6.85	6.85	0.48	0.78	± 12.0 %
3500	37.9	2.91	6.96	6.96	6.96	0.85	0.62	± 13.1 %
5200	36.0	4.66	5.20	5.20	5.20	0.35	1.80	± 13.1 %
5300	35.9	4.76	5.07	5.07	5.07	0.30	1.80	± 13.1 %
5600	35.5	5.07	4.57	4.57	4.57	0.40	1.80	± 13.1 %
5800	35.3	5.27	4.56	4.56	4.56	0.45	1.80	± 13.1 %

^C Frequency validity of ± 100 MHz only applies for DASY v4.4 and higher (see Page 2), else it is restricted to ± 50 MHz. The uncertainty is the RSS of the ConvF uncertainty at calibration frequency and the uncertainty for the indicated frequency band.

^F At frequencies below 3 GHz, the validity of tissue parameters (ϵ and σ) can be relaxed to ± 10% if liquid compensation formula is applied to measured SAR values. At frequencies above 3 GHz, the validity of tissue parameters (ϵ and σ) is restricted to ± 5%. The uncertainty is the RSS of the ConvF uncertainty for indicated target tissue parameters.

DASY/EASY - Parameters of Probe: EX3DV4 - SN:3650

Calibration Parameter Determined in Body Tissue Simulating Media

f (MHz) ^C	Relative Permittivity ^F	Conductivity (S/m) ^F	ConvF X	ConvF Y	ConvF Z	Alpha	Depth (mm)	Unct. (k=2)
750	55.5	0.96	9.51	9.51	9.51	0.73	0.64	± 12.0 %
835	55.2	0.97	9.35	9.35	9.35	0.80	0.50	± 12.0 %
900	55.0	1.05	9.23	9.23	9.23	0.78	0.62	± 12.0 %
1450	54.0	1.30	8.40	8.40	8.40	0.80	0.50	± 12.0 %
1640	53.8	1.40	8.36	8.36	8.36	0.80	0.62	± 12.0 %
1750	53.4	1.49	7.57	7.57	7.57	0.74	0.66	± 12.0 %
1900	53.3	1.52	7.39	7.39	7.39	0.40	0.86	± 12.0 %
2000	53.3	1.52	7.57	7.57	7.57	0.51	0.77	± 12.0 %
2300	52.9	1.81	6.73	6.73	6.73	0.51	0.73	± 12.0 %
2450	52.7	1.95	7.09	7.09	7.09	0.80	0.50	± 12.0 %
2600	52.5	2.16	6.91	6.91	6.91	0.80	0.50	± 12.0 %
3500	51.3	3.31	6.58	6.58	6.58	0.38	1.16	± 13.1 %
5200	49.0	5.30	4.51	4.51	4.51	0.45	1.90	± 13.1 %
5300	48.9	5.42	4.31	4.31	4.31	0.45	1.90	± 13.1 %
5600	48.5	5.77	4.00	4.00	4.00	0.45	1.90	± 13.1 %
5800	48.2	6.00	4.21	4.21	4.21	0.55	1.90	± 13.1 %

^C Frequency validity of ± 100 MHz only applies for DASY v4.4 and higher (see Page 2), else it is restricted to ± 50 MHz. The uncertainty is the RSS of the ConvF uncertainty at calibration frequency and the uncertainty for the indicated frequency band.

^F At frequencies below 3 GHz, the validity of tissue parameters (ϵ and σ) can be relaxed to ± 10% if liquid compensation formula is applied to measured SAR values. At frequencies above 3 GHz, the validity of tissue parameters (ϵ and σ) is restricted to ± 5%. The uncertainty is the RSS of the ConvF uncertainty for indicated target tissue parameters.

Frequency Response of E-Field (TEM-Cell:ifi110 EXX, Waveguide: R22)

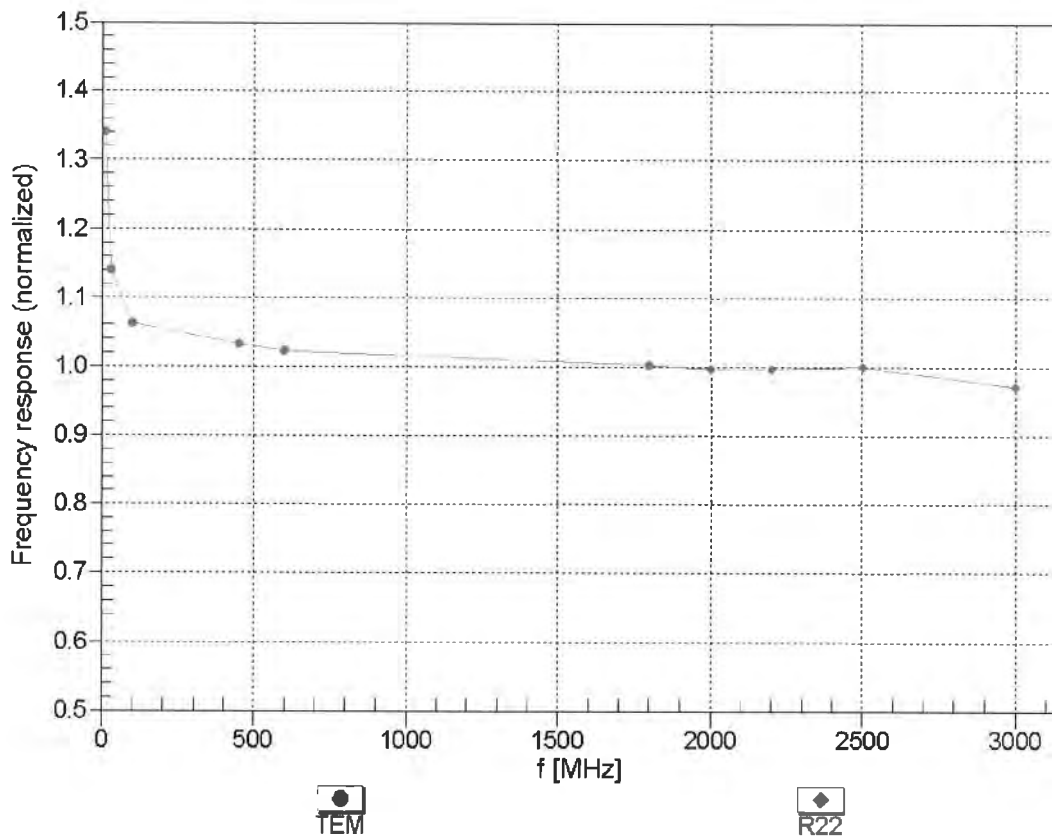

Uncertainty of Frequency Response of E-field: $\pm 6.3\%$ (k=2)

Receiving Pattern (ϕ), $\theta = 0^\circ$

f=600 MHz,TEM

f=1800 MHz,R22

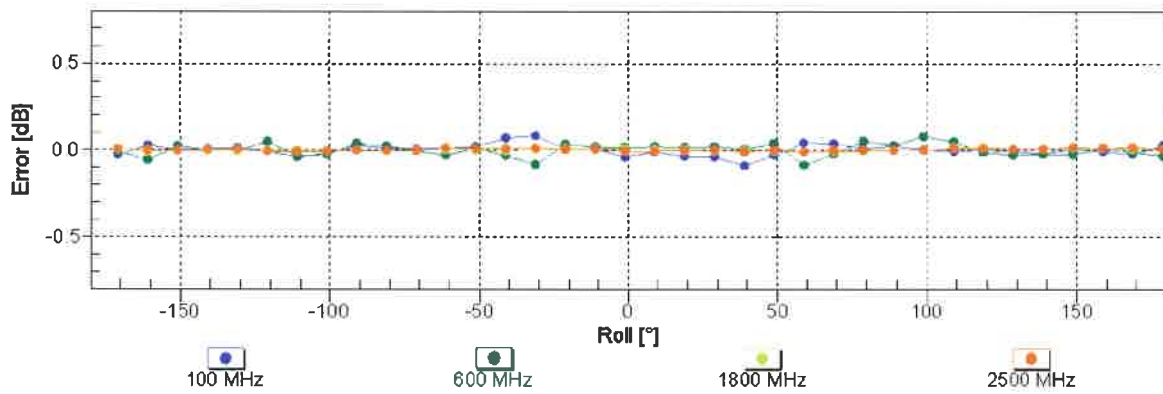
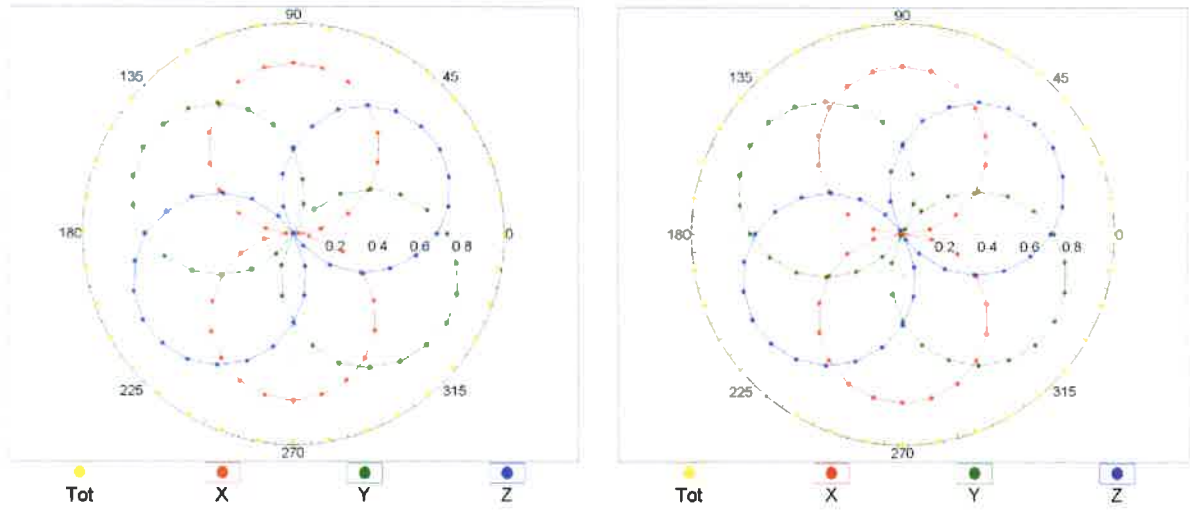

Uncertainty of Axial Isotropy Assessment: $\pm 0.5\%$ (k=2)

Dynamic Range f(SAR_{head}) (TEM cell , f = 900 MHz)

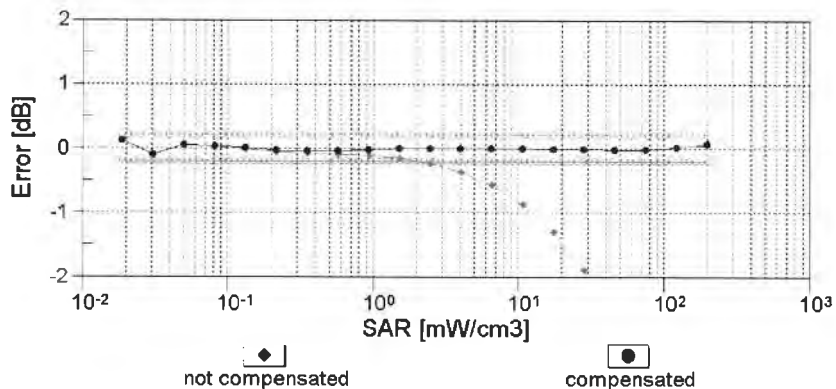
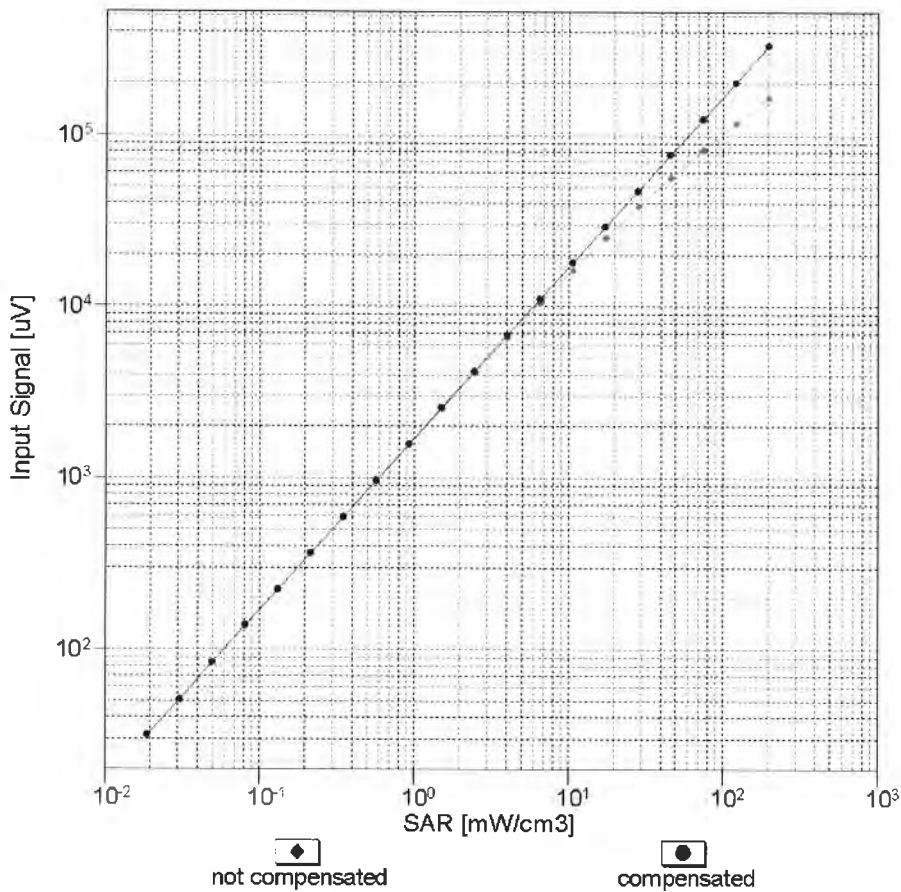

Uncertainty of Linearity Assessment: ± 0.6% (k=2)

Conversion Factor Assessment

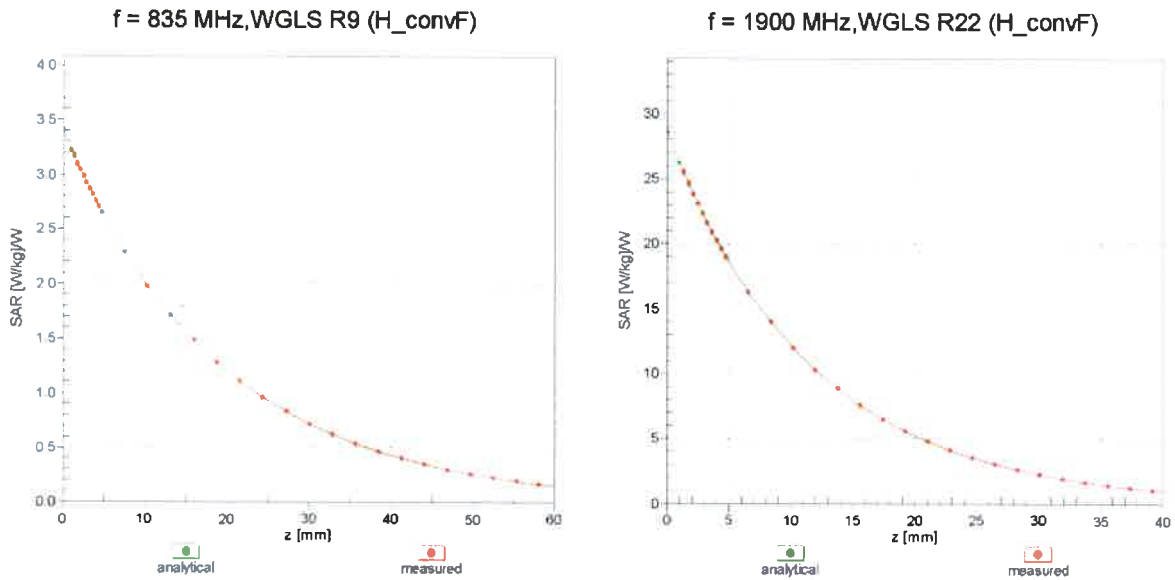

Deviation from Isotropy in Liquid Error (ϕ, ϑ), f = 900 MHz

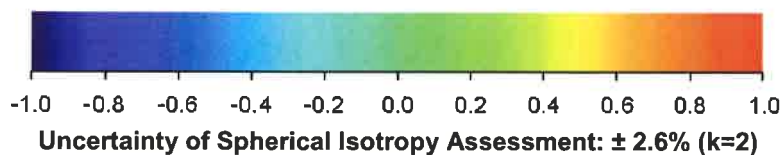
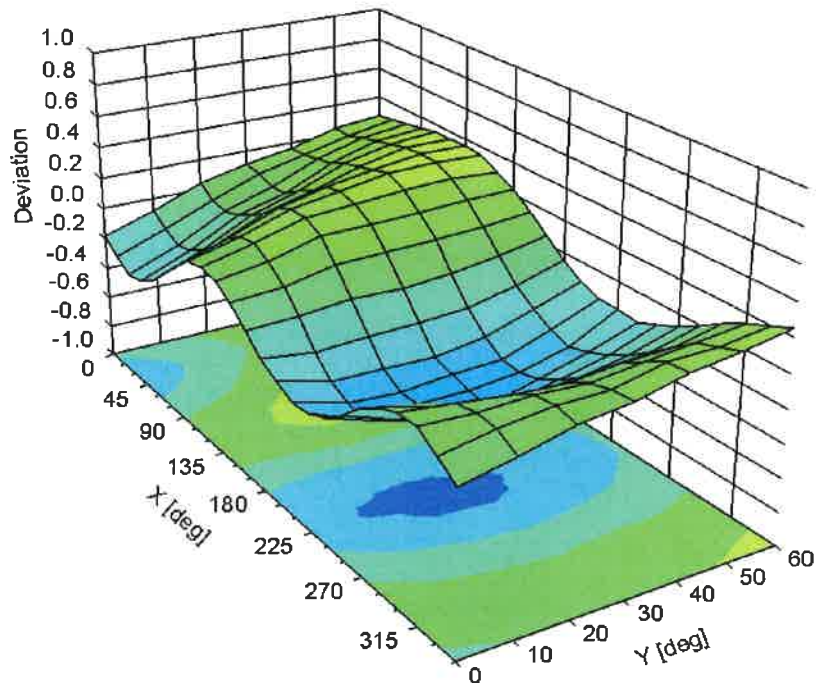

DASY/EASY - Parameters of Probe: EX3DV4 - SN:3650

Other Probe Parameters

Sensor Arrangement	Triangular
Connector Angle (°)	-21.1
Mechanical Surface Detection Mode	enabled
Optical Surface Detection Mode	disabled
Probe Overall Length	337 mm
Probe Body Diameter	10 mm
Tip Length	9 mm
Tip Diameter	2.5 mm
Probe Tip to Sensor X Calibration Point	1 mm
Probe Tip to Sensor Y Calibration Point	1 mm
Probe Tip to Sensor Z Calibration Point	1 mm
Recommended Measurement Distance from Surface	2 mm