



A D T

# FCC TEST REPORT (PART 24)

**REPORT NO.:** RF131119C06-1  
**MODEL NO.:** C6725  
**FCC ID:** V65C6725  
**RECEIVED:** Nov. 19, 2013  
**TESTED:** Nov. 29, 2013 ~ Dec. 18, 2013  
**ISSUED:** Feb. 14, 2014

**APPLICANT:** Kyocera Communications, Inc. c/o Kyocera Corporation

**ADDRESS:** 8611 Balboa Ave. San Diego, CA 92123

**ISSUED BY:** Bureau Veritas Consumer Products Services  
(H.K.) Ltd., Taoyuan Branch

**LAB ADDRESS:** No. 47, 14th Ling, Chia Pau Vil., Lin Kou Dist., New  
Taipei City, Taiwan ( R.O.C. )

**TEST LOCATION:** No. 19, Hwa Ya 2nd Rd, Wen Hwa Tsuen, Kwei  
Shan Hsiang, Taoyuan Hsien 333, Taiwan, R.O.C.

This report should not be used by the client to claim  
product certification, approval, or endorsement by TAF or  
any government agencies.



This report is for your exclusive use. Any copying or replication of this report to or for any other person or entity, or use of our name or trademark, is permitted only with our prior written permission. This report sets forth our findings solely with respect to the test samples identified herein. The results set forth in this report are not indicative or representative of the quality or characteristics of the lot from which a test sample was taken or any similar or identical product unless specifically and expressly noted. Our report includes all of the tests requested by you and the results thereof based upon the information that you provided to us. You have 60 days from date of issuance of this report to notify us of any material error or omission caused by our negligence, provided, however, that such notice shall be in writing and shall specifically address the issue you wish to raise. A failure to raise such issue within the prescribed time shall constitute your unqualified acceptance of the completeness of this report, the tests conducted and the correctness of the report contents. Unless specific mention, the uncertainty of measurement has been explicitly taken into account to declare the compliance or non-compliance to the specification

## TABLE OF CONTENTS

RELEASE CONTROL RECORD .....	3
1 CERTIFICATION .....	4
2 SUMMARY OF TEST RESULTS.....	5
2.1 MEASUREMENT UNCERTAINTY .....	5
2.2 TEST SITE AND INSTRUMENTS .....	6
3 GENERAL INFORMATION .....	7
3.1 GENERAL DESCRIPTION OF EUT.....	7
3.2 CONFIGURATION OF SYSTEM UNDER TEST .....	8
3.3 DESCRIPTION OF SUPPORT UNITS.....	8
3.4 TEST ITEM AND TEST CONFIGURATION .....	9
3.5 EUT OPERATING CONDITIONS.....	11
3.6 GENERAL DESCRIPTION OF APPLIED STANDARDS .....	11
4 TEST TYPES AND RESULTS.....	12
4.1 OUTPUT POWER MEASUREMENT .....	12
4.1.1 LIMITS OF OUTPUT POWER MEASUREMENT .....	12
4.1.2 TEST PROCEDURES .....	12
4.1.3 TEST SETUP .....	13
4.1.4 TEST RESULTS .....	14
4.2 FREQUENCY STABILITY MEASUREMENT .....	19
4.2.1 LIMITS OF FREQUENCY STABILITY MEASUREMENT .....	19
4.2.2 TEST PROCEDURE .....	19
4.2.3 TEST SETUP .....	19
4.2.4 TEST RESULTS .....	20
4.3 OCCUPIED BANDWIDTH MEASUREMENT.....	21
4.3.1 TEST PROCEDURES.....	21
4.3.2 TEST SETUP .....	21
4.3.3 TEST RESULTS .....	22
4.4 PEAK TO AVERAGE RATIO.....	25
4.4.1 LIMITS OF PEAK TO AVERAGE RATIO MEASUREMENT .....	25
4.4.2 TEST SETUP .....	25
4.4.3 TEST PROCEDURES.....	25
4.4.4 TEST RESULTS .....	26
4.5 BAND EDGE MEASUREMENT .....	29
4.5.1 LIMITS OF BAND EDGE MEASUREMENT .....	29
4.5.2 TEST SETUP .....	29
4.5.3 TEST PROCEDURES.....	29
4.5.4 TEST RESULTS .....	30
4.6 CONDUCTED SPURIOUS EMISSIONS.....	33
4.6.1 LIMITS OF CONDUCTED SPURIOUS EMISSIONS MEASUREMENT.....	33
4.6.2 TEST PROCEDURE .....	33
4.6.3 TEST SETUP .....	33
4.6.4 TEST RESULTS .....	34
4.7 RADIATED EMISSION MEASUREMENT .....	35
4.7.1 LIMITS OF RADIATED EMISSION MEASUREMENT .....	35
4.7.2 TEST PROCEDURES.....	35
4.7.3 DEVIATION FROM TEST STANDARD.....	35
4.7.4 TEST SETUP .....	36
4.7.5 TEST RESULTS .....	37
5 PHOTOGRAPHS OF THE TEST CONFIGURATION .....	45
6 INFORMATION ON THE TESTING LABORATORIES .....	46
7 APPENDIX A – MODIFICATIONS RECORDERS FOR ENGINEERING CHANGES TO THE EUT BY THE LAB.....	47



A D T

## RELEASE CONTROL RECORD

ISSUE NO.	REASON FOR CHANGE	DATE ISSUED
RF131119C06-1	Original release	Feb. 14, 2014



# 1 CERTIFICATION

**PRODUCT:** Kyocera phone

**MODEL:** C6725

**BRAND:** Kyocera

**APPLICANT:** Kyocera Communications, Inc. c/o Kyocera Corporation

**TESTED:** Nov. 29, 2013 ~ Dec. 18, 2013

**TEST SAMPLE:** Identical Prototype

**STANDARDS:** **FCC Part 24, Subpart E**

The above equipment (model: C6725) has been tested by **Bureau Veritas Consumer Products Services (H.K.) Ltd., Taoyuan Branch**, and found compliance with the requirement of the above standards. The test record, data evaluation & Equipment Under Test (EUT) configurations represented herein are true and accurate accounts of the measurements of the sample's EMC characteristics under the conditions specified in this report.

**PREPARED BY** :  Vera Huang  , **DATE** :  Feb. 14, 2014

Vera Huang / Specialist

**APPROVED BY** :  Sam chen  , **DATE** :  Feb. 14, 2014

Sam Chen / Senior Project Engineer

## 2 SUMMARY OF TEST RESULTS

The EUT has been tested according to the following specifications:

APPLIED STANDARD: FCC Part 24 & Part 2			
STANDARD SECTION	TEST TYPE	RESULT	REMARK
2.1046 24.232	Equivalent isotropically radiated power	PASS	Meet the requirement of limit.
2.1055 24.235	Frequency Stability	PASS	Meet the requirement of limit.
2.1049 24.238(b)	Occupied Bandwidth	PASS	Meet the requirement of limit.
24.232(d)	Peak to average ratio	PASS	Meet the requirement of limit.
24.238(b)	Band Edge Measurements	PASS	Meet the requirement of limit.
2.1051 24.238	Conducted Spurious Emissions	PASS	Meet the requirement of limit.
2.1053 24.238	Radiated Spurious Emissions	PASS	Meet the requirement of limit. Minimum passing margin is -26.66dB at 5643.60MHz.

### 2.1 MEASUREMENT UNCERTAINTY

Where relevant, the following measurement uncertainty levels have been estimated for tests performed on the EUT as specified in CISPR 16-4-2:

MEASUREMENT	FREQUENCY	UNCERTAINTY
Conducted emissions	150kHz~30MHz	2.44 dB
Radiated emissions	30MHz ~ 200MHz	2.93 dB
	200MHz ~1000MHz	2.95 dB
	1GHz ~ 18GHz	2.26 dB
	18GHz ~ 40GHz	1.94 dB

This uncertainty represents an expanded uncertainty expressed at approximately the 95% confidence level using a coverage factor of k=2.



## 2.2 TEST SITE AND INSTRUMENTS

DESCRIPTION & MANUFACTURER	MODEL NO.	SERIAL NO.	DATE OF CALIBRATION	DUE DATE OF CALIBRATION
Test Receiver ROHDE & SCHWARZ	ESCI	100744	Apr. 15, 2013	Apr. 14, 2014
Spectrum Analyzer Agilent	E4446A	MY51100039	Jul. 31, 2013	Jul. 30, 2014
BILOG Antenna SCHWARZBECK	VULB9168	9168-472	Mar. 25, 2013	Mar. 24, 2014
HORN Antenna SCHWARZBECK	BBHA 9120 D	9120D-969	Jan. 07, 2013	Jan. 06, 2014
HORN Antenna SCHWARZBECK	BBHA 9170	9170-480	Dec. 25, 2012	Dec. 24, 2013
Loop Antenna	HFH2-Z2	100070	Jan. 31, 2012	Jan. 30, 2014
Preamplifier EMCI	EMC 330H	980112	Dec. 28, 2012	Dec. 27, 2013
RF signal cable HUBER+SUHNNER	SUCOFLEX 104	309219/4 2950114	Oct. 18, 2013	Oct. 17, 2014
RF signal cable HUBER+SUHNNER	SUCOFLEX 104	250130/4	Oct. 18, 2013	Oct. 17, 2014
RF signal cable Worken	RG-213	NA	Nov. 07, 2013	Nov. 06, 2014
Software BV ADT	E3 6.120103	NA	NA	NA
Antenna Tower MF	MFA-440H	NA	NA	NA
Turn Table MF	MFT-201SS	NA	NA	NA
Antenna Tower & Turn Table Controller MF	MF-7802	NA	NA	NA
Mini-Circuits Power Splitter	ZN2PD-9G	NA	Jul. 18, 2013	Jul. 17, 2014
JFW 20dB attenuation	50HF-020-SMA	NA	NA	NA
Communications Tester-Wireless	E5515C	MY52102544	Sep. 05, 2012	Sep. 04, 2014
Radio Communication Analyzer	MT8820C	6201300640	Aug. 01, 2013	Jul. 31, 2014

**NOTE:** 1. The calibration interval of the above test instruments is 12 months and the calibrations are traceable to NML/ROC and NIST/USA.

2. The test was performed in HwaYa Chamber 10.
3. The horn antenna and HP preamplifier (model: 8449B) are used only for the measurement of emission frequency above 1GHz if tested.
4. The FCC Site Registration No. is 690701.
5. The IC Site Registration No. is IC 7450F-10.



A D T

### 3 GENERAL INFORMATION

#### 3.1 GENERAL DESCRIPTION OF EUT

<b>EUT</b>	Kyocera phone	
<b>MODEL NO.</b>	C6725	
<b>POWER SUPPLY</b>	5.0Vdc (adapter or host equipment) 3.8Vdc (battery)	
<b>MODULATION TYPE</b>	<b>CDMA</b>	QPSK, OQPSK, HPSK
	<b>LTE Band 25</b>	QPSK, 16QAM
<b>FREQUENCY RANGE</b>	<b>CDMA</b>	1851.25MHz ~ 1908.75MHz
	<b>LTE Band 25 (Channel Bandwidth: 3MHz)</b>	1851.5MHz ~ 1913.5MHz
	<b>LTE Band 25 (Channel Bandwidth: 5MHz)</b>	1852.5MHz ~ 1912.5MHz
	<b>LTE Band 25 (Channel Bandwidth: 10MHz)</b>	1855MHz ~ 1910MHz
<b>MAX. EIRP POWER</b>	<b>CDMA</b>	192.04mW
	<b>LTE Band 25 (Channel Bandwidth: 3MHz)</b>	144.21mW
	<b>LTE Band 25 (Channel Bandwidth: 5MHz)</b>	136.14mW
	<b>LTE Band 25 (Channel Bandwidth: 10MHz)</b>	150.66mW
<b>EMISSION DESIGNATOR</b>	<b>CDMA</b>	1M27F9W
	<b>LTE Band 25 (Channel Bandwidth: 3MHz)</b>	2M68W7D
	<b>LTE Band 25 (Channel Bandwidth: 5MHz)</b>	4M49G7D
	<b>LTE Band 25 (Channel Bandwidth: 10MHz)</b>	8M92G7D
<b>ANTENNA TYPE</b>	<b>CDMA:</b> Fixed Internal Antenna with -1.5dBi gain <b>LTE Band 25:</b> Fixed Internal Antenna with -1.5dBi gain	
<b>I/O PORTS</b>	Refer to users' manual	
<b>DATA CABLE</b>	Refer to NOTE as below	
<b>ACCESSORY DEVICES</b>	Refer to NOTE as below	

**NOTE:**

1. The EUT has following accessories.

ITEM	BRAND	MODEL	DESCRIPTION
AC Adapter	Kyocera	SCP-42ADT	I/P: 100-240Vac, 50/60Hz, 200mA O/P: 5Vdc, 1000mA
Li-ion Battery	Kyocera	SCP-59LBPS	Rating: 3.8Vdc, 2000mAh
USB cable	Kyocera	SCP-11SDC	1.2m non-shielded cable w/o ferrite core

2. The above EUT information is declared by the manufacturer and for more detailed features description, please refer to the manufacturer's specifications or User's Manual.

### 3.2 CONFIGURATION OF SYSTEM UNDER TEST

#### FOR RADIATION EMISSION TEST

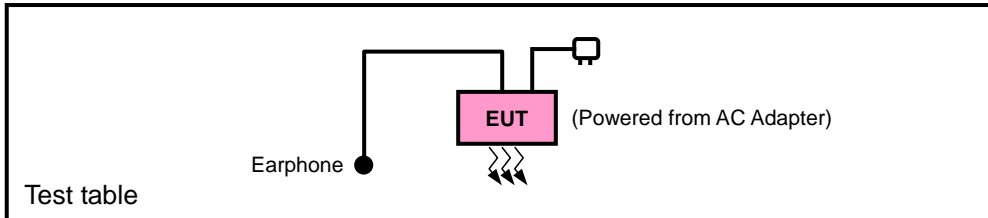

#### FOR E.I.R.P. TEST

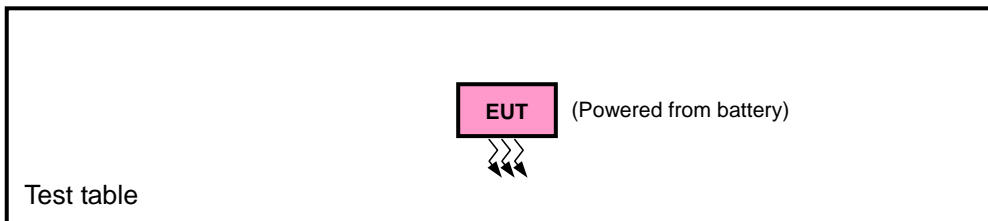

### 3.3 DESCRIPTION OF SUPPORT UNITS

The EUT has been tested as an independent unit together with other necessary accessories or support units. The following support units or accessories were used to form a representative test configuration during the tests.

NO.	PRODUCT	BRAND	MODEL NO.	SERIAL NO.	FCC ID
1	EARPHONE	GALIEN	HF-HB04D	N/A	N/A

NO.	SIGNAL CABLE DESCRIPTION OF THE ABOVE SUPPORT UNITS
1	N/A

**NOTE:**

1. All power cords of the above support units are non-shielded (1.8m).
2. Item 1 was provided by client.





### 3.4 TEST ITEM AND TEST CONFIGURATION

Pre-Scan has been conducted to determine the worst-case mode from all possible combinations between available modulations, data rates, XYZ axis and antenna ports. The worst case was found when positioned on Y-plane for CDMA and X-plane for LTE for EIRP, and X-axis for CDMA and Z-axis for LTE for radiated emission. Following channel(s) was (were) selected for the final test as listed below:

#### CDMA MODE

EUT CONFIGURE MODE	TEST ITEM	AVAILABLE CHANNEL	TESTED CHANNEL	MODE
-	EIRP	25 to 1175	25, 600, 1175	1xRTT
-	FREQUENCY STABILITY	25 to 1175	600	1xRTT
-	OCCUPIED BANDWIDTH	25 to 1175	25, 600, 1175	1xRTT
-	PEAK TO AVERAGE RATIO	25 to 1175	25, 600, 1175	1xRTT
-	BAND EDGE	25 to 1175	25, 1175	1xRTT
-	CONDCUDED EMISSION	25 to 1175	600	1xRTT
-	RADIATED EMISSION	25 to 1175	600	1xRTT



**LTE BAND 25 MODE**

EUT CONFIGURE MODE	TEST ITEM	AVAILABLE CHANNEL	TESTED CHANNEL	CHANNEL BANDWIDTH	MODULATION	MODE		
-	EIRP	26055 to 26675	26055, 26365, 26675	3MHz	QPSK / 16QAM	1 RB / 0 RB Offset		
		26065 to 26665	26065, 26365, 26665	5MHz	QPSK / 16QAM	1 RB / 0 RB Offset		
		26090 to 26640	26090, 26365, 26640	10MHz	QPSK / 16QAM	1 RB / 0 RB Offset		
-	FREQUENCY STABILITY	26055 to 26675	26365	3MHz	QPSK	1 RB / 0 RB Offset		
		26065 to 26665	26365	5MHz	QPSK	1 RB / 0 RB Offset		
		26090 to 26640	26365	10MHz	QPSK	1 RB / 0 RB Offset		
-	OCCUPIED BANDWIDTH	26055 to 26675	26055, 26365, 26675	3MHz	QPSK / 16QAM	15 RB / 0 RB Offset		
		26065 to 26665	26065, 26365, 26665	5MHz	QPSK / 16QAM	25 RB / 0 RB Offset		
		26090 to 26640	26090, 26365, 26640	10MHz	QPSK / 16QAM	50 RB / 0 RB Offset		
-	PEAK TO AVERAGE RATIO	26055 to 26675	26055, 26365, 26675	3MHz	QPSK / 16QAM	1 RB / 7 RB Offset		
		26065 to 26665	26065, 26365, 26665	5MHz	QPSK / 16QAM	1 RB / 12 RB Offset		
		26090 to 26640	26090, 26365, 26640	10MHz	QPSK / 16QAM	1 RB / 24 RB Offset		
-	BAND EDGE	26055 to 26675	26055	3MHz	QPSK	1 RB / 0 RB Offset 15 RB / 0 RB Offset		
			26675	3MHz	QPSK	1 RB / 14 RB Offset 15 RB / 0 RB Offset		
		26065 to 26665	26065	5MHz	QPSK	1 RB / 0 RB Offset 25 RB / 0 RB Offset		
			26665	5MHz	QPSK	1 RB / 24 RB Offset 25 RB / 0 RB Offset		
		26090 to 26640	26090	10MHz	QPSK	1 RB / 0 RB Offset 50 RB / 0 RB Offset		
			26640	10MHz	QPSK	1 RB / 49 RB Offset 50 RB / 0 RB Offset		
		-	CONDCUDED EMISSION	26055 to 26675	26365	3MHz	QPSK	1 RB / 7 RB Offset
				26065 to 26665	26365	5MHz	QPSK	1 RB / 12 RB Offset
26090 to 26640	26365			10MHz	QPSK	1 RB / 24 RB Offset		
-	RADIATED EMISSION	26055 to 26675	26365	3MHz	QPSK	1 RB / 0 RB Offset		
		26065 to 26665	26365	5MHz	QPSK	1 RB / 0 RB Offset		
		26090 to 26640	26365	10MHz	QPSK	1 RB / 0 RB Offset		

**Note:** This device was tested under all bandwidths, RB configurations and modulations. The worst case was found in QPSK modulation.



**TEST CONDITION:**

TEST ITEM	ENVIRONMENTAL CONDITIONS	INPUT POWER	TESTED BY
EIRP	26deg. C, 58%RH	3.8Vdc	Howard Kao
FREQUENCY STABILITY	26deg. C, 58%RH	3.8Vdc	Howard Kao
OCCUPIED BANDWIDTH	26deg. C, 58%RH	3.8Vdc	Howard Kao
BAND EDGE	26deg. C, 58%RH	3.8Vdc	Howard Kao
CONDCUDED EMISSION	26deg. C, 58%RH	3.8Vdc	Howard Kao
RADIATED EMISSION	25deg. C, 65%RH	120Vac, 60Hz	Johnson Liao

**3.5 EUT OPERATING CONDITIONS**

The EUT makes a call to the communication simulator. The communication simulator station system controlled a EUT to export maximum output power under transmission mode and specific channel frequency

**3.6 GENERAL DESCRIPTION OF APPLIED STANDARDS**

The EUT is a RF product. According to the specifications of the manufacturer, it must comply with the requirements of the following standards:

**FCC 47 CFR Part 2**

**FCC 47 CFR Part 24**

**ANSI/TIA/EIA-603-C 2004**

**NOTE:** All test items have been performed and recorded as per the above standards.

## 4 TEST TYPES AND RESULTS

### 4.1 OUTPUT POWER MEASUREMENT

#### 4.1.1 LIMITS OF OUTPUT POWER MEASUREMENT

Mobile and portable stations are limited to 2 watts EIRP

#### 4.1.2 TEST PROCEDURES

##### **EIRP MEASUREMENT:**

- a. All measurements were done at low, middle and high operational frequency range. RBW and VBW is 5MHz for CDMA, and 10MHz for LTE mode.
- b. Substitution method is used for E.I.R.P measurement. In the semi-anechoic chamber, EUT placed on the 0.8m height of Turn Table, rotated the table around 360 degrees to search the maximum radiation power and receiver antenna shall be rotated vertical and horizontal polarization and moved height from 1m to 4m to find the maximum polar radiated power. The “Read Value” is the spectrum reading the maximum power value.
- c. The substitution horn antenna is substituted for EUT at the same position and signals generator export the CW signal to the substitution antenna via a tx cable. Rotated the Turn Table and moved receiving antenna to find the maximum radiation power. Adjust output power level of S.G to get a Value of spectrum reading equal to “Read Value” of step b. Record the power level of S.G
- d.  $EIRP = \text{Output power level of S.G} - \text{TX cable loss} + \text{Antenna gain of substitution horn.}$

##### **CONDUCTED POWER MEASUREMENT:**

The EUT was set up for the maximum power with GSM, GPRS, EDGE & WCDMA link data modulation and link up with simulator. Set the EUT to transmit under low, middle and high channel and record the power level shown on simulator.

### 4.1.3 TEST SETUP

#### EIRP / ERP MEASUREMENT:

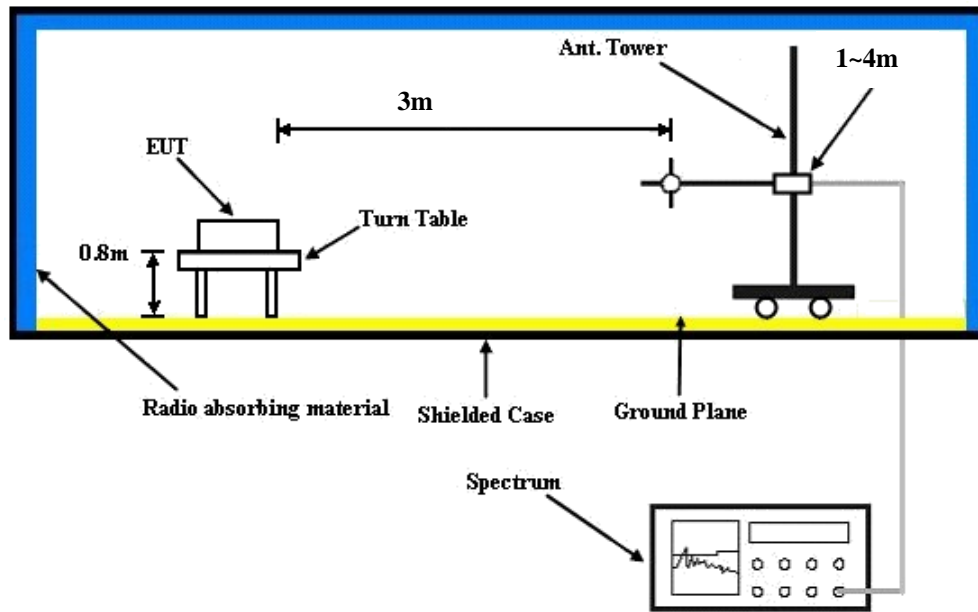

#### CONDUCTED POWER MEASUREMENT:

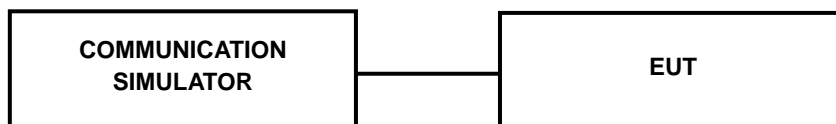



#### 4.1.4 TEST RESULTS

##### CONDUCTED OUTPUT POWER (dBm)

Band	CDMA		
	25	600	1175
Channel	25	600	1175
Frequency (MHz)	1851.25	1880	1908.75
RC1+SO55	24.87	24.71	24.31
RC3+SO55	24.88	24.72	24.32
RC3+SO32(+ F-SCH)	24.83	24.67	24.27
RC3+SO32(+SCH)	24.84	24.68	24.28
RTAP 153.6	24.86	24.70	24.30
RETAP 4096	24.82	24.66	24.26

Band / BW	Modulation	RB Size	RB Offset	Low CH	Mid CH	High CH	3PGG MPR (dB)
				26055	26365	26675	
				Frequency	Frequency	Frequency	
				1851.5 MHz	1882.5 MHz	1913.5 MHz	
25 / 3M	QPSK	1	0	23.30	23.17	23.31	0
		1	7	23.16	22.98	23.22	0
		1	14	23.06	23.01	23.16	0
		8	0	22.31	22.28	22.49	1
		8	3	22.26	22.08	22.30	1
		8	7	22.18	22.16	22.23	1
		15	0	22.26	22.12	22.29	1
	16QAM	1	0	22.20	22.07	22.21	1
		1	7	22.06	21.88	22.12	1
		1	14	21.96	21.91	22.06	1
		8	0	21.21	21.18	21.39	2
		8	3	21.16	20.98	21.20	2
		8	7	21.08	21.06	21.13	2
		15	0	21.16	21.02	21.19	2

Band / BW	Modulation	RB Size	RB Offset	Low CH	Mid CH	High CH	3PGG MPR (dB)
				26065	26365	26665	
				Frequency	Frequency	Frequency	
				1852.5 MHz	1882.5 MHz	1912.5 MHz	
25 / 5M	QPSK	1	0	23.33	23.20	23.34	0
		1	12	23.19	23.01	23.25	0
		1	24	23.09	23.04	23.19	0
		12	0	22.34	22.31	22.52	1
		12	6	22.29	22.11	22.33	1
		12	13	22.21	22.19	22.26	1
		25	0	22.29	22.15	22.32	1
	16QAM	1	0	22.23	22.10	22.24	1
		1	12	22.09	21.91	22.15	1
		1	24	21.99	21.94	22.09	1
		12	0	21.24	21.21	21.42	2
		12	6	21.19	21.01	21.23	2
		12	13	21.11	21.09	21.16	2
		25	0	21.19	21.05	21.22	2



A D T

Band / BW	Modulation	RB Size	RB Offset	Low CH 26090	Mid CH 26365	High CH 26640	3PGG MPR (dB)
				Frequency 1855.0 MHz	Frequency 1882.5 MHz	Frequency 1910.0 MHz	
25 / 10M	QPSK	1	0	23.37	23.24	<b>23.38</b>	0
		1	24	23.23	23.05	23.29	0
		1	49	23.13	23.08	23.23	0
		25	0	22.38	22.35	22.39	1
		25	12	22.33	22.15	22.37	1
		25	25	22.25	22.23	22.30	1
		50	0	22.33	22.19	22.36	1
	16QAM	1	0	22.27	22.14	22.28	1
		1	24	22.13	21.95	22.19	1
		1	49	22.03	21.98	22.13	1
		25	0	21.28	21.25	21.46	2
		25	12	21.23	21.05	21.27	2
		25	25	21.15	21.13	21.20	2
		50	0	21.23	21.09	21.26	2



A D T

## EIRP POWER (dBm)

### CDMA

Plane	Channel	Frequency (MHz)	LVL (dBm)	Correction Factor(dB)	EIRP(dBm)	EIRP(mW)	Polarization (H/V)
Y	25	1851.25	-14.32	36.57	22.25	167.96	H
	600	1880.00	-14.39	37.22	22.83	192.04	H
	1175	1908.75	-14.81	37.18	22.37	172.66	H
	25	1851.25	-19.31	37.65	18.34	68.25	V
	600	1880.00	-19.07	37.58	18.51	71.01	V
	1175	1908.75	-19.92	37.48	17.56	57.02	V

### LTE Band 25

#### CHANNEL BANDWIDTH: 3MHz QPSK

Plane	Channel	Frequency (MHz)	LVL (dBm)	Correction Factor(dB)	EIRP(dBm)	EIRP(mW)	Polarization (H/V)
X	26055	1851.5	-15.32	36.57	21.25	133.41	H
	26365	1882.5	-15.87	37.22	21.35	136.58	H
	26675	1913.5	-17.52	39.11	21.59	144.21	H
	26055	1851.5	-18.08	37.65	19.57	90.59	V
	26365	1882.5	-18.43	37.58	19.15	82.28	V
	26675	1913.5	-18.88	37.93	19.05	80.35	V

#### CHANNEL BANDWIDTH: 3MHz 16QAM

Plane	Channel	Frequency (MHz)	LVL (dBm)	Correction Factor(dB)	EIRP(dBm)	EIRP(mW)	Polarization (H/V)
X	26055	1851.5	-15.81	36.57	20.76	119.18	H
	26365	1882.5	-16.44	37.22	20.78	119.78	H
	26675	1913.5	-18.35	39.11	20.76	119.12	H
	26055	1851.5	-18.07	37.65	19.58	90.80	V
	26365	1882.5	-18.62	37.58	18.96	78.76	V
	26675	1913.5	-18.45	37.93	19.48	88.72	V





A D T

### CHANNEL BANDWIDTH: 5MHz QPSK

Plane	Channel	Frequency (MHz)	LVL (dBm)	Correction Factor(dB)	EIRP(dBm)	EIRP(mW)	Polarization (H/V)
X	26065	1852.5	-15.61	36.57	20.96	124.80	H
	26365	1882.5	-16.05	37.22	21.17	131.04	H
	26665	1912.5	-17.77	39.11	21.34	136.14	H
	26065	1852.5	-18.23	37.65	19.42	87.52	V
	26365	1882.5	-18.20	37.58	19.38	86.76	V
	26665	1912.5	-18.32	37.96	19.64	92.04	V

### CHANNEL BANDWIDTH: 5MHZ 16QAM

Plane	Channel	Frequency (MHz)	LVL (dBm)	Correction Factor(dB)	EIRP(dBm)	EIRP(mW)	Polarization (H/V)
X	26065	1852.5	-15.84	36.57	20.73	118.36	H
	26365	1882.5	-16.47	37.22	20.75	118.96	H
	26665	1912.5	-18.55	39.11	20.56	113.76	H
	26065	1852.5	-19.13	37.65	18.52	71.14	V
	26365	1882.5	-19.06	37.58	18.52	71.17	V
	26665	1912.5	-19.14	37.96	18.82	76.21	V



**CHANNEL BANDWIDTH: 10MHZ QPSK**

Plane	Channel	Frequency (MHz)	LVL (dBm)	Correction Factor(dB)	EIRP(dBm)	EIRP(mW)	Polarization (H/V)
X	26090	1855	-15.52	36.57	21.05	127.41	H
	26365	1882.5	-15.59	37.22	21.63	145.68	H
	26640	1910	-17.41	39.19	21.78	150.66	H
	26090	1855	-18.16	37.65	19.49	88.94	V
	26365	1882.5	-18.32	37.58	19.26	84.39	V
	26640	1910	-18.63	38.15	19.52	89.54	V

**CHANNEL BANDWIDTH: 10MHZ 16QAM**

Plane	Channel	Frequency (MHz)	LVL (dBm)	Correction Factor(dB)	EIRP(dBm)	EIRP(mW)	Polarization (H/V)
X	26090	1855	-16.28	36.57	20.29	106.95	H
	26365	1882.5	-16.46	37.22	20.76	119.23	H
	26640	1910	-18.43	39.19	20.76	119.12	H
	26090	1855	-19.02	37.65	18.63	72.96	V
	26365	1882.5	-19.32	37.58	18.26	67.03	V
	26640	1910	-19.28	38.15	18.87	77.09	V

## 4.2 FREQUENCY STABILITY MEASUREMENT

### 4.2.1 LIMITS OF FREQUENCY STABILITY MEASUREMENT

The frequency stability shall be sufficient to ensure that the fundamental emission stays within the authorized frequency block.

### 4.2.2 TEST PROCEDURE

- a. Device is placed at the oven room. The oven room could control the temperatures and humidity. Power warm up is at least 15 min and power applied should perform before recording frequency error.
- b. EUT is connected the external power supply to control the DC input power. The test voltage range is from minimum to maximum working voltage. Each step shall be record the frequency error rate.
- c. The temperature range step is 10 degrees in this test items. All temperature levels shall be hold the  $\pm 0.5^{\circ}\text{C}$  during the measurement testing. The each temperature step shall be at least 0.5 hours, consider the EUT could be test under the stability condition.

**NOTE:** The frequency error was recorded frequency error from the communication simulator.

### 4.2.3 TEST SETUP

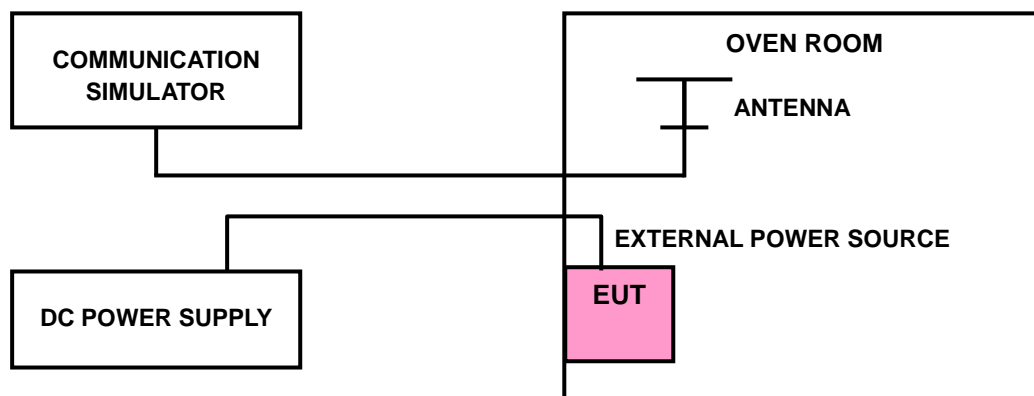

#### 4.2.4 TEST RESULTS

##### FREQUENCY ERROR vs. VOLTAGE

VOLTAGE (Volts)	FREQUENCY ERROR (ppm)				LIMIT (ppm)
	CDMA	LTE Band 25			
		3MHz	5MHz	10MHz	
3.7	0.002	-0.003	-0.003	0.0035	2.5
3.3	0.003	-0.001	-0.001	0.0004	2.5
4.2	0.002	-0.002	0.001	-0.0028	2.5

**NOTE:** The applicant defined the normal working voltage of the battery is from 3.3Vdc to 4.2Vdc.

##### FREQUENCY ERROR vs. TEMPERATURE

TEMP. (°C)	FREQUENCY ERROR (ppm)				LIMIT (ppm)
	CDMA	LTE Band 25			
		3MHz	5MHz	10MHz	
-30	0.002	0.001	0.002	0.0016	2.5
-20	0.002	-0.001	-0.002	-0.0003	2.5
-10	0.003	-0.003	-0.002	-0.0008	2.5
0	0.002	-0.002	0.005	-0.0005	2.5
10	0.003	-0.002	-0.003	0.0030	2.5
20	0.002	-0.006	-0.001	0.0022	2.5
30	0.002	-0.003	-0.001	-0.0022	2.5
40	0.002	-0.002	-0.002	0.0008	2.5
50	0.002	0.001	-0.001	-0.0014	2.5

### 4.3 OCCUPIED BANDWIDTH MEASUREMENT

#### 4.3.1 TEST PROCEDURES

The EUT makes a call to the communication simulator. All measurements were done at low, middle and high operational frequency range. The communication simulator station system controlled a EUT to export maximum output power under transmission mode and specific channel frequency. Use OBW measurement function of Spectrum analyzer to measure 99 % occupied bandwidth.

#### 4.3.2 TEST SETUP

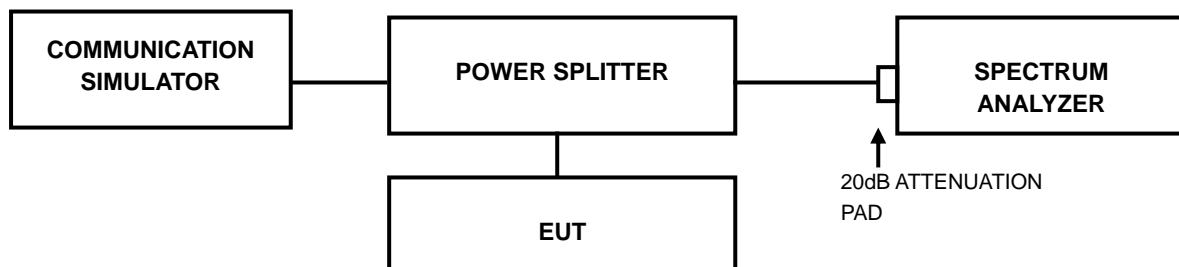



A D T

### 4.3.3 TEST RESULTS

CHANNEL	FREQUENCY	99% OCCUPIED BANDWIDTH (MHz)
		CDMA
25	1851.25	1.2676
600	1880.00	1.2713
1175	1908.75	1.2655

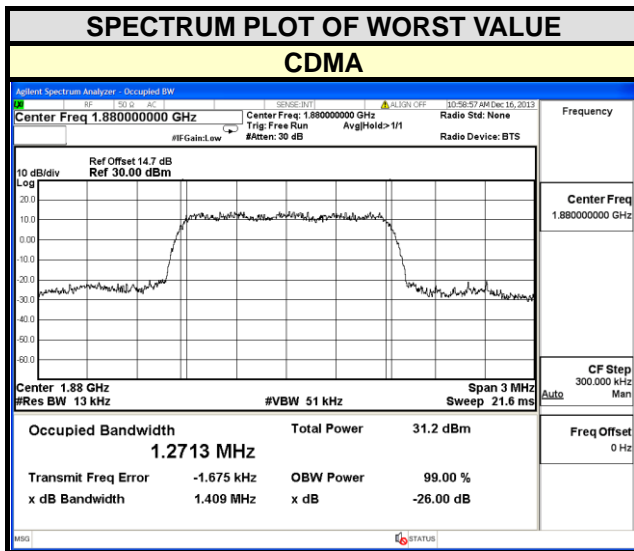



A D T

LTE BAND 25							
CHANNEL BANDWIDTH: 3MHz				CHANNEL BANDWIDTH: 5MHz			
CHANNEL	FREQUENCY	99% OCCUPIED BANDWIDTH (MHz)		CHANNEL	FREQUENCY	99% OCCUPIED BANDWIDTH (MHz)	
		QPSK	16QAM			QPSK	16QAM
26055	1851.5	2.6795	2.6820	26065	1852.5	4.4900	4.4871
26365	1882.5	2.6806	2.6802	26365	1882.5	4.4910	4.4875
26675	1913.5	2.6816	2.6821	26665	1912.5	4.4916	4.4860

**SPECTRUM PLOT OF WORST VALUE**

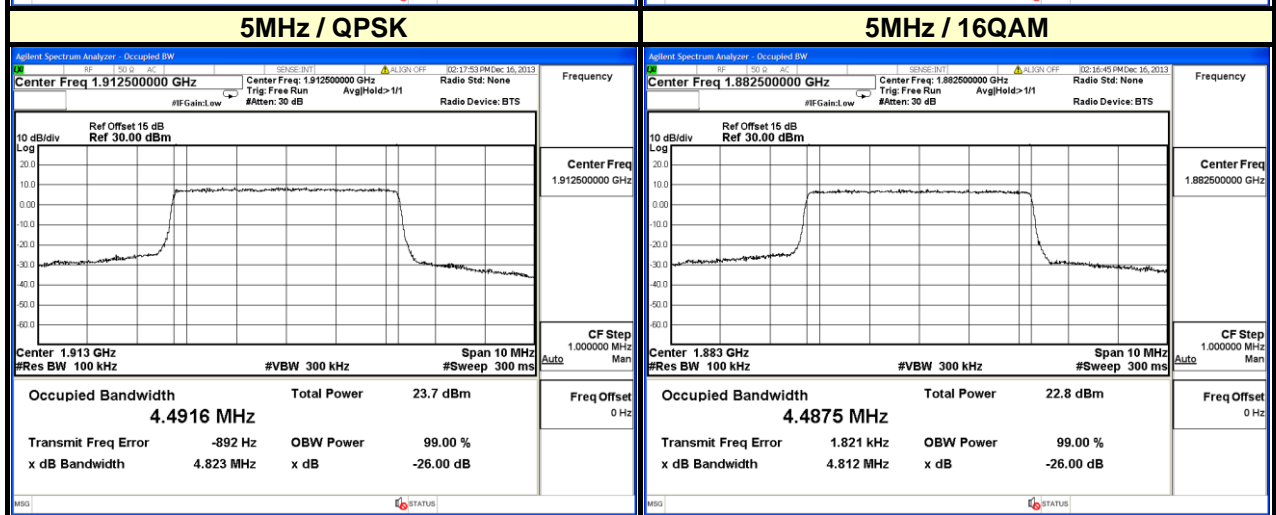
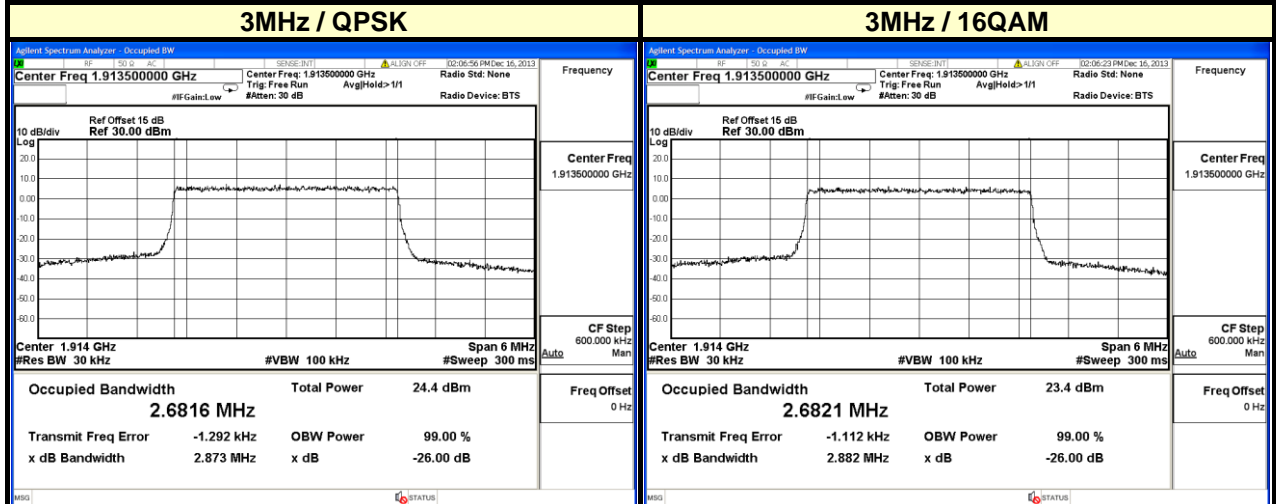



A D T

LTE BAND 25			
CHANNEL BANDWIDTH: 10MHz			
CHANNEL	FREQUENCY	99% OCCUPIED BANDWIDTH (MHz)	
		QPSK	16QAM
26090	1855.0	8.9168	8.9084
26365	1882.5	8.9157	8.9183
26640	1910.0	8.9186	8.9183

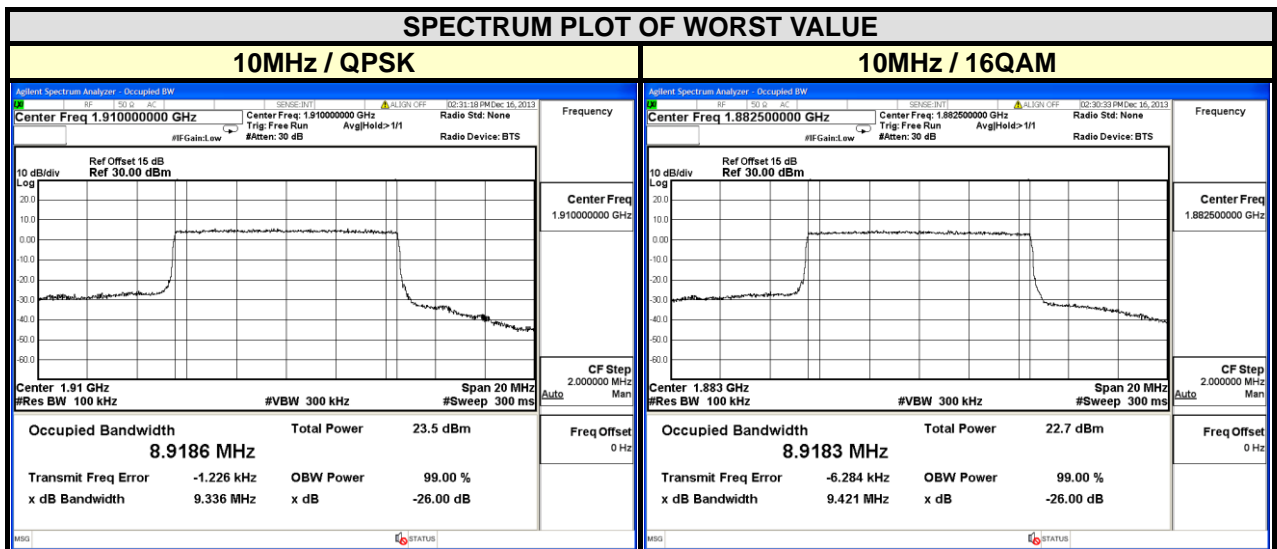



## 4.4 PEAK TO AVERAGE RATIO

### 4.4.1 LIMITS OF PEAK TO AVERAGE RATIO MEASUREMENT

In measuring transmissions in this band using an average power technique, the peak to-average ratio (PAR) of the transmission may not exceed 13 dB

### 4.4.2 TEST SETUP

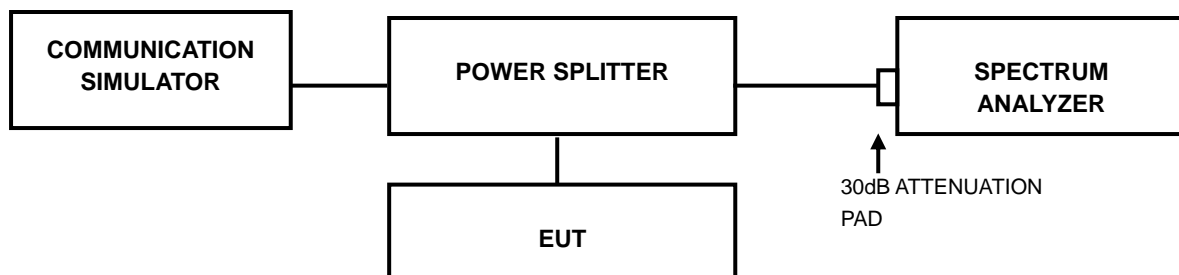

### 4.4.3 TEST PROCEDURES

1. Set resolution/measurement bandwidth  $\geq$  signal's occupied bandwidth;
2. Set the number of counts to a value that stabilizes the measured CCDF curve;
3. Record the maximum PAPR level associated with a probability of 0.1%.



A D T

#### 4.4.4 TEST RESULTS

CHANNEL	FREQUENCY (MHz)	PEAK TO AVERAGE RATIO (dB)
		CDMA
25	1851.25	3.22
600	1880.00	3.69
1175	1908.75	3.77

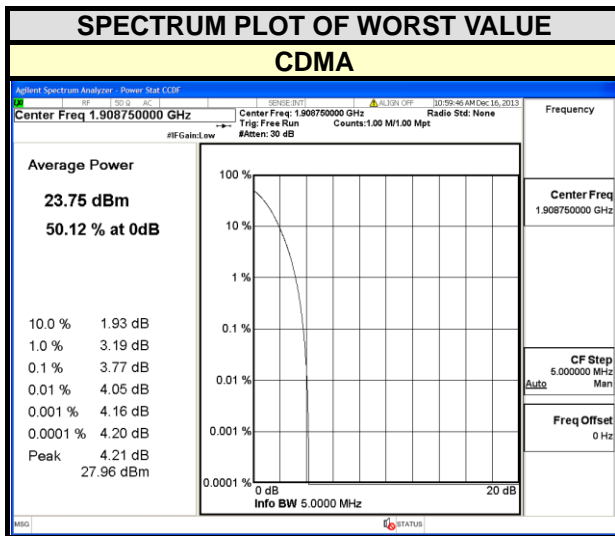



A D T

LTE BAND 25							
CHANNEL BANDWIDTH: 3MHz				CHANNEL BANDWIDTH: 5MHz			
CHANNEL	FREQUENCY (MHz)	PEAK TO AVERAGE RATIO (dB)		CHANNEL	FREQUENCY (MHz)	PEAK TO AVERAGE RATIO (dB)	
		QPSK	16QAM			QPSK	16QAM
26055	1851.5	4.62	5.91	26065	1852.5	4.98	6.04
26365	1882.5	5.06	6.31	26365	1882.5	5.02	6.18
26675	1913.5	4.82	6.50	26665	1912.5	4.95	6.32

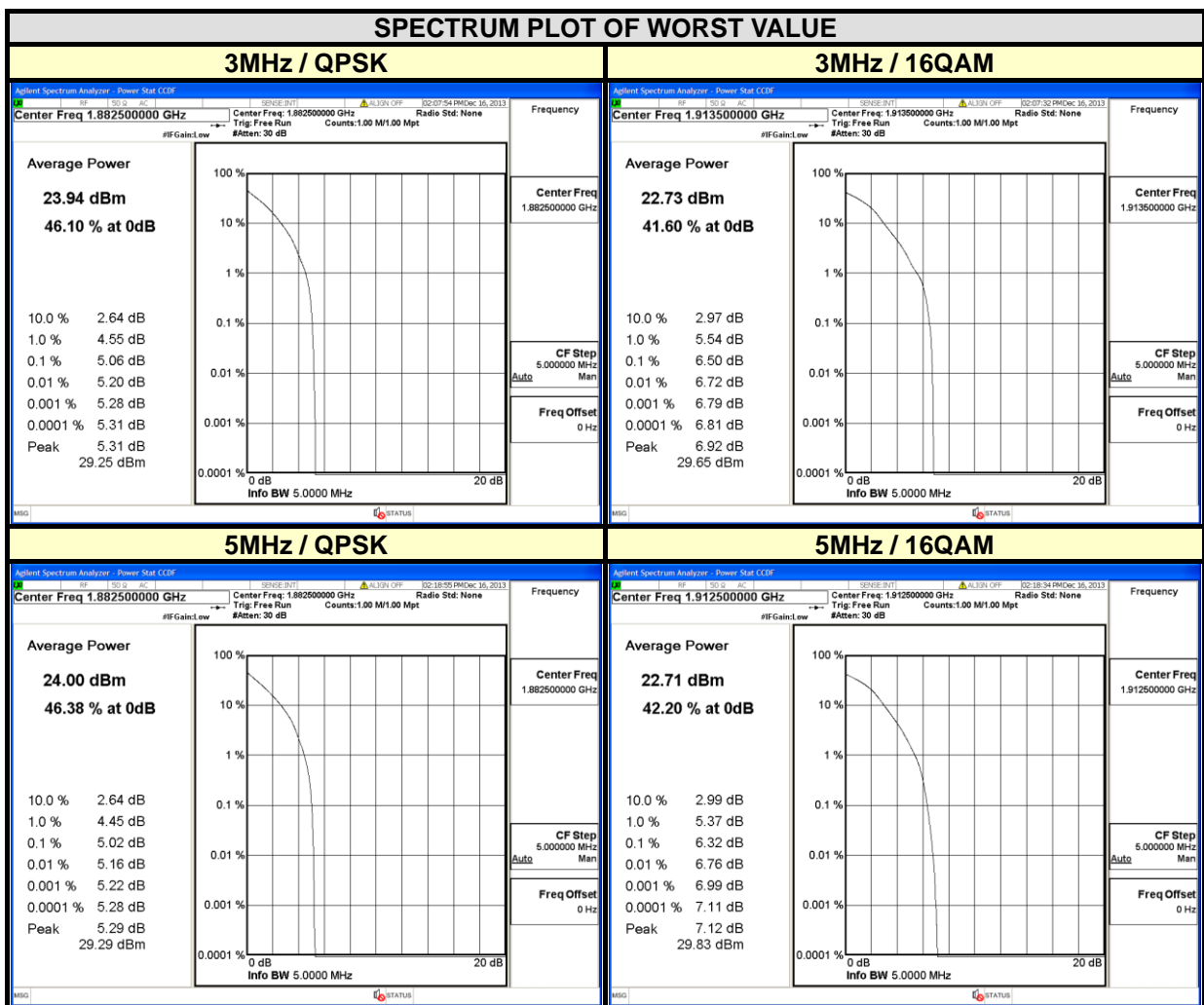



A D T

LTE BAND 25			
CHANNEL BANDWIDTH: 10MHz			
CHANNEL	FREQUENCY (MHz)	PEAK TO AVERAGE RATIO (dB)	
		QPSK	16QAM
26090	1855.0	5.05	6.36
26365	1882.5	4.99	6.23
26640	1910.0	4.87	6.15

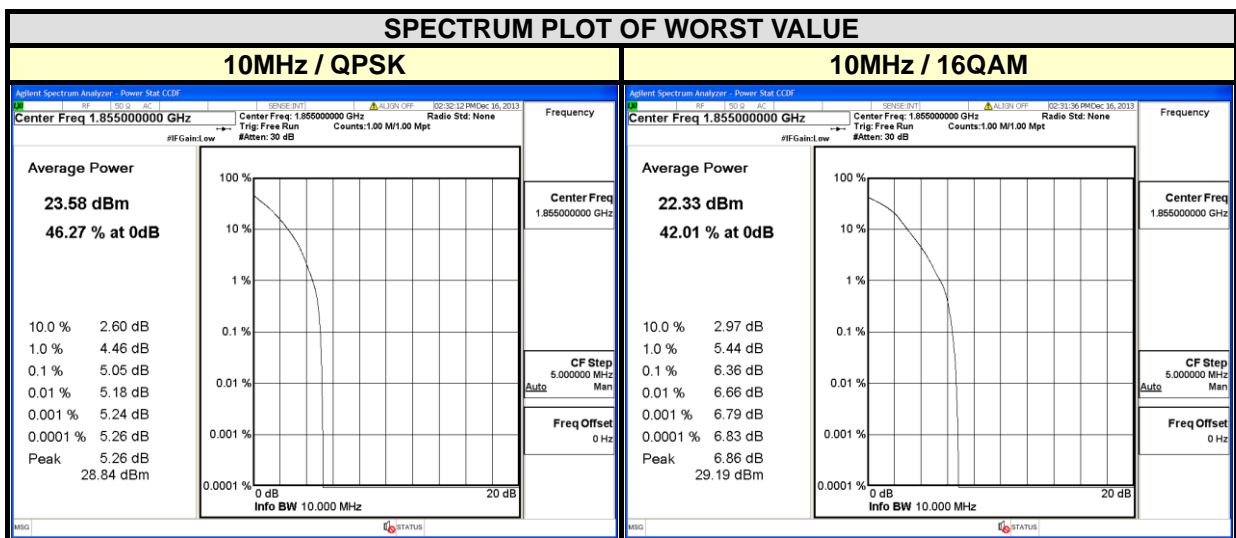

## 4.5 BAND EDGE MEASUREMENT

### 4.5.1 LIMITS OF BAND EDGE MEASUREMENT

Power of any emission outside of the authorized operating frequency ranges must be attenuated below the transmitting power (P) by a factor of at least  $43 + 10 \log(P)$  dB. In the 1 MHz bands immediately outside and adjacent to the frequency block a resolution bandwidth of at least one percent of the emission bandwidth of the fundamental emission of the transmitter may be employed.

### 4.5.2 TEST SETUP

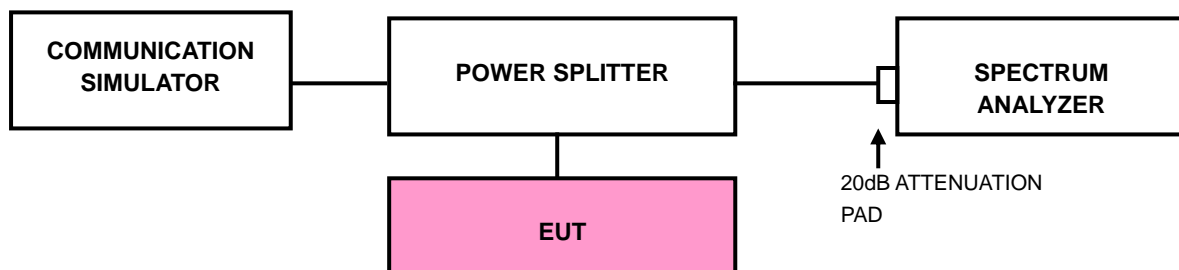

### 4.5.3 TEST PROCEDURES

- a. All measurements were done at low and high operational frequency range.
- b. The center frequency of spectrum is the band edge frequency and span is 1MHz. RB of the spectrum is 13kHz and VB of the spectrum is 51kHz (CDMA).
- c. The center frequency of spectrum is the band edge frequency and span is 1MHz. RB of the spectrum is 30kHz and VB of the spectrum is 100kHz (LTE Channel Bandwidth 3MHz).
- d. The center frequency of spectrum is the band edge frequency and span is 1MHz. RB of the spectrum is 100kHz and VB of the spectrum is 300kHz (LTE Channel Bandwidth 5MHz & 10MHz).
- e. Record the max trace plot into the test report.



A D T

### 4.5.4 TEST RESULTS

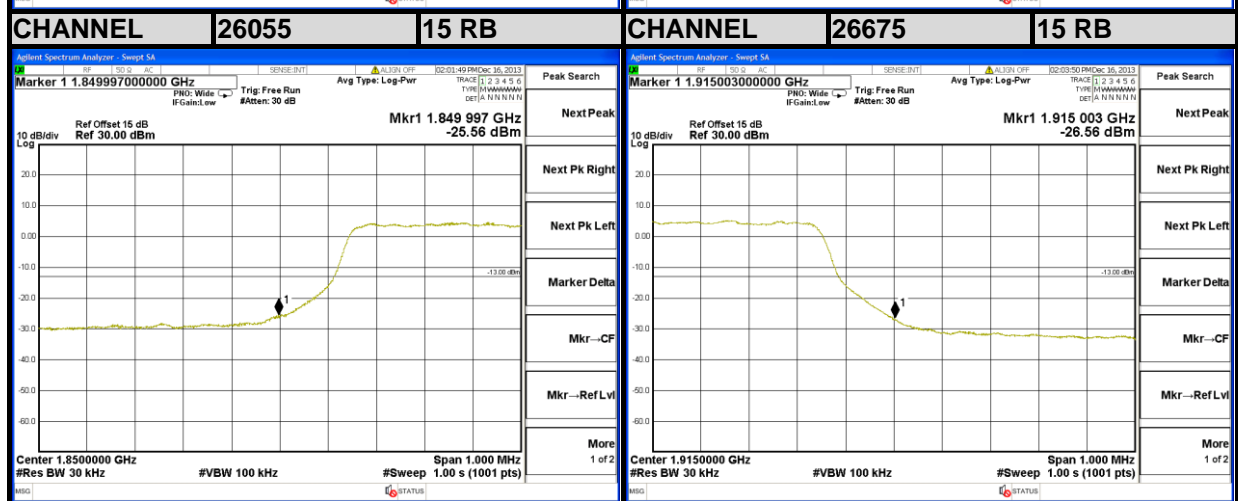
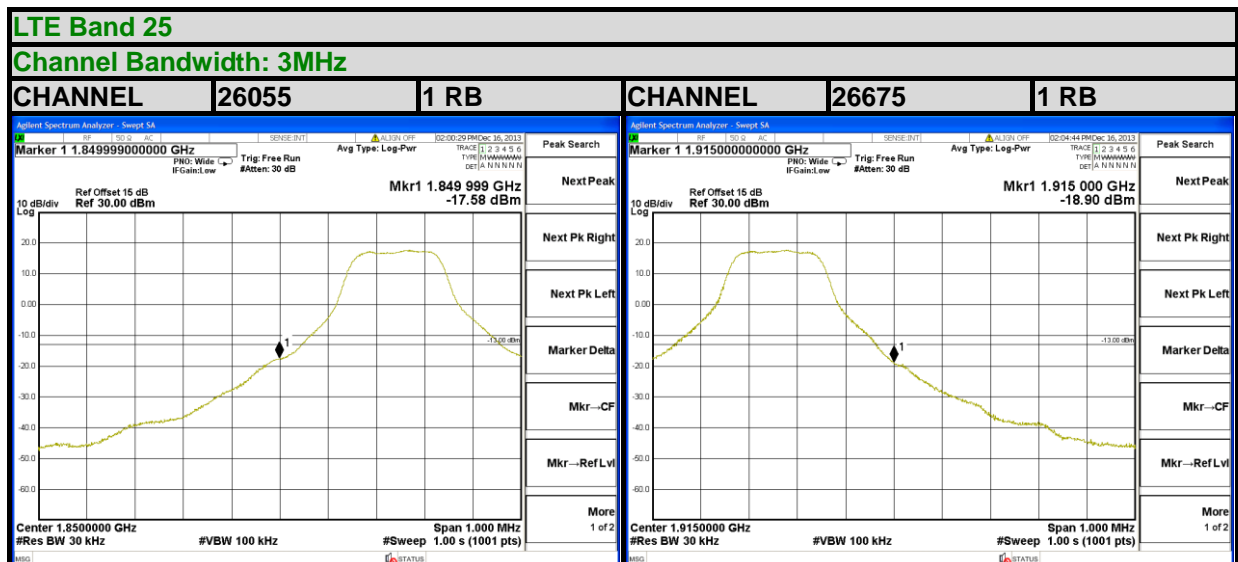
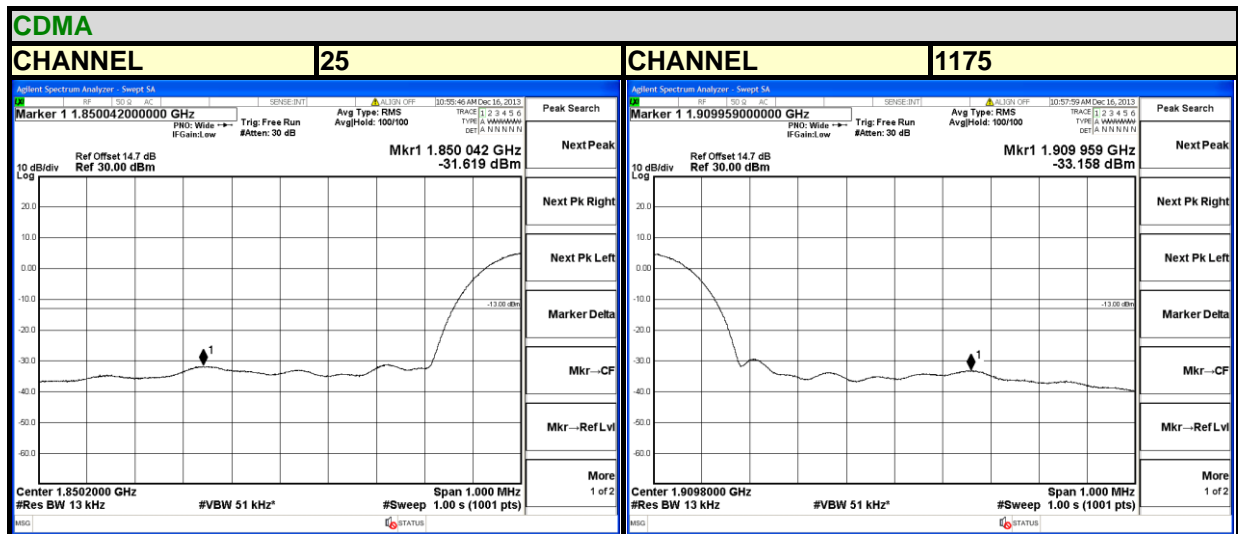



A D T

### LTE Band 25

### Channel Bandwidth: 5MHz

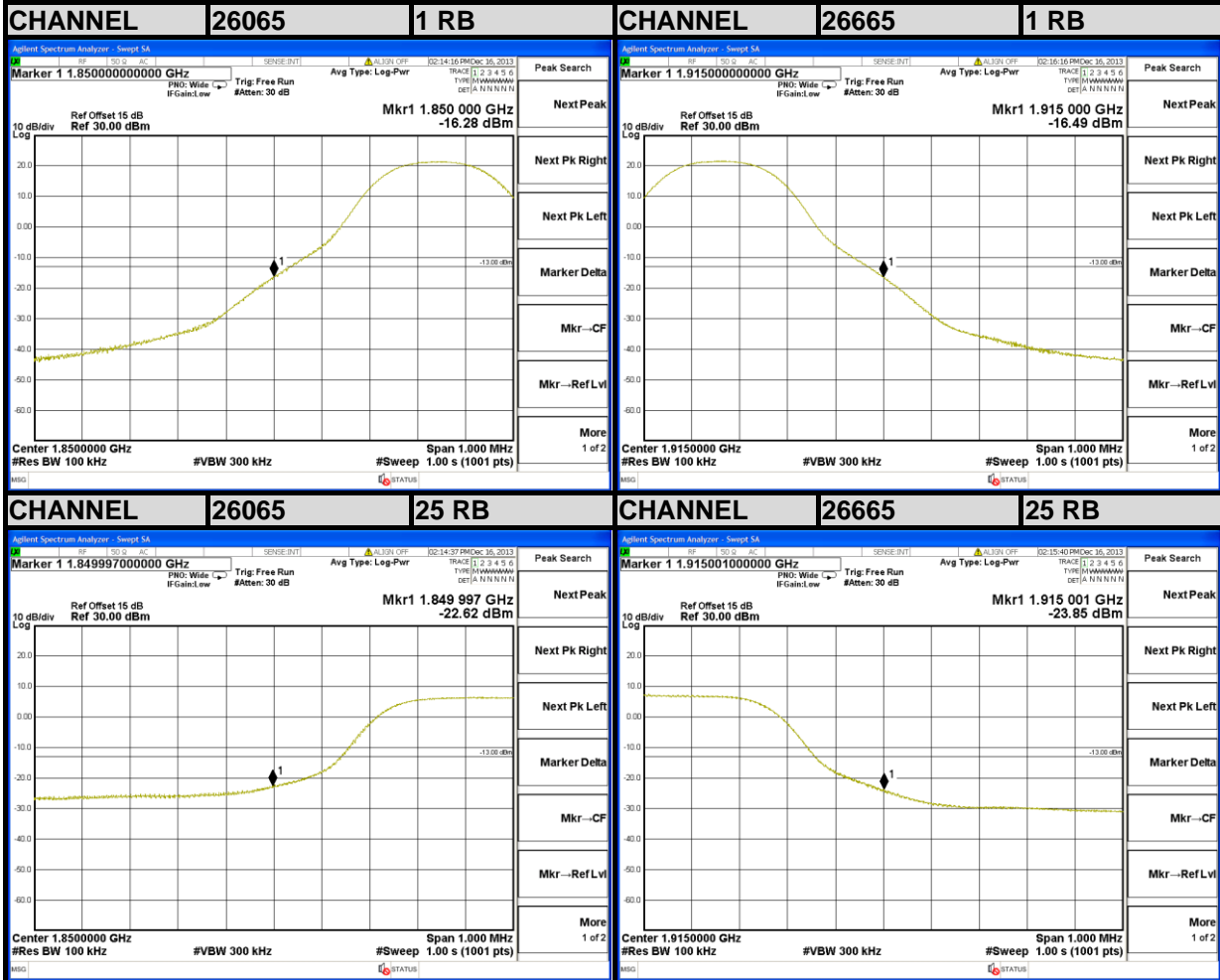



A D T

### LTE Band 25

### Channel Bandwidth: 10MHz

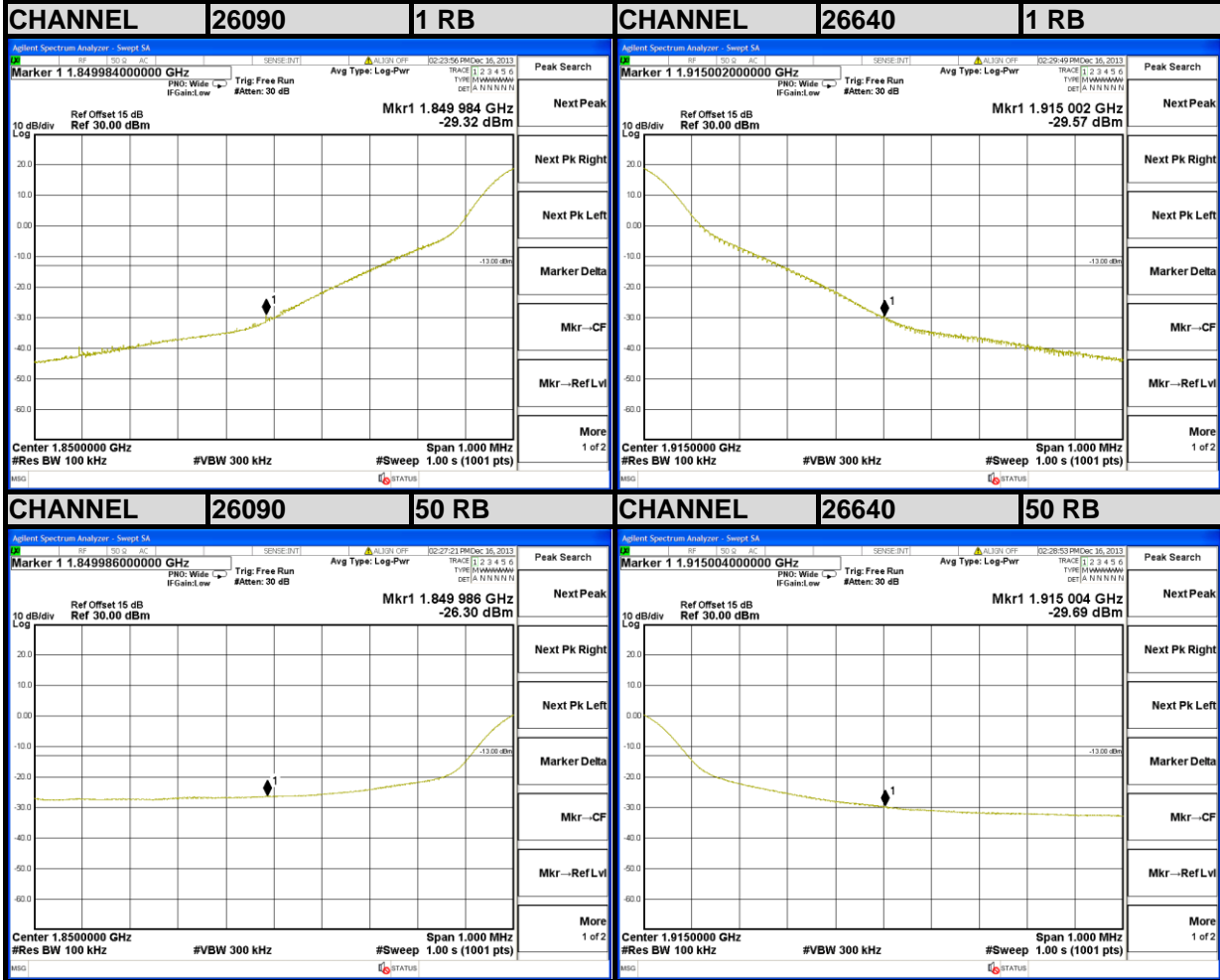



## 4.6 CONDUCTED SPURIOUS EMISSIONS

### 4.6.1 LIMITS OF CONDUCTED SPURIOUS EMISSIONS MEASUREMENT

The power of any emission outside of the authorized operating frequency ranges must be attenuated below the transmitting power (P) by a factor of at least  $43 + 10 \log(P)$  dB. The emission limit equal to  $-13\text{dBm}$ .

### 4.6.2 TEST PROCEDURE

- The EUT makes a phone call to the communication simulator. All measurements were done at low, middle and high operational frequency range.
- Measuring frequency range is from 30 MHz to 19.1GHz. 10dB attenuation pad is connected with spectrum. RBW=1MHz and VBW=3MHz is used for conducted emission measurement.

### 4.6.3 TEST SETUP

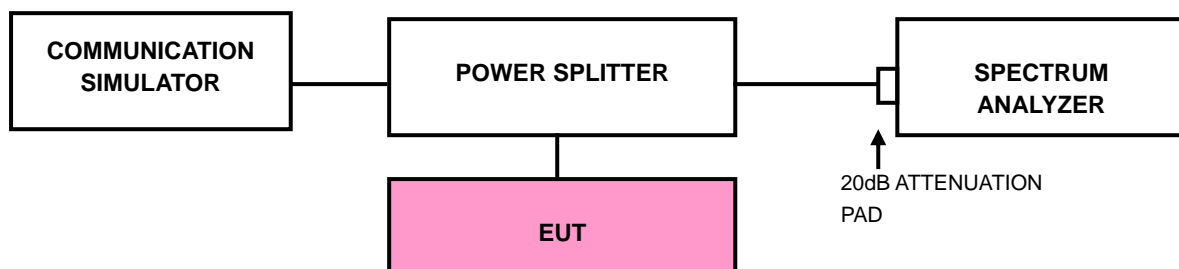



A D T

### 4.6.4 TEST RESULTS

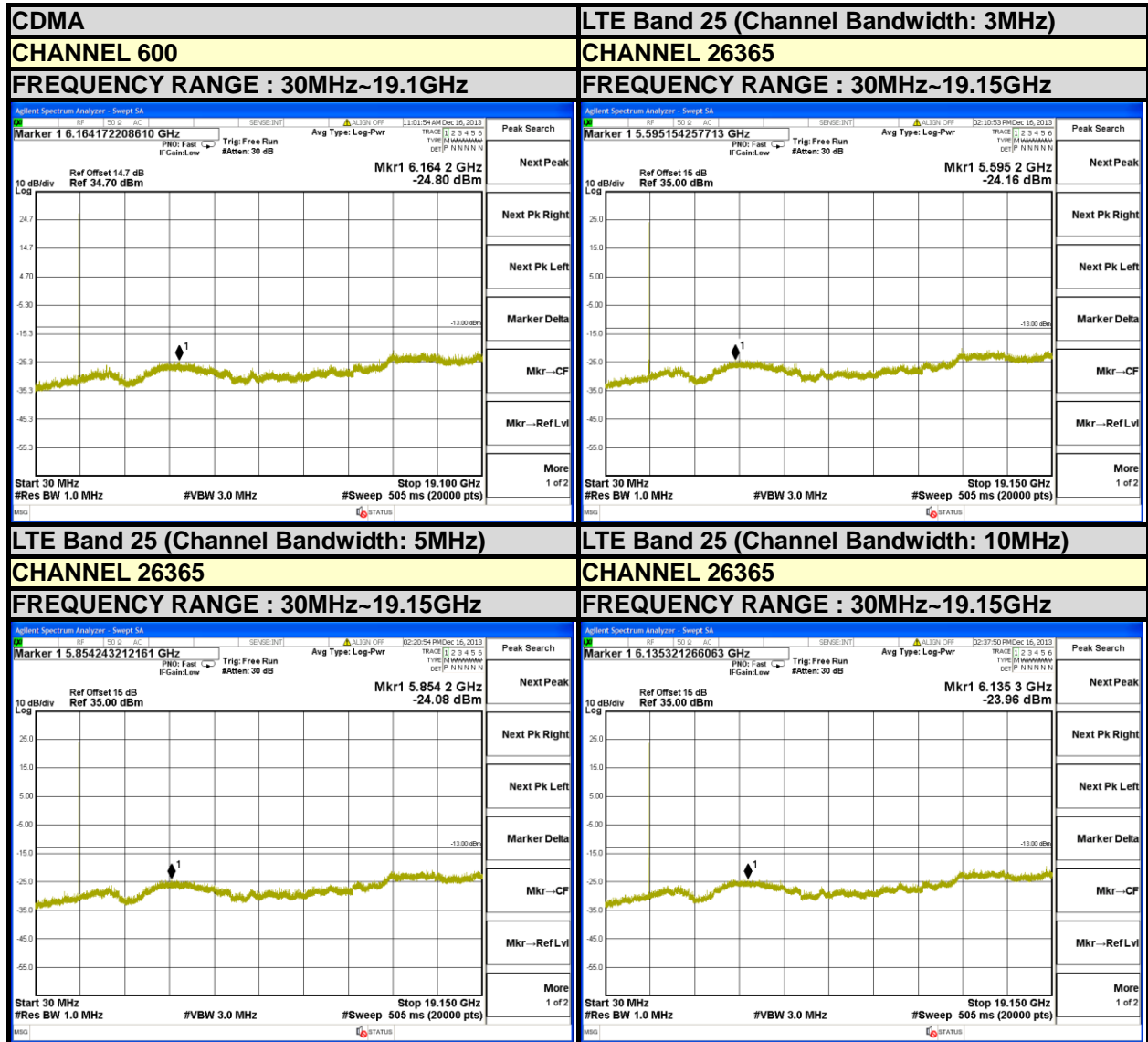

## 4.7 RADIATED EMISSION MEASUREMENT

### 4.7.1 LIMITS OF RADIATED EMISSION MEASUREMENT

The power of any emission outside of the authorized operating frequency ranges must be attenuated below the transmitting power (P) by a factor of at least  $43 + 10 \log(P)$  dB. The emission limit equal to  $-13\text{dBm}$ .

### 4.7.2 TEST PROCEDURES

- a. Substitution method is used for E.I.R.P measurement. In the semi-anechoic chamber, EUT placed on the 0.8m height of Turn Table, rotated the table around 360 degrees to search the maximum radiation power and receiver antenna shall be rotated vertical and horizontal polarization and moved height from 1m to 4m to find the maximum polar radiated power. The “Read Value” is the spectrum reading the maximum power value.
- b. The substitution horn antenna is substituted for EUT at the same position and signals generator export the CW signal to the substitution antenna via a TX cable. Rotated the Turn Table and moved receiving antenna to find the maximum radiation power. Adjust output power level of S.G to get a Value of spectrum reading equal to “Read Value” of step a. Record the power level of S.G
- c.  $\text{EIRP} = \text{Output power level of S.G} - \text{TX cable loss} + \text{Antenna gain of substitution horn}$ .
- d. E.R.P power can be calculated form E.I.R.P power by subtracting the gain of dipole,  
 $\text{E.R.P power} = \text{E.I.R.P power} - 2.15\text{dBi}$ .

**NOTE:** The resolution bandwidth and video bandwidth of test receiver/spectrum analyzer is 1MHz/3MHz.

### 4.7.3 DEVIATION FROM TEST STANDARD

No deviation

#### 4.7.4 TEST SETUP

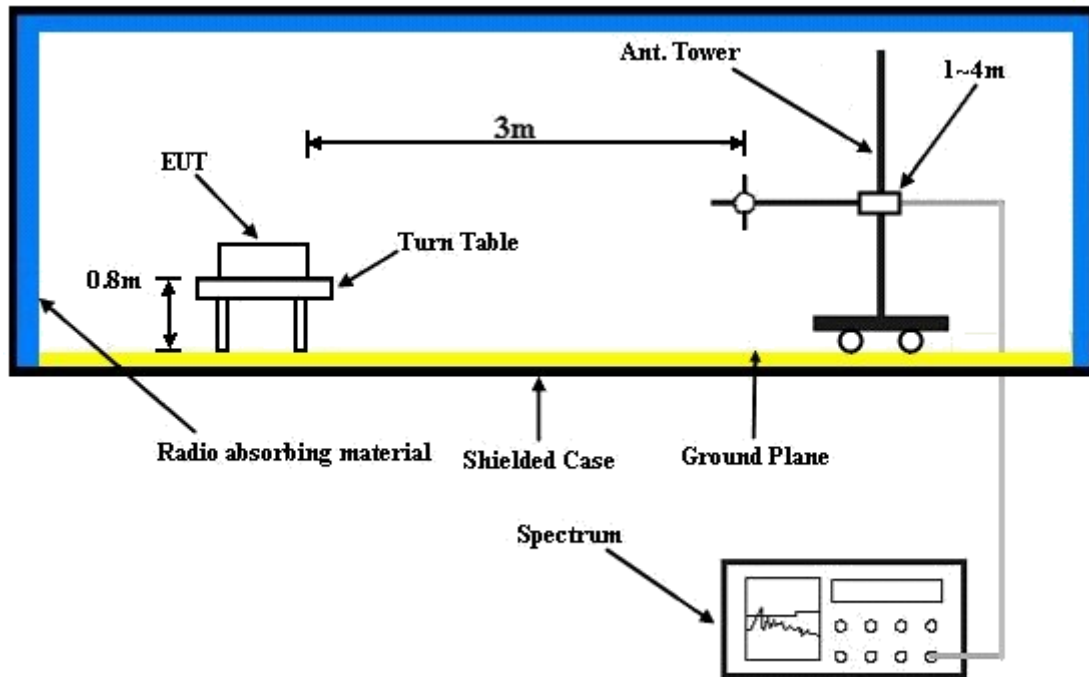

For the actual test configuration, please refer to the attached file (Test Setup Photo).



A D T

### 4.7.5 TEST RESULTS

#### CDMA:



Bureau Veritas Consumer Products Services Ltd., Taoyuan Branch

A D T

Data: 15

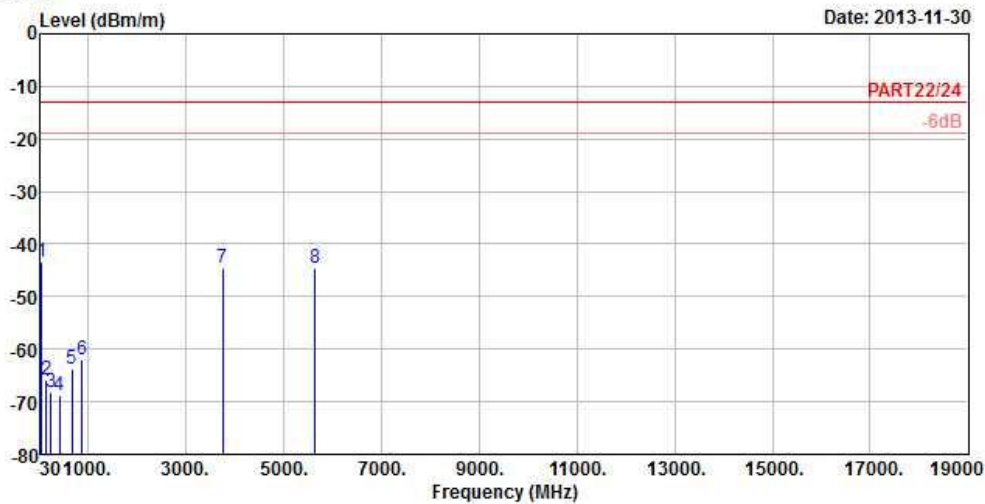

Site : 966 Chamber 5  
 Condition : PART22/24 3m HORIZONTAL  
 Brand/Model: G81-C6725  
 Remark : 1xRTT1900 Link  
 Tested by : Johnson Liao  
 Temperature : 25°C  
 Humidity : 65%  
 Plane : X  
 Sample No : C131120-002-024-006

	Read	Limit	Over			
Freq	Level	Level	Line	Limit	Factor	Remark
MHz	dBm/m	dBm	dBm/m	dB	dB/m	
1 pp	44.58	-43.51	-42.32	-13.00	-30.51	-1.19 Peak
2	144.21	-65.97	-59.99	-13.00	-52.97	-5.98 Peak
3	246.27	-68.20	-62.35	-13.00	-55.20	-5.85 Peak
4	419.70	-68.82	-63.69	-13.00	-55.82	-5.13 Peak
5	668.20	-63.84	-64.71	-13.00	-50.84	0.87 Peak
6	876.80	-61.91	-64.48	-13.00	-48.91	2.57 Peak
7	3760.00	-44.59	-36.29	-13.00	-31.59	-8.30 Peak
8	5640.00	-44.56	-42.66	-13.00	-31.56	-1.90 Peak



A D T



Bureau Veritas Consumer Products Services Ltd., Taoyuan Branch

A D T

Data: 16

Date: 2013-11-30

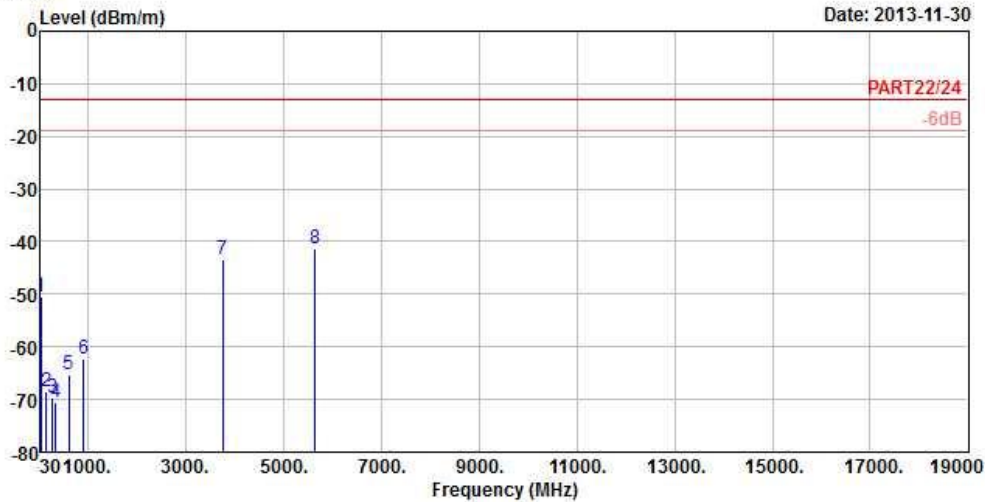

Site : 966 Chamber 5  
 Condition : PART22/24 3m VERTICAL  
 Brand/Model: G81-C6725  
 Remark : 1xRTT1900 Link  
 Tested by : Johnson Liao  
 Temperature : 25°C  
 Humidity : 65%  
 Plane : X  
 Sample No : C131120-002-024-006

	Read	Limit	Over			
Freq	Level	Level	Line	Limit	Factor	Remark
MHz	dBm/m	dBm	dBm/m	dB	dB/m	
1	38.64	-50.49	-48.75	-13.00	-37.49	-1.74 Peak
2	141.78	-68.41	-62.61	-13.00	-55.41	-5.80 Peak
3	267.33	-69.76	-63.83	-13.00	-56.76	-5.93 Peak
4	332.90	-70.59	-64.45	-13.00	-57.59	-6.14 Peak
5	609.40	-65.23	-65.04	-13.00	-52.23	-0.19 Peak
6	915.30	-62.34	-65.35	-13.00	-49.34	3.01 Peak
7	3760.00	-43.26	-34.96	-13.00	-30.26	-8.30 Peak
8 pp	5640.00	-41.43	-39.53	-13.00	-28.43	-1.90 Peak



A D T

### LTE BAND 25

CHANNEL BANDWIDTH: 3MHz / QPSK



Bureau Veritas Consumer Products Services Ltd., Taoyuan Branch

A D T

Data: 15

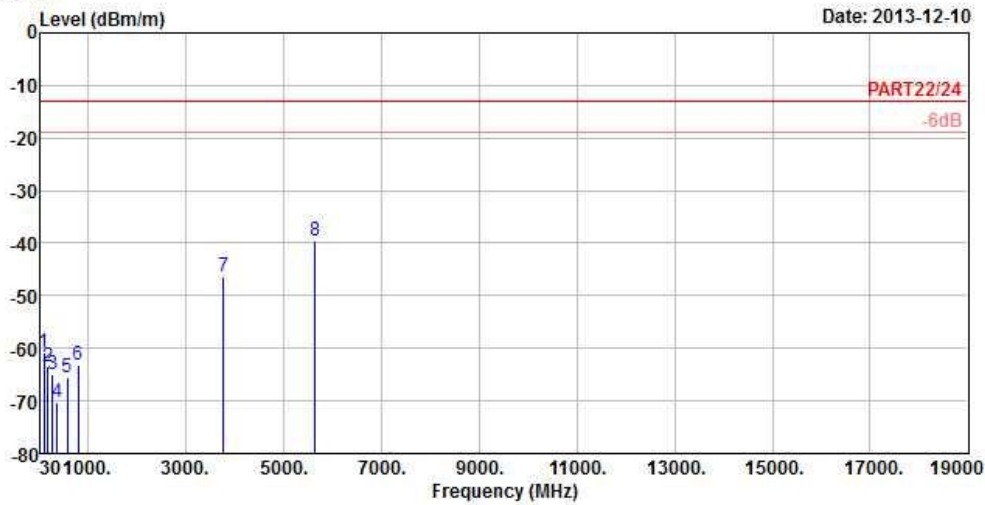

Site : 966 Chamber 5  
 Condition : PART22/24 3m HORIZONTAL  
 Brand/Model: G81-C6725  
 Remark : Band 25 3M QPSK(1,0) Link  
 Tested by : Johnosn Liao  
 Temperature : 25°C  
 Humidity : 65%  
 Plane : Z  
 Sample No : C131120-004-024-005

	Freq	Level	Read Level	Limit Line	Over Limit	Factor	Remark
	MHz	dBm/m	dBm	dBm/m	dB	dB/m	
1	95.07	-60.70	-50.21	-13.00	-47.70	-10.49	Peak
2	179.04	-63.48	-57.62	-13.00	-50.48	-5.86	Peak
3	265.71	-64.94	-59.04	-13.00	-51.94	-5.90	Peak
4	363.70	-70.15	-64.24	-13.00	-57.15	-5.91	Peak
5	582.80	-65.43	-64.60	-13.00	-52.43	-0.83	Peak
6	791.40	-63.30	-65.37	-13.00	-50.30	2.07	Peak
7	3762.40	-46.29	-37.99	-13.00	-33.29	-8.30	Peak
8 pp	5643.60	-39.66	-37.76	-13.00	-26.66	-1.90	Peak



A D T



Bureau Veritas Consumer Products Services Ltd., Taoyuan Branch

A D T

Data: 16

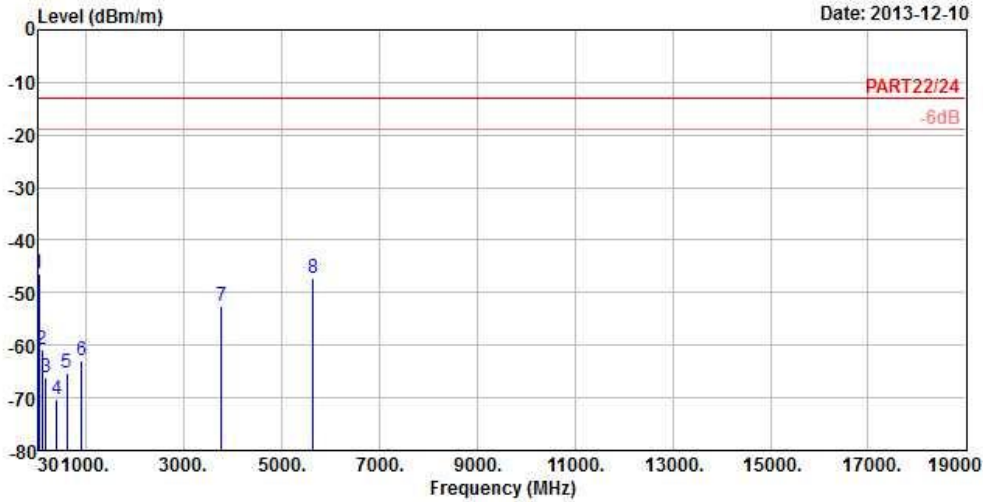

Site : 966 Chamber 5  
 Condition : PART22/24 3m VERTICAL  
 Brand/Model: G81-C6725  
 Remark : Band 25 3M QPSK(1,0) Link  
 Tested by : Johnosn Liao  
 Temperature : 25°C  
 Humidity : 65%  
 Plane : Z  
 Sample No : C131120-004-024-005

	Read	Limit	Over			
Freq	Level	Level	Line	Limit	Factor	Remark
MHz	dBm/m	dBm	dBm/m	dB	dB/m	
1 pp	37.02	-46.31	-44.16	-13.00	-33.31	-2.15 Peak
2	95.88	-60.73	-50.26	-13.00	-47.73	-10.47 Peak
3	178.23	-66.25	-60.21	-13.00	-53.25	-6.04 Peak
4	398.70	-70.28	-64.63	-13.00	-57.28	-5.65 Peak
5	612.90	-65.15	-65.03	-13.00	-52.15	-0.12 Peak
6	901.30	-62.92	-65.64	-13.00	-49.92	2.72 Peak
7	3762.40	-52.62	-44.32	-13.00	-39.62	-8.30 Peak
8	5643.60	-47.26	-45.36	-13.00	-34.26	-1.90 Peak





A D T

CHANNEL BANDWIDTH: 5MHz / QPSK



Bureau Veritas Consumer Products Services Ltd., Taoyuan Branch

A D T

Data: 11

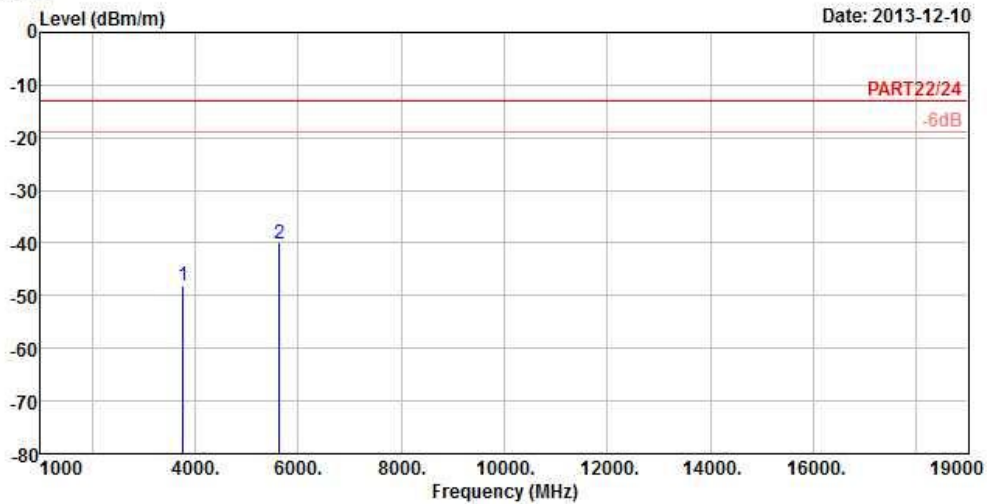

Site : 966 Chamber 5  
 Condition : PART22/24 3m HORIZONTAL  
 Brand/Model: G81-C6725  
 Remark : Band 25 5M QPSK(1,0) Link  
 Tested by : Johnosn Liao  
 Temperature : 25°C  
 Humidity : 65%  
 Plane : Z  
 Sample No : C131120-004-024-005

	Freq	Level	Read Level	Limit Line	Over Limit	Factor	Remark
	MHz	dBm/m	dBm	dBm/m	dB	dB/m	
1	3760.60	-48.26	-39.96	-13.00	-35.26	-8.30	Peak
2 pp	5640.90	-40.00	-38.10	-13.00	-27.00	-1.90	Peak



A D T



Bureau Veritas Consumer Products Services Ltd., Taoyuan Branch

A D T

Data: 12

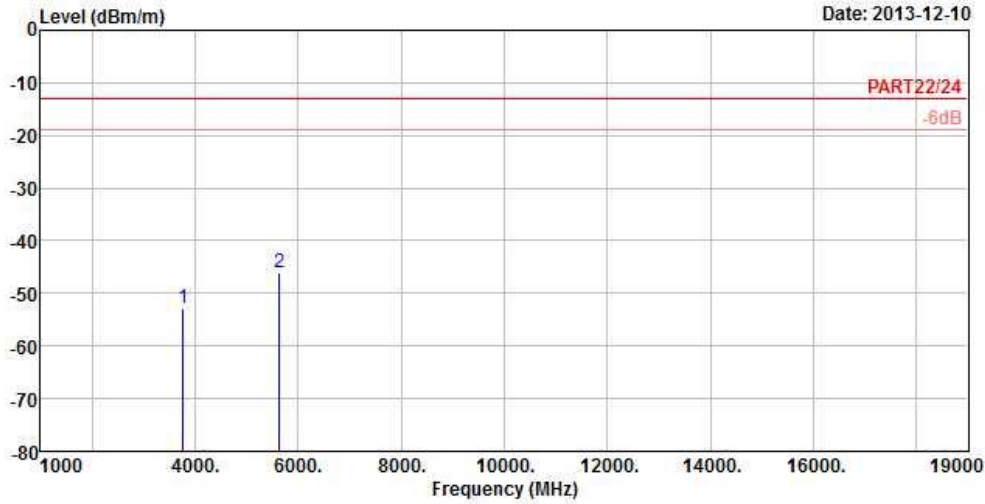

Site : 966 Chamber 5  
 Condition : PART22/24 3m VERTICAL  
 Brand/Model: G81-C6725  
 Remark : Band 25 5M QPSK(1,0) Link  
 Tested by : Johnosn Liao  
 Temperature : 25°C  
 Humidity : 65%  
 Plane : Z  
 Sample No : C131120-004-024-005

	Freq	Level	Read Level	Limit Line	Over Limit	Factor	Remark
	MHz	dBm/m	dBm	dBm/m	dB	dB/m	
1	3760.60	-52.81	-44.51	-13.00	-39.81	-8.30	Peak
2 pp	5640.90	-46.03	-44.13	-13.00	-33.03	-1.90	Peak



A D T

CHANNEL BANDWIDTH: 10MHz / QPSK



Bureau Veritas Consumer Products Services Ltd., Taoyuan Branch

A D T

Data: 11

Date: 2013-12-17

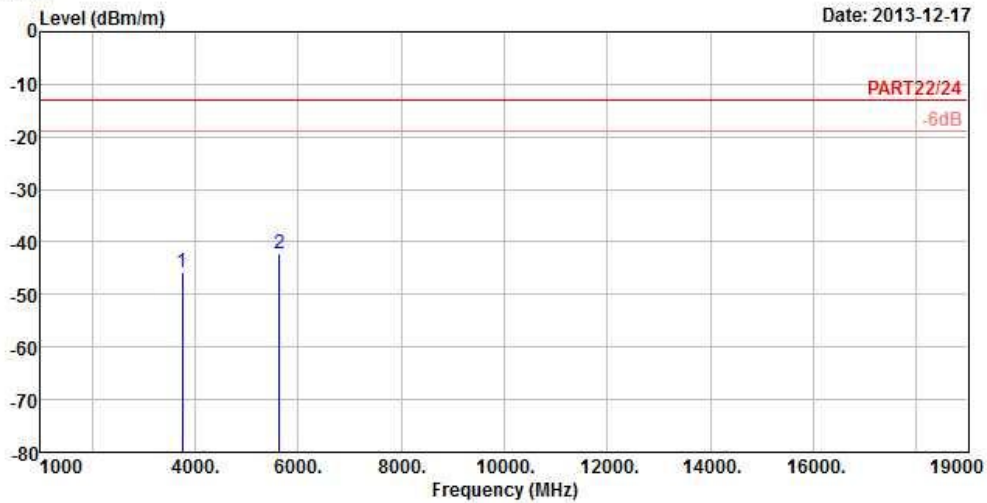

Site : 966 Chamber 5  
 Condition : PART22/24 3m HORIZONTAL  
 Brand/Model: G81-C6725  
 Remark : Band 25 10M QPSK(1,0) Link  
 Tested by : Johnosn Liao  
 Temperature : 25°C  
 Humidity : 65%  
 Plane : Z  
 Sample No : C131120-004-024-005

	Freq	Level	Read Level	Limit Line	Over Limit	Factor	Remark
	MHz	dBm/m	dBm	dBm/m	dB	dB/m	
1	3756.20	-45.73	-37.43	-13.00	-32.73	-8.30	Peak
2 pp	5634.30	-42.19	-40.29	-13.00	-29.19	-1.90	Peak



A D T



Bureau Veritas Consumer Products Services Ltd., Taoyuan Branch

A D T

Data: 12

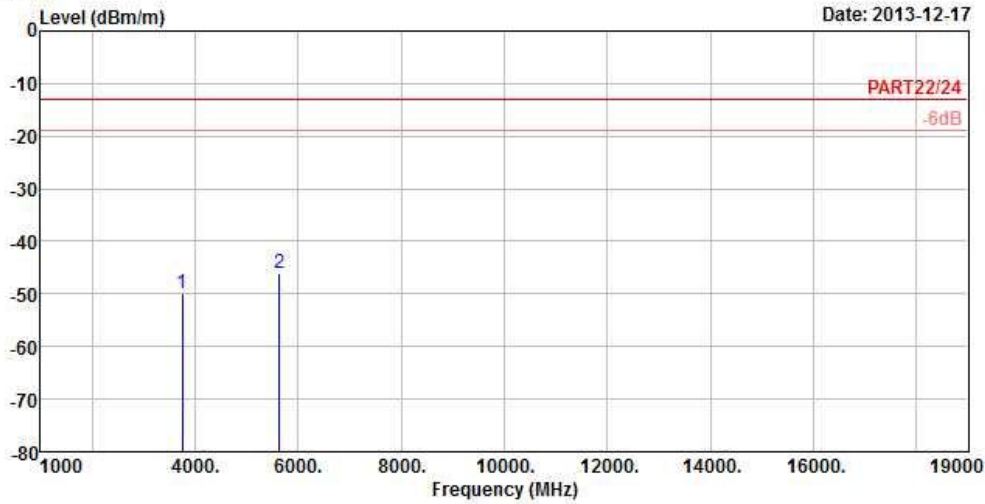

Site : 966 Chamber 5  
 Condition : PART22/24 3m VERTICAL  
 Brand/Model: G81-C6725  
 Remark : Band 25 10M QPSK(1,0) Link  
 Tested by : Johnosn Liao  
 Temperature : 25°C  
 Humidity : 65%  
 Plane : Z  
 Sample No : C131120-004-024-005

	Freq	Level	Read Level	Limit Line	Over Limit	Factor	Remark
	MHz	dBm/m	dBm	dBm/m	dB	dB/m	
1	3756.20	-49.83	-41.53	-13.00	-36.83	-8.30	Peak
2 pp	5634.30	-46.19	-44.29	-13.00	-33.19	-1.90	Peak

## 5 PHOTOGRAPHS OF THE TEST CONFIGURATION

Please refer to the attached file (Test Setup Photo).



## 6 INFORMATION ON THE TESTING LABORATORIES

We, Bureau Veritas Consumer Products Services (H.K.) Ltd., Taoyuan Branch, were founded in 1988 to provide our best service in EMC, Radio, Telecom and Safety consultation. Our laboratories are accredited and approved according to ISO/IEC 17025.

If you have any comments, please feel free to contact us at the following:

**Linko EMC/RF Lab:**

Tel: 886-2-26052180

Fax: 886-2-26051924

**Hsin Chu EMC/RF Lab:**

Tel: 886-3-5935343

Fax: 886-3-5935342

**Hwa Ya EMC/RF/Safety/Telecom Lab:**

Tel: 886-3-3183232

Fax: 886-3-3270892

**Email:** [service.adt@tw.bureauveritas.com](mailto:service.adt@tw.bureauveritas.com)

**Web Site:** [www.bureauveritas-adt.com](http://www.bureauveritas-adt.com)

The address and road map of all our labs can be found in our web site also.



A D T

## **7 APPENDIX A – MODIFICATIONS RECORDERS FOR ENGINEERING CHANGES TO THE EUT BY THE LAB**

No any modifications were made to the EUT by the lab during the test.

**---END---**