

EAPro[®]-Gateway

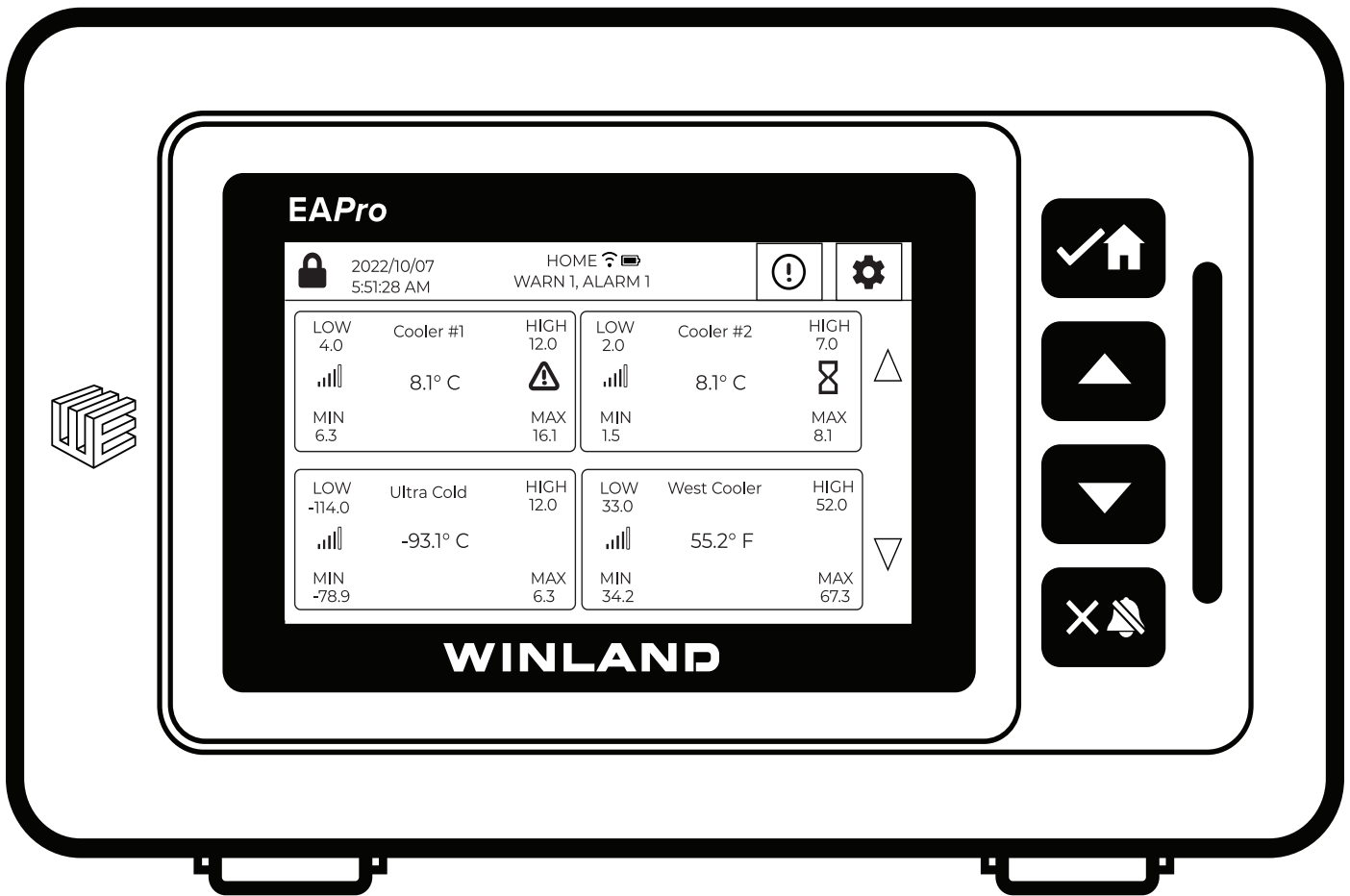

USER MANUAL

Limitations of the Alarm System or Device.

While your alarm system or device is reliable and sophisticated, it does not offer guaranteed protection against burglary, fire or other emergencies. Any security product, whether commercial or residential, is subject to compromise or failure-to-warn for a variety of reasons.

These include:

- Individuals may gain access through unprotected openings or have the technical sophistication to bypass an alarm sensor or disconnect an alarm warning device.
- Monitoring devices will not operate without power. Devices powered by AC will not work if their AC power supply is off for any reason. If the system has battery backup, batteries that are not maintained can fail to provide the necessary power for devices to function properly.
- Alarm warning devices such as sirens, bells, and horns may not alert people or awaken sleepers if they are located on the other side of closed or partly closed doors. If warning devices are on a different level of the residence from the bedrooms, they are less likely to awaken or alert people inside the bedrooms.
- Telephone lines needed to transmit alarm signals from a premises to a central monitoring station may be out of service, and are subject to compromise by sophisticated means of attack.
- Signals sent by wireless transmitters may be blocked or reflected by metal before they reach the alarm receiver. Even if the signal path has been recently checked during a weekly test, blockage can occur if a metal object is moved into the path.
- Even if the system responds to the emergency as intended and is a monitored alarm system, the authorities may not respond appropriately.
- This equipment, like other electrical devices, is subject to component failure.
- The most common cause of an alarm system not functioning properly is due to inadequate maintenance. Your alarm system should be tested weekly to make sure all detection devices are operating properly. Your control panel and keypads should be tested as well. Installing an alarm system may make you eligible for lower insurance rates, but an alarm system is not a substitute for insurance. Homeowners, property owners, and renters should continue to insure their lives and property.

Record of Revisions

REV NO.	DATE	DESCRIPTION
D-011-0177 Rev A	December 2022	Initial Issue
D-011-0177 Rev A.1	January 2023	Added USB Model to known to work (pg 61) Modified Radiating Power for US Sensor to 11.9 dBm (pg 65) Removed Channel 8 from RF Channels (pg 65)

Notice

This document will refer to [INSIGHT](#) throughout. [INSIGHT](#) is a cloud based platform for remote viewing and management of the EA800-ip device and the EAPro[®]-Gateway. [INSIGHT](#) is sold separately and is not required to use the EAPro[®]-Gateway. The EAPro[®]-Gateway, plus sensors, can be used in standalone mode, or along with [INSIGHT](#) in a connected mode. The EAPro[®]-Gateway monitors the environmental conditions detected by connected sensors and provides alarm signals when monitored conditions at any sensor exceeds the user-programmable set points. Winland [INSIGHT](#) provides complete real time cloud-based visibility of data from the EAPro[®]-Gateway monitored critical condition environments. The system's detailed and customized response protocols, data logs, and extreme flexibility, provide the fastest resolution of incidents by making the notification immediately actionable.

Note: As of firmware 22.12.29, the EAPro[®]-Gateway sends notifications to [INSIGHT](#), however [INSIGHT](#) does not send out notifications to text/emails as this time.

Page Left Blank

TABLE OF CONTENTS

Foreword	1
Safety Information	1
General Information	4
Overview	4
How to Use This Manual	5
Symbols On the Product or Manual Labeling	6
EAPro®-Gateway	8
Home Screen	10
Access Control	13
Connections	16
Configuration Parameters	17
Network Toggle	17
Sensor Programming and Parameter Descriptions	23
Relay Operation	25
Data Logs	26
Installation	28
Installation Tools and Supplies	28
Power Requirements	28
Mount the Rear Plate	29
Connecting Power	29
Initial Start-Up Procedure	30
Install Wired Sensors	31
Connect Wired Sensors	31
Install Wireless Sensor	32
Programming	35
Main Menu	35
Configure System	36
Add Sensor	37
Add User	40
Set System Time and Date Format	40
Set Date and Time	41
Set Lock Mode	41
Select RF Channel	42
Relays Trigger Status	42
Configure Relay State	42
Buzzer Triggers	43
Light Triggers	43
Operation	45
Acknowledge sensor reading or clear min/max	45
Clear Alarm or silence alarm	45
View Sensor Details	45
View Notification Log	46
View Event Log	46
View Sensor Logs	46
View User Logs	47
View About	47
Clear Notification Logs	47

Clear Sensor Logs	48
Export Logs	48
NOTIFICATION Logs	48
Maintenance	49
Edit Sensor	49
Replace Wireless Transmitter	55
Delete Sensor	55
Pause Sensor	55
Test Sensor	56
Edit User	57
Delete User	57
Configure User Mode	57
Sync Users	58
Save System Configuration	58
Edit Network Wi-Fi	59
Edit Ethernet Settings	60
Update Firmware	61
Factory Reset	62
Reboot System	63
Troubleshooting	64
Winland Technical Support	64
Specifications	65
Warranty and Service Information	68

LIST OF FIGURES

Figure 1: EAPro®-Gateway	4
Figure 2: EAPro®-Gateway Block Diagram	8
Figure 3: EAPro®-Gateway Front	8
Figure 4: Home Screen Sensor Tile	11
Figure 5: Home Screen Tile Examples	12
Figure 6: Connections	16
Figure 7: Network Toggles	18
Figure 8: Wiring Diagram for 4–20mA Sensor – PWR OUT Supply	21
Figure 9: Wiring Diagram for 4–20mA Sensor – External Power Supply	21
Figure 10: Wired Sensor Connection: Temperature Sensor, WaterBug®, and Dry Contact	31
Figure 11: Wired Sensor Connection: HA-III+	32
Figure 12: Wired Sensor Connection: 4–20mA	32
Figure 13: Wireless Models	33
Figure 14: Wireless Sensor MAC Address and ID Location	33
Figure 15: Wireless 4-20mA & 0-5V sensors	34
Figure 16: Main Menu Locked	35
Figure 17: Main Menu Unlocked	35

Page Left Blank

LIST OF TABLES

Table 1: Symbols on Product or Manual Labeling	6
Table 2: EAPro®-Gateway Parts: Description	9
Table 3: Icons on Touchscreen	10
Table 4: Home Screen Display	11
Table 5: Home Screen Sensor Tile	11
Table 6: Example of Sensor Status on Home Screen Tiles	12
Table 7: User Access Levels	14
Table 8: Lock Setting	15
Table 9: Connector Functions	16
Table 10: Configuration Parameters	17
Table 11: Wired Temperature Sensor	18
Table 12: Wired Humidity Sensor	19
Table 13: Wired Water Sensor	19
Table 14: Dry Contact Sensors	19
Table 15: Wireless Temperature Sensor	20
Table 16: Wireless Humidity Sensor	20
Table 17: Wireless Multi-Function Transmitter	20
Table 18: Voltage Selection Matrix for 4–20mA Sensors	22
Table 19: Sensor Programming Parameter Descriptions	23
Table 20: Relay Operation Conditions	25
Table 21: Data Log	26
Table 22: Troubleshooting	64
Table 23: Specifications: EAPro®-Gateway	65
Table 24: Specifications: Sensors	66
Table 25: Specifications: Accessories	66

Page Left Blank

FOREWORD

Please read this manual and all included material in its entirety before unpacking, installing, and operating your equipment.

The image on the front cover is representative only.

In order to prevent injury or equipment damage, everyone involved in installation, operating and maintenance of the products described in this manual must be qualified and trained in the current safety standards that govern their work.

Shock hazard—do not service the product or other electrical products without disconnecting power and tagging the circuits as out of service.

SAFETY INFORMATION

Warning on page 28.

WARNING

EAPro®-Gateway relay outputs are intended only for use as low voltage, low-current alarm connections, and not for direct switching or control of AC-mains powered loads. Additionally, local codes may further dictate or limit the types of loads and associated wiring to be used with the low-current Form C relay outputs used with the EAPro®-Gateway. Connecting AC-mains type circuits to the EAPro®-Gateway may result in an electric shock and/or fire hazard.

Connect only sensors specified in this manual to the wired and wireless input connections. Using sensors not specified in this manual may damage the EAPro®-Gateway or cause improper or unreliable operation.

Do not connect a load to OUTPUT 1 through OUTPUT 4 relay outputs that exceeds limitations stated in the [Specifications](#) section of this manual. Loads exceeding the specified limitations may damage the EAPro®-Gateway, or result in improper or unreliable operation.

The EAPro®-Gateway printed circuit board (PCB) contains electrostatic discharge (ESD) sensitive devices. To help prevent damage caused by ESD, observe appropriate ESD handling rules whenever the PCB in the EAPro®-Gateway is exposed.

Batteries shall not cause explosion or produce a fire hazard as a result of excessive charge or discharge, or if a battery is installed with incorrect polarity.

If the equipment is used in a manner not specified by the manufacturer, the protection provided by the equipment may be impaired.

Warning on page 47.

WARNING

Clearing the notification logs erases the information in the notification log. Clearing the notification log can result in data loss.

Warning on page 62.

WARNING

Resetting to factory defaults erases all data except the event logs. Resetting to factory defaults can result in data loss.

Caution statement page 7.

CAUTION

Per RSS-Gen, Section 8.4 This device complies with Industry Canada license-exempt RSS standard(s). Operation is subject to the following two conditions: (1) this device may not cause interference, and (2) this device must accept any interference, including interference that may cause undesired operation of the device.

To satisfy RF exposure requirements, this device and its antenna must operate with a separation distance of at least 20 cm from all persons.

Conformément au CNR-Gen, section 8.4 Cet appareil est conforme aux normes RSS d'Industrie Canada exemptes de licence. Le fonctionnement est soumis aux deux conditions suivantes : (1) ce dispositif ne peut pas causer de brouillage, et (2) ce dispositif doit accepter toute interférence, y compris les interférences qui peuvent causer un fonctionnement indésirable de l'appareil.

Pour satisfaire aux exigences d'exposition aux RF, cet appareil et son antenne doivent fonctionner avec une distance de séparation d'au moins 20 cm de toutes les personnes.

Caution on page 29.

CAUTION

Do not connect or disconnect power, sensor, or alarm wiring while power is applied. Connecting and disconnecting sensors or alarm wiring when power is applied to the EAPro®-Gateway may damage the EAPro®-Gateway or result in improper or unreliable operation.

Connection of unsuitable loads to the EAPro®-Gateway power connection may damage the power supply and EAPro®-Gateway, or result in improper or unreliable operation.

GENERAL INFORMATION

OVERVIEW

The EAPro[®]-Gateway monitors the environmental conditions detected by connected sensors and provides alarm signals when monitored conditions at any sensor exceeds the user-programmable set points. The alarm signals are provided via relay outputs that can operate with process controls, security systems, or other similar automated equipment. The EAPro[®]-Gateway system can be configured with wired or wireless sensors (sold separately).

The EAPro[®]-Gateway provides connection of up to 4 wired and up to 30 wireless sensors.

Setup and program the system using the touchscreen, through the [INSIGHT](#) cloud-based platform (sold separately) or by loading a CFG file. The touchscreen assists the user during local setup and displays the measured conditions of monitored environments during operation.

The EAPro[®]-Gateway can monitor for out of user specified set points environmental conditions using a wide array of hardwire and wireless sensors, multiple critical environments using multiple sensor inputs. The system features four output relays to indicate a warning condition exists or a programmed alarm limit has been exceeded. An auxiliary relay (AUX RELAY/POWER RELAY) can alert when any sensor, event, or user specified condition is in alarm status.

The EAPro[®]-Gateway monitors and provides warnings and alarms when using the appropriate Winland sensors (sold separately) for the following conditions:

- Temperature: from -100 °C to 150 °C (-148 °F to 302 °F)
- Humidity: from 5 to 95% RH (non-condensing)
- Presence of water
- Conditions monitored by a third-party sensor with a 0–5V or a 4–20mA output.

The EAPro[®]-Gateway (see Figure 1) may be mounted to a standard 3-gang electrical enclosure or directly to wall. The EAPro[®] wireless sensors are easily mounted to a wall.

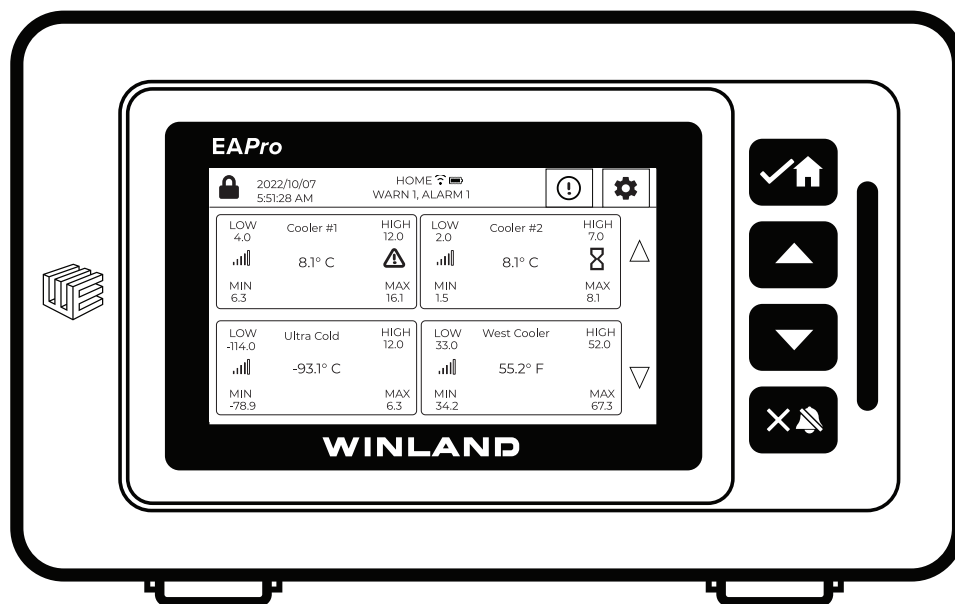

Figure 1: EAPro[®]-Gateway

Note: All product images shown are for illustration purposes only and may not be an exact representation of the product. Actual product may vary due to product modification, or software/firmware changes.

HOW TO USE THIS MANUAL

When viewed in electronic form, this manual contains internal and external links for quick navigation to sections and procedures. Click highlighted material to navigate within the document.

This manual is organized into sections that guide [Installation](#), [Programming](#), [Operation](#), and [Maintenance](#) of the EAPro®-Gateway system. Troubleshooting guidelines are also provided as well as [Specifications](#) and [Warranty and Service Information](#).

Note: The EAPro®-Gateway system can be programmed and operated remotely via [INSIGHT](#) (sold separately).

This manual presents programming procedures by showing the sequence of menus and screen displays to perform the procedure, and written instruction to advance through the procedure. The successive images (left to right) indicate the direction of procedure flow. Navigation includes using the touchscreen or using soft keys or a combination of both.

Below is an example of a procedure:

1. At the Home Screen, tap the lock icon.
2. Select USERNAME (“root” is default)
3. Enter 1234 or an assigned PIN (**Note:** 001234 is the same as 1234)
4. Tap **Confirm** to unlock.

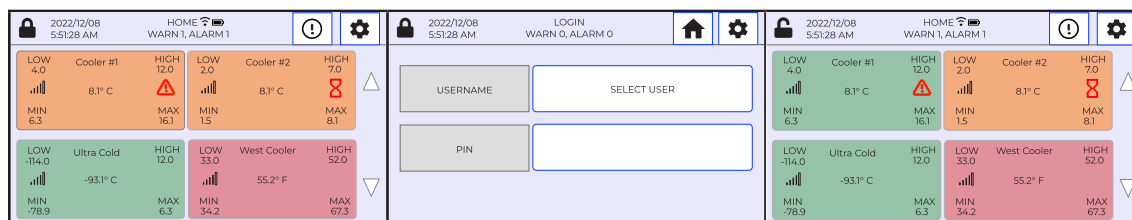

Throughout the manual:

- Buttons that appear on the touchscreen are shown like this: 
- Buttons often have a BLUE, RED, or GREEN outline depending on it's function.

BLUE: Indicates a button function for a user to select.

RED: Indicates a cancel or warning to proceed button.

GREEN: Indicates a confirm to proceed.



Note: When a BLUE outline button is pressed, it will often turn red for a moment to indicate the system recognizes your interaction.

- Quick links internal to the electronic document are shown like this: [Home Screen](#)
- Quick links to web pages from the electronic document are shown like this: [INSIGHT](#).

SYMBOLS ON THE PRODUCT OR MANUAL LABELING

Symbols appearing on the product labeling, packaging, and/or in this manual are shown and described in Table 1.

Table 1: Symbols on Product or Manual Labeling

SYMBOL	DEFINITION
	Attention, consult accompanying documents or statements.
	Please see reach.eapro.winland.com for further REACH Declaration of Conformity. For product disposal, ensure the following: Do not dispose of this product as unsorted municipal waste. Collect this product separately. Use collection and return systems available.
RoHS Compliant	Please see rohs.eapro.winland.com for further RoHS Declaration of Conformity
N.O.	Normally Open (N.O.) relay contact terminal.
C	Common relay contact terminal.
N.C.	Normally Closed (N.C.) relay contact terminal.
AUX RELAY / POWER RELAY	Combined single pole double throw (SPDT) relay output that activates upon an alarm from configurable setting. AUX RELAY and POWER RELAY terms may be used interchangeably.



<p>Model: EAPro®-Gateway • FCC ID: V5SEAPGTWY-0822 • IC: 7635A-EAPROGTWY</p> <p>Models: EAPro®-WMFT, EAPro®-WTS, EAPro®-WHS • FCC ID: V5SEAPWLSS-0822 • IC: 7635A-EAPROWS</p>	<p>This device complies with Part 15 of the FCC Rules. Operation is subject to the following two conditions: (1) This device may not cause harmful interference, and (2) this device must accept any interference received, including interference that may cause undesired operation.</p> <p>Per RSS-Gen, Section 8.4 This device complies with Industry Canada license-exempt RSS standard(s). Operation is subject to the following two conditions: (1) this device may not cause interference, and (2) this device must accept any interference, including interference that may cause undesired operation of the device. To satisfy RF exposure requirements, this device and its antenna must operate with a separation distance of at least 20 cm from all persons.</p> <p>Conformément au CNR-Gen, section 8.4 Cet appareil est conforme aux normes RSS d'Industrie Canada exemptes de licence. Le fonctionnement est soumis aux deux conditions suivantes : (1) ce dispositif ne peut pas causer de brouillage, et (2) ce dispositif doit accepter toute interférence, y compris les interférences qui peuvent causer un fonctionnement indésirable de l'appareil.</p> <p>Pour satisfaire aux exigences d'exposition aux RF, cet appareil et son antenne doivent fonctionner avec une distance de séparation d'au moins 20 cm de toutes les personnes.</p> <p>Caution Statement (per CFR 15.21): The user manual or instruction manual for an intentional or unintentional radiator shall caution the user that changes or modifications not expressly approved by the party responsible for compliance could void the user's authority to operate the equipment.</p> <p>Class B Product Compliance Statement (per CFR 15.105(b)): This equipment has been tested and found to comply with the limits for a Class B digital device, pursuant to Part 15 of the FCC Rules. These limits are designed to provide reasonable protection against harmful interference in a residential installation. This equipment generates, uses and can radiate radio frequency energy and, if not installed and used in accordance with the instructions, may cause harmful interference to radio communications. However, there is no guarantee that interference will not occur in a particular installation. If this equipment does cause harmful interference to radio or television reception, which can be determined by turning the equipment off and on, the user is encouraged to try to correct the interference by one or more of the following measures:</p> <ul style="list-style-type: none"> • Reorient or relocate the receiving antenna. • Increase the separation between the equipment and receiver. • Connect the equipment into an outlet on a circuit different from that to which the receiver is connected. • Consult the dealer or an experienced radio/TV technician for help.
	<p>The Eurofins MET Mark indicates national compliance by virtue of Eurofins' equivalent accreditations to UL and CSA. The Eurofins MET mark clearly indicates compliance to US and Canadian requirements</p>
	<p>The product is in conformity with all applicable requirements for its placing on the European Union market.</p>

Figure 2 shows a block diagram of the EAPro®-Gateway interfaces and functions. The EAPro®-Gateway provides four relays plus an auxiliary(AUX) relay. Program the four relays to indicate when a programmed alarm limit has been exceeded or a warning condition exists. The AUX relay provides an output signal for an optional audible alarm or strobe that is activated whenever any alarm condition exists. The EAPro®-Gateway may also be part of a larger security system.

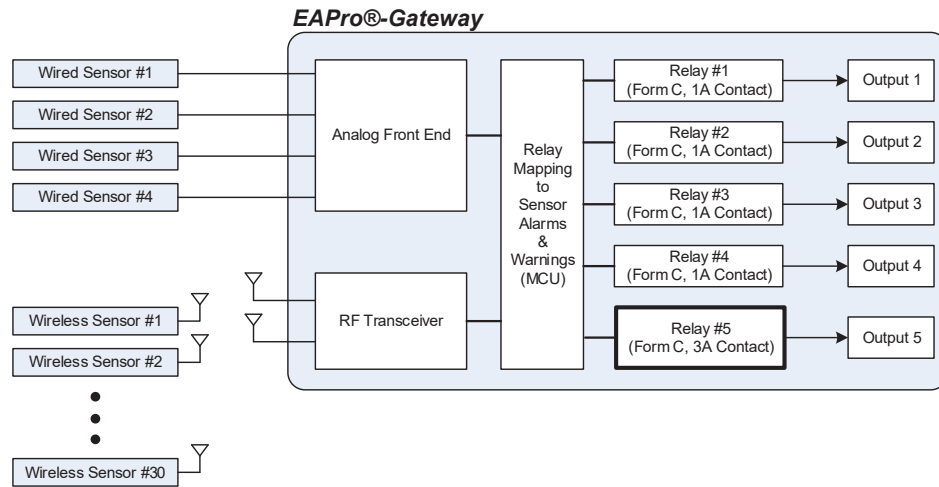

Figure 2: EAPro®-Gateway Block Diagram

EAPro®-GATEWAY

The EAPro®-Gateway features an interactive touchscreen and has four soft keys. A USB port is located on the right side for quick access. The rear is open for ease of routing wires. Once installed, unlatch and use hinge to swing down the front for easy maintenance. When the unit is hinged, the front can disconnect from it's base for portability during programmed if desired.

Parts and Functions

These topics illustrate the EAPro®-Gateway primary parts and key functions.

Note: All product images shown are for illustration purposes only and may not be an exact representation of the product. Actual product may vary due to product modifications.

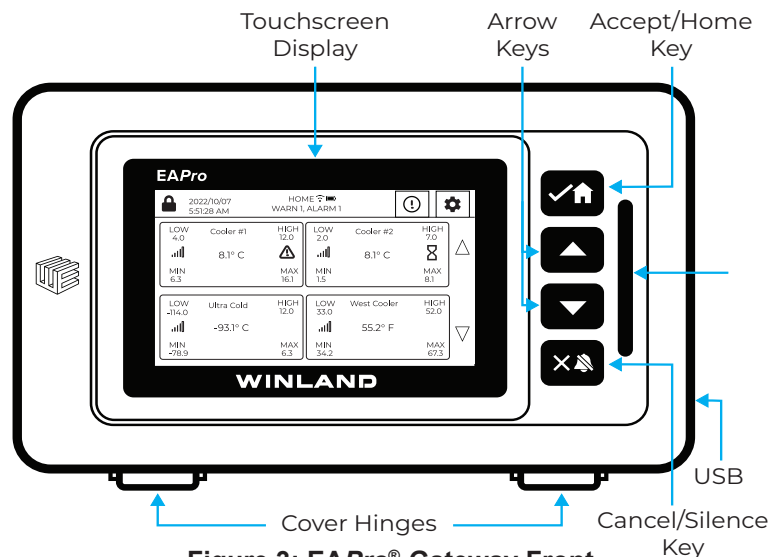





Figure 3: EAPro®-Gateway Front

Figure 3 shows the touchscreen and entry keys. The key functions are described in Table 2.

Table 2: EAPro®-Gateway Parts: Description

Part	Description/Function
Touchscreen Display	The touchscreen displays all the information needed for operation, such as the Home Screen with sensor status, navigation menus, and the date and time. The touchscreen provides menu based graphical user interface (GUI) tap navigation to all of the features and local data.
Accept/Home Key 	The Accept/Home key provides two functions when pressed: it accepts the currently entered selection or it displays the Home Screen. If the selection is a menu item, the selected item is accessed. If the current selection is an entered value, pressing the key accepts the entered value. If there is no selection made, pressing the key displays the Home Screen.
Up Arrow Key 	The up arrow key provides the scroll up function.
Down Arrow Key 	The down arrow key provides the scroll down function.
Cancel/Silence Key 	The Cancel/Silence key provides two functions when pressed: it cancels the current selection, or it temporarily silences alarms and stops light from flashing. If the selection is a value, the value is cleared. If there is no selection made, press and hold for 3 seconds the key will temporarily silence local audible alarms and deactivates a flashing light for ten minutes. If a new alarm originating from a different sensor occurs within this 10-minute period, the audible alarm and flashing lights are reactivated, and require another key press and hold of 3 seconds to silence the audible alarm and deactivate the flashing light. Note: Pressing the Cancel/Silence key does NOT reset the relay.
USB Port	See Connections.
Rear Mounting Plate	The rear mounting plate is connected with a hinge. The EAPro®-Gateway may be attached to a standard 3-gang electrical enclosure or mounted directly to a wall.
PWR IN	See Connections.
PWR OUT	See Connections.
Relay Inputs	See Connections.
Relay Outputs	See Connections.
Jumpers	See Connections.















Touchscreen Display

The EAPro®-Gateway features a menu based graphical user interface (GUI) on a touchscreen display. Tap icons (see Table 3) to navigate the touchscreen display or press soft keys to navigate up or down.

Icons on Touchscreen

Icons on the touchscreen indicate status and provide operational conditions. See Table 3.

Table 3: Icons on Touchscreen

SYMBOL	NAME	DEFINITION
	Lock	The touchscreen is locked when this displays in the upper left corner of the touchscreen. Tap icon to go to Login Screen.
	Unlock	The touchscreen is unlocked when this displays in the upper left corner of the touchscreen. Tap icon to lock touchscreen.
	Home	Tap the home icon to return to the Home Screen.
	Battery	The battery icon indicates the wireless sensor has a low battery.
	Information	The information icon is a quick key to access the Data Logs.
	Alarm	The alarm icon displays during active alarm conditions.
	Signal strength	The signal strength icon indicates the strength of the wireless connection. A greater number of bars indicates a stronger connection. The recommended connection is a strength of four or five bars. "ERR" will display in sensor reading if signal strength is zero bars.
	De-active	The de-active toggle indicates the option is deactivated.
	Active	The active toggle indicates the option is activated.
	Check/Accept	The Check/Accept icon is on the Accept/Home key.
	Time Delay Warning	The time delay warning icon indicates the sensor is in active time delay for a warning. The warning state is pending and the delay timer is counting down. A warning state will occur if the warning is not cleared before the timer runs out.
	Time Delay Alarm	The hourglass icon indicates the sensor is in active time delay for an alarm. The alarm state is pending and the delay timer is counting down. An alarm state will occur if the condition is not cleared before the timer runs out.
	Latched Relay Key	The key icon indicates the relay is latched.
	Gear	The gear icon is a quick key to access the Main Menu.
	Stop/Cancel	The stop or cancel icon stops a current function.

HOME SCREEN

The Home Screen displays operation information including, lock status, date and time, and sensor status data for four sensors. Tap the "home" icon from any screen to quickly navigate to the home screen. The Home Screen also has quick access buttons to Notification Log and the Main Menu.

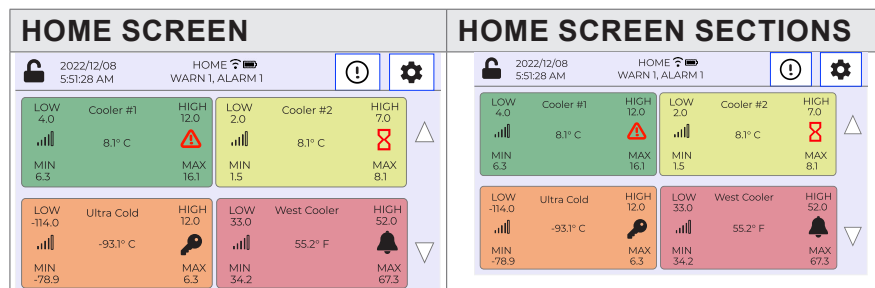

Table 4: Home Screen Display

NUMBER	NAME	DESCRIPTION
1	Lock/Unlock Icon	Tap and enter code to lock and unlock.
2	Date and Time	Current date and time. See Section 4-3 to change format.
3	Header Title	Navigation header.
4	Quick Access Buttons	Info exclamation icon is a quick access button for data menu. Gear icon is a quick access button for main menu.
5	Sensor Data	Operating sensor data. The tile color is a quick visual indication of operation status.
6	Navigation Arrows	Tap up arrow or down arrow to navigate to additional programmed sensors.

Home Screen Sensor Tile

A sensor tile (Figure 4) on the Home Screen provides operational sensor limits, sensor name, signal strength (if wireless sensor), current sensor reading, notification status, and overall min and max readings (Table 5). Sensor information is displayed within a tile. The color of the tile indicates the operational status, along with any notification icon.

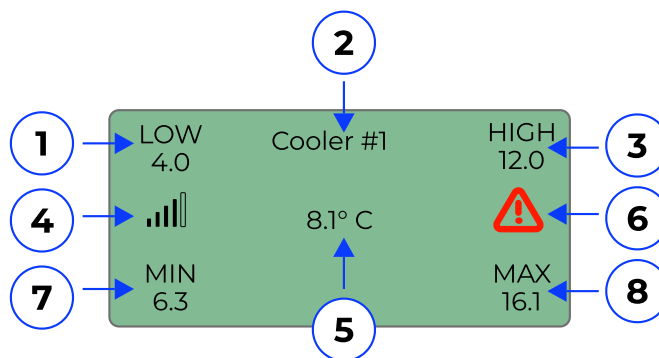

Figure 4: Home Screen Sensor Tile

Table 5: Home Screen Sensor Tile

NUMBER	NAME	DESCRIPTION
N/A	Tile Color	Tile color is a quick visual of operational status. Green: Operating within parameters Orange: Operating in warning status Yellow: Latched Operation Red: Is in alarm status
1	Low Alarm Limit	Low alarm limit is the lowest temperature setting at which, when exceeded and any time delay exceeded, the sensor would be in alarm status.
2	Sensor Name	Common or Custom name of sensor.
3	High Alarm Limit	High alarm limit is the highest temperature setting at which, when exceeded and any time delay exceeded, the sensor would be in alarm status.
4	Signal Strength Bars	Signal strength bars indicates connection to wireless sensor. "ERR" will display under sensor reading if signal strength is zero bars.

5	Sensor Reading	Current sensor reading. "ERR" will display under sensor when reading is beyond sensor limitations. An example of this is a cut or shorted wire.
6	Notification Icon	Notification icon is a quick visual of detailed operational status. Warning triangle: displays when in time delay for warning. Hourglass: displays when in time delay for alarm. Key icon: displays when the sensor is keeping the relay latched. Bell icon: displays when the sensor is in alarm.
7	Min Reading	Overall minimum sensor reading since last clear or reboot of device.
8	Max Reading	Overall maximum sensor reading since last clear or reboot of device.

Examples of Sensor Status on Home Screen

This section provides examples of sensor status as displayed in the tiles of the Home Screen. See Figure 5 and Table 6.

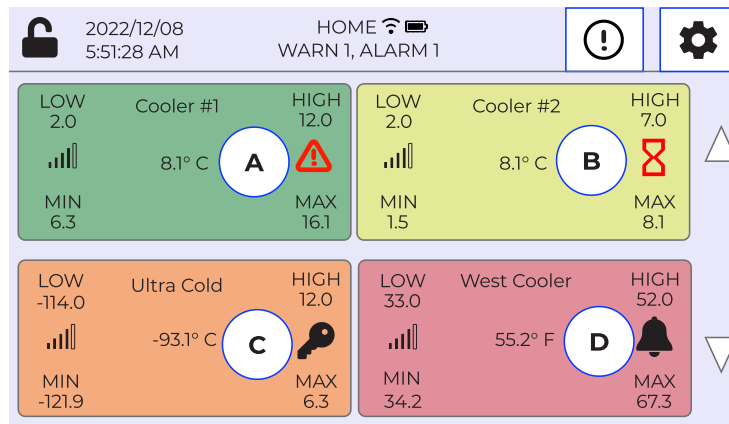

Figure 5: Home Screen Tile Examples

Table 6: Example of Sensor Status on Home Screen Tiles

LETTER (FIGURE 5)	TABLE 5 NUMBER	EXPLANATION
A		Tile color is green. The sensor is operating within parameters. There is a red warning icon, indicating that the warning set point has been hit. Since the tile is still green, it indicates that a time delay has been set for the warning.
	1 & 3	LOW and HIGH sensor settings for alarm limits: when the temperature is below 2.0 °C or above 12.0 °C the sensor would be in a pending alarm status based on a time delay, if there is no time delay the sensor would be in alarm status.
	4	Signal strength bars indicate connection to a wireless sensor.
	2 & 5	Sensor Name is Cooler #1 and Current Reading is 8.1 °C.

	6	Notification icon for sensor displays a warning triangle to indicate a time delay for a warning condition. (The temperature warning was set to 8.0 °C with a 20 minute time delay. The tile is green to indicate the time delay is under 20 minutes.) Note: <i>Warning set points are not placed on the sensor tile. Only alarm limit set points are placed on a sensor tile.</i>
	7 & 8	MIN is the lowest reading: 6.3 °C and MAX is the highest sensor reading 16.1 °C, since the sensor was programmed. NOTE: ERR readings can be discarded from this equation.
B	Condition is in a warning condition with pending alarm.	Tile color is yellow. The sensor is in a warning condition, with pending alarm icon.
	1 & 3	LOW and HIGH sensor settings for alarm limits: when the temperature is below 2.0 °C or above 7.0 °C the sensor is in a pending alarm status based on a time delay (time delay durations are not visible from the sensor tile), if there was no time delay, the sensor would be in an alarm status and if programmed, relays would trip.
	4	Signal strength bars indicate connection to a wireless sensor.
	2 & 5	Sensor Name is Cooler #2 and Current Reading is 8.1 °C.
	6	Notification icon shows there is a time delay set on the limit.
	7 & 8	MIN is the lowest reading 1.5 °C and MAX is the highest sensor reading 8.1 °C since the sensor was programmed.
C	Condition is within tolerance with a latched relay.	Tile color is orange. The status is back within limits, however a relay will indicate the system is still in alarm due to being latched. Note: <i>Latch relays need to be manually cleared. Typically for logging or to ensure someone validates everything is acceptable.</i>
	1 & 3	Low and High sensor settings: when the temperature is below -114.0 °C or above 12.0 °C. Currently the temperature is within range, but if tied to a local alarm panel, would indicate the system is still in alarm, due to the latched relay being uncleared manually. Note: <i>Holding the sensor tile will give the option to clear the alarm.</i>
	4	Signal strength bars indicate connection to a wireless sensor.
	2 & 5	Sensor Name is Ultra Cold and the current reading is -93.1 °C
	7 & 8	MIN is the lowest reading -121.9 °C and MAX is the highest sensor reading 6.3 °C.
	6	Notification icon for sensor displays a KEY icon to indicate a latched condition for the relay.
D	Condition is outside tolerance and is in alarm status.	Tile color is red. The status is active alarm condition.
	1 & 3	Low and High sensor settings: when the temperature is below 33.0 °F or above 52.0 °F.
	4	Signal strength bars indicate connection to a wireless sensor.
	2 & 5	Sensor Name is West Cooler and Current Reading is 55.2 °F
	7 & 8	MIN is the lowest reading 34.2 °F and MAX is the highest sensor reading 67.3 °F since the sensor was programmed.
	6	Notification icon for sensor displays BELL icon to indicate alarm status. A condition has been exceeded and any programmed time delay has been exceeded, sensor is in an active alarm status.

ACCESS CONTROL

The EAPro®-Gateway allows for auditing and logging capabilities through its user access levels. Access levels are defined as User, Admin and Root, with each allowing different access and permissions.

User Access

The EAPro®-Gateway allows up to 5 different users for logging through its direct interface. There is no limit to how many users can access the device remotely through INSIGHT to change settings.

Password of the Day (PotD)

Technicians have the option to use the Password of the Day. PotD allows for nearly root access to troubleshoot, program and edit sensors. Factory Reset is not allowed through PotD.

As of firmware 22.12.29, PotD is not active.

User Access Level

Users are assigned to one of three access levels for security. Users may be assigned a Personal Identification Number (PIN) to allow and record actions (see Table 7). Additionally, users may receive notifications for remote monitoring capabilities.

Table 7: User Access Levels

SECURITY LEVEL	READ	WRITE	DELETE	FACTORY RESET
User	Yes	No	No	No
Admin	Yes	Yes	Yes	No
Super Admin	Yes	Yes	Yes	Yes

User, Admin, and Super Admin activities are recorded in the User Logs. A list of Users and their access levels can be found in the User Log.

Users are identified in the Event Log and User Log by their Username. Username is often first name or last name, on INSIGHT usernames are typically an email address. The EAPro®-Gateway allows a PIN to have a 4–6 digit numeric code that offers an additional layer of security to perform activities.

User information may be entered at the EAPro®-Gateway or via [INSIGHT](#) (sold separately). Once entered at either location, Sync Users to quickly maintain system users.

Note: As of firmware 22.12.29, this feature is not enabled.

PIN

Users are assigned a PIN (personal identification number) as an added level of security to authorize different functions and to record who performed a given task. User PINs are 4–6 digit numeric codes assigned in the Add User procedure.

Login Screen

System security requires users to login with registered credentials. The default username is “root”. The root PIN is 001234. The root PIN can be changed but **CANNOT** be deleted.

1. Tap the drop-down to select username.
2. Tap into box to enter PIN.
3. Tap **ENTER** to log in.

Note: System logins are recorded in the User Log.

Note: 001234 is the same as 1234

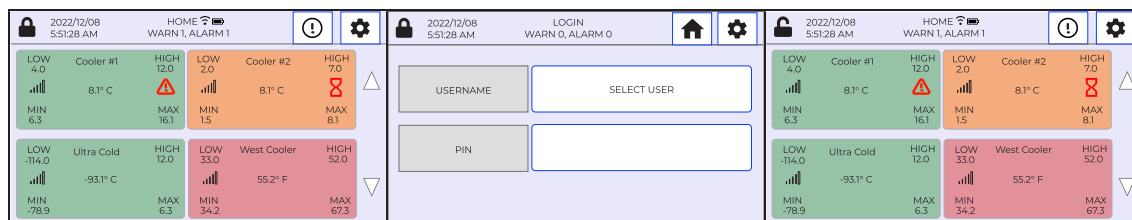

Local Lock Setting

Note: As of firmware 22.12.29, this feature is limited.

The EAPro®-Gateway provides three progressive lock settings for access control (see Table 8). See Set Lock Mode to configure the lock setting.

Table 8: Lock Setting

LOCK LEVEL	LOCK AFTER ACTIVITY	ON BOOT	LOCK SETTINGS
No Lock	Remains unlocked after any activity.	EAPro®-Gateway is unlocked.	Few screens require PIN to modify setting: Factory Reset Configuration Change
Limited Lock	Locks after 10 minutes of inactivity.	EAPro®-Gateway is locked.	MENU to most screens are locked by default.
Full Lock	Locks after 5 minutes of inactivity.	EAPro®-Gateway is locked.	Certain settings require PIN even when unlocked.
			"CLEAR HIGH/LOW" "ACKNOWLEDGE" "SILENCE" "PAUSE"
			Cancel/Silence key does not clear any relays.

No Lock

In the No Lock level, the EAPro®-Gateway is unlocked on boot up and remains unlocked after any activity. Full access is permitted to view and modify sensors, data, and users. A PIN is required to perform a factory reset. This may be used in home installations, where security is physical and user logging in not necessary or wanted.

The Open Lock icon is displayed in the upper left corner of the touchscreen to indicate the EAPro®-Gateway is unlocked. Tap the Open Lock icon to restrict unauthorized or unintended programming changes, log downloads, and firmware uploads.

Limited Lock

In the Limited Lock level, the EAPro®-Gateway is locked on boot up and locks after 15 minutes of inactivity (no touchscreen or key activity). Access to some menus and screens is restricted to view only. A PIN is required to access some settings and to make configuration changes.

The Closed Lock icon is displayed in the upper left corner of the touchscreen to indicate the EAPro®-Gateway is locked. Tap the Closed Lock icon and enter a PIN to access restricted options.

Full Lock

In the Full Lock level, the console is locked on boot up and the EAPro®-Gateway locks after 5 minutes of inactivity (no touchscreen or key activity). Access to most menus and screens is restricted to view only and must be unlocked. A PIN is required to modify most settings and to

make configuration changes.

The Closed Lock icon is displayed in the upper left corner of the touchscreen to indicate the EAPro®-Gateway is locked. Tap the Closed Lock icon and enter a PIN to access restricted options.

CONNECTIONS

Figure 6 Connections shows the EAPro®-Gateway connections and Table 9 describes the function of each connection. The EAPro®-Gateway has four output relays and one auxiliary (AUX) relay.

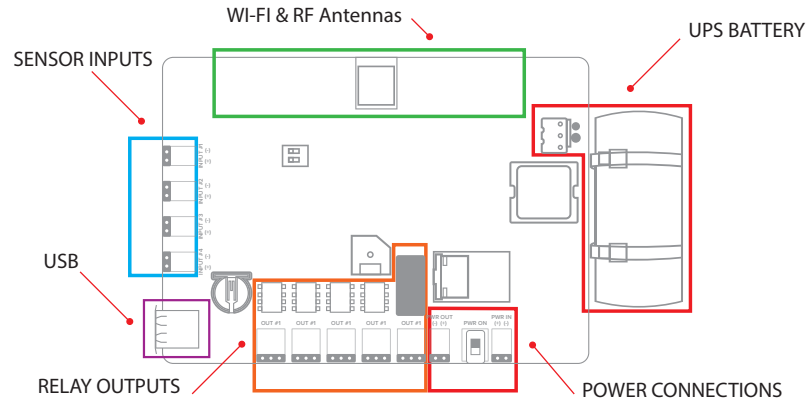

Figure 6: Connections

Table 9: Connector Functions

SECTION	DESIGNATION	FUNCTION
USB	USB	USB Type A connection used to update firmware, export logs, and export and import configuration files.
POWER CONNECTIONS	PWR IN	12–24 VDC input power connection for EAPro®-Gateway (from accessory power supply or alarm panel). CAUTION: Observe (+) and (-) polarity markings on circuit board. EAPro®-Gateway can be damaged if power polarity is reversed.
	PWR ON	Toggle switch to enable and disable power without disconnecting terminal block. Toggle “UP” toward RJ45 connector is “ON”,
	PWR OUT	12–24 VDC power out connection for EAPro®-Gateway accessories requiring power (such as HA-III+ Humidity Alert). This output voltage equals that of Power In and is current limited to a maximum of 100mA via an internal Positive Temperature Coefficient (PTC). CAUTION: Connect only accessories specified in this manual to the Power Out connection. Connection of unsuitable loads to this connection may damage the power supply and EAPro®-Gateway, or result in improper or unreliable operation. Note: Accuracy for the HA-III+ sensor is specified at 12VDC. The accuracy of the HA-III+ is compromised if Power Out powers the HA-III+ and is above 12VDC.
RELAY OUTPUTS	OUT #1	Form C relay alarm output for Relay 1.
	OUT #2	Form C relay alarm output for Relay 2.
	OUT #3	Form C relay alarm output for Relay 3.
	OUT #4	Form C relay alarm output for Relay 4.
	AUX OUT	Form C relay output that activates upon an alarm from any of the sensors.

Wi-Fi & RF Antenna	Wi-Fi Antenna	Receive and transmit 2.4Ghz data.
	RF Antenna	RF receive and transmit.

CONFIGURATION PARAMETERS

Configuring the settings consists of selecting a format for date and for time, and selecting an RF channel as outlined in Table 10.

Table 10: Configuration Parameters

PARAMETER	OPTIONS	FACTORY DEFAULT	DESCRIPTION
Date Format	YYYY-MM-DD	MM-DD-YYYY	Sets the desired date format for all event time stamps.
	MM-DD-YYYY		
	D.M.YY		
	DD.MM.YY		
	DD.MM.YYYY		
	YYYY/MM/D		
	m/d/YY		
	m/d/YYYY		
Time Format	HH:MM:SS	HH:MM:SS	Sets the desired time format for all event time stamps.
	HH:MM:SS XM		
	HH:MM		
	HH:MM XM		
	EPOCH		
RF Channel	CH0 (2405 MHz)	CH5 (2466 MHz)	Selects the ISM band radio frequency (RF) channel for transmission between the wireless sensors and gateway.
	CH1 (2414 MHz)		
	CH2 (2427 MHz)		
	CH3 (2440 MHz)		
	CH4 (2453 MHz)		
	CH5 (2466 MHz)		
	CH6 (2479 MHz)		

NETWORK TOGGLE

The EAP^{ro}-Gateway has a DIP switch to enable Wi-Fi and Ethernet connection. Any changes made to the DIP switch during power on operations will require the device to be rebooted before the changes to into effect.

Note: It is recommended only to have one toggled enabled.

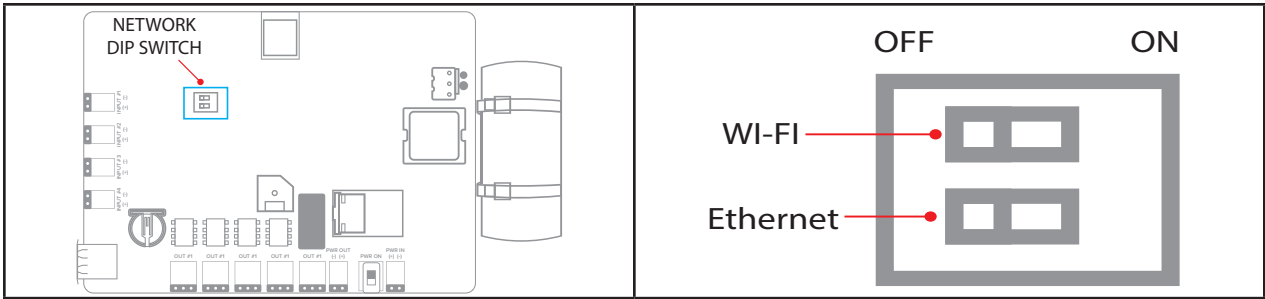

Figure 7: Network Toggles

SENSORS

The EAPro®-Gateway accepts a variety of sensors to provide environmental status and information. These include wired and EAPro® wireless sensors for conditions that include temperature, humidity, and the presence of water. Additional options include dry contact closure sensors and the use of industry standard 0–5V, and 4-20mA sensors.

The EAPro®-Gateway averages sensor readings to avoid false readings and to ensure dramatic spikes are avoided due to wiring noise or an unexpected wiring ground during operations.

Note: Sensors can be programmed to a specific relay, or to multiple relays based on different conditions, such as an exceeded high alarm limit or an exceeded low alarm limit.

Hardwired Sensors

Wired sensors can be Winland Temperature Sensor, Winland Humidity Sensor, Winland Water Supervised Sensor, Dry Contact Sensor, 0-5V or a 4–20mA Sensor.

Each hardwired input is parsed every 2 seconds and averaged over 5 cycles. The average is rolled with each cycle.

Wired Temperature Sensor

Wired temperature sensor options include sensors for high, low, and ultra-low temperature ranges (see Table 11). Sensor options are stainless steel and waterproof.

Note: The Wireless Multi-Function Transmitter (EAPro®-WMFT) accepts the wired temperature probes for wireless monitoring.

Table 11: Wired Temperature Sensor

MODEL	DESCRIPTION	OPERATING RANGE/PARAMETERS
TEMP-H-S	Thermistor, stainless steel, Red Range Sensor	32 °F to 302 °F (0 °C to 150 °C)
TEMP-H-W	Thermistor, waterproof, Red Range Sensor	32 °F to 221 °F (0 °C to 105 °C)
TEMP-L-S	Thermistor, stainless steel, Blue Range Sensor	-58 °F to 158 °F (-50 °C to 70 °C)
TEMP-L-W	Thermistor, waterproof, Blue Range Sensor	-58 °F to 158 °F (-50 °C to 70 °C)
TEMP-UL-S	Thermistor, stainless steel White Range Sensor	-148 °F to 32 °F (-100 °C to 0 °C)
EAPro-ULS	PT1000, stainless steel sensor	-148 °F to 257 °F (-100 °C to 125 °C)

Wired Humidity Sensor

Select the HA-III+ humidity sensor for wired humidity sensing applications (Table 12).

Table 12: Wired Humidity Sensor

MODEL	DESCRIPTION	OPERATING RANGE/PARAMETERS
HA-III+	Wired humidity sensor	5 to 95% RH (non-condensing)

Wired Supervised Water Sensor

Select the WaterBug® supervised water sensor for wired water sensing applications (Table 13).

Table 13: Wired Water Sensor

MODEL	DESCRIPTION	OPERATING RANGE/PARAMETERS
W-S-S	Supervised water sensor	N/A

Note: Wired water sensors require that at least one supervised water sensor (W-S-S) be used. Up to five additional unsupervised water sensors (W-S-U) may be added in parallel on the same input where the supervised water sensor is configured.

Note: The Wireless Multi-Function Transmitter accepts the WaterBug® supervised water sensor (W-S-S). When connected to the Wireless Multi-Function Transmitter, the W-S-S **CANNOT** be used with additional supervised (W-S-S).

Dry Contact Sensor

The EAPro®-Gateway accepts industry dry contact sensors (Table 14).

Table 14: Dry Contact Sensors

MODEL	DESCRIPTION	OPERATING RANGE/PARAMETERS
N/A	N.O. (Normally Open Dry Contact)	Normally Open dry contact such as door contacts, motion detectors, and glass break detectors.
N/A	N.C. (Normally Closed Dry Contact)	Normally Closed dry contact such as door contacts, motion detectors, and glass break detectors.

Wireless Sensors

Winland's EAPro® wireless sensors transmit to the EAPro®-Gateway through RF links. Each EAPro® wireless sensor is hard coded with a serial number which the EAPro®-Gateway uses to identify that sensor in the system. The serial number is printed on a label affixed to the wireless sensor printed circuit board.

Wireless transmitters send out data every 30 seconds and is averaged over 5 cycles.

The wireless sensors are fully supervised for both communication drop out and low battery condition. The power relay can be configured to give a low-battery indication (see Configure Relays). The wireless sensor's assigned relay will change state if communication drops out for more than 5 cycles.

Note: Each cycle is 30 seconds, approximately 3 minutes and 30 seconds for an RF disconnect. It will take 3 cycles for alarm to clear, approximately 1 minute and 30 seconds for a reconnect to disable and RF disconnect alarm.

Wireless sensors options include temperature (EAPro®-WTS) or humidity (EAPro®-WHS). Wired sensors can be wired to a wireless multi-function transmitter (EAPro®-WMFT).

Note: The EAPro®-Gateway is **NOT** compatible with older models of Winland wireless sensors, such as the EA-WTS, EA-WHS, and the EA-WMFS.

Wireless Temperature Sensor

EAPro®-WTS (wireless temperature sensor) is a standalone wireless sensor for temperature (Table 15). This sensor **CANNOT** be placed inside coolers or freezers (non-condensing environmental only).

Note: To monitor coolers and freezers use a wired temperature sensor (Table 11), or use a wireless multi-function transmitter (Table 17) with a waterproof temperature sensor (Table 11).

Table 15: Wireless Temperature Sensor

MODEL	DESCRIPTION	OPERATING RANGE/PARAMETERS
EAPro®-WTS	Standalone wireless temperature sensor. Not for use in coolers or freezers (non-condensing environmental only).	32 °F to 122 °F (0 °C to 50 °C)

Wireless Humidity Sensor

EAPro®-WHS (wireless humidity sensor) is a standalone wireless sensor for humidity (Table 16). The wireless humidity sensor **CANNOT** be placed inside coolers or freezers (non-condensing environmental only).

Table 16: Wireless Humidity Sensor

MODEL	DESCRIPTION	OPERATING RANGE/PARAMETERS
EAPro®-WHS	Standalone wireless humidity sensor. Not for use in coolers or freezers.	5 to 95% RH (non-condensing)

Wireless Multi-Function Transmitter

The EAPro®-WMFT (wireless multi-function transmitter) requires a wired probe or wired sensor for operation (Table 17).

Note: To monitor coolers and freezers use a Wired Temperature sensor with a Wireless Multi-Function Transmitter.

Table 17: Wireless Multi-Function Transmitter

MODEL	DESCRIPTION	OPERATING RANGE/PARAMETERS
EAPro®-WMFT	Wireless transmitter for sensors.	Dependent on connected probe or sensor, including: Temperature (Wired Temperature Sensor) Water (Wired Water Sensor) Dry Contact (Dry Contact Sensor) 0-5V Sensors (third-party) 4-20mA Sensors (third-party)

4–20mA Sensor

The EAPro®-Gateway accepts hardwired industry standard 4–20mA sensors. Before installing, it is important to verify that this type of sensor will operate properly over the entire output range.

Operation Diagrams

Figure 8 shows an example of the loop circuit for a 4–20mA sensor whose minimum operating voltage is 8V or less when connected to an EAPro®-Gateway that is powered with 12VDC.

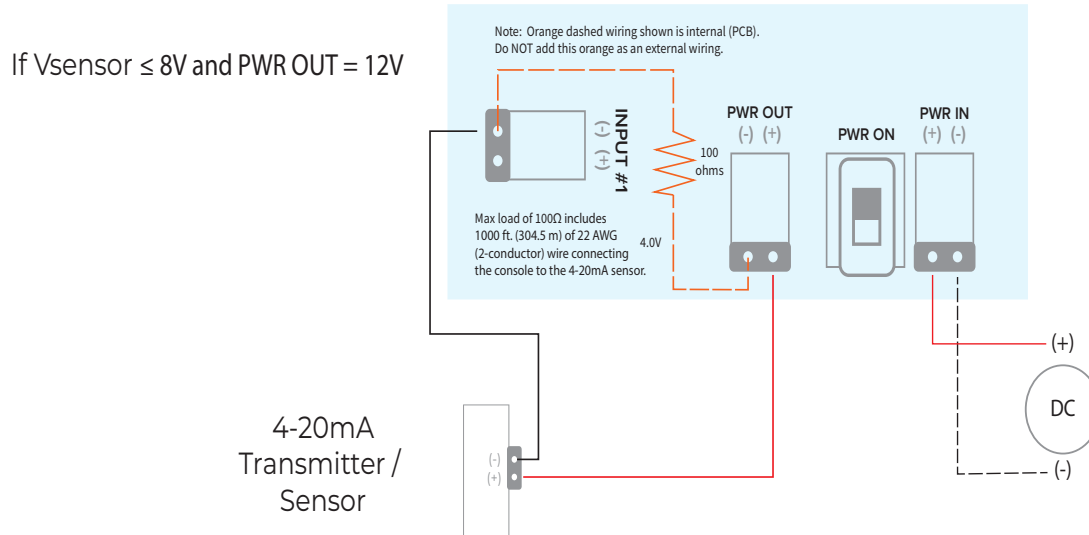

Figure 8: Wiring Diagram for 4–20mA Sensor – PWR OUT Supply

Figure 9 shows an example of the loop circuit for a 4–20mA sensor whose minimum operating voltage is greater than 8V when connected to an EAPro®-Gateway that is powered with 12VDC. This requires an external power supply for the 4-20mA sensor due to 4

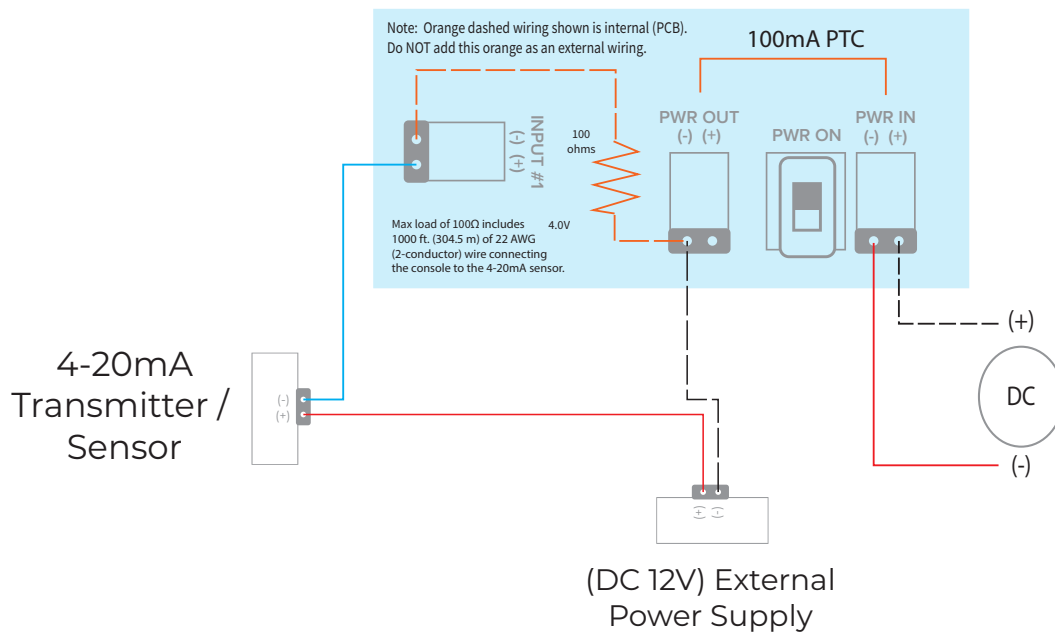

Figure 9: Wiring Diagram for 4–20mA Sensor – External Power Supply

Power Supply / Sensor Voltage Selection

To determine the power supply voltage required for correct full-scale operation of a given 4–20mA sensor, first identify all of the voltage drops within the current loop.

Figure 7 and Figure 8 each show a drop of 4.0 VDC which is the voltage drop generated by connecting the 4–20mA sensor to the EAPro®-Gateway using 1000' of 22 AWG wire.

To determine the power supply voltage, add the minimum operating voltage to the 4.0V voltage drop of the EAPro®-Gateway (plus wire). Then calculate the entire operating range to ensure correct full-scale operation.

Example:

Assume a 4–20mA sensor with an operating input voltage range of 10–30V is selected for use. The minimum operating voltage of the sensor is 10V (V_{sensor}). When the 4.0V drop of the EAPro®-Gateway (and wire) is added, at least 14VDC is needed to power the loop.

If the EAPro®-Gateway is connected to a 12VDC power supply, the sensor in the example now requires an external power supply of at least 16V as shown in Figure 29.

It is important not to exceed the maximum operating voltage of the 4–20mA sensor as specified within the sensor’s product specification.

The following formula provides the basis for the voltage selection matrix shown in Table 18.

$$R_L \leq (V_{cc} - x).023$$

where:

R_L = Loop resistance of 100Ω

V_{cc} = Power supplied to EAPro®-Gateway or PWR OUT

X = Sensor voltage (max)

Reference Table 18 to select either the proper sensor rating to be used with a known power supply, or to select a power supply for a known sensor rating.

Table 18: Voltage Selection Matrix for 4–20mA Sensors

POWER SUPPLIED TO EAPro®-GATEWAY OR PWR OUT	V_{SENSOR} (MAX) [MAXIMUM SENSOR VOLTAGE RATING]
11 VDC	7 VDC
12 VDC	8 VDC
13 VDC	9 VDC
14 VDC	10 VDC
15 VDC	11 VDC
16 VDC	12 VDC
17 VDC	13 VDC
18 VDC	14 VDC
19 VDC	15 VDC
20 VDC	16 VDC
21 VDC	17 VDC
22 VDC	18 VDC
23 VDC	19 VDC
24 VDC	20 VDC
25 VDC	21 VDC
26 VDC	22 VDC

SENSOR PROGRAMMING AND PARAMETER DESCRIPTIONS

This section provides a description of each sensor parameter (see Table 19) for sensor programming.

Table 19: Sensor Programming Parameter Descriptions

PARAMETER	APPLICABLE SENSORS	DESCRIPTION
Type	Hardwired Sensors	TEMP-L-S (BLUE) TEMP-L-W (BLUE) TEMP-H-S (RED) TEMP-H-W (RED) TEMP-UL-S (WHITE) HA-III+ (HUMIDITY) EAPro-ULS (RDT PT 1000) (CUSTOM) WaterBug N.O. N.C. 4–20mA (CUSTOM) 0–5 VOLTS (CUSTOM)
	Wireless Sensors	BLUE WHITE RED NORMALLY OPEN NORMALLY CLOSED PS-110 4–20mA (CUSTOM) 0-5 VOLTS (CUSTOM)
	Custom	0–5V 4–20mA RTD PT1000 (unit does NOT accept PT100 sensors)
Sensor Name	All Sensors	A name to identify the sensor in the alarm system for the viewer. The sensor name is displayed on the View Sensors screen. Two name choice types are available: Common Name: These are preprogrammed names, including: Cooler Freezer Fridge Warehouse Storage Door Water Custom Name: Enter any name if the preprogrammed common names do not adequately identify the sensor in the system (limited to 16 characters). Note: Duplicate sensor names are not permitted.
Unit of Measure	Wired Temperature Sensor	°F (Fahrenheit), °C (Celsius)
	Wireless Temperature Sensor	°F (Fahrenheit), °C (Celsius)
	0–5V 4–20mA Sensor	Common units of measure: °F (Fahrenheit), °C (Celsius), K (Kelvin), % RH (percent relative humidity), psi (pounds per square inch), Pa (Pascals), kPa (kilo Pascals), lb (pound), kg (kilogram)
		Custom units of measure: Enter the appropriate units for the connected 4–20mA sensor via the keypad.

Collection Frequency	All Sensors	<p>Sets the interval for collecting and recording data from the sensors. The data collection frequency is set per sensor. The system provides approximately 30,000 collected data regardless of the frequency selected. The estimated time duration covered for each data collection frequency is for one sensor:</p> <p>30 seconds = 10 days 1 minute = 20 days 5 minutes = 104 days 10 minutes = 208 days 15 minutes = 10 months 20 minutes = 13.5 months 30 minutes = 20.5 months 60 minutes (1 hour) = 3.4 years 120 minutes (2 hours) = 6.9 years 240 minutes (4 hours) = 13.8 years 360 minutes (6 hours) = 20 years</p> <p>Note: View Table 21 for more detail</p>															
Resolution	4–20mA Sensor	<p>Resolution determines the range that may be used for the 4–20mA sensor. The full scale range is determined by the values entered in the 4mA value and the 20mA value. Select the correct resolution to set the true range limits for the sensor. The available values are as follows:</p> <table border="1"> <thead> <tr> <th>Resolution</th> <th>Max 4mA</th> <th>Min 20mA</th> </tr> </thead> <tbody> <tr> <td>1.0</td> <td>-9999.</td> <td>+9999.</td> </tr> <tr> <td>0.1</td> <td>-999.9</td> <td>+999.9</td> </tr> <tr> <td>0.01</td> <td>-99.99</td> <td>+99.99</td> </tr> <tr> <td>0.001</td> <td>-9.999</td> <td>+9.999</td> </tr> </tbody> </table>	Resolution	Max 4mA	Min 20mA	1.0	-9999.	+9999.	0.1	-999.9	+999.9	0.01	-99.99	+99.99	0.001	-9.999	+9.999
Resolution	Max 4mA	Min 20mA															
1.0	-9999.	+9999.															
0.1	-999.9	+999.9															
0.01	-99.99	+99.99															
0.001	-9.999	+9.999															
4mA Value	4–20mA Sensor	This parameter equals the environmental reading that results in a sensor output of 4mA or its minimum valid reading. This is dependent on the setting of the resolution as discussed above.															
20mA Value	4–20mA Sensor	This parameter equals the environmental reading that results in a sensor output of 20mA or its minimum valid reading. This is dependent on the setting of the resolution as discussed above.															
Hysteresis	Wired Temperature Sensor	Hysteresis helps prevent alarms from being set and reset continually if the environment is at or near the alarm set point by providing an acceptable variance. Example: If hysteresis is set at 2 and the sensor high limit is set at 50, the sensor reading must decrease to 48 (50 minus 2) for the alarm condition to reset to a no-alarm condition.															
	Wireless Temperature Sensor																
	Wired Humidity Sensor																
	Wireless Humidity Sensor																
	0–5V 4–20mA Sensor																
Low Alarm Limit	Wired Temperature Sensor	The value that when exceeded, trips the low alarm.															
	Wireless Temperature Sensor																
	Wired Humidity Sensor																
	Wireless Humidity Sensor																
	0–5V Sensor 4–20mA Sensor																
High Alarm Limit	Wired Temperature Sensor	The value that when exceeded, trips the high alarm.															
	Wireless Temperature Sensor																

	Wired Humidity Sensor	
	Wireless Humidity Sensor	
	0–5V 4–20mA Sensor	
Alarm Time Delay	All	A period of time that an alarm condition can exist before the alarm is triggered. This helps to prevent false alarms in situations where normal activities cause conditions to temporarily exceed alarm thresholds. Example: The temperature in a freezer may temporarily rise above the high alarm limit while the freezer door is open for restocking. The Alarm Time Delay prevents the alarm trip until the delay time is exceeded thus allowing the door to be closed and the temperature to be re-cooled. Note: When temperature monitoring is critical, such as pharmaceuticals, use TEMP-G-B and TEMP-B-T to stabilize temperature around probe.
Buzzer (audible alarm)	All	Enables and disables the buzzer when an alarm limit has been exceeded or a warning condition exists. WARNING Selecting Disable for this parameter completely turns off the audible alarm buzzer. No audible alarm tone will sound when an alarm occurs when DISABLE is selected.
Light (visual alarm)	All	Enables and disables the visible flashing light when an alarm limit has been exceeded or a warning condition exists. WARNING Selecting Disable for this parameter completely turns off the visible alarm. No visible alarm light will flash when an alarm occurs when DISABLE is selected.
Relay	All	Enables which relay(s) are tripped based on setpoint(s).

RELAY OPERATION

This section describes the operation of the relays in the EAPro®-Gateway. Relays are programmed to provide the desired signal to the alarm panel. Relays are not programmed to a specific sensor, instead they provide an alarm for a specific condition such as an exceeded high alarm limit or an exceeded low alarm limit.

The default operation of a relay is de-energized (Table 20). De-energized relays trigger only upon alarm, they do not trigger on loss of power. An EAPro®-Gateway powered by an alarm panel that has backup power may not be concerned with loss of power.

Energized relays trigger upon alarm and upon loss of power. It's important to note that polarity is reversed when the relay is energized. Thus, a N.C. connection to your alarm panel will be connected to the C and N.O. terminals when a relay setting is set to energized.

Table 20: Relay Operation Conditions

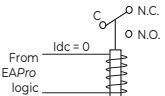
RELAY SETTING	CONDITION	DESCRIPTION	
De-Energized (default)	No Alarm		Power is removed from the relay coil.

	Alarm		Power is applied to the relay coil.
Energized	No Alarm		Power is applied to the relay coil.
	Alarm		Power is removed from the relay coil.

Table 21: Data Log

Time	1 Sensor	4 Sensors	12 Sensors	24 Sensors	34 Sensors
30 Seconds	10 Days	2 Days	0.8 Days	0.4 Days	0.3 Days
1 Minute	20 Days	5 Days	1.7 Days	0.8 Days	0.6 Days
5 Minutes	104 Days	26 Days	8.6 Days	4.3 Days	3 Days
10 Minutes	208 Days	52 Days	17.3 Days	8.6 Days	6.1 Days
15 Minutes	10.4 Months	78 Days	26 Days	13 Days	9.1 Days
20 Minutes	13.8 Months	104 Days	34.7 Days	17.3 Days	12.2 Days
30 Minutes	20.8 Months	156 Days	52 Days	26 Days	18.3 Days
1 Hour	41.6 Months	312 Days	104.1 Days	52 Days	36.7 Days
2 Hours	83.3 Months	20.8 Months	208 Days	104.1 Days	73.5 Days
4 Hours	166.6 Months	41.6 Months	416.6 Day	208.3 Days	147 Days
6 Hours	250 Months	62.5 Months	20.8 Months	312 Days	220 Days

Note: Sensors can have individual collection frequency, as well as some sensors may not need data collection, such a door contact. This table indicates all sensors requiring the same collection frequency.

DATA LOGS

The EAPro®-Gateway collects data which can be viewed or exported for reporting purposes. Logged data includes notifications, events, sensors, and users. View the logged data points on the EAPro®-Gateway, export a log to USB, or view via [INSIGHT](#) (sold separately).

Notification Log

The notification log contains time and date of warning and alarm notifications for all sensors. The EAPro®-Gateway displays the ten latest notifications in chronological order starting with the most recent. Logged information includes the sensor name, date and time of the warning or alarm, and the trigger.

Event Log

The event log contains the time, date, and user responsible for events, including: sensor maintenance, relay triggers, device updates, network changes, power cycles, RF issues, and system clears.

Sensor Log

The sensor log contains a time and date stamped list of sensor(s) reading data recorded according to the specified collection frequency for each sensor.

User Log

The User Log contains a list of activities by users who have credentials programmed into the system. User Log information includes email address (username) and PIN, log in/out timestamps, and timestamps for clearing logs, and for editing, pausing, and deleting sensors.

SECTION
LEFT BLANK

INSTALLATION

This section provides instructions for installing the EAPro®-Gateway.

Note: Read the [Installation](#) and [Program](#) sections in entirety prior to starting any installation or programming work.

Note: All product images shown are for illustration purposes only and may not be an exact representation of the product. Actual product may vary due to product modification.

INSTALLATION TOOLS AND SUPPLIES

The following tools and supplies may be necessary for the installation:

- Phillips screwdriver
- Mounting hardware for the EAPro®-Gateway and any optional sensor units
- If required, a drill and the appropriate drill bits
- Wire stripper
- Sensors (not supplied; see Sensors)
- Sensor wiring (typically 18–22 AWG twisted-pair; not supplied)
- Power sources

POWER REQUIREMENTS

All power terminals must be connected to a Class 2 power limited circuit which complies with the National Electrical Code NFPA 70, Article 725. Where required, this equipment is to be isolated from the mains supply by a limited power source as specified in EN61010-1.

WARNING

EAPro®-Gateway relay outputs are intended only for use as low voltage, low-current alarm connections, and not for direct switching or control of AC-mains powered loads. Additionally, local codes may further dictate or limit the types of loads and associated wiring to be used with the low-current Form C relay outputs used with the EAPro®-Gateway. Connecting AC-mains type circuits to the EAPro®-Gateway may result in an electric shock and/or fire hazard.

Connect only sensors specified in this manual to the wired and wireless input connections. Using sensors not specified in this manual may damage the EAPro®-Gateway or cause improper or unreliable operation.

Do not connect a load to the AUX OUT or OUTPUT 1 through OUTPUT 4 relay outputs that exceeds limitations stated in the [Specifications](#) section of this manual. Loads exceeding the specified limitations may damage the EAPro®-Gateway, or result in improper or unreliable operation.

The EAPro®-Gateway printed circuit board (PCB) contains electrostatic discharge (ESD) sensitive devices. To help prevent damage caused by ESD, observe appropriate ESD handling rules whenever

the PCB in the EAPro®-Gateway is exposed.

Batteries shall not cause explosion or produce a fire hazard as a result of excessive charge or discharge, or if a battery is installed with incorrect polarity.

If the equipment is used in a manner not specified by the manufacturer, the protection provided by the equipment may be impaired.

MOUNT THE REAR PLATE

The EAPro®-Gateway has a rear plate on a hinge that may be attached to a standard 3-gang electrical enclosure or mounted directly to a wall.

Drop down the rear mounting plate of the EAPro®-Gateway.

Pull the rear mounting plate down and hinge away from the EAPro®-Gateway main chassis. The top retainer tabs on the main chassis disengage from the holes in the rear plate.

Completely remove the mounting plate from the EAPro®-Gateway by disengaging the mounting plate hinges from the mating tabs.

Install the rear mounting plate.

If mounting to 3-gang enclosure: Use four (4) machine screws (4 screws are included in the box) to secure the mounting plate to the mating holes in the 3-gang enclosure.

If mounting to drywall surface: Hold the mounting plate in mounted position. Mark the locations of the four mounting holes. Install drywall anchors (4 drywall anchors are included in the box) and secure the mounting plate to the anchors.

Note: If wall-mounted, prepare a wiring access hole at this time. Wiring typically passes through the opening in the center of the rear mounting plate. The top of the mounting plate, next to the latch is etched out for a conduit.

CONNECTING POWER

CAUTION

Do not connect or disconnect power, sensor, or alarm wiring while power is applied. Connecting and disconnecting sensors or alarm wiring when power is applied to the EAPro®-Gateway may damage the EAPro®-Gateway or result in improper or unreliable operation.

Connection of unsuitable loads to the EAPro®-Gateway power connection may damage the power supply and EAPro®-Gateway, or result in improper or unreliable operation.

Note: Do not connect power to the EAPro®-Gateway until you are ready to begin programming sensors. The EAPro®-Gateway allows for power over Ethernet (PoE) on J1 or power through the included terminal on PWR IN on J6.

Note: When PoE and PWR IN are both enabled, PWR IN takes priority, and loss of power on PWR IN will take approximately 6 Milliseconds (ms) to swap to PoE. The UPS battery will enable

during this transition for seamless operation, and if UPS battery is not enabled, may result in system rebooting.

The PWR ON switch (SW7) is enabled when the switch is at the “ON” position, with the toggle closer to the center of the PCB board. The PWR ON switch disables both PWR IN and PoE when in the “OFF” position, but does NOT disable UPS Battery power.

Use the terminal block adapter to connect power supply positive (+) and negative (-) leads to PWR IN (+) and (-) on J6. Observe proper polarity. The EAPro®-Gateway does have polarity protection on the PWR IN.

If a sensor requires the power out to be used, connect leads to PWR OUT (+) and/or (-) on J5 using a terminal block adapter while the PWR ON switch is “OFF”

Connecting the UPS battery to J19 will power on the EAPro®-Gateway.

INITIAL START-UP PROCEDURE

When power is first applied to the EAPro®-Gateway, the touchscreen will flash the splash screen as well as the LED Light will flash an array of colors as the system verifies memory and conducts internal checks. Since no sensors are installed, the initial boot up process will end at the null sensor screen, this indicates the EAPro®-Gateway to be programmed once unlocked.

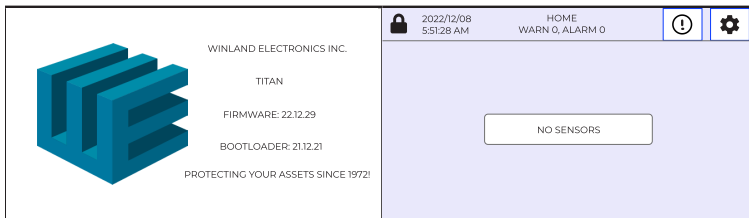

Note: Do not connect power to the EAPro®-Gateway until you are ready to begin programming sensors.

Unlock the EAPro®-Gateway

System security requires users to login with registered credentials. The default username is “root”. The root PIN is 001234. The root PIN can be changed but **CANNOT** be deleted. By default only “root” is enabled. Other users can be added to assist in auditing and logging.

Users may be assigned a PIN as an added level of security to authorize different functions and to record who performed a given task.

1. Tap on the LOCK icon on the upper left of the screen.
2. Tap the blue box next to USERNAME to enable the drop-down to select username.
3. Tap the PIN button to enable the keypad.
4. Tap in PIN and press ENTER to log in.

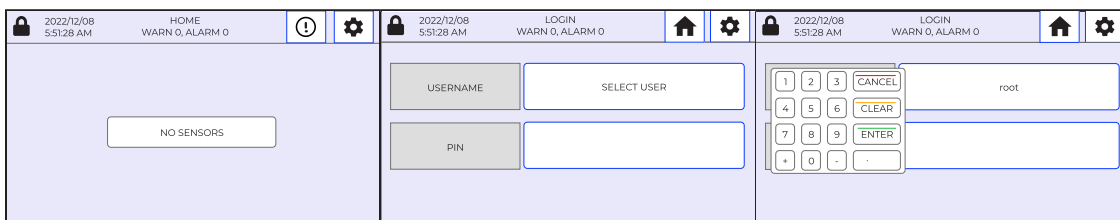

Note: System logins are recorded in the User Log.

Note: 001234 is the same as 1234, however, 123400 is NOT the same as 1234

Note: If the PIN entered was not valid, the system will not unlock and return to prior screen with lock icon still in place. No warning for incorrect PIN will display.

INSTALL WIRED SENSORS

Install wired sensors according to the instructions provided, when provided with the wired sensor.

Mount the wired sensor in its designated location.

Label the sensor wires for easy identification and keep documentation for wire runs and splices.

Route the wires from the sensor to the EAPro®-Gateway and dress the wires as required by local code. Ensure the wires are protected and supported along their entire length, and they are not stressed at any point.

Pass the wires through the rear plate.

CONNECT WIRED SENSORS

CAUTION

Do not connect or disconnect power, sensor, or alarm wiring while power is applied. Connecting and disconnecting sensor wiring while the EAPro®-Gateway has power connected may damage the console or result in improper or unreliable operation.

Terminal blocks are removable for easier installation from the input header, by pulling them straight up and off of the circuit board.

Note: Do NOT bend header pins when removing and installing terminal blocks.

Strip the ends of the sensor wires 1/4" (6.4 mm). If stranded, twist strands after stripping. Insert the stripped wire ends into screw terminals of the terminal block. See Figure 9, Figure 10, and Figure 11.

Note: Winland's temperature sensors, PS-110, and the WaterBug® sensor are NOT polarity sensitive.

Note: Winland's humidity sensors, third-party 0-5V, and third-party 4-20mA ARE polarity sensitive.

Secure the wire connection using the setscrews on the terminal block. Check the connection by pulling lightly and ensure wires stay in place.

After connecting the wire ends to the terminal block, align the terminal block to the correct header pins, and press to fully seat the block onto the header connector pins.

Note: Terminal blocks MUST be right-side up, with screws facing away from PCB.

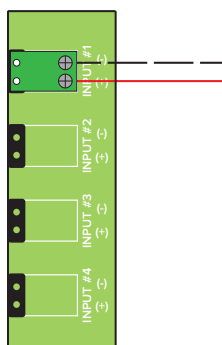

Figure 10: Wired Sensor Connection: Temperature Sensor, WaterBug®, and Dry Contact

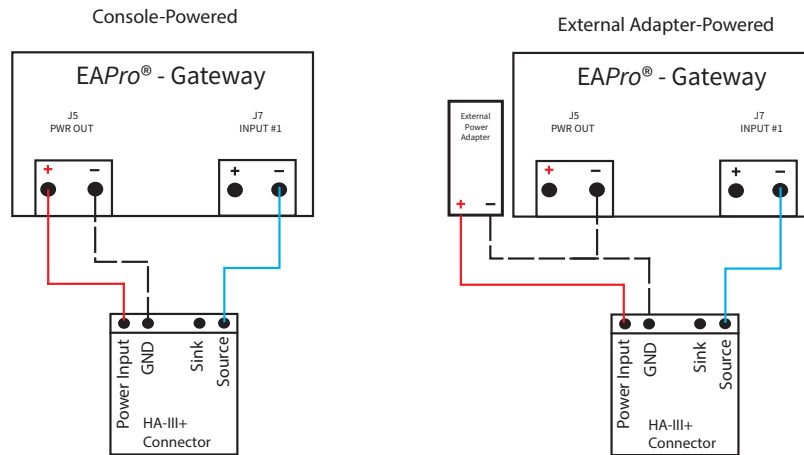

Figure 11: Wired Sensor Connection: HA-III+

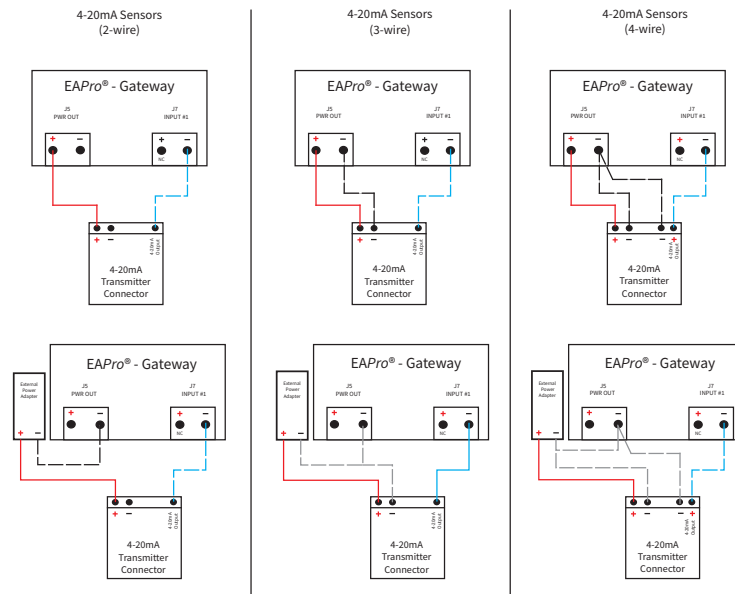

Figure 12: Wired Sensor Connection: 4-20mA

INSTALL WIRELESS SENSOR

Note: For simplicity, it is best to program wireless sensors one at a time. Document SN and location of the transmitter, as well as wire run of sensor if needed.

CAUTION

Do not connect or disconnect power, sensor, or alarm wiring while power is applied. Connecting and disconnecting wiring with the EAPro®-Gateway or EAPro® transmitter with power connected may damage the console or result in improper or unreliable operation.

Note: Verify the wireless sensor can communicate with the EAPro®-Gateway before permanent mounting. It is recommended to have the RF sensor programmed next to the EAPro®-Gateway to have the ability to watch the signal strength as it is being mounted.

Record Serial Number

Wireless sensors have a model type (e.g. EAPro TEMP for Wireless Temperature Sensor) and they are assigned a unique serial number (MAC address) for identification during programming. The model type is printed on the cover (HUMID, TEMP, MULTI is placed under EAPro). See figure 12.



Figure 13: Wireless Models

Remove the cover from the wireless sensor, by pinching the top or bottom next to the seam between the front and back cover, near the air vents.

The serial number is printed on a white label affixed to the PCB, slightly above the battery holder.

Locate and record the serial number (see Figure 13).

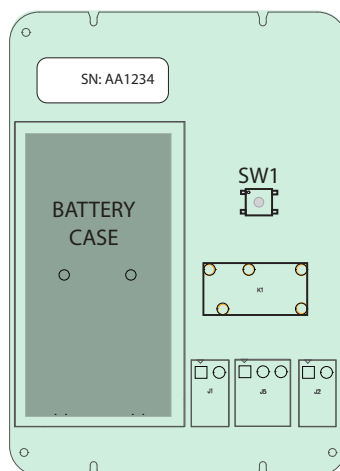

Figure 14: Wireless Sensor MAC Address and ID Location

Note: With wireless sensors, it is best to keep the wireless unit powered down until program is ready to scan for sensors.

Note: Wireless sensors will flash blue to indicate they are transmitting data. The EAPro®-Gateway will also flash blue on the LED to indicate it is receiving RF transmission.

Note: It is recommended that the EAPro®-Gateway identifies wireless sensors one at a time, with the sensors unmounted and in close proximity to the EAPro®-Gateway.

Note: Two AA batteries can be used either as the main power supply for the transmitter, or backup power when using the 12VDC terminal block being powered from a 12V 0.5A power supply.

Note: The EAPro®-WMFT, EAPro®-WHS, and the EAPro®-WTS has power polarity protection on the PWR IN.

Wireless 4-20mA & 0-5V Wiring

The EAPro®-WMFT allows for 4-20mA and 0-5V sensors. See figure 15.

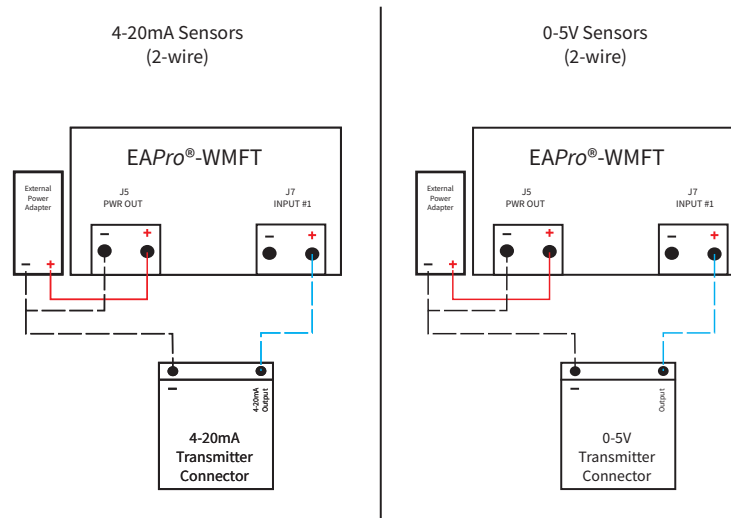

Figure 15: Wireless 4-20mA & 0-5V sensors

SECTION
LEFT BLANK

PROGRAMMING

This section provides instructions for programming the EAPro®-Gateway.

The EAPro®-Gateway may be programmed locally (by default) or remotely via [INSIGHT](#) (sold separately). A configuration file (CFG) file can be exported and imported.

Note: Read the [Installation](#) and [Program](#) sections in their entirety prior to starting any installation or programming work.

Note: The keypad locks automatically after inactivity (no key or touchscreen activity) according to the Local Lock Setting. If the detection and programming process for a sensor is not completed before the keypad lockout, entered values are lost and the programming procedure must be restarted for the sensor from the beginning.

MAIN MENU

The Main Menu is a gateway menu for programming or viewing settings (see Figure 16 & Figure 17). The Main Menu is also the starting point to modify settings, and to perform some Maintenance tasks. Tap the gear icon from any screen to quickly navigate to the Main Menu. A Locked Menu is limited and will not give the option to modify settings. Ensure your device is UNLOCKED during programming.

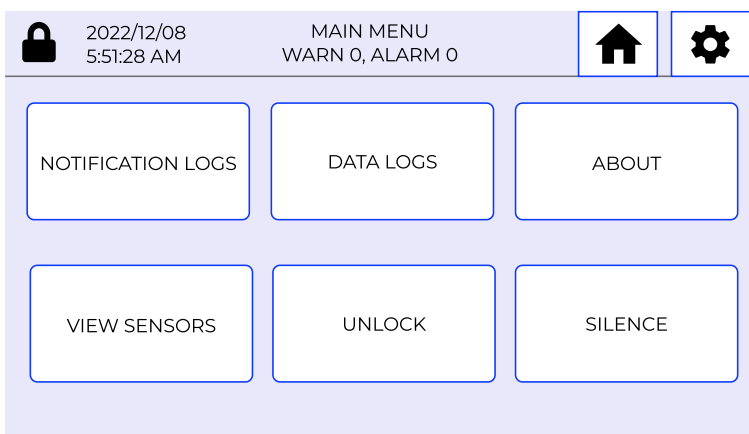

Figure 16: Main Menu Locked

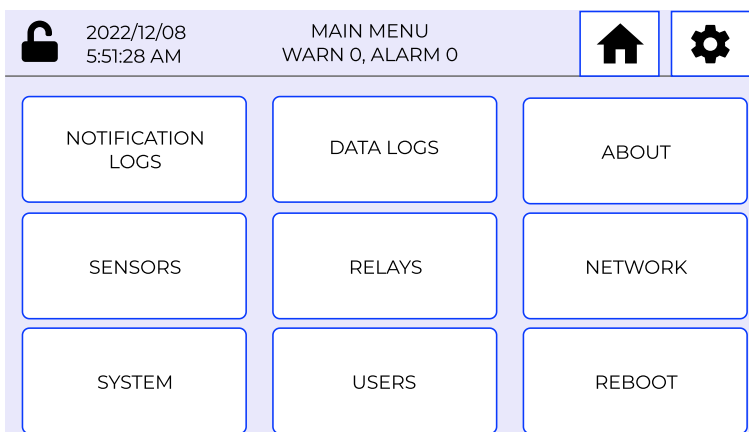

Figure 17: Main Menu Unlocked

CONFIGURE SYSTEM

System configurations, which includes the system parameters shown in [Configuration Parameters](#) and any programmed sensor parameters, can be saved from other installations and then loaded into current installations. To configure a system by loading settings from other installations, [Load System Configuration from USB](#) or [Load System Configuration from INSIGHT](#) (sold separately).

Note: USB should be formatted as FAT32.

Load System Configuration from USB

To configure the system with a file from a USB, perform the following procedure starting at the Main Menu:

1. Insert the USB.
2. At [Main Menu](#) tap **System** > **Configuration** > **Load Config** > **Load from USB**.
3. Scroll to desired file and tap blue box next to the file name.
4. Review warning and tap **Confirm** to load from USB.
5. Remove USB after pressing OK on confirmation that firmware is ready to be applied.
6. Reboot device by going to [Main Menu](#) and tap **Reboot**.

Note: System configuration changes are recorded in the [Event Log](#).

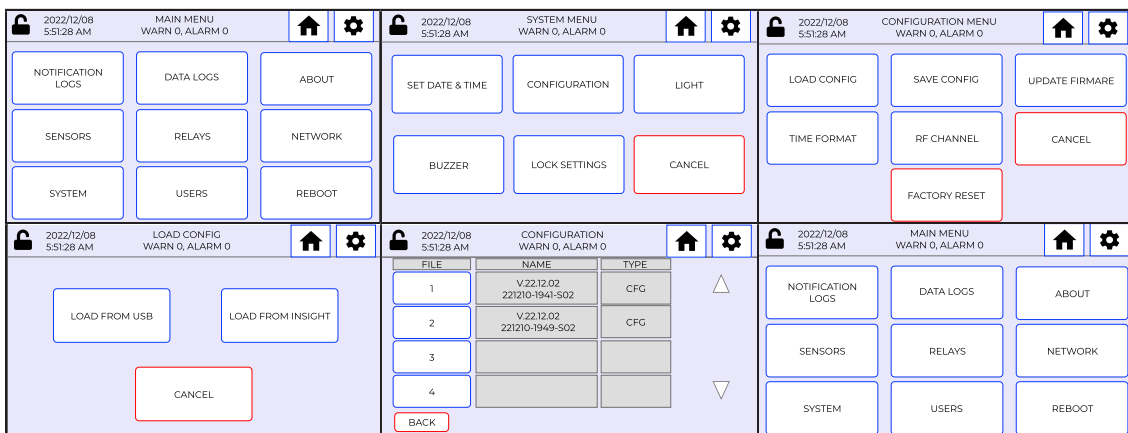

Note: File format shows the following:

1. Firmware version
2. YYMMDD-HHMM-SXX Where SXX is the amount of sensors in the configuration.

Load System Configuration from [INSIGHT](#)

Note: As of firmware 22.12.29 [INSIGHT](#) to Device feature does not work.

To configure system from [INSIGHT](#) (sold separately), perform the following procedure starting at the [Main Menu](#):

1. At [Main Menu](#) tap **System** > **Configuration** > **Load Config** > Load from [INSIGHT](#).
2. Scroll to desired file and tap file name to select.
3. Tap **Confirm** to activate.
4. Review warning and tap **Confirm** to load from [INSIGHT](#) (sold separately).

Note: System configuration changes are recorded in the [Event Log](#).

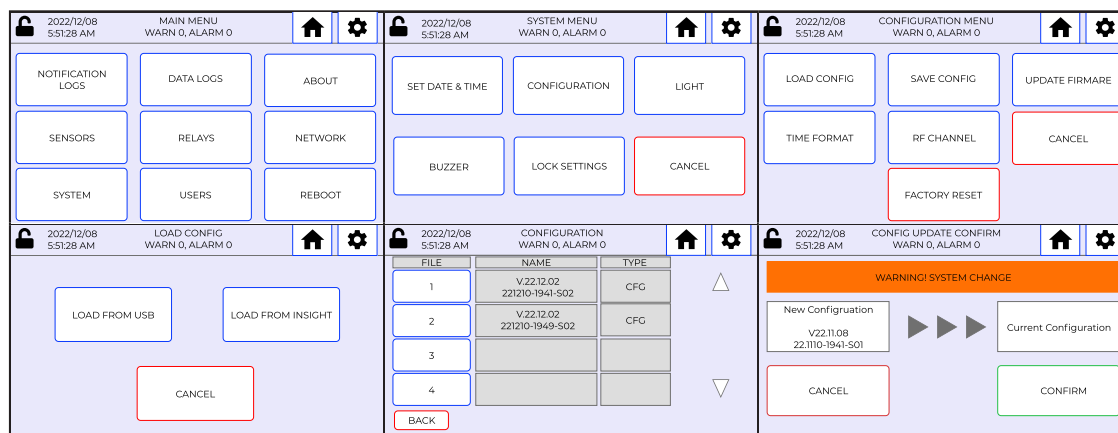

ADD SENSOR

Add Hardwire Sensor

To add a hardwire sensor, perform the following procedure starting at the Main Menu:

1. At **Main Menu** tap **Sensors** > **Add Sensor** > **Hardwire** and tap the appropriate Input.
2. On "Sensor Type & Name", Tap "SELECT PROBE) and select the appropriate type.

Note: Once a sensor is completely programmed, sensor type cannot be changed.

3. Toggle for NAME allows for prefilled drop-down names, or a keyboard to type your own custom name for the sensor.
4. Toggle to enabled COLLECTION FREQUENCY if desired, and then click on the number for a drop-down option for various frequencies.
5. **Confirm** when ready to proceed to next screen.
6. On "Sensor General", select your Unit Of Measure (UoM).

Note: UoM can be changed at any time for common sensors. Third-party sensors will not allow data conversion. By default all data is stored in Celsius with common sensors, and is converted as needed.

7. Toggle "LIGHT" if you would like the device to flash the LED when in alarm.
8. Toggle "BUZZER" if you would like the device to activate its piezo buzzer when in alarm.
9. **Confirm** when ready to proceed to next screen.

Note: If custom sensor (PT1000, 0-5V, 4-20mA) was selected as type, "Sensor Custom Config screen will come up. If common sensor is used, this screen is skipped.

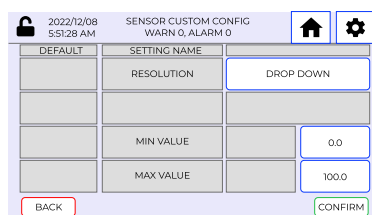

10. Enter Resolution.
11. Enter MIN & Max Value.
12. **Confirm** when ready to proceed to next screen.

Note: MIN & MAX setpoints are critical for proper readings. MIN refers to bottom sensor reading, and MAX refers to top sensor reading. For example, a humidity sensor with a reading range of 0 and 100 RH%, would be 0 for MIN, and 100 for MAX.

13. Toggle **Relays** if you would like the device to default all warning and alarm settings.

Note: As of firmware 22.12.29 this feature is not active.

14. Toggle **Warnings** if you would like the device to activate all warnings for this sensor.

Note: As of firmware 22.12.29 this feature is not active.

15. **Confirm** when ready to proceed to next screen.

16. Toggle and set **Low Limit, Low Limit Delay, Low Limit Warning, And Low Limit Warning Delay** if desired.

17. **Confirm** when ready to proceed to next screen.

18. Toggle and set **High Limit, High Limit Delay, High Limit Warning, And High Limit Warning Delay** if desired.

19. **Confirm** when ready to proceed to next screen.

The sensor has been added.

Note: Adding a sensor is recorded in the [Event Log](#). If a user is logged out due to a timeout, the sensor add will fail and a user will need to try again after logging back into the unit.



Add Wireless Sensor

It is recommended to have the wireless transmitters powered off until the device is ready to start scanning. Perform the following procedure starting at the [Main Menu](#):

1. At Main Menu tap **Sensors** > **Add Sensor** > (At this point, add power to the wireless transmitter, and ensure blue lights flash both on the transmitter and the EAPro®-Gateway) > **Wireless**.

Note: If the sensor is not shown on the next screen, press "BACK" and scan again with pressing "Wireless".

2. The EAPro®-Gateway will begin searching for wireless sensor and displays signal strength, and MAC address.
3. Tap the blue box next to the MAC address to start the sensor programming.
4. On “Sensor Type & Name”, Tap **Select Probe** and select the appropriate type.

Note: Once a sensor is completely programmed, probe type cannot be changed.

Note: EAPro®-WHS and EAPro®-WTS will have **Probe Type** auto filled.

5. Toggle for NAME allows for prefilled drop-down names, or a keyboard to type your own custom name for the sensor.
6. Toggle to enabled COLLECTION FREQUENCY if desired, and then click on the number for a drop-down option for various collection frequencies.
7. **Confirm** when ready to proceed to next screen.
8. On “Sensor General”, select your Unit Of Measure (UoM).

Note: UoM can be changed at any time for common sensors. Third-party sensors will not allow data conversion. By default all data is stored in Celsius with common sensors, and is converted as needed.

9. Toggle “LIGHT” if you would like the device to flash the LED when in alarm.
10. Toggle “BUZZER” if you would like the device to activate its piezo buzzer when in alarm.
11. **Confirm** when ready to proceed to next screen.

Note: If custom sensor (PT1000, 0-5V, 4-20mA) was selected as type, “Sensor Custom Config screen will come up. If common sensor is used, this screen is skipped due to preset values.

DEFAULT	SETTING NAME	
	RESOLUTION	DROP DOWN
	MIN VALUE	0.0
	MAX VALUE	100.0

BACK CONFIRM

12. Enter Resolution.
13. Enter MIN & Max Value.
14. **Confirm** when ready to proceed to next screen.

Note: MIN & MAX setpoints are critical for proper readings. MIN refers to bottom sensor reading, and MAX refers to top sensor reading. For example, a humidity sensor with a reading range of 0 and 100 RH%, would be 0 for MIN, and 100 for MAX.

15. Toggle **Relays** if you would like the device to default all warning and alarm settings.

Note: As of firmware 22.12.29 this feature is not active.

16. Toggle **Warnings** if you would like the device to activate all warnings for this sensor.

Note: As of firmware 22.12.29 this feature is not active.

17. **Confirm** when ready to proceed to next screen.
18. Toggle and set **Low Limit, Low Limit Delay, Low Limit Warning, And Low Limit Warning Delay** if desired.
19. **Confirm** when ready to proceed to next screen.
20. Toggle and set **High Limit, High Limit Delay, High Limit Warning, And High Limit Warning Delay** if desired.
21. **Confirm** when ready to proceed to next screen.

The sensor has been added.

Note: Adding a sensor is recorded in the Event Log. If a user is logged out due to a timeout, the sensor add will fail and a user will need to try again after logging back into the unit.

22. The sensor has been added. Tap screen to navigate as desired.

Note: Adding a sensor is recorded in the Event Log.

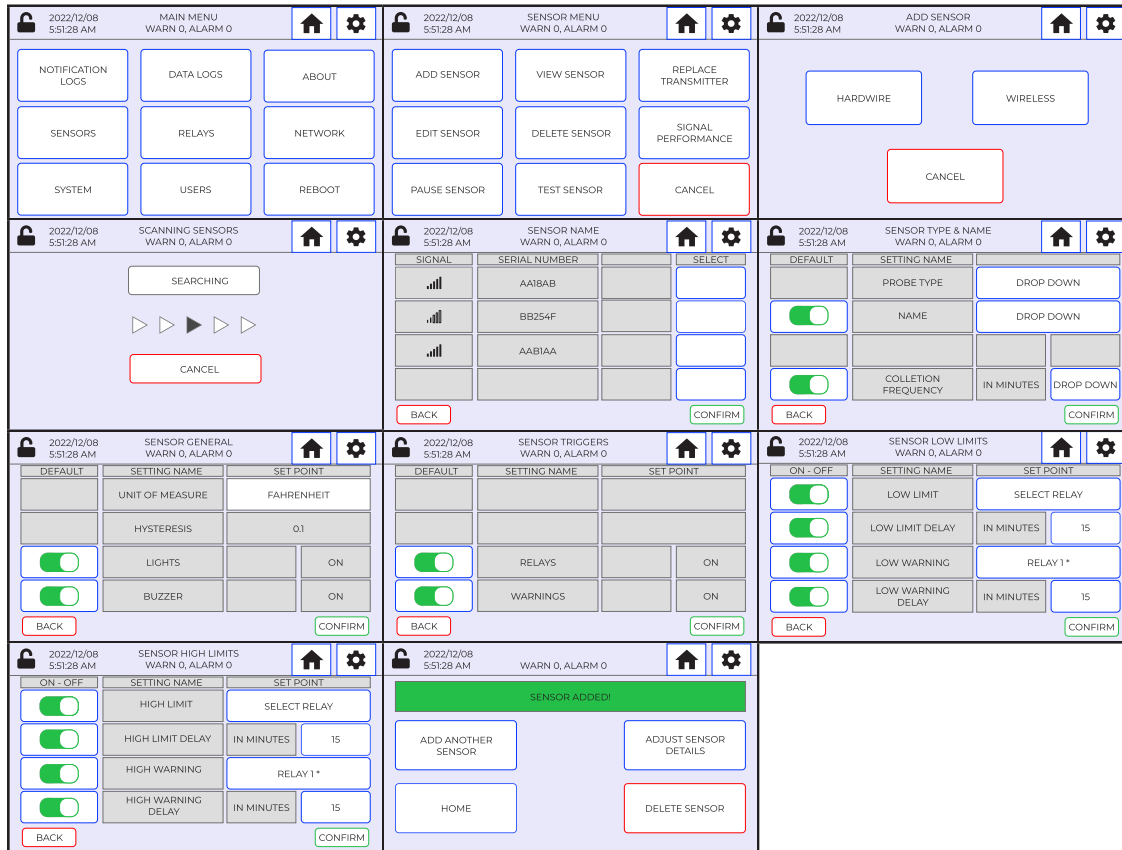

ADD USER

To add users, perform the following procedure starting at the Main Menu:

1. At Main Menu tap **Users** > **Add User** and enter:
 - a. Username (email address)
 - b. PIN (unique code of 4–6 alphanumeric characters)
2. Tap on security drop-down to select User Access Level (User, Admin, Super Admin).
3. Tap **Confirm** to activate.

Note: Adding a user is recorded in the Event Log.

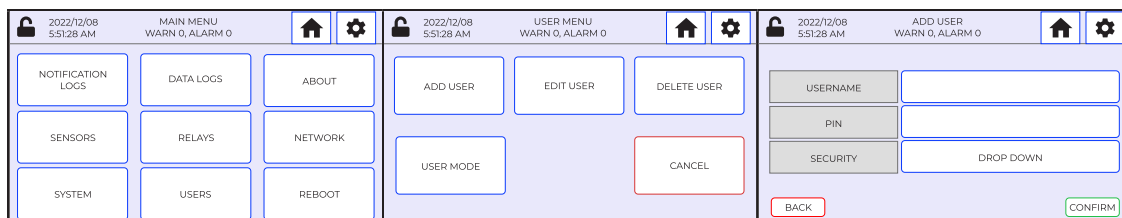

SET SYSTEM TIME AND DATE FORMAT

To set the system time and date format, perform the following procedure starting at the Main Menu:

1. At Main Menu tap **System** > **Configuration** > **Time Format**.
2. Tap on drop-down to select new date format.
3. Tap on drop-down to select new time format.
4. Tap **Confirm** to activate.

Note: System time and date format changes are recorded in the Event Log.

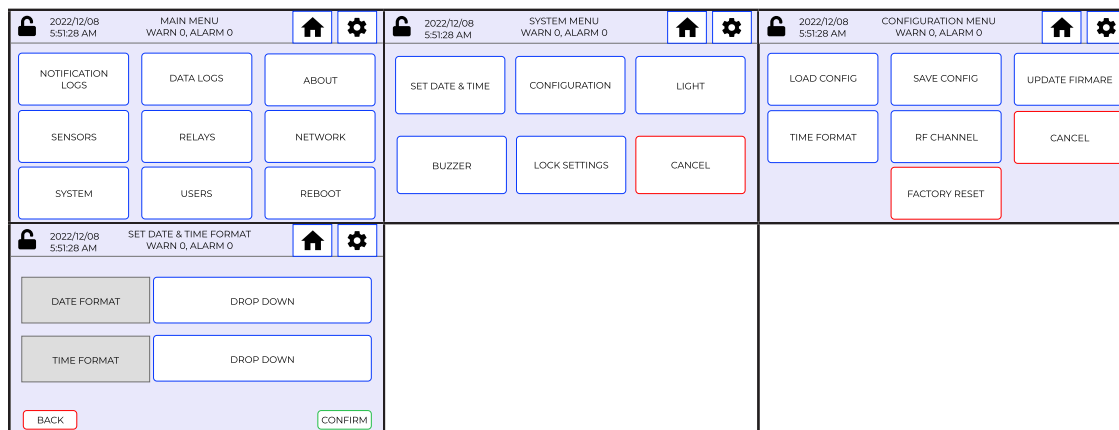

SET DATE AND TIME

To set the date and time, perform the following procedure starting at the Main Menu:

1. At Main Menu tap **System** > **Set Date & Time**.
2. Tap on date, month, and year to set and tap **Next** to advance.
3. Tap on hour and min to set.
4. Tap on **GMT Offset** to set time zone.
5. Tap **Confirm** to activate.

Note: If the unit is tied to the network, it will pull Network Time Protocol (NTP) and auto adjust based on offset or INSIGHT setting.

Note: The EAPro[®]-Gateway uses UTC Epoch for logging and does not follow daylight savings.

Note: Setting the date and time is recorded in the Event Log.

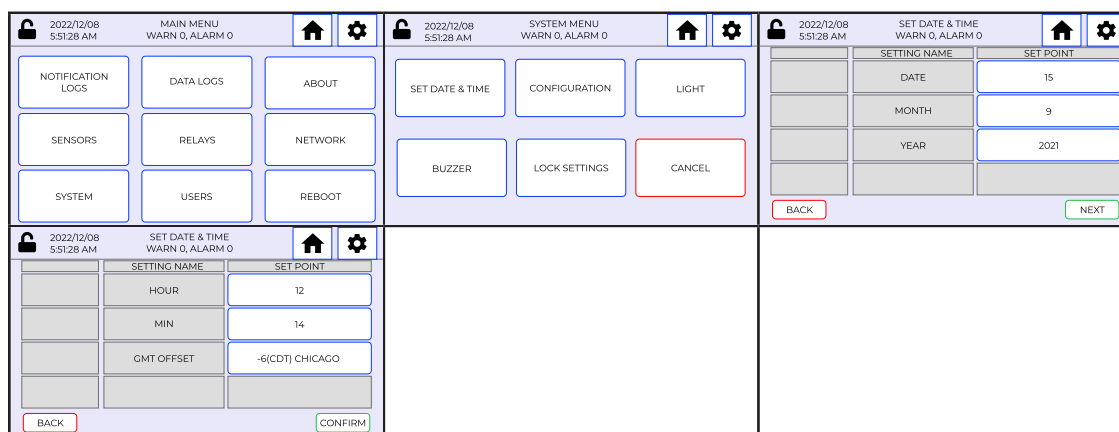

SET LOCK MODE

As of firmware 22.12.29 this feature is not enabled.

To configure lock mode, perform the following procedure starting at the Main Menu:

1. At Main Menu tap **System** > **Lock Settings**.

2. Tap to select lock mode (see Access Control).
3. Tap to select options.
4. Tap **Confirm** to activate.

Note: Configuring lock modes is recorded in the Event Log.

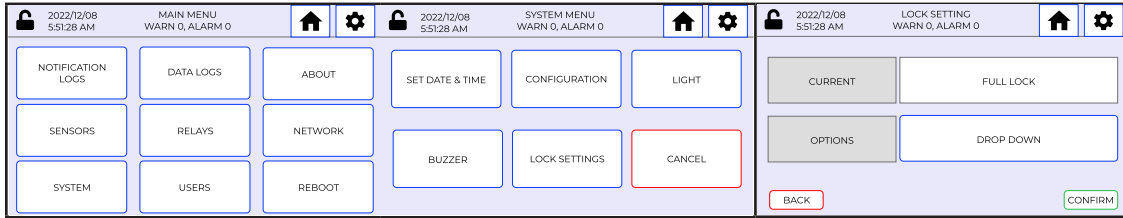

SELECT RF CHANNEL

To select RF channel, perform the following procedure starting at the Main Menu:

1. At Main Menu tap **System** > **Configuration** > **RF Channel**.
2. Review current RF channel and tap on drop-down. Tap to select new RF channel.
3. Tap **Confirm** to activate.

Note: RF channel changes are recorded in the Event Log.

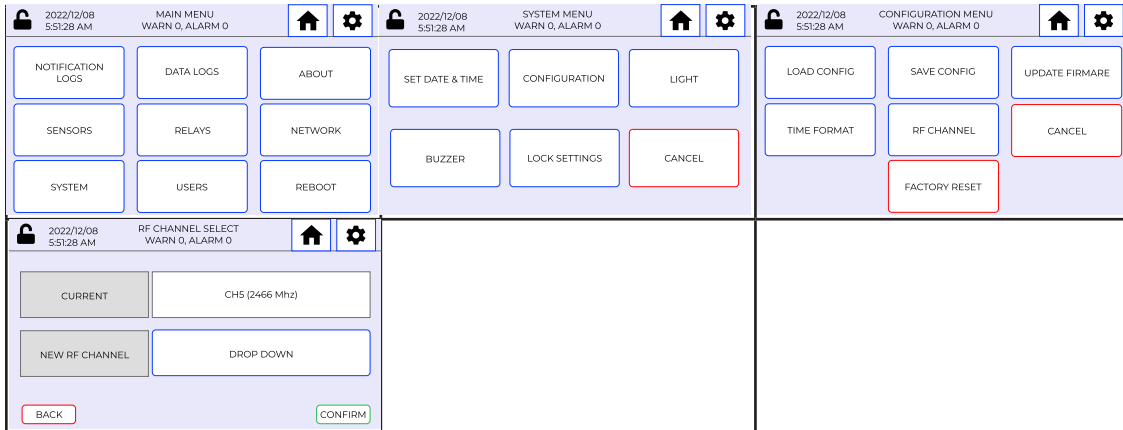

RELAYS TRIGGER STATUS

When all sensors have been added and programmed, a user can validate what sensor will trip a relay to warn or alarm for specific conditions.

To view configured relays, perform the following procedure starting at the Main Menu:

1. At Main Menu tap **Relays** and tap on desired relay.

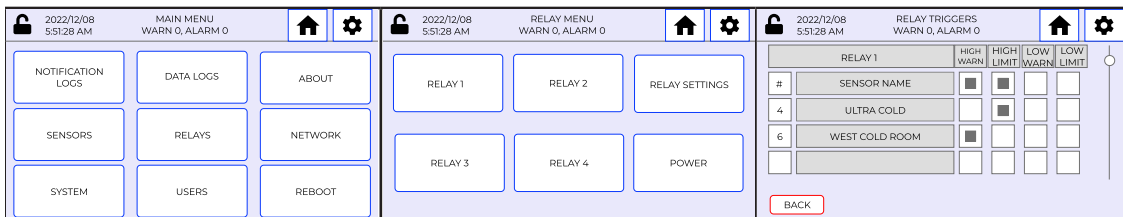

CONFIGURE RELAY STATE

As of firmware 22.12.29 this feature is not enabled.

Relays must be programmed correctly to provide the desired signal to the alarm panel. Relay states by default are set to de-energized and non-latching.

To configure relay states, perform the following procedure starting at the Main Menu:

1. At Main Menu tap **Relays** > **Relay Settings**.
2. Tap to toggle state (energized or de-energized) for desired relay.
3. Tap to toggle latch (enable or disabled).
4. Tap **Confirm** to activate.

Note: Latch is disabled by default. Latch requires a “Reset” by the user to clear an alarm for the relay to go back to a normal condition.

Note: Configuring relays is recorded in the Event Log.

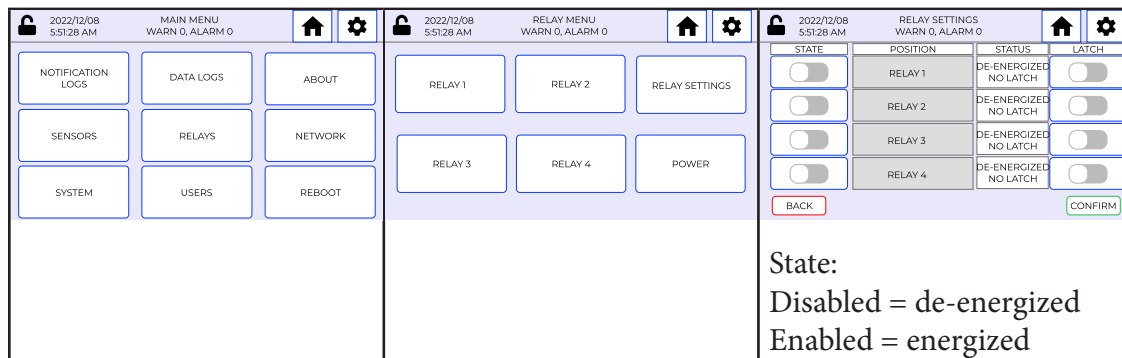

BUZZER TRIGGERS

To view system buzzer triggers, perform the following procedure starting at the Main Menu:

1. At Main Menu tap **System** > **Buzzer** and scroll to view sensor and validate if trigger box is enabled.
2. Tap to Enable or Disable buzzer triggers for the system.
3. Tap to Pause or reactivate buzzer triggers for the system.
4. Tap **Confirm** to activate.

Note: Buzzer trigger changes are recorded in the Event Log.

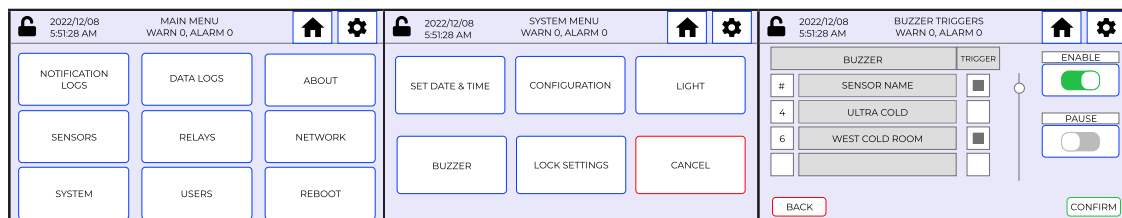

LIGHT TRIGGERS

To view system light triggers, perform the following procedure starting at the Main Menu:

1. At Main Menu tap **System** > **Light** and scroll to view sensor and validate if trigger box is enabled.
2. Tap to Enable or Disable light triggers for the system.
3. Tap to Pause or reactivate light triggers for the system.
4. Tap **Confirm** to activate.

Note: Light trigger changes are recorded in the Event Log.

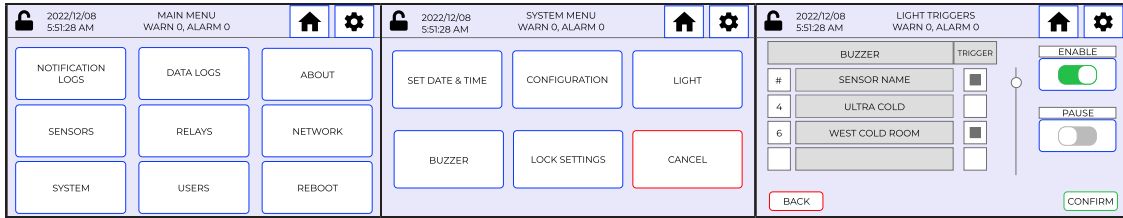

SECTION
LEFT BLANK

OPERATION

This chapter provides instructions for general system operations.

ACKNOWLEDGE SENSOR READING OR CLEAR MIN/MAX

Note: This feature is only active when a sensor is not in alarm.

To acknowledge an alarm, perform the following procedure starting from the [Home Screen](#):

1. At [Home Screen](#), tap and hold down on sensor tile that is in alarm.
2. At popup, enter PIN (if using), and press:
 - a. Clear: to clear MIN & MAX.
 - b. Acknowledge: to acknowledge sensor reading for logging and auditing.

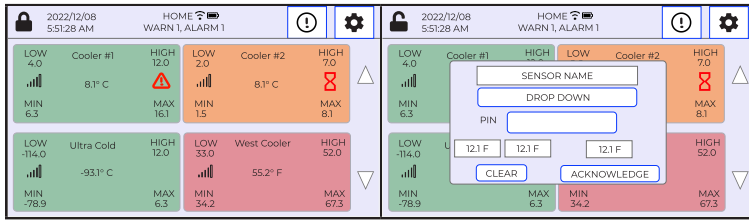

CLEAR ALARM OR SILENCE ALARM

Note: This feature is only active when a sensor is an alarm.

To clear an alarm, perform the following procedure starting from the [Home Screen](#):

1. At [Home Screen](#), tap and hold down on sensor tile that is in alarm.
2. At popup, enter PIN (if using), and press:
 - a. Reset: to stop an alarm and reset the sensor.

Note: If sensor is still in alarm with no time delay, the system will activate a new alarm. If there is a time delay, an alarm delay will start.

- b. Silence: to silence the buzzer for the alarm.

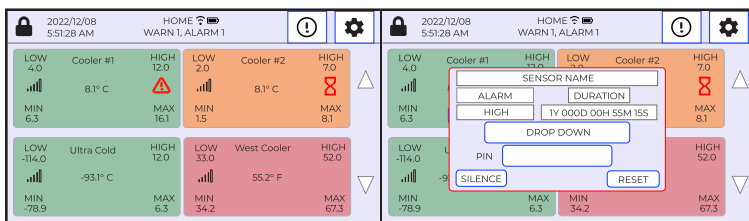

VIEW SENSOR DETAILS

To view programming details of a sensor, perform the following procedure starting at the [Main Menu](#):

1. At [Main Menu](#) tap **Sensors** > **View Sensor** and tap on desired sensor.
2. Tap Next to advance through settings.

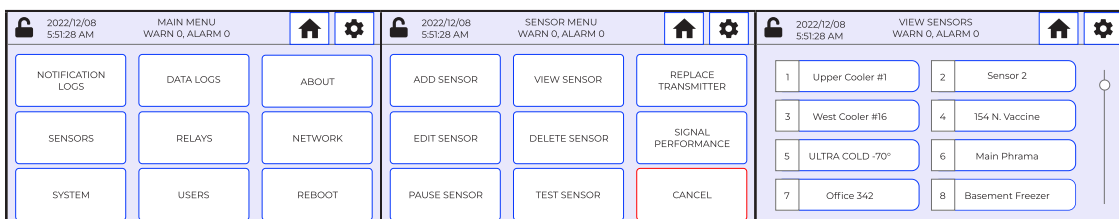

2022/12/08 5:51:28 AM SENSOR CONFIG WARN 0, ALARM 0			2022/12/08 5:51:28 AM SENSORS CONFIG WARN 0, ALARM 0			2022/12/08 5:51:28 AM SENSOR CONFIG WARN 0, ALARM 0		
	NAME	Upper Cooler #1		LOW LIMIT	32.0		HIGH LIMIT	55.0
22.11.9	TYPE	BLUE		LOW LIMIT DELAY	25		HIGH LIMIT DELAY	32
	DEGREE	FAHRENHEIT		LOW WARNING	12.0		HIGH WARNING	45.0
AA:50:FA	LAST COMM	5/25/2021 12:01 PM		LOW WARNING DELAY	5		HIGH WARNING DELAY	15
BACK NEXT			BACK NEXT			BACK NEXT		
2022/12/08 5:51:28 AM SENSORS CONFIG WARN 0, ALARM 0								
	HYSTERESIS	0.1						
	OFFSET	+ 0.0						
	CALIBRATION DATE	5/2021						
	CALIBRATION DUE	5/2023						
BACK								

VIEW NOTIFICATION LOG

The notification logs consists of both warnings and alarms. To view notification logs, perform the following procedure starting at the Main Menu:

1. At Main Menu tap **Notification Logs > Notifications**.
2. Tap on drop-down and select desired Notification Log.

2022/12/08 5:51:28 AM MAIN MENU WARN 0, ALARM 0			2022/12/08 5:51:28 AM DATA MENU WARN 0, ALARM 0			2022/12/06 5:51:28 AM NOTIFICATIONS WARN 0, ALARM 0		
NOTIFICATION LOGS	DATA LOGS	ABOUT	NOTIFICATIONS	EVENTS	CLEAR LOGS	FILTER: SELECT FILTER	DETAIL: DATE	TIME
SENSORS	RELAYS	NETWORK	SENSOR LOGS	USER LOGS	EXPORT	POS: SENSOR NAME	DATE	TRIGGER
SYSTEM	USERS	REBOOT						
BACK PREVIOUS MORE			BACK PREVIOUS MORE			BACK PREVIOUS MORE		

VIEW EVENT LOG

To view event logs, perform the following procedure starting at the Main Menu:

1. At Main Menu tap **Notification Logs > Events**.
2. Tap on drop-down and select desired Event Log.

Note: The Event Log CANNOT be cleared.

2022/12/08 5:51:28 AM MAIN MENU WARN 0, ALARM 0			2022/12/08 5:51:28 AM DATA MENU WARN 0, ALARM 0			2022/12/08 5:51:28 AM EVENT LOGS WARN 0, ALARM 0		
NOTIFICATION LOGS	DATA LOGS	ABOUT	NOTIFICATIONS	EVENTS	CLEAR LOGS	FILTER: SELECT FILTER	EVENT NAME	DATE
SENSORS	RELAYS	NETWORK	SENSOR LOGS	USER LOGS	EXPORT	SEQ: EVENT NAME	DATE	TIME
SYSTEM	USERS	REBOOT						TRIGGER
BACK PREVIOUS MORE			BACK PREVIOUS MORE			BACK PREVIOUS MORE		

VIEW SENSOR LOGS

To view sensor logs, perform the following procedure starting at the Main Menu:

1. At Main Menu tap **Notification Logs > Sensor Logs**.
2. Tap on drop-down and select desired Sensor Log.

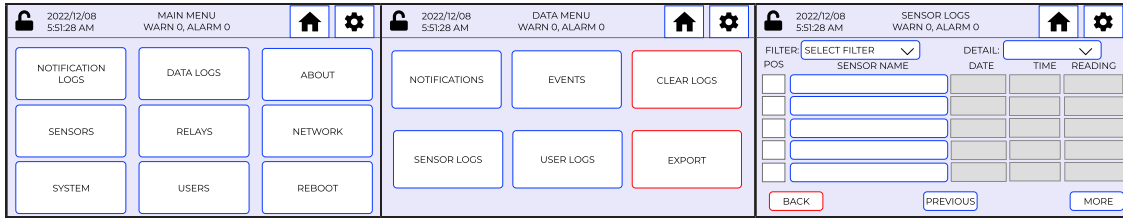

VIEW USER LOGS

To view user logs, perform the following procedure starting at the Main Menu:

1. At Main Menu tap **Notification Logs** > **User Logs**.
2. Tap on drop-down and select desired User Log.

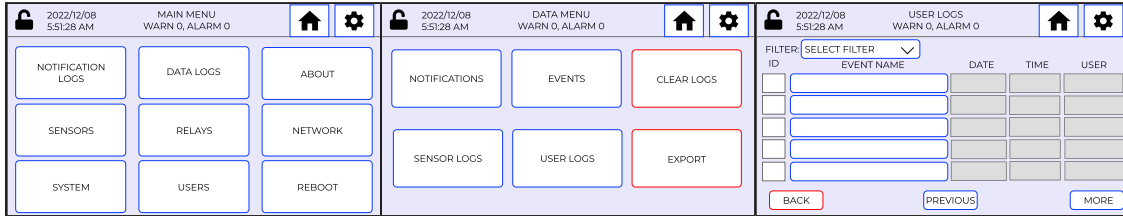

VIEW ABOUT

To view the about information, perform the following procedure starting at the Main Menu:

1. At Main Menu tap **About**.
2. Tap **Confirm** to advance.

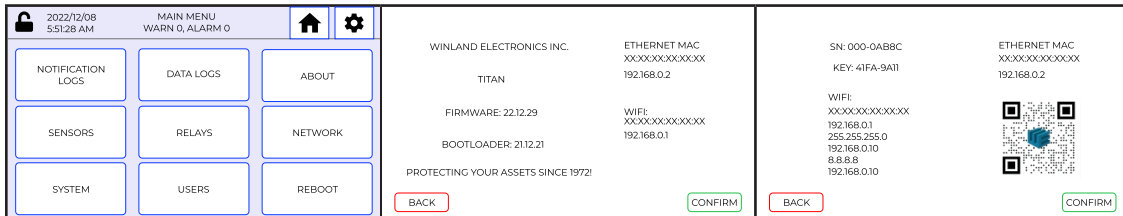

CLEAR NOTIFICATION LOGS

WARNING

Clearing the notification logs erases the information in the notification log. Clearing the notification log can result in data loss.

To clear the notification log, perform the following procedure starting at the Main Menu:

1. At Main Menu tap **Notification Logs** > **Clear Logs** > **Clear Notifications**.

Note: Clearing notification logs is recorded in the Event Log.

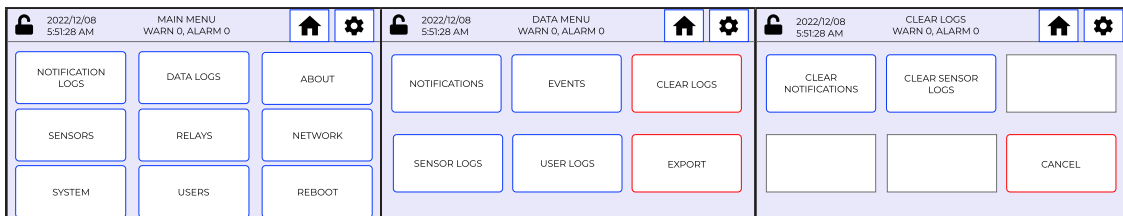

CLEAR SENSOR LOGS

To clear the sensor log, perform the following procedure starting at the Main Menu:

1. At Main Menu tap **Data Logs > Clear Logs > Clear Sensor Logs**.

Note: Clearing sensors logs is recorded in the Event Log.

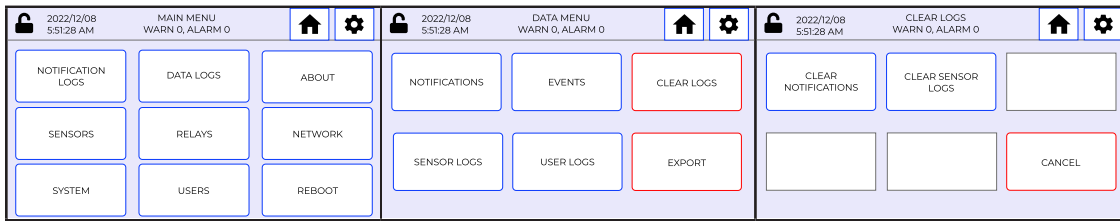

EXPORT LOGS

To export logs, perform the following procedure starting at the Main Menu:

1. Insert storage device to USB port.
2. At Main Menu tap **Data Logs > Export**.

Note: Exporting logs is recorded in the Event Log.

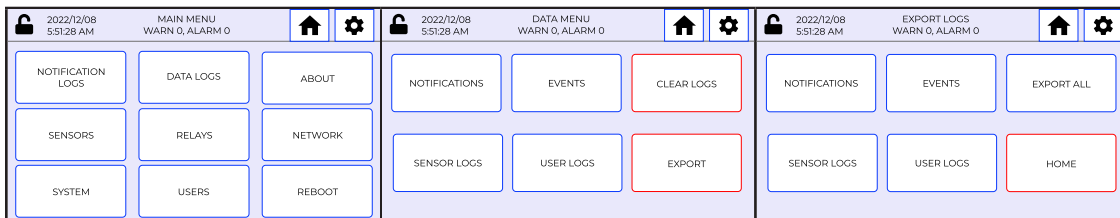

NOTIFICATION LOGS

The notification logs consists of both warnings and alarms. To view notification logs, perform the following procedure starting at the Main Menu:

1. At Main Menu tap **Notifications**.
2. Tap on **Select Filter** drop-down and if necessary select **Detail**:

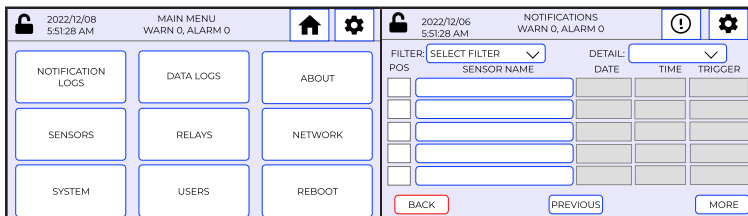

MAINTENANCE

This chapter provides instructions for maintaining the system.

EDIT SENSOR

Occasionally, the parameters of a sensor may need to be edited. Use the Edit Sensor menu to edit the desired parameters.

Note: Editing sensor parameters is recorded in the [Event Log](#).

Edit Sensor Name

To edit the name of a sensor, perform the following procedure starting at the [Main Menu](#):

1. At [Main Menu](#) tap **Sensors** > **Edit Sensor** and tap on desired sensor.
2. At Edit Sensor Menu tap **Name & Collection Frequency**.
3. Toggle to active between custom name and common, and then tap on **Name** to edit.
4. Tap **Confirm** to activate.

Note: Editing sensor parameters is recorded in the [Event Log](#).

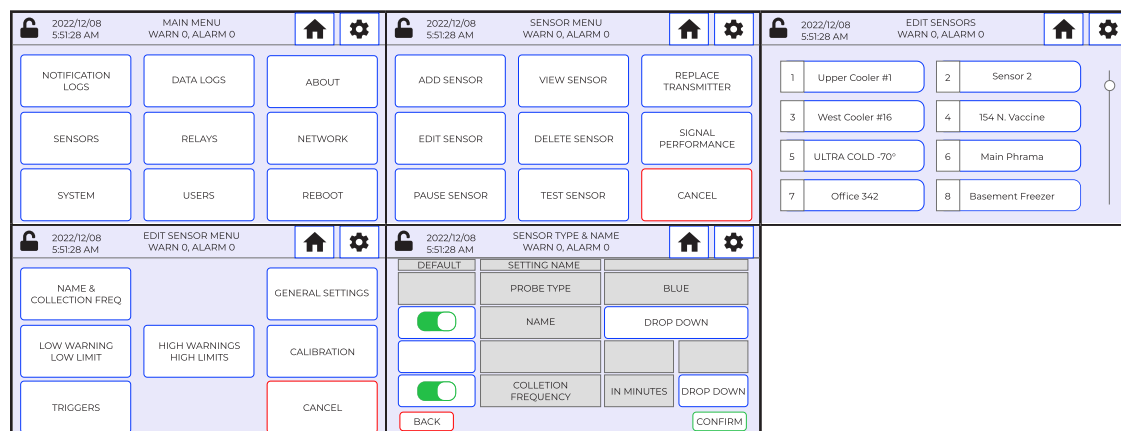

Edit Sensor Collection Frequency

To edit the collection frequency of a sensor, perform the following procedure starting at the [Main Menu](#):

1. At [Main Menu](#) tap **Sensors** > **Edit Sensor** and tap on desired sensor.
2. At Edit Sensor Menu tap **Name & Collection Frequency**.
3. Tap on toggle next to collection frequency to enable or disable feature to edit.
4. Tap **Confirm** to activate once changes have been made.

Note: Editing sensor parameters is recorded in the [Event Log](#).

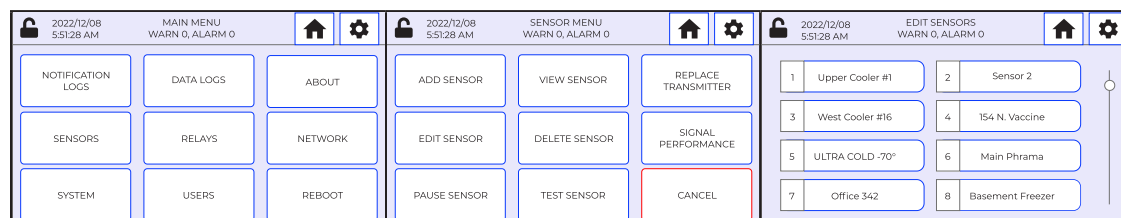

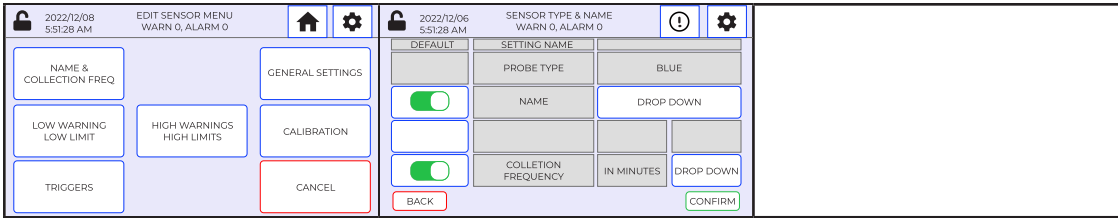

Edit Sensor Unit of Measure

Note: Not all sensors allow Unit of Measure (UoM) to be changed.

To edit the parameters of a sensor, perform the following procedure starting at the Main Menu:

1. At Main Menu tap **Sensors** > **Edit Sensor** and tap on desired sensor.
2. At Edit Sensors Menu tap **General Settings**.
3. Tap on desired feature to edit.
4. Tap **Confirm** to activate.

Note: Editing sensor parameters is recorded in the Event Log.

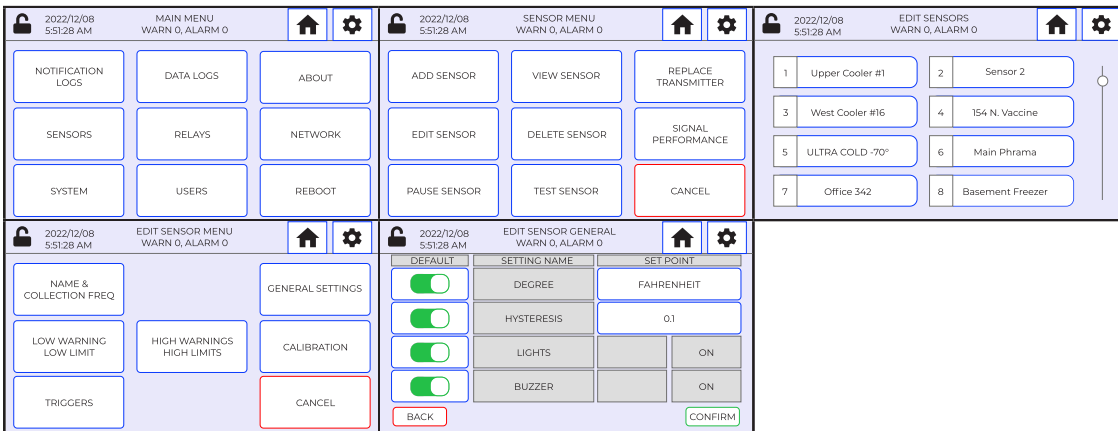

Edit Sensor Hysteresis

To edit the hysteresis of a sensor, perform the following procedure starting at the Main Menu:

1. At Main Menu tap **Sensors** > **Edit Sensor** and tap on desired sensor.
2. At Edit Sensor Menu tap **General Settings**.
3. Tap on desired feature to edit.
4. Tap **Confirm** to activate.

Note: Editing sensor parameters is recorded in the Event Log.

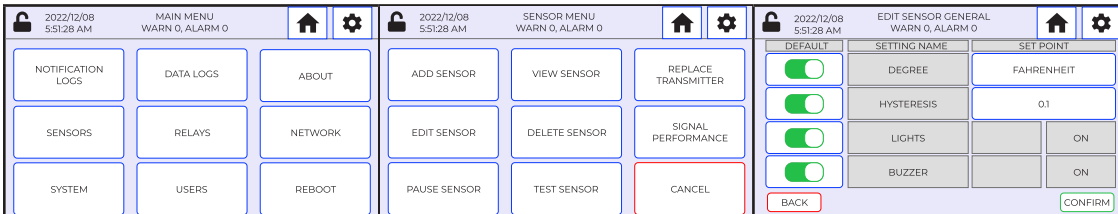

Edit Sensor Light (Visual Warning)

To edit the light (visual warning) of a sensor, perform the following procedure starting at the Main Menu:

1. At Main Menu tap **Sensors** > **Edit Sensor** and tap on desired sensor.
2. At Edit Sensor Menu tap **General Settings**.
3. Tap on desired feature to edit.
4. Tap **Confirm** to activate.

Note: Editing sensor parameters is recorded in the Event Log.

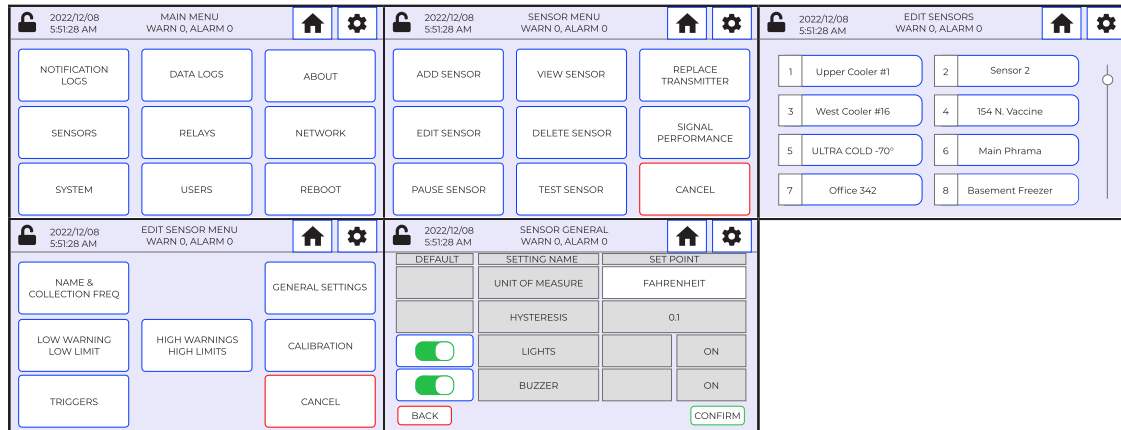

Edit Sensor Buzzer (Audible Warning)

To edit the buzzer (audible warning) of a sensor, perform the following procedure starting at the Main Menu:

1. At Main Menu tap **Sensors** > **Edit Sensor** and tap on desired sensor.
2. At Edit Sensor Menu tap **General Settings**.
3. Tap on desired feature to edit.
4. Tap **Confirm** to activate.

Note: Editing sensor parameters is recorded in the Event Log.

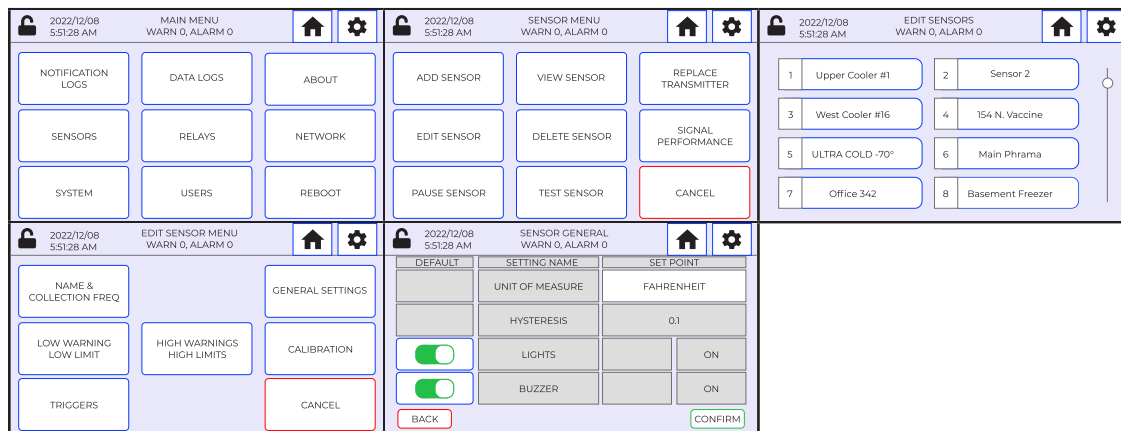

Edit Sensor Relay Assignment

To edit the relay of a sensor setting, perform the following procedure starting at the Main Menu:

1. At Main Menu tap **Sensors** > **Edit Sensor** and tap on desired sensor.
2. At Edit Sensor Menu tap **General Settings**.
3. Tap on desired feature to edit (degrees, hysteresis, lights, and buzzer) and tap **Confirm** to activate.
4. Tap on desired feature to edit (relay, warnings) and tap **Confirm** to activate.

Note: Editing sensor parameters is recorded in the Event Log.

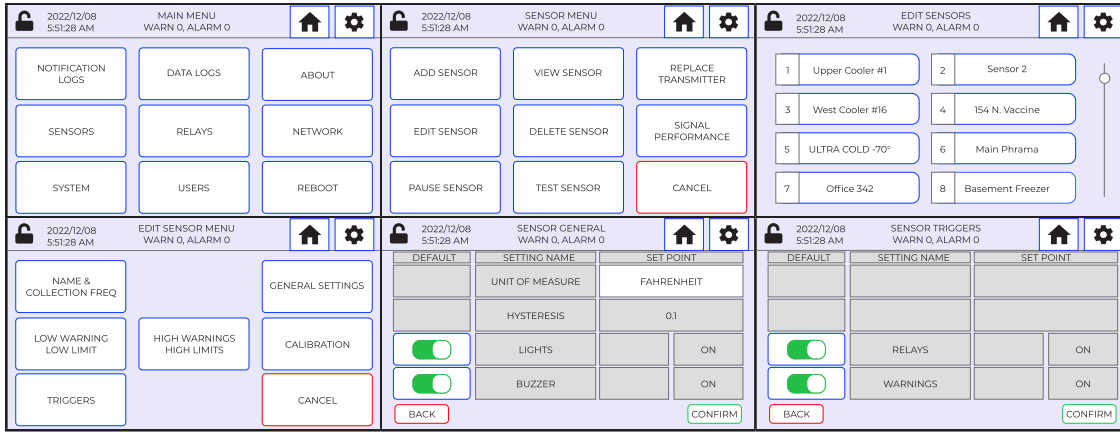

Edit Sensor Warnings

To edit the warnings of a sensor, perform the following procedure starting at the Main Menu:

1. At Main Menu tap **Sensors** > **Edit Sensor** and tap on desired sensor.
2. At Edit Sensor Menu tap **General Settings**.
3. Tap on desired feature to edit (degrees, hysteresis, lights, and buzzer) and tap **Confirm** to activate.
4. Tap on desired feature to edit (relay, warnings) and tap **Confirm** to activate.

Note: Editing sensor parameters is recorded in the Event Log.

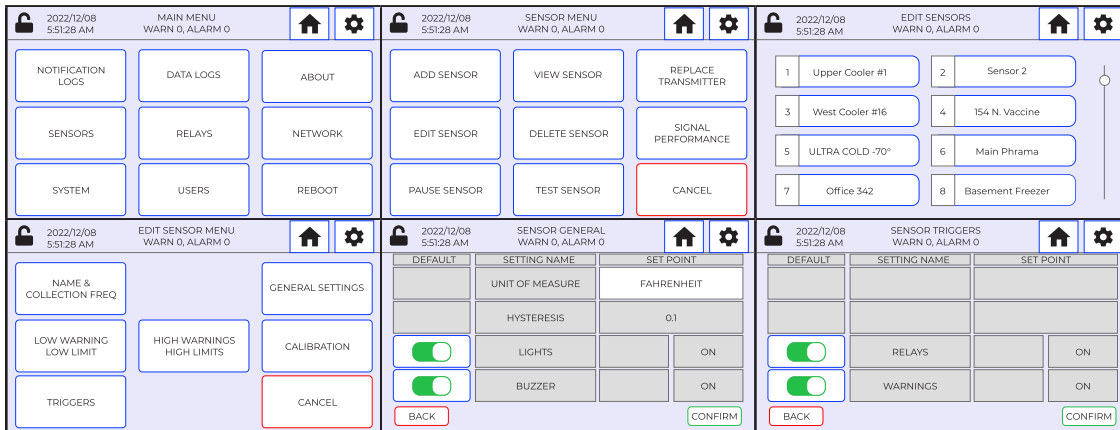

Edit Sensor High Warnings or High Limits

To edit sensor high warnings or high limits, perform the following procedure starting at the Main Menu:

1. At Main Menu tap **Sensors** > **Edit Sensor** and tap on desired sensor.
2. At Edit Sensor Menu tap **High Warning High Limits**.
3. Modify desired defaults and tap **Confirm** to activate.

Note: Editing sensor parameters is recorded in the Event Log.

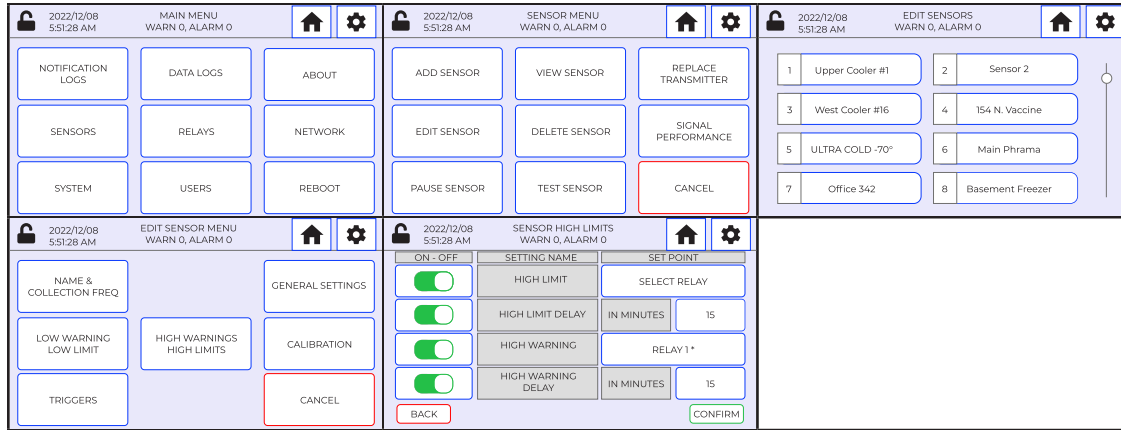

Edit Sensor Low Warnings or Low Limits

To edit sensor low warnings or low limits, perform the following procedure starting at the Main Menu:

1. At Main Menu tap **Sensors** > **Edit Sensor** and tap on desired sensor.
2. At Edit Sensor Menu tap **Low Warning Low Limits**.
3. Modify desired defaults and tap **Confirm** to activate.

Note: Editing sensor parameters is recorded in the Event Log.

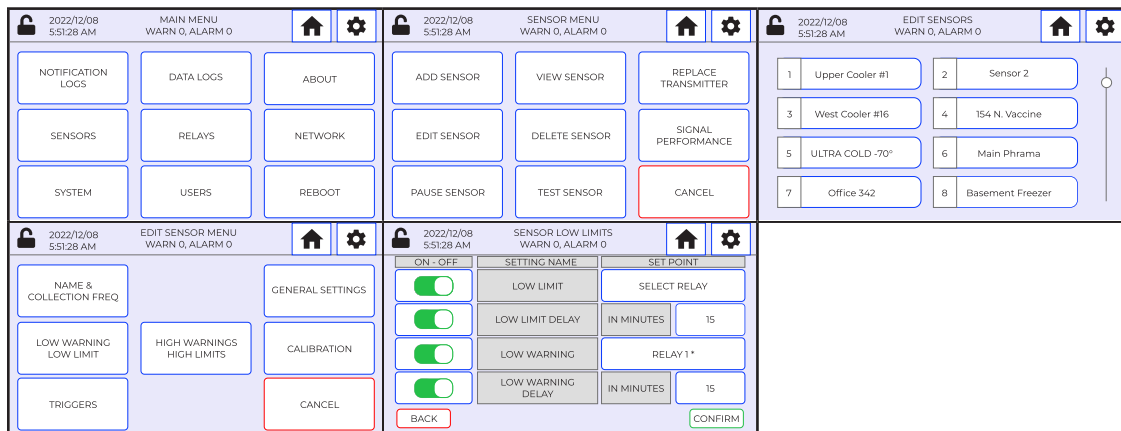

Edit Sensor Offset

To edit sensor schedule, perform the following procedure starting at the Main Menu:

1. At Main Menu tap **Sensors** > **Edit Sensor** and tap on desired sensor.
2. At Edit Sensor Menu tap **Offset**.
3. Modify desired defaults and tap **Confirm** to activate.

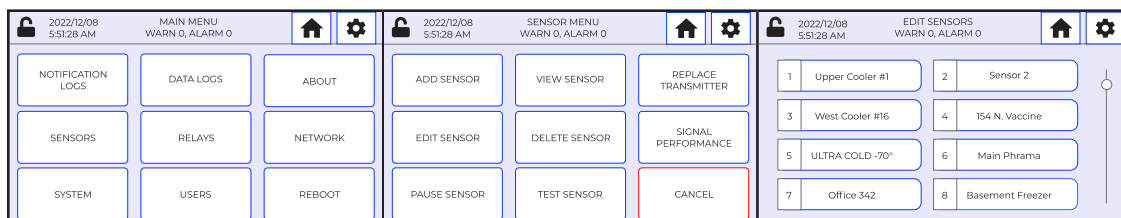

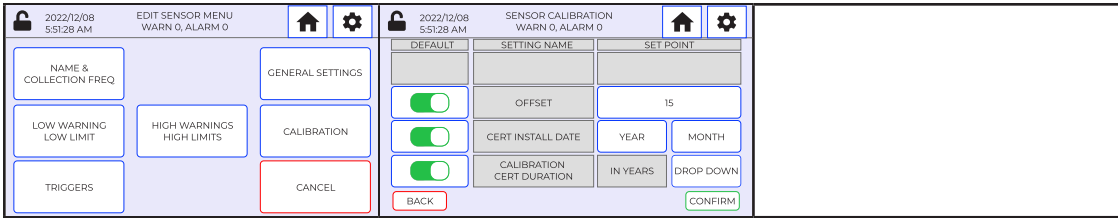

Edit Sensor Certificate Install Date

To edit calibration certification date, perform the following procedure starting at the Main Menu:

1. At Main Menu tap **Sensors** > **Edit Sensor** and tap on desired sensor.
2. At Edit Sensor Menu tap **Cert Install Date** drop-down for **Year** and **Month**.
3. Modify desired defaults and tap **Confirm** to activate.

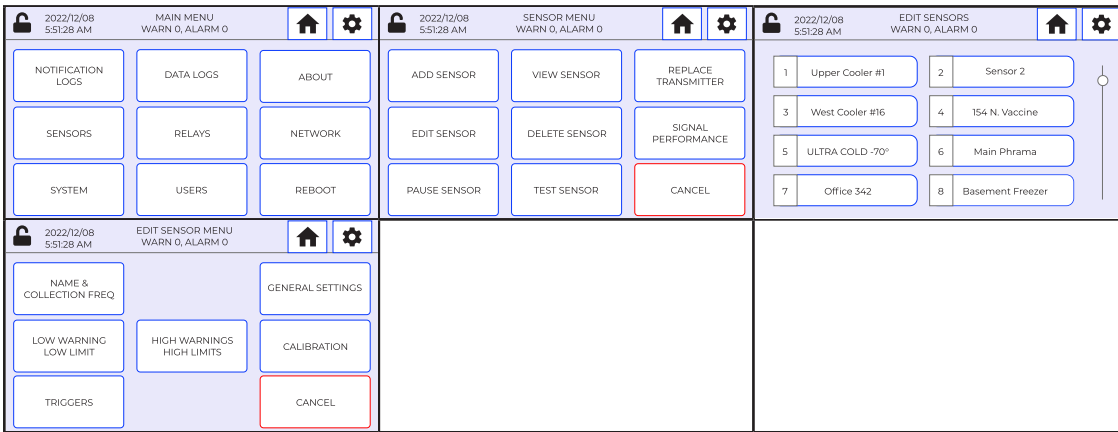

Edit Sensor Calibration Certification Duration

To edit sensor calibration certification duration, perform the following procedure starting at the Main Menu:

1. At Main Menu tap **Sensors** > **Edit Sensor** and tap on desired sensor.
2. At Edit Sensor Menu tap **Calibration Cert Duration** drop-down.
3. Modify desired defaults and tap **Confirm** to activate.

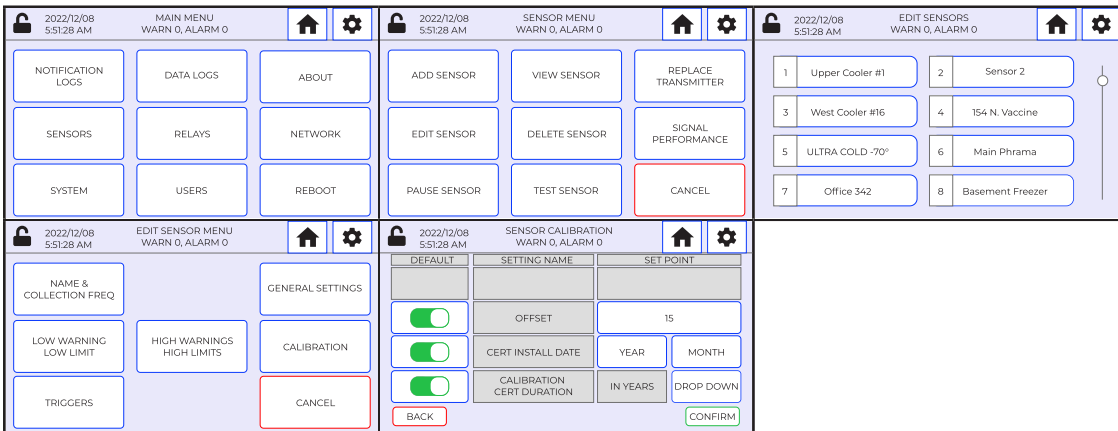

REPLACE WIRELESS TRANSMITTER

Note: As of firmware 22.12.29 this feature is not enabled. Instead a user can edit the configuration file and reload with proper RF MAC address.

To replace an existing wireless transmitter with new wireless transmitter of the same kind, perform the following procedure starting at the Main Menu:

1. At Main Menu tap **Sensors** > **Replace Transmitter**.
2. At Edit Sensors, verify the transmitter ID number shown on screen is the same as the ID number on the transmitter PCB board, and then tap on desired transmitter.
3. Tap **Confirm** to activate.

Note: Replacing a wireless transmitter is recorded in the Event Log.

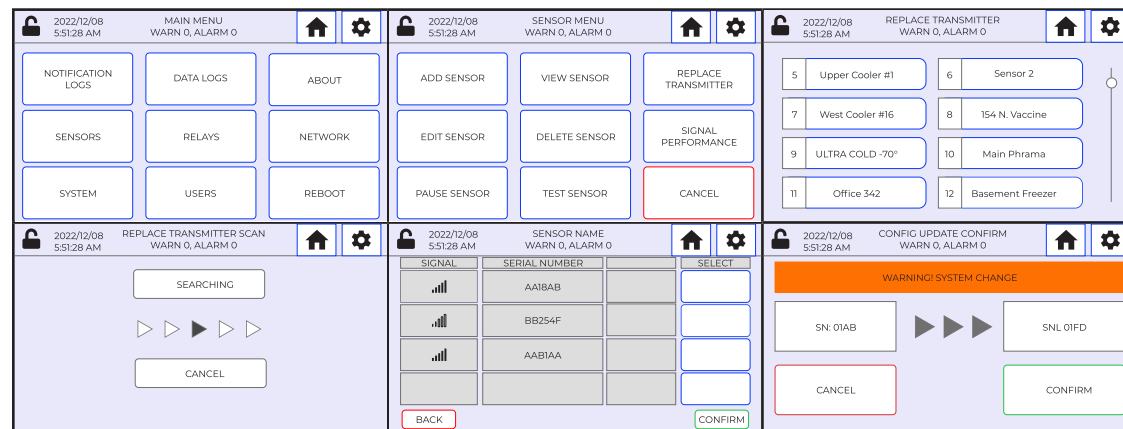

DELETE SENSOR

To delete a sensor, perform the following procedure starting at the Main Menu:

1. At Main Menu tap **Sensors** > **Delete Sensor** and tap on desired sensor.
2. Tap on drop-down to select user.
3. Enter PIN code.
4. Tap **Confirm** to delete sensor.

Note: Deleting a sensor is recorded in the Event Log.



PAUSE SENSOR

Note: As of firmware 22.12.29 this feature is not enabled.

To prevent false alarms when performing maintenance, pause monitoring of specific sensors.

Pausing a sensor stops monitoring and ignores active alarms for a specified period of time based on the drop-down. When the pause function times out or is canceled, monitoring automatically starts.

To pause monitoring of a sensor, perform the following procedure starting at the Main Menu:

1. At Main Menu tap **Sensors** > **Pause Sensor** and tap on desired sensor.
2. Set the desired pause time in 4 hour increments or set to DISABLE to cancel the pause function.
3. Tap on drop-down to select user.
4. Enter PIN code.
5. Tap **Confirm** to activate.

Note: Pausing a sensor is recorded in the Event Log.

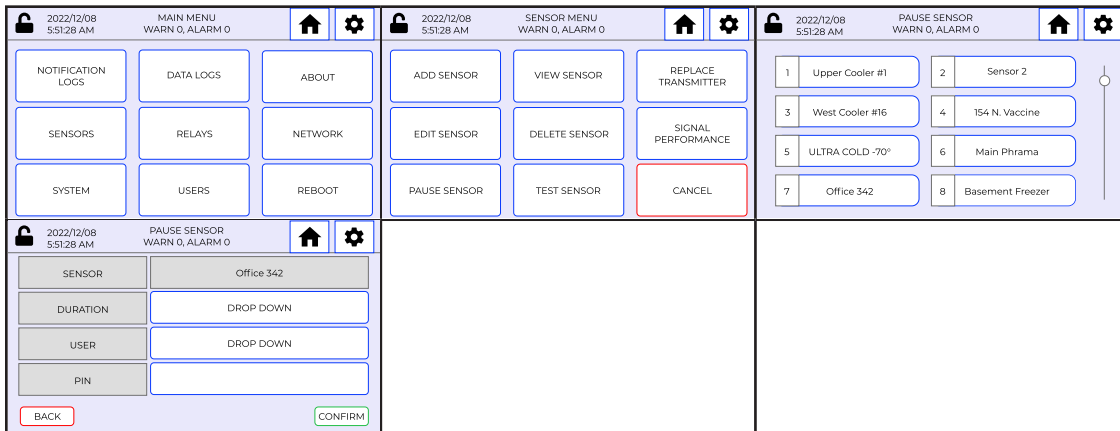

TEST SENSOR

The system will test a sensor's functionality. To test a sensor, perform the following procedure starting at the Main Menu:

1. At Main Menu tap **Sensors** > **Test Sensor** and tap on desired sensor.
2. Tap on desired function to test:
 - a. Low Warning
 - b. High Warning
 - c. Low Limit
 - d. High Limit
3. Tap **Cancel** to return to sensor menu.

Note: Testing a sensor is recorded in the Event Log.

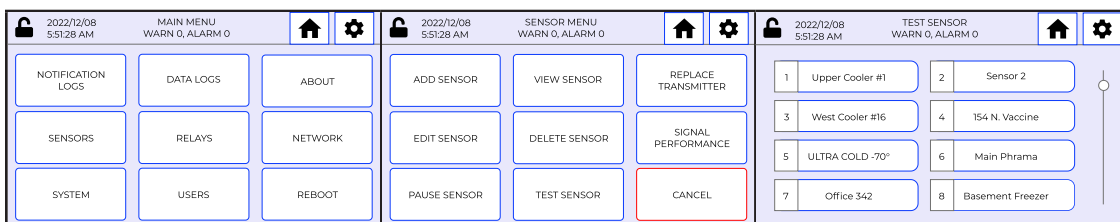



EDIT USER

User PIN or security level may need to be modified. If a user email address (name) needs to be modified, delete the user and add a new user.

To edit users, perform the following procedure starting at the [Main Menu](#):

1. At [Main Menu](#) tap **Users** > **Edit User**.
2. Modify as desired.
3. Tap **Confirm** to activate.

Note: Editing a user is recorded in the [Event Log](#).

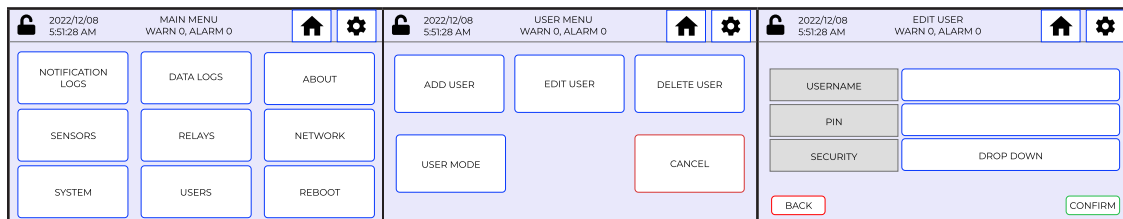

DELETE USER

To delete users, perform the following procedure starting at the [Main Menu](#):

1. At [Main Menu](#) tap **Users** > **Delete User** and tap on desired user to select for deletion.
2. Enter PIN number.
3. Tap **Confirm** to activate.

Note: Deleting a user is recorded in the [Event Log](#).

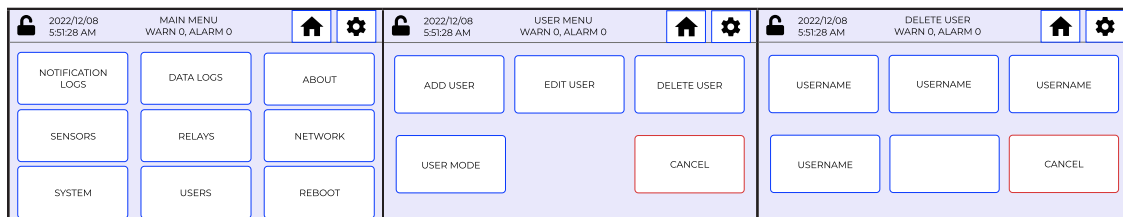

CONFIGURE USER MODE

To configure user mode, perform the following procedure starting at the [Main Menu](#):

1. At [Main Menu](#) tap **Users** > **User Mode**.
2. At [User Mode](#) select **Local Mode** or **Online Mode**.

Note: Configuring user modes is recorded in the [Event Log](#).

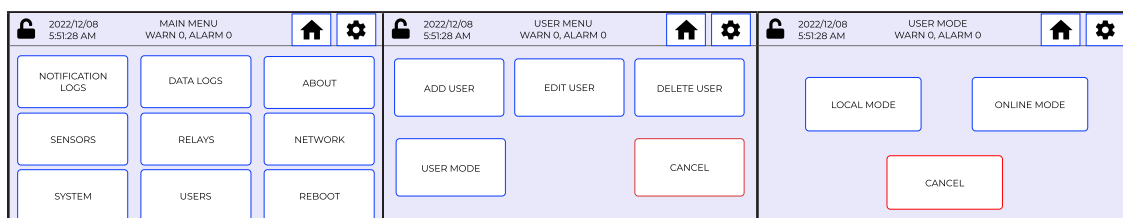

SYNC USERS

Note: As of firmware 22.12.29 this feature is not enabled.

To sync users between [INSIGHT](#) (sold separately) and local programming, perform the following procedure starting at the [Main Menu](#):

1. At Main Menu tap **Users > Sync Users**.

Note: Syncing users is recorded in the [Event Log](#).

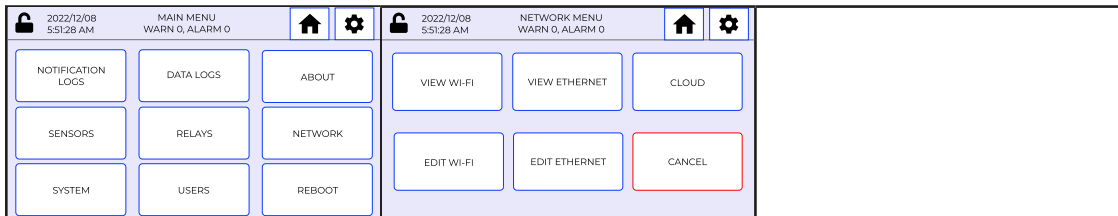

SAVE SYSTEM CONFIGURATION

Save System Configuration to USB

To save system configuration to USB, perform the following procedure starting at the [Main Menu](#):

1. Insert USB.
2. At Main Menu tap **System > Configuration > Save Config > Save to USB**.
3. Configuration file will save to main directory of USB and screen will show a small pop up to state file saved and press **OK**.
4. Remove USB.

Note: System configuration changes are recorded in the [Event Log](#).

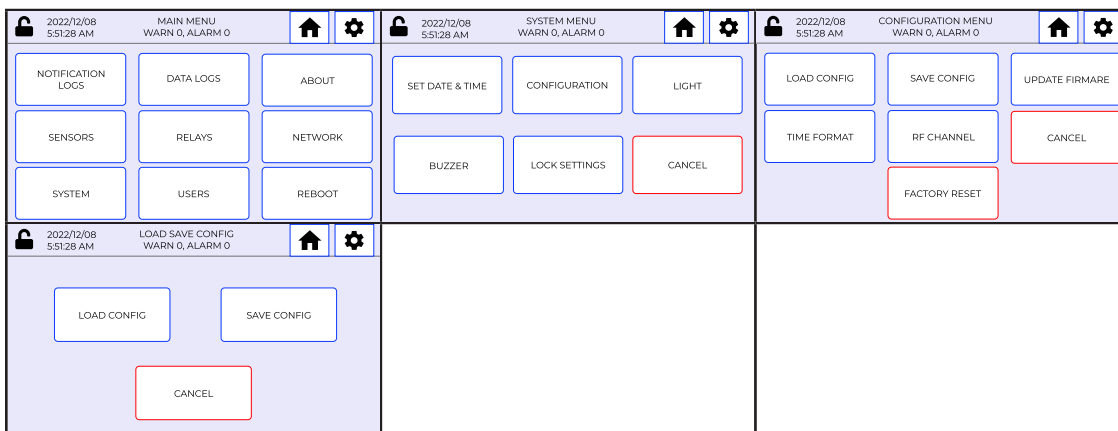

Save System Configuration to [INSIGHT](#)

As of firmware 22.12.29 this feature is not enabled.

To save system configuration to [INSIGHT](#) (sold separately), perform the following procedure starting at the [Main Menu](#):

1. At Main Menu tap **System > Configuration > Save Config > Save to [INSIGHT](#)**.
2. Configuration file will save to [INSIGHT](#) (sold separately) and screen will show a small pop up to state file saved and press **OK**.

Note: System configuration changes are recorded in the [Event Log](#).

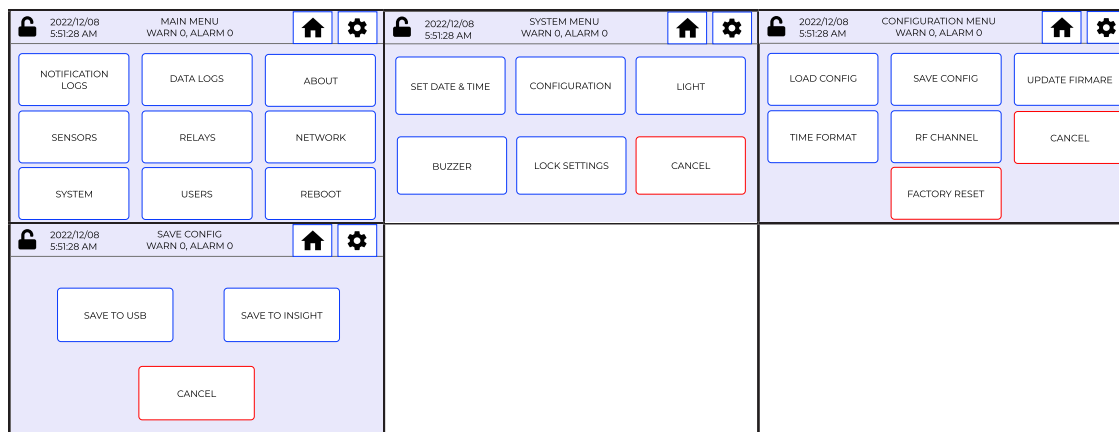

EDIT NETWORK WI-FI

Edit Network Wi-Fi Manually

To edit network Wi-Fi settings manually, perform the following procedure starting at the [Main Menu](#):

Note: Ensure the Wi-Fi [Network Toggle](#) is enabled.

1. At Main Menu tap **Network** > **Edit Wi-Fi** > **Manual**.
2. Enter Network Name.
3. Enter network Password.
4. Tap to select Security.
5. Tap **Confirm** to activate.
6. Reboot the device.

Note: Editing network Wi-Fi is recorded in the [Event Log](#).

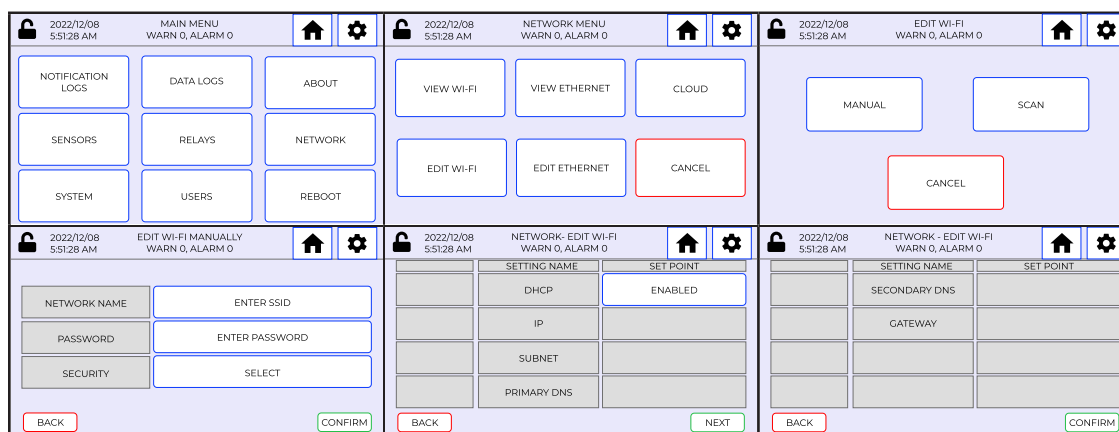

Edit Network Wi-Fi Scan

To edit network Wi-Fi settings by scanning, perform the following procedure starting at the [Main Menu](#):

Note: Ensure Wi-Fi [Network Toggle](#) is enabled.

1. At Main Menu tap **Network** > **Edit Wi-Fi** > **Scan** and tap **Select Network** to see available 2.4GHz access points.

Note: Access Points (AP) and Extenders/Repeaters will show as different networks even if they have the same name. If you do not see your network after scanning, you may need to move the *EAPro*[®]-Gateway closer to the AP.

2. Enter network Password.
3. Tap **Confirm** to activate.

Note: Editing network Wi-Fi is recorded in the Event Log.

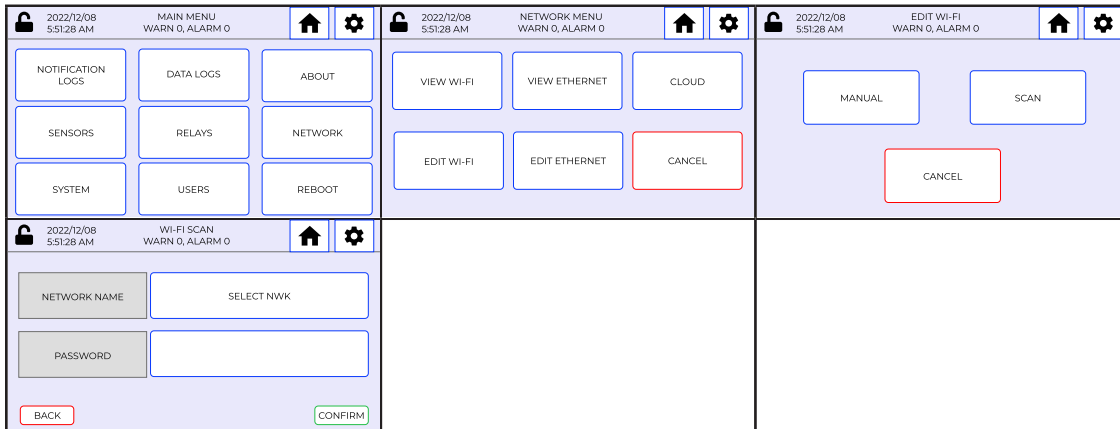

EDIT ETHERNET SETTINGS

To edit network Ethernet settings, perform the following procedure starting at the Main Menu:

Note: Ensure Ethernet Network Toggle is enabled.

1. At Main Menu tap **Network** > **Edit Ethernet**.

Note: If Dynamic Host Configuration Protocol (DHCP) is enabled, the rest of the settings will be greyed out.

2. Modify settings as needed if DHCP is disabled.
3. Tap **Confirm** to return to Network menu.

Note: Editing Ethernet settings is recorded in the Event Log.

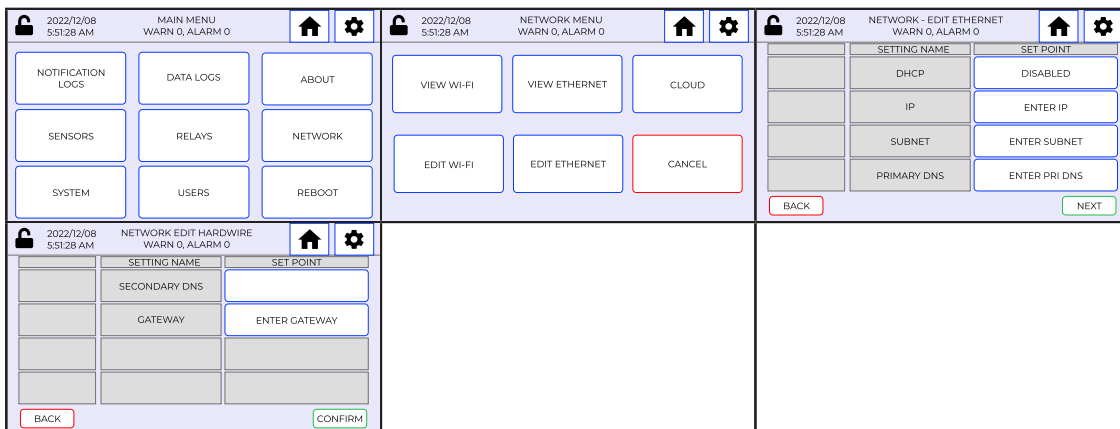

Enable/Disable Cloud

To enable or disable Cloud (**INSIGHT**), perform the following procedure starting at the Main Menu:

1. At Main Menu tap **Network** > **Cloud**.
2. Tap on the setpoint for **Cloud** to be enabled or disabled.
3. Tap on **Confirm**.

Note: Enabling and disabling the Cloud is recorded in the Event Log.

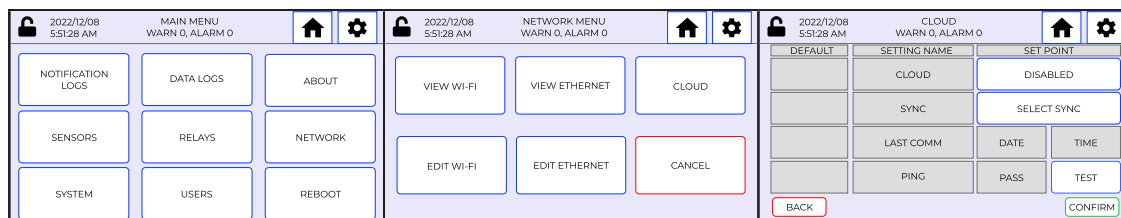

Troubleshoot Ethernet

To troubleshoot Ethernet settings, perform the following procedure starting at the Main Menu:

Note: Ensure Network Toggle is enabled and either Wi-Fi or Ethernet is configured.

1. At Main Menu tap **Network > Cloud**.
2. Tap **Test** to validate PING to DNS.
3. Validate pass/fail to DNS.

Note: Troubleshooting Cloud is recorded in the Event Log.

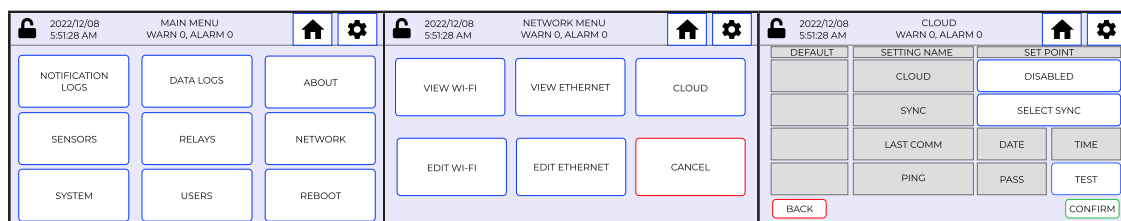

UPDATE FIRMWARE

NOTE:

Firmware updates will force the clock to stop until the process is complete. It is highly recommended to backup all data and sensor configurations prior to any firmware changes. Firmware updates will often take 5 minutes.

Winland recommends disabling both Network Toggles. If updating RF sensors, it's important to ensure you have fresh batteries and the transmitters are close to the GW. It is often required to update one RF at a time.

If you are not able to see the firmware from the USB, and "Press OK to continue" never shows, the USB is not allowing the device to read the file properly. You may need to reboot the device and try another USB. USB must be in FAT32 format.

USB models known to work:

- SanDisk: Cruzer Glide 32GB: SDCZ60-032G
- SanDisk: Ultra USB 3.0 128GB: SDCZ48-128G
- Samsung: FIT Plus USB 3.1: MUF-32AB/AM

As of firmware 22.12.29 event logs do not display firmware updates.

Update Firmware from USB

To update the firmware from USB, perform the following procedure starting at the Main Menu:

1. Insert USB.
2. At Main Menu tap **System > Configuration > Update Firmware > Load from USB**

3. Select desired firmware file and tap **Confirm** to activate.
4. Review revision changes and tap **Confirm** to load from USB.
5. Clock will stop and after few moments, the device will state: Firmware XX.XX.XX ready to be applied. Press **OK** to continue.
6. Reboot the unit, and validate firmware on boot or at Main Menu tap **About**.

Note: Firmware updates are recorded in the Event Log.

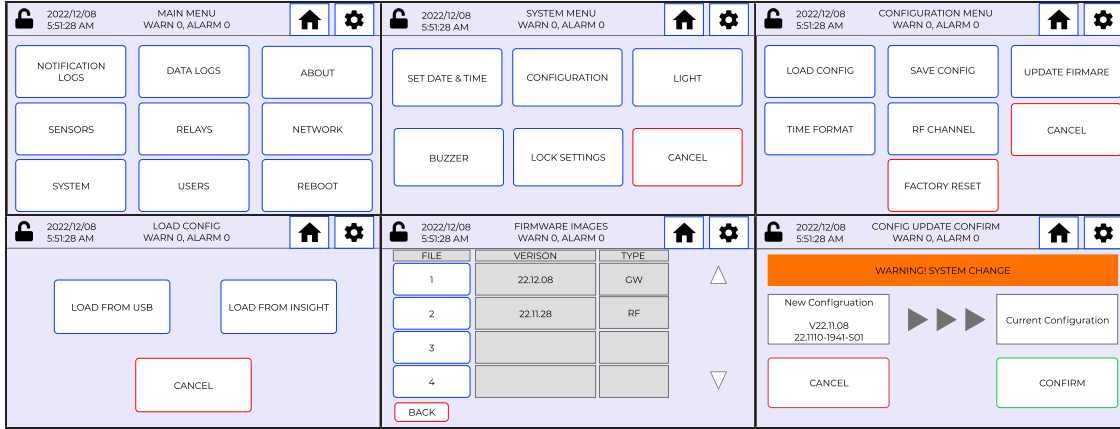

Update Firmware from **INSIGHT**

As of firmware 22.12.29 this feature is not enabled.

To update the firmware from **INSIGHT** (sold separately), perform the following procedure starting at the Main Menu:

1. At Main Menu tap **System** > **Configuration** > **Update Firmware** > Load from **INSIGHT**.
2. Scroll to and tap on desired firmware file and tap **Confirm** to activate.
3. Review warning and tap **Confirm** to load from **INSIGHT**.

Note: Firmware updates are recorded in the Event Log.

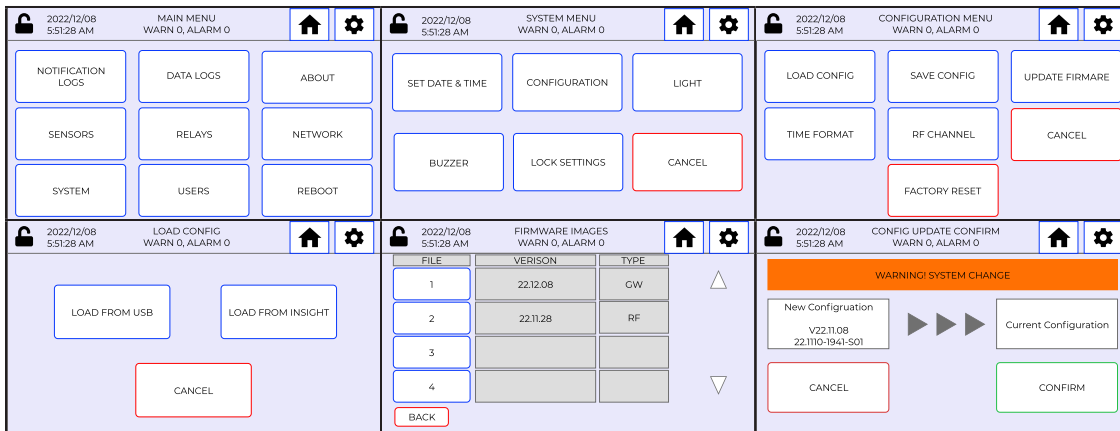

FACTORY RESET



Resetting to factory defaults erases all data except the event logs. Resetting to factory defaults will result in data loss.

Note: EAPro®-Gateway will need to be rebooted after a factory reset.

Note: Resetting to factory defaults does not delete the [Event Log](#).

To reset all parameters to factory defaults, perform the following procedure starting at the [Main Menu](#):

1. At Main Menu tap **System > Configuration > Factory Reset**.
2. Enter PIN number and tap **Confirm** to activate.

Note: Factory resets are recorded in the [Event Log](#).

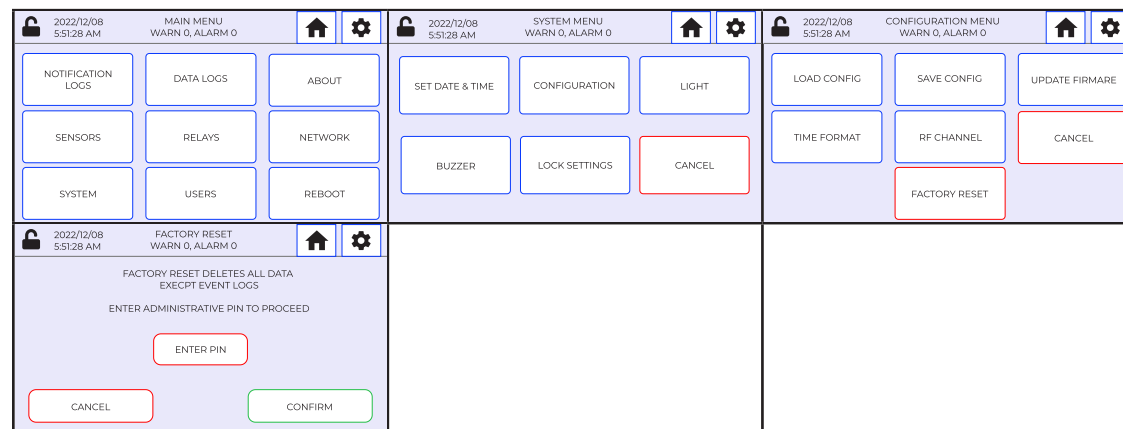

REBOOT SYSTEM

Occasionally, the system will need to be rebooted.

To reboot the system, perform the following procedure starting at the [Main Menu](#):

1. At Main Menu tap **Reboot**.
2. Tap **Confirm** to activate.

Note: Rebooting the system may take a few minutes. The system will flash the boot screen as the reboot process occurs. When the reboot process is completed, the Home screen displays.

Note: System reboots are recorded in the [Event Log](#).

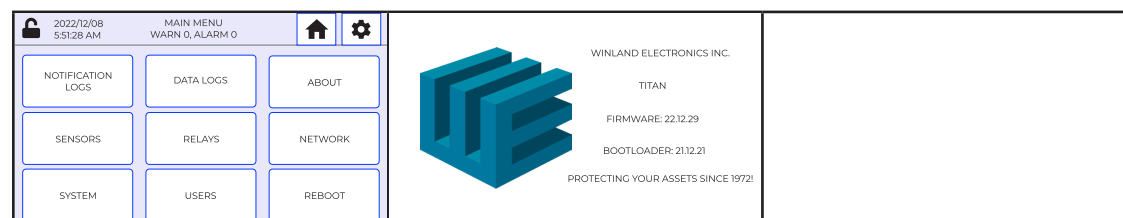

TROUBLESHOOTING

Operating or setup errors are indicated by flashing data on the display. A programming error may result in an alarm for a misprogrammed relay. Table 21 lists and describes common error symptoms, causes, and corrective actions. For updated information, go to the FAQ on the *EAPro*[®]-Gateway website.

Table 22: Troubleshooting

SYMPTOM	CAUSE	CORRECTIVE ACTION
Temperature reading indicates maximum when temperature is actually less.	Wired sensor is shorted.	Ensure the sensor connection is not shorted. A short equals zero resistance and thus the maximum value.
	Wire sensor cable has a short.	Replace damaged cable.
	Sensor has failed.	Replace if physically damaged. Contact Winland Technical Support.
Temperature reading indicates minimum when temperature is actually greater.	Wired sensor is not connected.	Ensure the sensor is connected to the correct header pins. An open connection equals an infinite resistance and thus the minimum value.
	Wired sensor cable has an open.	Replace damaged cable.
	Sensor has failed.	Replace if physically damaged. Contact Winland Technical Support.
Temperature display does not equal actual temperature.	Incorrect sensor programmed.	Verify the actual sensor connected to the sensor input is programmed appropriately. Each temperature sensor is limited to a specific operating range.
	Incorrect temperature scale.	Verify display and known correct value are both in same scale (example: both in °C).
Display flashes repeatedly between the Winland Electronics Inc. screen and a blank screen.	The <i>EAPro</i> [®] -Gateway reboots repeatedly and fails to successfully complete the boot process.	Cycle power to the <i>EAPro</i> [®] -Gateway and wait for a period (30 seconds) of time before reapplying power. If a USB drive is attached to the USB port, remove it and cycle power as noted above. If problem recurs, contact Winland Technical Support.
The display flashes while displaying the Active Alarms screen.	A sensor's reading has exceeded a set limit.	Verify the environmental condition of the sensor.
	A wireless sensor is not communicating with the <i>EAPro</i> [®] -Gateway.	Verify the received signal strength.
		Verify the wireless sensor has a charged battery.

WINLAND TECHNICAL SUPPORT

Winland Technical Support is available Monday through Friday from 8:00am to 5:00pm Central at 1-800-635-4269, techsupport@winland.com and eapro.winland.com.

SPECIFICATIONS

This section lists the specifications for the EAPro®-Gateway, sensors, and accessories.

EAPro®-Gateway Specifications

Specifications for the EAPro®-Gateway are listed in Table 22.

Table 23: Specifications: EAPro®-Gateway

ITEM	SPECIFICATION																
Dimension	8.13" H x 5.52" W x 1.93" D (20.6cm x 14.0cm x 4.9cm)																
Weight	1.1 lb (1 lb, 2oz) Including the battery pack.																
Mounting	Standard 3-gang electrical box or mount directly to drywall or similar surface using appropriate anchors (included).																
Case Material	ABS, UL94V-0 rated.																
Power In Specification	12 to 24VDC @ 1A. Note: NFPA 72-2022 10.3.5: At 85% and 110% of primary. Note: Standard commercial filtered and regulated power supply suitable supplied by AC adapter (not included; see Accessories) or alarm panel. Note: Power supply requirement does not include additional requirements for loads switched through alarm output relays, or third party sensors such as 4-20mA where power is derived from terminal strip connections.																
Power Out	Equivalent to DC input voltage used: 12 to 24VDC. (Maximum output current 100mA).																
Real-Time Clock Battery	CR2032 (3V Cell).																
Radiating Power	Max EIRP (US): Gateway = 15.44 dBm Sensor = 11.9 dBm Max EIRP (CE) Gateway = 8.48 dBm Sensor = 5.996 dBm																
Wireless Sensitivity (minimum at PCB antenna input)	-94.5 dBm																
7 RF Channels (Both CE/US)	<table border="1"> <thead> <tr> <th>Channel</th> <th>Frequency (MHz)</th> </tr> </thead> <tbody> <tr> <td>1</td> <td>2405</td> </tr> <tr> <td>2</td> <td>2414</td> </tr> <tr> <td>3</td> <td>2427</td> </tr> <tr> <td>4</td> <td>2440</td> </tr> <tr> <td>5</td> <td>2453</td> </tr> <tr> <td>6</td> <td>2466</td> </tr> <tr> <td>7</td> <td>2479</td> </tr> </tbody> </table>	Channel	Frequency (MHz)	1	2405	2	2414	3	2427	4	2440	5	2453	6	2466	7	2479
Channel	Frequency (MHz)																
1	2405																
2	2414																
3	2427																
4	2440																
5	2453																
6	2466																
7	2479																
Sensors	Up to four (4) wired sensors. Up to 30 wireless sensors.																
Cable Length	Wireless Multi-Function Transmitter: 1000' (304 m) max																
	Wired Temp Sensor: 2-wire; 1000' (304 m) max. Using 22 AWG twisted pair recommended.																
	Wired Humidity Sensor: 3-wire; 1000' (304 m) max. Using 22 AWG recommended.																
	Wired Water Presence Sensor: 2-wire; 1 Sensor: 1000' (304 m) max using 22 AWG minimum. 2 Sensors: 500' (152 m) max using 22 AWG minimum. 2+ Sensors: 200' (60 m) max using 22 AWG minimum.																
	Wired 4–20mA sensor: EAPro®-Gateway load (100Ω maximum)																

Relay Outputs	Five (5) Form C with 3-terminal N.C./C/N.O. connections Note: There are 4 primary relays and 1 auxiliary relay.
Relay Contact Ratings	Four (4) Form C @ 1A resistive. One (1) Form C @ 3A resistive.
Relay Logic	Each relay is user configurable.
Touchscreen Display	480 x 272 PX touchscreen
Ethernet	10/100BASE-TX/FX; fully compliant to IEEE 802-3u standard
Device Operating Range	Temperature: 32 F to 122 F (0 C to 50 C) Not for installation inside coolers or freezers, use sensors/probes to go inside coolers or freezers.
	Humidity: 5 to 95% RH, non-condensing
	Ambient Environmental Quality: Indoor use intended, noncorrosive environment
Conformity Certifications	FCC Part 15, Subpart C, Class B RSS 102 Issue 5 RSS 247 Issue 2 NRTL MET certification mark
Warranty	One (1) year limited warranty. See Warranty and Service Information.
Note 1: Where required, this equipment is to be isolated from the mains supply by a limited power source as specified in EN61010-1.	
Note 2: All terminals must be connected to a Class 2 Power Limited Circuit complying with the National Electrical Code NFPA 70, Article 725.	

Sensor Specifications

Specifications for Winland sensors used with the EAPro[®]-Gateway are listed in Table 23.

Table 24: Specifications: Sensors

ITEM	SPECIFICATION
Dimension	Wireless sensor: 3.67" x 2.65" x 1.17" (9.3 x 6.7 x 2.9 cm) HA-III+: 3.25" x 1.5" x 1" (8.2 x 3.7 x 2.5 cm) W-S-S: 2" x 3" x 0.88" (5.1 x 7.6 x 2.2 cm)
Weight	Wireless sensor: 0.26 lb (0.11 kg) with batteries HA-III+: 5 oz (0.14 g) W-S-S: 2.4 oz (0.07 kg)
Power Specification	Wireless sensor: 12 VDC @ 100mA using a 2.1 mm barrel plug, center positive, OR 2xAA Alkaline Batteries (1.5V Cell)
Wireless Sensor Radiation (minimum, at PCB antenna connector)	-2.5 dBm
Wireless Sensitivity (minimum, at PCB antenna connector)	-95.5 dBm

Accessory Specifications

Accessories available for use with the EAPro[®]-Gateway are listed in Table 24.

Table 25: Specifications: Accessories

ITEM (MODEL NUMBER)	DESCRIPTION
TEMP-G-B	Glycerin Bottle
TEMP-B-T	Buffer Tube
TEMP-S-K	Flat Cable Splice Kit

SECTION LEFT BLANK

WARRANTY AND SERVICE INFORMATION

Winland Electronics, Inc. ("Winland") warrants to the original purchaser from Winland that each product of Winland's that it manufactures shall be free from defects in material and factory workmanship for a period of one (1) year from the date of purchase, when properly installed and operated under normal conditions according to Winland's instruction.

Winland's obligation under this limited warranty is limited to correcting the product without charge, at its factory any part or parts thereof which are returned, transportation charges prepaid, to the factory within one year of the date of purchase subject to Winland's examination showing to Winland's satisfaction to be covered by this warranty.

Product returns will not be accepted unless a Return Material Authorization has been issued by Winland, which is subject to purchaser's identification of the purchase order number and product serial number. UNAUTHORIZED RETURN SHIPMENT OR SHIPMENT CONTRARY TO WINLAND'S WRITTEN INSTRUCTIONS WILL VOID THIS LIMITED WARRANTY. Correction of such defects by repair, replacement or refund of the amount paid for the product, at Winland's option, shall constitute fulfillment of all Winland's obligations under this limited warranty. Repaired and replacement parts will be warranted for the remainder of the original product warranty. Repairs not covered by this limited warranty may be offered by Winland for a charge.

This limited warranty shall not apply to any of Winland's products which have been subject to misuse, negligence, accident or which have been repaired or altered outside of Winland's factory.

THIS LIMITED WARRANTY IS IN LIEU OF ALL OTHER WARRANTIES, EXPRESS OR IMPLIED, INCLUDING, WITHOUT LIMITATION, ANY WARRANTIES OF MERCHANTABILITY, FITNESS FOR PARTICULAR PURPOSES, NON-INFRINGEMENT, DESIGN, AND TITLE, AND ANY WARRANTIES ARISING FROM COURSE OF DEALING, USAGE OF TRADE OR OTHERWISE. ALL OTHER REPRESENTATIONS MADE TO THE END USER/PURCHASER BY ANY OTHER PARTY ARE EXCLUDED. No person, agent or dealer is authorized to give warranties on behalf of Winland nor to assume for Winland any other liability in connection with any Winland product.

Winland shall not be liable for loss, damage or expense resulting, directly or indirectly, from the use, malfunction or unavailability of its products or any other cause except as stated in this limited warranty.

WINLAND SHALL NOT BE LIABLE TO ANY PERSON FOR INDIRECT, SPECIAL, INCIDENTAL OR CONSEQUENTIAL DAMAGES OF ANY DESCRIPTION, WHETHER ARISING OUT OF WARRANTY OR OTHER CONTRACT, NEGLIGENCE, OTHER TORT, STRICT LIABILITY OR OTHERWISE. Under no circumstances shall Winland's liability under this limited warranty exceed the purchase price paid by the end user/purchaser for the product. The parties agree that the limitation of remedies in this document is an agreed upon allocation of risk and does not cause the remedy to fail of its essential purpose.

The sale of product by Winland and the terms in this document shall be governed by, construed and enforced in accordance with the laws of the State of Minnesota, U.S.A., and applicable U.S.A. federal laws, without giving effect to any choice of law rule that would cause the application of the laws of any other jurisdiction. To the fullest extent permitted by applicable law, with respect to any action of any nature whatsoever against Winland relating in any manner to Winland product, (a) it must be brought exclusively in the state and federal courts located in Minneapolis, Minnesota and the claimant consents to such jurisdiction and venue and waives any right to dismiss or transfer such action based on forum inconvenience, (b) ANY RIGHT TO A JURY TRIAL IS WAIVED, and (c) ANY RIGHT TO PARTICIPATE IN A CLASS ACTION IS WAIVED.

Duplication or distribution of this manual and any information contained within it is strictly prohibited without the express written permission of Winland. This manual is available electronically at eapro.winland.com. For assistance with this manual, contact Winland's Technical Support at 1-800-635-4269 or tech.support@winland.com, Monday through Friday from 8:00am to 5:00pm Central.

The information in this document has been carefully examined and is believed to be entirely reliable; however, no responsibility is assumed for inaccuracies.

EnviroAlert Professional®, and the Winland logo, are trademarks of Winland Electronics, Inc. in the U.S. Other product names and trademarks appearing in this manual are the property of their respective owners.