



FCC RF Test Report

APPLICANT : PAX Technology Limited
EQUIPMENT : Wireless Data Terminal
BRAND NAME : PAX
MODEL NAME : X5
FCC ID : V5PX5
STANDARD : FCC Part 15 Subpart C §15.225
CLASSIFICATION : (DXX) Low Power Communication Device Transmitter

The product was received on May. 22, 2019 and testing was completed on Nov. 25, 2019. We, Sporton International (Shenzhen) Inc., would like to declare that the tested sample has been evaluated in accordance with the test procedures and has been in compliance with the applicable technical standards.

The test results in this report apply exclusively to the tested model / sample. Without written approval of Sporton International (Shenzhen) Inc., the test report shall not be reproduced except in full.

Reviewed by: Derreck Chen / Supervisor

Approved by: Eric Shih / Manager



Sporton International (Shenzhen) Inc.

1/F, 2/F, Bldg 5, Shiling Industrial Zone, Xinwei Village, Xili, Nanshan, Shenzhen, 518055
People's Republic of China



TABLE OF CONTENTS

TABLE OF CONTENTS2

REVISION HISTORY3

SUMMARY OF THE TEST RESULT4

1. GENERAL DESCRIPTION5

 1.1 Applicant..... 5

 1.2 Manufacturer 5

 1.3 Product Feature of Equipment Under Test 5

 1.4 Product Specification of Equipment Under Test 6

 1.5 Modification of EUT 6

 1.6 Testing Location 7

 1.7 Test Software 7

 1.8 Applicable Standards..... 8

2. TEST CONFIGURATION OF EQUIPMENT UNDER TEST9

 2.1 Descriptions of Test Mode 9

 2.2 Connection Diagram of Test System 10

 2.3 Table for Supporting Units 11

 2.4 EUT Operation Test Setup 11

3. TEST RESULTS.....12

 3.1 AC Power Line Conducted Emissions Measurement 12

 3.2 20dB and 99% OBW Spectrum Bandwidth Measurement..... 14

 3.3 Frequency Stability Measurement 15

 3.4 Field Strength of Fundamental Emissions and Mask Measurement..... 16

 3.5 Radiated Emissions Measurement 18

 3.6 Antenna Requirements..... 21

4. LIST OF MEASURING EQUIPMENT22

5. UNCERTAINTY OF EVALUATION23

APPENDIX A. TEST RESULTS OF CONDUCTED EMISSION TEST

APPENDIX B. TEST RESULTS OF CONDUCTED TEST ITEMS

 B1. Test Result of 20dB Spectrum Bandwidth

 B2. Test Result of Frequency Stability

APPENDIX C. TEST RESULTS OF RADIATED TEST ITEMS

 C1. Test Result of Field Strength of Fundamental Emissions

 C2. Results of Radiated Emissions (9 kHz~30MHz)

 C3. Results of Radiated Emissions (30MHz~1GHz)

APPENDIX D. SETUP PHOTOGRAPHS



REVISION HISTORY

REPORT NO.	VERSION	DESCRIPTION	ISSUED DATE
FR952227D	Rev. 01	Initial issue of report	Jan. 16, 2020



SUMMARY OF THE TEST RESULT

Report Section	FCC Rule	Description of Test	Result	Remark
3.1	15.207	AC Power Line Conducted Emissions	Complies	Under limit 4.70 dB at 0.570MHz
3.2	15.215(c)	20dB Spectrum Bandwidth	Complies	-
	-	99% OBW Spectrum Bandwidth	Complies	-
3.3	15.225(e)	Frequency Stability	Complies	-
3.4	15.225(a)(b)(c)	Field Strength of Fundamental Emissions	Complies	Max level 59.46 dBμV/m at 13.560 MHz
3.5	15.225(d) & 15.209	Radiated Spurious Emissions	Complies	Under limit 3.23 dB at 40.670MHz
3.6	15.203	Antenna Requirements	Complies	-

Declaration of Conformity:
The test results with all measurement uncertainty excluded are presented in accordance with the regulation limits or requirements declared by manufacturers.
Comments and Explanations:
The declared of product specification for EUT presented in the report are provided by the manufacturer, and the manufacturer takes all the responsibilities for the accuracy of product specification.



1. General Description

1.1 Applicant

PAX Technology Limited

Room 2416, 24/F., Sun Hung Kai Centre, 30 Harbour Road, Wanchai, Hong Kong

1.2 Manufacturer

PAX Computer Technology (Shenzhen) Co., Ltd.

4/F, No.3 Building, Software Park, Second Central Science-Tech Road, High-Tech industrial Park, Shenzhen, Guangdong, P.R.C.

1.3 Product Feature of Equipment Under Test

Product Feature	
Equipment	Wireless Data Terminal
Brand Name	PAX
Model Name	X5
FCC ID	V5PX5
EUT supports Radios application	WCDMA/LTE/GNSS/NFC WLAN 2.4GHz 802.11b/g/n HT20/HT40 WLAN 5GHz 802.11a/n HT20/HT40 WLAN 5GHz 802.11ac VHT20/VHT40/VHT80 Bluetooth BR/EDR/LE
IMEI Code	Conducted: 353022100101986 /353022100101994 Conduction: 353022100102067/353022100102075 Radiation: N/A
HW Version	N/A
SW Version	N/A
EUT Stage	Production Unit

Remark: The above EUT's information was declared by manufacturer. Please refer to the specifications or user's manual for more detailed description.



1.4 Product Specification of Equipment Under Test

Standards-related Product Specification	
Tx/Rx Frequency Range	13.553 ~ 13.567MHz
Channel Number	1
20dBW	2.46 KHz
99%OBW	2.08 KHz
Antenna Type	Fixed Internal Antenna
Type of Modulation	ASK

Remark: The above EUT's information was declared by manufacturer. Please refer to the specifications or user's manual for more detailed description.

1.5 Modification of EUT

No modifications are made to the EUT during all test items.



1.6 Testing Location

Sporton International (Kunshan) Inc. is accredited to ISO/IEC 17025:2017 by American Association for Laboratory Accreditation with Certificate Number 5145.02.

Test Site	Sporton International (Kunshan) Inc.		
Test Site Location	No. 1098, Pengxi North Road, Kunshan Economic Development Zone Jiangsu Province 215300 People's Republic of China TEL : +86-512-57900158 FAX : +86-512-57900958		
Test Site No.	Sporton Site No.	FCC Designation No.	FCC Test Firm Registration No.
	03CH02-KS	CN1257	314309
Test Engineer	Carl NI		
Temperature	21-22°C		
Relative Humidity	41-42%		

Sporton International (Shenzhen) Inc. is accredited to ISO/IEC 17025:2017 by American Association for Laboratory Accreditation with Certificate Number 5145.01.

Test Site	Sporton International (Shenzhen) Inc.		
Test Site Location	1/F, 2/F, Bldg 5, Shiling Industrial Zone, Xinwei Village, Xili, Nanshan, Shenzhen, 518055 People's Republic of China TEL: +86-755-86379589 FAX: +86-755-86379595		
Test Site No.	Sporton Site No.		FCC Designation No.
	TH01-SZ	CO01-SZ	CN1256
Test Engineer	Jensen Wu	Bear Xiong	
Temperature	24-26°C	22~25°C	
Relative Humidity	50-53%	50~55%	
			421272

1.7 Test Software

Item	Site	Manufacture	Name	Version
1.	03CH02-KS	AUDIX	E3	6.2009-8-24a
2.	CO01-SZ	AUDIX	E3	6.120613b



1.8 Applicable Standards

According to the specifications of the manufacturer, the EUT must comply with the requirements of the following standards:

- ♦ 47 CFR Part 15 Subpart C §15.225
- ♦ ANSI C63.10-2013



2. Test Configuration of Equipment Under Test

2.1 Descriptions of Test Mode

Investigation has been done on all the possible configurations.

The following table is a list of the test modes shown in this test report.

Test Items	
AC Power Line Conducted Emissions	Field Strength of Fundamental Emissions
20dB Spectrum Bandwidth	Frequency Stability
Radiated Emissions 9kHz~30MHz	Radiated Emissions 30MHz~1GHz

The EUT pre-scanned in two NFC type, A, B. The worst type (type A) was recorded in this report.

Pre-scanned tests, X, Y, Z in three orthogonal panels to determine the final configuration (Y plane as worst plane) from all possible combinations.

Test Cases	
AC Conducted Emission	Mode 1 : LTE Band 4 Idle + Bluetooth Link + WLAN Link (2.4G) + NFC Tx + Earphone + Battery + USB Cable(Charging from Adapter)
Remark: For Radiated Test Cases, The tests were performance with Adapter , Earphone	

2.2 Connection Diagram of Test System

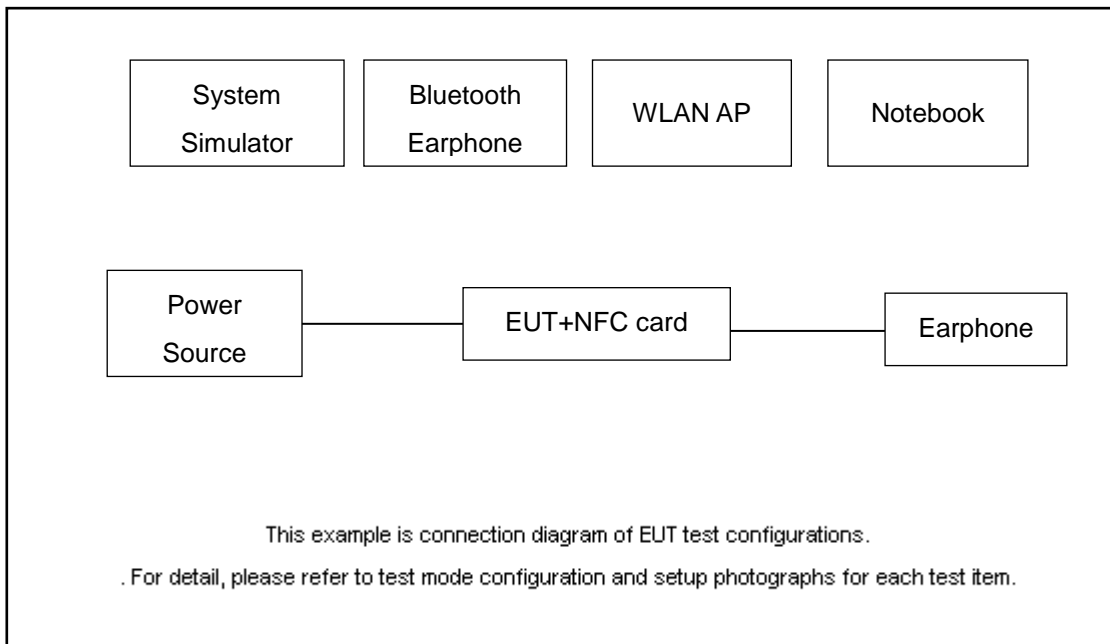

2.3 Table for Supporting Units

Item	Equipment	Trade Name	Model Name	FCC ID	Data Cable	Power Cord
1.	Base Station(LTE)	Anritsu	MT8820C	N/A	N/A	Unshielded,1.8m
2.	Bluetooth Earphone	Samsung	EO-MG900	PYAHS-107W	N/A	N/A
3.	Earphone	MOTO	N/A	N/A	N/A	N/A
4.	WLAN AP	Dlink	DIR-820L	KA2IR820LA1	N/A	Unshielded,1.8m
5.	NOTE BOOK	Lenovo	E540	FCC DoC	AC I/P : Unshielded, 1.2m DC O/P : Shielded, 1.8m	N/A
6.	NFC Card	N/A	N/A	N/A	N/A	N/A

2.4 EUT Operation Test Setup

The EUT was programmed to be in continuously transmitting mode.

The ancillary equipment, NFC card, is used to make the EUT (NFC) continuously transmit at 13.56MHz and is placed around 3 cm gap to the EUT.

3. Test Results

3.1 AC Power Line Conducted Emissions Measurement

3.1.1 Limit of AC Conducted Emission

For equipment that is designed to be connected to the public utility (AC) power line, the radio frequency voltage that is conducted back onto the AC power line on any frequency or frequencies within the band 150 kHz to 30 MHz shall not exceed the limits in the following table.

Frequency of Emission (MHz)	Conducted Limit (dB μ V)	
	Quasi-Peak	Average
0.15-0.5	66 to 56*	56 to 46*
0.5-5	56	46
5-30	60	50

*Decreases with the logarithm of the frequency.

3.1.2 Measuring Instruments

See list of measuring instruments of this test report.

3.1.3 Test Procedures

1. The EUT was placed 0.4 meter from the conducting wall of the shielding room, and it was kept at least 80 centimeters from any other grounded conducting surface.
2. Connect EUT to the power mains through a line impedance stabilization network (LISN).
3. All the support units are connecting to the other LISN.
4. The LISN provides 50 ohm coupling impedance for the measuring instrument.
5. The FCC states that a 50 ohm, 50 microhenry LISN should be used.
6. Both sides of AC line were checked for maximum conducted interference.
7. The frequency range from 150 kHz to 30 MHz was searched.
8. Set the test-receiver system to Peak Detect Function and specified bandwidth (IF Bandwidth = 9kHz) with Maximum Hold Mode. Then measurement is also conducted by Average Detector and Quasi-Peak Detector Function respectively.

3.1.4 Test setup

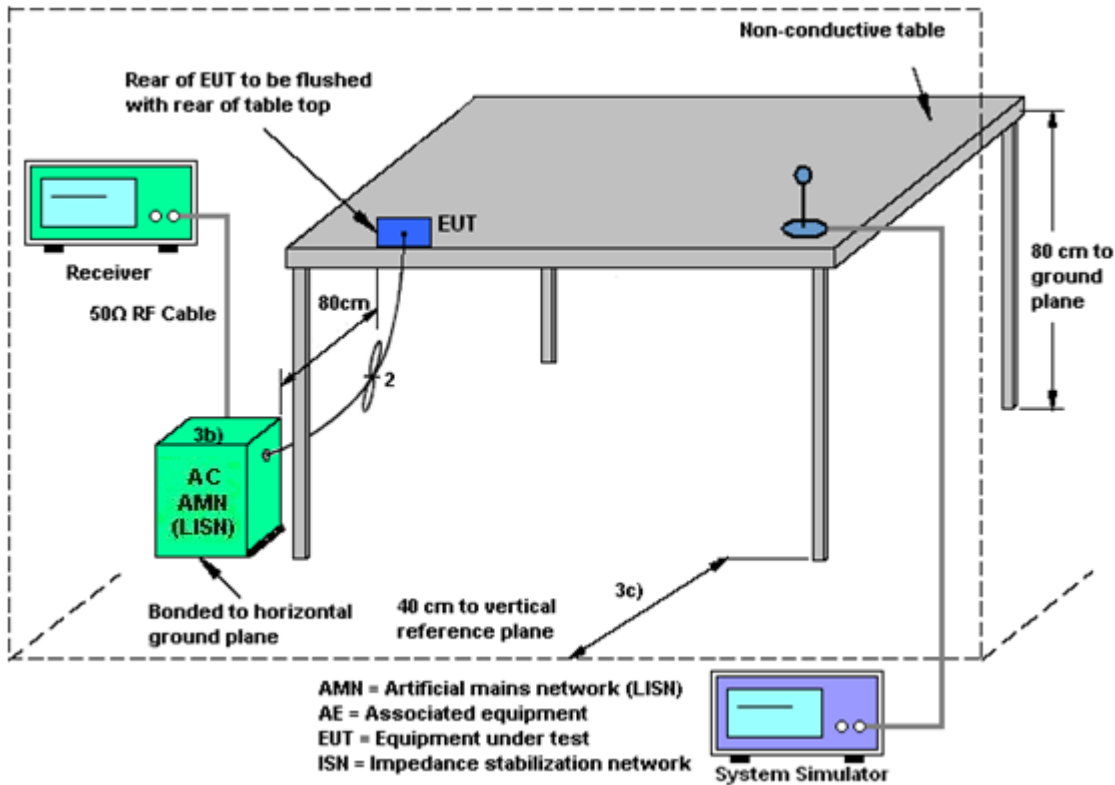

3.1.5 Test Result of AC Conducted Emission

Please refer to Appendix A.

3.2 20dB and 99% OBW Spectrum Bandwidth Measurement

3.2.1 Limit

Intentional radiators must be designed to ensure that the 20dB and 99% emission bandwidth in the specific band 13.553~13.567MHz.

3.2.2 Measuring Instruments

See list of measuring instruments of this test report.

3.2.3 Test Procedures

1. The spectrum analyzer connected via a receive antenna placed near the EUT in peak Max hold mode.
2. The resolution bandwidth of 1 kHz and the video bandwidth of 3 kHz were used.
3. Measured the spectrum width with power higher than 20dB below carrier.
4. Measured the 99% OBW.

3.2.4 Test Setup

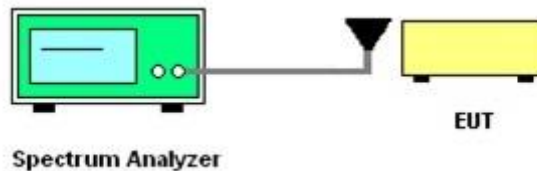

3.2.5 Test Result of Conducted Test Items

Please refer to Appendix B.

3.3 Frequency Stability Measurement

3.3.1 Limit

The frequency tolerance of the carrier signal shall be maintained within +/- 0.01% (100ppm) of the operating frequency over a temperature variation of -20 degrees to +50 degrees C at normal supply voltage, and for a variation in the primary supply voltage from 85% to 115% of the rated supply voltage at a temperature of 20 degrees C. For battery operated equipment, the equipment tests shall be performed using a new battery.

3.3.2 Measuring Instruments

See list of measuring instruments of this test report.

3.3.3 Test Procedures

1. The spectrum analyzer connected via a receive antenna placed near the EUT.
2. EUT have transmitted signal and fixed channelize.
3. Set the spectrum analyzer span to view the entire emissions bandwidth.
4. Set RBW = 1 kHz, VBW = 3 kHz with peak detector and maxhold settings.
5. The f_c is declaring of channel frequency. Then the frequency error formula is $(f_c - f) / f_c \times 10^6$ ppm and the limit is less than ± 100 ppm.
6. Extreme temperature rule is -20°C~50°C.

3.3.4 Test Setup

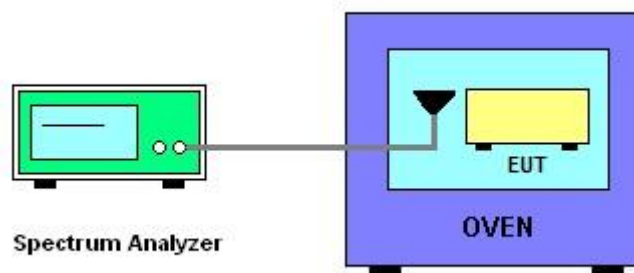

3.3.5 Test Result of Conducted Test Items

Please refer to Appendix B.



3.4 Field Strength of Fundamental Emissions and Mask Measurement

3.4.1 Limit

Rules and specifications	FCC CFR 47 Part 15 section 15.225			
Description	Compliance with the spectrum mask is tested with RBW set to 9kHz.			
Freq. of Emission (MHz)	Field Strength (μV/m) at 30m	Field Strength (dBμV/m) at 30m	Field Strength (dBμV/m) at 10m	Field Strength (dBμV/m) at 3m
1.705~13.110	30	29.5	48.58	69.5
13.110~13.410	106	40.5	59.58	80.5
13.410~13.553	334	50.5	69.58	90.5
13.553~13.567	15848	84.0	103.08	124.0
13.567~13.710	334	50.5	69.58	90.5
13.710~14.010	106	40.5	59.58	80.5
14.010~30.000	30	29.5	48.58	69.5

3.4.2 Measuring Instruments

See list of measuring instruments of this test report.

3.4.3 Test Procedures

1. Configure the EUT according to ANSI C63.10. The EUT was placed on the top of the turntable 0.8 meter above ground. The phase center of the loop receiving antenna mounted antenna tower was placed 3 meters far away from the turntable.
2. Power on the EUT and all the supporting units. The turntable was rotated by 360 degrees to determine the position of the highest radiation.
3. The height of the receiving antenna was fixed at one meter above ground to find the maximum emissions field strength.
4. For Fundamental emissions, use the receiver to measure QP reading.
5. When the radiated emissions limits are expressed in terms of the average value of the emissions, and pulsed operation is employed, the measurement field strength shall be determined by averaging over one complete pulse train, including blanking intervals, as long as the pulse train does not exceed 0.1 seconds. As an alternative (provided the transmitter operates for longer than 0.1 seconds) or in cases where the pulse train exceeds 0.1 seconds, the measured field strength shall be determined from the average absolute voltage during a 0.1 second interval during which the field strength is at its maximum value.
6. Compliance with the spectrum mask is tested with RBW set to 9kHz.

Note: Emission level (dB μ V/m) = 20 log Emission level (μ V/m).

3.4.4 Test Setup

For radiated emissions below 30MHz

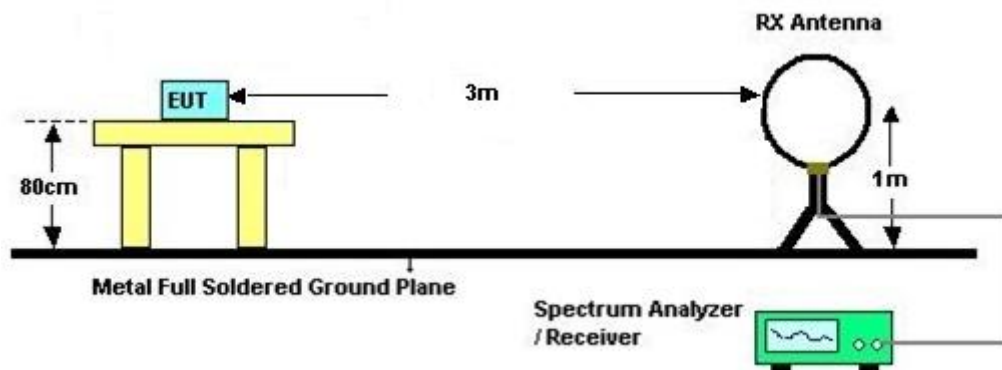

3.4.5 Test Result of Field Strength of Fundamental Emissions and Mask

Please refer to Appendix C.

3.5 Radiated Emissions Measurement

3.5.1 Limit

The field strength of any emissions which appear outside of 13.110 ~14.010MHz band shall not exceed the general radiated emissions limits.

Frequencies (MHz)	Field Strength (μV/m)	Measurement Distance (meters)
0.009~0.490	2400/F(kHz)	300
0.490~1.705	24000/F(kHz)	30
1.705~30.0	30	30
30~88	100	3
88~216	150	3
216~960	200	3
Above 960	500	3

3.5.2 Measuring Instruments

See list of measuring instruments of this test report.

3.5.3 Measuring Instrument Setting

The following table is the setting of receiver.

Receiver Parameter	Setting
Attenuation	Auto
Frequency Range: 9kHz~150kHz	RBW 200Hz for QP
Frequency Range: 150kHz~30MHz	RBW 9kHz for QP
Frequency Range: 30MHz~1000MHz	RBW 120kHz for Peak

Note: The emission limits shown in the above table are based on measurements employing a CISPR quasi-peak detector except for the frequency bands 9-90 kHz, 110-490 kHz. Radiated emission limits in these two bands are based on measurements employing an average detector.



3.5.4 Test Procedures

1. Configure the EUT according to ANSI C63.10. The EUT was placed on the top of the turntable 0.8 meter above ground. The phase center of the receiving antenna mounted on the top of a height-variable antenna tower was placed 3 meters far away from the turntable.
2. Power on the EUT and all the supporting units. The turntable was rotated by 360 degrees to determine the position of the highest radiation.
3. The height of the broadband receiving antenna was varied between one meter and four meters above ground to find the maximum emissions field strength of both horizontal and vertical polarization.
4. For each suspected emissions, the antenna tower was scan (from 1 M to 4 M) and then the turntable was rotated (from 0 degree to 360 degrees) to find the maximum reading.
5. Set the test-receiver system to Peak or CISPR quasi-peak Detect Function with specified bandwidth under Maximum Hold Mode.
6. When the radiated emissions limits are expressed in terms of the average value of the emissions, and pulsed operation is employed, the measurement field strength shall be determined by averaging over one complete pulse train, including blanking intervals, as long as the pulse train does not exceed 0.1 seconds. As an alternative (provided the transmitter operates for longer than 0.1 seconds) or in cases where the pulse train exceeds 0.1 seconds, the measured field strength shall be determined from the average absolute voltage during a 0.1 second interval during which the field strength is at its maximum value.
7. In case the emission is lower than 30MHz, loop antenna has to be used for measurement and the recorded data should be QP measured by receiver. Antenna Requirements

3.5.5 Test Setup

For radiated emissions below 30MHz

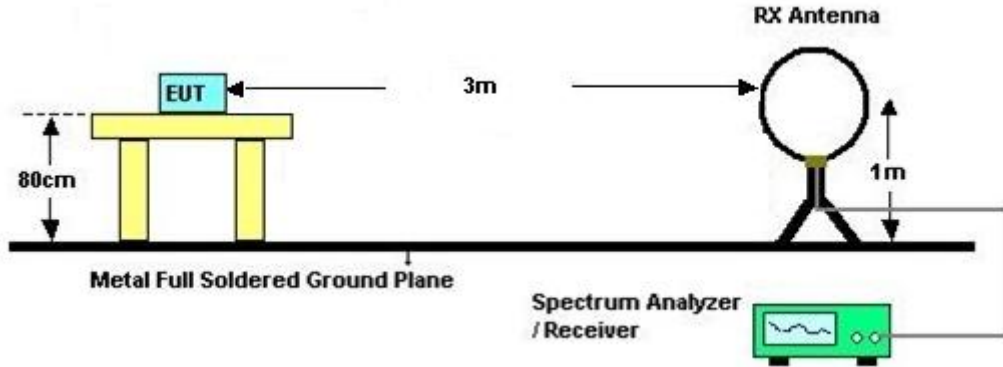

For radiated emissions above 30MHz

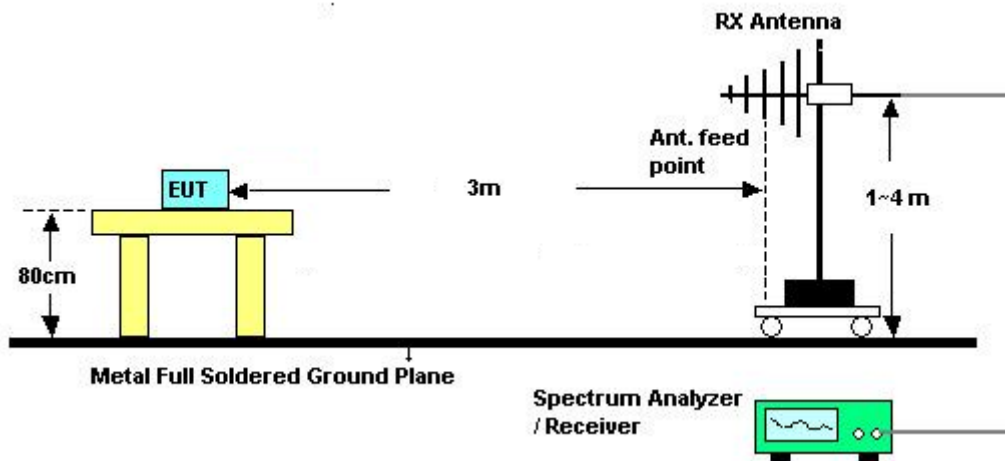

3.5.6 Test Result of Radiated Emissions Measurement

Please refer to Appendix C.

Remark: There is a comparison data of both open-field test site and semi-Anechoic chamber, and the result came out very similar.



3.6 Antenna Requirements

3.6.1 Standard Applicable

Except for special regulations, the Low-power Radio-frequency Devices must not be equipped with any jacket for installing an antenna with extension cable. An intentional radiator shall be designed to ensure that no antenna other than that furnished by the responsible party shall be used with the device. The use of a permanently attached antenna or of an antenna that uses a unique coupling to the intentional radiator shall be considered sufficient to comply with the provisions of this Section. The manufacturer may design the unit so that the user can replace a broken antenna, but the use of a standard antenna jack or electrical connector is prohibited.

The use of a permanently attached antenna or of an antenna that uses a unique coupling to the intentional radiator shall be considered sufficient to comply with the rule.

3.6.2 Antenna Anti-Replacement Construction

An embedded-in antenna design is used.



4. List of Measuring Equipment

Instrument	Manufacturer	Model No.	Serial No.	Characteristics	Calibration Date	Test Date	Due Date	Remark
Spectrum Analyzer	R&S	FSV40	101078	10Hz~40GHz	Apr. 18, 2019	Jun. 18, 2019	Apr. 17, 2020	Conducted (TH01-SZ)
Thermal Chamber	Ten Billion Hongzhangroup	LP-150U	H2014081803	-40~+150°C	Dec. 22, 2018	Jun. 18, 2019	Dec. 21, 2019	Conducted (TH01-SZ)
EMI Test Receiver	Keysight	N9038A	MY57290151	3Hz~8.5GHz;Max 30dBm	Jul.18.2019	Nov. 25, 2019	Jul.17.2020	Radiation (03CH02-KS)
Loop Antenna	R&S	HFH2-Z2	100321	9kHz~30MHz	Nov. 10, 2019	Nov. 25, 2019	Nov. 09, 2020	Radiation (03CH02-KS)
Bilog Antenna	TeseQ	CBL6111D	49922	30MHz-1GHz	May 30, 2019	Nov. 25, 2019	May 29, 2020	Radiation (03CH02-KS)
Amplifier	SONOMA	310N	187289	9KHz-1GHz	Aug. 06, 2019	Nov. 25, 2019	Aug. 05, 2020	Radiation (03CH02-KS)
AC Power Source	Chroma	61601	616010002473	N/A	NCR	Nov. 25, 2019	NCR	Radiation (03CH02-KS)
Turn Table	MF	MF7802	N/A	0~360 degree	NCR	Nov. 25, 2019	NCR	Radiation (03CH02-KS)
Antenna Mast	MF	MF7802	N/A	1 m~4 m	NCR	Nov. 25, 2019	NCR	Radiation (03CH02-KS)
EMI Receiver	R&S	ESR7	101630	9kHz~7GHz;	Dec. 23, 2018	Jun. 04, 2019~Jun. 17, 2019	Dec. 22, 2019	Conduction (CO01-SZ)
AC LISN	EMCO	3816/2SH	00103912	9kHz~30MHz	Oct. 18, 2018	Jun. 04, 2019~Jun. 17, 2019	Oct. 17, 2019	Conduction (CO01-SZ)
AC LISN (for auxiliary equipment)	EMCO	3816/2SH	00103892	9kHz~30MHz	Dec. 23, 2018	Jun. 04, 2019~Jun. 17, 2019	Dec. 22, 2019	Conduction (CO01-SZ)
AC Power Source	Chroma	61602	616020000891	100Vac~250Vac	Jul. 22, 2018	Jun. 04, 2019~Jun. 17, 2019	Jul. 23, 2019	Conduction (CO01-SZ)

NCR: No Calibration Required



5. Uncertainty of Evaluation

The measurement uncertainties shown below were calculated in accordance with the requirements of ANSI 63.10-2013. All the measurement uncertainty value were shown with a coverage K=2 to indicate 95% level of confidence. The measurement data show herein meets or exceeds the CISPR measurement uncertainty values specified in CISPR 16-4-2 and can be compared directly to specified limit to determine compliance.

Uncertainty of Conducted Emission Measurement (150 kHz ~ 30 MHz)

Measuring Uncertainty for a Level of Confidence of 95% (U = 2Uc(y))	2.6 dB
---	--------

Uncertainty of Radiated Emission Measurement (9 kHz ~ 30 MHz)

Measuring Uncertainty for a Level of Confidence of 95% (U = 2Uc(y))	4.9 dB
---	--------

Uncertainty of Radiated Emission Measurement (30 MHz ~ 1000 MHz)

Measuring Uncertainty for a Level of Confidence of 95% (U = 2Uc(y))	5.0 dB
---	--------



Appendix A. Test Results of Conducted Emission Test

Test Engineer :	Bear Xiong	Temperature :	22~25°C
		Relative Humidity :	50~55%
Test Voltage :	120Vac / 60Hz	Phase :	Line
Remark :	All emissions not reported here are more than 10 dB below the prescribed limit.		

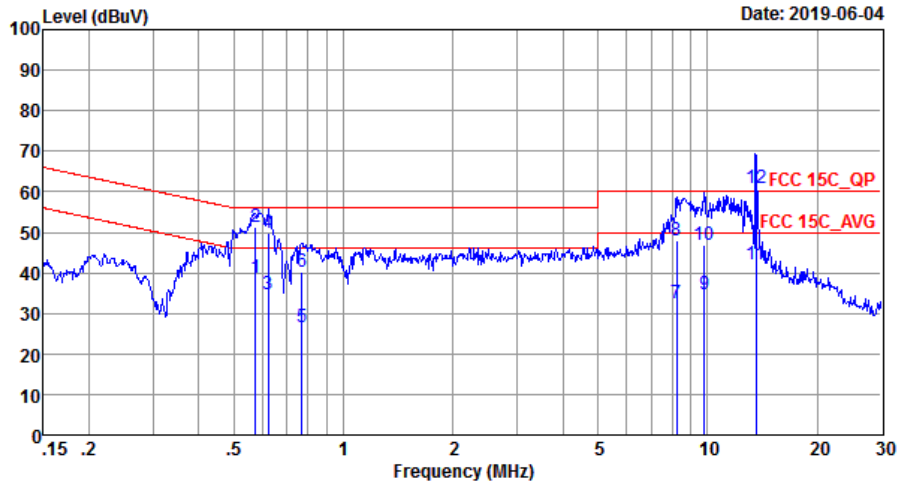

Site : CO01-SZ
Condition: FCC 15C QP LISN 20180719 L LINE

	Freq	Level	Over Limit	Limit Line	Read Level	LISN Factor	Cable Loss	Remark
	MHz	dBuV	dB	dBuV	dBuV	dB	dB	
1	0.57	38.70	-7.30	46.00	28.50	0.02	10.18	Average
2	0.57	51.30	-4.70	56.00	41.10	0.02	10.18	QP
3	0.62	34.60	-11.40	46.00	24.40	0.02	10.18	Average
4	0.62	49.80	-6.20	56.00	39.60	0.02	10.18	QP
5	0.77	26.41	-19.59	46.00	16.20	0.03	10.18	Average
6	0.77	40.22	-15.78	56.00	30.01	0.03	10.18	QP
7	8.24	32.44	-17.56	50.00	21.90	0.29	10.25	Average
8	8.24	48.04	-11.96	60.00	37.50	0.29	10.25	QP
9	9.81	34.81	-15.19	50.00	24.20	0.35	10.26	Average
10	9.81	46.71	-13.29	60.00	36.10	0.35	10.26	QP
11	13.56	41.94	-8.06	50.00	31.20	0.47	10.27	Average
12 *	13.56	60.84	0.84	60.00	50.10	0.47	10.27	QP

(1) with antenna

Remark: 13.560MHz is the NFC RF fundamental signal.



Test Engineer :	Bear Xiong	Temperature :	22~25°C
		Relative Humidity :	50~55%
Test Voltage :	120Vac / 60Hz	Phase :	Neutral
Remark :	All emissions not reported here are more than 10 dB below the prescribed limit.		

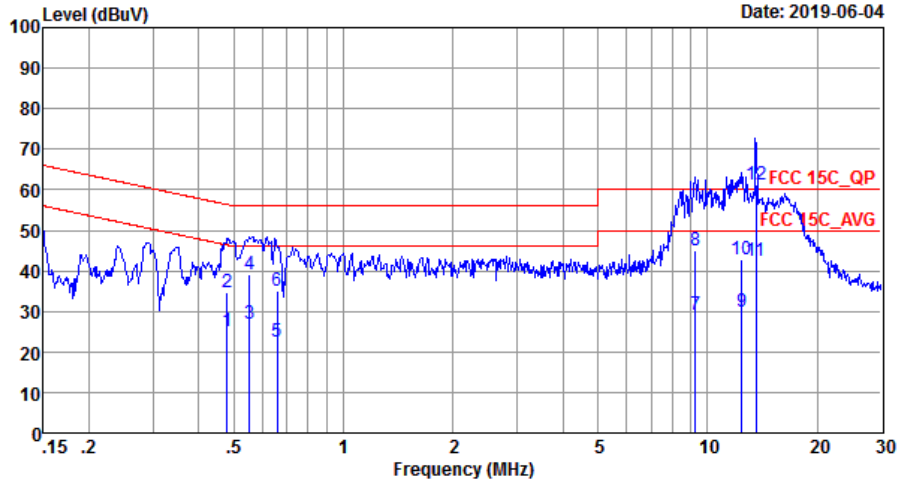

Site : CO01-SZ
 Condition: FCC 15C OP LISN 20180719 N NEUTRAL

	Freq	Level	Over Limit	Limit Line	Read Level	LISN Factor	Cable Loss	Remark
	MHz	dBuV	dB	dBuV	dBuV	dB	dB	
1	0.48	25.09	-21.27	46.36	14.90	0.02	10.17	Average
2	0.48	34.69	-21.67	56.36	24.50	0.02	10.17	QP
3	0.55	27.10	-18.90	46.00	16.90	0.02	10.18	Average
4	0.55	39.30	-16.70	56.00	29.10	0.02	10.18	QP
5	0.66	22.65	-23.35	46.00	12.45	0.02	10.18	Average
6	0.66	34.90	-21.10	56.00	24.70	0.02	10.18	QP
7	9.25	28.99	-21.01	50.00	18.60	0.14	10.25	Average
8	9.25	44.95	-15.05	60.00	34.56	0.14	10.25	QP
9	12.45	29.82	-20.18	50.00	19.30	0.25	10.27	Average
10	12.45	42.92	-17.08	60.00	32.40	0.25	10.27	QP
11	13.56	42.45	-7.55	50.00	31.89	0.29	10.27	Average
12 *	13.56	61.25	1.25	60.00	50.69	0.29	10.27	QP

(1) with antenna

Remark: 13.560MHz is the NFC RF fundamental signal.

Note:

- Level(dBμV) = Read Level(dBμV) + LISN Factor(dB) + Cable Loss(dB)
- Over Limit(dB) = Level(dBμV) – Limit Line(dBμV)



Test Engineer :	Bear Xiong	Temperature :	22~25°C
		Relative Humidity :	50~55%
Test Voltage :	120Vac / 60Hz	Phase :	Line
Remark :	All emissions not reported here are more than 10 dB below the prescribed limit.		

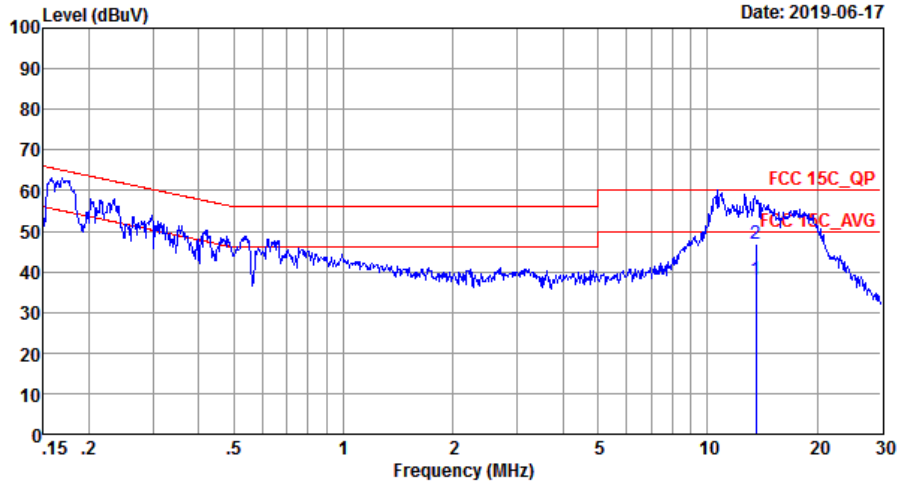

Site : CO01-SZ
 Condition: FCC 15C QP LISN 20180719 L LINE

	Freq	Level	Over Limit	Limit Line	Read Level	LISN Factor	Cable Loss	Remark
	MHz	dBuV	dB	dBuV	dBuV	dB	dB	
1 *	13.56	37.84	-12.16	50.00	27.10	0.47	10.27	Average
2	13.56	46.84	-13.16	60.00	36.10	0.47	10.27	QP

(2) With dummy load

Remark: Only the fundamental NFC signal needs to be retested per KDB 174176.



Test Engineer :	Bear Xiong	Temperature :	22~25°C
		Relative Humidity :	50~55%
Test Voltage :	120Vac / 60Hz	Phase :	Neutral
Remark :	All emissions not reported here are more than 10 dB below the prescribed limit.		

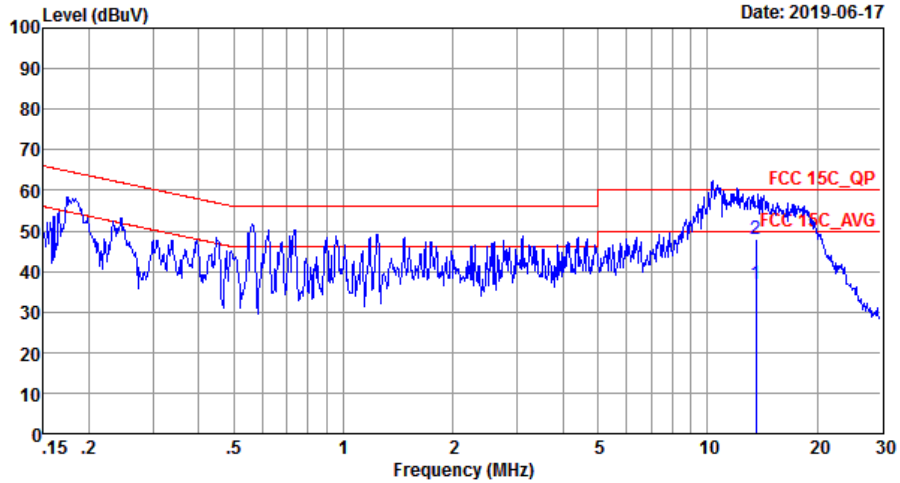

Site : C001-SZ
 Condition: FCC 15C_QP LISN_20180719_N NEUTRAL

	Freq	Level	Over Limit	Limit Line	Read Level	LISN Factor	Cable Loss	Remark
	MHz	dBuV	dB	dBuV	dBuV	dB	dB	
1	13.56	36.75	-13.25	50.00	26.19	0.29	10.27	Average
2 *	13.56	47.95	-12.05	60.00	37.39	0.29	10.27	QP

(2) With dummy load

Remark: Only the fundamental NFC signal needs to be retested per KDB 174176.

Note:

- Level(dBμV) = Read Level(dBμV) + LISN Factor(dB) + Cable Loss(dB)
- Over Limit(dB) = Level(dBμV) – Limit Line(dBμV)



Appendix B. Test Results of Conducted Test Items

B1. Test Result of 20dB Spectrum Bandwidth

Test mode	NFC Tx	Test Frequency (MHz)	13.56
20dB Bandwidth (kHz)	2.08	99% OccupiedBW(kHz)	2.46
Frequency range (MHz)	$f_L > 13.553$	13.558901	Test Result
	$f_H < 13.567$	13.561359	Complies

Remark: Because the measured signal is CW adjusting the RBW per C63.10 would not be practical since measured bandwidth will always follow the RBW and the result will be approximately twice the RBW.



B2. Test Result of Frequency Stability

Voltage vs. Frequency Stability		Temperature vs. Frequency Stability	
Voltage (Vac)	Measurement Frequency (MHz)	Temperature (°C)	Measurement Frequency (MHz)
3.30	13.560130	-20	13.560125
3.80	13.560125	-10	13.560120
4.35	13.560130	0	13.560120
		10	13.560130
		20	13.560140
		30	13.560140
		40	13.560140
		50	13.560140
Max.Deviation (MHz)	0.000130	Max.Deviation (MHz)	0.000140
Max.Deviation (ppm)	9.5870	Max.Deviation (ppm)	10.3245
Limit	FS < ±100 ppm	Limit	FS < ±100 ppm
Test Result	PASS	Test Result	PASS



Appendix C. Test Results of Radiated Test Items

C1. Test Result of Field Strength of Fundamental Emissions

Test Mode :	NFC Tx	Test Frequency (MHz)	13.56
--------------------	--------	-----------------------------	-------

Site : 03CH02-KS
 Condition : NFC 15.225 3m NFC ANT 100321 HORIZONTAL
 Project : (FR)952227
 Mode : 1

1	13.560	59.46	-64.54	124.00	38.69	20.30	0.47	---	---	QP
---	--------	-------	--------	--------	-------	-------	------	-----	-----	----

Site : 03CH02-KS
 Condition : NFC 15.225 3m NFC ANT 100321 VERTICAL
 Project : (FR)952227
 Mode : 1

1	13.560	58.40	-65.60	124.00	37.63	20.30	0.47	---	---	QP
---	--------	-------	--------	--------	-------	-------	------	-----	-----	----

Note:

1. Level(dBμV/m) = Read Level(dBμV) + Antenna Factor(dB/m) + Cable Loss(dB)
2. Over Limit(dB) = Level(dBμV/m) – Limit Line(dBμV/m)



C2. Results of Radiated Spurious Emissions (9 kHz~30MHz)

Test Mode :		NFC Tx			Polarization :		Horizontal		
Frequency (MHz)	Level (dB μ V/m)	Over Limit (dB)	Limit Line (dB μ V/m)	Read Level (dB μ V)	Antenna Factor (dB)	Cable Loss (dB)	Ant Pos (cm)	Table Pos (deg)	Remark
0.00985	59.41	-68.33	127.74	38.8	20.6	0.01	-	-	Average
0.03861	56.95	-58.91	115.86	37.14	19.8	0.01	-	-	Average
1.068	51.99	-15.03	67.02	30.97	21	0.02	-	-	QP
3.062	40.07	-29.47	69.54	19.03	21	0.04	-	-	QP
11.757	42.39	-27.15	69.54	22	20.25	0.14	-	-	QP
26.66	37.37	-32.17	69.54	17.1	19.97	0.3	-	-	QP



Test Mode :		NFC Tx			Polarization :		Vertical		
Frequency (MHz)	Level (dBμV/m)	Over Limit (dB)	Limit Line (dBμV/m)	Read Level (dBμV)	Antenna Factor (dB)	Cable Loss (dB)	Ant Pos (cm)	Table Pos (deg)	Remark
0.00999	57.76	-69.86	127.62	37.15	20.6	0.01	-	-	Average
0.03974	52	-63.61	115.61	32.19	19.8	0.01	-	-	Average
0.64395	44	-27.41	71.41	23.63	20.35	0.02	-	-	QP
4.622	39.82	-29.72	69.54	18.76	21	0.06	-	-	QP
11.842	48.83	-20.71	69.54	28.44	20.25	0.14	-	-	QP
25.895	38.51	-31.03	69.54	18.15	20.07	0.29	-	-	QP

Note:

1. The amplitude of spurious emissions which are attenuated by more than 20dB below the permissible value has no need to be reported.
2. Distance extrapolation factor = $40 \log(\text{specific distance} / \text{test distance})$ (dB);
3. Limit line = specific limits (dBμV) + distance extrapolation factor.



C3. Results of Radiated Spurious Emissions (30MHz~1GHz)

Test Mode :		NFC Tx			Polarization :		Horizontal			
Frequency (MHz)	Level (dBμV/m)	Over Limit (dB)	Limit Line (dBμV/m)	Read Level (dBμV)	Antenna Factor (dB)	Cable Loss (dB)	Preamp Factor (dB)	Ant Pos (cm)	Table Pos (deg)	Remark
40.67	26.34	-13.66	40	38.43	19.16	0.71	31.96	-	-	Peak
105.66	26.07	-17.43	43.5	40.49	16.32	1.19	31.93	-	-	Peak
176.47	29.71	-13.79	43.5	44.01	16.09	1.53	31.92	-	-	Peak
203.63	36.06	-7.44	43.5	50.92	15.38	1.66	31.9	100	0	Peak
326.82	30.04	-15.96	46	40.04	20	2.04	32.04	-	-	Peak
406.36	30.75	-15.25	46	38.54	22.06	2.27	32.12	-	-	Peak



Test Mode :		NFC Tx			Polarization :		Vertical			
Frequency (MHz)	Level (dBμV/m)	Over Limit (dB)	Limit Line (dBμV/m)	Read Level (dBμV)	Antenna Factor (dB)	Cable Loss (dB)	Preamp Factor (dB)	Ant Pos (cm)	Table Pos (deg)	Remark
40.67	36.77	-3.23	40	48.86	19.16	0.71	31.96	100	0	QP
44.55	34.97	-5.03	40	49.15	17	0.76	31.94	-	-	Peak
176.47	29.71	-13.79	43.5	44.01	16.09	1.53	31.92	-	-	Peak
203.63	35.41	-8.09	43.5	50.27	15.38	1.66	31.9	-	-	Peak
217.21	32.52	-13.48	46	46.38	16.35	1.71	31.92	-	-	Peak
569.32	36.18	-9.82	46	40.25	25.63	2.67	32.37	-	-	Peak

Note:

1. The amplitude of spurious emissions which are attenuated by more than 20dB below the permissible value has no need to be reported.
2. Emission level (dBμV/m) = 20 log Emission level (μV/m).
3. Corrected Reading: Antenna Factor + Cable Loss + Read Level - Preamp Factor= Level.