

# FCC SAR Test Report

APPLICANT : PAX Technology Limited  
EQUIPMENT : Wireless Data Terminal  
BRAND NAME : PAX  
MODEL NAME : X5  
FCC ID : V5PX5  
STANDARD : FCC 47 CFR PART 2 (2.1093)  
ANSI/IEEE C95.1-1992  
IEEE 1528-2013

The product was received on May 22, 2019 and testing was started from Jun. 15, 2019 and completed on Jun. 28, 2019. We, Sporton International (Shenzhen) Inc., would like to declare that the tested sample has been evaluated in accordance with the test procedures and has been in compliance with the applicable technical standards.

The test results in this report apply exclusively to the tested model / sample. Without written approval of Sporton International (Shenzhen) Inc., the test report shall not be reproduced except in full.



Reviewed by: Long Liang / Supervisor

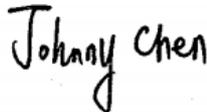

Approved by: Johnny Chen / Manager



**Sporton International (ShenZhen) Inc.**  
1/F, 2/F, Bldg 5, Shiling Industrial Zone, Xinwei Village, Xili, Nanshan, Shenzhen, 518055  
People's Republic of China



Table of Contents

1. Statement of Compliance ..... 4
2. Administration Data ..... 5
3. Guidance Applied..... 5
4. Equipment Under Test (EUT) Information..... 6
4.1 General Information ..... 6
4.2 General LTE SAR Test and Reporting Considerations ..... 7
5. RF Exposure Limits..... 9
5.1 Uncontrolled Environment..... 9
5.2 Controlled Environment..... 9
6. Specific Absorption Rate (SAR).....10
6.1 Introduction .....10
6.2 SAR Definition.....10
7. System Description and Setup .....11
7.1 E-Field Probe .....12
7.2 Data Acquisition Electronics (DAE) .....12
7.3 Phantom.....13
7.4 Device Holder.....14
8. Measurement Procedures .....15
8.1 Spatial Peak SAR Evaluation .....15
8.2 Power Reference Measurement.....16
8.3 Area Scan .....16
8.4 Zoom Scan.....17
8.5 Volume Scan Procedures.....17
8.6 Power Drift Monitoring.....17
9. Test Equipment List .....18
10. System Verification .....19
10.1 Tissue Simulating Liquids.....19
10.2 Tissue Verification .....20
10.3 System Performance Check Results.....21
11. RF Exposure Positions .....22
11.1 Ear and handset reference point .....22
11.2 Definition of the cheek position.....23
11.3 Definition of the tilt position.....24
11.4 Body Worn Accessory .....25
11.5 Product Specific 10g SAR Exposure .....26
11.6 Wireless Router.....26
12. Conducted RF Output Power (Unit: dBm).....27
13. Antenna Location .....51
14. SAR Test Results .....52
14.1 Head SAR .....54
14.2 Hotspot SAR .....57
14.3 Body Worn Accessory SAR.....61
14.4 Product specific 10g SAR .....63
15. Simultaneous Transmission Analysis.....64
15.1 Head Exposure Conditions .....65
15.2 Hotspot Exposure Conditions.....66
15.3 Body-Worn Accessory Exposure Conditions .....67
16. Uncertainty Assessment .....68
17. References.....69
Appendix A. Plots of System Performance Check
Appendix B. Plots of High SAR Measurement
Appendix C. DASy Calibration Certificate
Appendix D. Test Setup Photos





**1. Statement of Compliance**

The maximum results of Specific Absorption Rate (SAR) found during testing for **PAX Technology Limited, Wireless Data Terminal, X5**, are as follows.

Highest Standalone 1g SAR Summary						Highest Simultaneous Transmission 1g SAR (W/kg)
Equipment Class	Frequency Band		Head (Separation 0mm)	Hotspot (Separation 10mm)	Body-worn (Separation 10mm)	
			1g SAR (W/kg)			
Licensed	WCDMA	Band V	0.34	0.52	0.52	1.23
		Band IV	0.41	<b>0.76</b>	<b>0.76</b>	
		Band II	0.67	0.73	0.73	
	LTE	Band 12/Band 17	0.36	0.45	0.45	
		Band 13	0.19	0.21	0.21	
		Band 5	0.19	0.37	0.37	
		Band 4	0.29	0.45	0.45	
	Band 2	0.57	0.64	0.64		
DTS	WLAN	2.4GHz WLAN	0.21	0.11	0.11	0.87
NII		5GHz WLAN	<b>0.88</b>	0.48	0.39	1.23
DSS	Bluetooth	2.4GHz Bluetooth	<0.10	<0.10	<0.10	0.78
Highest 10g SAR Summary						
Equipment Class	Frequency Band		Product Specific 10g SAR (W/kg) (Separation 0mm)			
NII	WLAN	5GHz WLAN	<b>0.94</b>			
Date of Testing:			2019/6/15~2019/6/28			
<b>Remark:</b> This device supports LTE B17 and B12. Since the supported frequency span for B17 falls completely within the supports frequency span for LTE B12 , both LTE bands have the same target power, and both LTE bands share the same transmission path; therefore, SAR was only assessed for LTEB12.						

<b>Declaration of Conformity:</b>
The test results with all measurement uncertainty excluded are presented in accordance with the regulation limits or requirements declared by manufacturers.
<b>Comments and Explanations:</b>
The declared of product specification for EUT presented in the report are provided by the manufacturer, and the manufacturer takes all the responsibilities for the accuracy of product specification.

This device is in compliance with Specific Absorption Rate (SAR) for general population/uncontrolled exposure limits (1.6 W/kg for Partial-Body 1g SAR, 4.0 W/kg for Product Specific 10g SAR) specified in FCC 47 CFR part 2 (2.1093) and ANSI/IEEE C95.1-1992, and had been tested in accordance with the measurement methods and procedures specified in IEEE 1528-2013 and FCC KDB publications.



## 2. Administration Data

Sporton International (Shenzhen) Inc. is accredited to ISO/IEC 17025:2017 by American Association for Laboratory Accreditation with Certificate Number 5145.01.

Testing Laboratory		
Test Firm	Sporton International (Shenzhen) Inc.	
Test Site Location	1/F, 2/F, Bldg 5, Shiling Industrial Zone, Xinwei Village, Xili, Nanshan, Shenzhen, 518055 People's Republic of China TEL: +86-755-86379589 FAX: +86-755-86379595	
Test Site No.	FCC Designation No.	FCC Test Firm Registration No.
	CN1256	421272

Applicant	
Company Name	PAX Technology Limited
Address	Room 2416, 24/F., Sun Hung Kai Centre, 30 Harbour Road, Wanchai, Hong Kong

Manufacturer	
Company Name	PAX Computer Technology (Shenzhen) Co., Ltd.
Address	4/F, No.3 Building, Software Park, Second Central Science-Tech Road, High-Tech industrial Park, Shenzhen, Guangdong, P.R.C.

## 3. Guidance Applied

The Specific Absorption Rate (SAR) testing specification, method, and procedure for this device is in accordance with the following standards:

- FCC 47 CFR Part 2 (2.1093)
- ANSI/IEEE C95.1-1992
- IEEE 1528-2013
- FCC KDB 865664 D01 SAR Measurement 100 MHz to 6 GHz v01r04
- FCC KDB 865664 D02 SAR Reporting v01r02
- FCC KDB 447498 D01 General RF Exposure Guidance v06
- FCC KDB 648474 D04 SAR Evaluation Considerations for Wireless Handsets v01r03
- FCC KDB 248227 D01 802.11 Wi-Fi SAR v02r02
- FCC KDB 941225 D01 3G SAR Procedures v03r01
- FCC KDB 941225 D05 SAR for LTE Devices v02r05
- FCC KDB 941225 D06 Hotspot Mode SAR v02r01



4. Equipment Under Test (EUT) Information

4.1 General Information

Product Feature & Specification	
Equipment Name	Wireless Data Terminal
Brand Name	PAX
Model Name	X5
FCC ID	V5PX5
IMEI Code	SIM1: 353022100102141 SIM2: 353022100102158
Wireless Technology and Frequency Range	WCDMA Band II: 1852.4 MHz ~ 1907.6 MHz WCDMA Band IV: 1712.4 MHz ~ 1752.6 MHz WCDMA Band V: 826.4 MHz ~ 846.6 MHz LTE Band 2: 1850.7 MHz ~ 1909.3 MHz LTE Band 4: 1710.7 MHz ~ 1754.3 MHz LTE Band 5: 824.7 MHz ~ 848.3 MHz LTE Band 12: 699.7 MHz ~ 715.3 MHz LTE Band 13: 779.5 MHz ~ 784.5 MHz LTE Band 17: 706.5 MHz ~ 713.5 MHz WLAN 2.4GHz Band: 2412 MHz ~ 2462 MHz WLAN 5.2GHz Band: 5180 MHz ~ 5240 MHz WLAN 5.3GHz Band: 5260 MHz ~ 5320 MHz WLAN 5.5GHz Band: 5500 MHz ~ 5720 MHz WLAN 5.8GHz Band: 5745 MHz ~ 5825 MHz Bluetooth: 2402 MHz ~ 2480 MHz NFC : 13.56 MHz
Mode	RMC/AMR 12.2Kbps HSDPA HSUPA DC-HSDPA HSPA+ (16QAM uplink is not supported) LTE: QPSK, 16QAM WLAN 2.4GHz: 802.11b/g/n HT20/HT40 WLAN 5GHz 802.11a/n HT20/HT40 WLAN 5GHz 802.11ac VHT20/VHT40/VHT80 Bluetooth BR/EDR/LE NFC:ASK
HW Version	N/A
SW Version	N/A
GSM / (E)GPRS Transfer mode	Class B – EUT cannot support Packet Switched and Circuit Switched Network simultaneously but can automatically switch between Packet and Circuit Switched Network.
EUT Stage	Production Unit
<b>Remark:</b> 1. This device supports VoIP in WCDMA and LTE (e.g. for 3rd-party VoIP), LTE supports VoLTE operation. 2. This device 2.4GHz WLAN support hotspot operation and Bluetooth support tethering applications. 3. This device 2.4GHz WLAN/5.2GHz WLAN/5.8GHz WLAN support hotspot operation, and 5.2GHz WLAN/5.8GHz WLAN supports WiFi Direct (GC/GO), and 5.3GHz / 5.5GHz supports WiFi Direct (GC only). 4. For dual SIM card mobile has two SIM slots and supports dual SIM dual standby. The WWAN radio transmission will be enabled by either one SIM at a time (single active). After pre-scan two SIM cards power, we found test result of the SIM1 was the worse, so we chose SIM1 slot to perform all tests.	



**4.2 General LTE SAR Test and Reporting Considerations**

Summarized necessary items addressed in KDB 941225 D05 v02r05																																																															
FCC ID	V5PX5																																																														
Equipment Name	Wireless Data Terminal																																																														
Operating Frequency Range of each LTE transmission band	LTE Band 2: 1850.7 MHz ~ 1909.3 MHz LTE Band 4: 1710.7 MHz ~ 1754.3 MHz LTE Band 5: 824.7 MHz ~ 848.3 MHz LTE Band 12: 699.7 MHz ~ 715.3 MHz LTE Band 13: 779.5 MHz ~ 784.5 MHz LTE Band 17: 706.5 MHz ~ 713.5 MHz																																																														
Channel Bandwidth	LTE Band 2: 1.4MHz, 3MHz, 5MHz, 10MHz, 15MHz, 20MHz LTE Band 4: 1.4MHz, 3MHz, 5MHz, 10MHz, 15MHz, 20MHz LTE Band 5: 1.4MHz, 3MHz, 5MHz, 10MHz LTE Band 12: 1.4MHz, 3MHz, 5MHz, 10MHz LTE Band 13: 5MHz, 10MHz LTE Band 17: 5MHz, 10MHz																																																														
Uplink Modulations used	QPSK / 16QAM																																																														
LTE Voice / Data requirements	Voice and Data																																																														
LTE Release Version	R8, Cat 4																																																														
CA Support	Not Supported																																																														
LTE MPR permanently built-in by design	<p><b>Table 6.2.3-1: Maximum Power Reduction (MPR) for Power Class 1, 2 and 3</b></p> <table border="1"> <thead> <tr> <th rowspan="2">Modulation</th> <th colspan="6">Channel bandwidth / Transmission bandwidth (N<sub>RB</sub>)</th> <th rowspan="2">MPR (dB)</th> </tr> <tr> <th>1.4 MHz</th> <th>3.0 MHz</th> <th>5 MHz</th> <th>10 MHz</th> <th>15 MHz</th> <th>20 MHz</th> </tr> </thead> <tbody> <tr> <td>QPSK</td> <td>&gt; 5</td> <td>&gt; 4</td> <td>&gt; 8</td> <td>&gt; 12</td> <td>&gt; 16</td> <td>&gt; 18</td> <td>≤ 1</td> </tr> <tr> <td>16 QAM</td> <td>≤ 5</td> <td>≤ 4</td> <td>≤ 8</td> <td>≤ 12</td> <td>≤ 16</td> <td>≤ 18</td> <td>≤ 1</td> </tr> <tr> <td>16 QAM</td> <td>&gt; 5</td> <td>&gt; 4</td> <td>&gt; 8</td> <td>&gt; 12</td> <td>&gt; 16</td> <td>&gt; 18</td> <td>≤ 2</td> </tr> <tr> <td>64 QAM</td> <td>≤ 5</td> <td>≤ 4</td> <td>≤ 8</td> <td>≤ 12</td> <td>≤ 16</td> <td>≤ 18</td> <td>≤ 2</td> </tr> <tr> <td>64 QAM</td> <td>&gt; 5</td> <td>&gt; 4</td> <td>&gt; 8</td> <td>&gt; 12</td> <td>&gt; 16</td> <td>&gt; 18</td> <td>≤ 3</td> </tr> <tr> <td>256 QAM</td> <td colspan="6">≥ 1</td> <td>≤ 5</td> </tr> </tbody> </table>	Modulation	Channel bandwidth / Transmission bandwidth (N <sub>RB</sub> )						MPR (dB)	1.4 MHz	3.0 MHz	5 MHz	10 MHz	15 MHz	20 MHz	QPSK	> 5	> 4	> 8	> 12	> 16	> 18	≤ 1	16 QAM	≤ 5	≤ 4	≤ 8	≤ 12	≤ 16	≤ 18	≤ 1	16 QAM	> 5	> 4	> 8	> 12	> 16	> 18	≤ 2	64 QAM	≤ 5	≤ 4	≤ 8	≤ 12	≤ 16	≤ 18	≤ 2	64 QAM	> 5	> 4	> 8	> 12	> 16	> 18	≤ 3	256 QAM	≥ 1						≤ 5
Modulation	Channel bandwidth / Transmission bandwidth (N <sub>RB</sub> )						MPR (dB)																																																								
	1.4 MHz	3.0 MHz	5 MHz	10 MHz	15 MHz	20 MHz																																																									
QPSK	> 5	> 4	> 8	> 12	> 16	> 18	≤ 1																																																								
16 QAM	≤ 5	≤ 4	≤ 8	≤ 12	≤ 16	≤ 18	≤ 1																																																								
16 QAM	> 5	> 4	> 8	> 12	> 16	> 18	≤ 2																																																								
64 QAM	≤ 5	≤ 4	≤ 8	≤ 12	≤ 16	≤ 18	≤ 2																																																								
64 QAM	> 5	> 4	> 8	> 12	> 16	> 18	≤ 3																																																								
256 QAM	≥ 1						≤ 5																																																								
LTE A-MPR	In the base station simulator configuration, Network Setting value is set to NS_01 to disable A-MPR during SAR testing and the LTE SAR tests was transmitting on all TTI frames (Maximum TTI)																																																														
Spectrum plots for RB configuration	A properly configured base station simulator was used for the SAR and power measurement; therefore, spectrum plots for each RB allocation and offset configuration are not included in the SAR report.																																																														



Transmission (H, M, L) channel numbers and frequencies in each LTE band												
LTE Band 2												
	Bandwidth 1.4 MHz		Bandwidth 3 MHz		Bandwidth 5 MHz		Bandwidth 10 MHz		Bandwidth 15 MHz		Bandwidth 20 MHz	
	Ch. #	Freq. (MHz)	Ch. #	Freq. (MHz)	Ch. #	Freq. (MHz)	Ch. #	Freq. (MHz)	Ch. #	Freq. (MHz)	Ch. #	Freq. (MHz)
L	18607	1850.7	18615	1851.5	18625	1852.5	18650	1855	18675	1857.5	18700	1860
M	18900	1880	18900	1880	18900	1880	18900	1880	18900	1880	18900	1880
H	19193	1909.3	19185	1908.5	19175	1907.5	19150	1905	19125	1902.5	19100	1900
LTE Band 4												
	Bandwidth 1.4 MHz		Bandwidth 3 MHz		Bandwidth 5 MHz		Bandwidth 10 MHz		Bandwidth 15 MHz		Bandwidth 20 MHz	
	Ch. #	Freq. (MHz)	Ch. #	Freq. (MHz)	Ch. #	Freq. (MHz)	Ch. #	Freq. (MHz)	Ch. #	Freq. (MHz)	Ch. #	Freq. (MHz)
L	19957	1710.7	19965	1711.5	19975	1712.5	20000	1715	20025	1717.5	20050	1720
M	20175	1732.5	20175	1732.5	20175	1732.5	20175	1732.5	20175	1732.5	20175	1732.5
H	20393	1754.3	20385	1753.5	20375	1752.5	20350	1750	20325	1747.5	20300	1745
LTE Band 5												
	Bandwidth 1.4 MHz		Bandwidth 3 MHz		Bandwidth 5 MHz		Bandwidth 10 MHz					
	Ch. #	Freq. (MHz)	Ch. #	Freq. (MHz)	Ch. #	Freq. (MHz)	Ch. #	Freq. (MHz)	Ch. #	Freq. (MHz)	Ch. #	Freq. (MHz)
L	20407	824.7	20415	825.5	20425	826.5	20450	829				
M	20525	836.5	20525	836.5	20525	836.5	20525	836.5				
H	20643	848.3	20635	847.5	20625	846.5	20600	844				
LTE Band 12												
	Bandwidth 1.4 MHz		Bandwidth 3 MHz		Bandwidth 5 MHz		Bandwidth 10 MHz					
	Ch. #	Freq. (MHz)	Ch. #	Freq. (MHz)	Ch. #	Freq. (MHz)	Ch. #	Freq. (MHz)	Ch. #	Freq. (MHz)	Ch. #	Freq. (MHz)
L	23017	699.7	23025	700.5	23035	701.5	23060	704				
M	23095	707.5	23095	707.5	23095	707.5	23095	707.5				
H	23173	715.3	23165	714.5	23155	713.5	23130	711				
LTE Band 13												
	Bandwidth 5 MHz				Bandwidth 10 MHz							
	Channel #		Freq.(MHz)		Channel #		Freq.(MHz)		Channel #		Freq.(MHz)	
L	23205		779.5		23230		782					
M	23230		782									
H	23255		784.5									
LTE Band 17												
	Bandwidth 5 MHz				Bandwidth 10 MHz							
	Channel #		Freq.(MHz)		Channel #		Freq. (MHz)		Channel #		Freq. (MHz)	
L	23755		706.5		23780		709					
M	23790		710		23790		710					
H	23825		713.5		23800		711					



5. RF Exposure Limits

5.1 Uncontrolled Environment

Uncontrolled Environments are defined as locations where there is the exposure of individuals who have no knowledge or control of their exposure. The general population/uncontrolled exposure limits are applicable to situations in which the general public may be exposed or in which persons who are exposed as a consequence of their employment may not be made fully aware of the potential for exposure or cannot exercise control over their exposure. Members of the general public would come under this category when exposure is not employment-related; for example, in the case of a wireless transmitter that exposes persons in its vicinity.

5.2 Controlled Environment

Controlled Environments are defined as locations where there is exposure that may be incurred by persons who are aware of the potential for exposure, (i.e. as a result of employment or occupation). In general, occupational/controlled exposure limits are applicable to situations in which persons are exposed as a consequence of their employment, who have been made fully aware of the potential for exposure and can exercise control over their exposure. The exposure category is also applicable when the exposure is of a transient nature due to incidental passage through a location where the exposure levels may be higher than the general population/uncontrolled limits, but the exposed person is fully aware of the potential for exposure and can exercise control over his or her exposure by leaving the area or by some other appropriate means.

Limits for Occupational/Controlled Exposure (W/kg)

Table with 3 columns: Whole-Body, Partial-Body, Hands, Wrists, Feet and Ankles. Values: 0.4, 8.0, 20.0

Limits for General Population/Uncontrolled Exposure (W/kg)

Table with 3 columns: Whole-Body, Partial-Body, Hands, Wrists, Feet and Ankles. Values: 0.08, 1.6, 4.0

Whole-Body SAR is averaged over the entire body, partial-body SAR is averaged over any 1gram of tissue defined as a tissue volume in the shape of a cube. SAR for hands, wrists, feet and ankles is averaged over any 10 grams of tissue defined as a tissue volume in the shape of a cube.

## **6. Specific Absorption Rate (SAR)**

### **6.1 Introduction**

SAR is related to the rate at which energy is absorbed per unit mass in an object exposed to a radio field. The SAR distribution in a biological body is complicated and is usually carried out by experimental techniques or numerical modeling. The standard recommends limits for two tiers of groups, occupational/controlled and general population/uncontrolled, based on a person's awareness and ability to exercise control over his or her exposure. In general, occupational/controlled exposure limits are higher than the limits for general population/uncontrolled.

### **6.2 SAR Definition**

The SAR definition is the time derivative (rate) of the incremental energy (dW) absorbed by (dissipated in) an incremental mass (dm) contained in a volume element (dv) of a given density ( $\rho$ ). The equation description is as below:

$$SAR = \frac{d}{dt} \left( \frac{dW}{dm} \right) = \frac{d}{dt} \left( \frac{dW}{\rho dv} \right)$$

SAR is expressed in units of Watts per kilogram (W/kg)

$$SAR = \frac{\sigma |E|^2}{\rho}$$

Where:  $\sigma$  is the conductivity of the tissue,  $\rho$  is the mass density of the tissue and E is the RMS electrical field strength.

## 7. System Description and Setup

The DASY system used for performing compliance tests consists of the following items:

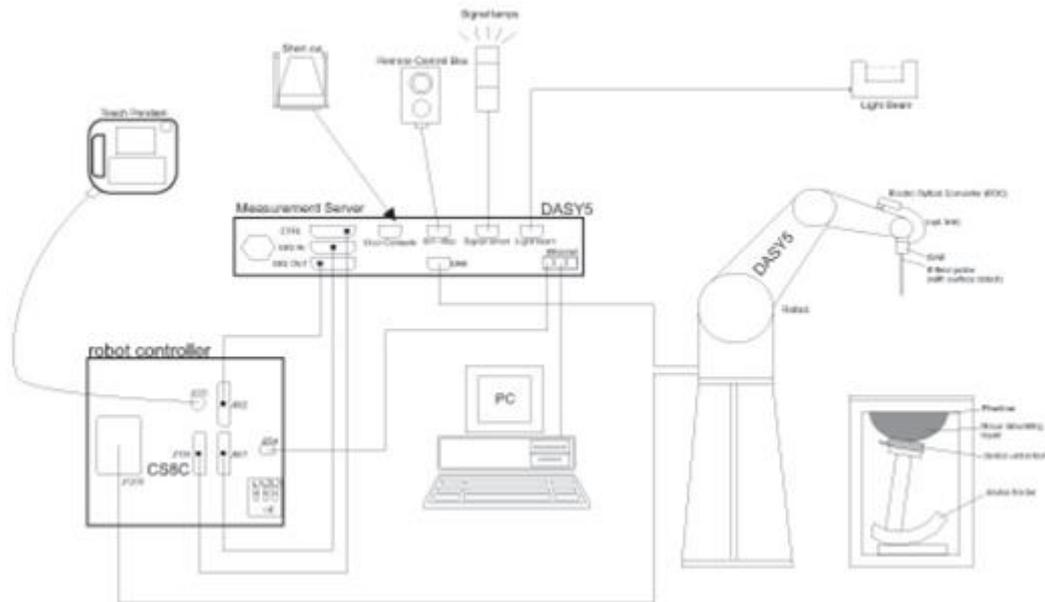

- A standard high precision 6-axis robot with controller, teach pendant and software. An arm extension for accommodating the data acquisition electronics (DAE).
- An isotropic Field probe optimized and calibrated for the targeted measurement.
- A data acquisition electronics (DAE) which performs the signal amplification, signal multiplexing, AD-conversion, offset measurements, mechanical surface detection, collision detection, etc. The unit is battery powered with standard or rechargeable batteries. The signal is optically transmitted to the EOC.
- The Electro-optical converter (EOC) performs the conversion from optical to electrical signals for the digital communication to the DAE. To use optical surface detection, a special version of the EOC is required. The EOC signal is transmitted to the measurement server.
- The function of the measurement server is to perform the time critical tasks such as signal filtering, control of the robot operation and fast movement interrupts.
- The Light Beam used is for probe alignment. This improves the (absolute) accuracy of the probe positioning.
- A computer running WinXP or Win7 and the DASY5 software.
- Remote control and teach pendant as well as additional circuitry for robot safety such as warning lamps, etc.
- The phantom, the device holder and other accessories according to the targeted measurement.

**7.1 E-Field Probe**

The SAR measurement is conducted with the dosimetric probe (manufactured by SPEAG). The probe is specially designed and calibrated for use in liquid with high permittivity. The dosimetric probe has special calibration in liquid at different frequency. This probe has a built in optical surface detection system to prevent from collision with phantom.

**<ES3DV3 Probe>**

<b>Construction</b>	Symmetric design with triangular core Interleaved sensors Built-in shielding against static charges PEEK enclosure material (resistant to organic solvents, e.g., DGBE)	
<b>Frequency</b>	10 MHz – 4 GHz; Linearity: $\pm 0.2$ dB (30 MHz – 4 GHz)	
<b>Directivity</b>	$\pm 0.2$ dB in TSL (rotation around probe axis) $\pm 0.3$ dB in TSL (rotation normal to probe axis)	
<b>Dynamic Range</b>	5 $\mu$ W/g – >100 mW/g; Linearity: $\pm 0.2$ dB	
<b>Dimensions</b>	Overall length: 337 mm (tip: 20 mm) Tip diameter: 3.9 mm (body: 12 mm) Distance from probe tip to dipole centers: 3.0 mm	

**<EX3DV4 Probe>**

<b>Construction</b>	Symmetric design with triangular core Built-in shielding against static charges PEEK enclosure material (resistant to organic solvents, e.g., DGBE)	
<b>Frequency</b>	10 MHz – >6 GHz Linearity: $\pm 0.2$ dB (30 MHz – 6 GHz)	
<b>Directivity</b>	$\pm 0.3$ dB in TSL (rotation around probe axis) $\pm 0.5$ dB in TSL (rotation normal to probe axis)	
<b>Dynamic Range</b>	10 $\mu$ W/g – >100 mW/g Linearity: $\pm 0.2$ dB (noise: typically <1 $\mu$ W/g)	
<b>Dimensions</b>	Overall length: 337 mm (tip: 20 mm) Tip diameter: 2.5 mm (body: 12 mm) Typical distance from probe tip to dipole centers: 1 mm	

**7.2 Data Acquisition Electronics (DAE)**

The data acquisition electronics (DAE) consists of a highly sensitive electrometer-grade preamplifier with auto-zeroing, a channel and gain-switching multiplexer, a fast 16 bit AD-converter and a command decoder and control logic unit. Transmission to the measurement server is accomplished through an optical downlink for data and status information as well as an optical uplink for commands and the clock.

The input impedance of the DAE is 200 MOhm; the inputs are symmetrical and floating. Common mode rejection is above 80 dB.



**Photo of DAE**

**7.3 Phantom**

**<SAM Twin Phantom>**

<b>Shell Thickness</b>	2 ± 0.2 mm; Center ear point: 6 ± 0.2 mm	
<b>Filling Volume</b>	Approx. 25 liters	
<b>Dimensions</b>	Length: 1000 mm; Width: 500 mm; Height: adjustable feet	
<b>Measurement Areas</b>	Left Hand, Right Hand, Flat Phantom	

The bottom plate contains three pair of bolts for locking the device holder. The device holder positions are adjusted to the standard measurement positions in the three sections. A white cover is provided to tap the phantom during off-periods to prevent water evaporation and changes in the liquid parameters. On the phantom top, three reference markers are provided to identify the phantom position with respect to the robot.

**<ELI Phantom>**

<b>Shell Thickness</b>	2 ± 0.2 mm (sagging: <1%)	
<b>Filling Volume</b>	Approx. 30 liters	
<b>Dimensions</b>	Major ellipse axis: 600 mm Minor axis: 400 mm	

The ELI phantom is intended for compliance testing of handheld and body-mounted wireless devices in the frequency range of 30 MHz to 6 GHz. ELI4 is fully compatible with standard and all known tissue simulating liquids.

## 7.4 Device Holder

### <Mounting Device for Hand-Held Transmitter>

In combination with the Twin SAM V5.0/V5.0c or ELI phantoms, the Mounting Device for Hand-Held Transmitters enables rotation of the mounted transmitter device to specified spherical coordinates. At the heads, the rotation axis is at the ear opening. Transmitter devices can be easily and accurately positioned according to IEC 62209-1, IEEE 1528, FCC, or other specifications. The device holder can be locked for positioning at different phantom sections (left head, right head, flat). And upgrade kit to Mounting Device to enable easy mounting of wider devices like big smart-phones, e-books, small tablets, etc. It holds devices with width up to 140 mm.



Mounting Device for Hand-Held Transmitters



Mounting Device Adaptor for Wide-Phones

### <Mounting Device for Laptops and other Body-Worn Transmitters>

The extension is lightweight and made of POM, acrylic glass and foam. It fits easily on the upper part of the mounting device in place of the phone positioned. The extension is fully compatible with the SAM Twin and ELI phantoms.



Mounting Device for Laptops

## **8. Measurement Procedures**

The measurement procedures are as follows:

### <Conducted power measurement>

- (a) For WWAN power measurement, use base station simulator to configure EUT WWAN transmission in conducted connection with RF cable, at maximum power in each supported wireless interface and frequency band.
- (b) Read the WWAN RF power level from the base station simulator.
- (c) For WLAN/BT power measurement, use engineering software to configure EUT WLAN/BT continuously transmission, at maximum RF power in each supported wireless interface and frequency band
- (d) Connect EUT RF port through RF cable to the power meter, and measure WLAN/BT output power

### <SAR measurement>

- (a) Use base station simulator to configure EUT WWAN transmission in radiated connection, and engineering software to configure EUT WLAN/BT continuously transmission, at maximum RF power, in the highest power channel.
- (b) Place the EUT in the positions as Appendix D demonstrates.
- (c) Set scan area, grid size and other setting on the DASY software.
- (d) Measure SAR results for the highest power channel on each testing position.
- (e) Find out the largest SAR result on these testing positions of each band
- (f) Measure SAR results for other channels in worst SAR testing position if the reported SAR of highest power channel is larger than 0.8 W/kg

According to the test standard, the recommended procedure for assessing the peak spatial-average SAR value consists of the following steps:

- (a) Power reference measurement
- (b) Area scan
- (c) Zoom scan
- (d) Power drift measurement

### **8.1 Spatial Peak SAR Evaluation**

The procedure for spatial peak SAR evaluation has been implemented according to the test standard. It can be conducted for 1g and 10g, as well as for user-specific masses. The DASY software includes all numerical procedures necessary to evaluate the spatial peak SAR value.

The base for the evaluation is a "cube" measurement. The measured volume must include the 1g and 10g cubes with the highest averaged SAR values. For that purpose, the center of the measured volume is aligned to the interpolated peak SAR value of a previously performed area scan.

The entire evaluation of the spatial peak values is performed within the post-processing engine (SEMCAD). The system always gives the maximum values for the 1g and 10g cubes. The algorithm to find the cube with highest averaged SAR is divided into the following stages:

- (a) Extraction of the measured data (grid and values) from the Zoom Scan
- (b) Calculation of the SAR value at every measurement point based on all stored data (A/D values and measurement parameters)
- (c) Generation of a high-resolution mesh within the measured volume
- (d) Interpolation of all measured values from the measurement grid to the high-resolution grid
- (e) Extrapolation of the entire 3-D field distribution to the phantom surface over the distance from sensor to surface
- (f) Calculation of the averaged SAR within masses of 1g and 10g

**8.2 Power Reference Measurement**

The Power Reference Measurement and Power Drift Measurements are for monitoring the power drift of the device under test in the batch process. The minimum distance of probe sensors to surface determines the closest measurement point to phantom surface. This distance cannot be smaller than the distance of sensor calibration points to probe tip as defined in the probe properties.

**8.3 Area Scan**

The area scan is used as a fast scan in two dimensions to find the area of high field values, before doing a fine measurement around the hot spot. The sophisticated interpolation routines implemented in DASY software can find the maximum found in the scanned area, within a range of the global maximum. The range (in dB0 is specified in the standards for compliance testing. For example, a 2 dB range is required in IEEE standard 1528 and IEC 62209 standards, whereby 3 dB is a requirement when compliance is assessed in accordance with the ARIB standard (Japan), if only one zoom scan follows the area scan, then only the absolute maximum will be taken as reference. For cases where multiple maximums are detected, the number of zoom scans has to be increased accordingly.

Area scan parameters extracted from FCC KDB 865664 D01v01r04 SAR measurement 100 MHz to 6 GHz.

	≤ 3 GHz	> 3 GHz
Maximum distance from closest measurement point (geometric center of probe sensors) to phantom surface	5 ± 1 mm	$\frac{1}{2} \cdot \delta \cdot \ln(2) \pm 0.5$ mm
Maximum probe angle from probe axis to phantom surface normal at the measurement location	30° ± 1°	20° ± 1°
Maximum area scan spatial resolution: $\Delta x_{Area}$ , $\Delta y_{Area}$	≤ 2 GHz: ≤ 15 mm 2 – 3 GHz: ≤ 12 mm	3 – 4 GHz: ≤ 12 mm 4 – 6 GHz: ≤ 10 mm
	When the x or y dimension of the test device, in the measurement plane orientation, is smaller than the above, the measurement resolution must be ≤ the corresponding x or y dimension of the test device with at least one measurement point on the test device.	

**8.4 Zoom Scan**

Zoom scans are used assess the peak spatial SAR values within a cubic averaging volume containing 1 gram and 10 gram of simulated tissue. The zoom scan measures points (refer to table below) within a cube shoes base faces are centered on the maxima found in a preceding area scan job within the same procedure. When the measurement is done, the zoom scan evaluates the averaged SAR for 1 gram and 10 gram and displays these values next to the job's label.

Zoom scan parameters extracted from FCC KDB 865664 D01v01r04 SAR measurement 100 MHz to 6 GHz.

		≤ 3 GHz	> 3 GHz	
Maximum zoom scan spatial resolution: $\Delta x_{Zoom}, \Delta y_{Zoom}$		$\leq 2$ GHz: $\leq 8$ mm 2 – 3 GHz: $\leq 5$ mm*	3 – 4 GHz: $\leq 5$ mm* 4 – 6 GHz: $\leq 4$ mm*	
Maximum zoom scan spatial resolution, normal to phantom surface	uniform grid: $\Delta z_{Zoom}(n)$	$\leq 5$ mm	3 – 4 GHz: $\leq 4$ mm 4 – 5 GHz: $\leq 3$ mm 5 – 6 GHz: $\leq 2$ mm	
	graded grid	$\Delta z_{Zoom}(1)$ : between 1 <sup>st</sup> two points closest to phantom surface	$\leq 4$ mm	3 – 4 GHz: $\leq 3$ mm 4 – 5 GHz: $\leq 2.5$ mm 5 – 6 GHz: $\leq 2$ mm
		$\Delta z_{Zoom}(n>1)$ : between subsequent points	$\leq 1.5 \cdot \Delta z_{Zoom}(n-1)$	
Minimum zoom scan volume	x, y, z	$\geq 30$ mm	3 – 4 GHz: $\geq 28$ mm 4 – 5 GHz: $\geq 25$ mm 5 – 6 GHz: $\geq 22$ mm	
Note: $\delta$ is the penetration depth of a plane-wave at normal incidence to the tissue medium; see draft standard IEEE P1528-2011 for details. * When zoom scan is required and the <i>reported</i> SAR from the <i>area scan based 1-g SAR estimation</i> procedures of KDB 447498 is $\leq 1.4$ W/kg, $\leq 8$ mm, $\leq 7$ mm and $\leq 5$ mm zoom scan resolution may be applied, respectively, for 2 GHz to 3 GHz, 3 GHz to 4 GHz and 4 GHz to 6 GHz.				

**8.5 Volume Scan Procedures**

The volume scan is used for assess overlapping SAR distributions for antennas transmitting in different frequency bands. It is equivalent to an oversized zoom scan used in standalone measurements. The measurement volume will be used to enclose all the simultaneous transmitting antennas. For antennas transmitting simultaneously in different frequency bands, the volume scan is measured separately in each frequency band. In order to sum correctly to compute the 1g aggregate SAR, the EUT remain in the same test position for all measurements and all volume scan use the same spatial resolution and grid spacing. When all volume scan were completed, the software, SEMCAD postprocessor can combine and subsequently superpose these measurement data to calculating the multiband SAR.

**8.6 Power Drift Monitoring**

All SAR testing is under the EUT install full charged battery and transmit maximum output power. In DASy measurement software, the power reference measurement and power drift measurement procedures are used for monitoring the power drift of EUT during SAR test. Both these procedures measure the field at a specified reference position before and after the SAR testing. The software will calculate the field difference in dB. If the power drifts more than 5%, the SAR will be retested.



**9. Test Equipment List**

Manufacturer	Name of Equipment	Type/Model	Serial Number	Calibration	
				Last Cal.	Due Date
SPEAG	750MHz System Validation Kit	D750V3	1099	Dec. 06, 2018	Dec. 05, 2019
SPEAG	835MHz System Validation Kit	D835V2	4d162	Dec. 05, 2018	Dec. 04, 2019
SPEAG	1750MHz System Validation Kit	D1750V2	1137	Jul. 30, 2018	Jul. 29, 2019
SPEAG	1900MHz System Validation Kit	D1900V2	5d182	Dec. 07, 2018	Dec. 06, 2019
SPEAG	2450MHz System Validation Kit	D2450V2	736	Aug. 31, 2018	Aug. 30, 2019
SPEAG	5000MHz System Validation Kit	D5GHZV2	1167	Aug. 03, 2018	Aug. 02, 2019
SPEAG	Data Acquisition Electronics	DAE4	1437	Oct. 15, 2018	Oct. 14, 2019
SPEAG	Data Acquisition Electronics	DAE4	715	Jan. 23, 2019	Jan. 22, 2020
SPEAG	Dosimetric E-Field Probe	ES3DV3	3191	Jan. 29, 2019	Jan. 28, 2020
SPEAG	Dosimetric E-Field Probe	EX3DV4	3819	Mar. 01, 2019	Feb. 29, 2020
SPEAG	SAM Twin Phantom	QD 000 P40 CD	TP-1671	NCR	NCR
SPEAG	SAM Twin Phantom	SAM V5.0	1795	NCR	NCR
Anritsu	Radio communication analyzer	MT8820C	6201300653	Jul. 18, 2018	Jul. 17, 2019
Agilent	Wireless Communication Test Set	E5515C	MY50267224	Sep. 11, 2018	Sep. 10, 2019
Agilent	Network Analyzer	E5071C	MY46523671	Oct. 18, 2018	Oct. 17, 2019
Speag	Dielectric Assessment KIT	DAK-3.5	1071	Nov. 20, 2018	Nov. 19, 2019
Agilent	Signal Generator	N5181A	MY50145381	Dec. 22, 2018	Dec. 21, 2019
Anritsu	Power Sensor	MA2411B	1306099	Jul. 30, 2018	Jul. 29, 2019
Anritsu	Power Meter	ML2495A	1349001	Jul. 26, 2018	Jul. 25, 2019
Anritsu	Power Sensor	MA2411B	1207253	Dec. 22, 2018	Dec. 21, 2019
Anritsu	Power Meter	ML2495A	1218010	Dec. 22, 2018	Dec. 21, 2019
R&S	CBT BLUETOOTH TESTER	CBT	100963	Dec. 22, 2018	Dec. 21, 2019
R&S	Spectrum Analyzer	FSP7	100818	Jul. 18, 2018	Jul. 17, 2019
LKM electronic	Hygrometer	DTM3000	3241	Aug. 10, 2018	Aug. 09, 2019
Anymetre	Thermo-Hygrometer	JR593	2015030904	Apr. 22, 2019	Apr. 21, 2020
Anymetre	Thermo-Hygrometer	JR593	2015102801	Dec. 22, 2018	Dec. 21, 2019
ARRA	Power Divider	A3200-2	N/A	Note	
PASTERNAK	Dual Directional Coupler	PE2214-10	N/A	Note	
Agilent	Dual Directional Coupler	778D	50422	Note	
MCL	Attenuation1	BW-S10W5	N/A	Note	
Weinschel	Attenuation2	3M-20	N/A	Note	
Zhongjilianhe	Attenuation3	MVE2214-03	N/A	Note	
AR	Amplifier	5S1G4	0333096	Note	
mini-circuits	Amplifier	ZVE-3W-83+	599201528	Note	

**Note:**

Prior to system verification and validation, the path loss from the signal generator to the system check source and the power meter, which includes the amplifier, cable, attenuator and directional coupler, was measured by the network analyzer. The reading of the power meter was offset by the path loss difference between the path to the power meter and the path to the system check source to monitor the actual power level fed to the system check source.

## 10. System Verification

### 10.1 Tissue Simulating Liquids

For the measurement of the field distribution inside the SAM phantom with DASY, the phantom must be filled with around 25 liters of homogeneous body tissue simulating liquid. For head SAR testing, the liquid height from the ear reference point (ERP) of the phantom to the liquid top surface is larger than 15 cm, which is shown in Fig. 10.1. For body SAR testing, the liquid height from the center of the flat phantom to the liquid top surface is larger than 15 cm, which is shown in Fig. 10.2.

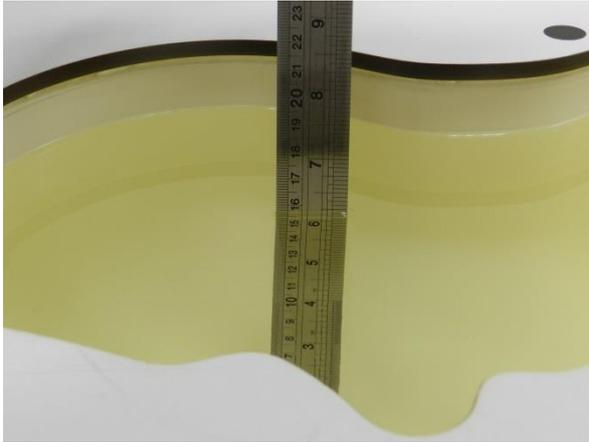

Fig 10.1 Photo of Liquid Height for Head SAR



Fig 10.2 Photo of Liquid Height for Body SAR

**10.2 Tissue Verification**

The following tissue formulations are provided for reference only as some of the parameters have not been thoroughly verified. The composition of ingredients may be modified accordingly to achieve the desired target tissue parameters required for routine SAR evaluation.

Frequency (MHz)	Water (%)	Sugar (%)	Cellulose (%)	Salt (%)	Preventol (%)	DGBE (%)	Conductivity (σ)	Permittivity (εr)
For Head								
750	41.1	57.0	0.2	1.4	0.2	0	0.89	41.9
835	40.3	57.9	0.2	1.4	0.2	0	0.90	41.5
1800, 1900, 2000	55.2	0	0	0.3	0	44.5	1.40	40.0
2450	55.0	0	0	0	0	45.0	1.80	39.2

**Simulating Liquid for 5GHz, Manufactured by SPEAG**

Ingredients	(% by weight)
Water	64~78%
Mineral oil	11~18%
Emulsifiers	9~15%
Additives and Salt	2~3%

**<Tissue Dielectric Parameter Check Results>**

Frequency (MHz)	Tissue Type	Liquid Temp. (°C)	Conductivity (σ)	Permittivity (εr)	Conductivity Target (σ)	Permittivity Target (εr)	Delta a (σ) (%)	Delta (εr) (%)	Limit (%)	Date
750	Head	22.4	0.883	40.810	0.89	41.90	-0.79	-2.60	±5	2019/6/17
835	Head	22.6	0.914	41.826	0.90	41.50	1.56	0.79	±5	2019/6/16
1750	Head	22.7	1.404	40.106	1.37	40.10	2.48	0.01	±5	2019/6/15
1900	Head	22.9	1.443	40.030	1.40	40.00	3.07	0.08	±5	2019/6/15
2450	Head	22.5	1.824	38.032	1.80	39.20	1.33	-2.98	±5	2019/6/28
5250	Head	22.4	4.714	36.412	4.71	35.95	0.08	1.29	±5	2019/6/28
5600	Head	22.6	5.034	36.508	5.07	35.50	-0.71	2.84	±5	2019/6/27
5750	Head	22.5	5.315	35.552	5.22	35.35	1.82	0.57	±5	2019/6/26

**10.3 System Performance Check Results**

Comparing to the original SAR value provided by SPEAG, the verification data should be within its specification of 10 %. Below table shows the target SAR and measured SAR after normalized to 1W input power. The table below indicates the system performance check can meet the variation criterion and the plots can be referred to Appendix A of this report.

**<1g SAR>**

Date	Frequency (MHz)	Tissue Type	Input Power (mW)	Dipole S/N	Probe S/N	DAE S/N	Measured 1g SAR (W/kg)	Targeted 1g SAR (W/kg)	Normalized 1g SAR (W/kg)	Deviation (%)
2019/6/17	750	Head	250	1099	3191	1437	1.98	8.52	7.92	-7.04
2019/6/16	835	Head	250	4d162	3191	1437	2.24	9.61	8.96	-6.76
2019/6/15	1750	Head	250	1137	3191	1437	9.07	36.50	36.28	-0.60
2019/6/15	1900	Head	250	5d182	3191	1437	9.49	39.60	37.96	-4.14
2019/6/28	2450	Head	250	736	3819	715	13.20	52.70	52.8	0.19
2019/6/28	5250	Head	100	1167	3819	715	7.12	77.00	71.2	-7.53
2019/6/27	5600	Head	100	1167	3819	715	7.88	80.80	78.8	-2.48
2019/6/26	5750	Head	100	1167	3819	715	7.16	76.90	71.6	-6.89

**<10g SAR>**

Date	Frequency (MHz)	Tissue Type	Input Power (mW)	Dipole S/N	Probe S/N	DAE S/N	Measured 10g SAR (W/kg)	Targeted 10g SAR (W/kg)	Normalized 10g SAR (W/kg)	Deviation (%)
2019/6/28	5250	Head	100	1167	3819	715	2.05	22.00	20.5	-6.82
2019/6/27	5600	Head	100	1167	3819	715	2.26	23.20	22.6	-2.59

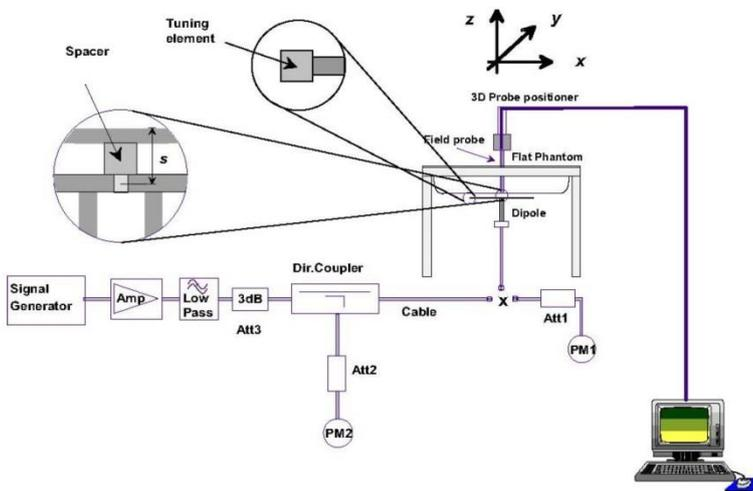

**Fig 10.3.1 System Performance Check Setup**



**Fig 10.3.2 Setup Photo**

## 11. RF Exposure Positions

### 11.1 Ear and handset reference point

Figure 11.1.1 shows the front, back, and side views of the SAM phantom. The center-of-mouth reference point is labeled "M," the left ear reference point (ERP) is marked "LE," and the right ERP is marked "RE." Each ERP is 15 mm along the B-M (back-mouth) line behind the entrance-to-ear-canal (EEC) point, as shown in Figure 11.1.2 The Reference Plane is defined as passing through the two ear reference points and point M. The line N-F (neck-front), also called the reference pivoting line, is normal to the Reference Plane and perpendicular to both a line passing through RE and LE and the B-M line (see Figure 11.1.3). Both N-F and B-M lines should be marked on the exterior of the phantom shell to facilitate handset positioning. Posterior to the N-F line the ear shape is a flat surface with 6 mm thickness at each ERP, and forward of the N-F line the ear is truncated, as illustrated in Figure 11.1.2. The ear truncation is introduced to preclude the ear lobe from interfering with handset tilt, which could lead to unstable positioning at the cheek.

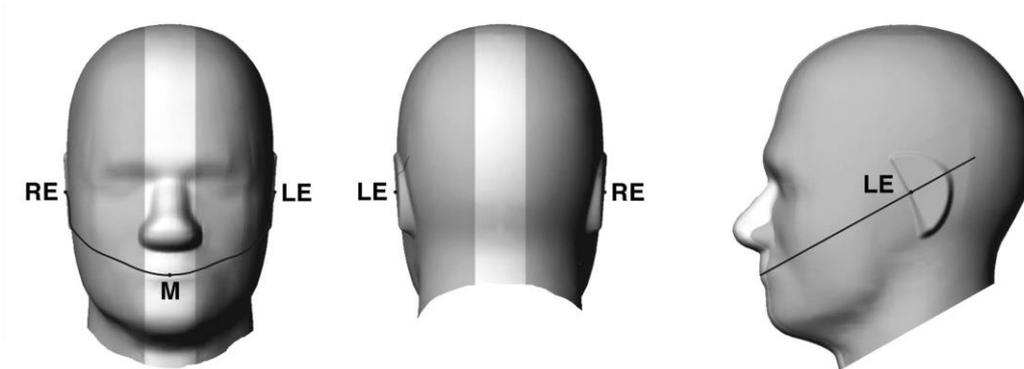

Fig 11.1.1 Front, back, and side views of SAM twin phantom

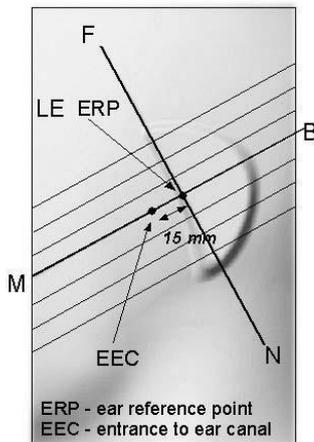

Fig 11.1.2 Close-up side view of phantom showing the ear region.

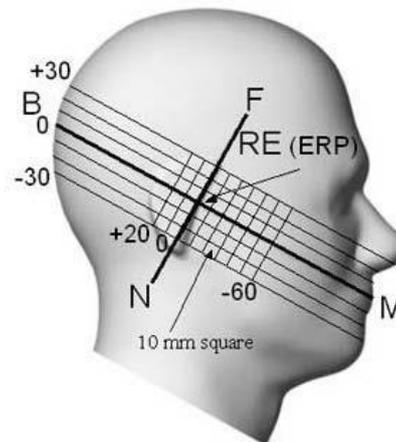

Fig 11.1.3 Side view of the phantom showing relevant markings and seven cross-sectional plane locations

## 11.2 Definition of the cheek position

1. Ready the handset for talk operation, if necessary. For example, for handsets with a cover piece (flip cover), open the cover. If the handset can transmit with the cover closed, both configurations must be tested.
2. Define two imaginary lines on the handset—the vertical centerline and the horizontal line. The vertical centerline passes through two points on the front side of the handset—the midpoint of the width  $w_t$  of the handset at the level of the acoustic output (point A in Figure 11.2.1 and Figure 11.2.2), and the midpoint of the width  $w_b$  of the bottom of the handset (point B). The horizontal line is perpendicular to the vertical centerline and passes through the center of the acoustic output (see Figure 11.2.1). The two lines intersect at point A. Note that for many handsets, point A coincides with the center of the acoustic output; however, the acoustic output may be located elsewhere on the horizontal line. Also note that the vertical centerline is not necessarily parallel to the front face of the handset (see Figure 11.2.2), especially for clamshell handsets, handsets with flip covers, and other irregularly-shaped handsets.
3. Position the handset close to the surface of the phantom such that point A is on the (virtual) extension of the line passing through points RE and LE on the phantom (see Figure 11.2.3), such that the plane defined by the vertical centerline and the horizontal line of the handset is approximately parallel to the sagittal plane of the phantom.
4. Translate the handset towards the phantom along the line passing through RE and LE until handset point A touches the pinna at the ERP.
5. While maintaining the handset in this plane, rotate it around the LE-RE line until the vertical centerline is in the plane normal to the plane containing B-M and N-F lines, i.e., the Reference Plane.
6. Rotate the handset around the vertical centerline until the handset (horizontal line) is parallel to the N-F line.
7. While maintaining the vertical centerline in the Reference Plane, keeping point A on the line passing through RE and LE, and maintaining the handset contact with the pinna, rotate the handset about the N-F line until any point on the handset is in contact with a phantom point below the pinna on the cheek. See Figure 11.2.3. The actual rotation angles should be documented in the test report.

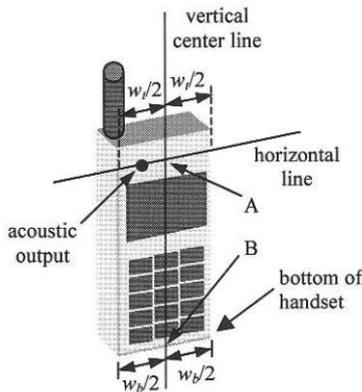

Fig 11.2.1 Handset vertical and horizontal reference lines—“fixed case”

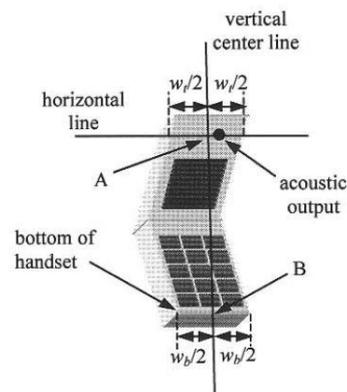

Fig 11.2.2 Handset vertical and horizontal reference lines—“clam-shell case”

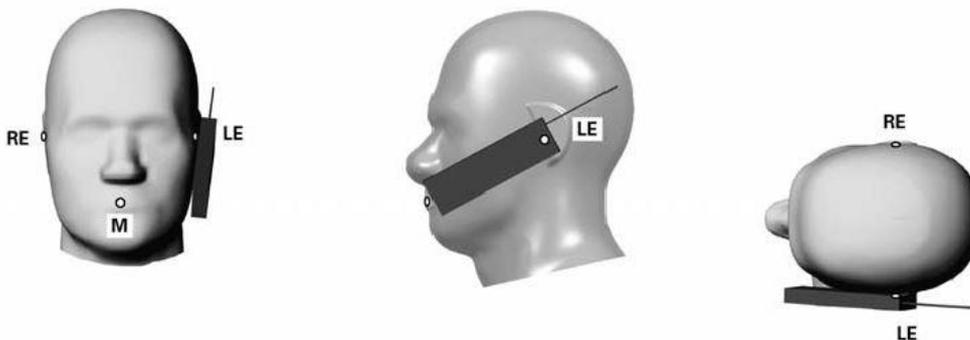

Fig 11.2.3 cheek or touch position. The reference points for the right ear (RE), left ear (LE), and mouth (M), which establish the Reference Plane for handset positioning, are indicated.

### 11.3 Definition of the tilt position

1. Ready the handset for talk operation, if necessary. For example, for handsets with a cover piece (flip cover), open the cover. If the handset can transmit with the cover closed, both configurations must be tested.
2. While maintaining the orientation of the handset, move the handset away from the pinna along the line passing through RE and LE far enough to allow a rotation of the handset away from the cheek by 15°.
3. Rotate the handset around the horizontal line by 15°.
4. While maintaining the orientation of the handset, move the handset towards the phantom on the line passing through RE and LE until any part of the handset touches the ear. The tilt position is obtained when the contact point is on the pinna. See Figure 11.3.1. If contact occurs at any location other than the pinna, e.g., the antenna at the back of the phantom head, the angle of the handset should be reduced. In this case, the tilt position is obtained if any point on the handset is in contact with the pinna and a second point

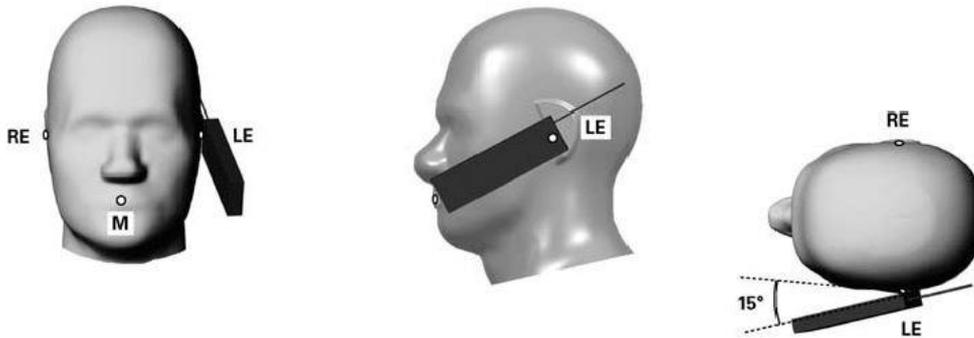

Fig 11.3.1 Tilt position. The reference points for the right ear (RE), left ear (LE), and mouth (M), which define the Reference Plane for handset positioning, are indicated.

### 11.4 Body Worn Accessory

Body-worn operating configurations are tested with the belt-clips and holsters attached to the device and positioned against a flat phantom in a normal use configuration (see Figure 11.4). Per KDB648474 D04v01r03, body-worn accessory exposure is typically related to voice mode operations when handsets are carried in body-worn accessories. The body-worn accessory procedures in FCC KDB 447498 D01v06 should be used to test for body-worn accessory SAR compliance, without a headset connected to it. This enables the test results for such configuration to be compatible with that required for hotspot mode when the body-worn accessory test separation distance is greater than or equal to that required for hotspot mode, when applicable. When the reported SAR for body-worn accessory, measured without a headset connected to the handset is  $> 1.2$  W/kg, the highest reported SAR configuration for that wireless mode and frequency band should be repeated for that body-worn accessory with a handset attached to the handset.

Accessories for body-worn operation configurations are divided into two categories: those that do not contain metallic components and those that do contain metallic components. When multiple accessories that do not contain metallic components are supplied with the device, the device is tested with only the accessory that dictates the closest spacing to the body. Then multiple accessories that contain metallic components are tested with the device with each accessory. If multiple accessories share an identical metallic component (i.e. the same metallic belt-chip used with different holsters with no other metallic components) only the accessory that dictates the closest spacing to the body is tested.

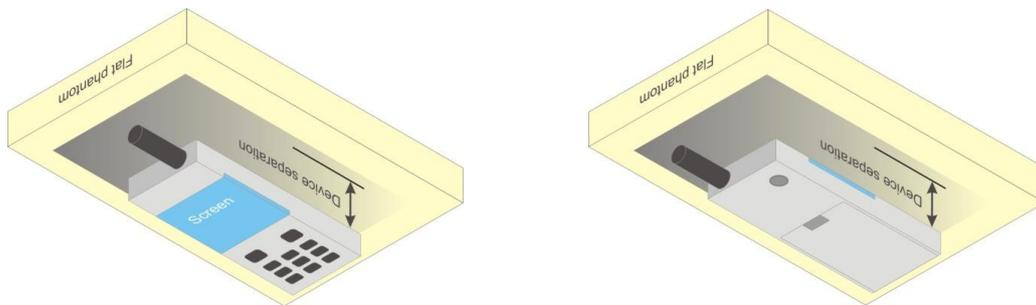

Fig 11.4 Body Worn Position



### **11.5 Product Specific 10g SAR Exposure**

For smart phones with a display diagonal dimension > 15.0 cm or an overall diagonal dimension > 16.0 cm that provide similar mobile web access and multimedia support found in mini-tablets or UMPC mini-tablets that support voice calls next to the ear, According to KDB648474 D04v01r03, the following phablet procedures should be applied to evaluate SAR compliance for each applicable wireless modes and frequency band. Devices marketed as phablets, regardless of form factors and operating characteristics must be tested as a phablet to determine SAR compliance

1. The normally required head and body-worn accessory SAR test procedures for handsets, including hotspot mode, must be applied.
2. The UMPC mini-tablet procedures must also be applied to test the SAR of all surfaces and edges with an antenna located at  $\leq 25$  mm from that surface or edge, in direct contact with a flat phantom, for 10-g extremity SAR according to the body-equivalent tissue dielectric parameters in KDB 865664 to address interactive hand use exposure conditions.6 The UMPC mini-tablet 1-g SAR at 5 mm is not required. When hotspot mode applies, 10-g extremity SAR is required only for the surfaces and edges with hotspot mode 1-g reported SAR > 1.2 W/kg.

### **11.6 Wireless Router**

Some battery-operated handsets have the capability to transmit and receive user through simultaneous transmission of WIFI simultaneously with a separate licensed transmitter. The FCC has provided guidance in FCC KDB Publication 941225 D06 v02r01 where SAR test considerations for handsets (L x W  $\geq 9$  cm x 5 cm) are based on a composite test separation distance of 10mm from the front, back and edges of the device containing transmitting antennas within 2.5cm of their edges, determined from general mixed use conditions for this type of devices. Since the hotspot SAR results may overlap with the body-worn accessory SAR requirements, the more conservative configurations can be considered, thus excluding some body-worn accessory SAR tests.

When the user enables the personal wireless router functions for the handset, actual operations include simultaneous transmission of both the WIFI transmitter and another licensed transmitter. Both transmitters often do not transmit at the same transmitting frequency and thus cannot be evaluated for SAR under actual use conditions due to the limitations of the SAR assessment probes. Therefore, SAR must be evaluated for each frequency transmission and mode separately and spatially summed with the WIFI transmitter according to FCC KDB Publication 447498 D01v06 publication procedures. The "Portable Hotspot" feature on the handset was NOT activated during SAR assessments, to ensure the SAR measurements were evaluated for a single transmission frequency RF signal at a time.

## 12. Conducted RF Output Power (Unit: dBm)

### <WCDMA Conducted Power>

1. The following tests were conducted according to the test requirements outlines in 3GPP TS 34.121 specification.
2. The procedures in KDB 941225 D01v03r01 are applied for 3GPP Rel. 6 HSPA to configure the device in the required sub-test mode(s) to determine SAR test exclusion.
3. For DC-HSDPA, the device was configured according to the H-Set 12, Fixed Reference Channel (FRC) configuration in Table C.8.1.12 of 3GPP TS 34.121-1, with the primary and the secondary serving HS-DSCH Cell enabled during the power measurement.

A summary of these settings are illustrated below:

### HSDPA Setup Configuration:

- a. The EUT was connected to Base Station Agilent E5515C referred to the Setup Configuration.
- b. The RF path losses were compensated into the measurements.
- c. A call was established between EUT and Base Station with following setting:
  - i. Set Gain Factors ( $\beta_c$  and  $\beta_d$ ) and parameters were set according to each
  - ii. Specific sub-test in the following table, C10.1.4, quoted from the TS 34.121
  - iii. Set RMC 12.2Kbps + HSDPA mode.
  - iv. Set Cell Power = -86 dBm
  - v. Set HS-DSCH Configuration Type to FRC (H-set 1, QPSK)
  - vi. Select HSDPA Uplink Parameters
  - vii. Set Delta ACK, Delta NACK and Delta CQI = 8
  - viii. Set Ack-Nack Repetition Factor to 3
  - ix. Set CQI Feedback Cycle (k) to 4 ms
  - x. Set CQI Repetition Factor to 2
  - xi. Power Ctrl Mode = All Up bits
- d. The transmitted maximum output power was recorded.

**Table C.10.1.4:  $\beta$  values for transmitter characteristics tests with HS-DPCCH**

Sub-test	$\beta_c$	$\beta_d$	$\beta_d$ (SF)	$\beta_c/\beta_d$	$\beta_{hs}$ (Note 1, Note 2)	CM (dB) (Note 3)	MPR (dB) (Note 3)
1	2/15	15/15	64	2/15	4/15	0.0	0.0
2	12/15 (Note 4)	15/15 (Note 4)	64	12/15 (Note 4)	24/15	1.0	0.0
3	15/15	8/15	64	15/8	30/15	1.5	0.5
4	15/15	4/15	64	15/4	30/15	1.5	0.5

Note 1:  $\Delta_{ACK}, \Delta_{NACK}$  and  $\Delta_{CQI} = 30/15$  with  $\beta_{hs} = 30/15 * \beta_c$ .

Note 2: For the HS-DPCCH power mask requirement test in clause 5.2C, 5.7A, and the Error Vector Magnitude (EVM) with HS-DPCCH test in clause 5.13.1A, and HSDPA EVM with phase discontinuity in clause 5.13.1AA,  $\Delta_{ACK}$  and  $\Delta_{NACK} = 30/15$  with  $\beta_{hs} = 30/15 * \beta_c$ , and  $\Delta_{CQI} = 24/15$  with  $\beta_{hs} = 24/15 * \beta_c$ .

Note 3: CM = 1 for  $\beta_c/\beta_d = 12/15, \beta_{hs}/\beta_c = 24/15$ . For all other combinations of DPDCH, DPCCH and HS-DPCCH the MPR is based on the relative CM difference. This is applicable for only UEs that support HSDPA in release 6 and later releases.

Note 4: For subtest 2 the  $\beta_c/\beta_d$  ratio of 12/15 for the TFC during the measurement period (TF1, TF0) is achieved by setting the signalled gain factors for the reference TFC (TF1, TF1) to  $\beta_c = 11/15$  and  $\beta_d = 15/15$ .

### Setup Configuration

**HSUPA Setup Configuration:**

- a. The EUT was connected to Base Station Agilent E5515C referred to the Setup Configuration.
- b. The RF path losses were compensated into the measurements.
- c. A call was established between EUT and Base Station with following setting \* :
  - i. Call Configs = 5.2B, 5.9B, 5.10B, and 5.13.2B with QPSK
  - ii. Set the Gain Factors ( $\beta_c$  and  $\beta_d$ ) and parameters (AG Index) were set according to each specific sub-test in the following table, C11.1.3, quoted from the TS 34.121
  - iii. Set Cell Power = -86 dBm
  - iv. Set Channel Type = 12.2k + HSPA
  - v. Set UE Target Power
  - vi. Power Ctrl Mode= Alternating bits
  - vii. Set and observe the E-TFCl
  - viii. Confirm that E-TFCl is equal to the target E-TFCl of 75 for sub-test 1, and other subtest's E-TFCl
- d. The transmitted maximum output power was recorded.

**Table C.11.1.3:  $\beta$  values for transmitter characteristics tests with HS-DPCCH and E-DCH**

Sub-test	$\beta_c$	$\beta_d$	$\beta_d$ (SF)	$\beta_c/\beta_d$	$\beta_{HS}$ (Note1)	$\beta_{ec}$	$\beta_{ed}$ (Note 4) (Note 5)	$\beta_{ed}$ (SF)	$\beta_{ed}$ (Codes)	CM (dB) (Note 2)	MPR (dB) (Note 2) (Note 6)	AG Index (Note 5)	E-TFCl
1	11/15 (Note 3)	15/15 (Note 3)	64	11/15 (Note 3)	22/15	209/25	1309/225	4	1	1.0	0.0	20	75
2	6/15	15/15	64	6/15	12/15	12/15	94/75	4	1	3.0	2.0	12	67
3	15/15	9/15	64	15/9	30/15	30/15	$\beta_{ed1}: 47/15$ $\beta_{ed2}: 47/15$	4	2	2.0	1.0	15	92
4	2/15	15/15	64	2/15	4/15	2/15	56/75	4	1	3.0	2.0	17	71
5	15/15	0	-	-	5/15	5/15	47/15	4	1	1.0	0.0	12	67

Note 1: For sub-test 1 to 4,  $\Delta_{ACK}$ ,  $\Delta_{NACK}$  and  $\Delta_{CQI} = 30/15$  with  $\beta_{hs} = 30/15 * \beta_c$ . For sub-test 5,  $\Delta_{ACK}$ ,  $\Delta_{NACK}$  and  $\Delta_{CQI} = 5/15$  with  $\beta_{hs} = 5/15 * \beta_c$ .

Note 2: CM = 1 for  $\beta_c/\beta_d = 12/15$ ,  $\beta_{hs}/\beta_c = 24/15$ . For all other combinations of DPDCH, DPCCH, HS-DPCCH, E-DPDCH and E-DPCCH the MPR is based on the relative CM difference.

Note 3: For subtest 1 the  $\beta_c/\beta_d$  ratio of 11/15 for the TFC during the measurement period (TF1, TF0) is achieved by setting the signalled gain factors for the reference TFC (TF1, TF1) to  $\beta_c = 10/15$  and  $\beta_d = 15/15$ .

Note 4: In case of testing by UE using E-DPDCH Physical Layer category 1, Sub-test 3 is omitted according to TS25.306 Table 5.1g.

Note 5:  $\beta_{ed}$  can not be set directly; it is set by Absolute Grant Value.

Note 6: For subtests 2, 3 and 4, UE may perform E-DPDCH power scaling at max power which could results in slightly smaller MPR values.

**Setup Configuration**

**DC-HSDPA 3GPP release 8 Setup Configuration:**

- a. The EUT was connected to Base Station referred to the Setup Configuration below
- b. The RF path losses were compensated into the measurements.
- c. A call was established between EUT and Base Station with following setting:
  - i. Set RMC 12.2Kbps + HSDPA mode.
  - ii. Set Cell Power = -25 dBm
  - iii. Set HS-DSCH Configuration Type to FRC (H-set 12, QPSK)
  - iv. Select HSDPA Uplink Parameters
  - v. Set Gain Factors ( $\beta_c$  and  $\beta_d$ ) and parameters were set according to each Specific sub-test in the following table, C10.1.4, quoted from the TS 34.121
    - a). Subtest 1:  $\beta_c/\beta_d=2/15$
    - b). Subtest 2:  $\beta_c/\beta_d=12/15$
    - c). Subtest 3:  $\beta_c/\beta_d=15/8$
    - d). Subtest 4:  $\beta_c/\beta_d=15/4$
  - vi. Set Delta ACK, Delta NACK and Delta CQI = 8
  - vii. Set Ack-Nack Repetition Factor to 3
  - viii. Set CQI Feedback Cycle (k) to 4 ms
  - ix. Set CQI Repetition Factor to 2
  - x. Power Ctrl Mode = All Up bits
- d. The transmitted maximum output power was recorded.

The following tests were conducted according to the test requirements outlines in 3GPP TS 34.121 specification. A summary of these settings are illustrated below:

C.8.1.12 Fixed Reference Channel Definition H-Set 12

Table C.8.1.12: Fixed Reference Channel H-Set 12

Parameter	Unit	Value
Nominal Avg. Inf. Bit Rate	kbps	60
Inter-TTI Distance	TTI's	1
Number of HARQ Processes	Processes	6
Information Bit Payload ( $N_{INF}$ )	Bits	120
Number Code Blocks	Blocks	1
Binary Channel Bits Per TTI	Bits	960
Total Available SML's in UE	SML's	19200
Number of SML's per HARQ Proc.	SML's	3200
Coding Rate		0.15
Number of Physical Channel Codes	Codes	1
Modulation		QPSK
Note 1: The RMC is intended to be used for DC-HSDPA mode and both cells shall transmit with identical parameters as listed in the table. Note 2: Maximum number of transmission is limited to 1, i.e., retransmission is not allowed. The redundancy and constellation version 0 shall be used.		

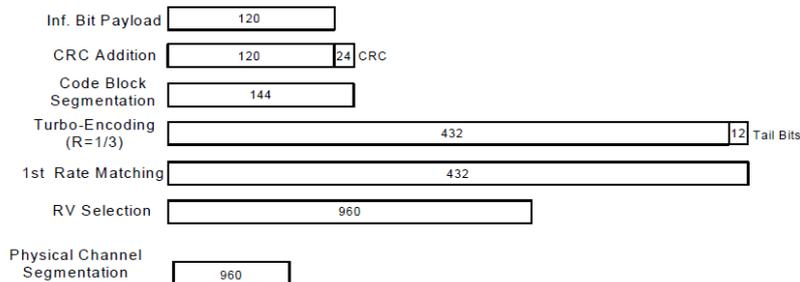

Figure C.8.19: Coding rate for Fixed reference Channel H-Set 12 (QPSK)

**Setup Configuration**



<WCDMA Conducted Power>

General Note:

1. Per KDB 941225 D01v03r01, for SAR testing is measured using a 12.2 kbps RMC with TPC bits configured to all "1's".
2. Per KDB 941225 D01v03r01, RMC 12.2kbps setting is used to evaluate SAR. The maximum output power and tune-up tolerance specified for production units in HSDPA / HSUPA / DC-HSDPA is ≤ ¼ dB higher than RMC 12.2Kbps or when the highest reported SAR of the RMC12.2Kbps is scaled by the ratio of specified maximum output power and tune-up tolerance of HSDPA / HSUPA / DC-HSDPA to RMC12.2Kbps and the adjusted SAR is ≤ 1.2 W/kg, SAR measurement is not required for HSDPA / HSUPA / DC-HSDPA, and according to the following RF output power, the output power results of the secondary modes (HSDPA / HSUPA / DC-HSDPA) are less than ¼ dB higher than the primary modes; therefore, SAR measurement is not required for HSDPA / HSUPA / DC-HSDPA.

Band		WCDMA Band II			Tune-up Limit (dBm)	WCDMA Band IV			Tune-up Limit (dBm)	WCDMA Band V			Tune-up Limit (dBm)
Tx Channel		9262	9400	9538		1312	1413	1513		4132	4182	4233	
Rx Channel		9662	9800	9938		1537	1638	1738		4357	4407	4458	
Frequency (MHz)		1852.4	1880	1907.6	1712.4	1732.6	1752.6	826.4	836.4	846.6			
3GPP Rel 99	AMR 12.2Kbps	22.12	22.29	22.14	23.00	21.74	21.88	21.81	23.00	22.33	22.41	22.28	23.00
3GPP Rel 99	RMC 12.2Kbps	22.15	22.33	22.17	23.00	21.81	21.89	21.85	23.00	22.34	22.43	22.36	23.00
3GPP Rel 6	HSDPA Subtest-1	21.43	21.43	21.26	22.00	21.25	21.44	21.39	22.00	21.62	21.63	21.47	22.00
3GPP Rel 6	HSDPA Subtest-2	21.48	21.39	20.99	22.00	21.36	21.47	21.42	22.00	21.58	21.56	21.48	22.00
3GPP Rel 6	HSDPA Subtest-3	21.00	20.91	20.78	21.50	20.85	20.98	20.93	21.50	21.09	21.17	21.00	21.50
3GPP Rel 6	HSDPA Subtest-4	20.98	21.00	20.78	21.50	20.83	20.97	20.93	21.50	21.06	21.16	20.99	21.50
3GPP Rel 8	DC-HSDPA Subtest-1	21.37	21.27	21.19	22.00	21.17	21.39	21.31	22.00	21.36	21.46	21.44	22.00
3GPP Rel 8	DC-HSDPA Subtest-2	21.42	21.38	20.97	22.00	21.28	21.45	21.26	22.00	21.43	21.46	21.34	22.00
3GPP Rel 8	DC-HSDPA Subtest-3	20.80	20.72	20.69	21.50	20.80	20.85	20.88	21.50	21.04	21.11	20.94	21.50
3GPP Rel 8	DC-HSDPA Subtest-4	20.97	20.94	20.68	21.50	20.63	20.80	20.81	21.50	20.96	20.98	20.91	21.50
3GPP Rel 6	HSUPA Subtest-1	20.83	21.13	21.18	22.00	20.96	21.44	21.04	22.00	21.57	21.34	21.30	22.00
3GPP Rel 6	HSUPA Subtest-2	20.39	20.53	20.85	21.00	20.32	20.46	20.08	21.00	20.48	20.62	20.14	21.00
3GPP Rel 6	HSUPA Subtest-3	20.27	20.34	20.09	21.00	20.19	20.16	20.36	21.00	20.05	20.28	20.16	21.00
3GPP Rel 6	HSUPA Subtest-4	20.43	20.70	20.28	21.00	20.25	20.39	20.67	21.00	20.55	20.54	20.42	21.00
3GPP Rel 6	HSUPA Subtest-5	21.40	21.50	21.40	22.00	21.40	21.50	21.30	22.00	21.60	21.60	21.30	22.00

**<LTE Conducted Power>**

**General Note:**

1. Anritsu MT8820C base station simulator was used to setup the connection with EUT; the frequency band, channel bandwidth, RB allocation configuration, modulation type are set in the base station simulator to configure EUT transmitting at maximum power and at different configurations which are requested to be reported to FCC, for conducted power measurement and SAR testing.
2. Per KDB 941225 D05v02r05, when a properly configured base station simulator is used for the SAR and power measurements, spectrum plots for each RB allocation and offset configuration is not required.
3. Per KDB 941225 D05v02r05, start with the largest channel bandwidth and measure SAR for QPSK with 1 RB allocation, using the RB offset and required test channel combination with the highest maximum output power for RB offsets at the upper edge, middle and lower edge of each required test channel.
4. Per KDB 941225 D05v02r05, 50% RB allocation for QPSK SAR testing follows 1RB QPSK allocation procedure.
5. Per KDB 941225 D05v02r05, for QPSK with 100% RB allocation, SAR is not required when the highest maximum output power for 100 % RB allocation is less than the highest maximum output power in 50% and 1 RB allocations and the highest reported SAR for 1 RB and 50% RB allocation are  $\leq 0.8$  W/kg. Otherwise, SAR is measured for the highest output power channel; and if the reported SAR is  $> 1.45$  W/kg, the remaining required test channels must also be tested.
6. Per KDB 941225 D05v02r05, 16QAM output power for each RB allocation configuration is  $>$  not  $\frac{1}{2}$  dB higher than the same configuration in QPSK and the reported SAR for the QPSK configuration is  $\leq 1.45$  W/kg; Per KDB 941225 D05v02r05, 16QAM SAR testing is not required.
7. Per KDB 941225 D05v02r05, smaller bandwidth output power for each RB allocation configuration is  $>$  not  $\frac{1}{2}$  dB higher than the same configuration in the largest supported bandwidth, and the reported SAR for the largest supported bandwidth is  $\leq 1.45$  W/kg; Per KDB 941225 D05v02r05, smaller bandwidth SAR testing is not required.
8. For LTE B4 / B5 / B12 / B17 the maximum bandwidth does not support three non-overlapping channels, per KDB 941225 D05v02r05, when a device supports overlapping channel assignment in a channel bandwidth configuration, the middle channel of the group of overlapping channels should be selected for testing.
9. LTE band 17 SAR test was covered by Band 12; according to April 2015 TCB workshop, SAR test for overlapping LTE bands can be reduced if
  - a. the maximum output power, including tolerance, for the smaller band is  $\leq$  the larger band to qualify for the SAR test exclusion
  - b. the channel bandwidth and other operating parameters for the smaller band are fully supported by the larger band



<LTE Band 2>

BW [MHz]	Modulation	RB Size	RB Offset	Power Low Ch. / Freq.	Power Middle Ch. / Freq.	Power High Ch. / Freq.	Tune-up limit (dBm)	MPR (dB)
Channel				18700	18900	19100		
Frequency (MHz)				1860	1880	1900		
20	QPSK	1	0	21.81	21.86	21.87	22.5	0
20	QPSK	1	49	22.06	22.08	22.15		
20	QPSK	1	99	21.69	21.70	21.75		
20	QPSK	50	0	20.86	20.91	20.91	21.5	1
20	QPSK	50	24	20.93	20.95	20.98		
20	QPSK	50	50	20.92	20.94	20.96		
20	16QAM	1	0	20.47	20.91	20.67	21.5	1
20	16QAM	1	49	20.57	20.93	20.44		
20	16QAM	1	99	20.48	20.47	20.44		
20	16QAM	50	0	20.14	19.99	19.96	20.5	2
20	16QAM	50	24	19.82	19.99	20.18		
20	16QAM	50	50	20.17	19.85	20.10		
20	16QAM	100	0	20.03	19.94	19.92		
Channel				18675	18900	19125	Tune-up limit (dBm)	MPR (dB)
Frequency (MHz)				1857.5	1880	1902.5		
15	QPSK	1	0	21.65	21.93	21.90	22.5	0
15	QPSK	1	37	22.02	21.98	22.04		
15	QPSK	1	74	21.93	21.82	21.89		
15	QPSK	36	0	20.86	20.90	20.92	21.5	1
15	QPSK	36	20	20.84	20.91	20.93		
15	QPSK	36	39	20.87	20.90	20.91		
15	QPSK	75	0	20.90	20.91	20.85	21.5	1
15	16QAM	1	0	20.79	20.73	20.87		
15	16QAM	1	37	21.03	20.61	21.01		
15	16QAM	1	74	20.75	20.54	20.70	20.5	2
15	16QAM	36	0	19.90	19.91	19.83		
15	16QAM	36	20	19.88	20.07	20.00		
15	16QAM	36	39	20.05	19.74	19.87		
15	16QAM	75	0	20.02	19.89	19.93		



Channel				18650	18900	19150	Tune-up limit (dBm)	MPR (dB)
Frequency (MHz)				1855	1880	1905		
10	QPSK	1	0	21.68	21.88	21.67	22.5	0
10	QPSK	1	25	21.98	22.12	21.99		
10	QPSK	1	49	21.78	21.84	21.75		
10	QPSK	25	0	20.90	20.88	20.80	21.5	1
10	QPSK	25	12	20.95	20.98	20.92		
10	QPSK	25	25	20.87	20.81	20.76		
10	QPSK	50	0	20.92	20.93	20.88	21.5	1
10	16QAM	1	0	20.39	20.73	20.43		
10	16QAM	1	25	20.82	20.84	20.44		
10	16QAM	1	49	20.46	20.45	20.40	20.5	2
10	16QAM	25	0	19.86	19.95	19.86		
10	16QAM	25	12	19.80	20.22	19.98		
10	16QAM	25	25	19.92	19.82	19.74	20.5	2
10	16QAM	50	0	19.98	20.00	19.84		
Channel				18625	18900	19175	Tune-up limit (dBm)	MPR (dB)
Frequency (MHz)				1852.5	1880	1907.5		
5	QPSK	1	0	21.84	21.71	21.88	22.5	0
5	QPSK	1	12	21.95	21.70	21.85		
5	QPSK	1	24	21.89	21.80	21.56		
5	QPSK	12	0	20.82	20.89	20.78	21.5	1
5	QPSK	12	7	20.84	20.79	20.74		
5	QPSK	12	13	20.79	20.75	20.70		
5	QPSK	25	0	20.79	20.77	20.74	21.5	1
5	16QAM	1	0	20.69	20.92	20.68		
5	16QAM	1	12	20.51	20.54	20.81		
5	16QAM	1	24	20.68	20.45	20.51	20.5	2
5	16QAM	12	0	19.66	19.69	19.66		
5	16QAM	12	7	19.68	19.69	19.72		
5	16QAM	12	13	19.70	19.64	19.62	20.5	2
5	16QAM	25	0	19.84	19.83	19.73		



Channel				18615	18900	19185	Tune-up limit (dBm)	MPR (dB)
Frequency (MHz)				1851.5	1880	1908.5		
3	QPSK	1	0	21.68	21.82	21.69	22.5	0
3	QPSK	1	8	21.59	21.65	21.61		
3	QPSK	1	14	21.68	21.74	21.75		
3	QPSK	8	0	20.76	20.90	20.89	21.5	1
3	QPSK	8	4	20.77	20.89	20.77		
3	QPSK	8	7	20.80	20.85	20.76		
3	QPSK	15	0	20.84	20.87	20.81	21.5	1
3	16QAM	1	0	20.51	20.44	20.30		
3	16QAM	1	8	20.76	20.45	20.50		
3	16QAM	1	14	20.44	20.52	20.35	20.5	2
3	16QAM	8	0	19.73	19.82	19.75		
3	16QAM	8	4	19.72	19.83	19.82		
3	16QAM	8	7	19.80	19.87	19.72	20.5	2
3	16QAM	15	0	19.62	19.95	19.55		
Channel				18607	18900	19193	Tune-up limit (dBm)	MPR (dB)
Frequency (MHz)				1850.7	1880	1909.3		
1.4	QPSK	1	0	21.59	21.67	21.83	22.5	0
1.4	QPSK	1	3	21.83	21.75	21.81		
1.4	QPSK	1	5	21.80	21.67	21.74		
1.4	QPSK	3	0	21.87	21.89	21.80		
1.4	QPSK	3	1	22.02	21.98	21.88		
1.4	QPSK	3	3	21.97	22.02	21.95	21.5	1
1.4	QPSK	6	0	20.83	20.93	20.86		
1.4	16QAM	1	0	21.05	21.04	21.05	21.5	1
1.4	16QAM	1	3	21.16	21.16	21.16		
1.4	16QAM	1	5	20.90	21.04	20.67		
1.4	16QAM	3	0	20.72	20.85	20.68		
1.4	16QAM	3	1	20.80	20.88	20.84		
1.4	16QAM	3	3	20.63	20.43	20.79	20.5	2
1.4	16QAM	6	0	19.68	19.71	19.69		



<LTE Band 4>

BW [MHz]	Modulation	RB Size	RB Offset	Power Low Ch. / Freq.	Power Middle Ch. / Freq.	Power High Ch. / Freq.	Tune-up limit (dBm)	MPR (dB)
Channel				20050	20175	20300		
Frequency (MHz)				1720	1732.5	1745		
20	QPSK	1	0	21.29	21.38	21.43		
20	QPSK	1	49	21.19	21.30	21.20	22	0
20	QPSK	1	99	20.95	21.37	20.97		
20	QPSK	50	0	20.41	20.37	20.55		
20	QPSK	50	24	20.28	20.40	20.37	21	1
20	QPSK	50	50	20.23	20.32	20.28		
20	QPSK	100	0	20.36	20.31	20.48		
20	16QAM	1	0	19.86	20.00	19.95	21	1
20	16QAM	1	49	20.04	19.99	19.98		
20	16QAM	1	99	19.49	20.06	19.67		
20	16QAM	50	0	19.13	19.33	19.45	20	2
20	16QAM	50	24	18.99	19.36	19.44		
20	16QAM	50	50	19.16	19.38	19.36		
20	16QAM	100	0	19.19	19.36	19.45		
Channel				20025	20175	20325	Tune-up limit (dBm)	MPR (dB)
Frequency (MHz)				1717.5	1732.5	1747.5		
15	QPSK	1	0	21.24	21.35	21.36	22	0
15	QPSK	1	37	20.98	21.39	21.25		
15	QPSK	1	74	21.08	21.37	21.07		
15	QPSK	36	0	20.44	20.32	20.27	21	1
15	QPSK	36	20	20.15	20.36	20.11		
15	QPSK	36	39	20.07	20.40	20.01		
15	16QAM	1	0	20.03	19.58	20.08	21	1
15	16QAM	1	37	20.28	20.21	20.28		
15	16QAM	1	74	19.87	19.91	19.59		
15	16QAM	36	0	19.23	19.28	19.15	20	2
15	16QAM	36	20	19.16	19.43	19.11		
15	16QAM	36	39	19.08	19.29	19.09		
15	16QAM	75	0	19.23	19.29	19.21		



Channel				20000	20175	20350	Tune-up limit (dBm)	MPR (dB)
Frequency (MHz)				1715	1732.5	1750		
10	QPSK	1	0	21.16	21.29	21.07	22	0
10	QPSK	1	25	21.24	21.35	21.02		
10	QPSK	1	49	20.96	21.41	21.19		
10	QPSK	25	0	20.28	20.39	20.29	21	1
10	QPSK	25	12	20.14	20.37	20.13		
10	QPSK	25	25	20.14	20.41	20.12		
10	QPSK	50	0	20.18	20.35	20.03	21	1
10	16QAM	1	0	19.88	19.87	19.62		
10	16QAM	1	25	19.89	20.20	19.82		
10	16QAM	1	49	19.68	20.00	19.97	20	2
10	16QAM	25	0	19.30	19.34	18.99		
10	16QAM	25	12	19.26	19.34	19.02		
10	16QAM	25	25	19.17	19.39	19.02	20	2
10	16QAM	50	0	19.31	19.42	19.12		
Channel				19975	20175	20375	Tune-up limit (dBm)	MPR (dB)
Frequency (MHz)				1712.5	1732.5	1752.5		
5	QPSK	1	0	21.26	21.37	21.10	22	0
5	QPSK	1	12	21.17	21.42	21.19		
5	QPSK	1	24	21.20	21.35	21.27		
5	QPSK	12	0	20.30	20.35	20.16	21	1
5	QPSK	12	7	20.22	20.33	19.99		
5	QPSK	12	13	20.28	20.39	20.10		
5	QPSK	25	0	20.37	20.41	20.07	21	1
5	16QAM	1	0	19.70	19.80	20.17		
5	16QAM	1	12	19.83	20.05	19.78		
5	16QAM	1	24	20.16	20.15	19.96	20	2
5	16QAM	12	0	19.42	19.23	18.95		
5	16QAM	12	7	19.24	19.12	18.94		
5	16QAM	12	13	19.39	19.18	18.95	20	2
5	16QAM	25	0	19.40	19.29	19.05		



Channel				19965	20175	20385	Tune-up limit (dBm)	MPR (dB)
Frequency (MHz)				1711.5	1732.5	1753.5		
3	QPSK	1	0	21.42	21.20	21.22	22	0
3	QPSK	1	8	21.35	21.20	20.95		
3	QPSK	1	14	21.34	21.18	20.93		
3	QPSK	8	0	20.33	20.41	20.14	21	1
3	QPSK	8	4	20.32	20.44	20.10		
3	QPSK	8	7	20.24	20.37	20.04		
3	QPSK	15	0	20.18	20.38	19.98	21	1
3	16QAM	1	0	19.85	19.83	19.50		
3	16QAM	1	8	19.70	19.91	19.78		
3	16QAM	1	14	20.00	20.05	19.91	20	2
3	16QAM	8	0	19.22	19.34	18.90		
3	16QAM	8	4	19.31	19.35	18.97		
3	16QAM	8	7	19.32	19.40	19.08		
3	16QAM	15	0	19.24	19.38	18.98		
Channel				19957	20175	20393	Tune-up limit (dBm)	MPR (dB)
Frequency (MHz)				1710.7	1732.5	1754.3		
1.4	QPSK	1	0	21.28	21.10	20.99	22	0
1.4	QPSK	1	3	21.37	21.29	21.20		
1.4	QPSK	1	5	21.20	21.36	21.15		
1.4	QPSK	3	0	21.32	21.38	21.24		
1.4	QPSK	3	1	21.38	21.42	21.22		
1.4	QPSK	3	3	21.34	21.37	21.17	21	1
1.4	QPSK	6	0	20.26	20.37	20.10		
1.4	16QAM	1	0	20.31	19.96	19.75	21	1
1.4	16QAM	1	3	20.37	20.27	19.71		
1.4	16QAM	1	5	20.09	20.16	19.74		
1.4	16QAM	3	0	20.22	20.22	19.96		
1.4	16QAM	3	1	20.42	20.19	20.04		
1.4	16QAM	3	3	20.26	20.19	20.00	20	2
1.4	16QAM	6	0	19.20	19.22	19.05		



<LTE Band 5>

BW [MHz]	Modulation	RB Size	RB Offset	Power Low Ch. / Freq.	Power Middle Ch. / Freq.	Power High Ch. / Freq.	Tune-up limit (dBm)	MPR (dB)
Channel				20450	20525	20600		
Frequency (MHz)				829	836.5	844		
10	QPSK	1	0	21.44	21.18	21.19	22	0
10	QPSK	1	25	21.53	21.42	21.32		
10	QPSK	1	49	21.26	21.49	21.36		
10	QPSK	25	0	20.42	20.38	20.40	21	1
10	QPSK	25	12	20.41	20.45	20.40		
10	QPSK	25	25	20.30	20.44	20.35		
10	QPSK	50	0	20.41	20.50	20.46	21	1
10	16QAM	1	0	20.26	20.15	20.15		
10	16QAM	1	25	20.17	20.23	20.18		
10	16QAM	1	49	20.04	20.41	20.18	20	2
10	16QAM	25	0	19.46	19.42	19.50		
10	16QAM	25	12	19.44	19.59	19.34		
10	16QAM	25	25	19.42	19.48	19.36	20	2
10	16QAM	50	0	19.53	19.31	19.51		
Channel				20425	20525	20625		
Frequency (MHz)				826.5	836.5	846.5		
5	QPSK	1	0	21.15	21.30	21.28	22	0
5	QPSK	1	12	21.29	21.45	21.32		
5	QPSK	1	24	21.36	21.27	21.35		
5	QPSK	12	0	20.38	20.34	20.40	21	1
5	QPSK	12	7	20.36	20.36	20.37		
5	QPSK	12	13	20.36	20.38	20.43		
5	QPSK	25	0	20.40	20.44	20.37	21	1
5	16QAM	1	0	19.89	19.84	20.20		
5	16QAM	1	12	20.14	19.92	20.06		
5	16QAM	1	24	19.62	19.93	20.04	20	2
5	16QAM	12	0	19.19	19.20	19.46		
5	16QAM	12	7	19.19	19.54	19.36		
5	16QAM	12	13	19.20	19.52	19.42	20	2
5	16QAM	25	0	19.34	19.55	19.44		



Channel				20415	20525	20635	Tune-up limit (dBm)	MPR (dB)
Frequency (MHz)				825.5	836.5	847.5		
3	QPSK	1	0	21.27	21.42	21.47	22	0
3	QPSK	1	8	21.17	21.23	21.31		
3	QPSK	1	14	21.22	21.45	21.35		
3	QPSK	8	0	20.39	20.38	20.46	21	1
3	QPSK	8	4	20.42	20.35	20.46		
3	QPSK	8	7	20.40	20.50	20.44		
3	QPSK	15	0	20.43	20.44	20.37	21	1
3	16QAM	1	0	20.09	20.14	19.72		
3	16QAM	1	8	20.00	20.22	19.82		
3	16QAM	1	14	20.00	20.01	20.01	20	2
3	16QAM	8	0	19.42	19.47	19.46		
3	16QAM	8	4	19.38	19.76	19.50		
3	16QAM	8	7	19.47	19.79	19.56		
3	16QAM	15	0	19.52	19.50	19.56		
Channel				20407	20525	20643	Tune-up limit (dBm)	MPR (dB)
Frequency (MHz)				824.7	836.5	848.3		
1.4	QPSK	1	0	21.38	21.24	21.32	22	0
1.4	QPSK	1	3	21.47	21.47	21.45		
1.4	QPSK	1	5	21.37	21.45	21.41		
1.4	QPSK	3	0	21.44	21.45	21.49		
1.4	QPSK	3	1	21.49	21.49	21.47		
1.4	QPSK	3	3	21.45	21.49	21.44	21	1
1.4	QPSK	6	0	20.37	20.39	20.45		
1.4	16QAM	1	0	20.29	19.98	20.05	21	1
1.4	16QAM	1	3	20.43	20.05	19.91		
1.4	16QAM	1	5	20.15	19.94	19.75		
1.4	16QAM	3	0	20.40	20.10	20.32		
1.4	16QAM	3	1	20.35	20.02	20.49		
1.4	16QAM	3	3	20.32	20.04	20.51	20	2
1.4	16QAM	6	0	19.24	19.25	19.32		



<LTE Band 12>

BW [MHz]	Modulation	RB Size	RB Offset	Power Low Ch. / Freq.	Power Middle Ch. / Freq.	Power High Ch. / Freq.	Tune-up limit (dBm)	MPR (dB)
Channel				23060	23095	23130		
Frequency (MHz)				704	707.5	711		
10	QPSK	1	0	22.08	22.39	22.15	23	0
10	QPSK	1	25	22.44	22.57	22.46		
10	QPSK	1	49	22.39	22.46	22.23		
10	QPSK	25	0	21.45	21.46	21.68	22	1
10	QPSK	25	12	21.53	21.51	21.70		
10	QPSK	25	25	21.60	21.63	21.64		
10	QPSK	50	0	21.49	21.63	21.67	22	1
10	16QAM	1	0	21.44	21.28	21.13		
10	16QAM	1	25	21.21	21.47	21.27		
10	16QAM	1	49	21.23	21.53	21.29	21	2
10	16QAM	25	0	20.36	20.50	20.62		
10	16QAM	25	12	20.45	20.56	20.77		
10	16QAM	25	25	20.45	20.68	20.69	21	2
10	16QAM	50	0	20.43	20.59	20.66		
Channel				23035	23095	23155		
Frequency (MHz)				701.5	707.5	713.5		
5	QPSK	1	0	22.38	22.27	22.36	23	0
5	QPSK	1	12	22.44	22.42	22.44		
5	QPSK	1	24	22.20	22.34	22.16		
5	QPSK	12	0	21.44	21.46	21.60	22	1
5	QPSK	12	7	21.60	21.55	21.51		
5	QPSK	12	13	21.44	21.68	21.57		
5	QPSK	25	0	21.46	21.52	21.52	22	1
5	16QAM	1	0	21.32	21.56	21.09		
5	16QAM	1	12	21.44	21.31	21.29		
5	16QAM	1	24	21.10	21.30	21.29	21	2
5	16QAM	12	0	20.45	20.35	20.34		
5	16QAM	12	7	20.41	20.62	20.39		
5	16QAM	12	13	20.36	20.66	20.39	21	2
5	16QAM	25	0	20.48	20.58	20.59		



Channel				23025	23095	23165	Tune-up limit (dBm)	MPR (dB)
Frequency (MHz)				700.5	707.5	714.5		
3	QPSK	1	0	22.46	22.47	22.54	23	0
3	QPSK	1	8	22.38	22.55	22.44		
3	QPSK	1	14	22.43	22.55	22.49		
3	QPSK	8	0	21.52	21.49	21.56	22	1
3	QPSK	8	4	21.54	21.64	21.64		
3	QPSK	8	7	21.56	21.68	21.58		
3	QPSK	15	0	21.63	21.68	21.66	22	1
3	16QAM	1	0	21.48	21.47	21.13		
3	16QAM	1	8	21.22	21.06	21.00		
3	16QAM	1	14	21.32	21.09	21.24	21	2
3	16QAM	8	0	20.32	20.45	20.67		
3	16QAM	8	4	20.39	20.74	20.61		
3	16QAM	8	7	20.51	20.71	20.61		
3	16QAM	15	0	20.56	20.61	20.65		
Channel				23017	23095	23173	Tune-up limit (dBm)	MPR (dB)
Frequency (MHz)				699.7	707.5	715.3		
1.4	QPSK	1	0	22.10	22.36	22.33	23	0
1.4	QPSK	1	3	22.35	22.51	22.45		
1.4	QPSK	1	5	22.20	22.38	22.42		
1.4	QPSK	3	0	22.47	22.42	22.38		
1.4	QPSK	3	1	22.50	22.46	22.49		
1.4	QPSK	3	3	22.52	22.53	22.47	22	1
1.4	QPSK	6	0	21.44	21.62	21.51		
1.4	16QAM	1	0	21.10	21.12	21.25	22	1
1.4	16QAM	1	3	21.54	21.53	21.24		
1.4	16QAM	1	5	21.21	21.28	21.14		
1.4	16QAM	3	0	21.51	21.44	21.41		
1.4	16QAM	3	1	21.46	21.74	21.78		
1.4	16QAM	3	3	21.43	21.79	21.65	21	2
1.4	16QAM	6	0	20.33	20.60	20.54		



<LTE Band 13>

BW [MHz]	Modulation	RB Size	RB Offset	Power Low Ch. / Freq.	Power Middle Ch. / Freq.	Power High Ch. / Freq.	Tune-up limit (dBm)	MPR (dB)
Channel				23230			22.5	0
Frequency (MHz)				782				
10	QPSK	1	0		21.83			
10	QPSK	1	25		21.95		21.5	1
10	QPSK	1	49		21.89			
10	QPSK	25	0		20.80			
10	QPSK	25	12		20.90		21.5	1
10	QPSK	25	25		20.84			
10	QPSK	50	0		20.73			
10	16QAM	1	0		20.76		21.5	1
10	16QAM	1	25		20.85			
10	16QAM	1	49		20.83			
10	16QAM	25	0		19.72		20.5	2
10	16QAM	25	12		19.75			
10	16QAM	25	25		19.73			
10	16QAM	50	0		19.83		20.5	2
Channel				23205	23230	23255		
Frequency (MHz)				779.5	782	784.5		
5	QPSK	1	0	21.87	21.65	21.88	22.5	0
5	QPSK	1	12	21.92	21.87	21.94		
5	QPSK	1	24	21.59	21.87	21.88		
5	QPSK	12	0	20.76	20.71	20.87	21.5	1
5	QPSK	12	7	20.75	20.74	20.88		
5	QPSK	12	13	20.79	20.90	20.99		
5	QPSK	25	0	20.79	20.89	20.85	21.5	1
5	16QAM	1	0	20.79	20.98	20.60		
5	16QAM	1	12	20.77	21.20	21.28		
5	16QAM	1	24	20.89	20.90	20.99	20.5	2
5	16QAM	12	0	19.90	19.67	19.94		
5	16QAM	12	7	19.81	19.81	19.77		
5	16QAM	12	13	19.68	19.96	19.86	20.5	2
5	16QAM	25	0	19.94	19.82	20.07		



<LTE Band 17>

BW [MHz]	Modulation	RB Size	RB Offset	Power Low Ch. / Freq.	Power Middle Ch. / Freq.	Power High Ch. / Freq.	Tune-up limit (dBm)	MPR (dB)
Channel				23780	23790	23800		
Frequency (MHz)				709	710	711		
10	QPSK	1	0	22.01	21.94	21.96	23	0
10	QPSK	1	25	22.35	22.30	22.36		
10	QPSK	1	49	22.34	22.00	21.87		
10	QPSK	25	0	21.11	21.25	21.21	22	1
10	QPSK	25	12	21.33	21.24	21.21		
10	QPSK	25	25	21.30	21.29	21.10		
10	QPSK	50	0	21.24	21.29	21.22	22	1
10	16QAM	1	0	21.29	20.92	20.91		
10	16QAM	1	25	21.42	20.88	21.39		
10	16QAM	1	49	21.40	20.71	20.81	21	2
10	16QAM	25	0	20.12	20.24	20.29		
10	16QAM	25	12	20.33	20.33	20.09		
10	16QAM	25	25	20.08	20.21	19.97	21	2
10	16QAM	50	0	20.23	20.36	20.10		
Channel				23755	23790	23825		
Frequency (MHz)				706.5	710	713.5		
5	QPSK	1	0	21.89	22.04	22.05	23	0
5	QPSK	1	12	22.17	22.27	22.08		
5	QPSK	1	24	22.23	22.17	21.79		
5	QPSK	12	0	21.08	21.09	21.04	22	1
5	QPSK	12	7	21.16	21.22	20.98		
5	QPSK	12	13	21.10	21.23	20.90		
5	QPSK	25	0	21.13	21.19	20.98	22	1
5	16QAM	1	0	21.06	20.48	20.45		
5	16QAM	1	12	20.82	20.67	20.61		
5	16QAM	1	24	20.74	20.50	20.57	21	2
5	16QAM	12	0	19.97	19.92	20.13		
5	16QAM	12	7	20.06	20.22	19.93		
5	16QAM	12	13	20.01	20.29	19.85	21	2
5	16QAM	25	0	20.13	20.44	19.96		

**<WLAN Conducted Power>**

**General Note:**

1. Per KDB 248227 D01v02r02, SAR test reduction is determined according to 802.11 transmission mode configurations and certain exposure conditions with multiple test positions. In the 2.4 GHz band, separate SAR procedures are applied to DSSS and OFDM configurations to simplify DSSS test requirements. For OFDM, in both 2.4 and 5 GHz bands, an initial test configuration must be determined for each standalone and aggregated frequency band, according to the transmission mode configuration with the highest maximum output power specified for production units to perform SAR measurements. If the same highest maximum output power applies to different combinations of channel bandwidths, modulations and data rates, additional procedures are applied to determine which test configurations require SAR measurement. When applicable, an initial test position may be applied to reduce the number of SAR measurements required for next to the ear, UMPC mini-tablet or hotspot mode configurations with multiple test positions.
2. For 2.4 GHz 802.11b DSSS, either the initial test position procedure for multiple exposure test positions or the DSSS procedure for fixed exposure position is applied; these are mutually exclusive. For 2.4 GHz and 5 GHz OFDM configurations, the initial test configuration is applied to measure SAR using either the initial test position procedure for multiple exposure test position configurations or the initial test configuration procedures for fixed exposure test conditions. Based on the reported SAR of the measured configurations and maximum output power of the transmission mode configurations that are not included in the initial test configuration, the subsequent test configuration and initial test position procedures are applied to determine if SAR measurements are required for the remaining OFDM transmission configurations. In general, the number of test channels that require SAR measurement is minimized based on maximum output power measured for the test sample(s).
3. For OFDM transmission configurations in the 2.4 GHz and 5 GHz bands, When the same maximum power is specified for multiple transmission modes in a frequency band, the largest channel bandwidth, lowest order modulation, lowest data rate and lowest order 802.11a/g/n/ac mode is used for SAR measurement, on the highest measured output power channel for each frequency band.
4. DSSS and OFDM configurations are considered separately according to the required SAR procedures. SAR is measured in the initial test position using the 802.11 transmission mode configuration required by the DSSS procedure or initial test configuration and subsequent test configuration(s) according to the OFDM procedures.18 The initial test position procedure is described in the following:
  - a. When the reported SAR of the initial test position is  $\leq 0.4$  W/kg, further SAR measurement is not required for the other test positions in that exposure configuration and 802.11 transmission mode combinations within the frequency band or aggregated band.
  - b. When the reported SAR of the test position is  $> 0.4$  W/kg, SAR is repeated for the 802.11 transmission mode configuration tested in the initial test position to measure the subsequent next closet/smallest test separation distance and maximum coupling test position on the highest maximum output power channel, until the report SAR is  $\leq 0.8$  W/kg or all required test position are tested.
  - c. For all positions/configurations, when the reported SAR is  $> 0.8$  W/kg, SAR is measured for these test positions/configurations on the subsequent next highest measured output power channel(s) until the reported SAR is  $\leq 1.2$  W/kg or all required channels are tested.



<2.4GHz WLAN>

	Mode	Channel	Frequency (MHz)	Average power (dBm)	Tune-Up Limit	Duty Cycle %
2.4GHz WLAN	802.11b 1Mbps	1	2412	15.30	15.50	97.59
		6	2437	15.30	15.50	
		11	2462	15.10	15.50	
	802.11g 6Mbps	1	2412	12.80	15.50	87.01
		6	2437	15.30	15.50	
		11	2462	15.00	15.50	
	802.11n-HT20 MCS0	1	2412	13.10	13.50	86.25
		6	2437	13.00	13.50	
		11	2462	12.80	13.50	
	802.11n-HT40 MCS0	3	2422	12.20	12.50	76.08
		6	2437	12.10	12.50	
		9	2452	12.00	12.50	



<5GHz WLAN>

	Mode	Channel	Frequency (MHz)	Average power (dBm)	Tune-Up Limit	Duty Cycle %
5.2GHz WLAN	802.11a 6Mbps	36	5180	14.40	15.00	87.50
		40	5200	14.31	15.00	
		44	5220	14.39	15.00	
		48	5240	14.26	15.00	
	802.11n-HT20 MCS0	36	5180	14.48	15.00	86.70
		40	5200	14.45	15.00	
		44	5220	14.37	15.00	
		48	5240	14.24	15.00	
	802.11n-HT40 MCS0	38	5190	14.34	14.50	76.19
		46	5230	14.23	14.50	
	802.11ac-VHT20 MCS0	36	5180	14.47	14.50	83.08
		40	5200	14.35	14.50	
		44	5220	14.31	14.50	
		48	5240	14.22	14.50	
802.11ac-VHT40 MCS0	38	5190	14.24	14.50	71.20	
	46	5230	14.12	14.50		
802.11ac-VHT80 MCS0	42	5210	13.97	14.50	55.16	



	Mode	Channel	Frequency (MHz)	Average power (dBm)	Tune-Up Limit	Duty Cycle %
5.3GHz WLAN	802.11a 6Mbps	52	5260	14.16	15.00	87.50
		56	5280	14.25	15.00	
		60	5300	14.19	15.00	
		64	5320	14.15	15.00	
	802.11n-HT20 MCS0	52	5260	14.12	15.00	86.70
		56	5280	14.30	15.00	
		60	5300	14.17	15.00	
		64	5320	14.18	15.00	
	802.11n-HT40 MCS0	54	5270	13.93	14.50	76.19
		62	5310	14.00	14.50	
	802.11ac-VHT20 MCS0	52	5260	14.10	14.50	83.08
		56	5280	13.82	14.50	
		60	5300	14.11	14.50	
		64	5320	14.13	14.50	
	802.11ac-VHT40 MCS0	54	5270	13.87	14.50	71.20
		62	5310	13.97	14.50	
802.11ac-VHT80 MCS0	58	5290	14.00	14.50	55.16	



	Mode	Channel	Frequency (MHz)	Average power (dBm)	Tune-Up Limit	Duty Cycle %
5.5GHz WLAN	802.11a 6Mbps	100	5500	13.90	15.00	87.50
		116	5580	14.12	15.00	
		124	5620	13.83	15.00	
		132	5660	13.91	15.00	
		140	5700	14.11	15.00	
		144	5720	14.06	15.00	
	802.11n-HT20 MCS0	100	5500	14.01	15.00	86.70
		116	5580	14.19	15.00	
		124	5620	14.42	15.00	
		132	5660	14.00	15.00	
		140	5700	14.22	15.00	
		144	5720	14.08	15.00	
	802.11n-HT40 MCS0	102	5510	14.20	14.50	76.19
		110	5550	14.33	14.50	
		126	5630	14.10	14.50	
		134	5670	14.22	14.50	
		142	5710	13.99	14.50	
	802.11ac-VHT20 MCS0	100	5500	13.98	14.50	83.08
		116	5580	14.16	14.50	
		124	5620	14.35	14.50	
		132	5660	13.87	14.50	
		140	5700	14.21	14.50	
		144	5720	14.04	14.50	
	802.11ac-VHT40 MCS0	102	5510	14.15	14.50	71.20
110		5550	14.30	14.50		
126		5630	13.94	14.50		
134		5670	14.19	14.50		
142		5710	13.92	14.50		
802.11ac-VHT80 MCS0	106	5530	13.96	14.50	55.16	
	122	5610	13.97	14.50		
	138	5690	13.72	14.50		



5.8GHz WLAN	Mode	Channel	Frequency (MHz)	Average power (dBm)	Tune-Up Limit	Duty Cycle %
	802.11a 6Mbps	149	5745	13.90	14.50	87.50
		157	5785	13.71	14.50	
		165	5825	13.65	14.50	
	802.11n-HT20 MCS0	149	5745	13.99	14.50	86.70
		157	5785	13.76	14.50	
		165	5825	13.65	14.50	
	802.11n-HT40 MCS0	151	5755	13.93	14.00	76.19
		159	5795	13.74	14.00	
	802.11ac-VHT20 MCS0	149	5745	13.95	14.00	83.08
157		5785	13.69	14.00		
165		5825	13.63	14.00		
802.11ac-VHT40 MCS0	151	5755	13.87	14.00	71.20	
	159	5795	13.67	14.00		
802.11ac-VHT80 MCS0	155	5775	13.56	14.00	55.16	

**<2.4GHz Bluetooth>**

**General Note:**

1. For 2.4GHz Bluetooth SAR testing was selected 1Mbps, due to its highest average power.
2. The Bluetooth duty cycle is 76.82 % as following figure, according to 2016 Oct. TCB workshop for Bluetooth SAR scaling need further consideration and the theoretical duty cycle is 83.3%, therefore the actual duty cycle will be scaled up to the theoretical value of Bluetooth reported SAR calculation.

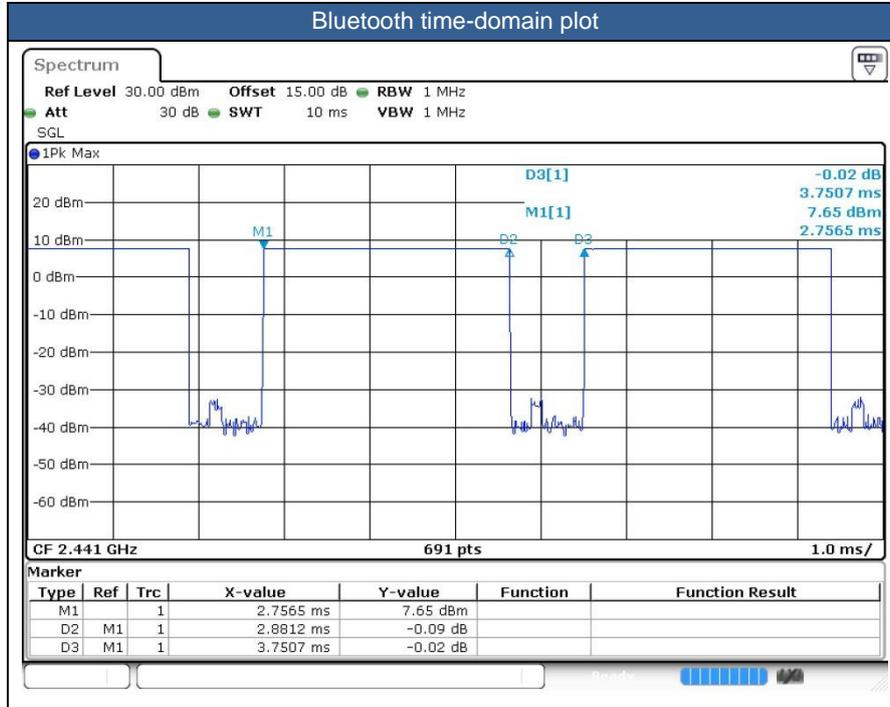

Mode	Channel	Frequency (MHz)	Data Rate
			1Mbps
BR/EDR	CH 00	2402	6.30
	CH 39	2441	<b>7.20</b>
	CH 78	2480	5.60
Tune-up Limit			8.00

Mode	Channel	Frequency (MHz)	Average power (dBm)
			GFSK
v4.0 LE	CH 00	2402	2.00
	CH 19	2440	<b>2.30</b>
	CH 39	2480	1.10
Tune-up Limit			3.00

### 13. Antenna Location

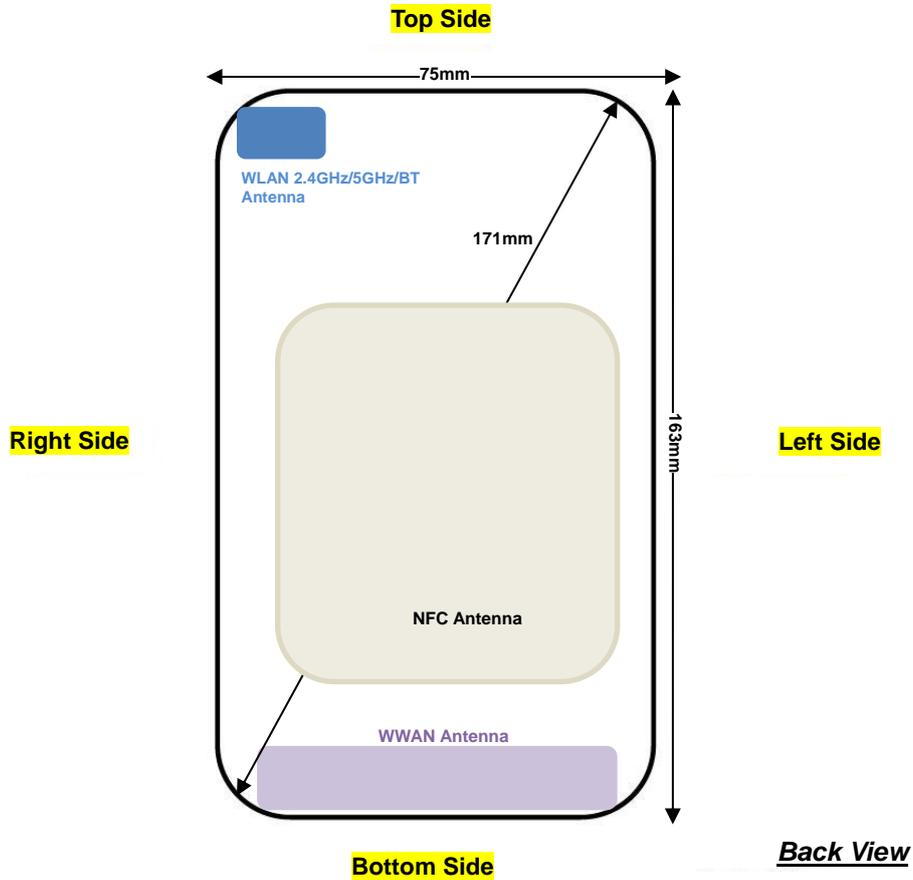

Distance of the Antenna to the EUT surface/edge						
Antennas	Back	Front	Top Side	Bottom Side	Right Side	Left Side
WWAN Antenna	≤ 25mm	≤ 25mm	>25mm	≤ 25mm	≤ 25mm	≤ 25mm
WLAN 2.4GHz/5GHz/BT	≤ 25mm	≤ 25mm	≤ 25mm	>25mm	≤ 25mm	>25mm

Positions for SAR tests; Hotspot mode						
Antennas	Back	Front	Top Side	Bottom Side	Right Side	Left Side
WWAN Antenna	Yes	Yes	No	Yes	Yes	Yes
WLAN 2.4GHz/5GHz/BT	Yes	Yes	Yes	No	Yes	No

**General Note:**

- Referring to KDB 941225 D06 v02r01, when the overall device length and width are ≥ 9cm\*5cm, the test distance is 10 mm. SAR must be measured for all sides and surfaces with a transmitting antenna located within 25mm from that surface or edge.



## **14. SAR Test Results**

### **General Note:**

1. Per KDB 447498 D01v06, the reported SAR is the measured SAR value adjusted for maximum tune-up tolerance.
  - a. Tune-up scaling Factor = tune-up limit power (mW) / EUT RF power (mW), where tune-up limit is the maximum rated power among all production units.
  - b. For SAR testing of WLAN signal with non-100% duty cycle, the measured SAR is scaled-up by the duty cycle scaling factor which is equal to "1/(duty cycle)"
  - c. For WWAN: Reported SAR(W/kg)= Measured SAR(W/kg)\*Tune-up Scaling Factor
  - d. For BT/WLAN: Reported SAR(W/kg)= Measured SAR(W/kg)\* Duty Cycle scaling factor \* Tune-up scaling factor
2. Per KDB 447498 D01v06, for each exposure position, testing of other required channels within the operating mode of a frequency band is not required when the *reported* 1-g or 10-g SAR for the mid-band or highest output power channel is:
  - $\leq 0.8$  W/kg or 2.0 W/kg, for 1-g or 10-g respectively, when the transmission band is  $\leq 100$  MHz
  - $\leq 0.6$  W/kg or 1.5 W/kg, for 1-g or 10-g respectively, when the transmission band is between 100 MHz and 200 MHz
  - $\leq 0.4$  W/kg or 1.0 W/kg, for 1-g or 10-g respectively, when the transmission band is  $\geq 200$  MHz
3. Per KDB 865664 D01v01r04, for each frequency band, repeated SAR measurement is required when the measured SAR is  $\geq 0.8$ W/kg. Per KDB 865664 D01v01r04, if the extremity repeated SAR is necessary, the same procedures should be adapted for measurements according to extremity and occupational exposure limits by applying a factor of 2.5 for extremity exposure and a factor of 5 for occupational exposure to the corresponding SAR thresholds.
4. Per KDB 648474 D04v01r03, when the reported SAR for a body-worn accessory measured without a headset connected to the handset is  $\leq 1.2$  W/kg, SAR testing with a headset connected to the handset is not required.
5. Per KDB648474 D04v01r03, for smart phones with a display diagonal dimension > 15cm or an overall diagonal dimension > 16cm, when hotspot mode applies, 10-g product specific SAR is required only for the surfaces and edges with hotspot mode 1-g reported SAR > 1.2 W/kg, in this report all the hotspot mode results are < 1.2W/kg.
6. WLAN 5.3/5.5GHz tested the product specific 10g SAR since it has no hotspot mode.

### **WCDMA Note:**

1. Per KDB 941225 D01v03r01, for SAR testing is measured using a 12.2 kbps RMC with TPC bits configured to all "1's".
2. Per KDB 941225 D01v03r01, RMC 12.2kbps setting is used to evaluate SAR. The maximum output power and tune-up tolerance specified for production units in HSDPA / HSUPA / DC-HSDPA is  $\leq \frac{1}{4}$  dB higher than RMC 12.2Kbps or when the highest reported SAR of the RMC12.2Kbps is scaled by the ratio of specified maximum output power and tune-up tolerance of HSDPA / HSUPA / DC-HSDPA to RMC12.2Kbps and the adjusted SAR is  $\leq 1.2$  W/kg, SAR measurement is not required for HSDPA / HSUPA / DC-HSDPA, and according to the following RF output power, the output power results of the secondary modes (HSDPA / HSUPA / DC-HSDPA) are less than  $\frac{1}{4}$  dB higher than the primary modes; therefore, SAR measurement is not required for HSDPA / HSUPA / DC-HSDPA.

**LTE Note:**

1. Per KDB 941225 D05v02r05, start with the largest channel bandwidth and measure SAR for QPSK with 1 RB allocation, using the RB offset and required test channel combination with the highest maximum output power for RB offsets at the upper edge, middle and lower edge of each required test channel.
2. Per KDB 941225 D05v02r05, 50% RB allocation for QPSK SAR testing follows 1RB QPSK allocation procedure.
3. Per KDB 941225 D05v02r05, for QPSK with 100% RB allocation, SAR is not required when the highest maximum output power for 100 % RB allocation is less than the highest maximum output power in 50% and 1 RB allocations and the highest reported SAR for 1 RB and 50% RB allocation are  $\leq 0.8$  W/kg. Otherwise, SAR is measured for the highest output power channel; and if the reported SAR is  $> 1.45$  W/kg, the remaining required test channels must also be tested.
4. Per KDB 941225 D05v02r05, 16QAM output power for each RB allocation configuration is  $>$  not  $\frac{1}{2}$  dB higher than the same configuration in QPSK and the reported SAR for the QPSK configuration is  $\leq 1.45$  W/kg; Per KDB 941225 D05v02r05, 16QAM SAR testing is not required.
5. Per KDB 941225 D05v02r05, smaller bandwidth output power for each RB allocation configuration is  $>$  not  $\frac{1}{2}$  dB higher than the same configuration in the largest supported bandwidth, and the reported SAR for the largest supported bandwidth is  $\leq 1.45$  W/kg; Per KDB 941225 D05v02r05, smaller bandwidth SAR testing is not required.
6. For LTE B4 / B5 / B12 / B17 the maximum bandwidth does not support three non-overlapping channels, per KDB 941225 D05v02r05, when a device supports overlapping channel assignment in a channel bandwidth configuration, the middle channel of the group of overlapping channels should be selected for testing.
7. LTE band 17 SAR test was covered by Band 12; according to April 2015 TCB workshop, SAR test for overlapping LTE bands can be reduced if
  - a. the maximum output power, including tolerance, for the smaller band is  $\leq$  the larger band to qualify for the SAR test exclusion
  - b. the channel bandwidth and other operating parameters for the smaller band are fully supported by the larger band

**WLAN/Bluetooth Note:**

1. Per KDB 248227 D01v02r02, for 2.4GHz 802.11g/n SAR testing is not required when the highest reported SAR for DSSS is adjusted by the ratio of OFDM to DSSS specified maximum output power and the adjusted SAR is  $\leq 1.2$  W/kg.
2. Per KDB 248227 D01v02r02, U-NII-1 SAR testing is not required when the U-NII-2A band highest reported SAR for a test configuration is  $\leq 1.2$  W/kg, SAR is not required for U-NII-1 band.
3. When the reported SAR of the test position is  $> 0.4$  W/kg, SAR is repeated for the 802.11 transmission mode configuration tested in the initial test position to measure the subsequent next closet/smallest test separation distance and maximum coupling test position on the highest maximum output power channel, until the report SAR is  $\leq 0.8$  W/kg or all required test position are tested.
4. For all positions / configurations, when the reported SAR is  $> 0.8$  W/kg, SAR is measured for these test positions / configurations on the subsequent next highest measured output power channel(s) until the reported SAR is  $\leq 1.2$  W/kg or all required channels are tested.
5. During SAR testing the WLAN transmission was verified using a spectrum analyzer.



14.1 Head SAR

<WCDMA SAR>

Plot No.	Band	Mode	Test Position	Ch.	Freq. (MHz)	Average Power (dBm)	Tune-Up Limit (dBm)	Tune-up Scaling Factor	Power Drift (dB)	Measured 1g SAR (W/kg)	Reported 1g SAR (W/kg)
	WCDMA V	RMC 12.2Kbps	Right Cheek	4182	836.4	22.43	23.00	1.140	0.03	0.151	0.172
	WCDMA V	RMC 12.2Kbps	Right Tilted	4182	836.4	22.43	23.00	1.140	0.08	0.065	0.075
	WCDMA V	RMC 12.2Kbps	Left Cheek	4182	836.4	22.43	23.00	1.140	0.11	0.210	0.239
	WCDMA V	RMC 12.2Kbps	Left Tilted	4182	836.4	22.43	23.00	1.140	0.04	0.072	0.082
01	WCDMA V	RMC 12.2Kbps	Left Cheek	4132	826.4	22.34	23.00	1.164	0.09	0.292	0.340
	WCDMA V	RMC 12.2Kbps	Left Cheek	4233	846.6	22.36	23.00	1.159	0.01	0.157	0.182
02	WCDMA IV	RMC 12.2Kbps	Right Cheek	1413	1732.6	21.89	23.00	1.291	0.03	0.319	0.412
	WCDMA IV	RMC 12.2Kbps	Right Tilted	1413	1732.6	21.89	23.00	1.291	-0.02	0.071	0.092
	WCDMA IV	RMC 12.2Kbps	Left Cheek	1413	1732.6	21.89	23.00	1.291	0.09	0.126	0.163
	WCDMA IV	RMC 12.2Kbps	Left Tilted	1413	1732.6	21.89	23.00	1.291	0.01	0.084	0.108
	WCDMA IV	RMC 12.2Kbps	Right Cheek	1312	1712.4	21.81	23.00	1.315	0.04	0.242	0.318
	WCDMA IV	RMC 12.2Kbps	Right Cheek	1513	1752.6	21.85	23.00	1.303	0.02	0.247	0.322
	WCDMA II	RMC 12.2Kbps	Right Cheek	9400	1880	22.33	23.00	1.167	-0.06	0.409	0.477
	WCDMA II	RMC 12.2Kbps	Right Tilted	9400	1880	22.33	23.00	1.167	0.02	0.162	0.189
	WCDMA II	RMC 12.2Kbps	Left Cheek	9400	1880	22.33	23.00	1.167	-0.05	0.219	0.256
	WCDMA II	RMC 12.2Kbps	Left Tilted	9400	1880	22.33	23.00	1.167	0.02	0.153	0.179
	WCDMA II	RMC 12.2Kbps	Right Cheek	9262	1852.4	22.15	23.00	1.216	0.06	0.381	0.463
03	WCDMA II	RMC 12.2Kbps	Right Cheek	9538	1907.6	22.17	23.00	1.211	-0.17	0.552	0.668



<FDD LTE SAR>

Plot No.	Band	BW (MHz)	Modulation	RB Size	RB Offset	Test Position	Ch.	Freq. (MHz)	Average Power (dBm)	Tune-Up Limit (dBm)	Tune-up Scaling Factor	Power Drift (dB)	Measured 1g SAR (W/kg)	Reported 1g SAR (W/kg)
	LTE Band 12	10M	QPSK	1	25	Right Cheek	23095	707.5	22.57	23.00	1.104	-0.16	0.269	0.297
	LTE Band 12	10M	QPSK	1	25	Right Tilted	23095	707.5	22.57	23.00	1.104	0.04	0.157	0.173
04	LTE Band 12	10M	QPSK	1	25	Left Cheek	23095	707.5	22.57	23.00	1.104	0.05	0.322	0.356
	LTE Band 12	10M	QPSK	1	25	Left Tilted	23095	707.5	22.57	23.00	1.104	0.03	0.157	0.173
	LTE Band 12	10M	QPSK	25	12	Right Cheek	23095	707.5	21.51	22.00	1.119	0.02	0.217	0.243
	LTE Band 12	10M	QPSK	25	12	Right Tilted	23095	707.5	21.51	22.00	1.119	0.05	0.125	0.140
	LTE Band 12	10M	QPSK	25	12	Left Cheek	23095	707.5	21.51	22.00	1.119	0.08	0.249	0.279
	LTE Band 12	10M	QPSK	25	12	Left Tilted	23095	707.5	21.51	22.00	1.119	-0.01	0.124	0.139
	LTE Band 13	10M	QPSK	1	25	Right Cheek	23230	782	21.95	22.50	1.135	0.04	0.140	0.159
	LTE Band 13	10M	QPSK	1	25	Right Tilted	23230	782	21.95	22.50	1.135	0.02	0.071	0.080
05	LTE Band 13	10M	QPSK	1	25	Left Cheek	23230	782	21.95	22.50	1.135	0.08	0.170	0.193
	LTE Band 13	10M	QPSK	1	25	Left Tilted	23230	782	21.95	22.50	1.135	0.03	0.071	0.081
	LTE Band 13	10M	QPSK	25	12	Right Cheek	23230	782	20.90	21.50	1.148	-0.11	0.112	0.129
	LTE Band 13	10M	QPSK	25	12	Right Tilted	23230	782	20.90	21.50	1.148	0.01	0.057	0.066
	LTE Band 13	10M	QPSK	25	12	Left Cheek	23230	782	20.90	21.50	1.148	0.04	0.135	0.155
	LTE Band 13	10M	QPSK	25	12	Left Tilted	23230	782	20.90	21.50	1.148	0.09	0.056	0.064
	LTE Band 5	10M	QPSK	1	25	Right Cheek	20525	836.5	21.42	22.00	1.143	-0.02	0.105	0.120
	LTE Band 5	10M	QPSK	1	25	Right Tilted	20525	836.5	21.42	22.00	1.143	0.03	0.049	0.056
06	LTE Band 5	10M	QPSK	1	25	Left Cheek	20525	836.5	21.42	22.00	1.143	0.02	0.163	0.186
	LTE Band 5	10M	QPSK	1	25	Left Tilted	20525	836.5	21.42	22.00	1.143	0.09	0.056	0.064
	LTE Band 5	10M	QPSK	25	12	Right Cheek	20525	836.5	20.45	21.00	1.135	-0.01	0.083	0.094
	LTE Band 5	10M	QPSK	25	12	Right Tilted	20525	836.5	20.45	21.00	1.135	0.06	0.039	0.044
	LTE Band 5	10M	QPSK	25	12	Left Cheek	20525	836.5	20.45	21.00	1.135	0.02	0.125	0.142
	LTE Band 5	10M	QPSK	25	12	Left Tilted	20525	836.5	20.45	21.00	1.135	0.13	0.044	0.050
07	LTE Band 4	20M	QPSK	1	0	Right Cheek	20175	1732.5	21.38	22.00	1.153	0.17	0.253	0.292
	LTE Band 4	20M	QPSK	1	0	Right Tilted	20175	1732.5	21.38	22.00	1.153	0.1	0.060	0.069
	LTE Band 4	20M	QPSK	1	0	Left Cheek	20175	1732.5	21.38	22.00	1.153	0.04	0.014	0.016
	LTE Band 4	20M	QPSK	1	0	Left Tilted	20175	1732.5	21.38	22.00	1.153	0.03	0.076	0.088
	LTE Band 4	20M	QPSK	50	0	Right Cheek	20175	1732.5	20.37	21.00	1.156	-0.04	0.162	0.187
	LTE Band 4	20M	QPSK	50	0	Right Tilted	20175	1732.5	20.37	21.00	1.156	0.03	0.047	0.054
	LTE Band 4	20M	QPSK	50	0	Left Cheek	20175	1732.5	20.37	21.00	1.156	0.08	0.090	0.104
	LTE Band 4	20M	QPSK	50	0	Left Tilted	20175	1732.5	20.37	21.00	1.156	0.01	0.060	0.069
08	LTE Band 2	20M	QPSK	1	49	Right Cheek	19100	1900	22.15	22.50	1.084	-0.11	0.523	0.567
	LTE Band 2	20M	QPSK	1	49	Right Tilted	19100	1900	22.15	22.50	1.084	-0.02	0.167	0.181
	LTE Band 2	20M	QPSK	1	49	Left Cheek	19100	1900	22.15	22.50	1.084	0.08	0.285	0.309
	LTE Band 2	20M	QPSK	1	49	Left Tilted	19100	1900	22.15	22.50	1.084	0.02	0.158	0.171
	LTE Band 2	20M	QPSK	1	49	Right Cheek	18900	1880	22.08	22.50	1.102	0.03	0.398	0.438
	LTE Band 2	20M	QPSK	1	49	Right Cheek	18700	1860	22.06	22.50	1.107	0.09	0.369	0.408
	LTE Band 2	20M	QPSK	50	24	Right Cheek	19100	1900	20.98	21.50	1.127	0.09	0.411	0.463
	LTE Band 2	20M	QPSK	50	24	Right Tilted	19100	1900	20.98	21.50	1.127	0.02	0.129	0.145
	LTE Band 2	20M	QPSK	50	24	Left Cheek	19100	1900	20.98	21.50	1.127	0.01	0.162	0.183
	LTE Band 2	20M	QPSK	50	24	Left Tilted	19100	1900	20.98	21.50	1.127	0.08	0.121	0.136

**<WLAN 2.4GHz SAR>**

Plot No.	Band	Mode	Test Position	Ch.	Freq. (MHz)	Average Power (dBm)	Tune-Up Limit (dBm)	Tune-up Scaling Factor	Duty Cycle %	Duty Cycle Scaling Factor	Power Drift (dB)	Measured 1g SAR (W/kg)	Reported 1g SAR (W/kg)
	WLAN2.4GHz	802.11b 1Mbps	Right Cheek	6	2437	15.30	15.50	1.047	97.59	1.025	0.02	0.132	0.142
	WLAN2.4GHz	802.11b 1Mbps	Right Tilted	6	2437	15.30	15.50	1.047	97.59	1.025	0.09	0.084	0.090
	WLAN2.4GHz	802.11b 1Mbps	Left Cheek	6	2437	15.30	15.50	1.047	97.59	1.025	-0.05	0.186	0.200
	WLAN2.4GHz	802.11b 1Mbps	Left Tilted	6	2437	15.30	15.50	1.047	97.59	1.025	-0.01	0.152	0.163
09	WLAN2.4GHz	802.11b 1Mbps	Left Cheek	1	2412	15.30	15.50	1.047	97.59	1.025	0.09	0.192	<b>0.206</b>
	WLAN2.4GHz	802.11b 1Mbps	Left Cheek	11	2462	15.10	15.50	1.096	97.59	1.025	0.03	0.170	0.191

**<WLAN 5GHz SAR>**

Plot No.	Band	Mode	Test Position	Ch.	Freq. (MHz)	Average Power (dBm)	Tune-Up Limit (dBm)	Tune-up Scaling Factor	Duty Cycle %	Duty Cycle Scaling Factor	Power Drift (dB)	Measured 1g SAR (W/kg)	Reported 1g SAR (W/kg)
	WLAN5.3GHz	802.11a 6Mbps	Right Cheek	56	5280	14.25	15.00	1.189	87.5	1.143	0.03	0.186	0.253
	WLAN5.3GHz	802.11a 6Mbps	Right Tilted	56	5280	14.25	15.00	1.189	87.5	1.143	0.09	0.175	0.238
	WLAN5.3GHz	802.11a 6Mbps	Left Cheek	56	5280	14.25	15.00	1.189	87.5	1.143	0.04	0.447	0.607
	WLAN5.3GHz	802.11a 6Mbps	Left Tilted	56	5280	14.25	15.00	1.189	87.5	1.143	0.15	0.294	0.399
	WLAN5.3GHz	802.11a 6Mbps	Left Cheek	52	5260	14.16	15.00	1.213	87.5	1.143	-0.06	0.424	0.588
	WLAN5.3GHz	802.11a 6Mbps	Left Cheek	60	5300	14.19	15.00	1.205	87.5	1.143	0.05	0.455	0.627
10	WLAN5.3GHz	802.11a 6Mbps	Left Cheek	64	5320	14.15	15.00	1.216	87.5	1.143	0.08	0.456	<b>0.634</b>
	WLAN5.5GHz	802.11a 6Mbps	Right Cheek	116	5580	14.12	15.00	1.225	87.5	1.143	0.03	0.270	0.378
	WLAN5.5GHz	802.11a 6Mbps	Right Tilted	116	5580	14.12	15.00	1.225	87.5	1.143	0.08	0.299	0.419
	WLAN5.5GHz	802.11a 6Mbps	Left Cheek	116	5580	14.12	15.00	1.225	87.5	1.143	0.02	0.547	0.766
	WLAN5.5GHz	802.11a 6Mbps	Left Tilted	116	5580	14.12	15.00	1.225	87.5	1.143	0.07	0.467	0.654
	WLAN5.5GHz	802.11a 6Mbps	Left Cheek	100	5500	13.90	15.00	1.288	87.5	1.143	0.09	0.525	0.773
	WLAN5.5GHz	802.11a 6Mbps	Left Cheek	124	5620	13.83	15.00	1.309	87.5	1.143	0.11	0.517	0.774
	WLAN5.5GHz	802.11a 6Mbps	Left Cheek	132	5660	13.91	15.00	1.285	87.5	1.143	0.04	0.526	0.773
	WLAN5.5GHz	802.11a 6Mbps	Left Cheek	140	5700	14.11	15.00	1.227	87.5	1.143	0.08	0.536	0.752
11	WLAN5.5GHz	802.11a 6Mbps	Left Cheek	144	5720	14.06	15.00	1.242	87.5	1.143	-0.02	0.618	<b>0.877</b>
	WLAN5.8GHz	802.11a 6Mbps	Right Cheek	149	5745	13.90	14.50	1.148	87.5	1.143	0.06	0.345	0.453
	WLAN5.8GHz	802.11a 6Mbps	Right Tilted	149	5745	13.90	14.50	1.148	87.5	1.143	0.07	0.387	0.508
12	WLAN5.8GHz	802.11a 6Mbps	Left Cheek	149	5745	13.90	14.50	1.148	87.5	1.143	0.03	0.592	<b>0.777</b>
	WLAN5.8GHz	802.11a 6Mbps	Left Tilted	149	5745	13.90	14.50	1.148	87.5	1.143	0.05	0.521	0.684
	WLAN5.8GHz	802.11a 6Mbps	Left Cheek	157	5785	13.71	14.50	1.200	87.5	1.143	0.16	0.494	0.677
	WLAN5.8GHz	802.11a 6Mbps	Left Cheek	165	5825	13.65	14.50	1.216	87.5	1.143	0.05	0.418	0.581

**<Bluetooth SAR>**

Plot No.	Band	Mode	Test Position	Ch.	Freq. (MHz)	Average Power (dBm)	Tune-Up Limit (dBm)	Tune-up Scaling Factor	Duty Cycle %	Duty Cycle Scaling Factor	Power Drift (dB)	Measured 1g SAR (W/kg)	Reported 1g SAR (W/kg)
	Bluetooth	DH5 1Mbps	Right Cheek	39	2441	7.20	8.00	1.202	76.82	1.084	0.06	0.021	0.027
	Bluetooth	DH5 1Mbps	Right Tilted	39	2441	7.20	8.00	1.202	76.82	1.084	0.01	0.006	0.007
	Bluetooth	DH5 1Mbps	Left Cheek	39	2441	7.20	8.00	1.202	76.82	1.084	-0.08	0.042	0.055
	Bluetooth	DH5 1Mbps	Left Tilted	39	2441	7.20	8.00	1.202	76.82	1.084	-0.11	0.026	0.034
	Bluetooth	DH5 1Mbps	Left Cheek	0	2402	6.30	8.00	1.479	76.82	1.084	-0.09	0.037	0.059
13	Bluetooth	DH5 1Mbps	Left Cheek	78	2480	5.60	8.00	1.738	76.82	1.084	0.01	0.033	<b>0.062</b>



14.2 Hotspot SAR

<WCDMA SAR>

Plot No.	Band	Mode	Test Position	Gap (mm)	Ch.	Freq. (MHz)	Average Power (dBm)	Tune-Up Limit (dBm)	Tune-up Scaling Factor	Power Drift (dB)	Measured 1g SAR (W/kg)	Reported 1g SAR (W/kg)
	WCDMA V	RMC 12.2Kbps	Front	10	4182	836.4	22.43	23	1.140	-0.04	0.145	0.165
	WCDMA V	RMC 12.2Kbps	Back	10	4182	836.4	22.43	23	1.140	0.01	0.378	0.431
	WCDMA V	RMC 12.2Kbps	Left Side	10	4182	836.4	22.43	23	1.140	0.12	0.196	0.223
	WCDMA V	RMC 12.2Kbps	Right Side	10	4182	836.4	22.43	23	1.140	0.08	0.058	0.066
	WCDMA V	RMC 12.2Kbps	Bottom Side	10	4182	836.4	22.43	23	1.140	0.02	0.091	0.103
14	WCDMA V	RMC 12.2Kbps	Back	10	4132	826.4	22.34	23	1.164	-0.07	0.448	0.522
	WCDMA V	RMC 12.2Kbps	Back	10	4233	846.6	22.36	23	1.159	0.05	0.327	0.379
	WCDMA IV	RMC 12.2Kbps	Front	10	1413	1732.6	21.89	23	1.291	-0.03	0.569	0.735
	WCDMA IV	RMC 12.2Kbps	Back	10	1413	1732.6	21.89	23	1.291	0.03	0.526	0.679
	WCDMA IV	RMC 12.2Kbps	Left Side	10	1413	1732.6	21.89	23	1.291	0.04	0.103	0.133
	WCDMA IV	RMC 12.2Kbps	Right Side	10	1413	1732.6	21.89	23	1.291	0.09	0.442	0.571
	WCDMA IV	RMC 12.2Kbps	Bottom Side	10	1413	1732.6	21.89	23	1.291	0.01	0.129	0.167
15	WCDMA IV	RMC 12.2Kbps	Front	10	1312	1712.4	21.81	23	1.315	-0.06	0.579	0.762
	WCDMA IV	RMC 12.2Kbps	Front	10	1513	1752.6	21.85	23	1.303	0.01	0.516	0.672
	WCDMA II	RMC 12.2Kbps	Front	10	9400	1880	22.33	23	1.167	-0.05	0.564	0.658
	WCDMA II	RMC 12.2Kbps	Back	10	9400	1880	22.33	23	1.167	0.04	0.493	0.575
	WCDMA II	RMC 12.2Kbps	Left Side	10	9400	1880	22.33	23	1.167	0.02	0.123	0.144
	WCDMA II	RMC 12.2Kbps	Right Side	10	9400	1880	22.33	23	1.167	0.03	0.542	0.632
	WCDMA II	RMC 12.2Kbps	Bottom Side	10	9400	1880	22.33	23	1.167	0.06	0.133	0.155
	WCDMA II	RMC 12.2Kbps	Front	10	9262	1852.4	22.15	23	1.216	0.11	0.560	0.681
16	WCDMA II	RMC 12.2Kbps	Front	10	9538	1907.6	22.17	23	1.211	-0.12	0.599	0.725



<LTE SAR>

Plot No.	Band	BW (MHz)	Modulation	RB Size	RB Offset	Test Position	Gap (mm)	Ch.	Freq. (MHz)	Average Power (dBm)	Tune-Up Limit (dBm)	Tune-up Scaling Factor	Power Drift (dB)	Measured 1g SAR (W/kg)	Reported 1g SAR (W/kg)
17	LTE Band 12	10M	QPSK	1	25	Front	10	23095	707.5	22.57	23	1.104	0.15	0.290	0.320
	LTE Band 12	10M	QPSK	1	25	Back	10	23095	707.5	22.57	23	1.104	0.04	0.407	<b>0.449</b>
	LTE Band 12	10M	QPSK	1	25	Left Side	10	23095	707.5	22.57	23	1.104	-0.04	0.314	0.347
	LTE Band 12	10M	QPSK	1	25	Right Side	10	23095	707.5	22.57	23	1.104	0.03	0.227	0.251
	LTE Band 12	10M	QPSK	1	25	Bottom Side	10	23095	707.5	22.57	23	1.104	0.03	0.053	0.059
	LTE Band 12	10M	QPSK	25	12	Front	10	23095	707.5	21.51	22	1.119	0.04	0.230	0.257
	LTE Band 12	10M	QPSK	25	12	Back	10	23095	707.5	21.51	22	1.119	-0.02	0.316	0.354
	LTE Band 12	10M	QPSK	25	12	Left Side	10	23095	707.5	21.51	22	1.119	0.06	0.251	0.281
	LTE Band 12	10M	QPSK	25	12	Right Side	10	23095	707.5	21.51	22	1.119	0.08	0.186	0.208
	LTE Band 12	10M	QPSK	25	12	Bottom Side	10	23095	707.5	21.51	22	1.119	0.02	0.052	0.058
18	LTE Band 13	10M	QPSK	1	25	Front	10	23230	782	21.95	22.5	1.135	0.01	0.107	0.121
	LTE Band 13	10M	QPSK	1	25	Back	10	23230	782	21.95	22.5	1.135	-0.09	0.186	<b>0.211</b>
	LTE Band 13	10M	QPSK	1	25	Left Side	10	23230	782	21.95	22.5	1.135	0.02	0.034	0.038
	LTE Band 13	10M	QPSK	1	25	Right Side	10	23230	782	21.95	22.5	1.135	0.04	0.020	0.023
	LTE Band 13	10M	QPSK	1	25	Bottom Side	10	23230	782	21.95	22.5	1.135	0.11	0.039	0.044
	LTE Band 13	10M	QPSK	25	12	Front	10	23230	782	20.9	21.5	1.148	0.13	0.087	0.099
	LTE Band 13	10M	QPSK	25	12	Back	10	23230	782	20.9	21.5	1.148	0.02	0.150	0.172
	LTE Band 13	10M	QPSK	25	12	Left Side	10	23230	782	20.9	21.5	1.148	0.04	0.028	0.032
	LTE Band 13	10M	QPSK	25	12	Right Side	10	23230	782	20.9	21.5	1.148	0.01	0.016	0.019
	LTE Band 13	10M	QPSK	25	12	Bottom Side	10	23230	782	20.9	21.5	1.148	0.05	0.031	0.036
19	LTE Band 5	10M	QPSK	1	25	Front	10	20525	836.5	21.42	22	1.143	-0.11	0.110	0.126
	LTE Band 5	10M	QPSK	1	25	Back	10	20525	836.5	21.42	22	1.143	0.03	0.322	<b>0.368</b>
	LTE Band 5	10M	QPSK	1	25	Left Side	10	20525	836.5	21.42	22	1.143	0.04	0.143	0.163
	LTE Band 5	10M	QPSK	1	25	Right Side	10	20525	836.5	21.42	22	1.143	0.03	0.043	0.049
	LTE Band 5	10M	QPSK	1	25	Bottom Side	10	20525	836.5	21.42	22	1.143	-0.16	0.077	0.088
	LTE Band 5	10M	QPSK	25	12	Front	10	20525	836.5	20.45	21	1.135	0.06	0.089	0.101
	LTE Band 5	10M	QPSK	25	12	Back	10	20525	836.5	20.45	21	1.135	0.04	0.206	0.234
	LTE Band 5	10M	QPSK	25	12	Left Side	10	20525	836.5	20.45	21	1.135	-0.01	0.109	0.124
	LTE Band 5	10M	QPSK	25	12	Right Side	10	20525	836.5	20.45	21	1.135	0.08	0.032	0.036
	LTE Band 5	10M	QPSK	25	12	Bottom Side	10	20525	836.5	20.45	21	1.135	0.02	0.059	0.067
20	LTE Band 4	20M	QPSK	1	0	Front	10	20175	1732.5	21.38	22	1.153	-0.14	0.388	<b>0.448</b>
	LTE Band 4	20M	QPSK	1	0	Back	10	20175	1732.5	21.38	22	1.153	0.03	0.337	0.389
	LTE Band 4	20M	QPSK	1	0	Left Side	10	20175	1732.5	21.38	22	1.153	0.09	0.081	0.093
	LTE Band 4	20M	QPSK	1	0	Right Side	10	20175	1732.5	21.38	22	1.153	0.01	0.371	0.428
	LTE Band 4	20M	QPSK	1	0	Bottom Side	10	20175	1732.5	21.38	22	1.153	0.05	0.136	0.157
	LTE Band 4	20M	QPSK	50	0	Front	10	20175	1732.5	20.37	21	1.156	0.04	0.307	0.355
	LTE Band 4	20M	QPSK	50	0	Back	10	20175	1732.5	20.37	21	1.156	0.02	0.274	0.317
	LTE Band 4	20M	QPSK	50	0	Left Side	10	20175	1732.5	20.37	21	1.156	-0.03	0.068	0.079
	LTE Band 4	20M	QPSK	50	0	Right Side	10	20175	1732.5	20.37	21	1.156	0.04	0.337	0.390
	LTE Band 4	20M	QPSK	50	0	Bottom Side	10	20175	1732.5	20.37	21	1.156	0.09	0.100	0.116



Plot No.	Band	BW (MHz)	Modulation	RB Size	RB Offset	Test Position	Gap (mm)	Ch.	Freq. (MHz)	Average Power (dBm)	Tune-Up Limit (dBm)	Tune-up Scaling Factor	Power Drift (dB)	Measured 1g SAR (W/kg)	Reported 1g SAR (W/kg)
21	LTE Band 2	20M	QPSK	1	49	Front	10	19100	1900	22.15	22.5	1.084	-0.11	0.589	0.638
	LTE Band 2	20M	QPSK	1	49	Back	10	19100	1900	22.15	22.5	1.084	0.08	0.542	0.587
	LTE Band 2	20M	QPSK	1	49	Left Side	10	19100	1900	22.15	22.5	1.084	0.04	0.133	0.144
	LTE Band 2	20M	QPSK	1	49	Right Side	10	19100	1900	22.15	22.5	1.084	0.03	0.476	0.516
	LTE Band 2	20M	QPSK	1	49	Bottom Side	10	19100	1900	22.15	22.5	1.084	0.09	0.154	0.167
	LTE Band 2	20M	QPSK	1	49	Front	10	18900	1880	22.08	22.5	1.102	0.04	0.527	0.581
	LTE Band 2	20M	QPSK	1	49	Front	10	18700	1860	22.06	22.5	1.107	0.02	0.519	0.574
	LTE Band 2	20M	QPSK	50	24	Front	10	19100	1900	20.98	21.5	1.127	-0.16	0.448	0.505
	LTE Band 2	20M	QPSK	50	24	Back	10	19100	1900	20.98	21.5	1.127	0.05	0.381	0.429
	LTE Band 2	20M	QPSK	50	24	Left Side	10	19100	1900	20.98	21.5	1.127	0.05	0.100	0.113
	LTE Band 2	20M	QPSK	50	24	Right Side	10	19100	1900	20.98	21.5	1.127	0.08	0.389	0.438
	LTE Band 2	20M	QPSK	50	24	Bottom Side	10	19100	1900	20.98	21.5	1.127	0.02	0.114	0.129

**<WLAN 2.4GHz SAR>**

Plot No.	Band	Mode	Test Position	Gap (mm)	Ch.	Freq. (MHz)	Average Power (dBm)	Tune-Up Limit (dBm)	Tune-up Scaling Factor	Duty Cycle %	Duty Cycle Scaling Factor	Power Drift (dB)	Measured 1g SAR (W/kg)	Reported 1g SAR (W/kg)
	WLAN2.4GHz	802.11b 1Mbps	Front	10	6	2437	15.30	15.50	1.047	97.59	1.025	-0.06	0.088	0.094
	WLAN2.4GHz	802.11b 1Mbps	Back	10	6	2437	15.30	15.50	1.047	97.59	1.025	0.01	<0.001	<0.001
	WLAN2.4GHz	802.11b 1Mbps	Right Side	10	6	2437	15.30	15.50	1.047	97.59	1.025	-0.01	0.045	0.048
	WLAN2.4GHz	802.11b 1Mbps	Top Side	10	6	2437	15.30	15.50	1.047	97.59	1.025	0.06	0.042	0.045
	WLAN2.4GHz	802.11b 1Mbps	Front	10	1	2412	15.30	15.50	1.047	97.59	1.025	0.02	0.090	0.097
22	WLAN2.4GHz	802.11b 1Mbps	Front	10	11	2462	15.10	15.50	1.096	97.59	1.025	-0.09	0.097	<b>0.109</b>

**<WLAN 5GHz SAR>**

Plot No.	Band	Mode	Test Position	Gap (mm)	Ch.	Freq. (MHz)	Average Power (dBm)	Tune-Up Limit (dBm)	Tune-up Scaling Factor	Duty Cycle %	Duty Cycle Scaling Factor	Power Drift (dB)	Measured 1g SAR (W/kg)	Reported 1g SAR (W/kg)
	WLAN5.2GHz	802.11a 6Mbps	Front	10	36	5180	14.40	15.00	1.148	87.5	1.143	0.06	0.135	0.177
	WLAN5.2GHz	802.11a 6Mbps	Back	10	36	5180	14.40	15.00	1.148	87.5	1.143	0.04	0.183	0.240
	WLAN5.2GHz	802.11a 6Mbps	Right Side	10	36	5180	14.40	15.00	1.148	87.5	1.143	0.07	0.252	0.331
	WLAN5.2GHz	802.11a 6Mbps	Top Side	10	36	5180	14.40	15.00	1.148	87.5	1.143	0.05	0.181	0.238
	WLAN5.2GHz	802.11a 6Mbps	Right Side	10	40	5200	14.31	15.00	1.172	87.5	1.143	0.02	0.248	0.332
	WLAN5.2GHz	802.11a 6Mbps	Right Side	10	44	5220	14.39	15.00	1.151	87.5	1.143	0.01	0.234	0.308
23	WLAN5.2GHz	802.11a 6Mbps	Right Side	10	48	5240	14.26	15.00	1.186	87.5	1.143	0.04	0.246	<b>0.333</b>
	WLAN5.8GHz	802.11a 6Mbps	Front	10	149	5745	13.90	14.50	1.148	87.5	1.143	0.06	0.186	0.244
	WLAN5.8GHz	802.11a 6Mbps	Back	10	149	5745	13.90	14.50	1.148	87.5	1.143	0.03	0.209	0.274
	WLAN5.8GHz	802.11a 6Mbps	Right Side	10	149	5745	13.90	14.50	1.148	87.5	1.143	0.04	0.350	0.459
24	WLAN5.8GHz	802.11a 6Mbps	Top Side	10	149	5745	13.90	14.50	1.148	87.5	1.143	-0.12	0.366	<b>0.480</b>
	WLAN5.8GHz	802.11a 6Mbps	Top Side	10	157	5785	13.71	14.50	1.200	87.5	1.143	0.06	0.347	0.476
	WLAN5.8GHz	802.11a 6Mbps	Top Side	10	165	5825	13.65	14.50	1.216	87.5	1.143	0.08	0.312	0.434
	WLAN5.8GHz	802.11a 6Mbps	Back	10	157	5785	13.71	14.50	1.200	87.5	1.143	0.07	0.189	0.259
	WLAN5.8GHz	802.11a 6Mbps	Back	10	165	5825	13.65	14.50	1.216	87.5	1.143	0.02	0.162	0.225

**<Bluetooth SAR>**

Plot No.	Band	Mode	Test Position	Gap (mm)	Ch.	Freq. (MHz)	Average Power (dBm)	Tune-Up Limit (dBm)	Tune-up Scaling Factor	Duty Cycle %	Duty Cycle Scaling Factor	Power Drift (dB)	Measured 1g SAR (W/kg)	Reported 1g SAR (W/kg)
	Bluetooth	DH5 1Mbps	Front	10	39	2441	7.20	8.00	1.202	76.82	1.084	0.01	0.010	0.012
	Bluetooth	DH5 1Mbps	Back	10	39	2441	7.20	8.00	1.202	76.82	1.084	0.01	<0.001	<0.001
	Bluetooth	DH5 1Mbps	Right Side	10	39	2441	7.20	8.00	1.202	76.82	1.084	0.06	0.009	0.011
	Bluetooth	DH5 1Mbps	Top Side	10	39	2441	7.20	8.00	1.202	76.82	1.084	0.01	0.006	0.008
25	Bluetooth	DH5 1Mbps	Front	10	0	2402	6.30	8.00	1.479	76.82	1.084	0.01	0.00976	<b>0.016</b>
	Bluetooth	DH5 1Mbps	Front	10	78	2480	5.60	8.00	1.738	76.82	1.084	0.06	0.007	0.013



**14.3 Body Worn Accessory SAR**

**<WCDMA SAR>**

Plot No.	Band	Mode	Test Position	Gap (mm)	Ch.	Freq. (MHz)	Average Power (dBm)	Tune-Up Limit (dBm)	Tune-up Scaling Factor	Power Drift (dB)	Measured 1g SAR (W/kg)	Reported 1g SAR (W/kg)
	WCDMA V	RMC 12.2Kbps	Front	10	4182	836.4	22.43	23	1.140	-0.04	0.145	0.165
	WCDMA V	RMC 12.2Kbps	Back	10	4182	836.4	22.43	23	1.140	0.01	0.378	0.431
26	WCDMA V	RMC 12.2Kbps	Back	10	4132	826.4	22.34	23	1.164	-0.07	0.448	<b>0.522</b>
	WCDMA V	RMC 12.2Kbps	Back	10	4233	846.6	22.36	23	1.159	0.05	0.327	0.379
	WCDMA IV	RMC 12.2Kbps	Front	10	1413	1732.6	21.89	23	1.291	-0.03	0.569	0.735
	WCDMA IV	RMC 12.2Kbps	Back	10	1413	1732.6	21.89	23	1.291	0.03	0.526	0.679
27	WCDMA IV	RMC 12.2Kbps	Front	10	1312	1712.4	21.81	23	1.315	-0.06	0.579	<b>0.762</b>
	WCDMA IV	RMC 12.2Kbps	Front	10	1513	1752.6	21.85	23	1.303	0.01	0.516	0.672
	WCDMA II	RMC 12.2Kbps	Front	10	9400	1880	22.33	23	1.167	-0.05	0.564	0.658
	WCDMA II	RMC 12.2Kbps	Back	10	9400	1880	22.33	23	1.167	0.04	0.493	0.575
	WCDMA II	RMC 12.2Kbps	Front	10	9262	1852.4	22.15	23	1.216	0.11	0.560	0.681
28	WCDMA II	RMC 12.2Kbps	Front	10	9538	1907.6	22.17	23	1.211	-0.12	0.599	<b>0.725</b>

**<LTE SAR>**

Plot No.	Band	BW (MHz)	Modulation	RB Size	RB Offset	Test Position	Gap (mm)	Ch.	Freq. (MHz)	Average Power (dBm)	Tune-Up Limit (dBm)	Tune-up Scaling Factor	Power Drift (dB)	Measured 1g SAR (W/kg)	Reported 1g SAR (W/kg)
	LTE Band 12	10M	QPSK	1	25	Front	10	23095	707.5	22.57	23	1.104	0.15	0.290	0.320
29	LTE Band 12	10M	QPSK	1	25	Back	10	23095	707.5	22.57	23	1.104	0.04	0.407	<b>0.449</b>
	LTE Band 12	10M	QPSK	25	12	Front	10	23095	707.5	21.51	22	1.119	0.04	0.230	0.257
	LTE Band 12	10M	QPSK	25	12	Back	10	23095	707.5	21.51	22	1.119	-0.02	0.316	0.354
	LTE Band 13	10M	QPSK	1	25	Front	10	23230	782	21.95	22.5	1.135	0.01	0.107	0.121
30	LTE Band 13	10M	QPSK	1	25	Back	10	23230	782	21.95	22.5	1.135	-0.09	0.186	<b>0.211</b>
	LTE Band 13	10M	QPSK	25	12	Front	10	23230	782	20.9	21.5	1.148	0.13	0.087	0.099
	LTE Band 13	10M	QPSK	25	12	Back	10	23230	782	20.9	21.5	1.148	0.02	0.150	0.172
	LTE Band 5	10M	QPSK	1	25	Front	10	20525	836.5	21.42	22	1.143	-0.11	0.110	0.126
31	LTE Band 5	10M	QPSK	1	25	Back	10	20525	836.5	21.42	22	1.143	0.03	0.322	<b>0.368</b>
	LTE Band 5	10M	QPSK	25	12	Front	10	20525	836.5	20.45	21	1.135	0.06	0.089	0.101
	LTE Band 5	10M	QPSK	25	12	Back	10	20525	836.5	20.45	21	1.135	0.04	0.206	0.234
32	LTE Band 4	20M	QPSK	1	0	Front	10	20175	1732.5	21.38	22	1.153	-0.14	0.388	<b>0.448</b>
	LTE Band 4	20M	QPSK	1	0	Back	10	20175	1732.5	21.38	22	1.153	0.03	0.337	0.389
	LTE Band 4	20M	QPSK	50	0	Front	10	20175	1732.5	20.37	21	1.156	0.04	0.307	0.355
	LTE Band 4	20M	QPSK	50	0	Back	10	20175	1732.5	20.37	21	1.156	0.02	0.274	0.317
33	LTE Band 2	20M	QPSK	1	49	Front	10	19100	1900	22.15	22.5	1.084	-0.11	0.589	<b>0.638</b>
	LTE Band 2	20M	QPSK	1	49	Back	10	19100	1900	22.15	22.5	1.084	0.08	0.542	0.587
	LTE Band 2	20M	QPSK	1	49	Front	10	18900	1880	22.08	22.5	1.102	0.04	0.527	0.581
	LTE Band 2	20M	QPSK	1	49	Front	10	18700	1860	22.06	22.5	1.107	0.02	0.519	0.574
	LTE Band 2	20M	QPSK	50	24	Front	10	19100	1900	20.98	21.5	1.127	-0.16	0.448	0.505
	LTE Band 2	20M	QPSK	50	24	Back	10	19100	1900	20.98	21.5	1.127	0.05	0.381	0.429



<WLAN 2.4GHz SAR>

Plot No.	Band	Mode	Test Position	Gap (mm)	Ch.	Freq. (MHz)	Average Power (dBm)	Tune-Up Limit (dBm)	Tune-up Scaling Factor	Duty Cycle %	Duty Cycle Scaling Factor	Power Drift (dB)	Measured 1g SAR (W/kg)	Reported 1g SAR (W/kg)
	WLAN2.4GHz	802.11b 1Mbps	Front	10	6	2437	15.30	15.50	1.047	97.59	1.025	-0.06	0.088	0.094
	WLAN2.4GHz	802.11b 1Mbps	Back	10	6	2437	15.30	15.50	1.047	97.59	1.025	0.01	<0.001	<0.001
	WLAN2.4GHz	802.11b 1Mbps	Front	10	1	2412	15.30	15.50	1.047	97.59	1.025	0.02	0.090	0.097
34	WLAN2.4GHz	802.11b 1Mbps	Front	10	11	2462	15.10	15.50	1.096	97.59	1.025	-0.09	0.097	<b>0.109</b>

<WLAN 5GHz SAR>

Plot No.	Band	Mode	Test Position	Gap (mm)	Ch.	Freq. (MHz)	Average Power (dBm)	Tune-Up Limit (dBm)	Tune-up Scaling Factor	Duty Cycle %	Duty Cycle Scaling Factor	Power Drift (dB)	Measured 1g SAR (W/kg)	Reported 1g SAR (W/kg)
	WLAN5.2GHz	802.11a 6Mbps	Front	10	36	5180	14.40	15.00	1.148	87.5	1.143	0.06	0.135	0.177
	WLAN5.2GHz	802.11a 6Mbps	Back	10	36	5180	14.40	15.00	1.148	87.5	1.143	0.04	0.183	0.240
	WLAN5.3GHz	802.11a 6Mbps	Front	10	56	5280	14.25	15.00	1.189	87.5	1.143	0.06	0.161	0.219
	WLAN5.3GHz	802.11a 6Mbps	Back	10	56	5280	14.25	15.00	1.189	87.5	1.143	0.05	0.189	0.257
	WLAN5.3GHz	802.11a 6Mbps	Back	10	52	5260	14.16	15.00	1.213	87.5	1.143	0.04	0.190	0.264
35	WLAN5.3GHz	802.11a 6Mbps	Back	10	60	5300	14.19	15.00	1.205	87.5	1.143	0.08	0.196	<b>0.270</b>
	WLAN5.3GHz	802.11a 6Mbps	Back	10	64	5320	14.15	15.00	1.216	87.5	1.143	0.09	0.191	0.266
	WLAN5.5GHz	802.11a 6Mbps	Front	10	116	5580	14.12	15.00	1.225	87.5	1.143	0.08	0.188	0.263
36	WLAN5.5GHz	802.11a 6Mbps	Back	10	116	5580	14.12	15.00	1.225	87.5	1.143	0.05	0.281	<b>0.393</b>
	WLAN5.5GHz	802.11a 6Mbps	Back	10	100	5500	13.90	15.00	1.288	87.5	1.143	0.03	0.250	0.368
	WLAN5.5GHz	802.11a 6Mbps	Back	10	124	5620	13.83	15.00	1.309	87.5	1.143	0.07	0.232	0.347
	WLAN5.5GHz	802.11a 6Mbps	Back	10	132	5660	13.91	15.00	1.285	87.5	1.143	0.15	0.239	0.351
	WLAN5.5GHz	802.11a 6Mbps	Back	10	140	5700	14.11	15.00	1.227	87.5	1.143	-0.08	0.218	0.306
	WLAN5.5GHz	802.11a 6Mbps	Back	10	144	5720	14.06	15.00	1.242	87.5	1.143	0.06	0.233	0.331
	WLAN5.8GHz	802.11a 6Mbps	Front	10	149	5745	13.90	14.50	1.148	87.5	1.143	0.06	0.186	0.244
37	WLAN5.8GHz	802.11a 6Mbps	Back	10	149	5745	13.90	14.50	1.148	87.5	1.143	0.03	0.209	<b>0.274</b>
	WLAN5.8GHz	802.11a 6Mbps	Back	10	157	5785	13.71	14.50	1.200	87.5	1.143	0.07	0.189	0.259
	WLAN5.8GHz	802.11a 6Mbps	Back	10	165	5825	13.65	14.50	1.216	87.5	1.143	0.02	0.162	0.225

<Bluetooth SAR>

Plot No.	Band	Mode	Test Position	Gap (mm)	Ch.	Freq. (MHz)	Average Power (dBm)	Tune-Up Limit (dBm)	Tune-up Scaling Factor	Duty Cycle %	Duty Cycle Scaling Factor	Power Drift (dB)	Measured 1g SAR (W/kg)	Reported 1g SAR (W/kg)
	Bluetooth	DH5 1Mbps	Front	10	39	2441	7.20	8.00	1.202	76.82	1.084	0.01	0.010	0.012
	Bluetooth	DH5 1Mbps	Back	10	39	2441	7.20	8.00	1.202	76.82	1.084	0.01	<0.001	<0.001
38	Bluetooth	DH5 1Mbps	Front	10	0	2402	6.30	8.00	1.479	76.82	1.084	0.01	0.00976	<b>0.016</b>
	Bluetooth	DH5 1Mbps	Front	10	78	2480	5.60	8.00	1.738	76.82	1.084	0.06	0.007	0.013



**14.4 Product specific 10g SAR**

**<WLAN 5GHz SAR>**

Plot No.	Band	Mode	Test Position	Gap (mm)	Ch.	Freq. (MHz)	Average Power (dBm)	Tune-Up Limit (dBm)	Tune-up Scaling Factor	Duty Cycle %	Duty Cycle Scaling Factor	Power Drift (dB)	Measured 10g SAR (W/kg)	Reported 10g SAR (W/kg)
	WLAN5.3GHz	802.11a 6Mbps	Front	0	56	5280	14.25	15.00	1.189	87.5	1.143	0.05	0.267	0.363
	WLAN5.3GHz	802.11a 6Mbps	Back	0	56	5280	14.25	15.00	1.189	87.5	1.143	0.08	0.370	0.503
	WLAN5.3GHz	802.11a 6Mbps	Right Side	0	56	5280	14.25	15.00	1.189	87.5	1.143	0.03	0.567	0.770
	WLAN5.3GHz	802.11a 6Mbps	Top Side	0	56	5280	14.25	15.00	1.189	87.5	1.143	0.07	0.509	0.691
	WLAN5.3GHz	802.11a 6Mbps	Right Side	0	52	5260	14.16	15.00	1.213	87.5	1.143	0.04	0.529	0.734
39	WLAN5.3GHz	802.11a 6Mbps	Right Side	0	60	5300	14.19	15.00	1.205	87.5	1.143	-0.07	0.679	<b>0.935</b>
	WLAN5.3GHz	802.11a 6Mbps	Right Side	0	64	5320	14.15	15.00	1.216	87.5	1.143	0.02	0.653	0.908
	WLAN5.5GHz	802.11a 6Mbps	Front	0	116	5580	14.12	15.00	1.225	87.5	1.143	0.06	0.361	0.505
	WLAN5.5GHz	802.11a 6Mbps	Back	0	116	5580	14.12	15.00	1.225	87.5	1.143	0.05	0.484	0.677
40	WLAN5.5GHz	802.11a 6Mbps	Right Side	0	116	5580	14.12	15.00	1.225	87.5	1.143	0.11	0.603	<b>0.844</b>
	WLAN5.5GHz	802.11a 6Mbps	Top Side	0	116	5580	14.12	15.00	1.225	87.5	1.143	0.03	0.600	0.840
	WLAN5.5GHz	802.11a 6Mbps	Right Side	0	100	5500	13.90	15.00	1.288	87.5	1.143	0.05	0.564	0.830
	WLAN5.5GHz	802.11a 6Mbps	Right Side	0	124	5620	13.83	15.00	1.309	87.5	1.143	-0.11	0.531	0.795
	WLAN5.5GHz	802.11a 6Mbps	Right Side	0	132	5660	13.91	15.00	1.285	87.5	1.143	0.05	0.527	0.774
	WLAN5.5GHz	802.11a 6Mbps	Right Side	0	140	5700	14.11	15.00	1.227	87.5	1.143	0.03	0.509	0.714
	WLAN5.5GHz	802.11a 6Mbps	Right Side	0	144	5720	14.06	15.00	1.242	87.5	1.143	0.07	0.524	0.744

### 15. Simultaneous Transmission Analysis

No.	Simultaneous Transmission Configurations	Portable Handset			
		Head	Body-worn	Hotspot	Product specific 10g SAR
1.	WCDMA + WLAN2.4GHz	Yes	Yes	Yes	Yes
2.	LTE + WLAN2.4GHz	Yes	Yes	Yes	Yes
3.	WCDMA + WLAN5.3/5.5GHz	Yes	Yes		Yes
4.	LTE + WLAN5.3/5.5GHz	Yes	Yes		Yes
5.	WCDMA + WLAN5.2/5.8GHz	Yes	Yes	Yes	Yes
6.	LTE + WLAN5.2/5.8GHz	Yes	Yes	Yes	Yes
7.	WCDMA + Bluetooth	Yes	Yes	Yes	Yes
8.	LTE + Bluetooth	Yes	Yes	Yes	Yes

**General Note:**

1. This device supports VoIP in WCDMA and LTE (e.g. for 3rd-party VoIP), LTE supports VoLTE operation..
2. EUT will choose each WCDMA and LTE according to the network signal condition; therefore, they will not operate simultaneously at any moment.
3. This device 2.4GHz WLAN support hotspot operation and Bluetooth support tethering applications.
4. This device 2.4GHz WLAN/ 5.2GHz WLAN/5.8GHz WLAN support hotspot operation, and 5.2GHz WLAN/5.8GHz WLAN supports WLAN Direct (GC/GO), and 5.3GHz / 5.5GHz supports WLAN Direct (GC only).
5. EUT will choose either WLAN 2.4GHz or WLAN 5GHz according to the network signal condition; therefore, 2.4GHz WLAN and 5GHz WLAN will not operate simultaneously at any moment though they have independent antenna.
6. WLAN and Bluetooth share the same antenna so can't transmit simultaneously.
7. Chose the worst zoom scan SAR of WLAN correspondingly for co-located with WWAN analysis.
8. All licensed modes share the same antenna part and cannot transmit simultaneously.
9. The reported SAR summation is calculated based on the same configuration and test position.
10. Per KDB 447498 D01v06, simultaneous transmission SAR is compliant if,
  - i) 1g Scalar SAR summation < 1.6W/kg.
  - ii)  $SPLSR = (SAR1 + SAR2)^{1.5} / (\min. \text{ separation distance, mm})$ , and the peak separation distance is determined from the square root of  $[(x1-x2)^2 + (y1-y2)^2 + (z1-z2)^2]$ , where (x1, y1, z1) and (x2, y2, z2) are the coordinates of the extrapolated peak SAR locations in the zoom scan.
  - iii) If  $SPLSR \leq 0.04$ , simultaneously transmission SAR measurement is not necessary.
  - iv) Simultaneously transmission SAR measurement, and the reported multi-band SAR < 1.6W/kg.



15.1 Head Exposure Conditions

WWAN Band		Exposure Position	1	2	3	4	1+2 Summed 1g SAR (W/kg)	1+3 Summed 1g SAR (W/kg)	1+4 Summed 1g SAR (W/kg)
			WWAN 1g SAR (W/kg)	2.4GHz WLAN 1g SAR (W/kg)	5GHz WLAN 1g SAR (W/kg)	Bluetooth 1g SAR (W/kg)			
WCDMA	WCDMA II	Right Cheek	0.668	0.142	0.453	0.027	0.81	1.12	0.70
		Right Tilted	0.189	0.090	0.508	0.007	0.28	0.70	0.20
		Left Cheek	0.256	0.206	0.877	0.062	0.46	1.13	0.32
		Left Tilted	0.179	0.163	0.684	0.034	0.34	0.86	0.21
	WCDMA IV	Right Cheek	0.412	0.142	0.453	0.027	0.55	0.87	0.44
		Right Tilted	0.092	0.090	0.508	0.007	0.18	0.60	0.10
		Left Cheek	0.163	0.206	0.877	0.062	0.37	1.04	0.23
		Left Tilted	0.108	0.163	0.684	0.034	0.27	0.79	0.14
	WCDMA V	Right Cheek	0.172	0.142	0.453	0.027	0.31	0.63	0.20
		Right Tilted	0.075	0.090	0.508	0.007	0.17	0.58	0.08
		Left Cheek	0.340	0.206	0.877	0.062	0.55	1.22	0.40
		Left Tilted	0.082	0.163	0.684	0.034	0.25	0.77	0.12
LTE	LTE Band 12	Right Cheek	0.297	0.142	0.453	0.027	0.44	0.75	0.32
		Right Tilted	0.173	0.090	0.508	0.007	0.26	0.68	0.18
		Left Cheek	0.356	0.206	0.877	0.062	0.56	1.23	0.42
		Left Tilted	0.173	0.163	0.684	0.034	0.34	0.86	0.21
	LTE Band 13	Right Cheek	0.159	0.142	0.453	0.027	0.30	0.61	0.19
		Right Tilted	0.080	0.090	0.508	0.007	0.17	0.59	0.09
		Left Cheek	0.193	0.206	0.877	0.062	0.40	1.07	0.26
		Left Tilted	0.081	0.163	0.684	0.034	0.24	0.77	0.12
	LTE Band 5	Right Cheek	0.120	0.142	0.453	0.027	0.26	0.57	0.15
		Right Tilted	0.056	0.090	0.508	0.007	0.15	0.56	0.06
		Left Cheek	0.186	0.206	0.877	0.062	0.39	1.06	0.25
		Left Tilted	0.064	0.163	0.684	0.034	0.23	0.75	0.10
	LTE Band 4	Right Cheek	0.292	0.142	0.453	0.027	0.43	0.75	0.32
		Right Tilted	0.069	0.090	0.508	0.007	0.16	0.58	0.08
		Left Cheek	0.104	0.206	0.877	0.062	0.31	0.98	0.17
		Left Tilted	0.088	0.163	0.684	0.034	0.25	0.77	0.12
	LTE Band 2	Right Cheek	0.567	0.142	0.453	0.027	0.71	1.02	0.59
		Right Tilted	0.181	0.090	0.508	0.007	0.27	0.69	0.19
		Left Cheek	0.309	0.206	0.877	0.062	0.52	1.19	0.37
		Left Tilted	0.171	0.163	0.684	0.034	0.33	0.86	0.21



15.2 Hotspot Exposure Conditions

WWAN Band		Exposure Position	1	2	3	4	1+2 Summed 1g SAR (W/kg)	1+3 Summed 1g SAR (W/kg)	1+4 Summed 1g SAR (W/kg)
			WWAN 1g SAR (W/kg)	2.4GHz WLAN 1g SAR (W/kg)	5GHz WLAN 1g SAR (W/kg)	Bluetooth 1g SAR (W/kg)			
WCDMA	WCDMA II	Front	0.725	0.109	0.244	0.016	0.83	0.97	0.74
		Back	0.575	<0.001	0.274	<0.001	0.58	0.85	0.58
		Left side	0.144				0.14	0.14	0.14
		Right side	0.632	0.048	0.459	0.011	0.68	1.09	0.64
		Top side		0.045	0.480	0.008	0.05	0.48	0.01
		Bottom side	0.155				0.16	0.16	0.16
	WCDMA IV	Front	0.762	0.109	0.244	0.016	<b>0.87</b>	1.01	<b>0.78</b>
		Back	0.679	<0.001	0.274	<0.001	0.68	0.95	0.68
		Left side	0.133				0.13	0.13	0.13
		Right side	0.571	0.048	0.459	0.011	0.62	1.03	0.58
		Top side		0.045	0.480	0.008	0.05	0.48	0.01
		Bottom side	0.167				0.17	0.17	0.17
	WCDMA V	Front	0.165	0.109	0.244	0.016	0.27	0.41	0.18
		Back	0.522	<0.001	0.274	<0.001	0.52	0.80	0.52
		Left side	0.223				0.22	0.22	0.22
		Right side	0.066	0.048	0.459	0.011	0.11	0.53	0.08
		Top side		0.045	0.480	0.008	0.05	0.48	0.01
		Bottom side	0.103				0.10	0.10	0.10
LTE	LTE Band 12	Front	0.320	0.109	0.244	0.016	0.43	0.56	0.34
		Back	0.449	<0.001	0.274	<0.001	0.45	0.72	0.45
		Left side	0.347				0.35	0.35	0.35
		Right side	0.251	0.048	0.459	0.011	0.30	0.71	0.26
		Top side		0.045	0.480	0.008	0.05	0.48	0.01
		Bottom side	0.059				0.06	0.06	0.06
	LTE Band 13	Front	0.121	0.109	0.244	0.016	0.23	0.37	0.14
		Back	0.211	<0.001	0.274	<0.001	0.21	0.49	0.21
		Left side	0.038				0.04	0.04	0.04
		Right side	0.023	0.048	0.459	0.011	0.07	0.48	0.03
		Top side		0.045	0.480	0.008	0.05	0.48	0.01
		Bottom side	0.044				0.04	0.04	0.04
	LTE Band 5	Front	0.126	0.109	0.244	0.016	0.24	0.37	0.14
		Back	0.368	<0.001	0.274	<0.001	0.37	0.64	0.37
		Left side	0.163				0.16	0.16	0.16
		Right side	0.049	0.048	0.459	0.011	0.10	0.51	0.06
		Top side		0.045	0.480	0.008	0.05	0.48	0.01
		Bottom side	0.088				0.09	0.09	0.09
	LTE Band 4	Front	0.448	0.109	0.244	0.016	0.56	0.69	0.46
		Back	0.389	<0.001	0.274	<0.001	0.39	0.66	0.39
		Left side	0.093				0.09	0.09	0.09
		Right side	0.428	0.048	0.459	0.011	0.48	0.89	0.44
		Top side		0.045	0.480	0.008	0.05	0.48	0.01
		Bottom side	0.157				0.16	0.16	0.16
LTE Band 2	Front	0.638	0.109	0.244	0.016	0.75	0.88	0.65	
	Back	0.587	<0.001	0.274	<0.001	0.59	0.86	0.59	
	Left side	0.144				0.14	0.14	0.14	
	Right side	0.516	0.048	0.459	0.011	0.56	0.98	0.53	
	Top side		0.045	0.480	0.008	0.05	0.48	0.01	
	Bottom side	0.167				0.17	0.17	0.17	



**15.3 Body-Worn Accessory Exposure Conditions**

WWAN Band		Exposure Position	1	2	3	4	1+2 Summed 1g SAR (W/kg)	1+3 Summed 1g SAR (W/kg)	1+4 Summed 1g SAR (W/kg)
			WWAN 1g SAR (W/kg)	2.4GHz WLAN 1g SAR (W/kg)	5GHz WLAN 1g SAR (W/kg)	Bluetooth 1g SAR (W/kg)			
WCDMA	WCDMA II	Front	0.725	0.109	0.263	0.016	0.83	0.99	0.74
		Back	0.575	<0.001	0.393	<0.001	0.58	0.97	0.58
	WCDMA IV	Front	0.762	0.109	0.263	0.016	0.87	1.03	0.78
		Back	0.679	<0.001	0.393	<0.001	0.68	1.07	0.68
	WCDMA V	Front	0.165	0.109	0.263	0.016	0.27	0.43	0.18
		Back	0.522	<0.001	0.393	<0.001	0.52	0.92	0.52
LTE	LTE Band 12	Front	0.320	0.109	0.263	0.016	0.43	0.58	0.34
		Back	0.449	<0.001	0.393	<0.001	0.45	0.84	0.45
	LTE Band 13	Front	0.121	0.109	0.263	0.016	0.23	0.38	0.14
		Back	0.211	<0.001	0.393	<0.001	0.21	0.60	0.21
	LTE Band 5	Front	0.126	0.109	0.263	0.016	0.24	0.39	0.14
		Back	0.368	<0.001	0.393	<0.001	0.37	0.76	0.37
	LTE Band 4	Front	0.448	0.109	0.263	0.016	0.56	0.71	0.46
		Back	0.389	<0.001	0.393	<0.001	0.39	0.78	0.39
	LTE Band 2	Front	0.638	0.109	0.263	0.016	0.75	0.90	0.65
		Back	0.587	<0.001	0.393	<0.001	0.59	0.98	0.59

Test Engineer : Changlin Huang, Bin He, Mengming Dai



## **16. Uncertainty Assessment**

Per KDB 865664 D01 SAR measurement 100MHz to 6GHz, when the highest measured 1-g SAR within a frequency band is < 1.5 W/kg and the measured 10-g SAR within a frequency band is < 3.75 W/kg. The expanded SAR measurement uncertainty must be  $\leq 30\%$ , for a confidence interval of  $k = 2$ . If these conditions are met, extensive SAR measurement uncertainty analysis described in IEEE Std 1528-2013 is not required in SAR reports submitted for equipment approval. For this device, the highest measured 1-g SAR is less 1.5W/kg and highest measured 10-g SAR is less 3.75W/kg. Therefore, the measurement uncertainty table is not required in this report.



## **17. References**

- [1] FCC 47 CFR Part 2 "Frequency Allocations and Radio Treaty Matters; General Rules and Regulations"
- [2] ANSI/IEEE Std. C95.1-1992, "IEEE Standard for Safety Levels with Respect to Human Exposure to Radio Frequency Electromagnetic Fields, 3 kHz to 300 GHz", September 1992
- [3] IEEE Std. 1528-2013, "IEEE Recommended Practice for Determining the Peak Spatial-Average Specific Absorption Rate (SAR) in the Human Head from Wireless Communications Devices: Measurement Techniques", Sep 2013
- [4] SPEAG DASY System Handbook
- [5] FCC KDB 865664 D01 v01r04, "SAR Measurement Requirements for 100 MHz to 6 GHz", Aug 2015.
- [6] FCC KDB 865664 D02 v01r02, "RF Exposure Compliance Reporting and Documentation Considerations" Oct 2015.
- [7] FCC KDB 248227 D01 v02r02, "SAR Guidance for IEEE 802.11 (WiFi) Transmitters", Oct 2015.
- [8] FCC KDB 447498 D01 v06, "Mobile and Portable Device RF Exposure Procedures and Equipment Authorization Policies", Oct 2015
- [9] FCC KDB 648474 D04 v01r03, "SAR Evaluation Considerations for Wireless Handsets", Oct 2015.
- [10] FCC KDB 941225 D01 v03r01, "3G SAR MEAUREMENT PROCEDURES", Oct 2015
- [11] FCC KDB 941225 D05 v02r05, "SAR Evaluation Considerations for LTE Devices", Dec 2015
- [12] FCC KDB 941225 D06 v02r01, "SAR Evaluation Procedures for Portable Devices with Wireless Router Capabilities", Oct 2015.

-----THE END-----



**Appendix A. Plots of System Performance Check**

The plots are shown as follows.

## System Check\_Head\_750MHz

**DUT: D750V3-SN:1099**

Communication System: UID 0, CW (0); Frequency: 750 MHz; Duty Cycle: 1:1

Medium: HSL\_750\_190617 Medium parameters used:  $f = 750$  MHz;  $\sigma = 0.883$  S/m;  $\epsilon_r = 40.81$ ;  $\rho = 1000$  kg/m<sup>3</sup>

Ambient Temperature : 23.4 °C; Liquid Temperature : 22.4 °C

DASY5 Configuration:

- Probe: ES3DV3 - SN3191; ConvF(6.59, 6.59, 6.59); Calibrated: 2019.01.29;
- Sensor-Surface: 3mm (Mechanical Surface Detection)
- Electronics: DAE4 Sn1437; Calibrated: 2018.10.15
- Phantom: SAM2; Type: QD000P40CD; Serial: TP:1671
- Measurement SW: DASY52, Version 52.8 (8); SEMCAD X Version 14.6.10 (7331)

**Pin=250mW/Area Scan (61x61x1):** Interpolated grid: dx=15mm, dy=15mm

Maximum value of SAR (interpolated) = 1.12 W/kg

**Pin=250mW/Zoom Scan (5x5x7)/Cube 0:** Measurement grid: dx=8mm, dy=8mm, dz=5mm

Reference Value = 33.65 V/m; Power Drift = 0.02 dB

Peak SAR (extrapolated) = 2.22 W/kg

**SAR(1 g) = 1.98 W/kg; SAR(10 g) = 1.37 W/kg**

Maximum value of SAR (measured) = 1.15 W/kg

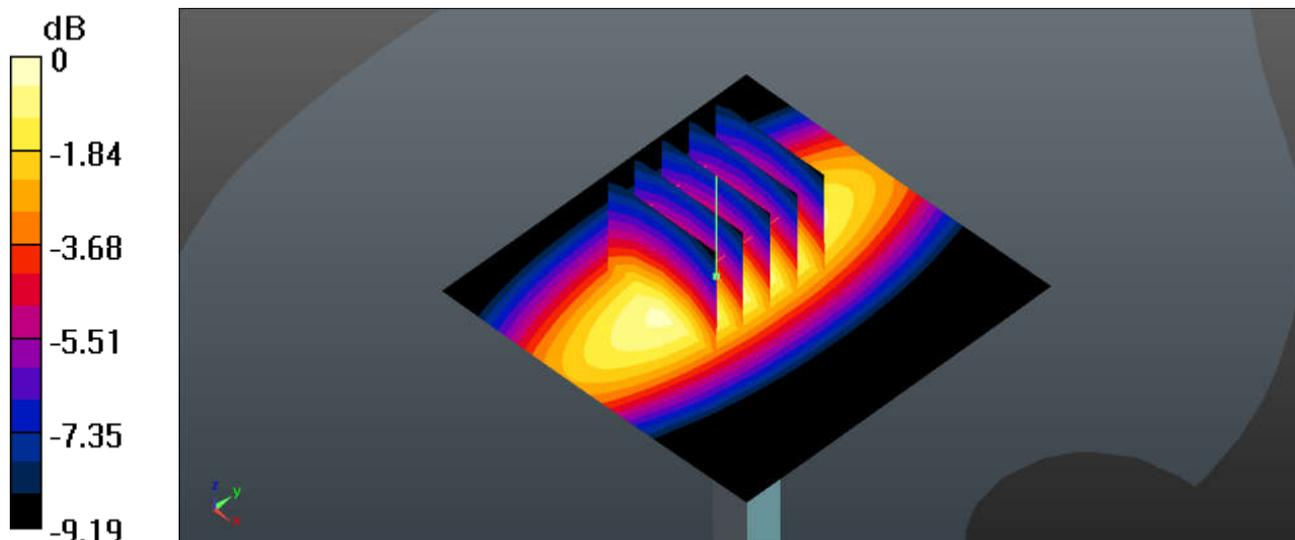

0 dB = 1.15 W/kg

### System Check\_Head\_835MHz

**DUT: D835V2-SN:4d162**

Communication System: UID 0, CW; Frequency: 835 MHz; Duty Cycle: 1:1

Medium: HSL\_835\_190616 Medium parameters used:  $f = 835$  MHz;  $\sigma = 0.914$  S/m;  $\epsilon_r = 41.826$ ;  $\rho = 1000$  kg/m<sup>3</sup>

Ambient Temperature : 23.4 °C; Liquid Temperature : 22.6 °C

DASY5 Configuration:

- Probe: ES3DV3 - SN3191; ConvF(6.38, 6.38, 6.38); Calibrated: 2019.01.29;
- Sensor-Surface: 3mm (Mechanical Surface Detection)
- Electronics: DAE4 Sn1437; Calibrated: 2018.10.15
- Phantom: SAM2; Type: QD000P40CD; Serial: TP:1671
- Measurement SW: DASY52, Version 52.8 (8); SEMCAD X Version 14.6.10 (7331)

**Pin=250mW/Area Scan (61x61x1):** Interpolated grid: dx=15mm, dy=15mm

Maximum value of SAR (interpolated) = 1.40 W/kg

**Pin=250mW/Zoom Scan (5x5x7)/Cube 0:** Measurement grid: dx=8mm, dy=8mm, dz=5mm

Reference Value = 41.04 V/m; Power Drift = -0.01 dB

Peak SAR (extrapolated) = 2.51 W/kg

**SAR(1 g) = 2.24 W/kg; SAR(10 g) = 1.69 W/kg**

Maximum value of SAR (measured) = 1.39 W/kg

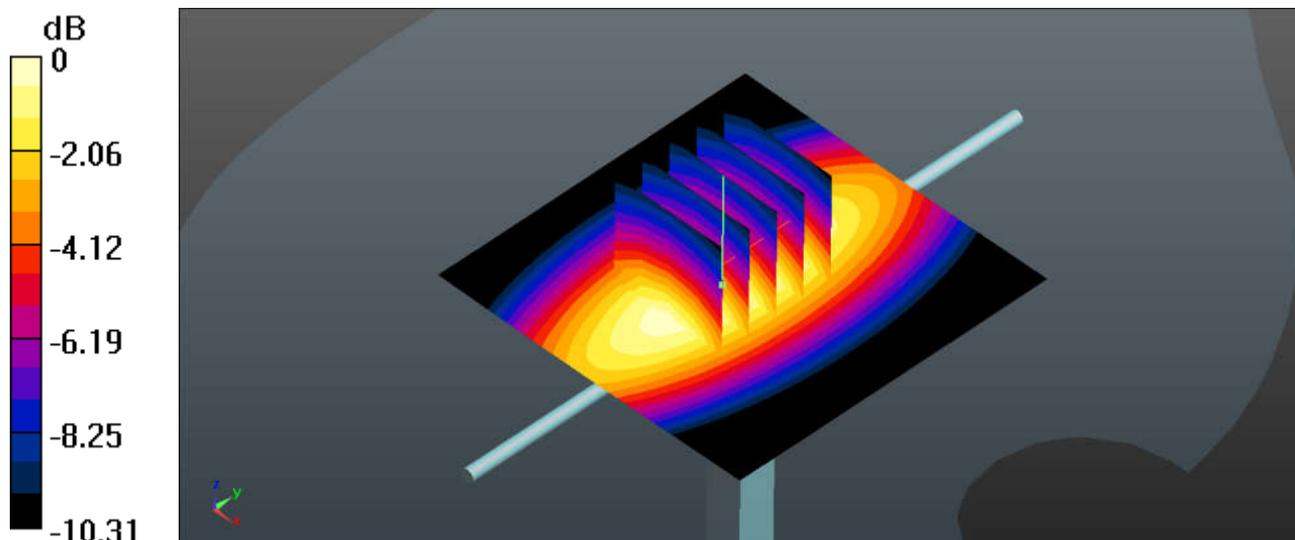

0 dB = 1.39 W/kg

### System Check\_Head\_1750MHz

**DUT: D1750V2-SN:1137**

Communication System: UID 0, CW; Frequency: 1750 MHz; Duty Cycle: 1:1

Medium: HSL\_1750\_190615 Medium parameters used:  $f = 1750$  MHz;  $\sigma = 1.404$  S/m;  $\epsilon_r = 40.106$ ;  $\rho = 1000$  kg/m<sup>3</sup>

Ambient Temperature : 23.4 °C; Liquid Temperature : 22.7 °C

DASY5 Configuration:

- Probe: ES3DV3 - SN3191; ConvF(5.51, 5.51, 5.51); Calibrated: 2019.01.29;
- Sensor-Surface: 3mm (Mechanical Surface Detection)
- Electronics: DAE4 Sn1437; Calibrated: 2018.10.15
- Phantom: SAM2; Type: QD000P40CD; Serial: TP:1671
- Measurement SW: DASY52, Version 52.8 (8); SEMCAD X Version 14.6.10 (7331)

**Pin=250mW/Area Scan (61x61x1):** Interpolated grid: dx=15mm, dy=15mm

Maximum value of SAR (interpolated) = 13.1 W/kg

**Pin=250mW/Zoom Scan (5x5x7)/Cube 0:** Measurement grid: dx=8mm, dy=8mm, dz=5mm

Reference Value = 96.58 V/m; Power Drift = -0.02 dB

Peak SAR (extrapolated) = 16.1 W/kg

**SAR(1 g) = 9.07 W/kg; SAR(10 g) = 4.89 W/kg**

Maximum value of SAR (measured) = 12.5 W/kg

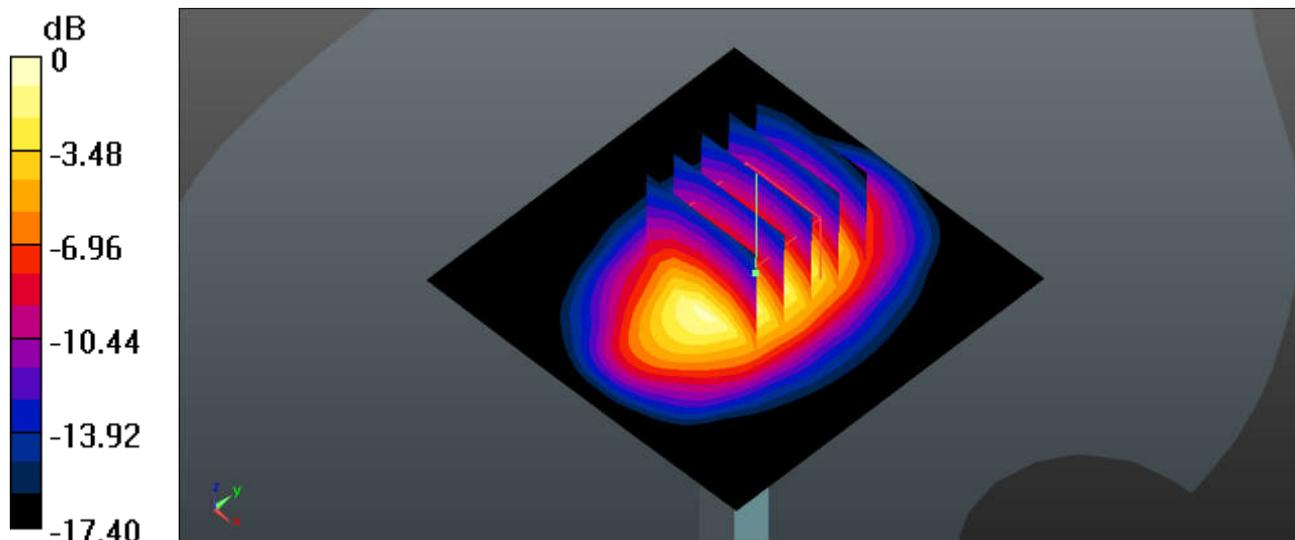

0 dB = 13.1 W/kg

### System Check\_Head\_1900MHz

**DUT: D1900V2-SN:5d182**

Communication System: UID 0, CW; Frequency: 1900 MHz; Duty Cycle: 1:1

Medium: HSL\_1900\_190615 Medium parameters used:  $f = 1900$  MHz;  $\sigma = 1.443$  S/m;  $\epsilon_r = 40.03$ ;  $\rho = 1000$  kg/m<sup>3</sup>

Ambient Temperature : 23.5 °C; Liquid Temperature : 22.9 °C

DASY5 Configuration:

- Probe: ES3DV3 - SN3191; ConvF(5.28, 5.28, 5.28); Calibrated: 2019.01.29;
- Sensor-Surface: 3mm (Mechanical Surface Detection)
- Electronics: DAE4 Sn1437; Calibrated: 2018.10.15
- Phantom: SAM2; Type: QD000P40CD; Serial: TP:1671
- Measurement SW: DASY52, Version 52.8 (8); SEMCAD X Version 14.6.10 (7331)

**Pin=250mW/Area Scan (61x61x1):** Interpolated grid: dx=15mm, dy=15mm

Maximum value of SAR (interpolated) = 13.6 W/kg

**Pin=250mW/Zoom Scan (5x5x7)/Cube 0:** Measurement grid: dx=8mm, dy=8mm, dz=5mm

Reference Value = 96.70 V/m; Power Drift = 0.05 dB

Peak SAR (extrapolated) = 17.3 W/kg

**SAR(1 g) = 9.49 W/kg; SAR(10 g) = 4.92 W/kg**

Maximum value of SAR (measured) = 13.3 W/kg

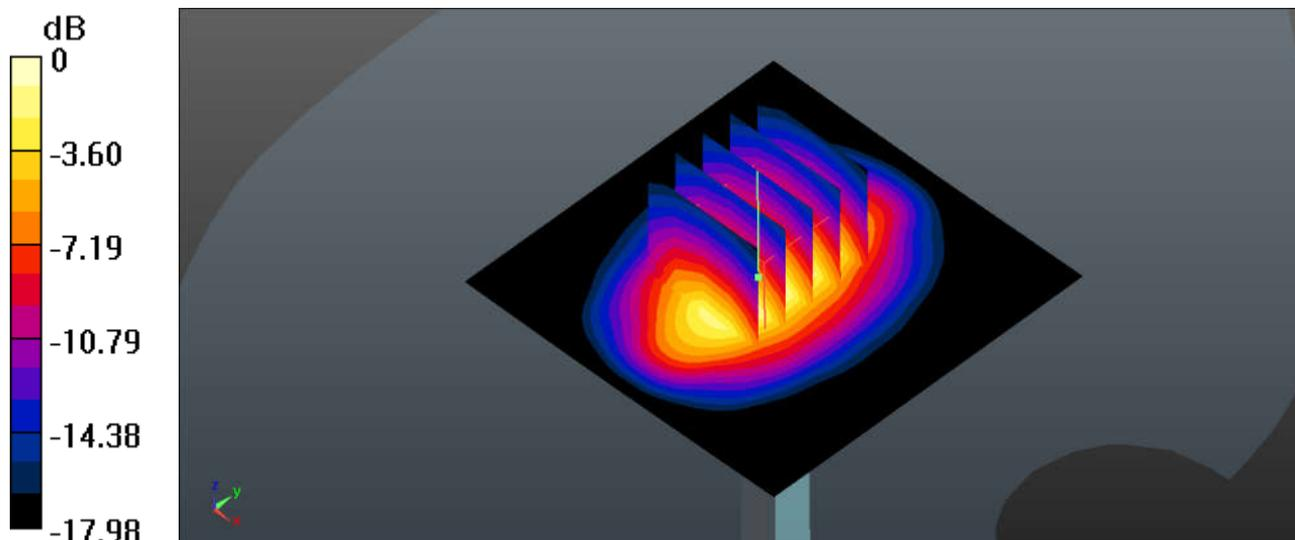

0 dB = 13.6 W/kg

## System Check\_Head\_2450MHz

**DUT: D2450V2-SN:736**

Communication System: UID 0, CW; Frequency: 2450 MHz; Duty Cycle: 1:1  
Medium: HSL\_2450\_190628 Medium parameters used:  $f = 2450$  MHz;  $\sigma = 1.824$  S/m;  $\epsilon_r = 38.032$ ;  
 $\rho = 1000$  kg/m<sup>3</sup>  
Ambient Temperature : 23.6 °C; Liquid Temperature : 22.5 °C

DASY5 Configuration:

- Probe: EX3DV4 - SN3819; ConvF(7.21, 7.21, 7.21); Calibrated: 2019.03.01;
- Sensor-Surface: 2mm (Mechanical Surface Detection)
- Electronics: DAE4 Sn715; Calibrated: 2019.01.23
- Phantom: SAM (Front) with CRP v5.0; Type: QD000P40CD; Serial: TP:1795
- Measurement SW: DASY52, Version 52.8 (8); SEMCAD X Version 14.6.10 (7331)

**Pin=250mW/Area Scan (81x81x1):** Interpolated grid: dx=12mm, dy=12mm  
Maximum value of SAR (interpolated) = 20.1 W/kg

**Pin=250mW/Zoom Scan (7x7x7)/Cube 0:** Measurement grid: dx=5mm, dy=5mm, dz=5mm  
Reference Value = 90.53 V/m; Power Drift = -0.03 dB  
Peak SAR (extrapolated) = 26.7 W/kg  
**SAR(1 g) = 13.2 W/kg; SAR(10 g) = 6.2 W/kg**  
Maximum value of SAR (measured) = 20.0 W/kg

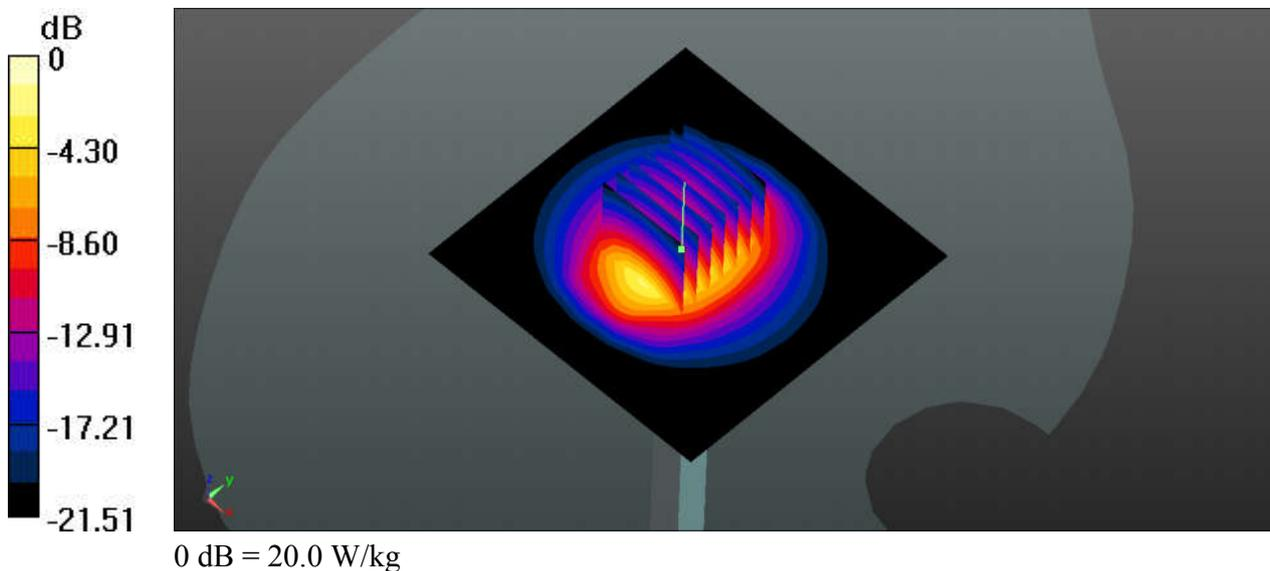

## System Check\_Head\_5250MHz

**DUT: D5GHzV2-SN:1167**

Communication System: UID 0, CW (0); Frequency: 5250 MHz; Duty Cycle: 1:1  
Medium: HSL\_5250\_190628 Medium parameters used:  $f = 5250$  MHz;  $\sigma = 4.714$  S/m;  $\epsilon_r = 36.412$ ;  
 $\rho = 1000$  kg/m<sup>3</sup>  
Ambient Temperature : 23.7 °C ; Liquid Temperature : 22.4 °C

DASY5 Configuration:

- Probe: EX3DV4 - SN3819; ConvF(5.07, 5.07, 5.07); Calibrated: 2019.03.01;
- Sensor-Surface: 1.4mm (Mechanical Surface Detection)
- Electronics: DAE4 Sn715; Calibrated: 2019.01.23
- Phantom: SAM (Front) with CRP v5.0; Type: QD000P40CD; Serial: TP:1795
- Measurement SW: DASY52, Version 52.8 (8); SEMCAD X Version 14.6.10 (7331)

**Pin=100mW/Area Scan (71x71x1):** Interpolated grid: dx=10mm, dy=10mm  
Maximum value of SAR (interpolated) = 15.8 W/kg

**Pin=100mW/Zoom Scan (7x7x7)/Cube 0:** Measurement grid: dx=4mm, dy=4mm, dz=1.4mm  
Reference Value = 49.65 V/m; Power Drift = -0.06 dB  
Peak SAR (extrapolated) = 27.4 W/kg  
**SAR(1 g) = 7.12 W/kg; SAR(10 g) = 2.05 W/kg**  
Maximum value of SAR (measured) = 17.0 W/kg

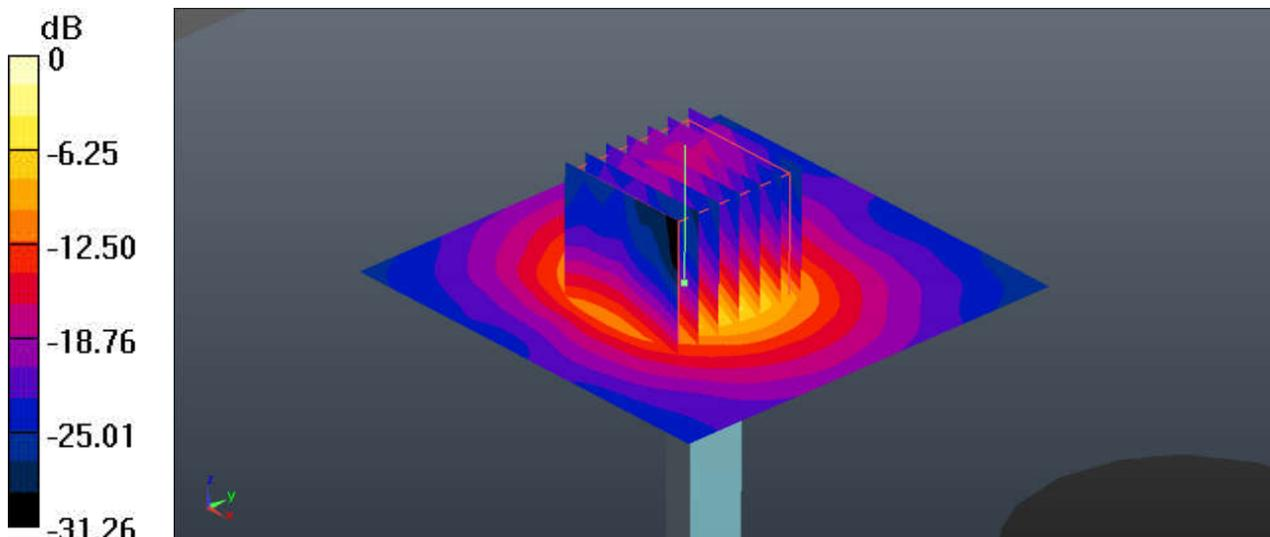

0 dB = 17.0 W/kg

## System Check\_Head\_5600MHz

**DUT: D5GHzV2-SN:1167**

Communication System: UID 0, CW (0); Frequency: 5600 MHz; Duty Cycle: 1:1  
Medium: HSL\_5600\_190627 Medium parameters used:  $f = 5600$  MHz;  $\sigma = 5.034$  S/m;  $\epsilon_r = 36.508$ ;  
 $\rho = 1000$  kg/m<sup>3</sup>  
Ambient Temperature : 23.5 °C; Liquid Temperature : 22.6 °C

DASY5 Configuration:

- Probe: EX3DV4 - SN3819; ConvF(4.7, 4.7, 4.7); Calibrated: 2019.03.01;
- Sensor-Surface: 1.4mm (Mechanical Surface Detection)
- Electronics: DAE4 Sn715; Calibrated: 2019.01.23
- Phantom: SAM (Front) with CRP v5.0; Type: QD000P40CD; Serial: TP:1795
- Measurement SW: DASY52, Version 52.8 (8); SEMCAD X Version 14.6.10 (7331)

**Pin=100mW/Area Scan (71x71x1):** Interpolated grid: dx=10mm, dy=10mm  
Maximum value of SAR (interpolated) = 18.9 W/kg

**Pin=100mW/Zoom Scan (7x7x7)/Cube 0:** Measurement grid: dx=4mm, dy=4mm, dz=1.4mm  
Reference Value = 51.70 V/m; Power Drift = -0.17 dB  
Peak SAR (extrapolated) = 34.3 W/kg  
**SAR(1 g) = 7.88 W/kg; SAR(10 g) = 2.26 W/kg**  
Maximum value of SAR (measured) = 19.5 W/kg

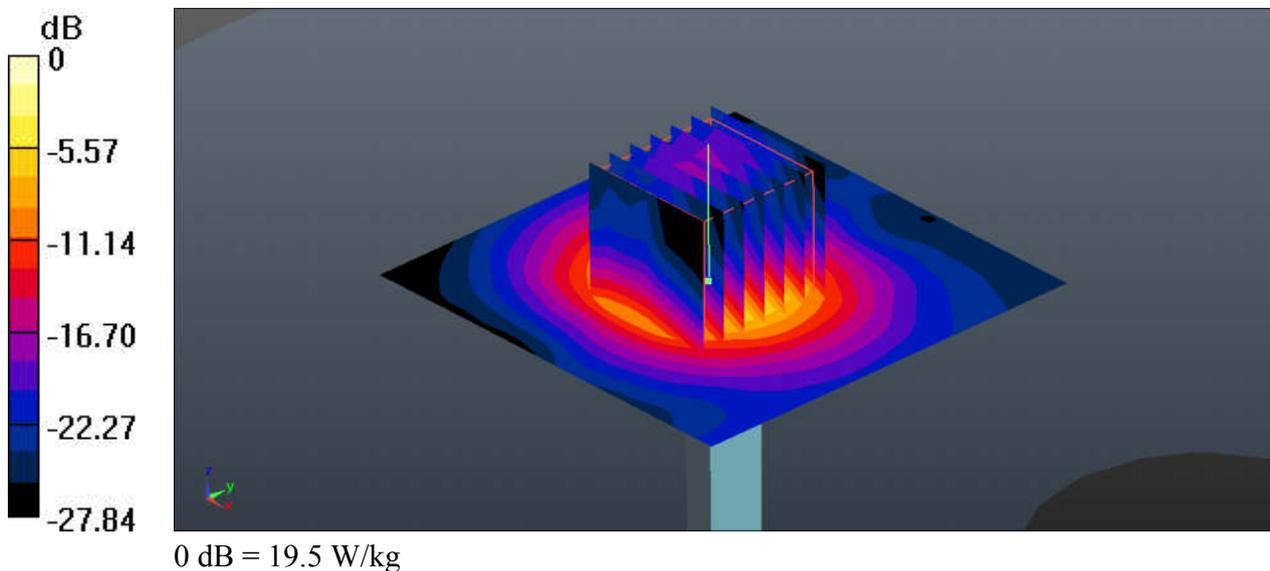

## System Check\_Head\_5750MHz

**DUT: D5GHzV2-SN:1167**

Communication System: UID 0, CW (0); Frequency: 5750 MHz; Duty Cycle: 1:1  
Medium: HSL\_5750\_190626 Medium parameters used:  $f = 5750$  MHz;  $\sigma = 5.315$  S/m;  $\epsilon_r = 35.552$ ;  
 $\rho = 1000$  kg/m<sup>3</sup>  
Ambient Temperature : 23.4 °C; Liquid Temperature : 22.5 °C

DASY5 Configuration:

- Probe: EX3DV4 - SN3819; ConvF(4.77, 4.77, 4.77); Calibrated: 2019.03.01;
- Sensor-Surface: 1.4mm (Mechanical Surface Detection)
- Electronics: DAE4 Sn715; Calibrated: 2019.01.23
- Phantom: SAM (Front) with CRP v5.0; Type: QD000P40CD; Serial: TP:1795
- Measurement SW: DASY52, Version 52.8 (8); SEMCAD X Version 14.6.10 (7331)

**Pin=100mW/Area Scan (71x71x1):** Interpolated grid: dx=10mm, dy=10mm  
Maximum value of SAR (interpolated) = 16.8 W/kg

**Pin=100mW/Zoom Scan (7x7x7)/Cube 0:** Measurement grid: dx=4mm, dy=4mm, dz=1.4mm  
Reference Value = 47.81 V/m; Power Drift = -0.18 dB  
Peak SAR (extrapolated) = 32.0 W/kg  
**SAR(1 g) = 7.16 W/kg; SAR(10 g) = 2.07 W/kg**  
Maximum value of SAR (measured) = 17.2 W/kg

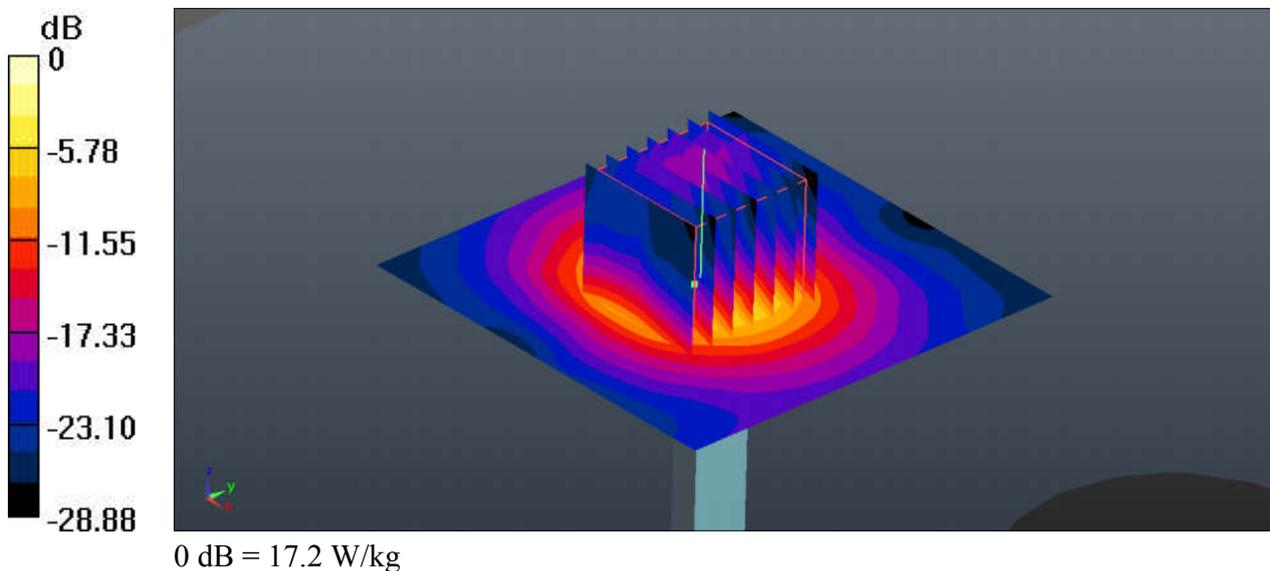



## **Appendix B. Plots of High SAR Measurement**

The plots are shown as follows.

## 01\_WCDMA V\_RMC 12.2Kbps\_Left Cheek\_Ch4132

Communication System: UID 0, UMTS (0); Frequency: 826.4 MHz; Duty Cycle: 1:1

Medium: HSL\_835\_190616 Medium parameters used:  $f = 826.4$  MHz;  $\sigma = 0.907$  S/m;  $\epsilon_r = 41.908$ ;  $\rho = 1000$  kg/m<sup>3</sup>

Ambient Temperature : 23.4 °C; Liquid Temperature : 22.6 °C

DASY5 Configuration:

- Probe: ES3DV3 - SN3191; ConvF(6.38, 6.38, 6.38); Calibrated: 2019.01.29;
- Sensor-Surface: 3mm (Mechanical Surface Detection)
- Electronics: DAE4 Sn1437; Calibrated: 2018.10.15
- Phantom: SAM2; Type: QD000P40CD; Serial: TP:1671
- Measurement SW: DASY52, Version 52.8 (8); SEMCAD X Version 14.6.10 (7331)

**Ch4132/Area Scan (71x131x1):** Interpolated grid: dx=15mm, dy=15mm

Maximum value of SAR (interpolated) = 0.363 W/kg

**Ch4132/Zoom Scan (5x5x7)/Cube 0:** Measurement grid: dx=8mm, dy=8mm, dz=5mm

Reference Value = 5.299 V/m; Power Drift = 0.09 dB

Peak SAR (extrapolated) = 0.394 W/kg

**SAR(1 g) = 0.292 W/kg; SAR(10 g) = 0.212 W/kg**

Maximum value of SAR (measured) = 0.332 W/kg

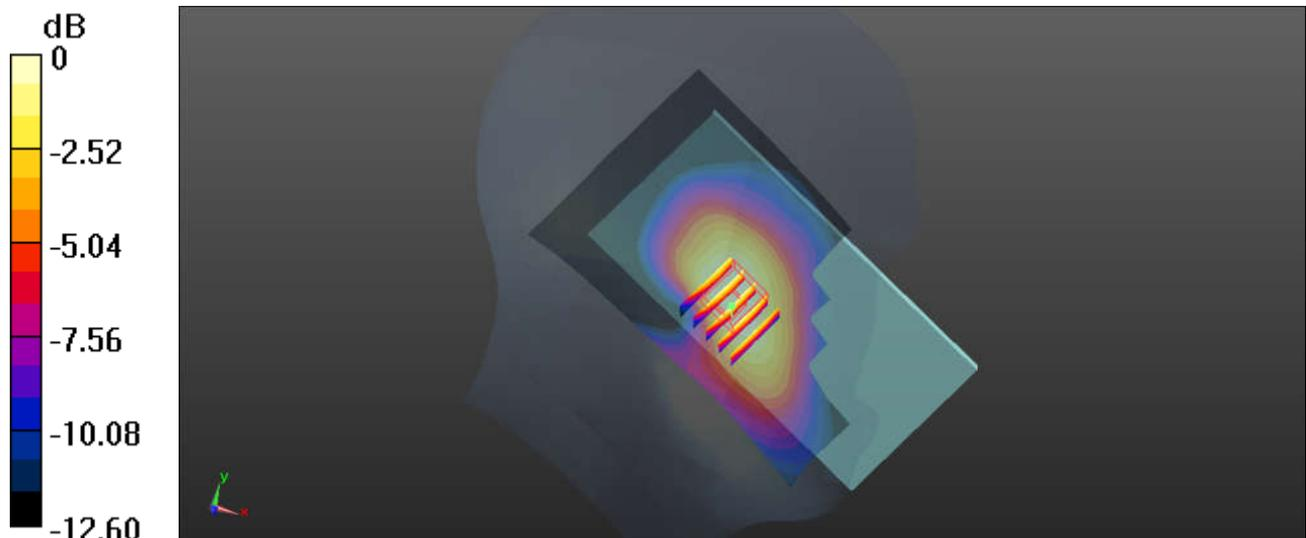

0 dB = 0.332 W/kg

## 02\_WCDMA IV\_RMC 12.2Kbps\_Right Cheek\_Ch1413

Communication System: UID 0, UMTS (0); Frequency: 1732.6 MHz; Duty Cycle: 1:1  
 Medium: HSL\_1750\_190615 Medium parameters used:  $f = 1733$  MHz;  $\sigma = 1.386$  S/m;  $\epsilon_r = 40.176$ ;  $\rho = 1000$  kg/m<sup>3</sup>  
 Ambient Temperature : 23.4 °C; Liquid Temperature : 22.7 °C

### DASY5 Configuration:

- Probe: ES3DV3 - SN3191; ConvF(5.51, 5.51, 5.51); Calibrated: 2019.01.29;
- Sensor-Surface: 3mm (Mechanical Surface Detection)
- Electronics: DAE4 Sn1437; Calibrated: 2018.10.15
- Phantom: SAM2; Type: QD000P40CD; Serial: TP:1671
- Measurement SW: DASY52, Version 52.8 (8); SEMCAD X Version 14.6.10 (7331)

**Ch1413/Area Scan (71x131x1):** Interpolated grid: dx=15mm, dy=15mm  
 Maximum value of SAR (interpolated) = 0.399 W/kg

**Ch1413/Zoom Scan (5x5x7)/Cube 0:** Measurement grid: dx=8mm, dy=8mm, dz=5mm  
 Reference Value = 12.15 V/m; Power Drift = 0.03 dB  
 Peak SAR (extrapolated) = 0.460 W/kg  
**SAR(1 g) = 0.319 W/kg; SAR(10 g) = 0.209 W/kg**  
 Maximum value of SAR (measured) = 0.363 W/kg

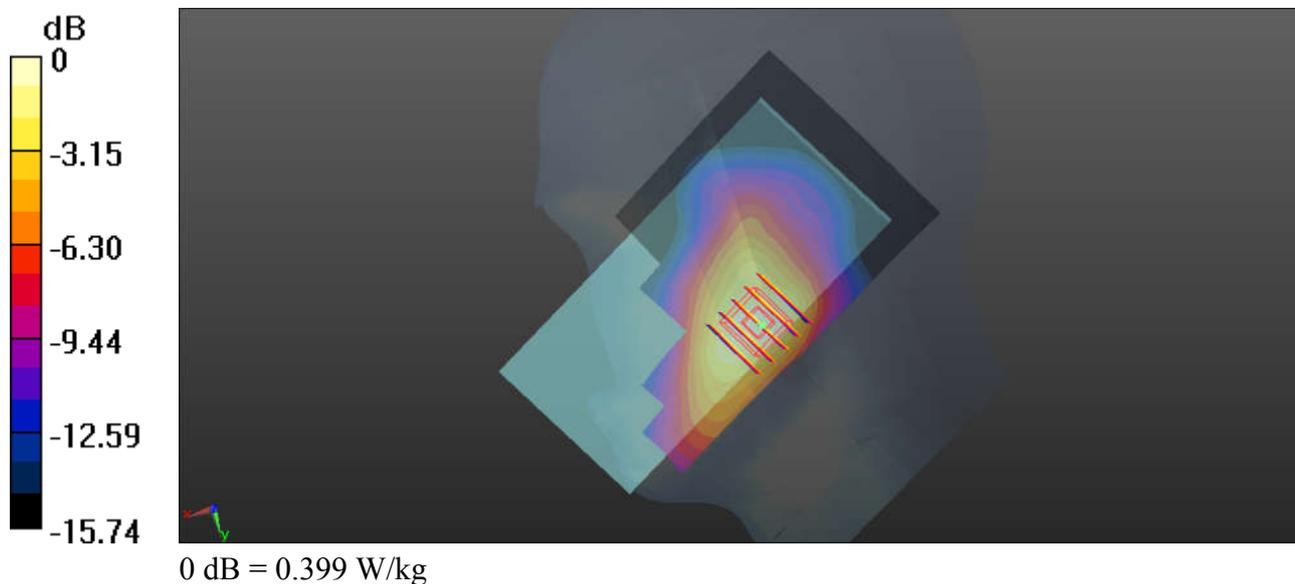

### 03\_WCDMA II\_RMC 12.2Kbps\_Right Cheek\_Ch9538

Communication System: UID 0, UMTS (0); Frequency: 1907.6 MHz; Duty Cycle: 1:1  
Medium: HSL\_1900\_190615 Medium parameters used:  $f = 1908$  MHz;  $\sigma = 1.451$  S/m;  $\epsilon_r = 39.996$ ;  $\rho = 1000$  kg/m<sup>3</sup>  
Ambient Temperature : 23.5 °C; Liquid Temperature : 22.9 °C

#### DASY5 Configuration:

- Probe: ES3DV3 - SN3191; ConvF(5.28, 5.28, 5.28); Calibrated: 2019.01.29;
- Sensor-Surface: 3mm (Mechanical Surface Detection)
- Electronics: DAE4 Sn1437; Calibrated: 2018.10.15
- Phantom: SAM2; Type: QD000P40CD; Serial: TP:1671
- Measurement SW: DASY52, Version 52.8 (8); SEMCAD X Version 14.6.10 (7331)

**Ch9538/Area Scan (71x131x1):** Interpolated grid: dx=15mm, dy=15mm  
Maximum value of SAR (interpolated) = 0.700 W/kg

**Ch9538/Zoom Scan (5x5x7)/Cube 0:** Measurement grid: dx=8mm, dy=8mm, dz=5mm  
Reference Value = 6.083 V/m; Power Drift = -0.17 dB  
Peak SAR (extrapolated) = 0.845 W/kg  
**SAR(1 g) = 0.552 W/kg; SAR(10 g) = 0.341 W/kg**  
Maximum value of SAR (measured) = 0.635 W/kg

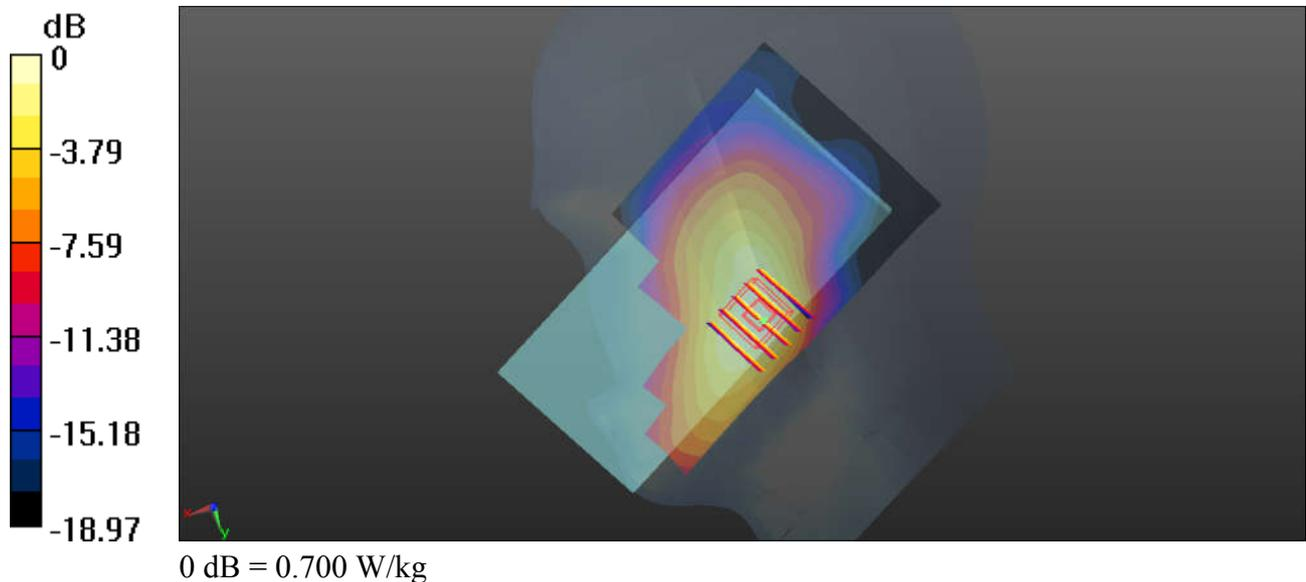

**04\_LTE Band 12\_10M\_QPSK\_1RB\_25Offset\_Left Cheek\_Ch23095**

Communication System: UID 0, LTE (0); Frequency: 707.5 MHz; Duty Cycle: 1:1

Medium: HSL\_750\_190617 Medium parameters used:  $f = 707.5$  MHz;  $\sigma = 0.86$  S/m;  $\epsilon_r = 41.73$ ;  $\rho = 1000$  kg/m<sup>3</sup>

Ambient Temperature : 23.4 °C; Liquid Temperature : 22.4 °C

**DASY5 Configuration:**

- Probe: ES3DV3 - SN3191; ConvF(6.59, 6.59, 6.59); Calibrated: 2019.01.29;
- Sensor-Surface: 3mm (Mechanical Surface Detection)
- Electronics: DAE4 Sn1437; Calibrated: 2018.10.15
- Phantom: SAM2; Type: QD000P40CD; Serial: TP:1671
- Measurement SW: DASY52, Version 52.8 (8); SEMCAD X Version 14.6.10 (7331)

**Ch23095/Area Scan (71x131x1):** Interpolated grid: dx=15mm, dy=15mm

Maximum value of SAR (interpolated) = 0.352 W/kg

**Ch23095/Zoom Scan (5x5x7)/Cube 0:** Measurement grid: dx=8mm, dy=8mm, dz=5mm

Reference Value = 1.920 V/m; Power Drift = 0.05 dB

Peak SAR (extrapolated) = 0.390 W/kg

**SAR(1 g) = 0.322 W/kg; SAR(10 g) = 0.249 W/kg**

Maximum value of SAR (measured) = 0.344 W/kg

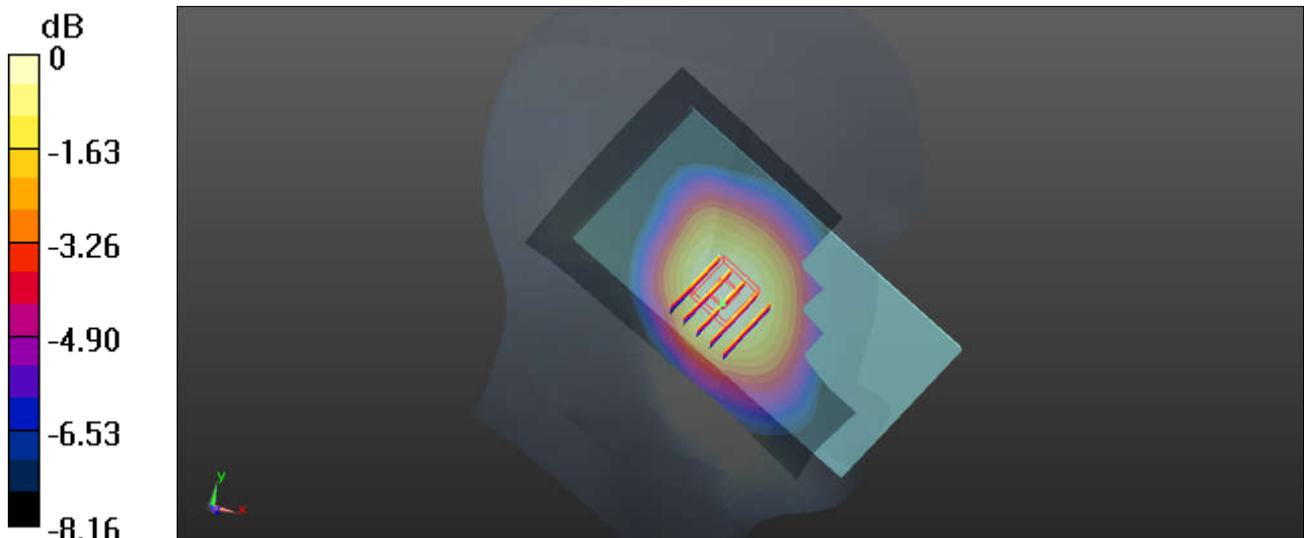

0 dB = 0.344 W/kg

**05\_LTE Band 13\_10M\_QPSK\_1RB\_25Offset\_Left Cheek\_Ch23230**

Communication System: UID 0, LTE (0); Frequency: 782 MHz; Duty Cycle: 1:1  
 Medium: HSL\_750\_190617 Medium parameters used:  $f = 782 \text{ MHz}$ ;  $\sigma = 0.902 \text{ S/m}$ ;  $\epsilon_r = 40.073$ ;  $\rho = 1000 \text{ kg/m}^3$   
 Ambient Temperature : 23.4 °C; Liquid Temperature : 22.4 °C

**DASY5 Configuration:**

- Probe: ES3DV3 - SN3191; ConvF(6.59, 6.59, 6.59); Calibrated: 2019.01.29;
- Sensor-Surface: 3mm (Mechanical Surface Detection)
- Electronics: DAE4 Sn1437; Calibrated: 2018.10.15
- Phantom: SAM2; Type: QD000P40CD; Serial: TP:1671
- Measurement SW: DASY52, Version 52.8 (8); SEMCAD X Version 14.6.10 (7331)

**Ch23230/Area Scan (71x131x1):** Interpolated grid:  $dx=15\text{mm}$ ,  $dy=15\text{mm}$   
 Maximum value of SAR (interpolated) = 0.193 W/kg

**Ch23230/Zoom Scan (5x5x7)/Cube 0:** Measurement grid:  $dx=8\text{mm}$ ,  $dy=8\text{mm}$ ,  $dz=5\text{mm}$   
 Reference Value = 5.366 V/m; Power Drift = 0.08 dB  
 Peak SAR (extrapolated) = 0.218 W/kg  
**SAR(1 g) = 0.170 W/kg; SAR(10 g) = 0.126 W/kg**  
 Maximum value of SAR (measured) = 0.183 W/kg

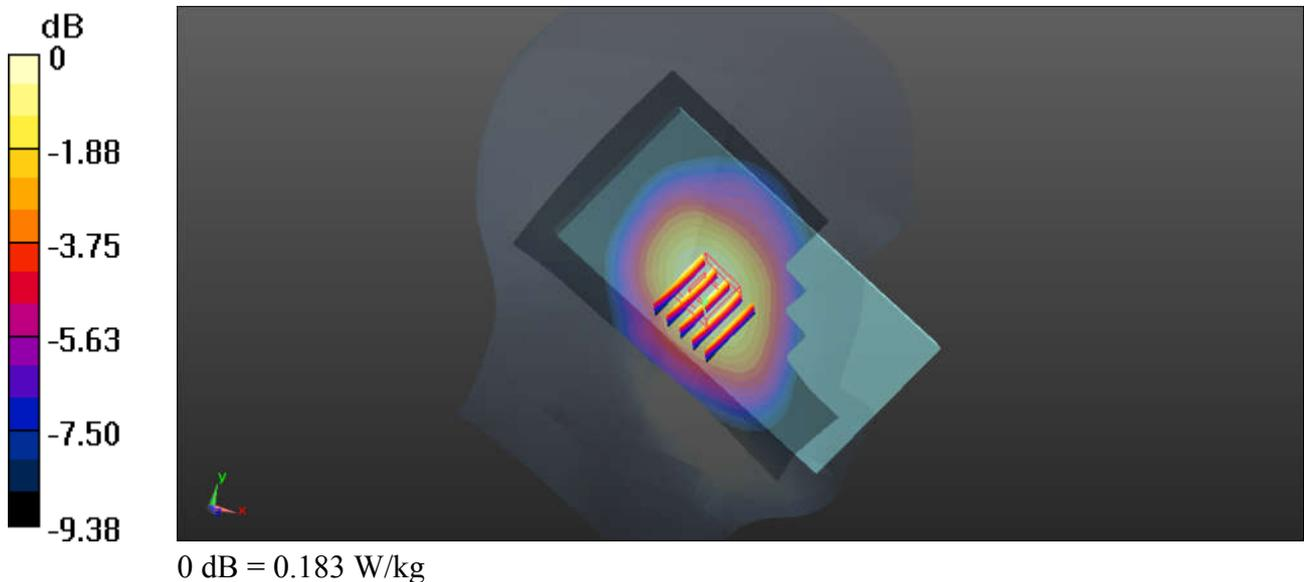

### 06\_LTE Band 5\_10M\_QPSK\_1RB\_25Offset\_Left Cheek\_Ch20525

Communication System: UID 0, LTE (0); Frequency: 836.5 MHz; Duty Cycle: 1:1  
Medium: HSL\_835\_190616 Medium parameters used:  $f = 836.5$  MHz;  $\sigma = 0.915$  S/m;  $\epsilon_r = 41.816$ ;  $\rho = 1000$  kg/m<sup>3</sup>  
Ambient Temperature : 23.4 °C; Liquid Temperature : 22.6 °C

#### DASY5 Configuration:

- Probe: ES3DV3 - SN3191; ConvF(6.38, 6.38, 6.38); Calibrated: 2019.01.29;
- Sensor-Surface: 3mm (Mechanical Surface Detection)
- Electronics: DAE4 Sn1437; Calibrated: 2018.10.15
- Phantom: SAM2; Type: QD000P40CD; Serial: TP:1671
- Measurement SW: DASY52, Version 52.8 (8); SEMCAD X Version 14.6.10 (7331)

**Ch20525/Area Scan (71x131x1):** Interpolated grid: dx=15mm, dy=15mm  
Maximum value of SAR (interpolated) = 0.197 W/kg

**Ch20525/Zoom Scan (5x5x7)/Cube 0:** Measurement grid: dx=8mm, dy=8mm, dz=5mm  
Reference Value = 4.046 V/m; Power Drift = 0.02 dB  
Peak SAR (extrapolated) = 0.220 W/kg  
**SAR(1 g) = 0.163 W/kg; SAR(10 g) = 0.117 W/kg**  
Maximum value of SAR (measured) = 0.183 W/kg

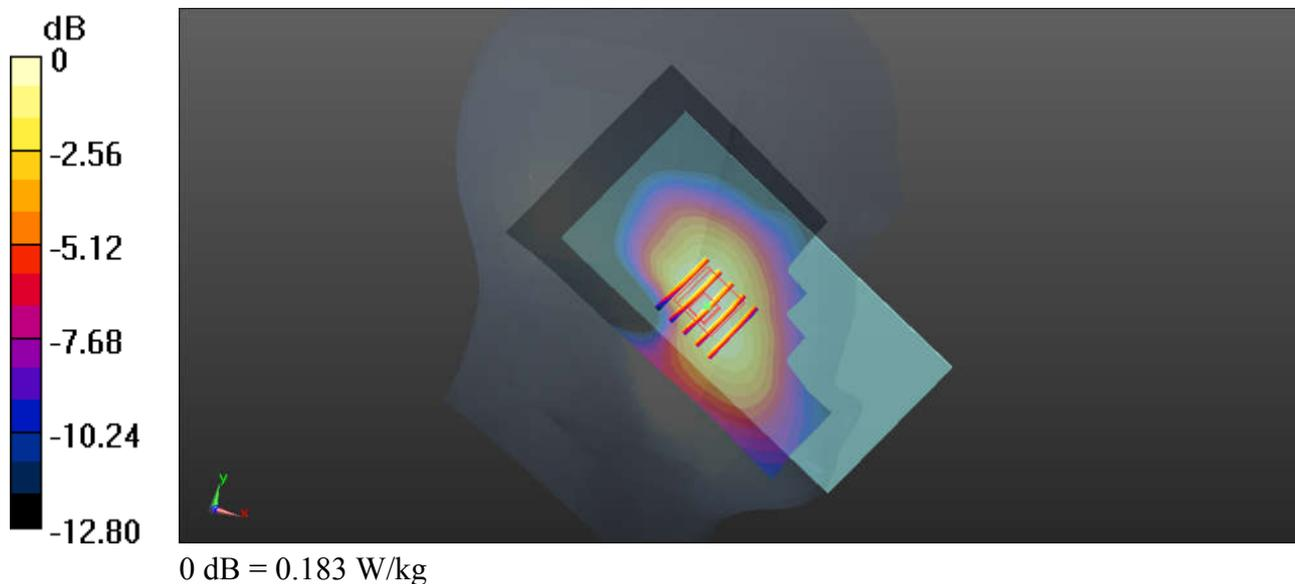

### 07\_LTE Band 4\_20M\_QPSK\_1RB\_0Offset\_Right Cheek\_Ch20175

Communication System: UID 0, LTE (0); Frequency: 1732.5 MHz; Duty Cycle: 1:1  
Medium: HSL\_1750\_190615 Medium parameters used:  $f = 1732.5$  MHz;  $\sigma = 1.386$  S/m;  $\epsilon_r = 40.178$ ;  
 $\rho = 1000$  kg/m<sup>3</sup>  
Ambient Temperature : 23.4 °C; Liquid Temperature : 22.7 °C

#### DASY5 Configuration:

- Probe: ES3DV3 - SN3191; ConvF(5.51, 5.51, 5.51); Calibrated: 2019.01.29;
- Sensor-Surface: 3mm (Mechanical Surface Detection)
- Electronics: DAE4 Sn1437; Calibrated: 2018.10.15
- Phantom: SAM2; Type: QD000P40CD; Serial: TP:1671
- Measurement SW: DASY52, Version 52.8 (8); SEMCAD X Version 14.6.10 (7331)

**Ch20175/Area Scan (71x131x1):** Interpolated grid: dx=15mm, dy=15mm  
Maximum value of SAR (interpolated) = 0.310 W/kg

**Ch20175/Zoom Scan (5x5x7)/Cube 0:** Measurement grid: dx=8mm, dy=8mm, dz=5mm  
Reference Value = 4.284 V/m; Power Drift = 0.17 dB  
Peak SAR (extrapolated) = 0.363 W/kg  
**SAR(1 g) = 0.253 W/kg; SAR(10 g) = 0.165 W/kg**  
Maximum value of SAR (measured) = 0.286 W/kg

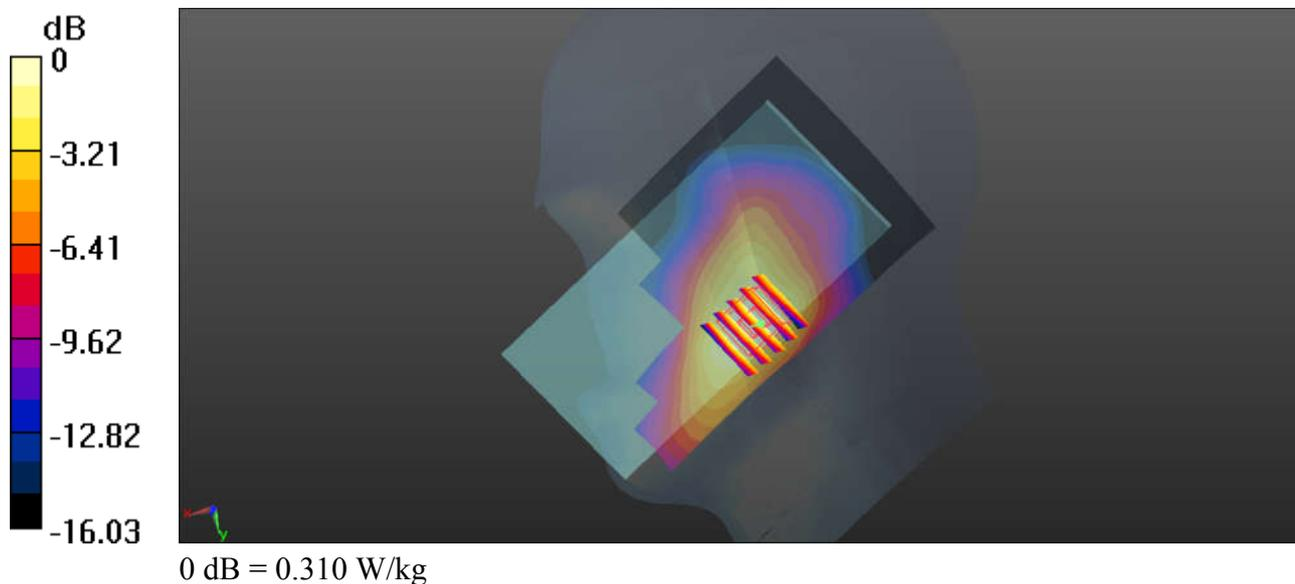

### 08\_LTE Band 2\_20M\_QPSK\_1RB\_49Offset\_Right Cheek\_Ch19100

Communication System: UID 0, LTE (0); Frequency: 1900 MHz; Duty Cycle: 1:1

Medium: HSL\_1900\_190615 Medium parameters used:  $f = 1900$  MHz;  $\sigma = 1.443$  S/m;  $\epsilon_r = 40.03$ ;  $\rho = 1000$  kg/m<sup>3</sup>

Ambient Temperature : 23.5 °C; Liquid Temperature : 22.9 °C

DASY5 Configuration:

- Probe: ES3DV3 - SN3191; ConvF(5.28, 5.28, 5.28); Calibrated: 2019.01.29;
- Sensor-Surface: 3mm (Mechanical Surface Detection)
- Electronics: DAE4 Sn1437; Calibrated: 2018.10.15
- Phantom: SAM2; Type: QD000P40CD; Serial: TP:1671
- Measurement SW: DASY52, Version 52.8 (8); SEMCAD X Version 14.6.10 (7331)

**Ch19100/Area Scan (71x131x1):** Interpolated grid: dx=15mm, dy=15mm

Maximum value of SAR (interpolated) = 0.650 W/kg

**Ch19100/Zoom Scan (5x5x7)/Cube 0:** Measurement grid: dx=8mm, dy=8mm, dz=5mm

Reference Value = 5.148 V/m; Power Drift = -0.11 dB

Peak SAR (extrapolated) = 0.803 W/kg

**SAR(1 g) = 0.523 W/kg; SAR(10 g) = 0.321 W/kg**

Maximum value of SAR (measured) = 0.601 W/kg

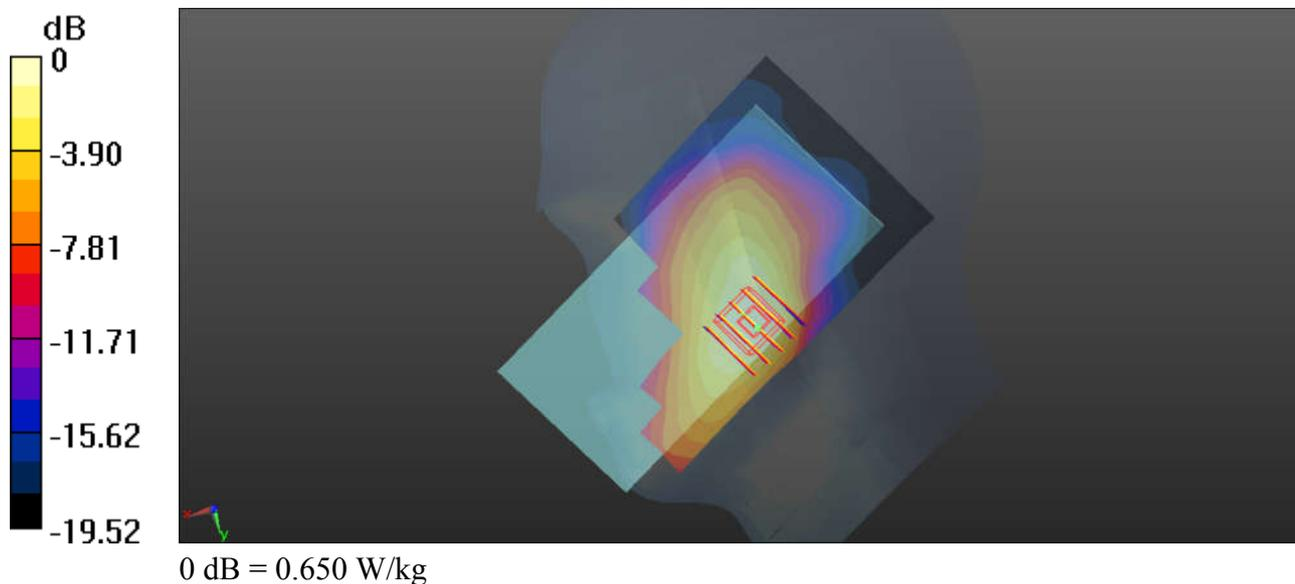

### 09\_WLAN2.4GHz\_802.11b 1Mbps\_Left Cheek\_Ch1

Communication System: UID 0, WIFI (0); Frequency: 2412 MHz; Duty Cycle: 1:1.025  
Medium: HSL\_2450\_190628 Medium parameters used:  $f = 2412$  MHz;  $\sigma = 1.788$  S/m;  $\epsilon_r = 38.181$ ;  
 $\rho = 1000$  kg/m<sup>3</sup>  
Ambient Temperature : 23.6 °C; Liquid Temperature : 22.5 °C

#### DASY5 Configuration:

- Probe: EX3DV4 - SN3819; ConvF(7.21, 7.21, 7.21); Calibrated: 2019.03.01;
- Sensor-Surface: 2mm (Mechanical Surface Detection)
- Electronics: DAE4 Sn715; Calibrated: 2019.01.23
- Phantom: SAM (Front) with CRP v5.0; Type: QD000P40CD; Serial: TP:1795
- Measurement SW: DASY52, Version 52.8 (8); SEMCAD X Version 14.6.10 (7331)

**Ch1/Area Scan (91x161x1):** Interpolated grid: dx=12mm, dy=12mm  
Maximum value of SAR (interpolated) = 0.283 W/kg

**Ch1/Zoom Scan (7x7x7)/Cube 0:** Measurement grid: dx=5mm, dy=5mm, dz=5mm  
Reference Value = 5.503 V/m; Power Drift = 0.09 dB  
Peak SAR (extrapolated) = 0.345 W/kg  
**SAR(1 g) = 0.192 W/kg; SAR(10 g) = 0.103 W/kg**  
Maximum value of SAR (measured) = 0.262 W/kg

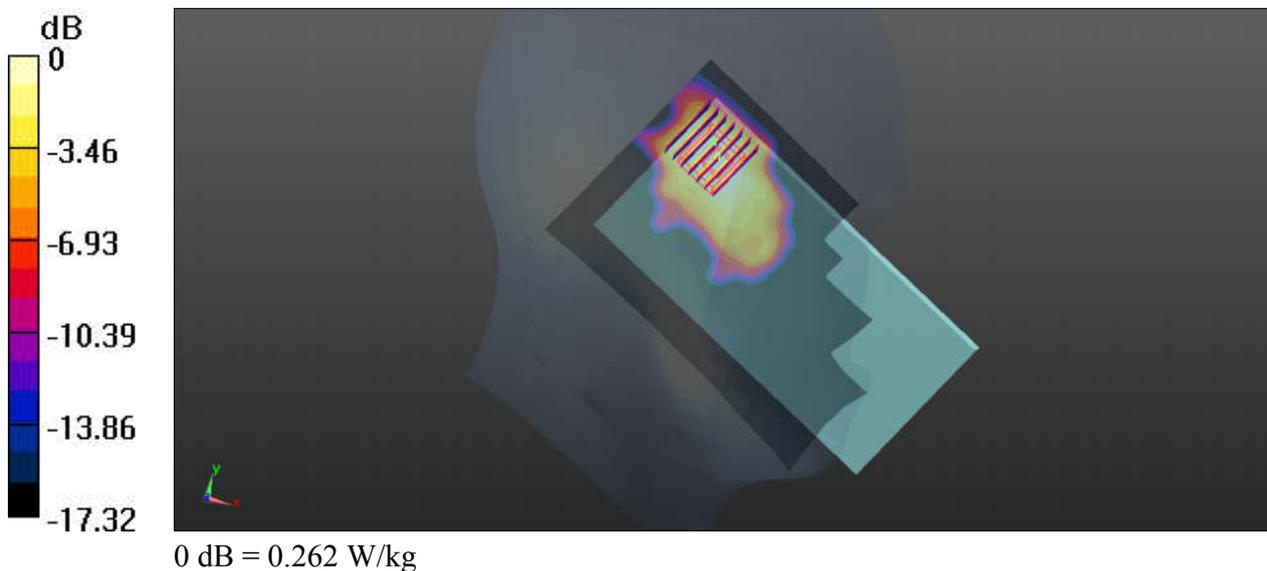

### 10\_WLAN5GHz\_802.11a 6Mbps\_Left Cheek\_Ch64

Communication System: UID 0, WIFI (0); Frequency: 5320 MHz; Duty Cycle: 1:1.143  
Medium: HSL\_5250\_190628 Medium parameters used:  $f = 5320$  MHz;  $\sigma = 4.803$  S/m;  $\epsilon_r = 36.316$ ;  
 $\rho = 1000$  kg/m<sup>3</sup>  
Ambient Temperature : 23.7 °C; Liquid Temperature : 22.4 °C

#### DASY5 Configuration:

- Probe: EX3DV4 - SN3819; ConvF(5.07, 5.07, 5.07); Calibrated: 2019.03.01;
- Sensor-Surface: 1.4mm (Mechanical Surface Detection)
- Electronics: DAE4 Sn715; Calibrated: 2019.01.23
- Phantom: SAM (Front) with CRP v5.0; Type: QD000P40CD; Serial: TP:1795
- Measurement SW: DASY52, Version 52.8 (8); SEMCAD X Version 14.6.10 (7331)

**Ch64/Area Scan (101x191x1):** Interpolated grid: dx=10mm, dy=10mm  
Maximum value of SAR (interpolated) = 1.14 W/kg

**Ch64/Zoom Scan (7x7x7)/Cube 0:** Measurement grid: dx=4mm, dy=4mm, dz=1.4mm  
Reference Value = 0 V/m; Power Drift = 0.08 dB  
Peak SAR (extrapolated) = 1.79 W/kg  
**SAR(1 g) = 0.456 W/kg; SAR(10 g) = 0.122 W/kg**  
Maximum value of SAR (measured) = 1.10 W/kg

**Ch64/Zoom Scan (7x7x7)/Cube 1:** Measurement grid: dx=4mm, dy=4mm, dz=1.4mm  
Reference Value = 0 V/m; Power Drift = 0.08 dB  
Peak SAR (extrapolated) = 1.82 W/kg  
**SAR(1 g) = 0.437 W/kg; SAR(10 g) = 0.111 W/kg**  
Maximum value of SAR (measured) = 1.12 W/kg

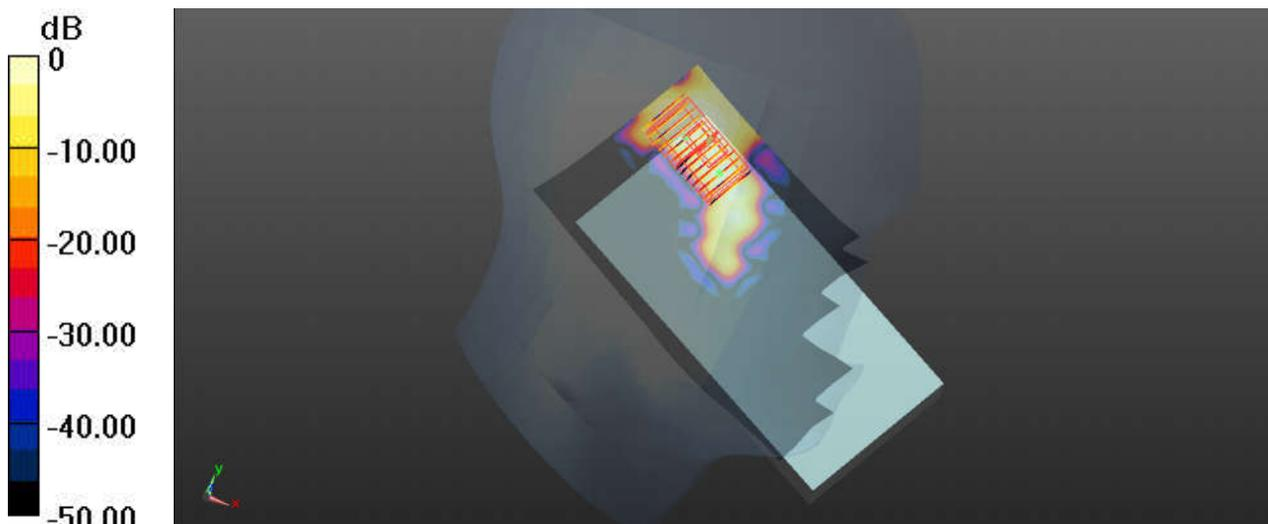

0 dB = 1.12 W/kg

## 11\_WLAN5GHz\_802.11a 6Mbps\_Left Cheek\_Ch144

Communication System: UID 0, WIFI (0); Frequency: 5720 MHz; Duty Cycle: 1:1.143  
 Medium: HSL\_5600\_190627 Medium parameters used:  $f = 5720$  MHz;  $\sigma = 5.17$  S/m;  $\epsilon_r = 36.32$ ;  $\rho = 1000$  kg/m<sup>3</sup>  
 Ambient Temperature : 23.5 °C; Liquid Temperature : 22.6 °C

### DASY5 Configuration:

- Probe: EX3DV4 - SN3819; ConvF(4.7, 4.7, 4.7); Calibrated: 2019.03.01;
- Sensor-Surface: 1.4mm (Mechanical Surface Detection)
- Electronics: DAE4 Sn715; Calibrated: 2019.01.23
- Phantom: SAM (Front) with CRP v5.0; Type: QD000P40CD; Serial: TP:1795
- Measurement SW: DASY52, Version 52.8 (8); SEMCAD X Version 14.6.10 (7331)

**Ch144/Area Scan (101x191x1):** Interpolated grid: dx=10mm, dy=10mm  
 Maximum value of SAR (interpolated) = 1.39 W/kg

**Ch144/Zoom Scan (7x7x7)/Cube 0:** Measurement grid: dx=4mm, dy=4mm, dz=1.4mm  
 Reference Value = 4.401 V/m; Power Drift = -0.02 dB  
 Peak SAR (extrapolated) = 2.75 W/kg  
**SAR(1 g) = 0.618 W/kg; SAR(10 g) = 0.200 W/kg**  
 Maximum value of SAR (measured) = 1.52 W/kg

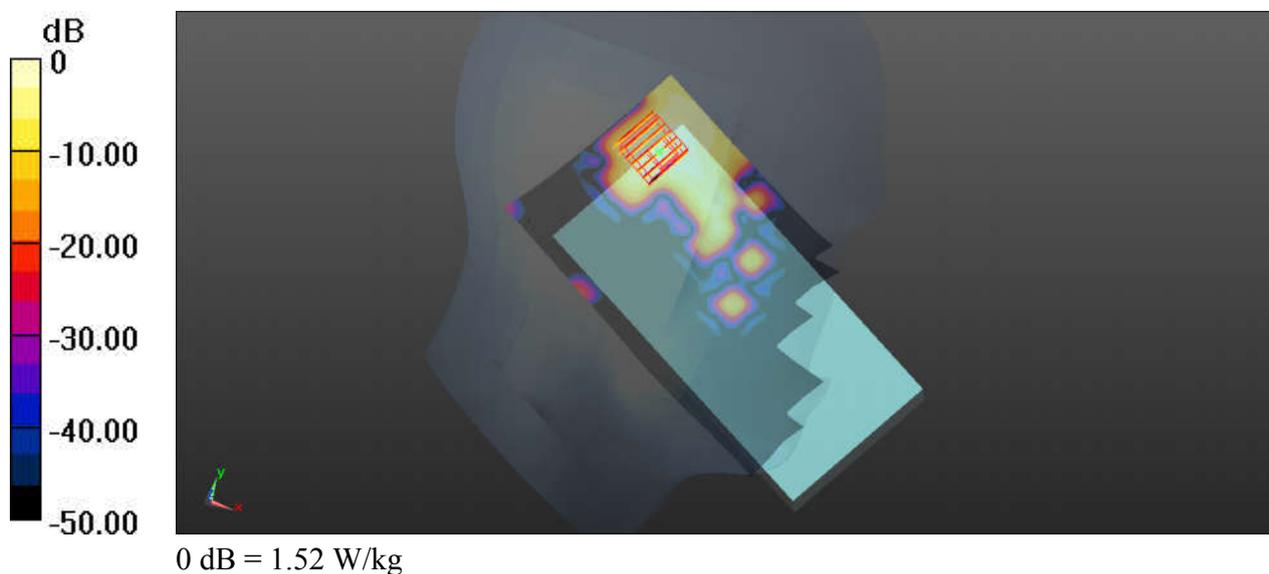

## 12\_WLAN5GHz\_802.11a 6Mbps\_Left Cheek\_Ch149

Communication System: UID 0, WIFI (0); Frequency: 5745 MHz; Duty Cycle: 1:1.143  
Medium: HSL\_5750\_190626 Medium parameters used:  $f = 5745 \text{ MHz}$ ;  $\sigma = 5.308 \text{ S/m}$ ;  $\epsilon_r = 35.56$ ;  $\rho = 1000 \text{ kg/m}^3$   
Ambient Temperature :  $23.4 \text{ }^\circ\text{C}$ ; Liquid Temperature :  $22.5 \text{ }^\circ\text{C}$

### DASY5 Configuration:

- Probe: EX3DV4 - SN3819; ConvF(4.77, 4.77, 4.77); Calibrated: 2019.03.01;
- Sensor-Surface: 1.4mm (Mechanical Surface Detection)
- Electronics: DAE4 Sn715; Calibrated: 2019.01.23
- Phantom: SAM (Front) with CRP v5.0; Type: QD000P40CD; Serial: TP:1795
- Measurement SW: DASY52, Version 52.8 (8); SEMCAD X Version 14.6.10 (7331)

**Ch149/Area Scan (101x191x1):** Interpolated grid:  $dx=10\text{mm}$ ,  $dy=10\text{mm}$   
Maximum value of SAR (interpolated) =  $1.49 \text{ W/kg}$

**Ch149/Zoom Scan (7x7x7)/Cube 0:** Measurement grid:  $dx=4\text{mm}$ ,  $dy=4\text{mm}$ ,  $dz=1.4\text{mm}$   
Reference Value =  $3.345 \text{ V/m}$ ; Power Drift =  $0.03 \text{ dB}$   
Peak SAR (extrapolated) =  $2.50 \text{ W/kg}$   
**SAR(1 g) =  $0.592 \text{ W/kg}$ ; SAR(10 g) =  $0.193 \text{ W/kg}$**   
Maximum value of SAR (measured) =  $1.55 \text{ W/kg}$

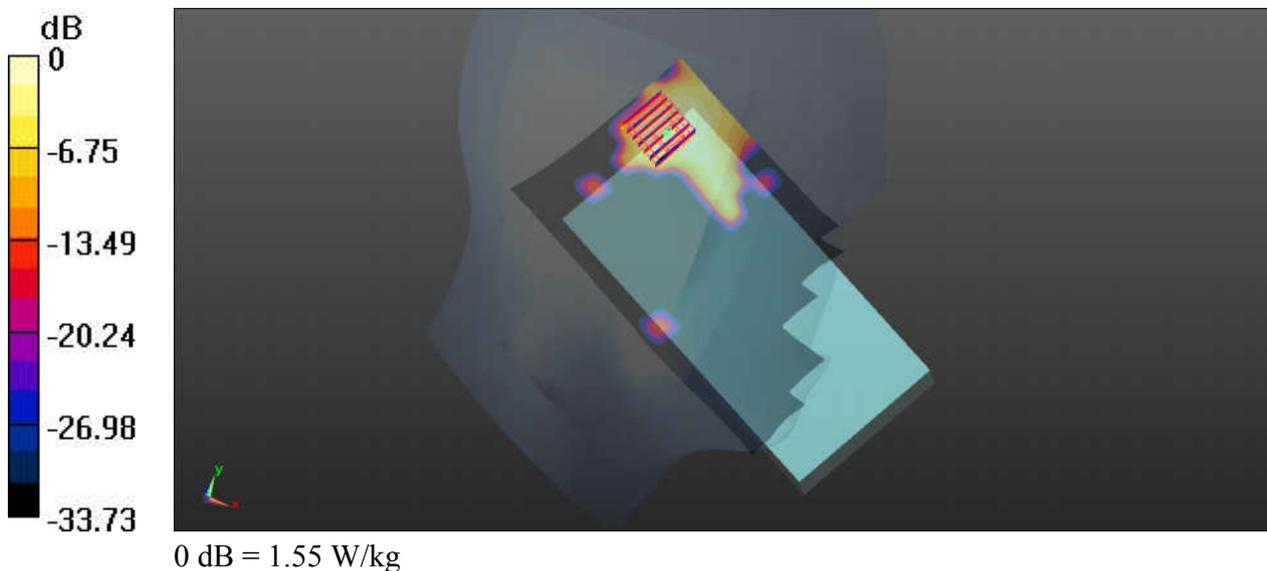

### 13\_Bluetooth\_DH5 1Mbps\_Left Cheek\_Ch78

Communication System: UID 0, Bluetooth (0); Frequency: 2480 MHz; Duty Cycle: 1:1.302  
Medium: HSL\_2450\_190628 Medium parameters used:  $f = 2480$  MHz;  $\sigma = 1.864$  S/m;  $\epsilon_r = 37.871$ ;  
 $\rho = 1000$  kg/m<sup>3</sup>  
Ambient Temperature : 23.6 °C; Liquid Temperature : 22.5 °C

#### DASY5 Configuration:

- Probe: EX3DV4 - SN3819; ConvF(7.21, 7.21, 7.21); Calibrated: 2019.03.01;
- Sensor-Surface: 2mm (Mechanical Surface Detection)
- Electronics: DAE4 Sn715; Calibrated: 2019.01.23
- Phantom: SAM (Front) with CRP v5.0; Type: QD000P40CD; Serial: TP:1795
- Measurement SW: DASY52, Version 52.8 (8); SEMCAD X Version 14.6.10 (7331)

**Ch78/Area Scan (91x161x1):** Interpolated grid: dx=12mm, dy=12mm  
Maximum value of SAR (interpolated) = 0.0787 W/kg

**Ch78/Zoom Scan (7x7x7)/Cube 0:** Measurement grid: dx=5mm, dy=5mm, dz=5mm  
Reference Value = 2.746 V/m; Power Drift = 0.01 dB  
Peak SAR (extrapolated) = 0.0650 W/kg  
**SAR(1 g) = 0.033 W/kg; SAR(10 g) = 0.016 W/kg**  
Maximum value of SAR (measured) = 0.0499 W/kg

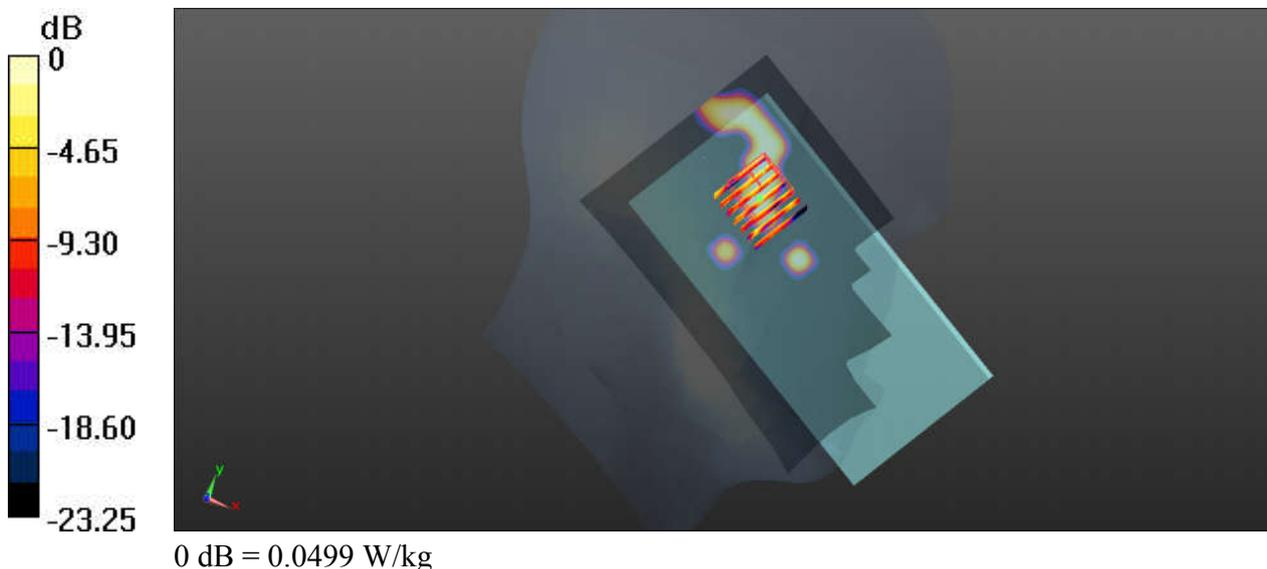

### 14\_WCDMA V\_RMC 12.2Kbps\_Back\_10mm\_Ch4132

Communication System: UID 0, UMTS (0); Frequency: 826.4 MHz; Duty Cycle: 1:1  
Medium: HSL\_835\_190616 Medium parameters used:  $f = 826.4$  MHz;  $\sigma = 0.907$  S/m;  $\epsilon_r = 41.908$ ;  $\rho = 1000$  kg/m<sup>3</sup>  
Ambient Temperature : 23.4 °C; Liquid Temperature : 22.6 °C

#### DASY5 Configuration:

- Probe: ES3DV3 - SN3191; ConvF(6.38, 6.38, 6.38); Calibrated: 2019.01.29;
- Sensor-Surface: 3mm (Mechanical Surface Detection)
- Electronics: DAE4 Sn1437; Calibrated: 2018.10.15
- Phantom: SAM2; Type: QD000P40CD; Serial: TP:1671
- Measurement SW: DASY52, Version 52.8 (8); SEMCAD X Version 14.6.10 (7331)

**Ch4132/Area Scan (71x131x1):** Interpolated grid: dx=15mm, dy=15mm  
Maximum value of SAR (interpolated) = 0.534 W/kg

**Ch4132/Zoom Scan (5x5x7)/Cube 0:** Measurement grid: dx=8mm, dy=8mm, dz=5mm  
Reference Value = 3.199 V/m; Power Drift = -0.07 dB  
Peak SAR (extrapolated) = 0.767 W/kg  
**SAR(1 g) = 0.448 W/kg; SAR(10 g) = 0.254 W/kg**  
Maximum value of SAR (measured) = 0.553 W/kg

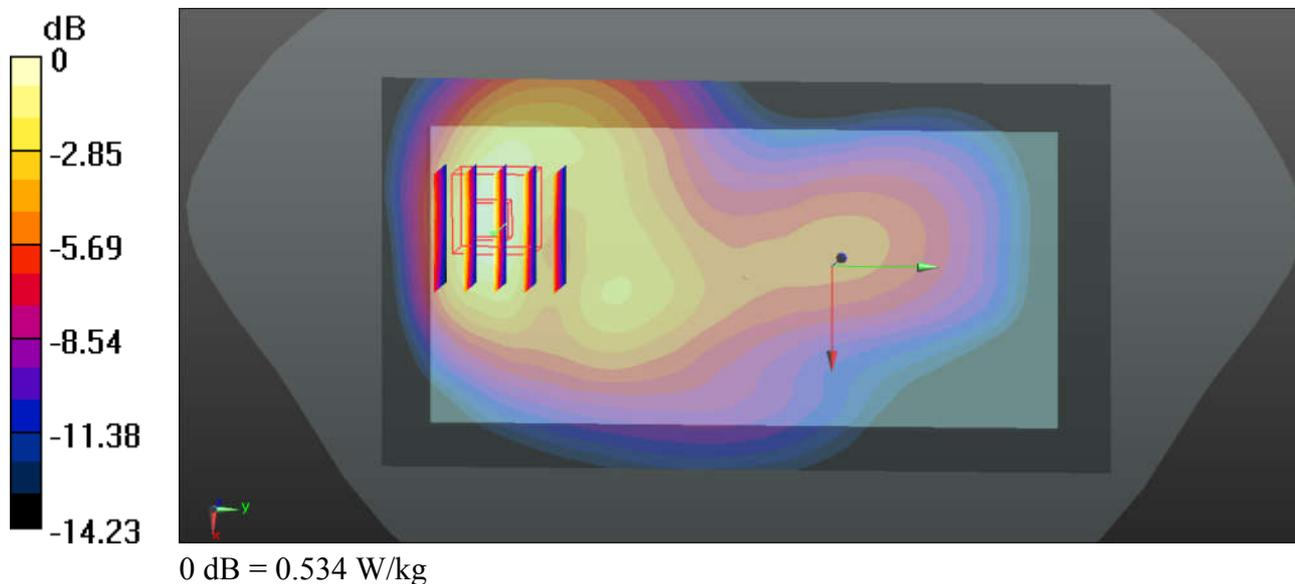

### 15\_WCDMA IV\_RMC 12.2Kbps\_Front\_10mm\_Ch1312

Communication System: UID 0, UMTS (0); Frequency: 1712.4 MHz; Duty Cycle: 1:1  
 Medium: HSL\_1750\_190615 Medium parameters used:  $f = 1712.4$  MHz;  $\sigma = 1.363$  S/m;  $\epsilon_r = 40.271$ ;  
 $\rho = 1000$  kg/m<sup>3</sup>  
 Ambient Temperature : 23.4 °C; Liquid Temperature : 22.7 °C

**DASY5 Configuration:**

- Probe: ES3DV3 - SN3191; ConvF(5.51, 5.51, 5.51); Calibrated: 2019.01.29;
- Sensor-Surface: 3mm (Mechanical Surface Detection)
- Electronics: DAE4 Sn1437; Calibrated: 2018.10.15
- Phantom: SAM2; Type: QD000P40CD; Serial: TP:1671
- Measurement SW: DASY52, Version 52.8 (8); SEMCAD X Version 14.6.10 (7331)

**Ch1312/Area Scan (71x131x1):** Interpolated grid: dx=15mm, dy=15mm  
 Maximum value of SAR (interpolated) = 0.679 W/kg

**Ch1312/Zoom Scan (5x5x7)/Cube 0:** Measurement grid: dx=8mm, dy=8mm, dz=5mm  
 Reference Value = 15.26 V/m; Power Drift = -0.06 dB  
 Peak SAR (extrapolated) = 0.910 W/kg  
**SAR(1 g) = 0.579 W/kg; SAR(10 g) = 0.342 W/kg**  
 Maximum value of SAR (measured) = 0.693 W/kg

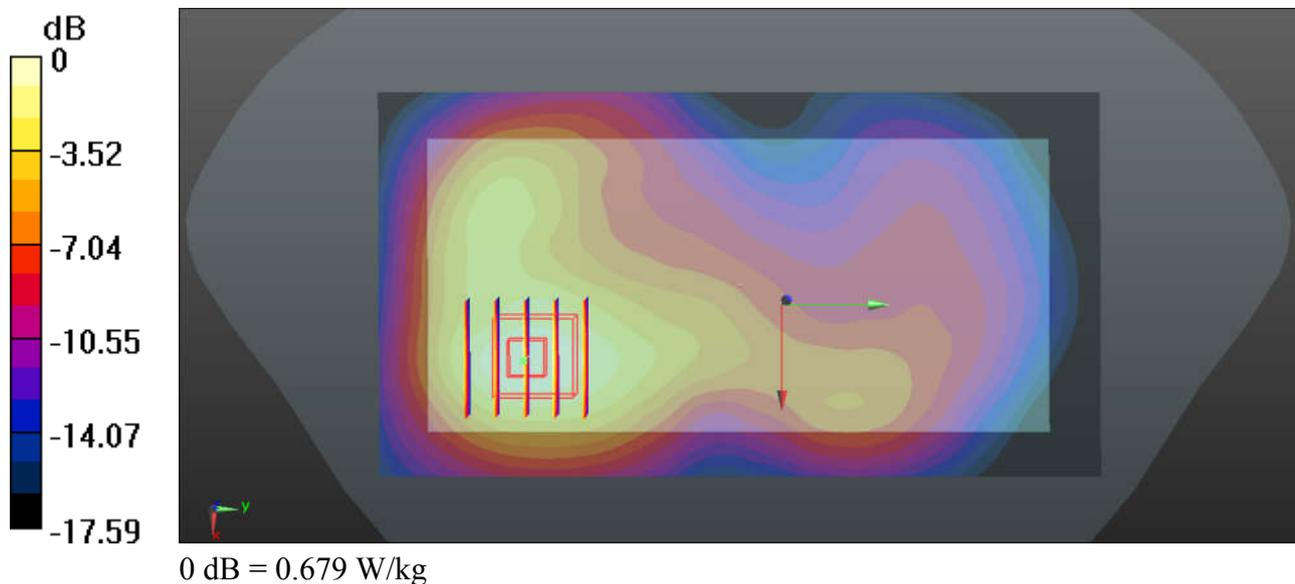

### 16\_WCDMA II\_RMC 12.2Kbps\_Front\_10mm\_Ch9538

Communication System: UID 0, UMTS (0); Frequency: 1907.6 MHz; Duty Cycle: 1:1  
 Medium: HSL\_1900\_190615 Medium parameters used:  $f = 1908 \text{ MHz}$ ;  $\sigma = 1.451 \text{ S/m}$ ;  $\epsilon_r = 39.996$ ;  $\rho = 1000 \text{ kg/m}^3$   
 Ambient Temperature : 23.5 °C; Liquid Temperature : 22.9 °C

**DASY5 Configuration:**

- Probe: ES3DV3 - SN3191; ConvF(5.28, 5.28, 5.28); Calibrated: 2019.01.29;
- Sensor-Surface: 3mm (Mechanical Surface Detection)
- Electronics: DAE4 Sn1437; Calibrated: 2018.10.15
- Phantom: SAM2; Type: QD000P40CD; Serial: TP:1671
- Measurement SW: DASY52, Version 52.8 (8); SEMCAD X Version 14.6.10 (7331)

**Ch9538/Area Scan (71x131x1):** Interpolated grid: dx=15mm, dy=15mm  
 Maximum value of SAR (interpolated) = 0.730 W/kg

**Ch9538/Zoom Scan (5x5x7)/Cube 0:** Measurement grid: dx=8mm, dy=8mm, dz=5mm  
 Reference Value = 13.93 V/m; Power Drift = -0.12 dB  
 Peak SAR (extrapolated) = 0.992 W/kg  
**SAR(1 g) = 0.599 W/kg; SAR(10 g) = 0.346 W/kg**  
 Maximum value of SAR (measured) = 0.729 W/kg

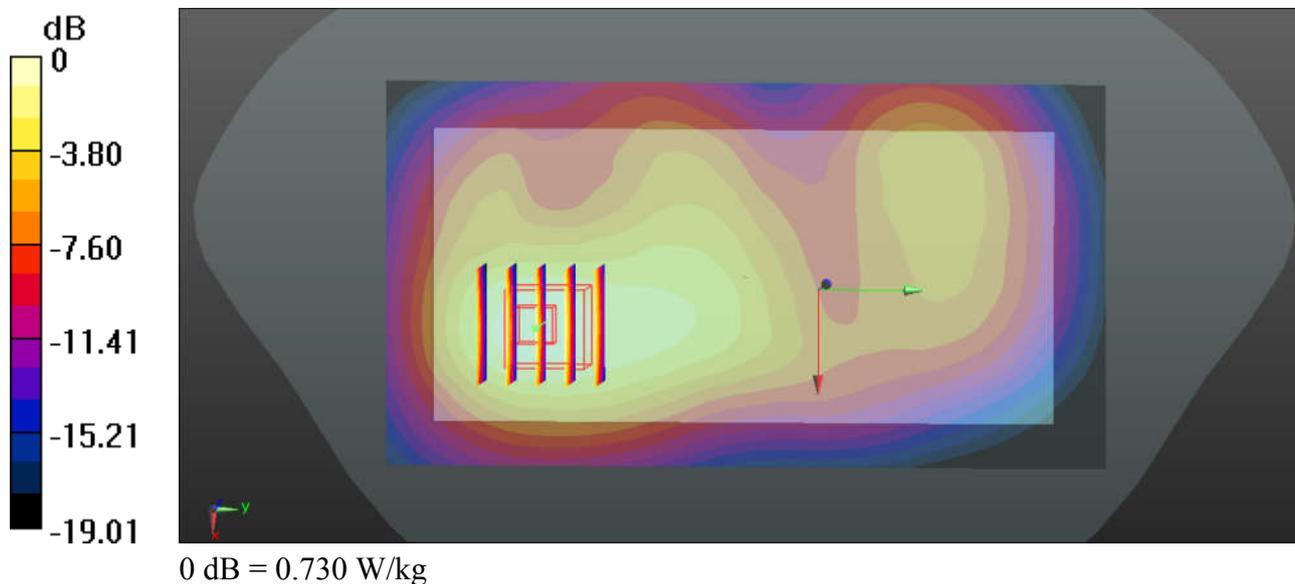

### 17\_LTE Band 12\_10M\_QPSK\_1RB\_25Offset\_Back\_10mm\_Ch23095

Communication System: UID 0, LTE (0); Frequency: 707.5 MHz; Duty Cycle: 1:1

Medium: HSL\_750\_190617 Medium parameters used:  $f = 707.5$  MHz;  $\sigma = 0.86$  S/m;  $\epsilon_r = 41.73$ ;  $\rho = 1000$  kg/m<sup>3</sup>

Ambient Temperature : 23.4 °C; Liquid Temperature : 22.4 °C

#### DASY5 Configuration:

- Probe: ES3DV3 - SN3191; ConvF(6.59, 6.59, 6.59); Calibrated: 2019.01.29;
- Sensor-Surface: 3mm (Mechanical Surface Detection)
- Electronics: DAE4 Sn1437; Calibrated: 2018.10.15
- Phantom: SAM2; Type: QD000P40CD; Serial: TP:1671
- Measurement SW: DASY52, Version 52.8 (8); SEMCAD X Version 14.6.10 (7331)

**Ch23095/Area Scan (71x131x1):** Interpolated grid: dx=15mm, dy=15mm

Maximum value of SAR (interpolated) = 0.442 W/kg

**Ch23095/Zoom Scan (5x5x7)/Cube 0:** Measurement grid: dx=8mm, dy=8mm, dz=5mm

Reference Value = 22.41 V/m; Power Drift = 0.04 dB

Peak SAR (extrapolated) = 0.493 W/kg

**SAR(1 g) = 0.407 W/kg; SAR(10 g) = 0.312 W/kg**

Maximum value of SAR (measured) = 0.445 W/kg

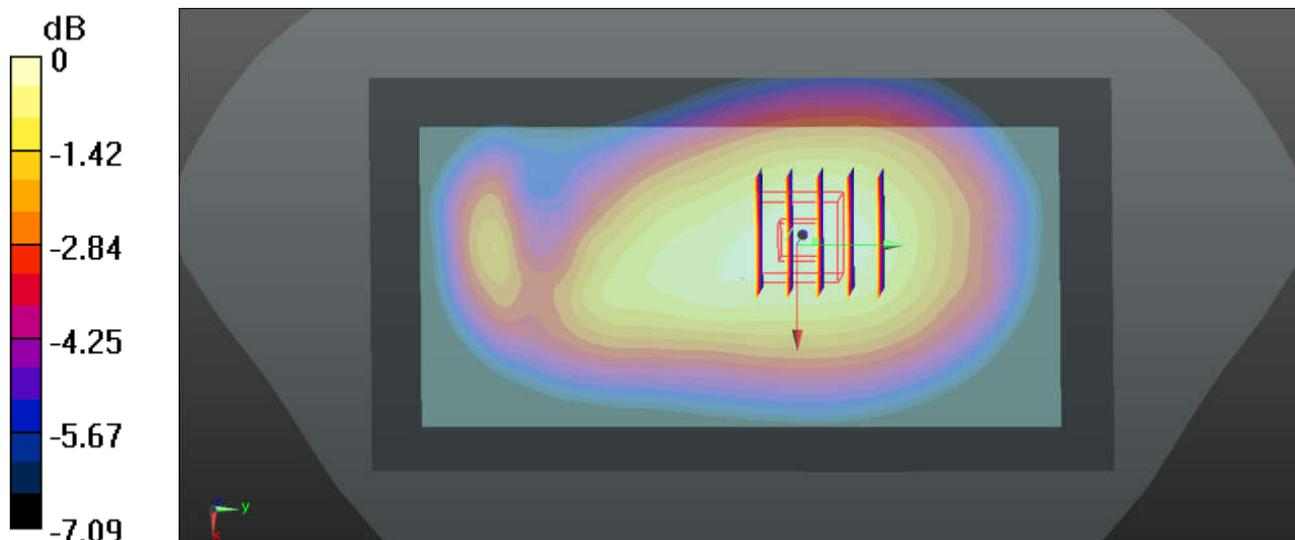

0 dB = 0.445 W/kg

### 18\_LTE Band 13\_10M\_QPSK\_1RB\_25Offset\_Back\_10mm\_Ch23230

Communication System: UID 0, LTE (0); Frequency: 782 MHz; Duty Cycle: 1:1  
Medium: HSL\_750\_190617 Medium parameters used:  $f = 782 \text{ MHz}$ ;  $\sigma = 0.902 \text{ S/m}$ ;  $\epsilon_r = 40.073$ ;  $\rho = 1000 \text{ kg/m}^3$   
Ambient Temperature : 23.4 °C; Liquid Temperature : 22.4 °C

#### DASY5 Configuration:

- Probe: ES3DV3 - SN3191; ConvF(6.59, 6.59, 6.59); Calibrated: 2019.01.29;
- Sensor-Surface: 3mm (Mechanical Surface Detection)
- Electronics: DAE4 Sn1437; Calibrated: 2018.10.15
- Phantom: SAM2; Type: QD000P40CD; Serial: TP:1671
- Measurement SW: DASY52, Version 52.8 (8); SEMCAD X Version 14.6.10 (7331)

**Ch23230/Area Scan (71x131x1):** Interpolated grid:  $dx=15\text{mm}$ ,  $dy=15\text{mm}$   
Maximum value of SAR (interpolated) = 0.229 W/kg

**Ch23230/Zoom Scan (5x5x7)/Cube 0:** Measurement grid:  $dx=8\text{mm}$ ,  $dy=8\text{mm}$ ,  $dz=5\text{mm}$   
Reference Value = 2.326 V/m; Power Drift = -0.09 dB  
Peak SAR (extrapolated) = 0.334 W/kg  
**SAR(1 g) = 0.186 W/kg; SAR(10 g) = 0.103 W/kg**  
Maximum value of SAR (measured) = 0.237 W/kg

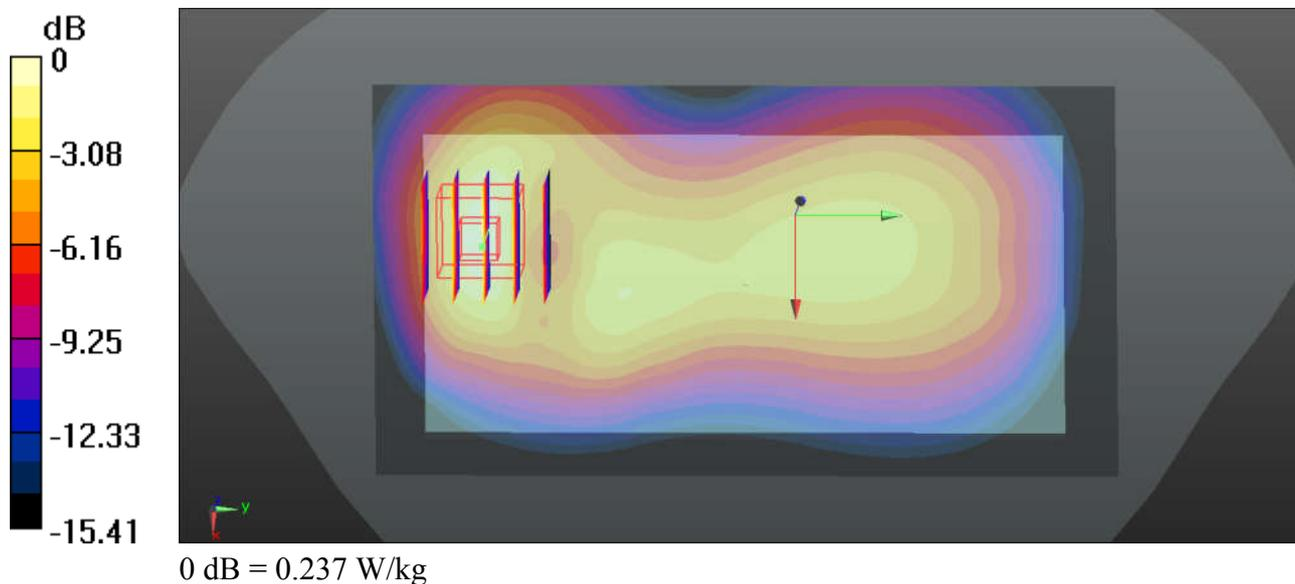

### 19\_LTE Band 5\_10M\_QPSK\_1RB\_25Offset\_Back\_10mm\_Ch20525

Communication System: UID 0, LTE (0); Frequency: 836.5 MHz; Duty Cycle: 1:1  
Medium: HSL\_835\_190616 Medium parameters used:  $f = 836.5$  MHz;  $\sigma = 0.915$  S/m;  $\epsilon_r = 41.816$ ;  $\rho = 1000$  kg/m<sup>3</sup>  
Ambient Temperature : 23.4 °C; Liquid Temperature : 22.6 °C

#### DASY5 Configuration:

- Probe: ES3DV3 - SN3191; ConvF(6.38, 6.38, 6.38); Calibrated: 2019.01.29;
- Sensor-Surface: 3mm (Mechanical Surface Detection)
- Electronics: DAE4 Sn1437; Calibrated: 2018.10.15
- Phantom: SAM2; Type: QD000P40CD; Serial: TP:1671
- Measurement SW: DASY52, Version 52.8 (8); SEMCAD X Version 14.6.10 (7331)

**Ch20525/Area Scan (71x131x1):** Interpolated grid: dx=15mm, dy=15mm  
Maximum value of SAR (interpolated) = 0.379 W/kg

**Ch20525/Zoom Scan (5x5x7)/Cube 0:** Measurement grid: dx=8mm, dy=8mm, dz=5mm  
Reference Value = 1.580 V/m; Power Drift = 0.03 dB  
Peak SAR (extrapolated) = 0.556 W/kg  
**SAR(1 g) = 0.322 W/kg; SAR(10 g) = 0.179 W/kg**  
Maximum value of SAR (measured) = 0.410 W/kg

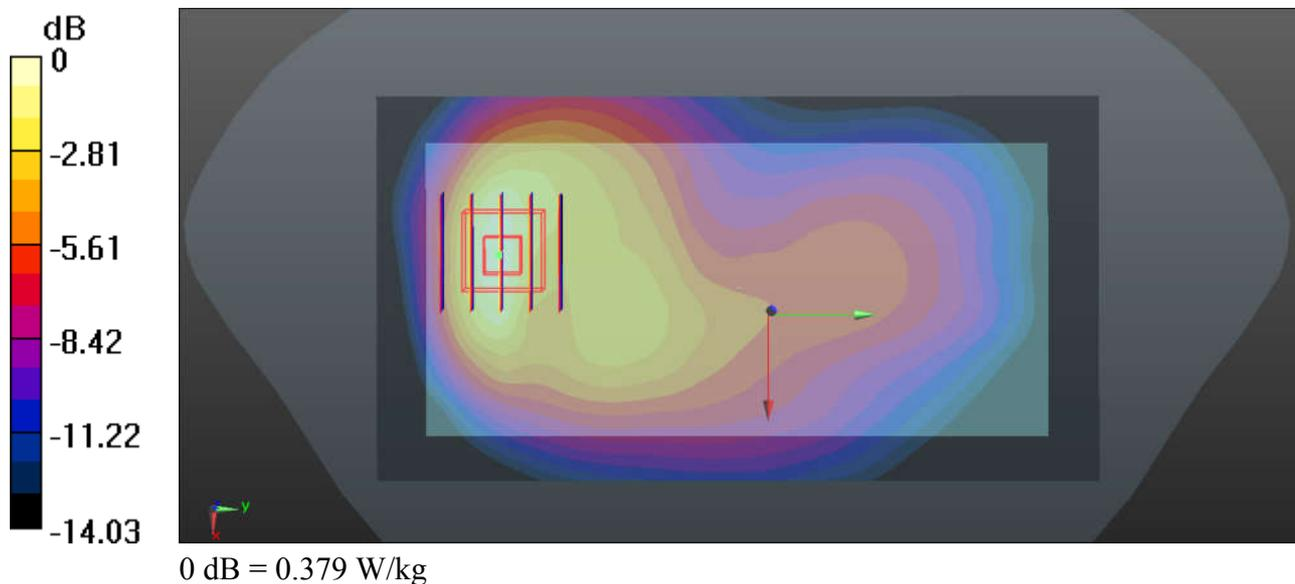

## 20\_LTE Band 4\_20M\_QPSK\_1RB\_0Offset\_Front\_10mm\_Ch20175

Communication System: UID 0, LTE (0); Frequency: 1732.5 MHz; Duty Cycle: 1:1

Medium: HSL\_1750\_190615 Medium parameters used:  $f = 1732.5$  MHz;  $\sigma = 1.386$  S/m;  $\epsilon_r = 40.178$ ;

$\rho = 1000$  kg/m<sup>3</sup>

Ambient Temperature : 23.4 °C; Liquid Temperature : 22.7 °C

DASY5 Configuration:

- Probe: ES3DV3 - SN3191; ConvF(5.51, 5.51, 5.51); Calibrated: 2019.01.29;
- Sensor-Surface: 3mm (Mechanical Surface Detection)
- Electronics: DAE4 Sn1437; Calibrated: 2018.10.15
- Phantom: SAM2; Type: QD000P40CD; Serial: TP:1671
- Measurement SW: DASY52, Version 52.8 (8); SEMCAD X Version 14.6.10 (7331)

**Ch20175/Area Scan (71x131x1):** Interpolated grid: dx=15mm, dy=15mm

Maximum value of SAR (interpolated) = 0.478 W/kg

**Ch20175/Zoom Scan (5x5x7)/Cube 0:** Measurement grid: dx=8mm, dy=8mm, dz=5mm

Reference Value = 6.798 V/m; Power Drift = -0.14 dB

Peak SAR (extrapolated) = 0.612 W/kg

**SAR(1 g) = 0.388 W/kg; SAR(10 g) = 0.229 W/kg**

Maximum value of SAR (measured) = 0.467 W/kg

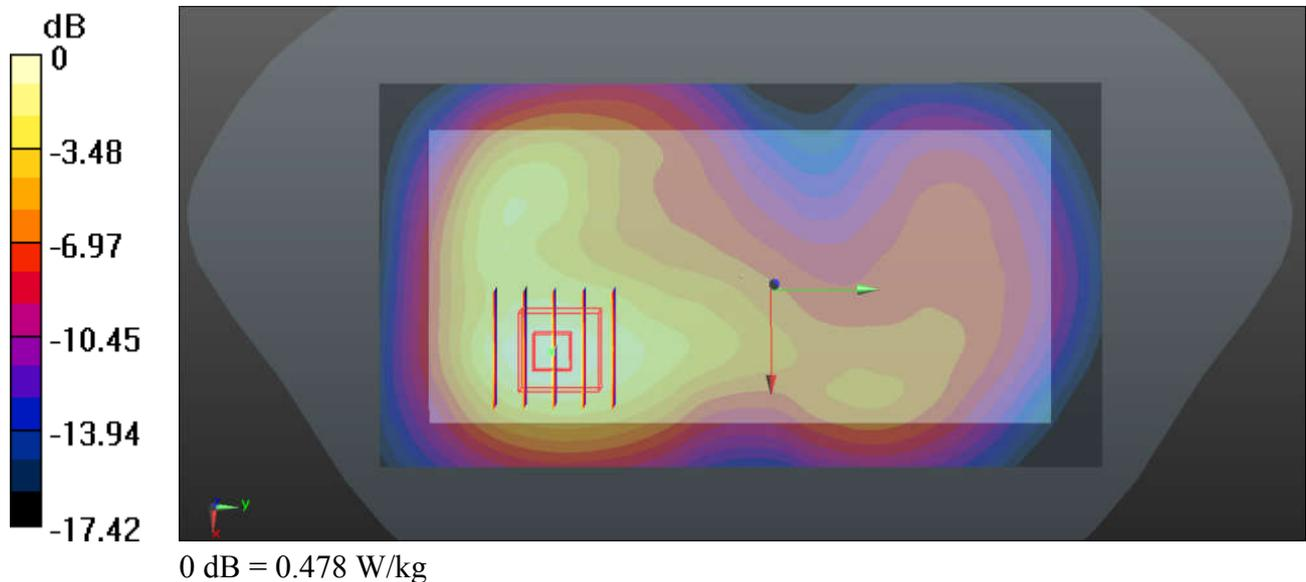

## 21\_LTE Band 2\_20M\_QPSK\_1RB\_49Offset\_Front\_10mm\_Ch19100

Communication System: UID 0, LTE (0); Frequency: 1900 MHz; Duty Cycle: 1:1

Medium: HSL\_1900\_190615 Medium parameters used:  $f = 1900$  MHz;  $\sigma = 1.443$  S/m;  $\epsilon_r = 40.03$ ;  $\rho = 1000$  kg/m<sup>3</sup>

Ambient Temperature : 23.5 °C; Liquid Temperature : 22.9 °C

DASY5 Configuration:

- Probe: ES3DV3 - SN3191; ConvF(5.28, 5.28, 5.28); Calibrated: 2019.01.29;
- Sensor-Surface: 3mm (Mechanical Surface Detection)
- Electronics: DAE4 Sn1437; Calibrated: 2018.10.15
- Phantom: SAM2; Type: QD000P40CD; Serial: TP:1671
- Measurement SW: DASY52, Version 52.8 (8); SEMCAD X Version 14.6.10 (7331)

**Ch19100/Area Scan (71x131x1):** Interpolated grid: dx=15mm, dy=15mm

Maximum value of SAR (interpolated) = 0.711 W/kg

**Ch19100/Zoom Scan (5x5x7)/Cube 0:** Measurement grid: dx=8mm, dy=8mm, dz=5mm

Reference Value = 11.75 V/m; Power Drift = -0.11 dB

Peak SAR (extrapolated) = 0.978 W/kg

**SAR(1 g) = 0.589 W/kg; SAR(10 g) = 0.338 W/kg**

Maximum value of SAR (measured) = 0.713 W/kg

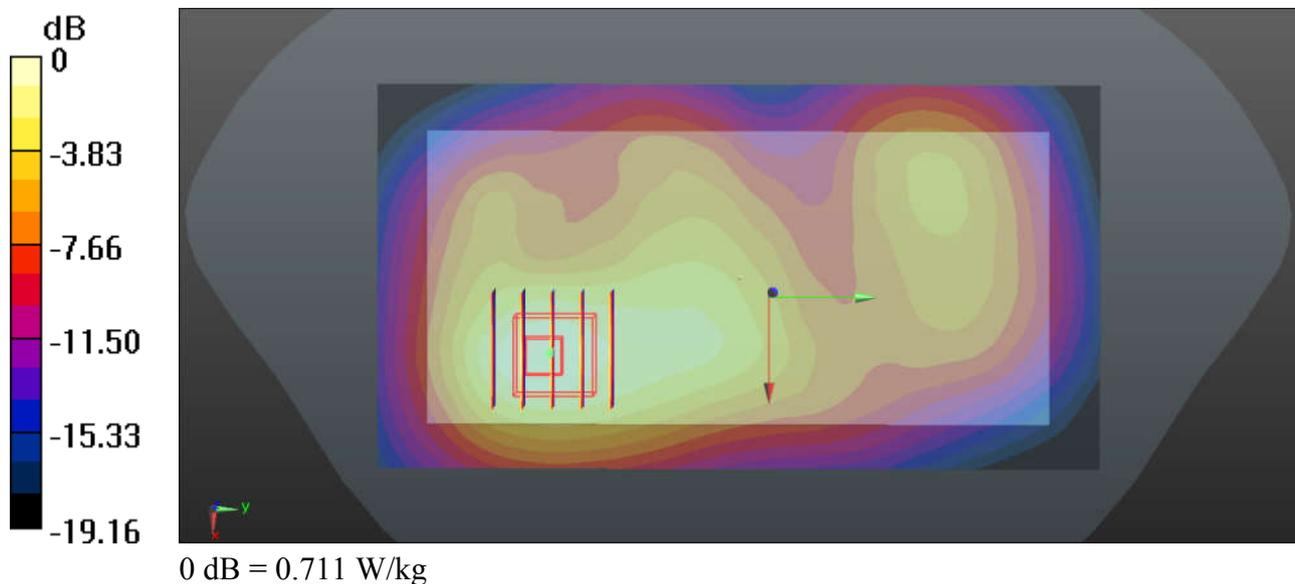

## 22\_WLAN2.4GHz\_802.11b 1Mbps\_Front\_10mm\_Ch11

Communication System: UID 0, WIFI (0); Frequency: 2462 MHz; Duty Cycle: 1:1.025  
Medium: HSL\_2450\_190628 Medium parameters used:  $f = 2462$  MHz;  $\sigma = 1.841$  S/m;  $\epsilon_r = 37.976$ ;  
 $\rho = 1000$  kg/m<sup>3</sup>  
Ambient Temperature : 23.6 °C; Liquid Temperature : 22.5 °C

### DASY5 Configuration:

- Probe: EX3DV4 - SN3819; ConvF(7.21, 7.21, 7.21); Calibrated: 2019.03.01;
- Sensor-Surface: 2mm (Mechanical Surface Detection)
- Electronics: DAE4 Sn715; Calibrated: 2019.01.23
- Phantom: SAM (Front) with CRP v5.0; Type: QD000P40CD; Serial: TP:1795
- Measurement SW: DASY52, Version 52.8 (8); SEMCAD X Version 14.6.10 (7331)

### Ch11/Area Scan (91x161x1): Interpolated grid: dx=12mm, dy=12mm

Maximum value of SAR (interpolated) = 0.138 W/kg

### Ch11/Zoom Scan (7x7x7)/Cube 0: Measurement grid: dx=5mm, dy=5mm, dz=5mm

Reference Value = 4.934 V/m; Power Drift = -0.09 dB

Peak SAR (extrapolated) = 0.181 W/kg

**SAR(1 g) = 0.097 W/kg; SAR(10 g) = 0.052 W/kg**

Maximum value of SAR (measured) = 0.137 W/kg

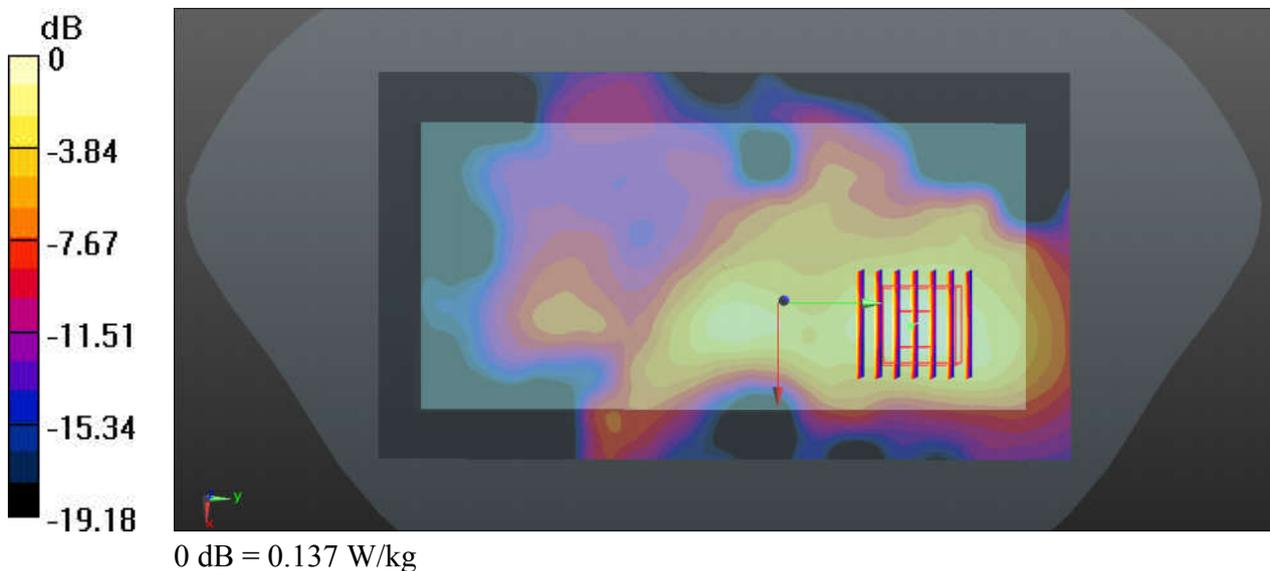

### 23\_WLAN5GHz\_802.11a 6Mbps\_Right Side\_10mm\_Ch48

Communication System: UID 0, WIFI (0); Frequency: 5240 MHz; Duty Cycle: 1:1.143  
Medium: HSL\_5250\_190628 Medium parameters used:  $f = 5240$  MHz;  $\sigma = 4.7$  S/m;  $\epsilon_r = 36.436$ ;  $\rho = 1000$  kg/m<sup>3</sup>  
Ambient Temperature : 23.7 °C; Liquid Temperature : 22.4 °C

#### DASY5 Configuration:

- Probe: EX3DV4 - SN3819; ConvF(5.07, 5.07, 5.07); Calibrated: 2019.03.01;
- Sensor-Surface: 1.4mm (Mechanical Surface Detection)
- Electronics: DAE4 Sn715; Calibrated: 2019.01.23
- Phantom: SAM (Front) with CRP v5.0; Type: QD000P40CD; Serial: TP:1795
- Measurement SW: DASY52, Version 52.8 (8); SEMCAD X Version 14.6.10 (7331)

**Ch48/Area Scan (61x191x1):** Interpolated grid: dx=10mm, dy=10mm  
Maximum value of SAR (interpolated) = 0.542 W/kg

**Ch48/Zoom Scan (7x7x7)/Cube 0:** Measurement grid: dx=4mm, dy=4mm, dz=1.4mm  
Reference Value = 2.516 V/m; Power Drift = 0.04 dB  
Peak SAR (extrapolated) = 0.854 W/kg  
**SAR(1 g) = 0.246 W/kg; SAR(10 g) = 0.095 W/kg**  
Maximum value of SAR (measured) = 0.534 W/kg

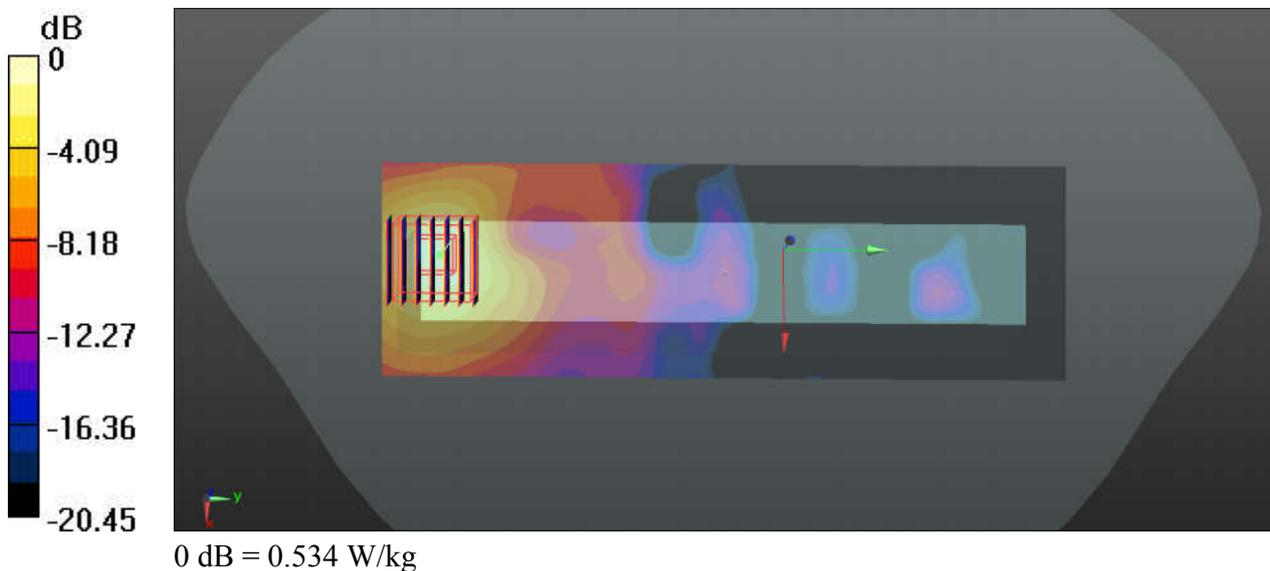

## 24\_WLAN5GHz\_802.11a 6Mbps\_Top Side\_10mm\_Ch149

Communication System: UID 0, WIFI (0); Frequency: 5745 MHz; Duty Cycle: 1:1.143  
Medium: HSL\_5750\_190626 Medium parameters used:  $f = 5745$  MHz;  $\sigma = 5.308$  S/m;  $\epsilon_r = 35.56$ ;  $\rho = 1000$  kg/m<sup>3</sup>  
Ambient Temperature : 23.4 °C; Liquid Temperature : 22.5 °C

### DASY5 Configuration:

- Probe: EX3DV4 - SN3819; ConvF(4.77, 4.77, 4.77); Calibrated: 2019.03.01;
- Sensor-Surface: 1.4mm (Mechanical Surface Detection)
- Electronics: DAE4 Sn715; Calibrated: 2019.01.23
- Phantom: SAM (Front) with CRP v5.0; Type: QD000P40CD; Serial: TP:1795
- Measurement SW: DASY52, Version 52.8 (8); SEMCAD X Version 14.6.10 (7331)

**Ch149/Area Scan (51x101x1):** Interpolated grid: dx=10mm, dy=10mm  
Maximum value of SAR (interpolated) = 0.885 W/kg

**Ch149/Zoom Scan (7x7x7)/Cube 0:** Measurement grid: dx=4mm, dy=4mm, dz=1.4mm  
Reference Value = 4.253 V/m; Power Drift = -0.12 dB  
Peak SAR (extrapolated) = 1.56 W/kg  
**SAR(1 g) = 0.366 W/kg; SAR(10 g) = 0.130 W/kg**  
Maximum value of SAR (measured) = 0.851 W/kg

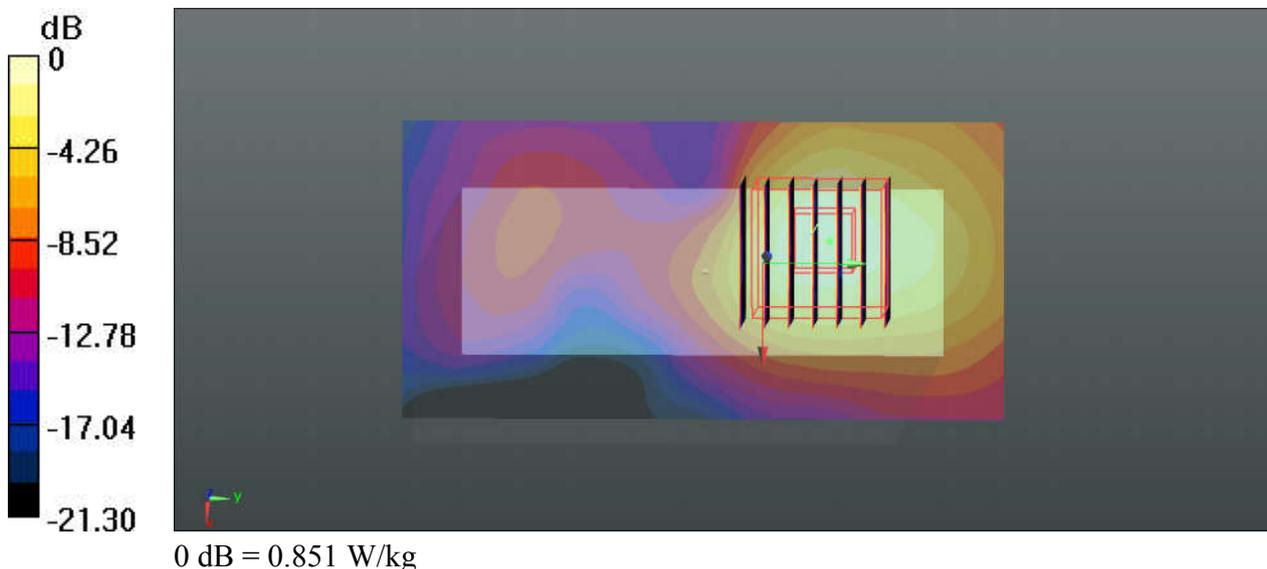

## 25\_Bluetooth\_DH5 1Mbps\_Front\_10mm\_Ch0

Communication System: UID 0, Bluetooth (0); Frequency: 2402 MHz; Duty Cycle: 1:1.302  
Medium: HSL\_2450\_190628 Medium parameters used:  $f = 2402$  MHz;  $\sigma = 1.767$  S/m;  $\epsilon_r = 38.098$ ;  
 $\rho = 1000$  kg/m<sup>3</sup>  
Ambient Temperature : 23.6 °C; Liquid Temperature : 22.5 °C

### DASY5 Configuration:

- Probe: EX3DV4 - SN3819; ConvF(7.21, 7.21, 7.21); Calibrated: 2019.03.01;
- Sensor-Surface: 2mm (Mechanical Surface Detection)
- Electronics: DAE4 Sn715; Calibrated: 2019.01.23
- Phantom: SAM (Front) with CRP v5.0; Type: QD000P40CD; Serial: TP:1795
- Measurement SW: DASY52, Version 52.8 (8); SEMCAD X Version 14.6.10 (7331)

**Ch0/Area Scan (91x161x1):** Interpolated grid: dx=12mm, dy=12mm  
Maximum value of SAR (interpolated) = 0.0157 W/kg

**Ch0/Zoom Scan (7x7x7)/Cube 0:** Measurement grid: dx=5mm, dy=5mm, dz=5mm  
Reference Value = 0.6970 V/m; Power Drift = 0.01 dB  
Peak SAR (extrapolated) = 0.0430 W/kg  
**SAR(1 g) = 0.00976 W/kg; SAR(10 g) = 0.00517 W/kg**  
Maximum value of SAR (measured) = 0.0147 W/kg

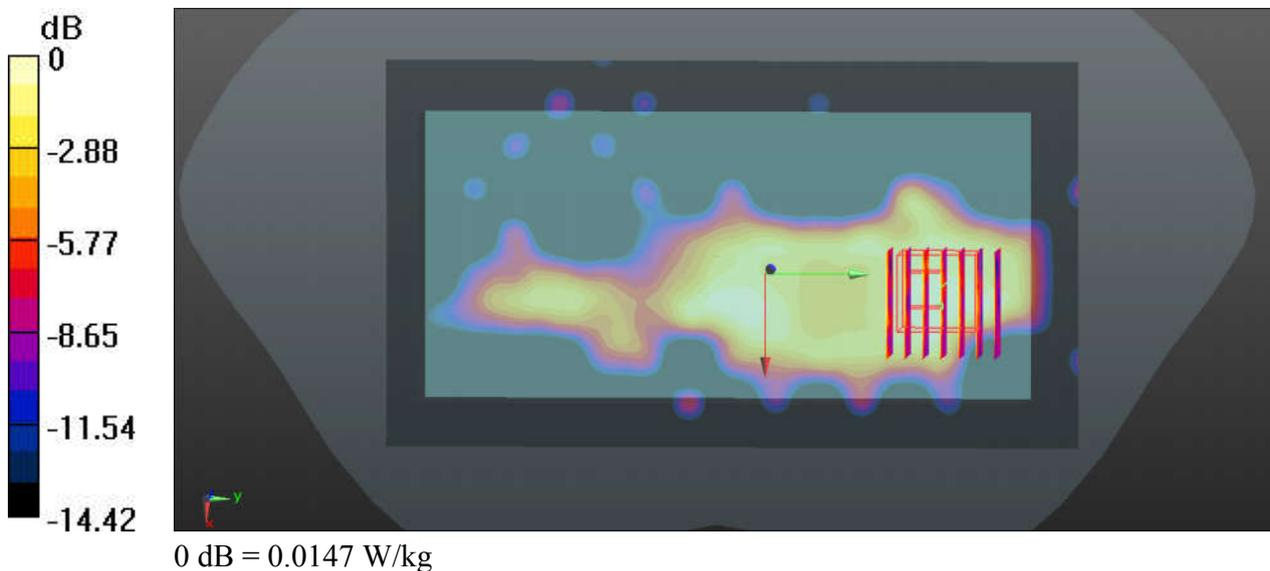

## 26\_WCDMA V\_RMC 12.2Kbps\_Back\_10mm\_Ch4132

Communication System: UID 0, UMTS (0); Frequency: 826.4 MHz; Duty Cycle: 1:1  
 Medium: HSL\_835\_190616 Medium parameters used:  $f = 826.4$  MHz;  $\sigma = 0.907$  S/m;  $\epsilon_r = 41.908$ ;  $\rho = 1000$  kg/m<sup>3</sup>  
 Ambient Temperature : 23.4 °C; Liquid Temperature : 22.6 °C

### DASY5 Configuration:

- Probe: ES3DV3 - SN3191; ConvF(6.38, 6.38, 6.38); Calibrated: 2019.01.29;
- Sensor-Surface: 3mm (Mechanical Surface Detection)
- Electronics: DAE4 Sn1437; Calibrated: 2018.10.15
- Phantom: SAM2; Type: QD000P40CD; Serial: TP:1671
- Measurement SW: DASY52, Version 52.8 (8); SEMCAD X Version 14.6.10 (7331)

**Ch4132/Area Scan (71x131x1):** Interpolated grid: dx=15mm, dy=15mm

Maximum value of SAR (interpolated) = 0.534 W/kg

**Ch4132/Zoom Scan (5x5x7)/Cube 0:** Measurement grid: dx=8mm, dy=8mm, dz=5mm

Reference Value = 3.199 V/m; Power Drift = -0.07 dB

Peak SAR (extrapolated) = 0.767 W/kg

**SAR(1 g) = 0.448 W/kg; SAR(10 g) = 0.254 W/kg**

Maximum value of SAR (measured) = 0.553 W/kg

