

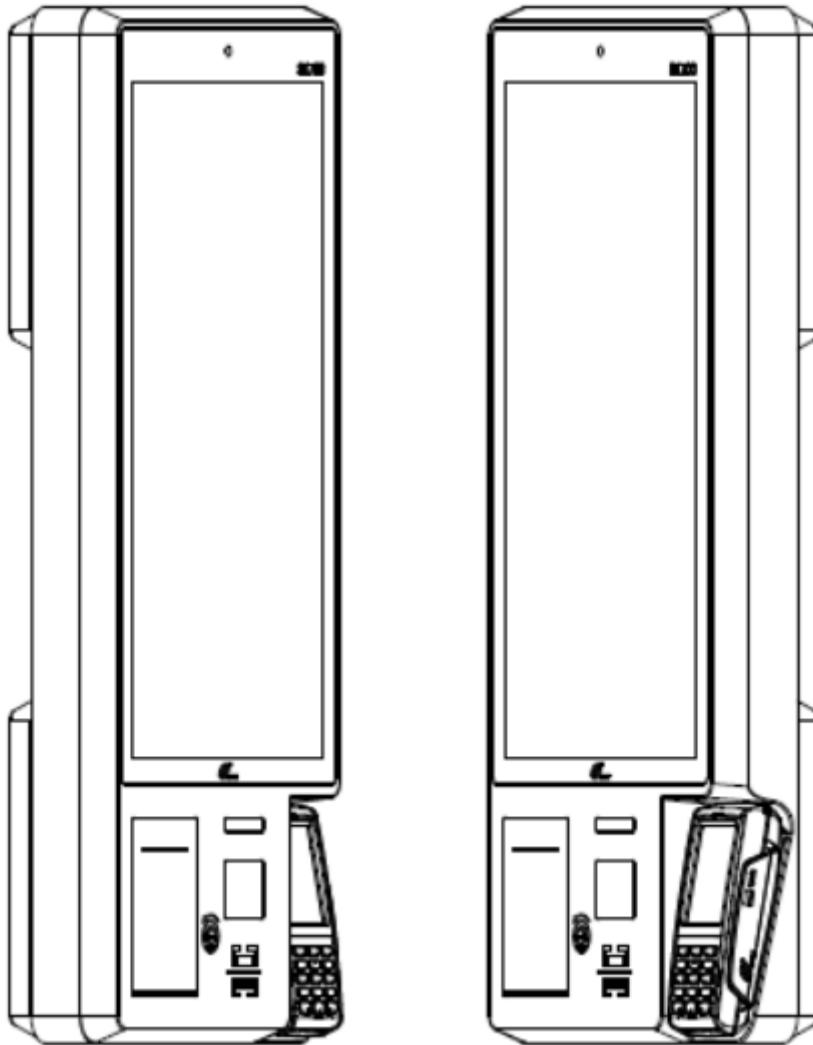

# ***Installation Manual***

## **SK700 Smart Kiosk**



Note: Product images shown may be different than actual product received

**PAX TECHNOLOGY LIMITED**

# 1、Contents Checklist

Please check the components after unpacking. If any are missing, please contact the dealer.

Name	Qty
SK700 Smart Kiosk	1
SK700 Wall Bracket	1
Printer Key	2
Thermal Paper Roll	1
M4-10 Combination Screw	2
Expansion Screw	6
Plastic Packaging	1
Power Cable	1
Quick Setup Guide	1

# 2、Product Description

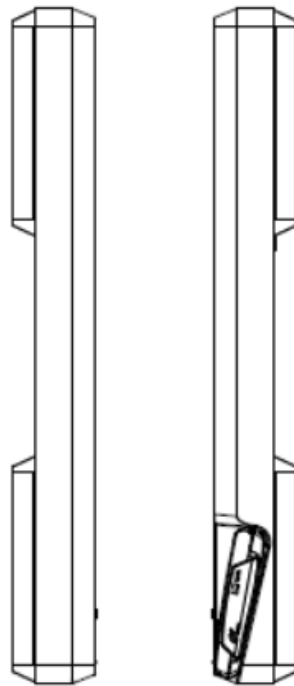

Side View

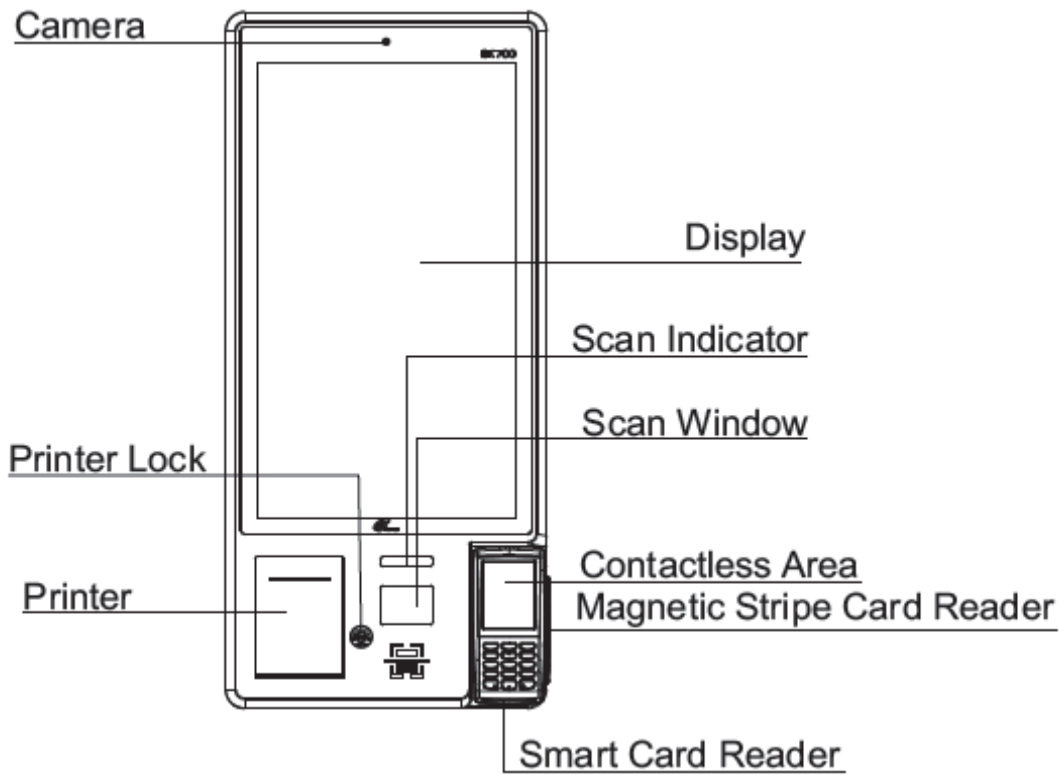

**Front View**

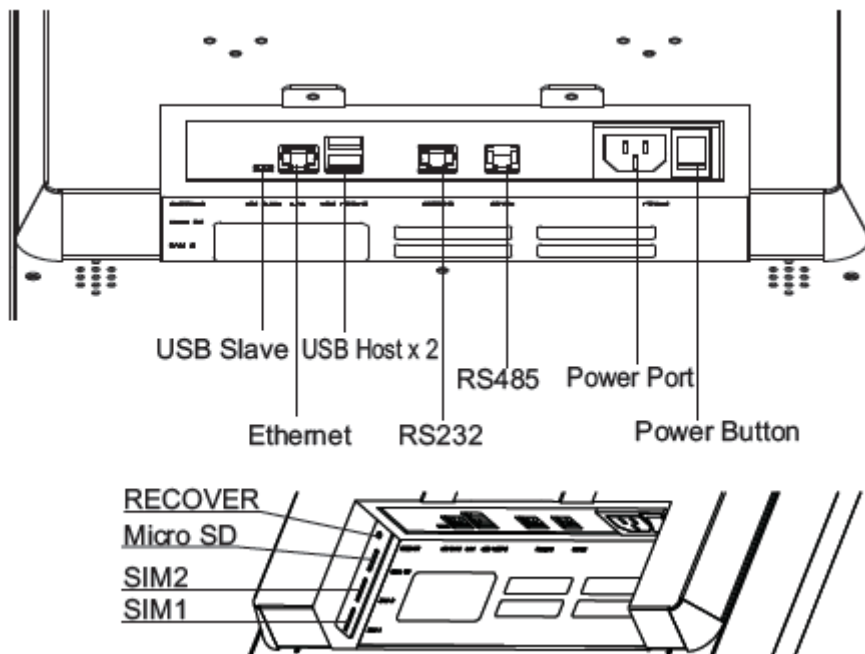

**Interface Diagram**

### 3. Operating Instruction

- **Power on:** Plug in the AC power cable, press and hold the Power button for

three seconds until the boot animation appears.

- **Power off:** Press and hold the Power button for three seconds until the shutdown menu displays. Select Power off. The terminal turns off after a few seconds.

## 4. Payment Options

- **Magnetic stripe card**

Insert magnetic stripe card into card slot and push to the end with magnetic stripe facing down, then pull out the card at a constant speed to swipe card.

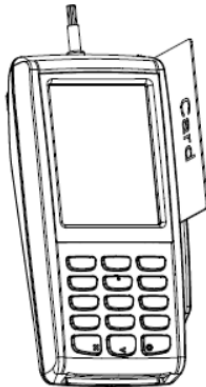

- **IC chip card**

Insert card with IC chip facing up, then push it to the end of the card slot. Leave card inserted until prompted to remove.



- **Contactless card**

Place the contactless card over the center of contactless card reader logo area.

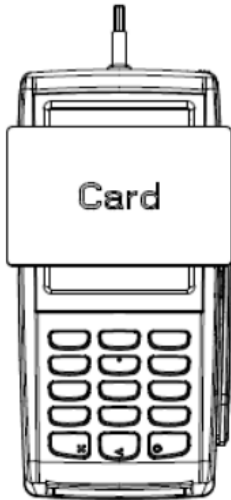

- **Scan**

When the scan indicator is on, hold your QR code & bar code device in front of the scan window to scan code.

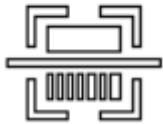
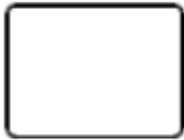
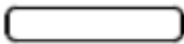

## 5、 Load Printer Paper

1. Insert the key into the keyhole and turn it counterclockwise to open printer cover.

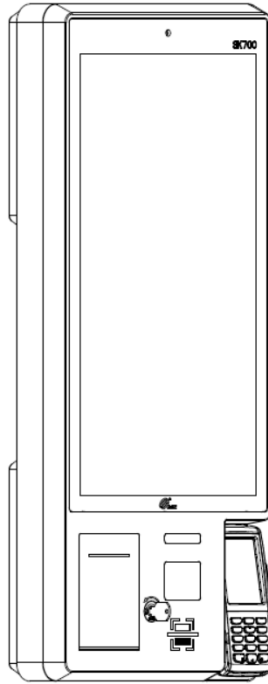

2. Completely open the printer cover.

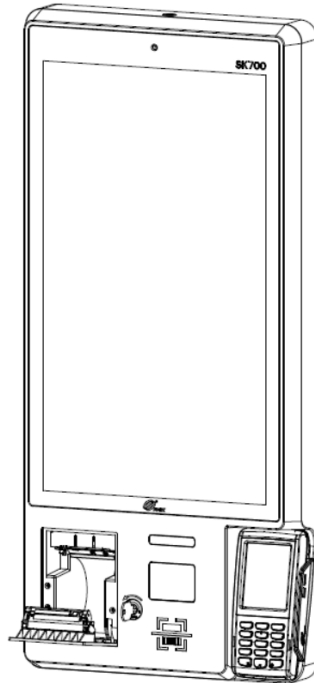

3. Insert the new paper roll into the printer.

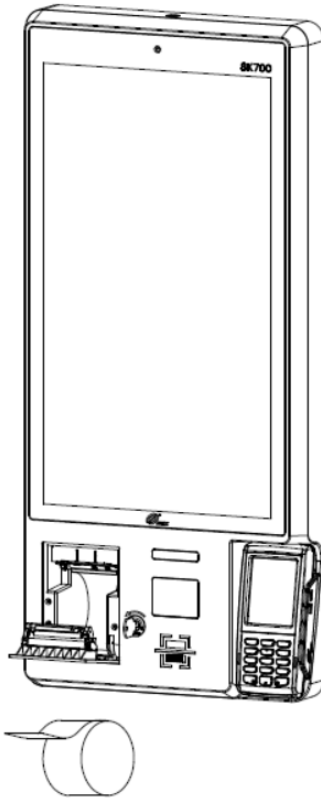

4. Pull out the end of the paper so that it extends past the cutting blade, Make sure the paper roll is placed in the direction as shown in the figure below.

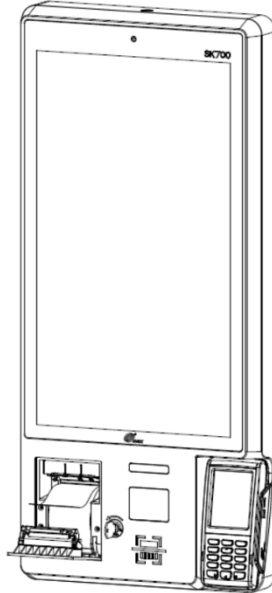

5. Close the printer cover, and pull out the key. Printer will automatically cut off the extra paper, the paper is changed successfully.

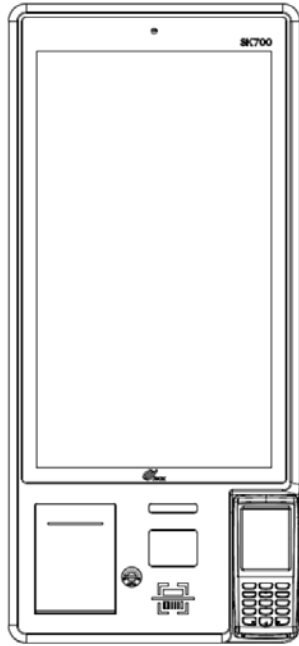

## 6、 Wall-mounted Installation

- Parts List

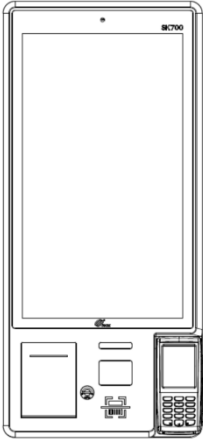
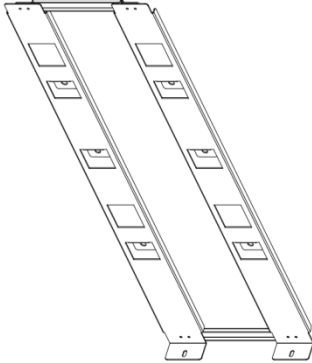
No.	Part	Picture	Qty/pcs
1	SK700Kiosk		1
2	Wall Bracket		1

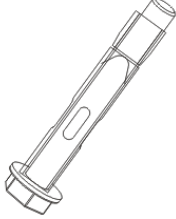
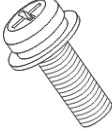

3	M6-50 Expansion Screw		6
4	M4-10 Combination Screw		2

● **Installation Steps**

1. Use 6pcs expansion screws to fix the bracket on the wall.
  - Use an 8.0 mm diameter drill bit to drill holes in the wall according to the position of the bracket fixing hole. The size is shown in the figure below:
  - Note: Holediameter is 8.0mm, Hole depth is above 60.0mm.

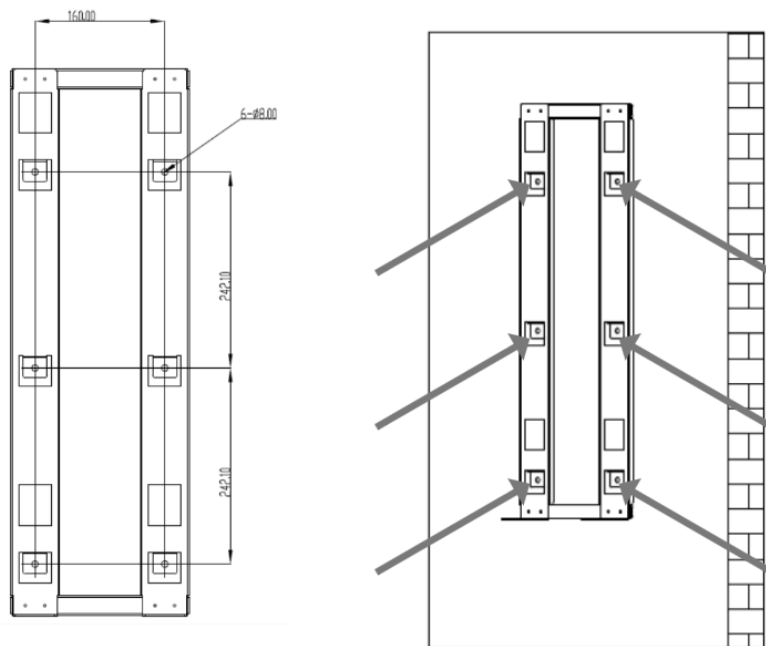

2. Use the 4pcs hooks on the back of the device to hang the whole device on the wall bracket.

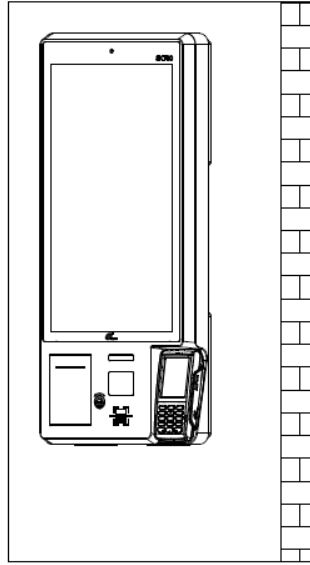

3. Use 2pcs M4-12 combination 3screws to attach the machine to the wall bracket at the bottom of the machine.

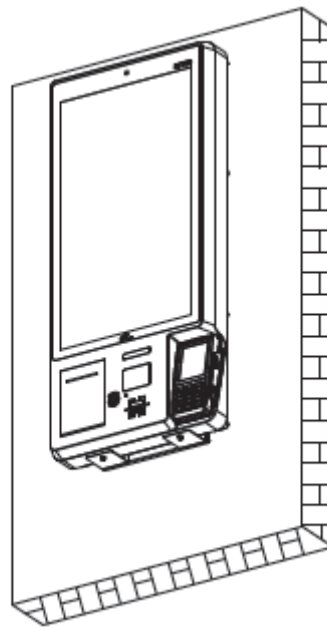

4. The device installation is completed.

## 7.Usage Tips

- 1) There is no built-in battery, and the device can only be powered by the power adapter.
- 2) Avoid exposing the device in overheated, humid, dusty, or strong electromagnetic environment.
- 3) Do not vibrate, shake, or drop the device.
- 4) Do not insert or unplug any part of the device while it is powered on. Otherwise, it may cause damage to the internal circuit.
- 5) If necessary, please contact PAX technical support for assistance with the device.
- 6) Before using the magnetic stripe /IC/contactless card, check if there is any suspicious

person nearby, if so, pay attention to guard against theft.

#### FCC compliance statement

This device complies with Part 15 of the FCC Rules. Operation is subject to the following two conditions: (1) this device may not cause harmful interference, and (2) this device must accept any interference received, including interference that may cause undesired operation.

changes or modifications not expressly approved by the party responsible for compliance could void the user's authority to operate the equipment.

This equipment has been tested and found to comply with the limits for a Class B digital device, pursuant to Part 15 of the FCC Rules. These limits are designed to provide reasonable protection against harmful interference in a residential installation. This equipment generates, uses and can radiate radio frequency energy and, if not installed and used in accordance with the instructions, may cause harmful interference to radio communications. However, there is no guarantee that interference will not occur in a particular installation. If this equipment does cause harmful interference to radio or television reception, which can be determined by turning the equipment off and on, the user is encouraged to try to correct the interference by one or more of the following measures:

- Reorient or relocate the receiving antenna.
- Increase the separation between the equipment and receiver.
- Connect the equipment into an outlet on a circuit different from that to which the receiver is connected.
- Consult the dealer or an experienced radio/TV technician for help.

#### ISED compliance statement

This device contains licence-exempt transmitter(s)/receiver(s) that comply with Innovation, Science and Economic Development Canada's licence-exempt RSS(s). Operation is subject to the following two conditions:

- (1) This device may not cause interference.
- (2) This device must accept any interference, including interference that may cause undesired operation of the device.

L'émetteur/récepteur exempt de licence contenu dans le présent appareil est conforme aux CNR d'Innovation, Sciences et Développement économique Canada applicables aux appareils radio exempts de licence. L'exploitation est autorisée aux deux conditions suivantes :

- (1) L'appareil ne doit pas produire de brouillage;
- (2) L'appareil doit accepter tout brouillage radioélectrique subi, même si le brouillage est susceptible d'en compromettre le fonctionnement.

#### ISED 5G Wi-Fi statement

The user manual for LE-LAN devices shall contain instructions related to the restrictions mentioned in the above sections, namely that:

- i. the device for operation in the band 5150–5250 MHz is only for indoor use to reduce the potential for harmful interference to co-channel mobile satellite systems;

ii. where applicable, antenna type(s), antenna models(s), and worst-case tilt angle(s) necessary to remain compliant with the e.i.r.p. elevation mask requirement set forth in section 6.2.2.3 shall be clearly indicated.

i. le dispositif utilisé dans la bande 5150-5250 MHz est réservé à une utilisation en intérieur afin de réduire le risque de brouillage préjudiciable aux systèmes mobiles par satellite dans le même canal;

ii. le cas échéant, le (s) type (s) d'antenne, le (s) modèle (s) d'antenne et l'angle (s) d'inclinaison le plus défavorable nécessaire (s) pour rester conforme (e) au p.e. L'exigence relative au masque d'élévation énoncée à la section 6.2.2.3 doit être clairement indiquée.

#### Radiation Exposure statement

This equipment complies with FCC/IC RSS-102 radiation exposure limits set forth for an uncontrolled environment. This equipment should be installed and operated with minimum distance 20cm between the radiator and your body.

Cet équipement est conforme aux limites d'exposition aux radiations FCC/IC CNR-102 établies pour un environnement non contrôlé. Cet équipement doit être installé et utilisé avec une distance minimale de 20 cm entre le radiateur et votre corps.

PAX TECHNOLOGY LIMITED reserves the right to change product technology specifications without notifying.



#### PAX TECHNOLOGY LIMITED

**Manufacturer: PAX Computer Technology (Shenzhen) Co., Ltd.**

**Address: 4/F, No.3 Building, Software Park, Second Central Science-Tech Road, High-Tech Industrial Park, Shenzhen, Guangdong, P.R.C.**

**Tel: 0755-86169630 Fax: 0755-86169634**

**Website: <http://www.pax.com.cn>**

**Responsible Party: PAX Technology, Inc.**

**8880 Freedom Crossing Trail, Building 400, 3rd Floor Suite 300, Jacksonville, Florida, 32256**

**Help-desk**

**1 877-859-0099**