

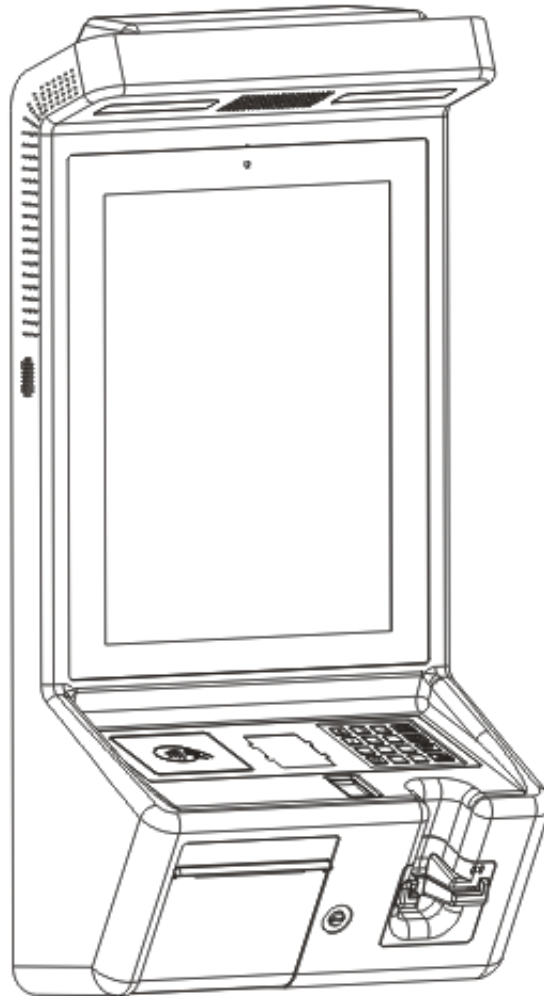

Installation Manual

SK600 Smart Kiosk



Note: Product images shown may be different than actual product received

PAX TECHNOLOGY LIMITED

1、Contents Checklist

Please check the components after unpacking. If any are missing, please contact the dealer.

Part	Qty
SK600 Smart Kiosk	1
SK600 Wall Bracket	1
Printer Key	2
Thermal Paper Roll	1
M4-12 Combination Screw	2
Expansion Screw	6
Plastic Packaging	1
Power Cable	1
Telephone Handle (optional)	1
Product Manual	1

2、Product Description

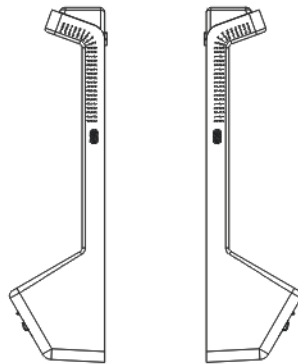

Side View

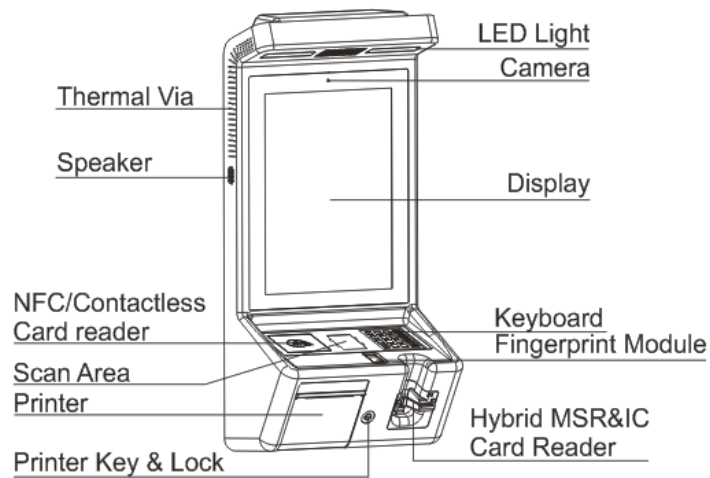

Front View

Thermal Via, Speaker, NFC/Contactless Card reader, Scan Area, Printer, Printer Key & Lock, LED Light, Camera, Display, Keyboard, Fingerprint Module, Hybrid MSR&IC Card Reader

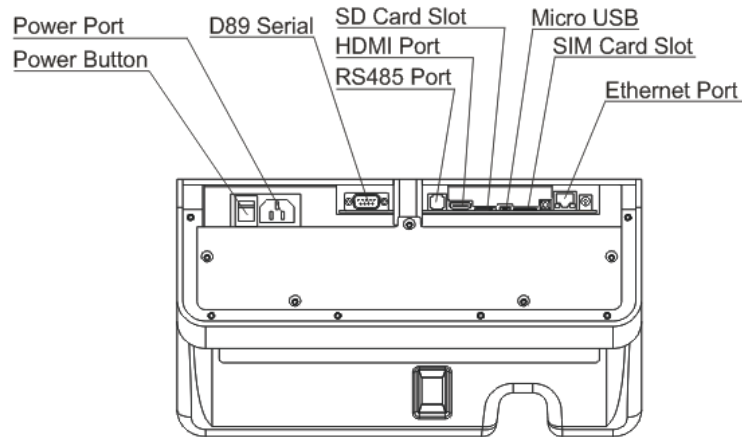

Interface Diagram

Power Port, Power Button, D89 Serial, SD Card Slot, HDMI Port, RS485 Port, Micro USB, SIM Card Slot, Ethernet Port

3、 Operating Instruction

- **Power on:** Plug in the AC power cable and turn on the power button.
- **Contactless module indicator:** Light indication when using the Contactless module.
- **LED working indicator:** Light indication when the device is working at night.
- **Card Readers:**

Magnetic stripe card:

Insert magnetic stripe card into card slot and push to the end with magnetic stripe facing down, then pull out the card at a constant speed to swipe card.

IC chip card:

Insert card with IC chip facing up, then push it to the end of the card slot. Keep the card inserted for 2~4 seconds until the display prompts to remove the card.

Contactless card:

Place the contactless card at the center of contactless card reader logo area.

4、 Specifications

Operating System: Android 6.0

CPU: Quad-Core Cortex A17, 1.8GHz

Memory: 2GB RAM+16GB Flash

Display: 15-inch, Resolution 1024 x 768 pixels, multi-touch Anti-Vandalism capacitive screen

Printer: 3 inch high-speed / mute thermal printer with auto cutter, printer speed: 150mm/S, Printer module is replaceable

Audio: Built-in speaker, support telephone handle (optional)

Camera: 5-mega pixels auto-focus front camera

Fingerprint Module: Capacitive Fingerprint, Image collection 256 * 360 pix (optional)

Wireless communication: LAN(10M/100M/1000M), WIFI(2.4GHz&5GHz), Bluetooth(4.0), 3G/4G

Positioning: GPS, GLONASS, Galileo, QZSS, SBAS

Card Slots:

3. Remove the remaining paper roll.

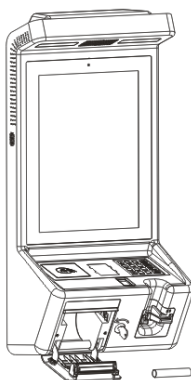

4. Insert the new paper roll into the printer.



5. Pull out the end of the paper so that it extends past the cutting blade, Make sure the paper roll is placed in the direction as shown in the figure below.

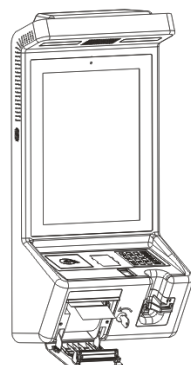

6. Close the printer cover, and pull out the key. Printer will automatically cut off the extra paper, the paper is changed successfully.

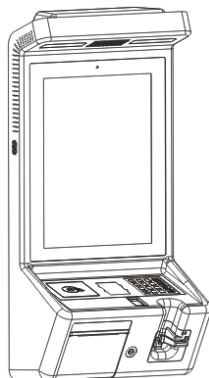

6、Install introduction

- Installation List

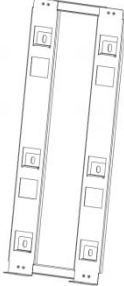
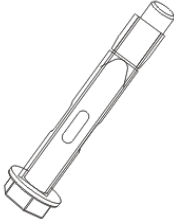
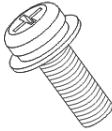
No.	Part	Picture	Qty/pcs
1	SK600Kiosk		1
2	Wall Bracket		1
3	M6-60 Expansion Screw		6
4	M4-12 Combination Screw		2

- Installation Steps

1. Use 6pcs expansion screws to fix the bracket on the wall.
 - Use an 8.0 mm diameter drill bit to drill holes in the wall according to the position of the bracket fixing hole. The le size is shown in the figurebelow:
 - Note: Hole diameter is 8.0mm, Hole depth is above 60.0mm.

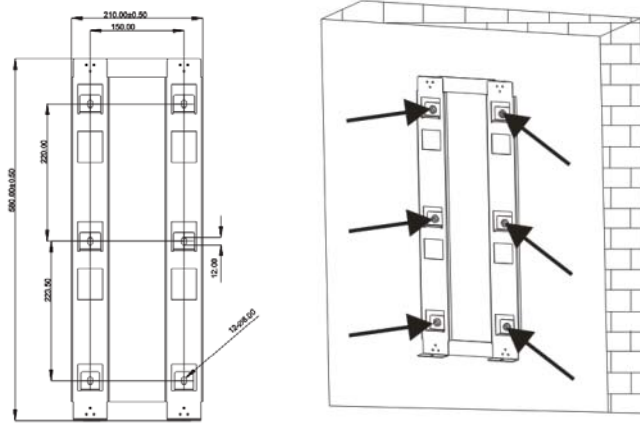

2. Use the 4pcs hooks on the back of the device to hang the whole device on the wall bracket.

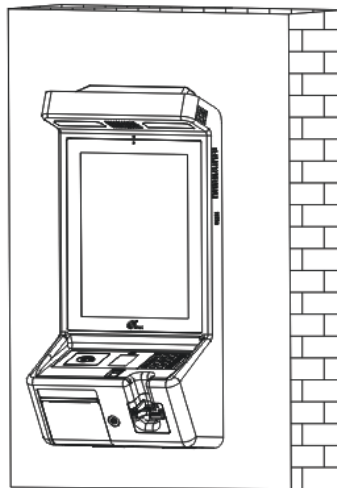

3. Use 2pcs M4-12 combination 3screws to attach the machine to the wall bracket at the bottom of the machine.

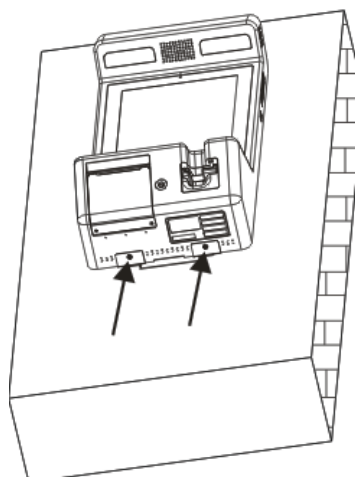

4. The device installation is completed.

7、 Installation and Usage Tips

1) There is no built-in battery, and the device can only be powered by the power adapter.

- 2) Avoid exposing the device in overheated, humid, dusty, or strong electromagnetic environment.
- 3) Do not vibrate, shake, or drop the device.
- 4) Do not insert or unplug any part of the device while it is powered on. Otherwise, it may cause damage to the internal circuit.
- 5) If necessary, please contact PAX technical support for assistance with the device.
- 6) Before using the magnetic stripe /IC/contactless card, check if there is any suspicious person nearby, if so, pay attention to guard against theft.

8、 FCC Regulations:

This device complies with Part 15 of the FCC Rules. Operation is subject to the following two conditions: (1) This device may not cause harmful interference, and (2) this device must accept any interference received, including interference that may cause undesired operation.

This equipment has been tested and found to comply with the limits for a Class B digital device, pursuant to Part 15 of the FCC Rules. These limits are designed to provide reasonable protection against harmful interference in a residential installation. This equipment generates, uses and can radiate radio frequency energy and, if not installed and used in accordance with the instructions, may cause harmful interference to radio communications. However, there is no guarantee that interference will not occur in a particular installation. If this equipment does cause harmful interference to radio or television reception, which can be determined by turning the equipment off and on, the user is encouraged to try to correct the interference by one of the following measures:

- Reorient or relocate the receiving antenna.
- Increase the separation between the equipment and receiver.
- Connect the equipment into an outlet on a circuit different from that to which the receiver is connected.
- Consult the dealer or an experienced radio/TV technician for help.

FCC Caution:

- Any changes or modifications not expressly approved by the party responsible for compliance could void the user's authority to operate this equipment.
- This transmitter must not be co-located or operating in conjunction with any other antenna or transmitter.

Radiation Exposure Statement:

This equipment complies with FCC radiation exposure limits set forth for an uncontrolled environment. This equipment should be installed and operated with minimum distance 20cm between the radiator & your body.

ISED Notice

- ❶ This device complies with Science and Economic Development Canada's license-exempt RSS standard(s). Operation is subject to the following two conditions:
 - 1) this device may not cause interference, and
 - 2) this device must accept any interference, including interference that may cause undesired operation of the device.
- ❶ Le présent appareil est conforme aux CNR d'Industrie Canada applicables aux appareils radio exempts de licence. L'exploitation est autorisée aux deux conditions suivantes:
 - 1) l'appareil ne doit pas produire de brouillage, et
 - 2) l'utilisateur de l'appareil doit accepter tout brouillage radioélectrique subi, même si le brouillage est susceptible d'en compromettre le fonctionnement.
- ❷ This device and its antenna(s) must not be co-located or operating in conjunction with any other antenna or transmitter, except tested built-in radios.
- ❷ Cet appareil et son antenne ne doivent pas être situés ou fonctionner en conjonction avec une autre antenne ou un autre émetteur, exception faites des radios intégrées qui ont été testées.
- ❸ The County Code Selection feature is disabled for products marketed in the US/ Canada.
- ❸ La fonction de sélection de l'indicatif du pays est désactivée pour les produits commercialisés aux États-Unis et au Canada.

Radiation Exposure Statement:

This equipment complies with IC radiation exposure limits set forth for an uncontrolled environment. This equipment should be installed and operated with minimum distance 20cm between the radiator & your body.

Déclaration d'exposition aux radiations:

Cet équipement est conforme aux limites d'exposition aux rayonnements IC établies pour un environnement non contrôlé. Cet équipement doit être installé et utilisé avec un minimum de 20 cm de distance entre la source de rayonnement et votre corps.

The device for operation in the band 5150-5250 MHz is only for indoor use.

les dispositifs fonctionnant dans la bande 5150-5250 MHz sont réservés uniquement pour une utilisation à l'intérieur.

Icon shows



This symbol on power switch indicates "ON" (power)



This symbol on power switch indicates "OFF" (power)



This symbol indicates AC voltage



This product bears the selective sorting symbol for Waste electrical and electronic equipment (WEEE). This means that this product must be handled pursuant to European directive 2012/19/EU in order to be recycled or dismantled to minimize its impact on the environment. User has the choice to give his product to a competent recycling organization or to the retailer when

he buys a new electrical or electronic equipment.

The mains plug is used as the disconnect device, The socket-outlet shall be installed near the equipment and shall be easily accessible.

Warning

To avoid replacement of a battery with an incorrect type

Don't disposal of a battery into fire or a hot oven, or mechanically crushing or cutting of a battery.

Don't leaving a battery in an extremely high temperature surrounding environment

To avoid battery subjected to extremely low air pressure.

- The marking information is located at the bottom of apparatus

- The equipment is only suitable for mounting at heights $\leq 2\text{m}$



- Moving parts Keep body parts away from moving parts

Hereby, PAX Computer Technology (Shenzhen) Co., Ltd. declares that the radio equipment type SK600 is in compliance with Directive 2014/53/EU.

The full text of the EU declaration of conformity is available at the following internet address: <http://www.pax.com.cn/ProductCE.aspx>

PAX TECHNOLOGY LIMITED reserves the right to change product technology specifications without notifying.



PAX TECHNOLOGY LIMITED

Manufacturer: PAX Computer Technology (Shenzhen) Co.,Ltd.

Address:4/F, No.3 Building, Software Park, Second Central Science-Tech Road, High-Tech Industrial Park, Shenzhen, Guangdong, P.R.C.

Tel: 0755-86169630 Fax: 0755-86169634

Website: <http://www.pax.com.cn>

Responsible Party:PAX Technology, Inc.

8880 Freedom Crossing Trail, Building 400, 3rd Floor Suite 300, Jacksonville , Florida, 32256

Help-desk

1 877-859-0099

P/N:200312000000423