

FCC TEST REPORT

(Part 15, Subpart E)



Applicant:	PAX Technology Limited
Address:	Room 2416, 24/F., Sun Hung Kai Centre, 30 Harbour Road, Wanchai, Hong Kong

Manufacturer or Supplier:	PAX Computer Technology (Shenzhen) Co., Ltd.
Address:	4/F, No.3 Building, Software Park, Second Central Science-Tech Road, High-Tech industrial Park, Shenzhen, Guangdong, P.R.C.
Product:	Smart Kiosk
Brand Name:	PAX
Model Name:	SK600
Additional model:	SK800
FCC ID:	V5PSK600
Date of tests:	Apr. 30, 2019 ~ Dec. 05, 2019

The tests have been carried out according to the requirements of the following standard:

FCC Part 15, Subpart E, Section 15.407

CONCLUSION: The submitted sample was found to COMPLY with the test requirement

Prepared by Alex Chen Engineer / Mobile Department	Approved by Luke Lu Manager / Mobile Department
 Date: Dec. 10, 2019	 Date: Dec. 10, 2019

This report is governed by, and incorporates by reference, CPS Conditions of Service as posted at the date of issuance of this report at <http://www.bureauveritas.com/home/about-us/our-business/cps/about-us/terms-conditions> and is intended for your exclusive use. Any copying or replication of this report to or for any other person or entity, or use of our name or trademark, is permitted only with our prior written permission. This report sets forth our findings solely with respect to the test samples identified herein. The results set forth in this report are not indicative or representative of the quality or characteristics of the lot from which a test sample was taken or any similar or identical product unless specifically and expressly noted. Our report includes all of the tests requested by you and the results thereof based upon the information that you provided to us. Measurement uncertainty is only provided upon request for accredited tests. You have 60 days from date of issuance of this report to notify us of any material error or omission caused by our negligence or if you require measurement uncertainty; provided, however, that such notice shall be in writing and shall specifically address the issue you wish to raise. A failure to raise such issue within the prescribed time shall constitute your unqualified acceptance of the completeness of this report, the tests conducted and the correctness of the report contents.



TABLE OF CONTENTS

RELEASE CONTROL RECORD 4

1 SUMMARY OF TEST RESULTS..... 5

1.1 MEASUREMENT UNCERTAINTY 5

2 GENERAL INFORMATION 6

2.1 GENERAL DESCRIPTION OF EUT 6

2.2 DESCRIPTION OF TEST MODES 8

2.2.1 TEST MODE APPLICABILITY AND TESTED CHANNEL DETAIL..... 10

2.3 DUTY CYCLE OF TEST SIGNAL 13

2.4 DESCRIPTION OF SUPPORT UNITS 14

2.4.1 CONFIGURATION OF SYSTEM UNDER TEST 14

2.5 GENERAL DESCRIPTION OF APPLIED STANDARDS 15

3 TEST TYPES AND RESULTS..... 16

3.1 RADIATED EMISSION AND BANDEDGE MEASUREMENT 16

3.1.1 LIMITS OF RADIATED EMISSION AND BANDEDGE MEASUREMENT..... 16

3.1.2 LIMITS OF UNWANTED EMISSION 17

3.1.3 TEST INSTRUMENTS 18

3.1.4 TEST PROCEDURES 19

3.1.5 DEVIATION FROM TEST STANDARD 19

3.1.6 TEST SETUP 20

3.1.7 EUT OPERATING CONDITION 20

3.1.8 TEST RESULTS 21

3.2 CONDUCTED EMISSION MEASUREMENT 70

3.2.1 LIMITS OF CONDUCTED EMISSION MEASUREMENT 70

3.2.2 TEST INSTRUMENTS 70

3.2.3 TEST PROCEDURES 70

3.2.4 DEVIATION FROM TEST STANDARD 71

3.2.5 TEST SETUP 71

3.2.6 EUT OPERATING CONDITIONS 71

3.2.7 TEST RESULTS 72

3.3 MAXIMUM CONDUCTED OUTPUT POWER MEASUREMENT 76

3.3.1 LIMITS OF MAXIMUM CONDUCTED OUTPUT POWER MEASUREMENT 76

3.3.2 TEST SETUP 77



3.3.3	TEST INSTRUMENTS.....	77
3.3.4	TEST PROCEDURE.....	78
3.3.5	DEVIATION FROM TEST STANDARD	80
3.3.6	EUT OPERATING CONDITIONS	80
3.3.7	TEST RESULTS	81
3.4	MAXIMUM POWER SPECTRAL DENSITY MEASUREMENT.....	94
3.4.1	LIMITS OF MAXIMUM POWER SPECTRAL DENSITY MEASUREMENT	94
3.4.2	TEST SETUP	94
3.4.3	TEST INSTRUMENTS.....	94
3.4.4	TEST PROCEDURES	95
3.4.5	DEVIATION FROM TEST STANDARD	95
3.4.6	EUT OPERATING CONDITIONS	95
3.4.7	TEST RESULTS	96
3.5	FREQUENCY STABILITY	103
3.5.1	LIMITS OF FREQUENCY STABILITY MEASUREMENT	103
3.5.2	TEST SETUP	103
3.5.3	TEST INSTRUMENTS.....	103
3.5.4	TEST PROCEDURE.....	104
3.5.5	DEVIATION FROM TEST STANDARD	104
3.5.6	EUT OPERATING CONDITION	104
3.5.7	TEST RESULTS	105
4	PHOTOGRAPHS OF THE TEST CONFIGURATION.....	107
5	APPENDIX A – MODIFICATIONS RECORDERS FOR ENGINEERING CHANGES TO THE EUT BY THE LAB.....	108



RELEASE CONTROL RECORD

ISSUE NO.	REASON FOR CHANGE	DATE ISSUED
RF190429W001-3	Original release	Jul. 11, 2019
RF191120W002-3	Based on the original product add one model SK800, changed power module. In this report verify RSE&CE worst case, other test date is copied from the original test report RF190429W001-3.	Dec. 10, 2019



1 SUMMARY OF TEST RESULTS

The EUT has been tested according to the following specifications:

APPLIED STANDARD: FCC PART 15, SUBPART E (SECTION 15.407)			
STANDARD SECTION	TEST TYPE AND LIMIT	RESULT	REMARK
15.407(b)(5)	AC Power Conducted Emission	PASS	Meet the requirement of limit. Minimum passing margin is -6.06dB at 0.408000MHz.
15.407(b) (1/2/3/4/6)	Radiated Emission & Band Edge Measurement	PASS	Meet the requirement of limit. Minimum passing margin is 2.68dB at 5725MHz.
15.407(a/1/2/3)	Maximum conducted output Power	PASS	Meet the requirement of limit.
15.407(a/1/2/3)	Peak Power Spectral Density	PASS	Meet the requirement of limit.
15.407(e)	6 dB Bandwidth	PASS	Meet the requirement of limit. (U-NII-3 Band only)
15.407(g)	Frequency Stability	PASS	Meet the requirement of limit.
15.203	Antenna Requirement	PASS	No antenna connector is used.

1.1 MEASUREMENT UNCERTAINTY

Where relevant, the following measurement uncertainty levels have been estimated for tests performed on the EUT as specified in CISPR 16-4-2:

MEASUREMENT	UNCERTAINTY
AC Power Conducted emissions	± 2.70dB
All Radiated emissions	±4.48dB
Conducted emissions	±2 dB
Occupied Channel Bandwidth	±21.7KHz
Conducted Output power	±1.03 dB
Power Spectral Density	±0.95 dB

This uncertainty represents an expanded uncertainty expressed at approximately the 95% confidence level using a coverage factor of k = 2.



2 GENERAL INFORMATION

2.1 GENERAL DESCRIPTION OF EUT

EUT	Smart Kiosk
BRAND NAME	PAX
MODEL NAME	SK600
ADDITIONAL MODEL	SK800
POWER SUPPLY	AC 120V
MODULATION TYPE	64QAM, 16QAM, QPSK, BPSK
MODULATION TECHNOLOGY	OFDM
TRANSFER RATE	802.11a: 54.0/ 48.0/ 36.0/ 24.0/ 18.0/ 12.0/ 9.0/ 6.0Mbps 802.11n: up to MCS7 802.11ac: up to 390.0Mbps
OPERATING FREQUENCY	5180 ~ 5240MHz, 5260 ~ 5320MHz, 5500 ~ 5700MHz, 5745 ~ 5825MHz
NUMBER OF CHANNEL	5180 ~ 5240MHz: 4 for 802.11a, 802.11n (20MHz) 2 for 802.11n (40MHz) 1 for 802.11ac (80MHz) 5260 ~ 5320MHz: 4 for 802.11a, 802.11n (20MHz) 2 for 802.11n (40MHz) 1 for 802.11ac (80MHz) 5500 ~ 5700MHz: 8 for 802.11a, 802.11n (20MHz) 3 for 802.11n (40MHz) 1 for 802.11ac (80MHz) 5745 ~ 5825MHz: 4 for 802.11a, 802.11n (20MHz) 2 for 802.11n (40MHz) 1 for 802.11ac (80MHz)
AVERAGE POWER	27.164mW for 5180 ~ 5240MHz 26.062mW for 5260 ~ 5320MHz 26.730mW for 5500 ~ 5700MHz 28.054mW for 5745 ~ 5825MHz
ANTENNA TYPE	5180 ~ 5240MHz: PIFA Antenna with 6.04dBi gain 5260 ~ 5320MHz: PIFA Antenna with 5.79dBi gain 5500 ~ 5700MHz: PIFA Antenna with 5.25dBi gain 5745 ~ 5825MHz: PIFA Antenna with 4.75dBi gain
HW VERSION	N/A
SW VERSION	N/A
I/O PORTS	Refer to user's manual



CABLE SUPPLIED	Refer to note as below
-----------------------	------------------------

NOTE:

- For a more detailed features description, please refer to the manufacturer’s specifications or the user’s manual.
- The hardware differences between SK800 with SK600:

Product size and weight	
SK600	Size: 660 x325 x 178 (mm) Weight: 7.8kg
SK800	Size: 965x 390x 175 (mm) Weight: 13kg

Product screen size	
SK600	screen size: 15"
SK800	screen size: 23.8"

Except Listings above, the others are the same.

- The EUT incorporates a SISO function. Physically, the EUT provides one completed transmitter and one receiver.

MODULATION MODE	TX FUNCTION
802.11a	1TX/1RX
802.11n (20MHz)	1TX/1RX
802.11n (40MHz)	1TX/1RX
802.11ac (80MHz)	1TX/1RX

- For the test results, the EUT had been tested with all conditions. But only the worst case was shown in test report.



2.2 DESCRIPTION OF TEST MODES

FOR 5150 ~ 5250MHz

4 channels are provided for 802.11a, 802.11n (20MHz):

CHANNEL	FREQUENCY	CHANNEL	FREQUENCY
36	5180 MHz	44	5220 MHz
40	5200 MHz	48	5240 MHz

2 channels are provided for 802.11n (40MHz):

CHANNEL	FREQUENCY	CHANNEL	FREQUENCY
38	5190 MHz	46	5230 MHz

1 channel is provided for 802.11ac (80MHz):

CHANNEL	FREQUENCY	CHANNEL	FREQUENCY
42	5210 MHz		

FOR 5250 ~ 5350MHz

4 channels are provided for 802.11a, 802.11n (20MHz):

CHANNEL	FREQUENCY	CHANNEL	FREQUENCY
52	5260 MHz	60	5300 MHz
56	5280 MHz	64	5320 MHz

2 channels are provided for 802.11n (40MHz):

CHANNEL	FREQUENCY	CHANNEL	FREQUENCY
54	5270 MHz	62	5310 MHz

1 channel is provided for 802.11ac (80MHz):

CHANNEL	FREQUENCY	CHANNEL	FREQUENCY
58	5290 MHz		



FOR 5470 ~ 5725MHz

8 channels are provided for 802.11a, 802.11n (20MHz):

CHANNEL	FREQUENCY	CHANNEL	FREQUENCY
100	5500 MHz	116	5580 MHz
104	5520 MHz	132	5660 MHz
108	5540 MHz	136	5680 MHz
112	5560 MHz	140	5700 MHz

3 channels are provided for 802.11n (40MHz):

CHANNEL	FREQUENCY	CHANNEL	FREQUENCY
102	5510 MHz	134	5670 MHz
110	5550 MHz		

1 channel is provided for 802.11ac (80MHz):

CHANNEL	FREQUENCY	CHANNEL	FREQUENCY
106	5530 MHz		

FOR 5725 ~ 5825MHz

4 channels are provided for 802.11a, 802.11n (20MHz):

CHANNEL	FREQUENCY	CHANNEL	FREQUENCY
149	5745 MHz	157	5785 MHz
153	5765 MHz	165	5825 MHz

2 channels are provided for 802.11n (40MHz):

CHANNEL	FREQUENCY	CHANNEL	FREQUENCY
151	5755 MHz	159	5795 MHz

1 channel is provided for 802.11ac (80MHz):

CHANNEL	FREQUENCY	CHANNEL	FREQUENCY
155	5775 MHz		



2.2.1 TEST MODE APPLICABILITY AND TESTED CHANNEL DETAIL

EUT CONFIGURE MODE	APPLICABLE TO				DESCRIPTION
	RE≥1G	RE<1G	PLC	APCM	
A	√	√	√	-	Powered by Adapter with wifi(5G) link
B	-	-	-	√	Powered by Battery with wifi(5G) link
C	-	-	-	-	Powered by USB with wifi(5G) link

Where **RE≥1G**: Radiated Emission above 1GHz **RE<1G**: Radiated Emission below 1GHz
PLC: Power Line Conducted Emission **APCM**: Antenna Port Conducted Measurement

NOTE:
The EUT had been pre-tested on the positioned of each 3 axis. The worst case was found when positioned on **X-plane**.
NOTE: "-" means no effect.

RADIATED EMISSION TEST (ABOVE 1GHz):

- Pre-Scan has been conducted to determine the worst-case mode from all possible combinations between available modulations, data rates and antenna ports (if EUT with antenna diversity architecture).
- Following channel(s) was (were) selected for the final test as listed below.

EUT CONFIGURE MODE	MODE	FREQ. BAND (MHz)	AVAILABLE CHANNEL	TESTED CHANNEL	MODULATION TECHNOLOGY	MODULATION TYPE	DATA RATE (Mbps)
A	802.11a	5180-5240	36 to 48	36, 40, 48	OFDM	BPSK	6.0
A	802.11n (20MHz)		36 to 48	36, 40, 48	OFDM	BPSK	MCS0
A	802.11n (40MHz)		38 to 46	38, 46	OFDM	BPSK	MCS0
A	802.11ac (80MHz)		42	42	OFDM	BPSK	V0
A	802.11a	5260-5320	52 to 64	52, 60, 64	OFDM	BPSK	6.0
A	802.11n (20MHz)		52 to 64	52, 60, 64	OFDM	BPSK	MCS0
A	802.11n (40MHz)		54 to 62	54, 62	OFDM	BPSK	MCS0
A	802.11ac (80MHz)		58	58	OFDM	BPSK	V0
A	802.11a	5500-5700	100 to 140	100, 116, 140	OFDM	BPSK	6.0
A	802.11n (20MHz)		100 to 140	100, 116, 140	OFDM	BPSK	MCS0
A	802.11n (40MHz)		102 to 134	102, 110, 134	OFDM	BPSK	MCS0
A	802.11ac (80MHz)		106	106	OFDM	BPSK	V0
A	802.11a	5725-5825	149 to 165	149, 157, 165	OFDM	BPSK	6.0
A	802.11n (20MHz)		149 to 165	149, 157, 165	OFDM	BPSK	MCS0
A	802.11n (40MHz)		151 to 159	151, 159	OFDM	BPSK	MCS0
A	802.11ac (80MHz)		155	155	OFDM	BPSK	V0



RADIATED EMISSION TEST (BELOW 1GHz):

- Pre-Scan has been conducted to determine the worst-case mode from all possible combinations between available modulations, data rates and antenna ports (if EUT with antenna diversity architecture).
- Following channel(s) was (were) selected for the final test as listed below.

EUT CONFIGURE MODE	MODE	FREQ. BAND (MHz)	AVAILABLE CHANNEL	TESTED CHANNEL	MODULATION TECHNOLOGY	MODULATION TYPE	DATA RATE (Mbps)
A	802.11a	5500-5700	100 to 140	140	OFDM	BPSK	6.0

POWER LINE CONDUCTED EMISSION TEST:

- Pre-Scan has been conducted to determine the worst-case mode from all possible combinations between available modulations, data rates and antenna ports (if EUT with antenna diversity architecture).
- Following channel(s) was (were) selected for the final test as listed below.

EUT CONFIGURE MODE	MODE	FREQ. BAND (MHz)	AVAILABLE CHANNEL	TESTED CHANNEL	MODULATION TECHNOLOGY	MODULATION TYPE	DATA RATE (Mbps)
A	802.11a	5500-5700	100 to 140	140	OFDM	BPSK	6.0

BANDEDGE MEASUREMENT:

- Pre-Scan has been conducted to determine the worst-case mode from all possible combinations between available modulations, data rates and antenna ports (if EUT with antenna diversity architecture).
- Following channel(s) was (were) selected for the final test as listed below.

EUT CONFIGURE MODE	MODE	FREQ. BAND (MHz)	AVAILABLE CHANNEL	TESTED CHANNEL	MODULATION TECHNOLOGY	MODULATION TYPE	DATA RATE (Mbps)
A	802.11a	5180-5240	36 to 48	36, 40, 48	OFDM	BPSK	6.0
A	802.11n (20MHz)		36 to 48	36, 40, 48	OFDM	BPSK	MCS0
A	802.11n (40MHz)		38 to 46	38, 46	OFDM	BPSK	MCS0
A	802.11ac (80MHz)		42	42	OFDM	BPSK	V0
A	802.11a	5260-5320	52 to 64	52, 60, 64	OFDM	BPSK	6.0
A	802.11n (20MHz)		52 to 64	52, 60, 64	OFDM	BPSK	MCS0
A	802.11n (40MHz)		54 to 62	54, 62	OFDM	BPSK	MCS0
A	802.11ac (80MHz)		58	58	OFDM	BPSK	V0
A	802.11a	5500-5700	100 to 140	100, 116, 140	OFDM	BPSK	6.0
A	802.11n (20MHz)		100 to 140	100, 116, 140	OFDM	BPSK	MCS0
A	802.11n (40MHz)		102 to 134	102, 110, 134	OFDM	BPSK	MCS0
A	802.11ac (80MHz)		106	106	OFDM	BPSK	V0
A	802.11a	5725-5825	149 to 165	149, 157, 165	OFDM	BPSK	6.0
A	802.11n (20MHz)		149 to 165	149, 157, 165	OFDM	BPSK	MCS0
A	802.11n (40MHz)		151 to 159	151, 159	OFDM	BPSK	MCS0
A	802.11ac (80MHz)		155	155	OFDM	BPSK	V0

**ANTENNA PORT CONDUCTED MEASUREMENT:**

- This item includes all test value of each mode, but only includes spectrum plot of worst value of each mode.
- Pre-Scan has been conducted to determine the worst-case mode from all possible combinations between available modulations, data rates and antenna ports (if EUT with antenna diversity architecture).
- Following channel(s) was (were) selected for the final test as listed below.

EUT CONFIGURE MODE	MODE	FREQ. BAND (MHz)	AVAILABLE CHANNEL	TESTED CHANNEL	MODULATION TECHNOLOGY	MODULATION TYPE	DATA RATE (Mbps)
A	802.11a	5180-5240	36 to 48	36, 40, 48	OFDM	BPSK	6.0
A	802.11n (20MHz)		36 to 48	36, 40, 48	OFDM	BPSK	MCS0
A	802.11n (40MHz)		38 to 46	38, 46	OFDM	BPSK	MCS0
A	802.11ac (80MHz)		42	42	OFDM	BPSK	V0
A	802.11a	5260-5320	52 to 64	52, 60, 64	OFDM	BPSK	6.0
A	802.11n (20MHz)		52 to 64	52, 60, 64	OFDM	BPSK	MCS0
A	802.11n (40MHz)		54 to 62	54, 62	OFDM	BPSK	MCS0
A	802.11ac (80MHz)		58	58	OFDM	BPSK	V0
A	802.11a	5500-5700	100 to 140	100, 116, 140	OFDM	BPSK	6.0
A	802.11n (20MHz)		100 to 140	100, 116, 140	OFDM	BPSK	MCS0
A	802.11n (40MHz)		102 to 134	102, 110, 134	OFDM	BPSK	MCS0
A	802.11ac (80MHz)		106	106	OFDM	BPSK	V0
A	802.11a	5725-5825	149 to 165	149, 157, 165	OFDM	BPSK	6.0
A	802.11n (20MHz)		149 to 165	149, 157, 165	OFDM	BPSK	MCS0
A	802.11n (40MHz)		151 to 159	151, 159	OFDM	BPSK	MCS0
A	802.11ac (80MHz)		155	155	OFDM	BPSK	V0

TEST CONDITION:

APPLICABLE TO	ENVIRONMENTAL CONDITIONS	INPUT POWER	TESTED BY
RE<1G	23deg. C, 62%RH	AC 120V	Star Le&Allen Xiong
RE≥1G	23deg. C, 62%RH	AC 120V	Star Le&Allen Xiong
PLC	24deg. C, 61%RH	AC 120V	John Wen&Tony Xiong
APCM	23.5deg. C, 60%RH	AC 120V	Rain Wang



2.3 DUTY CYCLE OF TEST SIGNAL

Duty cycle of test signal is < 98%, duty factor shall be considered.

802.11a: Duty cycle = 0.173/0.226=0.765, Duty factor = 10 * log(1/0.765) = 1.16

802.11n (20MHz): Duty cycle = 0.158/0.211 = 0.715, Duty factor = 10 * log(1/0.715) = 1.46

802.11n (40MHz): Duty cycle = 0.097/0.150 = 0.647, Duty factor = 10 * log(1/0.647) = 1.89

802.11ac (80MHz): Duty cycle = 0.061/0.114 = 0.535, Duty factor = 10 * log(1/0.535) = 2.71





2.4 DESCRIPTION OF SUPPORT UNITS

The EUT has been tested as an independent unit together with other necessary accessories or support units. The following support units or accessories were used to form a representative test configuration during the tests.

NO.	PRODUCT	BRAND	MODEL NO.	SERIAL NO.	FCC ID
1	DC source	LONG WEI	PS-6403D	010934269	N/A
2	PC	HP	A6608CN	3CR83825X3	N/A

NO.	SIGNAL CABLE DESCRIPTION OF THE ABOVE SUPPORT UNITS
1	DC Line: Unshielded, Detachable 1.0m
2	AC Line: Unshielded, Detachable 1.5m

NOTE:

1. All power cords of the above support units are non shielded (1.8m).

2.4.1 CONFIGURATION OF SYSTEM UNDER TEST

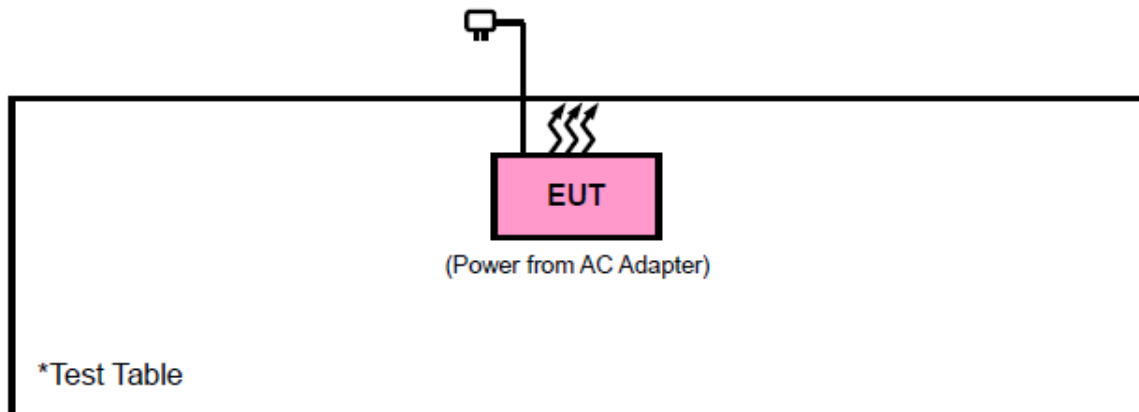



2.5 GENERAL DESCRIPTION OF APPLIED STANDARDS

The EUT is a RF Product. According to the specifications of the manufacturer, it must comply with the requirements of the following standards:

FCC Part 15, Subpart E (15.407)

KDB 789033 D02 General U-NII Test Procedures New Rules v02r01

ANSI C63.10-2013

All test items have been performed and recorded as per the above standards.

NOTE: The EUT is also considered as a kind of computer peripheral, because the connection to computer is necessary for typical use. It has been verified to comply with the requirements of FCC Part 15, Subpart B, Class B (Certification). The test report has been issued separately.



3 TEST TYPES AND RESULTS

3.1 RADIATED EMISSION AND BANDEDGE MEASUREMENT

3.1.1 LIMITS OF RADIATED EMISSION AND BANDEDGE MEASUREMENT

Radiated emissions which fall in the restricted bands must comply with the radiated emission limits specified as below table:

FREQUENCIES (MHz)	FIELD STRENGTH (microvolts/meter)	MEASUREMENT DISTANCE (meters)
0.009 ~ 0.490	2400/F(kHz)	300
0.490 ~ 1.705	24000/F(kHz)	30
1.705 ~ 30.0	30	30
30 ~ 88	100	3
88 ~ 216	150	3
216 ~ 960	200	3
Above 960	500	3

NOTE:

1. The lower limit shall apply at the transition frequencies.
2. Emission level (dBuV/m) = 20 log Emission level (uV/m).
3. For frequencies above 1000MHz, the field strength limits are based on average detector, however, the peak field strength of any emission shall not exceed the maximum permitted average limits, specified above by more than 20dB under any condition of modulation.



3.1.2 LIMITS OF UNWANTED EMISSION

RESTRICTED BANDS	APPLICABLE TO	LIMIT	
	789033 D02 General UNII Test Procedures New Rules v01r02	FIELD STRENGTH AT 3m (dBµV/m)	
		PK : 74	AV : 54
OUT OF THE RESTRICTED BANDS	APPLICABLE TO	EIRP LIMIT (dBm/MHz)	EQUIVALENT FIELD STRENGTH AT 3m (dBµV/m)
	15.407(b)(1)	PK : -27	PK : 68.3
	15.407(b)(2)		
	15.407(b)(3)		
	15.407(b)(4)	See note 2 (FCC 16-24)	

NOTE: The following formula is used to convert the equipment isotropic radiated power (eirp) to field strength:

$$E = \frac{1000000\sqrt{30P}}{3} \mu\text{V/m, where P is the eirp (Watts).}$$

2. All emissions shall be limited to a level of -27 dBm/MHz at 75 MHz or more above or below the band edge increasing linearly to 10 dBm/MHz at 25 MHz above or below the band edge, and from 25 MHz above or below the band edge increasing linearly to a level of 15.6 dBm/MHz at 5 MHz above or below the band edge, and from 5 MHz above or below the band edge increasing linearly to a level of 27 dBm/MHz at the band edge.



3.1.3 TEST INSTRUMENTS

Equipment	Manufacturer	Model No.	Serial No.	Last Cal.	Next Cal.
3m Semi-anechoic Chamber	ETS-LINDGREN	9m*6m*6m	Euroshieldpn-CT0001143-1216	Feb. 26,19	Feb. 25,20
Bilog Antenna	ETS-LINDGREN	3143B	00161965	Feb. 26,19	Feb. 25,20
Horn Antenna	ETS-LINDGREN	3117	00168728	Feb. 26,19	Feb. 25,20
Horn Antenna (18GHz-40GHz)	N/A	QWH-SL-18-40-K-SG/QMS-00361	15433	Nov. 24, 19	Nov. 23, 20
Test Software	E3	V 9.160323	N/A	N/A	N/A
Test Software	ADT	ADT_Radiated_V7.6.15.9.2	N/A	N/A	N/A
10dB Attenuator	JFW/USA	50HF-010-SMA	1505	Jun. 24,19	Jun. 23,20
MXE EMI Receiver	KEYSIGHT	N9038A-544	MY54450026	Feb. 26,19	Feb. 25,20
Signal Pre-Amplifier	EMSI	EMC 9135	980249	Jun. 24,19	Jun. 23,20
Signal Pre-Amplifier	EMSI	EMC 012645B	980257	Jun. 24,19	Jun. 23,20
Signal Pre-Amplifier	EMSI	EMC 184045B	980259	Jun. 24,19	Jun. 23,20

NOTE:

1. The calibration interval of the above test instruments is 12 months and the calibrations are traceable to CEPREI/CHINA, GRGT/CHINA and NIM/CHINA.
2. The test was performed in 3m Chamber.
3. The FCC Site Registration No. is 525120; The Designation No. is CN1171.



3.1.4 TEST PROCEDURES

- a. The EUT was placed on the top of a rotating table 0.8 meters (for below 1GHz) / 1.5 meters (for above 1GHz) above the ground at 3 meter chamber room for test. The table was rotated 360 degrees to determine the position of the highest radiation.
- b. The EUT was set 3 meters away from the interference-receiving antenna, which was mounted on the top of a variable-height antenna tower.
- c. The antenna is a broadband antenna, and its height is varied from one meter to four meters above the ground to determine the maximum value of the field strength. Both horizontal and vertical polarizations of the antenna are set to make the measurement.
- d. For each suspected emission, the EUT was arranged to its worst case and then the antenna was tuned to heights from 1 meter to 4 meters and the rotatable table was turned from 0 degrees to 360 degrees to find the maximum reading.
- e. The test-receiver system was set to Peak Detect Function and Specified Bandwidth with Maximum Hold Mode.
- f. If the emission level of the EUT in peak mode was 10dB lower than the limit specified, then testing could be stopped and the peak values of the EUT would be reported. Otherwise the emissions that did not have 10dB margin would be re-tested one by one using peak, quasi-peak or average method as specified and then reported in a data sheet.

NOTE:

1. The resolution bandwidth and video bandwidth of test receiver/spectrum analyzer is 120kHz for Peak detection (PK) and Quasi-peak detection (QP) at frequency below 1GHz.
2. The resolution bandwidth of test receiver/spectrum analyzer is 1MHz and video bandwidth is 3MHz for Peak detection at frequency above 1GHz.
3. The resolution bandwidth of test receiver/spectrum analyzer is 1MHz and the video bandwidth is 10Hz for Average detection (AV) at frequency above 1GHz.
4. All modes of operation were investigated and the worst-case emissions are reported.

3.1.5 DEVIATION FROM TEST STANDARD

No deviation.



3.1.6 TEST SETUP

< Frequency Range 30MHz~1GHz >

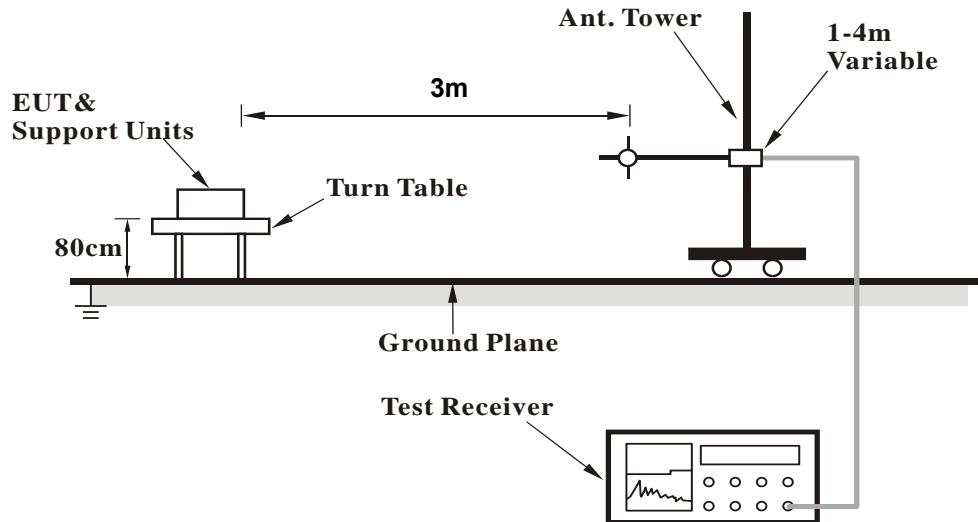

<Frequency Range above 1GHz>

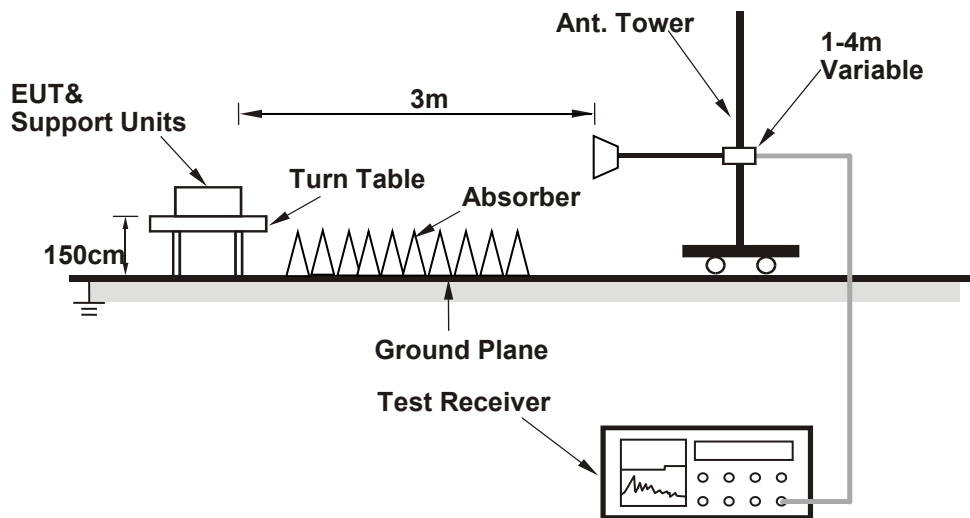

For the actual test configuration, please refer to the attached file (Test Setup Photo).

3.1.7 EUT OPERATING CONDITION

- Set the EUT under full load condition and placed them on a testing table.
- Set the transmitter part of EUT under transmission condition continuously at specific channel frequency.
- The necessary accessories enable the EUT in full functions.



3.1.8 TEST RESULTS

SK600

BELOW 1GHz WORST-CASE DATA:

30 MHz – 1GHz data:

802.11a

CHANNEL	TX Channel 140	DETECTOR FUNCTION	Quasi-Peak (QP)
FREQUENCY RANGE	30MHz ~ 1GHz		

ANTENNA POLARITY & TEST DISTANCE: HORIZONTAL AT 3 M										
FREQ. (MHz)	EMISSION LEVEL (dBuV/m)	READ LEVEL (dBuV)	LIMIT (dBuV/m)	MARGIN (dB)	ANTENNA FACTOR (dB /m)	CABLE LOSS (dB)	PREAMP FACTOR (dB)	ANTENNA HEIGHT (cm)	TABLE ANGLE (Degree)	REMARK
56.21	18.75	48.51	40	-21.25	6.44	1.14	37.34	100	360	QP
125.32	28.62	56.35	43.5	-14.88	7.46	1.72	36.91	100	360	QP
189.75	27.95	52.46	43.5	-15.55	10	2.11	36.62	100	360	QP
258.63	25.01	46.53	46	-20.99	12.5	2.5	36.52	100	360	QP
325.64	30.21	49.86	46	-15.79	14.08	2.83	36.56	100	360	QP
485.67	24.37	39.65	46	-21.63	18.23	3.42	36.93	100	360	QP

REMARKS:

1. Emission level (dBuV/m) = Raw Value (dBuV) + Correction Factor (dB/m).
2. Correction Factor (dB/m) = Antenna Factor (dB/m) + Cable Factor (dB).
3. The other emission levels were very low against the limit.
4. Margin value = Emission level – Limit value.

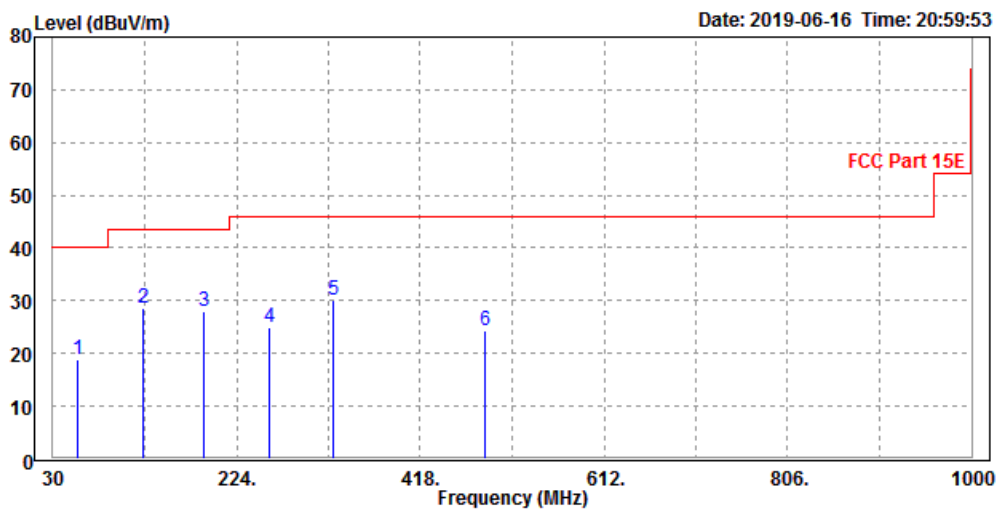



CHANNEL	Channel 140	DETECTOR FUNCTION	Quasi-Peak (QP)
FREQUENCY RANGE	30MHz ~ 1GHz		

ANTENNA POLARITY & TEST DISTANCE: VERTICAL AT 3 M										
FREQ. (MHz)	EMISSION LEVEL (dBuV/m)	READ LEVEL (dBuV)	LIMIT (dBuV/m)	MARGIN (dB)	ANTENNA FACTOR (dB /m)	CABLE LOSS (dB)	PREAMP FACTOR (dB)	ANTENNA HEIGHT (cm)	TABLE ANGLE (Degree)	REMARK
48.52	24.33	53.62	40	-15.67	7.05	1.06	37.4	100	0	QP
125.42	23.51	51.24	43.5	-19.99	7.46	1.72	36.91	100	0	QP
189.65	26.77	51.28	43.5	-16.73	10	2.11	36.62	100	0	QP
362.31	37.84	55.87	46	-8.16	15.62	2.99	36.64	100	0	QP
452.31	35.57	51.28	46	-10.43	17.83	3.31	36.85	100	0	QP
489.65	30.28	45.51	46	-15.72	18.28	3.43	36.94	100	0	QP

REMARKS:

1. Emission level (dBuV/m) = Raw Value (dBuV) + Correction Factor (dB/m).
2. Correction Factor (dB/m) = Antenna Factor (dB/m) + Cable Factor (dB).
3. The other emission levels were very low against the limit.
4. Margin value = Emission level – Limit value.

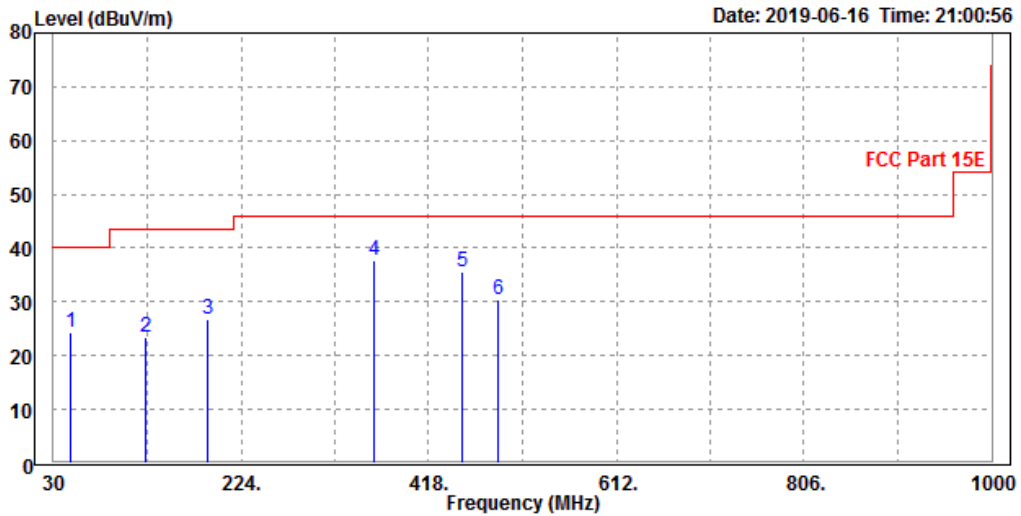



ABOVE 1GHz WORST-CASE DATA:

Note: For higher frequency, the emission is too low to be detected.

Band 1

802.11a

CHANNEL	TX Channel 36	DETECTOR FUNCTION	Peak (PK)
FREQUENCY RANGE	1GHz ~ 40GHz		Average (AV)

ANTENNA POLARITY & TEST DISTANCE: HORIZONTAL AT 3 M										
FREQ. (MHz)	EMISSION LEVEL (dBuV/m)	READ LEVEL (dBuV)	LIMIT (dBuV/m)	MARGIN (dB)	ANTENNA FACTOR (dB /m)	CABLE LOSS (dB)	PREAMP FACTOR (dB)	ANTENNA HEIGHT (cm)	TABLE ANGLE (Degree)	REMARK
5150	52.72	51.24	74	-21.28	35.95	7.42	41.89	100	328	Peak
5150	42.71	41.23	54	-11.29	35.95	7.42	41.89	100	328	Average
5180	89.78	88.26			35.98	7.43	41.89	100	328	Peak
5180	80.16	78.64			35.98	7.43	41.89	100	328	Average
5350	52.85	51.12	74	-21.15	36.15	7.47	41.89	100	328	Peak
5350	44.04	42.31	54	-9.96	36.15	7.47	41.89	100	328	Average
ANTENNA POLARITY & TEST DISTANCE: VERTICAL AT 3 M										
FREQ. (MHz)	EMISSION LEVEL (dBuV/m)	READ LEVEL (dBuV)	LIMIT (dBuV/m)	MARGIN (dB)	ANTENNA FACTOR (dB /m)	CABLE LOSS (dB)	PREAMP FACTOR (dB)	ANTENNA HEIGHT (cm)	TABLE ANGLE (Degree)	REMARK
5150	56.03	54.21	74	-17.97	36.29	7.42	41.89	100	5	Peak
5150	45.08	43.26	54	-8.92	36.29	7.42	41.89	100	5	Average
5180	92.15	90.3			36.31	7.43	41.89	100	5	Peak
5180	81.49	79.64			36.31	7.43	41.89	100	5	Average
5350	54.33	52.34	74	-19.67	36.41	7.47	41.89	100	5	Peak
5350	44.66	42.67	54	-9.34	36.41	7.47	41.89	100	5	Average

REMARKS:

- Emission Level = Read Level+ Antenna Factor + Cable Loss- Preamp Factor
Margin value = Emission level – Limit value.
- 5180MHz: Fundamental frequency.



CHANNEL	TX Channel 40	DETECTOR FUNCTION	Peak (PK)
FREQUENCY RANGE	1GHz ~ 40GHz		Average (AV)

ANTENNA POLARITY & TEST DISTANCE: HORIZONTAL AT 3 M										
FREQ. (MHz)	EMISSION LEVEL (dBuV/m)	READ LEVEL (dBuV)	LIMIT (dBuV/m)	MARGIN (dB)	ANTENNA FACTOR (dB /m)	CABLE LOSS (dB)	PREAMP FACTOR (dB)	ANTENNA HEIGHT (cm)	TABLE ANGLE (Degree)	REMARK
5150	53.95	52.47	74	-20.05	35.95	7.42	41.89	100	115	Peak
5150	46.36	44.88	54	-7.64	35.95	7.42	41.89	100	115	Average
5200	107.69	106.15			36	7.43	41.89	100	115	Peak
5200	96.98	95.44			36	7.43	41.89	100	115	Average
5350	52.43	50.7	74	-21.57	36.15	7.47	41.89	100	115	Peak
5350	41.87	40.14	54	-12.13	36.15	7.47	41.89	100	115	Average
ANTENNA POLARITY & TEST DISTANCE: VERTICAL AT 3 M										
FREQ. (MHz)	EMISSION LEVEL (dBuV/m)	READ LEVEL (dBuV)	LIMIT (dBuV/m)	MARGIN (dB)	ANTENNA FACTOR (dB /m)	CABLE LOSS (dB)	PREAMP FACTOR (dB)	ANTENNA HEIGHT (cm)	TABLE ANGLE (Degree)	REMARK
5150	54.37	52.55	74	-19.63	36.29	7.42	41.89	147	346	Peak
5150	44.89	43.07	54	-9.11	36.29	7.42	41.89	147	346	Average
5200	101.82	99.96			36.32	7.43	41.89	147	346	Peak
5200	91.92	90.06			36.32	7.43	41.89	147	346	Average
5350	53.15	51.16	74	-20.85	36.41	7.47	41.89	147	346	Peak
5350	42.04	40.05	54	-11.96	36.41	7.47	41.89	147	346	Average

REMARKS:

- Emission Level = Read Level+ Antenna Factor + Cable Loss- Preamp Factor
Margin value = Emission level – Limit value.
- 5200MHz: Fundamental frequency.



CHANNEL	TX Channel 48	DETECTOR FUNCTION	Peak (PK)
FREQUENCY RANGE	1GHz ~ 40GHz		Average (AV)

ANTENNA POLARITY & TEST DISTANCE: HORIZONTAL AT 3 M										
FREQ. (MHz)	EMISSION LEVEL (dBuV/m)	READ LEVEL (dBuV)	LIMIT (dBuV/m)	MARGIN (dB)	ANTENNA FACTOR (dB /m)	CABLE LOSS (dB)	PREAMP FACTOR (dB)	ANTENNA HEIGHT (cm)	TABLE ANGLE (Degree)	REMARK
5150	51.58	50.1	74	-22.42	35.95	7.42	41.89	173	55	Peak
5150	43.73	42.25	54	-10.27	35.95	7.42	41.89	173	55	Average
5240	109.7	108.11			36.04	7.44	41.89	173	55	Peak
5240	99.8	98.21			36.04	7.44	41.89	173	55	Average
5350	51.74	50.01	74	-22.26	36.15	7.47	41.89	173	55	Peak
5350	41.91	40.18	54	-12.09	36.15	7.47	41.89	173	55	Average
ANTENNA POLARITY & TEST DISTANCE: VERTICAL AT 3 M										
FREQ. (MHz)	EMISSION LEVEL (dBuV/m)	READ LEVEL (dBuV)	LIMIT (dBuV/m)	MARGIN (dB)	ANTENNA FACTOR (dB /m)	CABLE LOSS (dB)	PREAMP FACTOR (dB)	ANTENNA HEIGHT (cm)	TABLE ANGLE (Degree)	REMARK
5150	52.68	50.86	74	-21.32	36.29	7.42	41.89	114	205	Peak
5150	43.74	41.92	54	-10.26	36.29	7.42	41.89	114	205	Average
5240	105.04	103.15			36.34	7.44	41.89	114	205	Peak
5240	92.95	91.06			36.34	7.44	41.89	114	205	Average
5350	50.97	48.98	74	-23.03	36.41	7.47	41.89	114	205	Peak
5350	42.06	40.07	54	-11.94	36.41	7.47	41.89	114	205	Average

REMARKS:

- Emission Level = Read Level+ Antenna Factor + Cable Loss- Preamp Factor
Margin value = Emission level – Limit value.
- 5240MHz: Fundamental frequency.



802.11n (20MHz)

CHANNEL	TX Channel 36	DETECTOR FUNCTION	Peak (PK)
FREQUENCY RANGE	1GHz ~ 40GHz		Average (AV)

ANTENNA POLARITY & TEST DISTANCE: HORIZONTAL AT 3 M

FREQ. (MHz)	EMISSION LEVEL (dBuV/m)	READ LEVEL (dBuV)	LIMIT (dBuV/m)	MARGIN (dB)	ANTENNA FACTOR (dB /m)	CABLE LOSS (dB)	PREAMP FACTOR (dB)	ANTENNA HEIGHT (cm)	TABLE ANGLE (Degree)	REMARK
5150	56.11	54.63	74	-17.89	35.95	7.42	41.89	100	325	Peak
5150	46.76	45.28	54	-7.24	35.95	7.42	41.89	100	325	Average
5180	91.13	89.61			35.98	7.43	41.89	100	325	Peak
5180	81.77	80.25			35.98	7.43	41.89	100	325	Average
5350	54.09	52.36	74	-19.91	36.15	7.47	41.89	100	325	Peak
5350	43.86	42.13	54	-10.14	36.15	7.47	41.89	100	325	Average

ANTENNA POLARITY & TEST DISTANCE: VERTICAL AT 3 M

FREQ. (MHz)	EMISSION LEVEL (dBuV/m)	READ LEVEL (dBuV)	LIMIT (dBuV/m)	MARGIN (dB)	ANTENNA FACTOR (dB /m)	CABLE LOSS (dB)	PREAMP FACTOR (dB)	ANTENNA HEIGHT (cm)	TABLE ANGLE (Degree)	REMARK
5150	56.05	54.23	74	-17.95	36.29	7.42	41.89	100	25	Peak
5150	46.47	44.65	54	-7.53	36.29	7.42	41.89	100	25	Average
5180	92.1	90.25			36.31	7.43	41.89	100	25	Peak
5180	81.96	80.11			36.31	7.43	41.89	100	25	Average
5350	55.2	53.21	74	-18.8	36.41	7.47	41.89	100	25	Peak
5350	44.58	42.59	54	-9.42	36.41	7.47	41.89	100	25	Average

REMARKS:

- Emission Level = Read Level+ Antenna Factor + Cable Loss- Preamp Factor
Margin value = Emission level – Limit value.
- 5180MHz: Fundamental frequency.



CHANNEL	TX Channel 40	DETECTOR FUNCTION	Peak (PK)
FREQUENCY RANGE	1GHz ~ 40GHz		Average (AV)

ANTENNA POLARITY & TEST DISTANCE: HORIZONTAL AT 3 M										
FREQ. (MHz)	EMISSION LEVEL (dBuV/m)	READ LEVEL (dBuV)	LIMIT (dBuV/m)	MARGIN (dB)	ANTENNA FACTOR (dB /m)	CABLE LOSS (dB)	PREAMP FACTOR (dB)	ANTENNA HEIGHT (cm)	TABLE ANGLE (Degree)	REMARK
5150	52.38	50.9	74	-21.62	35.95	7.42	41.89	125	350	Peak
5150	44.32	42.84	54	-9.68	35.95	7.42	41.89	125	350	Average
5200	101.87	100.33			36	7.43	41.89	125	350	Peak
5200	91.75	90.21			36	7.43	41.89	125	350	Average
5350	50.09	48.36	74	-23.91	36.15	7.47	41.89	125	350	Peak
5350	41.67	39.94	54	-12.33	36.15	7.47	41.89	125	350	Average

ANTENNA POLARITY & TEST DISTANCE: VERTICAL AT 3 M										
FREQ. (MHz)	EMISSION LEVEL (dBuV/m)	READ LEVEL (dBuV)	LIMIT (dBuV/m)	MARGIN (dB)	ANTENNA FACTOR (dB /m)	CABLE LOSS (dB)	PREAMP FACTOR (dB)	ANTENNA HEIGHT (cm)	TABLE ANGLE (Degree)	REMARK
5150	53.63	51.81	74	-20.37	36.29	7.42	41.89	100	215	Peak
5150	44.82	43	54	-9.18	36.29	7.42	41.89	100	215	Average
5200	101.06	99.2			36.32	7.43	41.89	100	215	Peak
5200	91.06	89.2			36.32	7.43	41.89	100	215	Average
5350	52.04	50.05	74	-21.96	36.41	7.47	41.89	100	215	Peak
5350	42.08	40.09	54	-11.92	36.41	7.47	41.89	100	215	Average

REMARKS:

- Emission Level = Read Level+ Antenna Factor + Cable Loss- Preamp Factor
Margin value = Emission level – Limit value.
- 5200MHz: Fundamental frequency.



CHANNEL	TX Channel 48	DETECTOR FUNCTION	Peak (PK)
FREQUENCY RANGE	1GHz ~ 40GHz		Average (AV)

ANTENNA POLARITY & TEST DISTANCE: HORIZONTAL AT 3 M										
FREQ. (MHz)	EMISSION LEVEL (dBuV/m)	READ LEVEL (dBuV)	LIMIT (dBuV/m)	MARGIN (dB)	ANTENNA FACTOR (dB /m)	CABLE LOSS (dB)	PREAMP FACTOR (dB)	ANTENNA HEIGHT (cm)	TABLE ANGLE (Degree)	REMARK
5150	53.55	52.07	74	-20.45	35.95	7.42	41.89	165	55	Peak
5150	43.66	42.18	54	-10.34	35.95	7.42	41.89	165	55	Average
5240	108.22	106.63			36.04	7.44	41.89	165	55	Peak
5240	97.55	95.96			36.04	7.44	41.89	165	55	Average
5350	51.39	49.66	74	-22.61	36.15	7.47	41.89	165	55	Peak
5350	41.93	40.2	54	-12.07	36.15	7.47	41.89	165	55	Average

ANTENNA POLARITY & TEST DISTANCE: VERTICAL AT 3 M										
FREQ. (MHz)	EMISSION LEVEL (dBuV/m)	READ LEVEL (dBuV)	LIMIT (dBuV/m)	MARGIN (dB)	ANTENNA FACTOR (dB /m)	CABLE LOSS (dB)	PREAMP FACTOR (dB)	ANTENNA HEIGHT (cm)	TABLE ANGLE (Degree)	REMARK
5150	53.63	51.81	74	-20.37	36.29	7.42	41.89	100	205	Peak
5150	43.7	41.88	54	-10.3	36.29	7.42	41.89	100	205	Average
5240	102.75	100.86			36.34	7.44	41.89	100	205	Peak
5240	92.53	90.64			36.34	7.44	41.89	100	205	Average
5350	53.25	51.26	74	-20.75	36.41	7.47	41.89	100	205	Peak
5350	42.04	40.05	54	-11.96	36.41	7.47	41.89	100	205	Average

REMARKS:

- Emission Level = Read Level+ Antenna Factor + Cable Loss- Preamp Factor
Margin value = Emission level – Limit value.
- 5240MHz: Fundamental frequency.



802.11n (40MHz)

CHANNEL	TX Channel 38	DETECTOR FUNCTION	Peak (PK)
FREQUENCY RANGE	1GHz ~ 40GHz		Average (AV)

ANTENNA POLARITY & TEST DISTANCE: HORIZONTAL AT 3 M										
FREQ. (MHz)	EMISSION LEVEL (dBuV/m)	READ LEVEL (dBuV)	LIMIT (dBuV/m)	MARGIN (dB)	ANTENNA FACTOR (dB /m)	CABLE LOSS (dB)	PREAMP FACTOR (dB)	ANTENNA HEIGHT (cm)	TABLE ANGLE (Degree)	REMARK
5150	51.84	50.36	74	-22.16	35.95	7.42	41.89	100	325	Peak
5150	44.06	42.58	54	-9.94	35.95	7.42	41.89	100	325	Average
5190	87.16	85.63			35.99	7.43	41.89	100	325	Peak
5190	77.21	75.68			35.99	7.43	41.89	100	325	Average
5350	52.96	51.23	74	-21.04	36.15	7.47	41.89	100	325	Peak
5350	42.98	41.25	54	-11.02	36.15	7.47	41.89	100	325	Average

ANTENNA POLARITY & TEST DISTANCE: VERTICAL AT 3 M										
FREQ. (MHz)	EMISSION LEVEL (dBuV/m)	READ LEVEL (dBuV)	LIMIT (dBuV/m)	MARGIN (dB)	ANTENNA FACTOR (dB /m)	CABLE LOSS (dB)	PREAMP FACTOR (dB)	ANTENNA HEIGHT (cm)	TABLE ANGLE (Degree)	REMARK
5150	54.51	52.69	74	-19.49	36.29	7.42	41.89	100	15	Peak
5150	45.08	43.26	54	-8.92	36.29	7.42	41.89	100	15	Average
5190	89.36	87.51			36.31	7.43	41.89	100	15	Peak
5190	79.27	77.42			36.31	7.43	41.89	100	15	Average
5350	53.23	51.24	74	-20.77	36.41	7.47	41.89	100	15	Peak
5350	43.2	41.21	54	-10.8	36.41	7.47	41.89	100	15	Average

REMARKS:

- Emission Level = Read Level+ Antenna Factor + Cable Loss- Preamp Factor
Margin value = Emission level – Limit value.
- 5190MHz: Fundamental frequency.



CHANNEL	TX Channel 46	DETECTOR FUNCTION	Peak (PK)
FREQUENCY RANGE	1GHz ~ 40GHz		Average (AV)

ANTENNA POLARITY & TEST DISTANCE: HORIZONTAL AT 3 M

FREQ. (MHz)	EMISSION LEVEL (dBuV/m)	READ LEVEL (dBuV)	LIMIT (dBuV/m)	MARGIN (dB)	ANTENNA FACTOR (dB /m)	CABLE LOSS (dB)	PREAMP FACTOR (dB)	ANTENNA HEIGHT (cm)	TABLE ANGLE (Degree)	REMARK
5150	56.59	55.11	74	-17.41	35.95	7.42	41.89	100	50	Peak
5150	46.29	44.81	54	-7.71	35.95	7.42	41.89	100	50	Average
5230	103.42	101.84			36.03	7.44	41.89	100	50	Peak
5230	93.46	91.88			36.03	7.44	41.89	100	50	Average
5350	50.79	49.06	74	-23.21	36.15	7.47	41.89	100	50	Peak
5350	42.78	41.05	54	-11.22	36.15	7.47	41.89	100	50	Average

ANTENNA POLARITY & TEST DISTANCE: VERTICAL AT 3 M

FREQ. (MHz)	EMISSION LEVEL (dBuV/m)	READ LEVEL (dBuV)	LIMIT (dBuV/m)	MARGIN (dB)	ANTENNA FACTOR (dB /m)	CABLE LOSS (dB)	PREAMP FACTOR (dB)	ANTENNA HEIGHT (cm)	TABLE ANGLE (Degree)	REMARK
5150	53.91	52.09	74	-20.09	36.29	7.42	41.89	100	231	Peak
5150	45.49	43.67	54	-8.51	36.29	7.42	41.89	100	231	Average
5230	96.88	94.99			36.34	7.44	41.89	100	231	Peak
5230	86.33	84.44			36.34	7.44	41.89	100	231	Average
5350	51.54	49.55	74	-22.46	36.41	7.47	41.89	100	231	Peak
5350	42.95	40.96	54	-11.05	36.41	7.47	41.89	100	231	Average

REMARKS:

- Emission Level = Read Level+ Antenna Factor + Cable Loss- Preamp Factor
Margin value = Emission level – Limit value.
- 5230MHz: Fundamental frequency.



802.11ac (80MHz)

CHANNEL	TX Channel 42	DETECTOR FUNCTION	Peak (PK)
FREQUENCY RANGE	1GHz ~ 40GHz		Average (AV)

ANTENNA POLARITY & TEST DISTANCE: HORIZONTAL AT 3 M

FREQ. (MHz)	EMISSION LEVEL (dBuV/m)	READ LEVEL (dBuV)	LIMIT (dBuV/m)	MARGIN (dB)	ANTENNA FACTOR (dB /m)	CABLE LOSS (dB)	PREAMP FACTOR (dB)	ANTENNA HEIGHT (cm)	TABLE ANGLE (Degree)	REMARK
5150	63.79	62.31	74	-10.21	35.95	7.42	41.89	163	52	Peak
5150	50.73	49.25	54	-3.27	35.95	7.42	41.89	163	52	Average
5210	105.76	104.2			36.01	7.44	41.89	163	52	Peak
5210	96.51	94.95			36.01	7.44	41.89	163	52	Average
5350	51.96	50.23	74	-22.04	36.15	7.47	41.89	163	52	Peak
5350	42.34	40.61	54	-11.66	36.15	7.47	41.89	163	52	Average

ANTENNA POLARITY & TEST DISTANCE: VERTICAL AT 3 M

FREQ. (MHz)	EMISSION LEVEL (dBuV/m)	READ LEVEL (dBuV)	LIMIT (dBuV/m)	MARGIN (dB)	ANTENNA FACTOR (dB /m)	CABLE LOSS (dB)	PREAMP FACTOR (dB)	ANTENNA HEIGHT (cm)	TABLE ANGLE (Degree)	REMARK
5150	61.14	59.32	74	-12.86	36.29	7.42	41.89	125	63	Peak
5150	48.33	46.51	54	-5.67	36.29	7.42	41.89	125	63	Average
5210	102.19	100.31			36.33	7.44	41.89	125	63	Peak
5210	94.32	92.44			36.33	7.44	41.89	125	63	Average
5350	52.25	50.26	74	-21.75	36.41	7.47	41.89	125	63	Peak
5350	42.11	40.12	54	-11.89	36.41	7.47	41.89	125	63	Average

REMARKS:

- Emission Level = Read Level+ Antenna Factor + Cable Loss- Preamp Factor
Margin value = Emission level – Limit value.
- 5210MHz: Fundamental frequency.



Band 2
802.11a

CHANNEL	TX Channel 52	DETECTOR FUNCTION	Peak (PK)
FREQUENCY RANGE	1GHz ~ 40GHz		Average (AV)

ANTENNA POLARITY & TEST DISTANCE: HORIZONTAL AT 3 M

FREQ. (MHz)	EMISSION LEVEL (dBuV/m)	READ LEVEL (dBuV)	LIMIT (dBuV/m)	MARGIN (dB)	ANTENNA FACTOR (dB /m)	CABLE LOSS (dB)	PREAMP FACTOR (dB)	ANTENNA HEIGHT (cm)	TABLE ANGLE (Degree)	REMARK
5150	53.19	51.71	74	-20.81	35.95	7.42	41.89	198	86	Peak
5150	43.59	42.11	54	-10.41	35.95	7.42	41.89	198	86	Average
5260	108.1	106.48			36.06	7.45	41.89	198	86	Peak
5260	98.31	96.69			36.06	7.45	41.89	198	86	Average
5350	51.57	49.84	74	-22.43	36.15	7.47	41.89	198	86	Peak
5350	41.84	40.11	54	-12.16	36.15	7.47	41.89	198	86	Average

ANTENNA POLARITY & TEST DISTANCE: VERTICAL AT 3 M

FREQ. (MHz)	EMISSION LEVEL (dBuV/m)	READ LEVEL (dBuV)	LIMIT (dBuV/m)	MARGIN (dB)	ANTENNA FACTOR (dB /m)	CABLE LOSS (dB)	PREAMP FACTOR (dB)	ANTENNA HEIGHT (cm)	TABLE ANGLE (Degree)	REMARK
5150	51.33	49.51	74	-22.67	36.29	7.42	41.89	100	202	Peak
5150	43.73	41.91	54	-10.27	36.29	7.42	41.89	100	202	Average
5260	104.74	102.82			36.36	7.45	41.89	100	202	Peak
5260	93.64	91.72			36.36	7.45	41.89	100	202	Average
5350	51.4	49.41	74	-22.6	36.41	7.47	41.89	100	202	Peak
5350	42.11	40.12	54	-11.89	36.41	7.47	41.89	100	202	Average

REMARKS:

- Emission Level = Read Level+ Antenna Factor + Cable Loss- Preamp Factor
Margin value = Emission level – Limit value.
- 5260MHz: Fundamental frequency.



CHANNEL	TX Channel 60	DETECTOR FUNCTION	Peak (PK)
FREQUENCY RANGE	1GHz ~ 40GHz		Average (AV)

ANTENNA POLARITY & TEST DISTANCE: HORIZONTAL AT 3 M

FREQ. (MHz)	EMISSION LEVEL (dBuV/m)	READ LEVEL (dBuV)	LIMIT (dBuV/m)	MARGIN (dB)	ANTENNA FACTOR (dB /m)	CABLE LOSS (dB)	PREAMP FACTOR (dB)	ANTENNA HEIGHT (cm)	TABLE ANGLE (Degree)	REMARK
5150	51.56	50.08	74	-22.44	35.95	7.42	41.89	100	56	Peak
5150	43.55	42.07	54	-10.45	35.95	7.42	41.89	100	56	Average
5300	106.89	105.22			36.1	7.46	41.89	100	56	Peak
5300	96.48	94.81			36.1	7.46	41.89	100	56	Average
5350	53.44	51.71	74	-20.56	36.15	7.47	41.89	100	56	Peak
5350	3.29	1.56	54	-50.71	36.15	7.47	41.89	100	56	Average

ANTENNA POLARITY & TEST DISTANCE: VERTICAL AT 3 M

FREQ. (MHz)	EMISSION LEVEL (dBuV/m)	READ LEVEL (dBuV)	LIMIT (dBuV/m)	MARGIN (dB)	ANTENNA FACTOR (dB /m)	CABLE LOSS (dB)	PREAMP FACTOR (dB)	ANTENNA HEIGHT (cm)	TABLE ANGLE (Degree)	REMARK
5150	52.03	50.21	74	-21.97	36.29	7.42	41.89	100	205	Peak
5150	43.66	41.84	54	-10.34	36.29	7.42	41.89	100	205	Average
5300	104.04	102.09			36.38	7.46	41.89	100	205	Peak
5300	94.44	92.49			36.38	7.46	41.89	100	205	Average
5350	52.21	50.22	74	-21.79	36.41	7.47	41.89	100	205	Peak
5350	43.09	41.1	54	-10.91	36.41	7.47	41.89	100	205	Average

REMARKS:

- Emission Level = Read Level+ Antenna Factor + Cable Loss- Preamp Factor
Margin value = Emission level – Limit value.
- 5300MHz: Fundamental frequency.



CHANNEL	TX Channel 64	DETECTOR FUNCTION	Peak (PK)
FREQUENCY RANGE	1GHz ~ 40GHz		Average (AV)

ANTENNA POLARITY & TEST DISTANCE: HORIZONTAL AT 3 M

FREQ. (MHz)	EMISSION LEVEL (dBuV/m)	READ LEVEL (dBuV)	LIMIT (dBuV/m)	MARGIN (dB)	ANTENNA FACTOR (dB /m)	CABLE LOSS (dB)	PREAMP FACTOR (dB)	ANTENNA HEIGHT (cm)	TABLE ANGLE (Degree)	REMARK
5150	63.41	66.39	74	-10.59	35.95	7.42	46.35	200	90	Peak
5150	44.54	47.52	54	-9.46	35.95	7.42	46.35	200	90	Average
5320	103.78	106.5			36.12	7.46	46.3	200	90	Peak
5320	89.84	92.56			36.12	7.46	46.3	200	90	Average
5350	64.1	66.78	74	-9.9	36.15	7.47	46.3	200	90	Peak
5350	45.57	48.25	54	-8.43	36.15	7.47	46.3	200	90	Average

ANTENNA POLARITY & TEST DISTANCE: VERTICAL AT 3 M

FREQ. (MHz)	EMISSION LEVEL (dBuV/m)	READ LEVEL (dBuV)	LIMIT (dBuV/m)	MARGIN (dB)	ANTENNA FACTOR (dB /m)	CABLE LOSS (dB)	PREAMP FACTOR (dB)	ANTENNA HEIGHT (cm)	TABLE ANGLE (Degree)	REMARK
5150	65.28	67.92	74	-8.72	36.29	7.42	46.35	200	200	Peak
5150	43.45	46.09	54	-10.55	36.29	7.42	46.35	200	200	Average
5320	100.51	102.96			36.39	7.46	46.3	200	200	Peak
5320	90.13	92.58			36.39	7.46	46.3	200	200	Average
5350	63.91	66.33	74	-10.09	36.41	7.47	46.3	200	200	Peak
5350	42.86	45.28	54	-11.14	36.41	7.47	46.3	200	200	Average

REMARKS:

- Emission Level = Read Level+ Antenna Factor + Cable Loss- Preamp Factor
Margin value = Emission level – Limit value.
- 5320MHz: Fundamental frequency.



802.11n (20MHz)

CHANNEL	TX Channel 52	DETECTOR FUNCTION	Peak (PK)
FREQUENCY RANGE	1GHz ~ 40GHz		Average (AV)

ANTENNA POLARITY & TEST DISTANCE: HORIZONTAL AT 3 M										
FREQ. (MHz)	EMISSION LEVEL (dBuV/m)	READ LEVEL (dBuV)	LIMIT (dBuV/m)	MARGIN (dB)	ANTENNA FACTOR (dB /m)	CABLE LOSS (dB)	PREAMP FACTOR (dB)	ANTENNA HEIGHT (cm)	TABLE ANGLE (Degree)	REMARK
5150	54.18	52.7	74	-19.82	35.95	7.42	41.89	100	52	Peak
5150	44.58	43.1	54	-9.42	35.95	7.42	41.89	100	52	Average
5260	108.83	107.21			36.06	7.45	41.89	100	52	Peak
5260	97.53	95.91			36.06	7.45	41.89	100	52	Average
5350	51.89	50.16	74	-22.11	36.15	7.47	41.89	100	52	Peak
5350	42.8	41.07	54	-11.2	36.15	7.47	41.89	100	52	Average

ANTENNA POLARITY & TEST DISTANCE: VERTICAL AT 3 M										
FREQ. (MHz)	EMISSION LEVEL (dBuV/m)	READ LEVEL (dBuV)	LIMIT (dBuV/m)	MARGIN (dB)	ANTENNA FACTOR (dB /m)	CABLE LOSS (dB)	PREAMP FACTOR (dB)	ANTENNA HEIGHT (cm)	TABLE ANGLE (Degree)	REMARK
5150	53.84	52.02	74	-20.16	36.29	7.42	41.89	182	68	Peak
5150	44.77	42.95	54	-9.23	36.29	7.42	41.89	182	68	Average
5260	103.45	101.53			36.36	7.45	41.89	182	68	Peak
5260	92.79	90.87			36.36	7.45	41.89	182	68	Average
5350	51.48	49.49	74	-22.52	36.41	7.47	41.89	182	68	Peak
5350	42.99	41	54	-11.01	36.41	7.47	41.89	182	68	Average

REMARKS:

1. Emission Level = Read Level+ Antenna Factor + Cable Loss- Preamp Factor
Margin value = Emission level – Limit value.
2. 5260MHz: Fundamental frequency.



CHANNEL	TX Channel 60	DETECTOR FUNCTION	Peak (PK)
FREQUENCY RANGE	1GHz ~ 40GHz		Average (AV)

ANTENNA POLARITY & TEST DISTANCE: HORIZONTAL AT 3 M										
FREQ. (MHz)	EMISSION LEVEL (dBuV/m)	READ LEVEL (dBuV)	LIMIT (dBuV/m)	MARGIN (dB)	ANTENNA FACTOR (dB /m)	CABLE LOSS (dB)	PREAMP FACTOR (dB)	ANTENNA HEIGHT (cm)	TABLE ANGLE (Degree)	REMARK
5150	52.61	51.13	74	-21.39	35.95	7.42	41.89	132	54	Peak
5150	44.48	43	54	-9.52	35.95	7.42	41.89	132	54	Average
5300	105.68	104.01			36.1	7.46	41.89	132	54	Peak
5300	94.67	93			36.1	7.46	41.89	132	54	Average
5350	56.01	54.28	74	-17.99	36.15	7.47	41.89	132	54	Peak
5350	43.76	42.03	54	-10.24	36.15	7.47	41.89	132	54	Average

ANTENNA POLARITY & TEST DISTANCE: VERTICAL AT 3 M										
FREQ. (MHz)	EMISSION LEVEL (dBuV/m)	READ LEVEL (dBuV)	LIMIT (dBuV/m)	MARGIN (dB)	ANTENNA FACTOR (dB /m)	CABLE LOSS (dB)	PREAMP FACTOR (dB)	ANTENNA HEIGHT (cm)	TABLE ANGLE (Degree)	REMARK
5150	55.22	53.4	74	-18.78	36.29	7.42	41.89	100	206	Peak
5150	44.65	42.83	54	-9.35	36.29	7.42	41.89	100	206	Average
5300	102.04	100.09			36.38	7.46	41.89	100	206	Peak
5300	90.68	88.73			36.38	7.46	41.89	100	206	Average
5350	55.26	53.27	74	-18.74	36.41	7.47	41.89	100	206	Peak
5350	43.56	41.57	54	-10.44	36.41	7.47	41.89	100	206	Average

REMARKS:

- Emission Level = Read Level+ Antenna Factor + Cable Loss- Preamp Factor
Margin value = Emission level – Limit value.
- 5300MHz: Fundamental frequency.



CHANNEL	TX Channel 64	DETECTOR FUNCTION	Peak (PK)
FREQUENCY RANGE	1GHz ~ 40GHz		Average (AV)

ANTENNA POLARITY & TEST DISTANCE: HORIZONTAL AT 3 M

FREQ. (MHz)	EMISSION LEVEL (dBuV/m)	READ LEVEL (dBuV)	LIMIT (dBuV/m)	MARGIN (dB)	ANTENNA FACTOR (dB /m)	CABLE LOSS (dB)	PREAMP FACTOR (dB)	ANTENNA HEIGHT (cm)	TABLE ANGLE (Degree)	REMARK
5150	52.68	51.2	74	-21.32	35.95	7.42	41.89	140	51	Peak
5150	44.48	43	54	-9.52	35.95	7.42	41.89	140	51	Average
5320	105.55	103.86			36.12	7.46	41.89	140	51	Peak
5320	95.19	93.5			36.12	7.46	41.89	140	51	Average
5350	60.35	58.62	74	-13.65	36.15	7.47	41.89	140	51	Peak
5350	49.52	47.79	54	-4.48	36.15	7.47	41.89	140	51	Average

ANTENNA POLARITY & TEST DISTANCE: VERTICAL AT 3 M

FREQ. (MHz)	EMISSION LEVEL (dBuV/m)	READ LEVEL (dBuV)	LIMIT (dBuV/m)	MARGIN (dB)	ANTENNA FACTOR (dB /m)	CABLE LOSS (dB)	PREAMP FACTOR (dB)	ANTENNA HEIGHT (cm)	TABLE ANGLE (Degree)	REMARK
5150	53.56	51.74	74	-20.44	36.29	7.42	41.89	100	60	Peak
5150	44.77	42.95	54	-9.23	36.29	7.42	41.89	100	60	Average
5320	100.83	98.87			36.39	7.46	41.89	100	60	Peak
5320	90.52	88.56			36.39	7.46	41.89	100	60	Average
5350	60.08	58.09	74	-13.92	36.41	7.47	41.89	100	60	Peak
5350	47.22	45.23	54	-6.78	36.41	7.47	41.89	100	60	Average

REMARKS:

- Emission Level = Read Level+ Antenna Factor + Cable Loss- Preamp Factor
Margin value = Emission level – Limit value.
- 5320MHz: Fundamental frequency.



802.11n (40MHz)

CHANNEL	TX Channel 54	DETECTOR FUNCTION	Peak (PK)
FREQUENCY RANGE	1GHz ~ 40GHz		Average (AV)

ANTENNA POLARITY & TEST DISTANCE: HORIZONTAL AT 3 M										
FREQ. (MHz)	EMISSION LEVEL (dBuV/m)	READ LEVEL (dBuV)	LIMIT (dBuV/m)	MARGIN (dB)	ANTENNA FACTOR (dB /m)	CABLE LOSS (dB)	PREAMP FACTOR (dB)	ANTENNA HEIGHT (cm)	TABLE ANGLE (Degree)	REMARK
5150	53.71	52.23	74	-20.29	35.95	7.42	41.89	100	51	Peak
5150	44.95	43.47	54	-9.05	35.95	7.42	41.89	100	51	Average
5270	103.12	101.49			36.07	7.45	41.89	100	51	Peak
5270	92.94	91.31			36.07	7.45	41.89	100	51	Average
5350	53.85	52.12	74	-20.15	36.15	7.47	41.89	100	51	Peak
5350	43.91	42.18	54	-10.09	36.15	7.47	41.89	100	51	Average
ANTENNA POLARITY & TEST DISTANCE: VERTICAL AT 3 M										
FREQ. (MHz)	EMISSION LEVEL (dBuV/m)	READ LEVEL (dBuV)	LIMIT (dBuV/m)	MARGIN (dB)	ANTENNA FACTOR (dB /m)	CABLE LOSS (dB)	PREAMP FACTOR (dB)	ANTENNA HEIGHT (cm)	TABLE ANGLE (Degree)	REMARK
5150	54.92	53.1	74	-19.08	36.29	7.42	41.89	100	67	Peak
5150	44.75	42.93	54	-9.25	36.29	7.42	41.89	100	67	Average
5270	98.62	96.7			36.36	7.45	41.89	100	67	Peak
5270	87.68	85.76			36.36	7.45	41.89	100	67	Average
5350	53.55	51.56	74	-20.45	36.41	7.47	41.89	100	67	Peak
5350	43.32	41.33	54	-10.68	36.41	7.47	41.89	100	67	Average

REMARKS:

- Emission Level = Read Level+ Antenna Factor + Cable Loss- Preamp Factor
Margin value = Emission level – Limit value.
- 5270MHz: Fundamental frequency.



CHANNEL	TX Channel 62	DETECTOR FUNCTION	Peak (PK)
FREQUENCY RANGE	1GHz ~ 40GHz		Average (AV)

ANTENNA POLARITY & TEST DISTANCE: HORIZONTAL AT 3 M

FREQ. (MHz)	EMISSION LEVEL (dBuV/m)	READ LEVEL (dBuV)	LIMIT (dBuV/m)	MARGIN (dB)	ANTENNA FACTOR (dB /m)	CABLE LOSS (dB)	PREAMP FACTOR (dB)	ANTENNA HEIGHT (cm)	TABLE ANGLE (Degree)	REMARK
5150	51.83	50.35	74	-22.17	35.95	7.42	41.89	100	256	Peak
5150	42.74	41.26	54	-11.26	35.95	7.42	41.89	100	256	Average
5310	86.96	85.28			36.11	7.46	41.89	100	256	Peak
5310	77.16	75.48			36.11	7.46	41.89	100	256	Average
5350	54.37	52.64	74	-19.63	36.15	7.47	41.89	100	256	Peak
5350	44.29	42.56	54	-9.71	36.15	7.47	41.89	100	256	Average

ANTENNA POLARITY & TEST DISTANCE: VERTICAL AT 3 M

FREQ. (MHz)	EMISSION LEVEL (dBuV/m)	READ LEVEL (dBuV)	LIMIT (dBuV/m)	MARGIN (dB)	ANTENNA FACTOR (dB /m)	CABLE LOSS (dB)	PREAMP FACTOR (dB)	ANTENNA HEIGHT (cm)	TABLE ANGLE (Degree)	REMARK
5150	52.2	50.38	74	-21.8	36.29	7.42	41.89	100	36	Peak
5150	42.05	40.23	54	-11.95	36.29	7.42	41.89	100	36	Average
5310	88.21	86.25			36.39	7.46	41.89	100	36	Peak
5310	78.17	76.21			36.39	7.46	41.89	100	36	Average
5350	55.63	53.64	74	-18.37	36.41	7.47	41.89	100	36	Peak
5350	44.56	42.57	54	-9.44	36.41	7.47	41.89	100	36	Average

REMARKS:

- Emission Level = Read Level+ Antenna Factor + Cable Loss- Preamp Factor
Margin value = Emission level – Limit value.
- 5310MHz: Fundamental frequency.



802.11ac (80MHz)

CHANNEL	TX Channel 58	DETECTOR FUNCTION	Peak (PK)
FREQUENCY RANGE	1GHz ~ 40GHz		Average (AV)

ANTENNA POLARITY & TEST DISTANCE: HORIZONTAL AT 3 M

FREQ. (MHz)	EMISSION LEVEL (dBuV/m)	READ LEVEL (dBuV)	LIMIT (dBuV/m)	MARGIN (dB)	ANTENNA FACTOR (dB /m)	CABLE LOSS (dB)	PREAMP FACTOR (dB)	ANTENNA HEIGHT (cm)	TABLE ANGLE (Degree)	REMARK
5150	53.82	52.34	74	-20.18	35.95	7.42	41.89	142	69	Peak
5150	43.16	41.68	54	-10.84	35.95	7.42	41.89	142	69	Average
5290	105.18	103.53			36.09	7.45	41.89	142	69	Peak
5290	96.23	94.58			36.09	7.45	41.89	142	69	Average
5350	63.62	61.89	74	-10.38	36.15	7.47	41.89	142	69	Peak
5350	50.69	48.96	54	-3.31	36.15	7.47	41.89	142	69	Average

ANTENNA POLARITY & TEST DISTANCE: VERTICAL AT 3 M

FREQ. (MHz)	EMISSION LEVEL (dBuV/m)	READ LEVEL (dBuV)	LIMIT (dBuV/m)	MARGIN (dB)	ANTENNA FACTOR (dB /m)	CABLE LOSS (dB)	PREAMP FACTOR (dB)	ANTENNA HEIGHT (cm)	TABLE ANGLE (Degree)	REMARK
5150	53.09	51.27	74	-20.91	36.29	7.42	41.89	112	55	Peak
5150	43.03	41.21	54	-10.97	36.29	7.42	41.89	112	55	Average
5290	103.18	101.25			36.37	7.45	41.89	112	55	Peak
5290	95.59	93.66			36.37	7.45	41.89	112	55	Average
5350	63.44	61.45	74	-10.56	36.41	7.47	41.89	112	55	Peak
5350	49.67	47.68	54	-4.33	36.41	7.47	41.89	112	55	Average

REMARKS:

- Emission Level = Read Level+ Antenna Factor + Cable Loss- Preamp Factor
Margin value = Emission level – Limit value.
- 5290MHz: Fundamental frequency.



Band 3

802.11a

CHANNEL	TX Channel 100	DETECTOR FUNCTION	Peak (PK)
FREQUENCY RANGE	1GHz ~ 40GHz		Average (AV)

ANTENNA POLARITY & TEST DISTANCE: HORIZONTAL AT 3 M

FREQ. (MHz)	EMISSION LEVEL (dBuV/m)	READ LEVEL (dBuV)	LIMIT (dBuV/m)	MARGIN (dB)	ANTENNA FACTOR (dB /m)	CABLE LOSS (dB)	PREAMP FACTOR (dB)	ANTENNA HEIGHT (cm)	TABLE ANGLE (Degree)	REMARK
5460	54.24	52.37	74	-19.76	36.26	7.49	41.88	147	45	Peak
5460	43.62	41.75	54	-10.38	36.26	7.49	41.88	147	45	Average
#5470	46.39	44.51	68.3	-21.91	36.27	7.49	41.88	147	45	Peak
5500	103.59	101.67			36.3	7.5	41.88	147	45	Peak
5500	92.92	91			36.3	7.5	41.88	147	45	Average

ANTENNA POLARITY & TEST DISTANCE: VERTICAL AT 3 M

FREQ. (MHz)	EMISSION LEVEL (dBuV/m)	READ LEVEL (dBuV)	LIMIT (dBuV/m)	MARGIN (dB)	ANTENNA FACTOR (dB /m)	CABLE LOSS (dB)	PREAMP FACTOR (dB)	ANTENNA HEIGHT (cm)	TABLE ANGLE (Degree)	REMARK
5460	54.63	52.54	74	-19.37	36.48	7.49	41.88	100	214	Peak
5460	42.89	40.8	54	-11.11	36.48	7.49	41.88	100	214	Average
#5470	55.92	53.83	68.3	-12.38	36.48	7.49	41.88	100	214	Peak
5500	99.73	97.61			36.5	7.5	41.88	100	214	Peak
5500	90.19	88.07			36.5	7.5	41.88	100	214	Average

REMARKS:

- Emission Level = Read Level+ Antenna Factor + Cable Loss- Preamp Factor
Margin value = Emission level – Limit value.
- 5500MHz: Fundamental frequency.
- #: Out of restricted band.



CHANNEL	TX Channel 116	DETECTOR FUNCTION	Peak (PK)
FREQUENCY RANGE	1GHz ~ 40GHz		Average (AV)

ANTENNA POLARITY & TEST DISTANCE: HORIZONTAL AT 3 M										
FREQ. (MHz)	EMISSION LEVEL (dBuV/m)	READ LEVEL (dBuV)	LIMIT (dBuV/m)	MARGIN (dB)	ANTENNA FACTOR (dB /m)	CABLE LOSS (dB)	PREAMP FACTOR (dB)	ANTENNA HEIGHT (cm)	TABLE ANGLE (Degree)	REMARK
5460	52.99	51.12	74	-21.01	36.26	7.49	41.88	100	79	Peak
5460	43.27	41.4	54	-10.73	36.26	7.49	41.88	100	79	Average
#5470	55	53.12	68.3	-13.3	36.27	7.49	41.88	100	79	Peak
5580	102.05	100.07			36.33	7.58	41.93	100	79	Peak
5580	92.03	90.05			36.33	7.58	41.93	100	79	Average

ANTENNA POLARITY & TEST DISTANCE: VERTICAL AT 3 M										
FREQ. (MHz)	EMISSION LEVEL (dBuV/m)	READ LEVEL (dBuV)	LIMIT (dBuV/m)	MARGIN (dB)	ANTENNA FACTOR (dB /m)	CABLE LOSS (dB)	PREAMP FACTOR (dB)	ANTENNA HEIGHT (cm)	TABLE ANGLE (Degree)	REMARK
5460	51.99	49.9	74	-22.01	36.48	7.49	41.88	100	4	Peak
5460	41.52	39.43	54	-12.48	36.48	7.49	41.88	100	4	Average
#5470	53.12	51.03	68.3	-15.18	36.48	7.49	41.88	100	4	Peak
5580	103.1	100.9			36.55	7.58	41.93	100	4	Peak
5580	93.12	90.92			36.55	7.58	41.93	100	4	Average

REMARKS:

1. Emission Level = Read Level+ Antenna Factor + Cable Loss- Preamp Factor
Margin value = Emission level – Limit value.
2. 5580MHz: Fundamental frequency.
3. #: Out of restricted band.



CHANNEL	TX Channel 140	DETECTOR FUNCTION	Peak (PK)
FREQUENCY RANGE	1GHz ~ 40GHz		Average (AV)

ANTENNA POLARITY & TEST DISTANCE: HORIZONTAL AT 3 M										
FREQ. (MHz)	EMISSION LEVEL (dBuV/m)	READ LEVEL (dBuV)	LIMIT (dBuV/m)	MARGIN (dB)	ANTENNA FACTOR (dB /m)	CABLE LOSS (dB)	PREAMP FACTOR (dB)	ANTENNA HEIGHT (cm)	TABLE ANGLE (Degree)	REMARK
5700	104.88	102.81			36.38	7.7	42.01	140	47	Peak
5700	92.53	90.46			36.38	7.7	42.01	140	47	Average
#5725	64.16	62.06	68.3	-4.14	36.39	7.73	42.02	140	47	Peak
ANTENNA POLARITY & TEST DISTANCE: VERTICAL AT 3 M										
FREQ. (MHz)	EMISSION LEVEL (dBuV/m)	READ LEVEL (dBuV)	LIMIT (dBuV/m)	MARGIN (dB)	ANTENNA FACTOR (dB /m)	CABLE LOSS (dB)	PREAMP FACTOR (dB)	ANTENNA HEIGHT (cm)	TABLE ANGLE (Degree)	REMARK
5700	102.9	100.59			36.62	7.7	42.01	100	210	Peak
5700	92.36	90.05			36.62	7.7	42.01	100	210	Average
#5725	64.98	62.64	68.3	-3.32	36.63	7.73	42.02	100	210	Peak

REMARKS:

- Emission Level = Read Level+ Antenna Factor + Cable Loss- Preamp Factor
Margin value = Emission level – Limit value.
- 5700MHz: Fundamental frequency.
- #: Out of restricted band.



802.11n (20MHz)

CHANNEL	TX Channel 100	DETECTOR FUNCTION	Peak (PK)
FREQUENCY RANGE	1GHz ~ 40GHz		Average (AV)

ANTENNA POLARITY & TEST DISTANCE: HORIZONTAL AT 3 M										
FREQ. (MHz)	EMISSION LEVEL (dBuV/m)	READ LEVEL (dBuV)	LIMIT (dBuV/m)	MARGIN (dB)	ANTENNA FACTOR (dB /m)	CABLE LOSS (dB)	PREAMP FACTOR (dB)	ANTENNA HEIGHT (cm)	TABLE ANGLE (Degree)	REMARK
5460	54.98	53.11	74	-19.02	36.26	7.49	41.88	100	74	Peak
5460	43.62	41.75	54	-10.38	36.26	7.49	41.88	100	74	Average
#5470	61.35	59.47	68.3	-6.95	36.27	7.49	41.88	100	74	Peak
5500	102.91	100.99			36.3	7.5	41.88	100	74	Peak
5500	92.06	90.14			36.3	7.5	41.88	100	74	Average

ANTENNA POLARITY & TEST DISTANCE: VERTICAL AT 3 M										
FREQ. (MHz)	EMISSION LEVEL (dBuV/m)	READ LEVEL (dBuV)	LIMIT (dBuV/m)	MARGIN (dB)	ANTENNA FACTOR (dB /m)	CABLE LOSS (dB)	PREAMP FACTOR (dB)	ANTENNA HEIGHT (cm)	TABLE ANGLE (Degree)	REMARK
5460	52.99	50.9	74	-21.01	36.48	7.49	41.88	100	209	Peak
5460	43.21	41.12	54	-10.79	36.48	7.49	41.88	100	209	Average
#5470	58.7	56.61	68.3	-9.6	36.48	7.49	41.88	100	209	Peak
5500	100.22	98.1			36.5	7.5	41.88	100	209	Peak
5500	89.1	86.98			36.5	7.5	41.88	100	209	Average

REMARKS:

- Emission Level = Read Level+ Antenna Factor + Cable Loss- Preamp Factor
Margin value = Emission level – Limit value.
- 5500MHz: Fundamental frequency.
- #: Out of restricted band.



CHANNEL	TX Channel 116	DETECTOR FUNCTION	Peak (PK)
FREQUENCY RANGE	1GHz ~ 40GHz		Average (AV)

ANTENNA POLARITY & TEST DISTANCE: HORIZONTAL AT 3 M

FREQ. (MHz)	EMISSION LEVEL (dBuV/m)	READ LEVEL (dBuV)	LIMIT (dBuV/m)	MARGIN (dB)	ANTENNA FACTOR (dB /m)	CABLE LOSS (dB)	PREAMP FACTOR (dB)	ANTENNA HEIGHT (cm)	TABLE ANGLE (Degree)	REMARK
5460	50.81	48.94	74	-23.19	36.26	7.49	41.88	143	48	Peak
5460	42.45	40.58	54	-11.55	36.26	7.49	41.88	143	48	Average
#5470	54.48	52.6	68.3	-13.82	36.27	7.49	41.88	143	48	Peak
5580	103.49	101.51			36.33	7.58	41.93	143	48	Peak
5580	91.97	89.99			36.33	7.58	41.93	143	48	Average

ANTENNA POLARITY & TEST DISTANCE: VERTICAL AT 3 M

FREQ. (MHz)	EMISSION LEVEL (dBuV/m)	READ LEVEL (dBuV)	LIMIT (dBuV/m)	MARGIN (dB)	ANTENNA FACTOR (dB /m)	CABLE LOSS (dB)	PREAMP FACTOR (dB)	ANTENNA HEIGHT (cm)	TABLE ANGLE (Degree)	REMARK
5460	52.66	50.57	74	-21.34	36.48	7.49	41.88	100	67	Peak
5460	42.67	40.58	54	-11.33	36.48	7.49	41.88	100	67	Average
#5470	52.61	50.52	68.3	-15.69	36.48	7.49	41.88	100	67	Peak
5580	100.47	98.27			36.55	7.58	41.93	100	67	Peak
5580	90.31	88.11			36.55	7.58	41.93	100	67	Average

REMARKS:

- Emission Level = Read Level+ Antenna Factor + Cable Loss- Preamp Factor
Margin value = Emission level – Limit value.
- 5580MHz: Fundamental frequency.
- #: Out of restricted band.



CHANNEL	TX Channel 140	DETECTOR FUNCTION	Peak (PK)
FREQUENCY RANGE	1GHz ~ 40GHz		Average (AV)

ANTENNA POLARITY & TEST DISTANCE: HORIZONTAL AT 3 M										
FREQ. (MHz)	EMISSION LEVEL (dBuV/m)	READ LEVEL (dBuV)	LIMIT (dBuV/m)	MARGIN (dB)	ANTENNA FACTOR (dB /m)	CABLE LOSS (dB)	PREAMP FACTOR (dB)	ANTENNA HEIGHT (cm)	TABLE ANGLE (Degree)	REMARK
5700	103.6	101.53			36.38	7.7	42.01	100	38	Peak
5700	92.86	90.79			36.38	7.7	42.01	100	38	Average
#5725	65.84	63.74	68.3	-2.46	36.39	7.73	42.02	100	38	Peak
ANTENNA POLARITY & TEST DISTANCE: VERTICAL AT 3 M										
FREQ. (MHz)	EMISSION LEVEL (dBuV/m)	READ LEVEL (dBuV)	LIMIT (dBuV/m)	MARGIN (dB)	ANTENNA FACTOR (dB /m)	CABLE LOSS (dB)	PREAMP FACTOR (dB)	ANTENNA HEIGHT (cm)	TABLE ANGLE (Degree)	REMARK
5700	101.79	99.48			36.62	7.7	42.01	175	208	Peak
5700	90.96	88.65			36.62	7.7	42.01	175	208	Average
#5725	64.91	62.57	68.3	-3.39	36.63	7.73	42.02	175	208	Peak

REMARKS:

- Emission Level = Read Level+ Antenna Factor + Cable Loss- Preamp Factor
Margin value = Emission level – Limit value.
- 5700MHz: Fundamental frequency.
- #: Out of restricted band.



802.11n (40MHz)

CHANNEL	TX Channel 102	DETECTOR FUNCTION	Peak (PK)
FREQUENCY RANGE	1GHz ~ 40GHz		Average (AV)

ANTENNA POLARITY & TEST DISTANCE: HORIZONTAL AT 3 M										
FREQ. (MHz)	EMISSION LEVEL (dBuV/m)	READ LEVEL (dBuV)	LIMIT (dBuV/m)	MARGIN (dB)	ANTENNA FACTOR (dB /m)	CABLE LOSS (dB)	PREAMP FACTOR (dB)	ANTENNA HEIGHT (cm)	TABLE ANGLE (Degree)	REMARK
5460	58.5	56.63	74	-15.5	36.26	7.49	41.88	100	72	Peak
5460	44.38	42.51	54	-9.62	36.26	7.49	41.88	100	72	Average
#5470	60.45	58.57	68.3	-7.85	36.27	7.49	41.88	100	72	Peak
5510	97.03	95.11			36.3	7.51	41.89	100	72	Peak
5510	86.64	84.72			36.3	7.51	41.89	100	72	Average

ANTENNA POLARITY & TEST DISTANCE: VERTICAL AT 3 M										
FREQ. (MHz)	EMISSION LEVEL (dBuV/m)	READ LEVEL (dBuV)	LIMIT (dBuV/m)	MARGIN (dB)	ANTENNA FACTOR (dB /m)	CABLE LOSS (dB)	PREAMP FACTOR (dB)	ANTENNA HEIGHT (cm)	TABLE ANGLE (Degree)	REMARK
5460	54.13	52.04	74	-19.87	36.48	7.49	41.88	100	0	Peak
5460	43.92	41.83	54	-10.08	36.48	7.49	41.88	100	0	Average
#5470	56.37	54.28	68.3	-11.93	36.48	7.49	41.88	100	0	Peak
5510	95.45	93.32			36.51	7.51	41.89	100	0	Peak
5510	84.99	82.86			36.51	7.51	41.89	100	0	Average

REMARKS:

- Emission Level = Read Level+ Antenna Factor + Cable Loss- Preamp Factor
Margin value = Emission level – Limit value.
- 5510MHz: Fundamental frequency.
- #: Out of restricted band.



CHANNEL	TX Channel 110	DETECTOR FUNCTION	Peak (PK)
FREQUENCY RANGE	1GHz ~ 40GHz		Average (AV)

ANTENNA POLARITY & TEST DISTANCE: HORIZONTAL AT 3 M										
FREQ. (MHz)	EMISSION LEVEL (dBuV/m)	READ LEVEL (dBuV)	LIMIT (dBuV/m)	MARGIN (dB)	ANTENNA FACTOR (dB /m)	CABLE LOSS (dB)	PREAMP FACTOR (dB)	ANTENNA HEIGHT (cm)	TABLE ANGLE (Degree)	REMARK
5460	53.31	51.44	74	-20.69	36.26	7.49	41.88	100	72	Peak
5460	42.86	40.99	54	-11.14	36.26	7.49	41.88	100	72	Average
#5470	54.84	52.96	68.3	-13.46	36.27	7.49	41.88	100	72	Peak
5550	95.89	93.93			36.32	7.55	41.91	100	72	Peak
5550	85.91	83.95			36.32	7.55	41.91	100	72	Average

ANTENNA POLARITY & TEST DISTANCE: VERTICAL AT 3 M										
FREQ. (MHz)	EMISSION LEVEL (dBuV/m)	READ LEVEL (dBuV)	LIMIT (dBuV/m)	MARGIN (dB)	ANTENNA FACTOR (dB /m)	CABLE LOSS (dB)	PREAMP FACTOR (dB)	ANTENNA HEIGHT (cm)	TABLE ANGLE (Degree)	REMARK
5460	51.72	49.63	74	-22.28	36.48	7.49	41.88	100	0	Peak
5460	42.92	40.83	54	-11.08	36.48	7.49	41.88	100	0	Average
#5470	52.61	50.52	68.3	-15.69	36.48	7.49	41.88	100	0	Peak
5550	95.59	93.42			36.53	7.55	41.91	100	0	Peak
5550	85.01	82.84			36.53	7.55	41.91	100	0	Average

REMARKS:

- Emission Level = Read Level+ Antenna Factor + Cable Loss- Preamp Factor
Margin value = Emission level – Limit value.
- 5550MHz: Fundamental frequency.
- #: Out of restricted band.



CHANNEL	TX Channel 134	DETECTOR FUNCTION	Peak (PK)
FREQUENCY RANGE	1GHz ~ 40GHz		Average (AV)

ANTENNA POLARITY & TEST DISTANCE: HORIZONTAL AT 3 M										
FREQ. (MHz)	EMISSION LEVEL (dBuV/m)	READ LEVEL (dBuV)	LIMIT (dBuV/m)	MARGIN (dB)	ANTENNA FACTOR (dB /m)	CABLE LOSS (dB)	PREAMP FACTOR (dB)	ANTENNA HEIGHT (cm)	TABLE ANGLE (Degree)	REMARK
5670	97.4	95.35			36.37	7.67	41.99	140	47	Peak
5670	87.8	85.75			36.37	7.67	41.99	140	47	Average
#5725	58.93	56.83	68.3	-9.37	36.39	7.73	42.02	140	47	Peak
ANTENNA POLARITY & TEST DISTANCE: VERTICAL AT 3 M										
FREQ. (MHz)	EMISSION LEVEL (dBuV/m)	READ LEVEL (dBuV)	LIMIT (dBuV/m)	MARGIN (dB)	ANTENNA FACTOR (dB /m)	CABLE LOSS (dB)	PREAMP FACTOR (dB)	ANTENNA HEIGHT (cm)	TABLE ANGLE (Degree)	REMARK
5670	94.39	92.11			36.6	7.67	41.99	100	207	Peak
5670	84.73	82.45			36.6	7.67	41.99	100	207	Average
#5725	56.57	54.23	68.3	-11.73	36.63	7.73	42.02	100	207	Peak

REMARKS:

- Emission Level = Read Level+ Antenna Factor + Cable Loss- Preamp Factor
Margin value = Emission level – Limit value.
- 5670MHz: Fundamental frequency.
- #: Out of restricted band.



802.11ac (80MHz)

CHANNEL	TX Channel 106	DETECTOR FUNCTION	Peak (PK)
FREQUENCY RANGE	1GHz ~ 40GHz		Average (AV)

ANTENNA POLARITY & TEST DISTANCE: HORIZONTAL AT 3 M										
FREQ. (MHz)	EMISSION LEVEL (dBuV/m)	READ LEVEL (dBuV)	LIMIT (dBuV/m)	MARGIN (dB)	ANTENNA FACTOR (dB /m)	CABLE LOSS (dB)	PREAMP FACTOR (dB)	ANTENNA HEIGHT (cm)	TABLE ANGLE (Degree)	REMARK
5460	59.77	57.68	74	-14.23	36.48	7.49	41.88	116	52	Peak
5460	47.72	45.63	54	-6.28	36.48	7.49	41.88	116	52	Average
#5470	63.33	61.24	68.3	-4.97	36.48	7.49	41.88	116	52	Peak
5530	104.5	102.35			36.52	7.53	41.9	116	52	Peak
5530	95.79	93.64			36.52	7.53	41.9	116	52	Average

ANTENNA POLARITY & TEST DISTANCE: VERTICAL AT 3 M										
FREQ. (MHz)	EMISSION LEVEL (dBuV/m)	READ LEVEL (dBuV)	LIMIT (dBuV/m)	MARGIN (dB)	ANTENNA FACTOR (dB /m)	CABLE LOSS (dB)	PREAMP FACTOR (dB)	ANTENNA HEIGHT (cm)	TABLE ANGLE (Degree)	REMARK
5460	58.93	56.84	74	-15.07	36.48	7.49	41.88	145	65	Peak
5460	46.57	44.48	54	-7.43	36.48	7.49	41.88	145	65	Average
#5470	60.75	58.66	68.3	-7.55	36.48	7.49	41.88	145	65	Peak
5530	102.3	100.15			36.52	7.53	41.9	145	65	Peak
5530	94.41	92.26			36.52	7.53	41.9	145	65	Average

REMARKS:

1. Emission Level = Read Level+ Antenna Factor + Cable Loss- Preamp Factor
Margin value = Emission level – Limit value.
2. 5530MHz: Fundamental frequency.
3. #: Out of restricted band.



Band 4

802.11a

CHANNEL	TX Channel 149	DETECTOR FUNCTION	Peak (PK)
FREQUENCY RANGE	1GHz ~ 40GHz		Average (AV)

ANTENNA POLARITY & TEST DISTANCE: HORIZONTAL AT 3 M										
FREQ. (MHz)	EMISSION LEVEL (dBuV/m)	READ LEVEL (dBuV)	LIMIT (dBuV/m)	MARGIN (dB)	ANTENNA FACTOR (dB /m)	CABLE LOSS (dB)	PREAMP FACTOR (dB)	ANTENNA HEIGHT (cm)	TABLE ANGLE (Degree)	REMARK
5745	102.94	100.83			36.4	7.75	42.04	100	325	Peak
5745	94.47	92.36			36.4	7.75	42.04	100	325	Average
ANTENNA POLARITY & TEST DISTANCE: VERTICAL AT 3 M										
FREQ. (MHz)	EMISSION LEVEL (dBuV/m)	READ LEVEL (dBuV)	LIMIT (dBuV/m)	MARGIN (dB)	ANTENNA FACTOR (dB /m)	CABLE LOSS (dB)	PREAMP FACTOR (dB)	ANTENNA HEIGHT (cm)	TABLE ANGLE (Degree)	REMARK
5745	100.98	98.62			36.65	7.75	42.04	100	321	Peak
5745	92.71	90.35			36.65	7.75	42.04	100	321	Average

REMARKS:

- Emission Level = Read Level+ Antenna Factor + Cable Loss- Preamp Factor
Margin value = Emission level – Limit value.
- 5745MHz: Fundamental frequency.



Oobe Data

802.11a

ANTENNA POLARITY & TEST DISTANCE: HORIZONTAL AT 3 M										
FREQ. (MHz)	EMISSION LEVEL (dBuV/m)	READ LEVEL (dBuV)	LIMIT (dBuV/m)	MARGIN (dB)	ANTENNA FACTOR (dB /m)	CABLE LOSS (dB)	PREAMP FACTOR (dB)	ANTENNA HEIGHT (cm)	TABLE ANGLE (Degree)	REMARK
5573.75	61.99	60.01	68.3	-6.31	36.33	7.58	41.93	200	360	Peak
5973.7	62.65	60.36	68.3	-5.65	36.49	7.98	42.18	200	360	Peak
ANTENNA POLARITY & TEST DISTANCE: VERTICAL AT 3 M										
FREQ. (MHz)	EMISSION LEVEL (dBuV/m)	READ LEVEL (dBuV)	LIMIT (dBuV/m)	MARGIN (dB)	ANTENNA FACTOR (dB /m)	CABLE LOSS (dB)	PREAMP FACTOR (dB)	ANTENNA HEIGHT (cm)	TABLE ANGLE (Degree)	REMARK
5556.65	63.1	60.93	68.3	-5.2	36.53	7.56	41.92	100	360	Peak
5978.93	62.58	59.99	68.3	-5.72	36.79	7.99	42.19	100	360	Peak

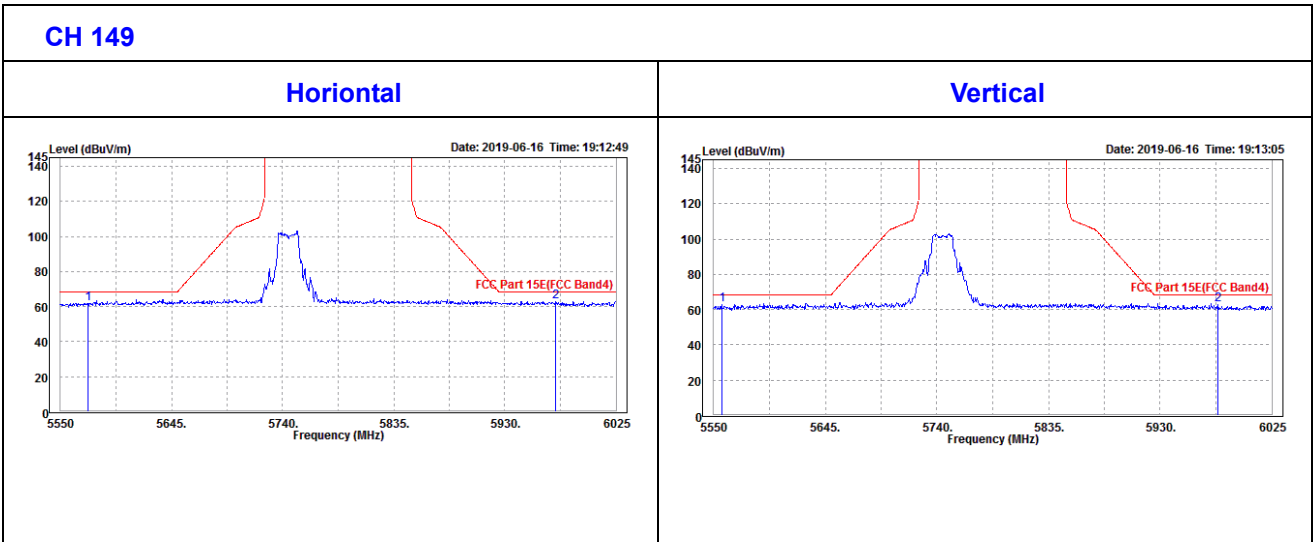



CHANNEL	TX Channel 157	DETECTOR FUNCTION	Peak (PK)
FREQUENCY RANGE	1GHz ~ 40GHz		Average (AV)

ANTENNA POLARITY & TEST DISTANCE: HORIZONTAL AT 3 M										
FREQ. (MHz)	EMISSION LEVEL (dBuV/m)	READ LEVEL (dBuV)	LIMIT (dBuV/m)	MARGIN (dB)	ANTENNA FACTOR (dB /m)	CABLE LOSS (dB)	PREAMP FACTOR (dB)	ANTENNA HEIGHT (cm)	TABLE ANGLE (Degree)	REMARK
5785	103.37	101.23			36.41	7.79	42.06	100	322	Peak
5785	95.79	93.65			36.41	7.79	42.06	100	322	Average

ANTENNA POLARITY & TEST DISTANCE: VERTICAL AT 3 M										
FREQ. (MHz)	EMISSION LEVEL (dBuV/m)	READ LEVEL (dBuV)	LIMIT (dBuV/m)	MARGIN (dB)	ANTENNA FACTOR (dB /m)	CABLE LOSS (dB)	PREAMP FACTOR (dB)	ANTENNA HEIGHT (cm)	TABLE ANGLE (Degree)	REMARK
5785	102.76	100.36			36.67	7.79	42.06	100	325	Peak
5785	93.63	91.23			36.67	7.79	42.06	100	325	Average

REMARKS:

- Emission Level = Read Level+ Antenna Factor + Cable Loss- Preamp Factor
Margin value = Emission level – Limit value.
- 5785MHz: Fundamental frequency.



Oobe Data

802.11a

ANTENNA POLARITY & TEST DISTANCE: HORIZONTAL AT 3 M										
FREQ. (MHz)	EMISSION LEVEL (dBuV/m)	READ LEVEL (dBuV)	LIMIT (dBuV/m)	MARGIN (dB)	ANTENNA FACTOR (dB /m)	CABLE LOSS (dB)	PREAMP FACTOR (dB)	ANTENNA HEIGHT (cm)	TABLE ANGLE (Degree)	REMARK
5567.58	61.58	59.6	68.3	-6.72	36.33	7.57	41.92	100	360	Peak
5954.23	61.29	59.02	68.3	-7.01	36.48	7.96	42.17	100	360	Peak
ANTENNA POLARITY & TEST DISTANCE: VERTICAL AT 3 M										
FREQ. (MHz)	EMISSION LEVEL (dBuV/m)	READ LEVEL (dBuV)	LIMIT (dBuV/m)	MARGIN (dB)	ANTENNA FACTOR (dB /m)	CABLE LOSS (dB)	PREAMP FACTOR (dB)	ANTENNA HEIGHT (cm)	TABLE ANGLE (Degree)	REMARK
5559.03	62.32	60.14	68.3	-5.98	36.54	7.56	41.92	100	0	Peak
5974.65	62.53	59.95	68.3	-5.77	36.78	7.98	42.18	100	0	Peak

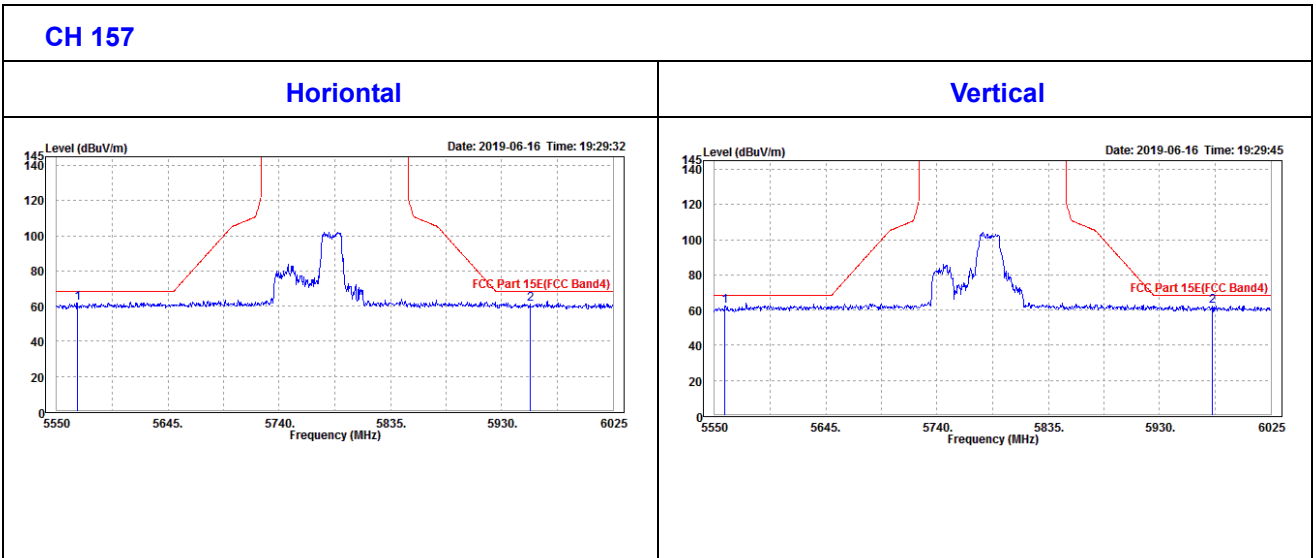



CHANNEL	TX Channel 165	DETECTOR FUNCTION	Peak (PK)
FREQUENCY RANGE	1GHz ~ 40GHz		Average (AV)

ANTENNA POLARITY & TEST DISTANCE: HORIZONTAL AT 3 M										
FREQ. (MHz)	EMISSION LEVEL (dBuV/m)	READ LEVEL (dBuV)	LIMIT (dBuV/m)	MARGIN (dB)	ANTENNA FACTOR (dB /m)	CABLE LOSS (dB)	PREAMP FACTOR (dB)	ANTENNA HEIGHT (cm)	TABLE ANGLE (Degree)	REMARK
5825	104.51	102.34			36.43	7.83	42.09	100	305	Peak
5825	96.38	94.21			36.43	7.83	42.09	100	305	Average

ANTENNA POLARITY & TEST DISTANCE: VERTICAL AT 3 M										
FREQ. (MHz)	EMISSION LEVEL (dBuV/m)	READ LEVEL (dBuV)	LIMIT (dBuV/m)	MARGIN (dB)	ANTENNA FACTOR (dB /m)	CABLE LOSS (dB)	PREAMP FACTOR (dB)	ANTENNA HEIGHT (cm)	TABLE ANGLE (Degree)	REMARK
5825	103.03	100.6			36.69	7.83	42.09	100	251	Peak
5825	94.95	92.52			36.69	7.83	42.09	100	251	Average

REMARKS:

1. Emission Level = Read Level+ Antenna Factor + Cable Loss- Preamp Factor
Margin value = Emission level – Limit value.
2. 5825MHz: Fundamental frequency.



OOBE DATA

802.11a

ANTENNA POLARITY & TEST DISTANCE: HORIZONTAL AT 3 M											
FREQ. (MHz)	EMISSION LEVEL (dBuV/m)	READ LEVEL (dBuV)	LIMIT (dBuV/m)	MARGIN (dB)	ANTENNA FACTOR (dB /m)	CABLE LOSS (dB)	PREAMP FACTOR (dB)	ANTENNA HEIGHT (cm)	TABLE ANGLE (Degree)	REMARK	
5565.68	61.07	59.09	68.3	-7.23	36.33	7.57	41.92	100	0	Peak	
5977.50	62.35	60.06	68.3	-5.95	36.49	7.99	42.19	100	0	Peak	
ANTENNA POLARITY & TEST DISTANCE: VERTICAL AT 3 M											
FREQ. (MHz)	EMISSION LEVEL (dBuV/m)	READ LEVEL (dBuV)	LIMIT (dBuV/m)	MARGIN (dB)	ANTENNA FACTOR (dB /m)	CABLE LOSS (dB)	PREAMP FACTOR (dB)	ANTENNA HEIGHT (cm)	TABLE ANGLE (Degree)	REMARK	
5556.18	62.05	59.88	68.3	-6.25	36.53	7.56	41.92	100	360	Peak	
5986.05	61.82	59.22	68.3	-6.48	36.79	8	42.19	100	360	Peak	

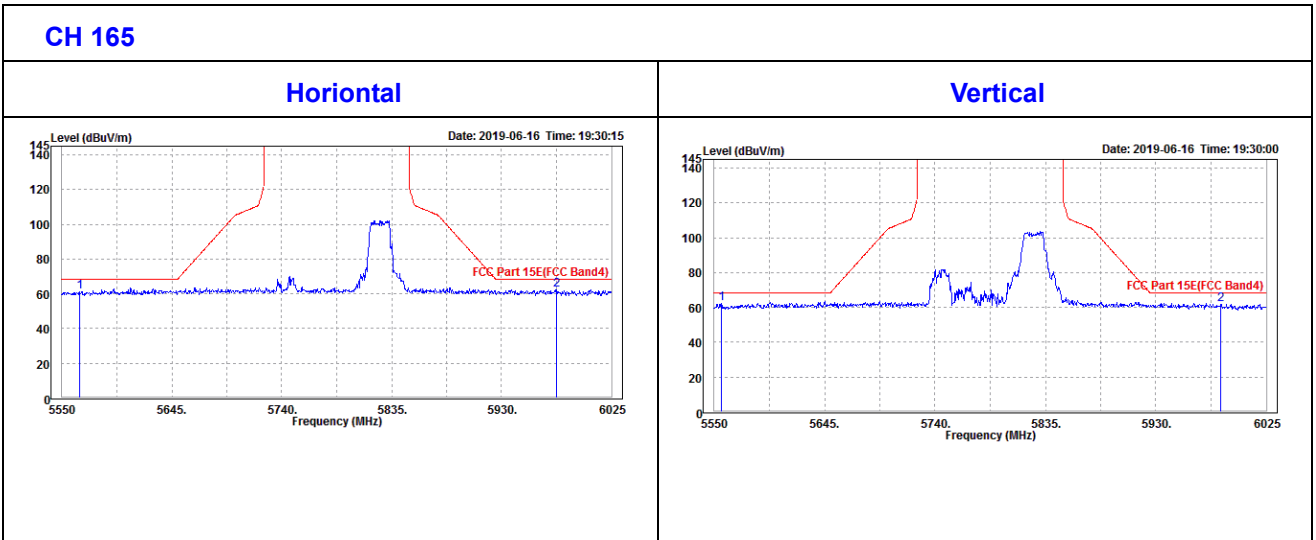



802.11n (20MHz)

CHANNEL	TX Channel 149	DETECTOR FUNCTION	Peak (PK)
FREQUENCY RANGE	1GHz ~ 40GHz		Average (AV)

ANTENNA POLARITY & TEST DISTANCE: HORIZONTAL AT 3 M										
FREQ. (MHz)	EMISSION LEVEL (dBuV/m)	READ LEVEL (dBuV)	LIMIT (dBuV/m)	MARGIN (dB)	ANTENNA FACTOR (dB /m)	CABLE LOSS (dB)	PREAMP FACTOR (dB)	ANTENNA HEIGHT (cm)	TABLE ANGLE (Degree)	REMARK
5745	103.43	101.32			36.4	7.75	42.04	100	256	Peak
5745	95.74	93.63			36.4	7.75	42.04	100	256	Average
ANTENNA POLARITY & TEST DISTANCE: VERTICAL AT 3 M										
FREQ. (MHz)	EMISSION LEVEL (dBuV/m)	READ LEVEL (dBuV)	LIMIT (dBuV/m)	MARGIN (dB)	ANTENNA FACTOR (dB /m)	CABLE LOSS (dB)	PREAMP FACTOR (dB)	ANTENNA HEIGHT (cm)	TABLE ANGLE (Degree)	REMARK
5745	94.86	100.25			36.65	0	42.04	100	236	Peak
5745	86.85	92.24			36.65	0	42.04	100	236	Average

REMARKS:

1. Emission Level = Read Level+ Antenna Factor + Cable Loss- Preamp Factor
Margin value = Emission level – Limit value.
2. 5745MHz: Fundamental frequency.



OUBE DATA

802.11n (20MHZ)

ANTENNA POLARITY & TEST DISTANCE: HORIZONTAL AT 3 M										
FREQ. (MHz)	EMISSION LEVEL (dBuV/m)	READ LEVEL (dBuV)	LIMIT (dBuV/m)	MARGIN (dB)	ANTENNA FACTOR (dB /m)	CABLE LOSS (dB)	PREAMP FACTOR (dB)	ANTENNA HEIGHT (cm)	TABLE ANGLE (Degree)	REMARK
5588.95	61.71	59.72	68.3	-6.59	36.34	7.59	41.94	100	0	Peak
5989.85	60.5	58.19	68.3	-7.8	36.5	8	42.19	100	0	Peak
ANTENNA POLARITY & TEST DISTANCE: VERTICAL AT 3 M										
FREQ. (MHz)	EMISSION LEVEL (dBuV/m)	READ LEVEL (dBuV)	LIMIT (dBuV/m)	MARGIN (dB)	ANTENNA FACTOR (dB /m)	CABLE LOSS (dB)	PREAMP FACTOR (dB)	ANTENNA HEIGHT (cm)	TABLE ANGLE (Degree)	REMARK
5556.18	61.32	59.15	68.3	-6.98	36.53	7.56	41.92	100	360	Peak
5939.03	62.64	60.09	68.3	-5.66	36.76	7.95	42.16	100	360	Peak

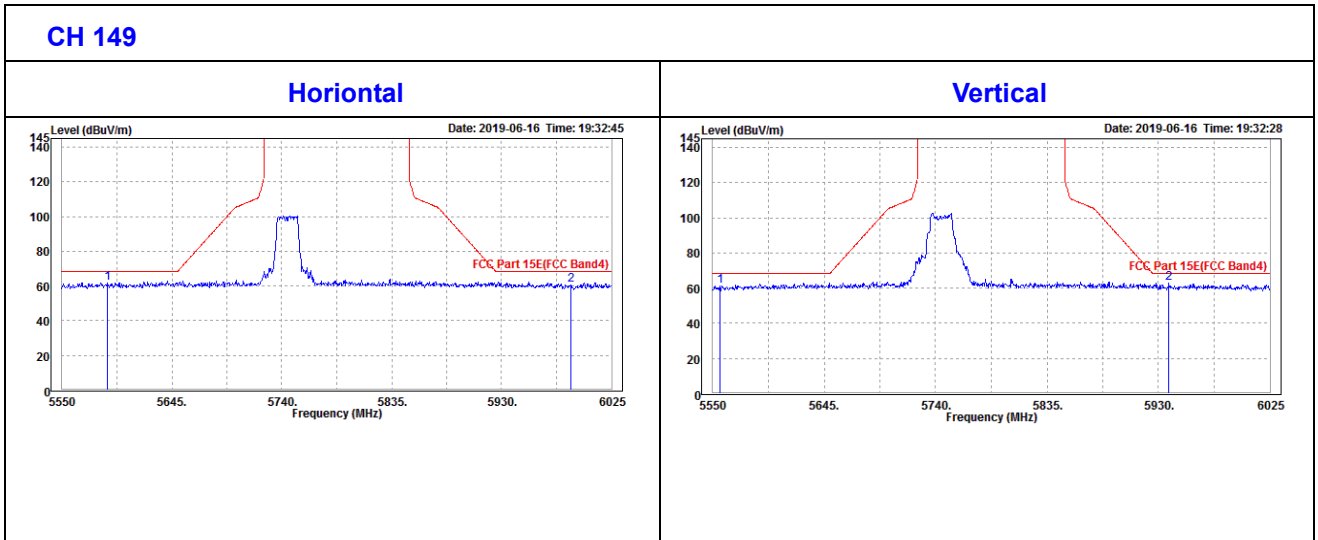



CHANNEL	TX Channel 157	DETECTOR FUNCTION	Peak (PK)
FREQUENCY RANGE	1GHz ~ 40GHz		Average (AV)

ANTENNA POLARITY & TEST DISTANCE: HORIZONTAL AT 3 M										
FREQ. (MHz)	EMISSION LEVEL (dBuV/m)	READ LEVEL (dBuV)	LIMIT (dBuV/m)	MARGIN (dB)	ANTENNA FACTOR (dB /m)	CABLE LOSS (dB)	PREAMP FACTOR (dB)	ANTENNA HEIGHT (cm)	TABLE ANGLE (Degree)	REMARK
5785	104.45	102.31			36.41	7.79	42.06	100	185	Peak
5785	95.59	93.45			36.41	7.79	42.06	100	185	Average

ANTENNA POLARITY & TEST DISTANCE: VERTICAL AT 3 M										
FREQ. (MHz)	EMISSION LEVEL (dBuV/m)	READ LEVEL (dBuV)	LIMIT (dBuV/m)	MARGIN (dB)	ANTENNA FACTOR (dB /m)	CABLE LOSS (dB)	PREAMP FACTOR (dB)	ANTENNA HEIGHT (cm)	TABLE ANGLE (Degree)	REMARK
5785	102.99	100.59			36.67	7.79	42.06	100	321	Peak
5785	94.98	92.58			36.67	7.79	42.06	100	321	Average

REMARKS:

1. Emission Level = Read Level+ Antenna Factor + Cable Loss- Preamp Factor
Margin value = Emission level – Limit value.
2. 5785MHz: Fundamental frequency.



OUBE DATA

802.11n (20MHZ)

ANTENNA POLARITY & TEST DISTANCE: HORIZONTAL AT 3 M											
FREQ. (MHz)	EMISSION LEVEL (dBuV/m)	READ LEVEL (dBuV)	LIMIT (dBuV/m)	MARGIN (dB)	ANTENNA FACTOR (dB /m)	CABLE LOSS (dB)	PREAMP FACTOR (dB)	ANTENNA HEIGHT (cm)	TABLE ANGLE (Degree)	REMARK	
5616.03	62.24	60.22	68.3	-6.06	36.35	7.62	41.95	100	0	Peak	
5951.85	61.28	59.01	68.3	-7.02	36.48	7.96	42.17	100	0	Peak	
ANTENNA POLARITY & TEST DISTANCE: VERTICAL AT 3 M											
FREQ. (MHz)	EMISSION LEVEL (dBuV/m)	READ LEVEL (dBuV)	LIMIT (dBuV/m)	MARGIN (dB)	ANTENNA FACTOR (dB /m)	CABLE LOSS (dB)	PREAMP FACTOR (dB)	ANTENNA HEIGHT (cm)	TABLE ANGLE (Degree)	REMARK	
5572.80	62.54	60.36	68.3	-5.76	36.54	7.57	41.93	100	360	Peak	
5973.23	60.79	58.21	68.3	-7.51	36.78	7.98	42.18	100	360	Peak	

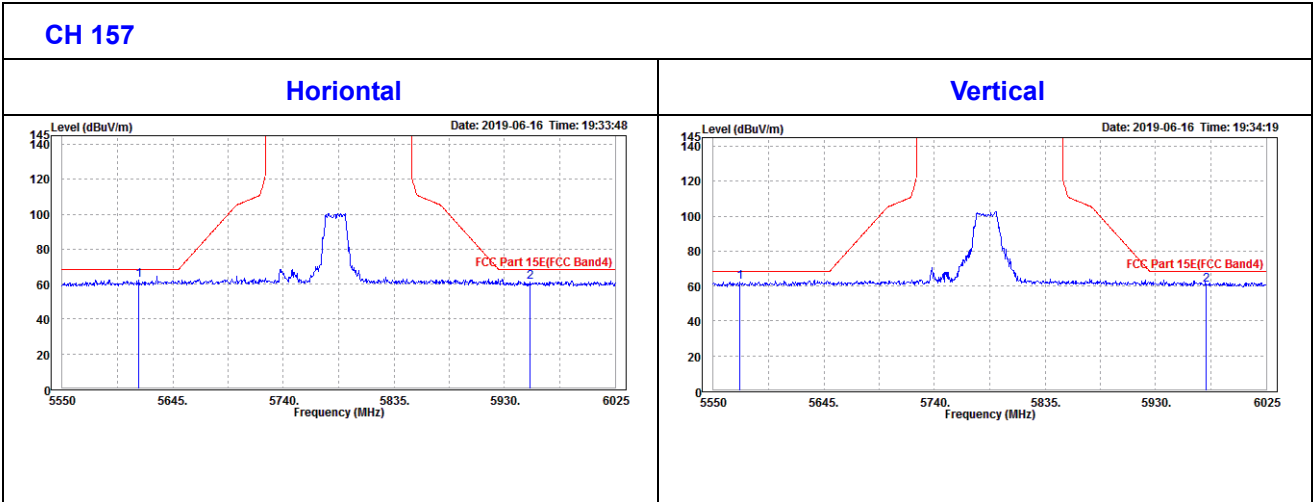



CHANNEL	TX Channel 165	DETECTOR FUNCTION	Peak (PK)
FREQUENCY RANGE	1GHz ~ 40GHz		Average (AV)

ANTENNA POLARITY & TEST DISTANCE: HORIZONTAL AT 3 M										
FREQ. (MHz)	EMISSION LEVEL (dBuV/m)	READ LEVEL (dBuV)	LIMIT (dBuV/m)	MARGIN (dB)	ANTENNA FACTOR (dB /m)	CABLE LOSS (dB)	PREAMP FACTOR (dB)	ANTENNA HEIGHT (cm)	TABLE ANGLE (Degree)	REMARK
5825	102.03	99.86			36.43	7.83	42.09	100	325	Peak
5825	93.71	91.54			36.43	7.83	42.09	100	325	Average

ANTENNA POLARITY & TEST DISTANCE: VERTICAL AT 3 M										
FREQ. (MHz)	EMISSION LEVEL (dBuV/m)	READ LEVEL (dBuV)	LIMIT (dBuV/m)	MARGIN (dB)	ANTENNA FACTOR (dB /m)	CABLE LOSS (dB)	PREAMP FACTOR (dB)	ANTENNA HEIGHT (cm)	TABLE ANGLE (Degree)	REMARK
5825	103.22	100.79			36.69	7.83	42.09	100	196	Peak
5825	94.8	92.37			36.69	7.83	42.09	100	196	Average

REMARKS:

1. Emission Level = Read Level+ Antenna Factor + Cable Loss- Preamp Factor
Margin value = Emission level – Limit value.
2. 5825MHz: Fundamental frequency.



OOBE DATA

802.11n (20MHZ)

ANTENNA POLARITY & TEST DISTANCE: HORIZONTAL AT 3 M											
FREQ. (MHz)	EMISSION LEVEL (dBuV/m)	READ LEVEL (dBuV)	LIMIT (dBuV/m)	MARGIN (dB)	ANTENNA FACTOR (dB /m)	CABLE LOSS (dB)	PREAMP FACTOR (dB)	ANTENNA HEIGHT (cm)	TABLE ANGLE (Degree)	REMARK	
5575.65	61.08	59.1	68.3	-7.22	36.33	7.58	41.93	100	360	Peak	
5981.3	61.28	58.99	68.3	-7.02	36.49	7.99	42.19	100	360	Peak	
ANTENNA POLARITY & TEST DISTANCE: VERTICAL AT 3 M											
FREQ. (MHz)	EMISSION LEVEL (dBuV/m)	READ LEVEL (dBuV)	LIMIT (dBuV/m)	MARGIN (dB)	ANTENNA FACTOR (dB /m)	CABLE LOSS (dB)	PREAMP FACTOR (dB)	ANTENNA HEIGHT (cm)	TABLE ANGLE (Degree)	REMARK	
5566.15	60.88	58.69	68.3	-7.42	36.54	7.57	41.92	100	0	Peak	
5949	61.37	58.81	68.3	-6.93	36.77	7.96	42.17	100	0	Peak	

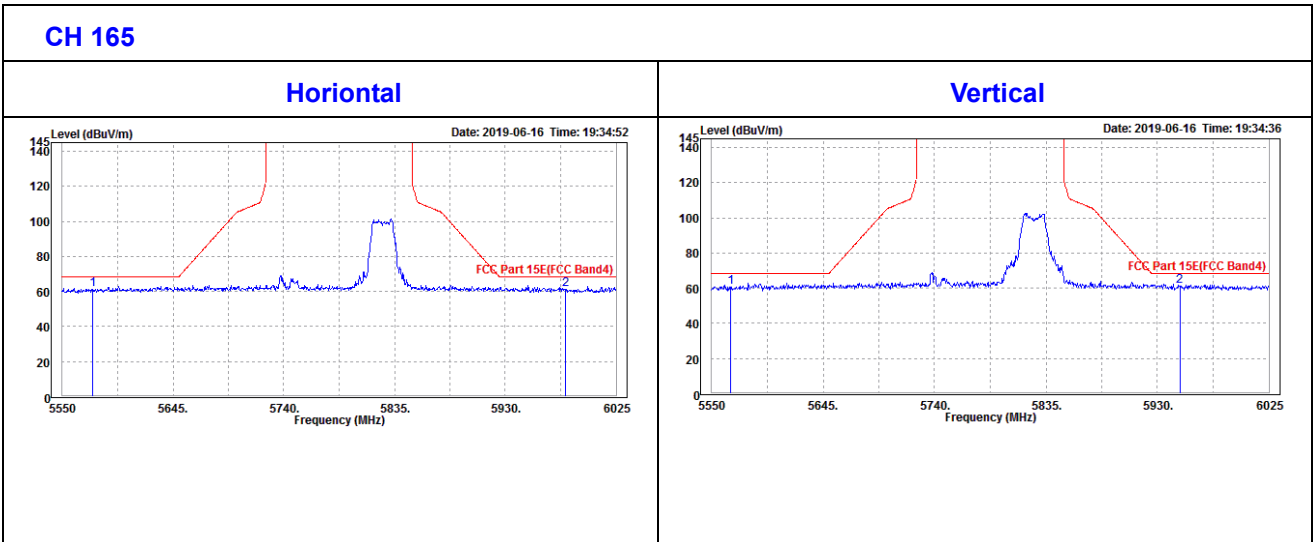



802.11n (40MHz)

CHANNEL	TX Channel 151	DETECTOR FUNCTION	Peak (PK)
FREQUENCY RANGE	1GHz ~ 40GHz		Average (AV)

ANTENNA POLARITY & TEST DISTANCE: HORIZONTAL AT 3 M										
FREQ. (MHz)	EMISSION LEVEL (dBuV/m)	READ LEVEL (dBuV)	LIMIT (dBuV/m)	MARGIN (dB)	ANTENNA FACTOR (dB /m)	CABLE LOSS (dB)	PREAMP FACTOR (dB)	ANTENNA HEIGHT (cm)	TABLE ANGLE (Degree)	REMARK
5755	100.4	102.42	74	26.4	36.4	7.76	46.18	100	215	Peak
5755	91.66	93.68	54	37.66	36.4	7.76	46.18	100	215	Average
ANTENNA POLARITY & TEST DISTANCE: VERTICAL AT 3 M										
FREQ. (MHz)	EMISSION LEVEL (dBuV/m)	READ LEVEL (dBuV)	LIMIT (dBuV/m)	MARGIN (dB)	ANTENNA FACTOR (dB /m)	CABLE LOSS (dB)	PREAMP FACTOR (dB)	ANTENNA HEIGHT (cm)	TABLE ANGLE (Degree)	REMARK
5755	99.87	101.64	74	25.87	36.65	7.76	46.18	100	328	Peak
5755	91.68	93.45	54	37.68	36.65	7.76	46.18	100	328	Average

REMARKS:

1. Emission Level = Read Level+ Antenna Factor + Cable Loss- Preamp Factor
Margin value = Emission level – Limit value.
2. 5755MHz: Fundamental frequency.



Oobe Data

802.11n (40MHz)

ANTENNA POLARITY & TEST DISTANCE: HORIZONTAL AT 3 M										
FREQ. (MHz)	EMISSION LEVEL (dBuV/m)	READ LEVEL (dBuV)	LIMIT (dBuV/m)	MARGIN (dB)	ANTENNA FACTOR (dB /m)	CABLE LOSS (dB)	PREAMP FACTOR (dB)	ANTENNA HEIGHT (cm)	TABLE ANGLE (Degree)	REMARK
5567.58	62.43	60.45	68.3	-5.87	36.33	7.57	41.92	100	0	Peak
5933.33	63.36	61.11	68.3	-4.94	36.47	7.94	42.16	100	0	Peak
ANTENNA POLARITY & TEST DISTANCE: VERTICAL AT 3 M										
FREQ. (MHz)	EMISSION LEVEL (dBuV/m)	READ LEVEL (dBuV)	LIMIT (dBuV/m)	MARGIN (dB)	ANTENNA FACTOR (dB /m)	CABLE LOSS (dB)	PREAMP FACTOR (dB)	ANTENNA HEIGHT (cm)	TABLE ANGLE (Degree)	REMARK
5572.80	63.9	61.72	68.3	-4.4	36.54	7.57	41.93	100	360	Peak
5947.58	61.82	59.26	68.3	-6.48	36.77	7.96	42.17	100	360	Peak

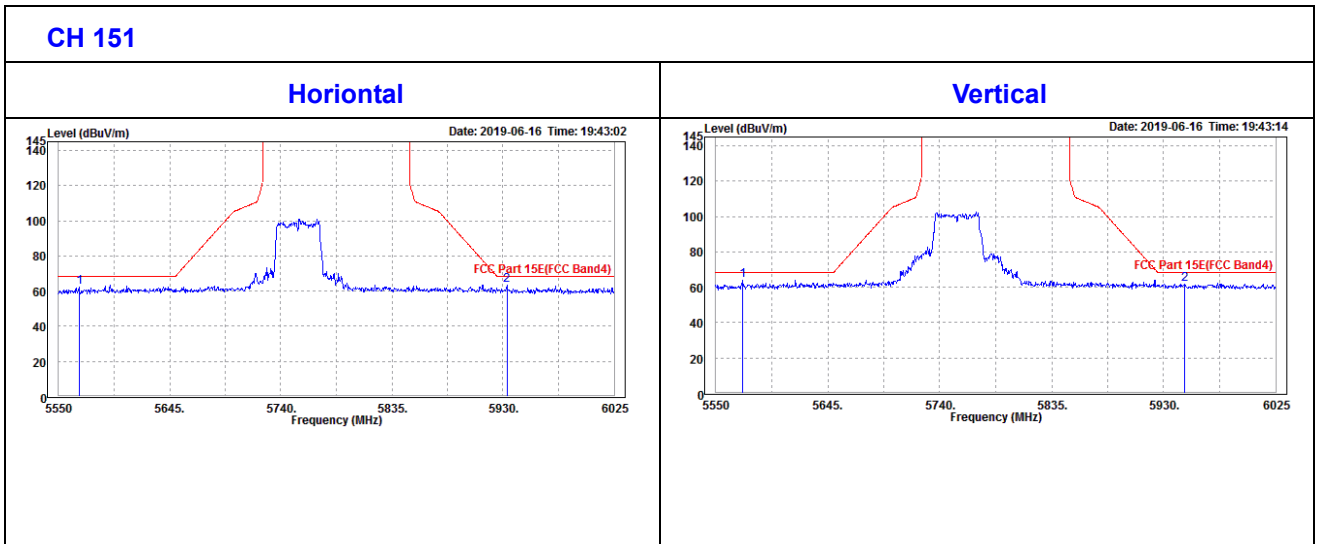



CHANNEL	TX Channel 159	DETECTOR FUNCTION	Peak (PK)
FREQUENCY RANGE	1GHz ~ 40GHz		Average (AV)

ANTENNA POLARITY & TEST DISTANCE: HORIZONTAL AT 3 M										
FREQ. (MHz)	EMISSION LEVEL (dBuV/m)	READ LEVEL (dBuV)	LIMIT (dBuV/m)	MARGIN (dB)	ANTENNA FACTOR (dB /m)	CABLE LOSS (dB)	PREAMP FACTOR (dB)	ANTENNA HEIGHT (cm)	TABLE ANGLE (Degree)	REMARK
5795	102.5	100.35			36.42	7.8	42.07	100	312	Peak
5795	93.71	91.56			36.42	7.8	42.07	100	312	Average

ANTENNA POLARITY & TEST DISTANCE: VERTICAL AT 3 M										
FREQ. (MHz)	EMISSION LEVEL (dBuV/m)	READ LEVEL (dBuV)	LIMIT (dBuV/m)	MARGIN (dB)	ANTENNA FACTOR (dB /m)	CABLE LOSS (dB)	PREAMP FACTOR (dB)	ANTENNA HEIGHT (cm)	TABLE ANGLE (Degree)	REMARK
5795	104.75	102.34			36.68	7.8	42.07	100	326	Peak
5795	96.06	93.65			36.68	7.8	42.07	100	326	Average

REMARKS:

1. Emission Level = Read Level+ Antenna Factor + Cable Loss- Preamp Factor
Margin value = Emission level – Limit value.
2. 5795MHz: Fundamental frequency.



Oobe Data

802.11n (40MHz)

ANTENNA POLARITY & TEST DISTANCE: HORIZONTAL AT 3 M											
FREQ. (MHz)	EMISSION LEVEL (dBuV/m)	READ LEVEL (dBuV)	LIMIT (dBuV/m)	MARGIN (dB)	ANTENNA FACTOR (dB /m)	CABLE LOSS (dB)	PREAMP FACTOR (dB)	ANTENNA HEIGHT (cm)	TABLE ANGLE (Degree)	REMARK	
5574.7	61.33	59.35	68.3	-6.97	36.33	7.58	41.93	100	360	Peak	
5960.4	61.42	59.14	68.3	-6.88	36.48	7.97	42.17	100	360	Peak	
ANTENNA POLARITY & TEST DISTANCE: VERTICAL AT 3 M											
FREQ. (MHz)	EMISSION LEVEL (dBuV/m)	READ LEVEL (dBuV)	LIMIT (dBuV/m)	MARGIN (dB)	ANTENNA FACTOR (dB /m)	CABLE LOSS (dB)	PREAMP FACTOR (dB)	ANTENNA HEIGHT (cm)	TABLE ANGLE (Degree)	REMARK	
5573.75	61.49	59.3	68.3	-6.81	36.54	7.58	41.93	100	0	Peak	
5948.53	61.68	59.12	68.3	-6.62	36.77	7.96	42.17	100	0	Peak	

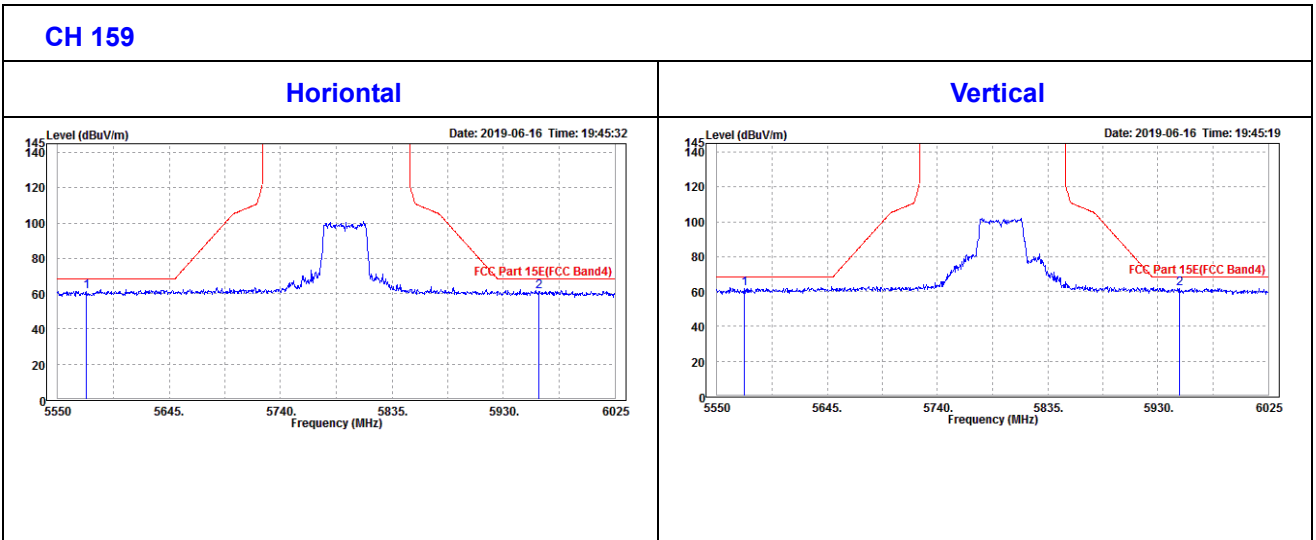



802.11ac (80MHz)

CHANNEL	TX Channel 155	DETECTOR FUNCTION	Peak (PK)
FREQUENCY RANGE	1GHz ~ 40GHz		Average (AV)

ANTENNA POLARITY & TEST DISTANCE: HORIZONTAL AT 3 M										
FREQ. (MHz)	EMISSION LEVEL (dBuV/m)	READ LEVEL (dBuV)	LIMIT (dBuV/m)	MARGIN (dB)	ANTENNA FACTOR (dB /m)	CABLE LOSS (dB)	PREAMP FACTOR (dB)	ANTENNA HEIGHT (cm)	TABLE ANGLE (Degree)	REMARK
5775	104.48	102.35			36.41	7.78	42.06	100	324	Peak
5775	95.78	93.65			36.41	7.78	42.06	100	324	Average
ANTENNA POLARITY & TEST DISTANCE: VERTICAL AT 3 M										
FREQ. (MHz)	EMISSION LEVEL (dBuV/m)	READ LEVEL (dBuV)	LIMIT (dBuV/m)	MARGIN (dB)	ANTENNA FACTOR (dB /m)	CABLE LOSS (dB)	PREAMP FACTOR (dB)	ANTENNA HEIGHT (cm)	TABLE ANGLE (Degree)	REMARK
5775	103.08	100.69			36.67	7.78	42.06	100	315	Peak
5775	95	92.61			36.67	7.78	42.06	100	315	Average

REMARKS:

1. Emission Level = Read Level+ Antenna Factor + Cable Loss- Preamp Factor
Margin value = Emission level – Limit value.
2. 5775MHz: Fundamental frequency.



Oobe Data

802.11ac (80MHz)

ANTENNA POLARITY & TEST DISTANCE: HORIZONTAL AT 3 M										
FREQ. (MHz)	EMISSION LEVEL (dBuV/m)	READ LEVEL (dBuV)	LIMIT (dBuV/m)	MARGIN (dB)	ANTENNA FACTOR (dB /m)	CABLE LOSS (dB)	PREAMP FACTOR (dB)	ANTENNA HEIGHT (cm)	TABLE ANGLE (Degree)	REMARK
5594.18	61.75	59.75	68.3	-6.55	36.34	7.6	41.94	100	0	Peak
5996.5	61.31	59	68.3	-6.99	36.5	8.01	42.2	100	0	Peak
ANTENNA POLARITY & TEST DISTANCE: VERTICAL AT 3 M										
FREQ. (MHz)	EMISSION LEVEL (dBuV/m)	READ LEVEL (dBuV)	LIMIT (dBuV/m)	MARGIN (dB)	ANTENNA FACTOR (dB /m)	CABLE LOSS (dB)	PREAMP FACTOR (dB)	ANTENNA HEIGHT (cm)	TABLE ANGLE (Degree)	REMARK
5569.48	61.99	59.8	68.3	-6.31	36.54	7.57	41.92	100	360	Peak
5997.93	62.12	59.51	68.3	-6.18	36.8	8.01	42.2	100	360	Peak

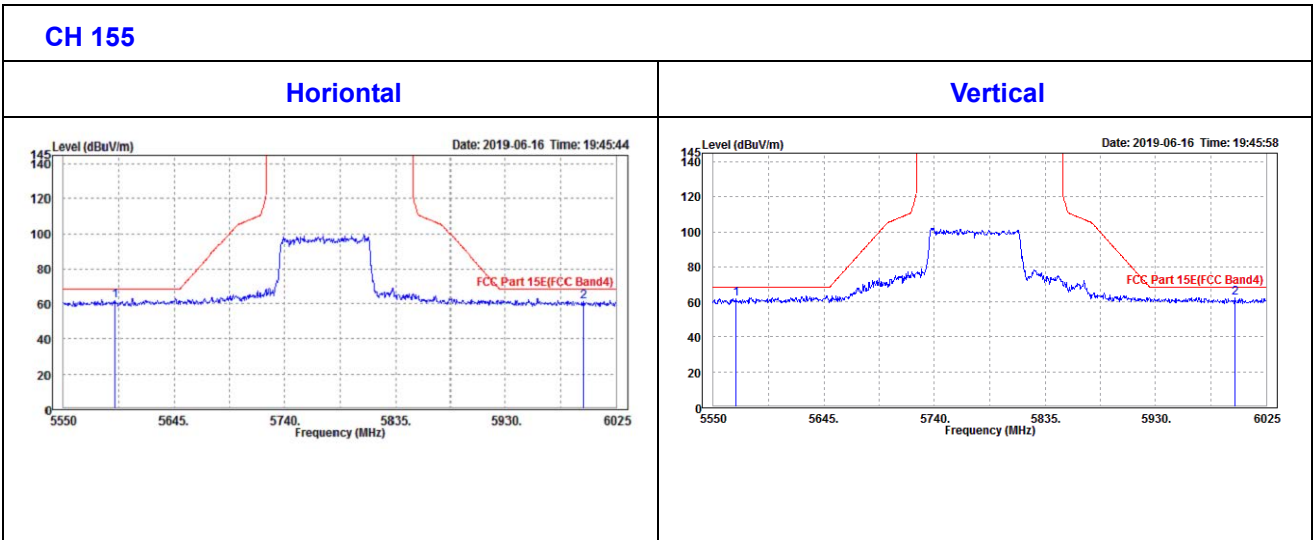



SK800

ABOVE 1GHz WORST-CASE DATA:

Note: For higher frequency, the emission is too low to be detected.

Band 2

802.11a

CHANNEL	TX Channel 64	DETECTOR FUNCTION	Peak (PK)
FREQUENCY RANGE	1GHz ~ 40GHz		Average (AV)

ANTENNA POLARITY & TEST DISTANCE: HORIZONTAL AT 3 M										
FREQ. (MHz)	EMISSION LEVEL (dBuV/m)	READ LEVEL (dBuV)	LIMIT (dBuV/m)	MARGIN (dB)	ANTENNA FACTOR (dB /m)	CABLE LOSS (dB)	PREAMP FACTOR (dB)	ANTENNA HEIGHT (cm)	TABLE ANGLE (Degree)	REMARK
5150	63.45	66.43	74	-10.55	35.95	7.42	46.35	200	130	Peak
5150	44.91	47.89	54	-9.09	35.95	7.42	46.35	200	130	Average
5320	102.7	105.42			36.12	7.46	46.3	200	130	Peak
5320	88.86	91.58			36.12	7.46	46.3	200	130	Average
5350	62.79	65.47	74	-11.21	36.15	7.47	46.3	200	130	Peak
5350	44.85	47.53	54	-9.15	36.15	7.47	46.3	200	130	Average
ANTENNA POLARITY & TEST DISTANCE: VERTICAL AT 3 M										
FREQ. (MHz)	EMISSION LEVEL (dBuV/m)	READ LEVEL (dBuV)	LIMIT (dBuV/m)	MARGIN (dB)	ANTENNA FACTOR (dB /m)	CABLE LOSS (dB)	PREAMP FACTOR (dB)	ANTENNA HEIGHT (cm)	TABLE ANGLE (Degree)	REMARK
5150	63.36	66	74	-10.64	36.29	7.42	46.35	200	180	Peak
5150	43.45	46.09	54	-10.55	36.29	7.42	46.35	200	180	Average
5320	102.07	104.52			36.39	7.46	46.3	200	180	Peak
5320	90.67	93.12			36.39	7.46	46.3	200	180	Average
5350	64.81	67.23	74	-9.19	36.41	7.47	46.3	200	180	Peak
5350	43.37	45.79	54	-10.63	36.41	7.47	46.3	200	200	Average

REMARKS:

1. Emission Level = Read Level+ Antenna Factor + Cable Loss- Preamp Factor
Margin value = Emission level – Limit value.
2. 5320MHz: Fundamental frequency.



3.2 CONDUCTED EMISSION MEASUREMENT

3.2.1 LIMITS OF CONDUCTED EMISSION MEASUREMENT

FREQUENCY OF EMISSION (MHz)	CONDUCTED LIMIT (dBµV)	
	Quasi-peak	Average
0.15 ~ 0.5	66 to 56	56 to 46
0.5 ~ 5	56	46
5 ~ 30	60	50

- NOTE:**
1. The lower limit shall apply at the transition frequencies.
 2. The limit decreases in line with the logarithm of the frequency in the range of 0.15 to 0.50MHz.
 3. All emanations from a class A/B digital device or system, including any network of conductors and apparatus connected thereto, shall not exceed the level of field strengths specified above.

3.2.2 TEST INSTRUMENTS

Equipment	Manufacturer	Model No.	Serial No.	Last Cal.	Next Cal.
EMI Test Receiver	Rohde&Schwarz	ESR3	101900	Feb. 26,19	Feb. 25,20
EMC32 test software	Rohde&Schwarz	EMC32	NA	NA	NA
LISN network	Rohde&Schwarz	ENV216	101922	Feb. 26,19	Feb. 25,20

- NOTE:**
1. The test was performed in CE shielded room.
 2. The calibration interval of the above test instruments is 12 months. And the calibrations are traceable to CEPREI/CHINA, GRGT/CHINA and NIM/CHINA.

3.2.3 TEST PROCEDURES

- a. The EUT was placed 0.4 meters from the conducting wall of the shielded room with EUT being connected to the power mains through a line impedance stabilization network (LISN). Other support units were connected to the power mains through another LISN. The two LISNs provide 50 ohm/ 50uH of coupling impedance for the measuring instrument.
- b. Both lines of the power mains connected to the EUT were checked for maximum conducted interference.
- c. The frequency range from 150kHz to 30MHz was searched. Emission levels under (Limit - 20dB) was not recorded.

NOTE: All modes of operation were investigated and the worst-case emissions are reported.



3.2.4 DEVIATION FROM TEST STANDARD

No deviation.

3.2.5 TEST SETUP

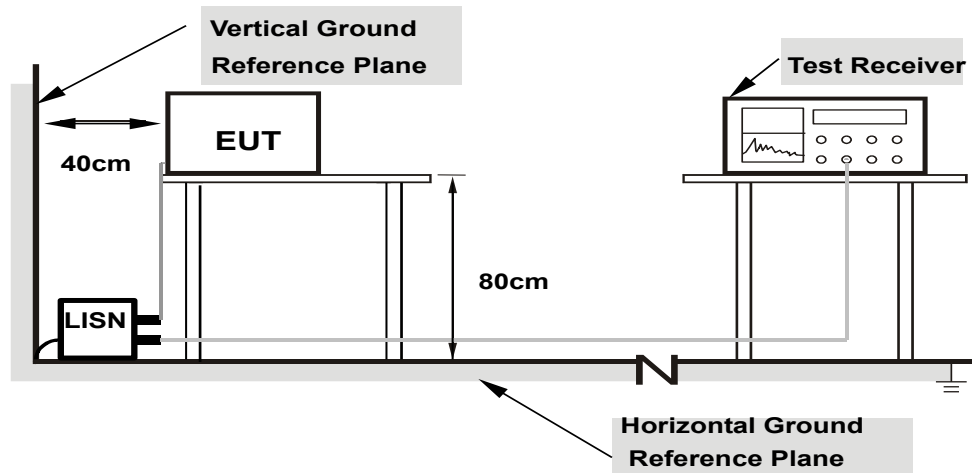

- Note: 1.Support units were connected to second LISN.
2.Both of LISNs (AMN) are 80 cm from EUT and at least 80
from other units and other metal planes**

For the actual test configuration, please refer to the attached file (Test Setup Photo).

3.2.6 EUT OPERATING CONDITIONS

Same as 3.1.6.



3.2.7 TEST RESULTS

CONDUCTED WORST-CASE DATA: SK600

Frequency Range	150KHz ~ 30MHz	Detector Function & Resolution Bandwidth	Quasi-Peak (QP) / Average (AV), 9 kHz
Input Power	120Vac, 60Hz	Environmental Conditions	25deg. C, 52RH
Tested By	Tony	TEST DATE	2019/11/25
Test Voltage	AC 120V		

Frequency (MHz)	QuasiPeak (dBuV)	CAverage (dBuV)	Limit (dBuV)	Margin (dB)	Line	Filter	Corr. (dB)
0.162000	---	36.40	55.36	-18.96	L	ON	9.9
0.162000	46.35	---	65.36	-19.01	L	ON	9.9
0.408000	---	41.63	47.69	-6.06	L	ON	10.0
0.408000	47.28	---	57.69	-10.41	L	ON	10.0
0.436000	---	33.19	47.14	-13.95	L	ON	10.0
0.436000	39.78	---	57.14	-17.36	L	ON	10.0
0.824000	---	23.98	46.00	-22.02	L	ON	10.1
0.824000	30.50	---	56.00	-25.50	L	ON	10.1
1.220000	---	18.99	46.00	-27.01	L	ON	10.1
1.220000	26.48	---	56.00	-29.52	L	ON	10.1
13.560000	---	29.93	50.00	-20.07	L	ON	10.5
13.560000	40.06	---	60.00	-19.94	L	ON	10.5

- REMARKS:**
1. Q.P. and AV. are abbreviations of quasi-peak and average individually.
 2. "-": The Quasi-peak reading value also meets average limit and measurement with the average detector is unnecessary.
 3. The emission levels of other frequencies were very low against the limit.
 4. Margin value = Emission level - Limit value
 5. Correction factor = Insertion loss + Cable loss
 6. Emission Level = Correction Factor + Reading Value.

Full Spectrum

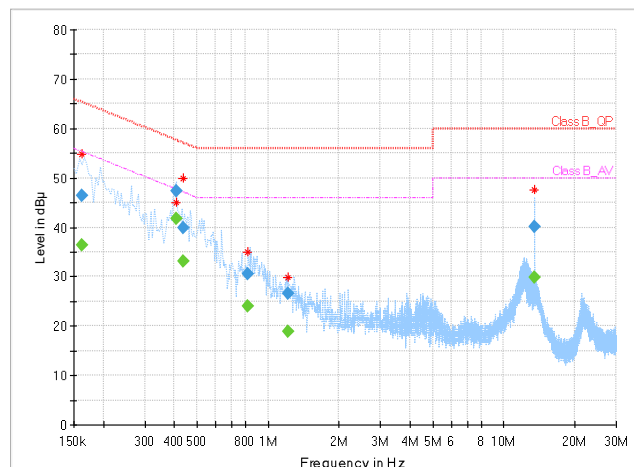



Frequency Range	150KHz ~ 30MHz	Detector Function & Resolution Bandwidth	Quasi-Peak (QP) / Average (AV), 9 kHz
Input Power	120Vac, 60Hz	Environmental Conditions	25deg. C, 52RH
Tested By	Tony	TEST DATE	2019/11/25
Test Voltage	AC 120V		

Frequency (MHz)	QuasiPeak (dBuV)	CAverage (dBuV)	Limit (dBuV)	Margin (dB)	Line	Filter	Corr. (dB)
0.154000	---	37.17	55.78	-18.61	N	ON	9.9
0.154000	48.26	---	65.78	-17.52	N	ON	9.9
0.404000	---	41.04	47.77	-6.73	N	ON	9.9
0.404000	45.84	---	57.77	-11.93	N	ON	9.9
0.412000	---	38.26	47.61	-9.34	N	ON	9.9
0.412000	46.17	---	57.61	-11.44	N	ON	9.9
0.752000	---	19.32	46.00	-26.68	N	ON	9.9
0.752000	28.22	---	56.00	-27.78	N	ON	9.9
1.300000	---	18.50	46.00	-27.50	N	ON	10.0
1.300000	25.49	---	56.00	-30.51	N	ON	10.0

- REMARKS:**
1. Q.P. and AV. are abbreviations of quasi-peak and average individually.
 2. "-": The Quasi-peak reading value also meets average limit and measurement with the average detector is unnecessary.
 3. The emission levels of other frequencies were very low against the limit.
 4. Margin value = Emission level - Limit value
 5. Correction factor = Insertion loss + Cable loss
 6. Emission Level = Correction Factor + Reading Value.

Full Spectrum

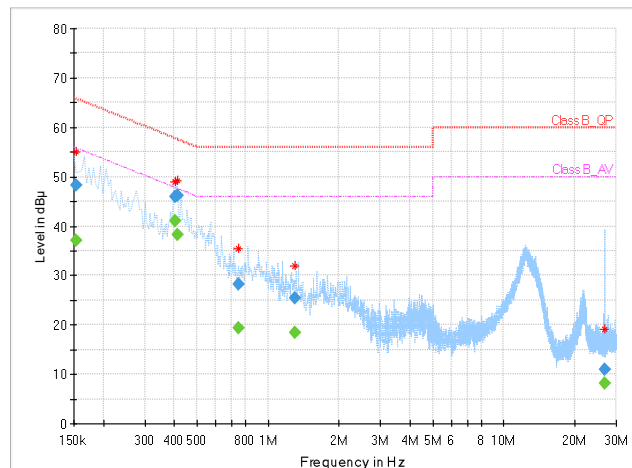



**BUREAU
VERITAS**

Test Report No.: RF191120W002-3

SK800

Frequency Range	150KHz ~ 30MHz	Detector Function & Resolution Bandwidth	Quasi-Peak (QP) / Average (AV), 9 kHz
Input Power	120Vac, 60Hz	Environmental Conditions	25deg. C, 52RH
Tested By	Tony	TEST DATE	2019/11/25
Test Voltage	AC 120V		

Frequency (MHz)	QuasiPeak (dBuV)	CAverage (dBuV)	Limit (dBuV)	Margin (dB)	Line	Filter	Corr. (dB)
0.158000	---	30.40	55.57	-25.17	L	ON	9.9
0.158000	43.94	---	65.57	-21.63	L	ON	9.9
0.460000	---	22.71	46.69	-23.98	L	ON	10.0
0.460000	30.47	---	56.69	-26.22	L	ON	10.0
0.528000	---	22.50	46.00	-23.50	L	ON	10.0
0.528000	33.46	---	56.00	-22.54	L	ON	10.0
0.936000	---	17.23	46.00	-28.77	L	ON	10.1
0.936000	26.02	---	56.00	-29.98	L	ON	10.1
3.480000	---	18.44	46.00	-27.56	L	ON	10.2
3.480000	30.99	---	56.00	-25.01	L	ON	10.2
4.128000	---	14.82	46.00	-31.18	L	ON	10.2
4.128000	24.70	---	56.00	-31.30	L	ON	10.2

- REMARKS:**
1. Q.P. and AV. are abbreviations of quasi-peak and average individually.
 2. "-": The Quasi-peak reading value also meets average limit and measurement with the average detector is unnecessary.
 3. The emission levels of other frequencies were very low against the limit.
 4. Margin value = Emission level - Limit value
 5. Correction factor = Insertion loss + Cable loss
 6. Emission Level = Correction Factor + Reading Value.

Full Spectrum

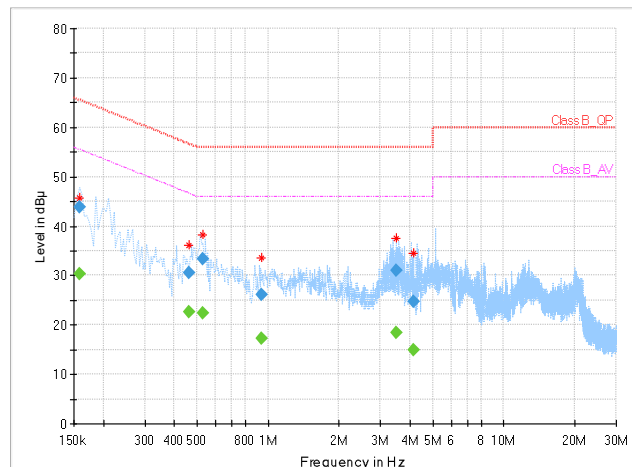



Frequency Range	150KHz ~ 30MHz	Detector Function & Resolution Bandwidth	Quasi-Peak (QP) / Average (AV), 9 kHz
Input Power	120Vac, 60Hz	Environmental Conditions	25deg. C, 52RH
Tested By	Tony	TEST DATE	2019/11/25
Test Voltage	AC 120V		

Frequency (MHz)	QuasiPeak (dBuV)	CAverage (dBuV)	Limit (dBuV)	Margin (dB)	Line	Filter	Corr. (dB)
0.150000	---	30.23	56.00	-25.77	N	ON	9.9
0.150000	43.92	---	66.00	-22.08	N	ON	9.9
0.200000	---	26.26	53.61	-27.35	N	ON	9.9
0.200000	39.99	---	63.61	-23.62	N	ON	9.9
0.512000	---	20.96	46.00	-25.04	N	ON	9.9
0.512000	31.09	---	56.00	-24.91	N	ON	9.9
1.784000	---	21.48	46.00	-24.52	N	ON	10.0
1.784000	26.70	---	56.00	-29.30	N	ON	10.0
3.560000	---	24.82	46.00	-21.18	N	ON	10.1
3.560000	37.01	---	56.00	-18.99	N	ON	10.1
3.724000	---	19.68	46.00	-26.32	N	ON	10.1
3.724000	32.33	---	56.00	-23.67	N	ON	10.1

- REMARKS:**
1. Q.P. and AV. are abbreviations of quasi-peak and average individually.
 2. "-": The Quasi-peak reading value also meets average limit and measurement with the average detector is unnecessary.
 3. The emission levels of other frequencies were very low against the limit.
 4. Margin value = Emission level - Limit value
 5. Correction factor = Insertion loss + Cable loss
 6. Emission Level = Correction Factor + Reading Value.

Full Spectrum

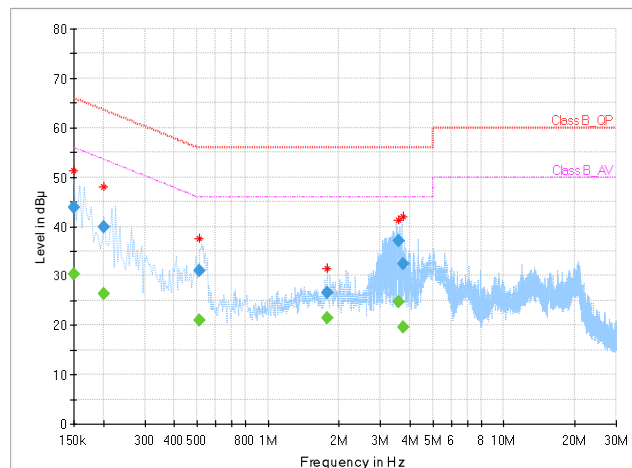



3.3 MAXIMUM CONDUCTED OUTPUT POWER MEASUREMENT

3.3.1 LIMITS OF MAXIMUM CONDUCTED OUTPUT POWER MEASUREMENT

Operation Band	EUT Category		LIMIT
U-NII-1		Outdoor Access Point	1 Watt (30 dBm) (Max. e.i.r.p ≤ 125mW(21 dBm) at any elevation angle above 30 degrees as measured from the horizon)
		Fixed point-to-point Access Point	1 Watt (30 dBm)
		Indoor Access Point	1 Watt (30 dBm)
	√	Client devices	250mW (24 dBm)
U-NII-2A	√		250mW (24 dBm) or 11 dBm+10 log B*
U-NII-2C	√		250mW (24 dBm) or 11 dBm+10 log B*
U-NII-3	√		1 Watt (30 dBm)

NOTE: Where B is the 26dB emission bandwidth in MHz.



3.3.2 TEST SETUP

FOR POWER OUTPUT MEASUREMENT

802.11a, 802.11n (20MHz), 802.11n (40MHz) TEST CONFIGURATION

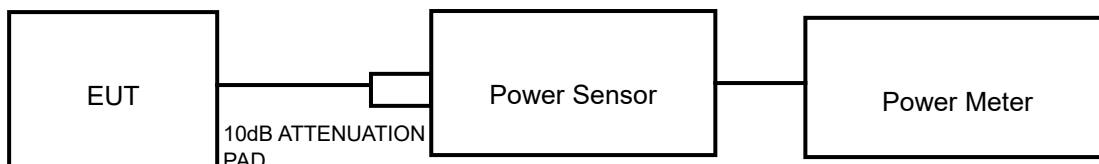

11ac TEST CONFIGURATION

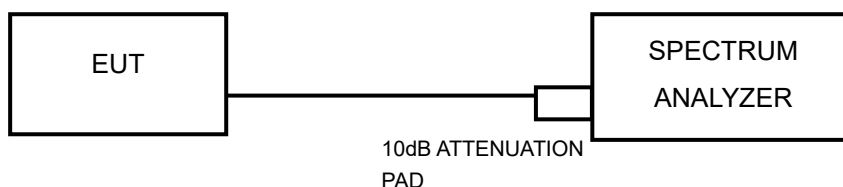

FOR 26dB BANDWIDTH

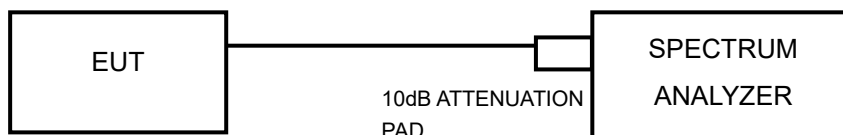

3.3.3 TEST INSTRUMENTS

Equipment	Manufacturer	Model No.	Serial No.	Last Cal.	Next Cal.
Power Meter	ANRITSU	ML2495A	1506002	Feb. 26,19	Feb. 25,20
EXA Signal Analyzer	KEYSIGHT	N9010A-526	MY54510322	Feb. 26,19	Feb. 25,20
EXA Signal Analyzer	KEYSIGHT	N9010A-544	MY54510355	Feb. 26,19	Feb. 25,20
Power Sensor	ANRITSU	MA2411B	1339352	Feb. 26,19	Feb. 25,20

NOTE:

1. The calibration interval of the above test instruments is 12 months and the calibrations are traceable to CEPREI/CHINA, GRGT/CHINA and NIM/CHINA.
2. The test was performed in RF Oven room.



3.3.4 TEST PROCEDURE

FOR POWER MEASUREMENT

For 802.11a, 802.11n (20MHz), 802.11n (40MHz)

Method PM is used to perform output power measurement, trigger and gating function of wide band power meter is enabled to measure max output power of TX on burst. Duty factor is not added to measured value.

For 802.11ac (80MHz)

1. Measure the duty cycle, x , of the transmitter output signal as described in II.B.
2. Set span to encompass the EBW (or, alternatively, the entire 99% occupied bandwidth) of the signal.
3. Set RBW = 1 MHz.
4. Set VBW \geq 3 MHz.
5. Number of points in sweep $\geq 2 \times \text{span} / \text{RBW}$. (This ensures that bin-to-bin spacing is $\leq \text{RBW}/2$, so that narrowband signals are not lost between frequency bins.)
6. Sweep time = auto.
7. Detector = power averaging (rms), if available. Otherwise, use sample detector mode.
8. Do not use sweep triggering. Allow the sweep to “free run.”
9. Trace average at least 100 traces in power averaging (rms) mode; however, the number of traces to be averaged shall be increased above 100 as needed to ensure that the average accurately represents the true average over the on and off periods of the transmitter.
10. Add $10 \log (1/x)$, where x is the duty cycle, to the measured power to compute the average power during the actual transmission times (because the measurement represents an average over both the on and off times of the transmission). For example, add $10 \log (1/0.25) = 6 \text{ dB}$ if the duty cycle is 25%.



FOR 99 PERCENT OCCUPIED BANDWIDTH

The following procedure shall be used for measuring (99 %) power bandwidth:

1. Set center frequency to the nominal EUT channel center frequency.
2. Set span = 1.5 times to 5.0 times the OBW.
3. Set RBW = 1 % to 5 % of the OBW
4. Set VBW $\geq 3 \cdot$ RBW
5. Video averaging is not permitted. Where practical, a sample detection and single sweep mode shall be used. Otherwise, peak detection and max hold mode (until the trace stabilizes) shall be used.
6. Use the 99 % power bandwidth function of the instrument (if available).
7. If the instrument does not have a 99 % power bandwidth function, the trace data points are recovered and directly summed in power units. The recovered amplitude data points, beginning at the lowest frequency, are placed in a running sum until 0.5 % of the total is reached; that frequency is recorded as the lower frequency. The process is repeated until 99.5 % of the total is reached; that frequency is recorded as the upper frequency. The 99% occupied bandwidth is the difference between these two frequencies.

FOR 26dB BANDWIDTH

- 1) Set RBW = approximately 1% of the emission bandwidth.
- 2) Set the VBW > RBW.
- 3) Detector = Peak.
- 4) Trace mode = max hold.
- 5) Measure the maximum width of the emission that is 26 dB down from the peak of the emission. Compare this with the RBW setting of the analyzer. Readjust RBW and repeat measurement as needed until the RBW/EBW ratio is approximately 1%.

FOR 6dB BANDWIDTH

1. Set RBW = 100 kHz.
2. Set the video bandwidth (VBW) ≥ 3 RBW.
3. Detector = Peak.
4. Trace mode = max hold.
5. Sweep = auto couple.
6. Allow the trace to stabilize.
7. Measure the maximum width of the emission that is constrained by the frequencies associated with the two outermost amplitude points (upper and lower frequencies) that are attenuated by 6 dB relative to the maximum level measured in the fundamental emission.



3.3.5 DEVIATION FROM TEST STANDARD

No deviation.

3.3.6 EUT OPERATING CONDITIONS

The software provided by client to enable the EUT under transmission condition continuously at specific channel frequencies individually.



3.3.7 TEST RESULTS

OUTPUT POWER:

802.11a

CHANNEL	CHANNEL FREQUENCY (MHz)	AVERAGE POWER (dBm)	AVERAGE POWER (mW)	POWER LIMIT (dBm)	PASS/FAIL
36	5180	14.07	25.527	24	PASS
40	5200	13.84	24.210	24	PASS
48	5240	14.34	27.164	24	PASS
52	5260	14.02	25.235	24	PASS
60	5300	13.90	24.547	24	PASS
64	5320	14.16	26.062	24	PASS
100	5500	14.24	26.546	24	PASS
116	5580	14.27	26.730	24	PASS
140	5700	14.10	25.704	24	PASS
149	5745	13.83	24.155	30	PASS
157	5785	14.41	27.606	30	PASS
165	5825	14.48	28.054	30	PASS

802.11n (20MHz)

CHANNEL	CHANNEL FREQUENCY (MHz)	AVERAGE POWER (dBm)	AVERAGE POWER (mW)	POWER LIMIT (dBm)	PASS/FAIL
36	5180	12.36	17.219	24	PASS
40	5200	12.50	17.783	24	PASS
48	5240	12.48	17.701	24	PASS
52	5260	12.52	17.865	24	PASS
60	5300	12.43	17.498	24	PASS
64	5320	12.33	17.100	24	PASS
100	5500	12.43	17.498	24	PASS
116	5580	12.53	17.906	24	PASS
140	5700	12.53	17.906	24	PASS
149	5745	12.11	16.255	30	PASS
157	5785	12.15	16.406	30	PASS
165	5825	12.23	16.711	30	PASS



802.11n (40MHz)

CHANNEL	CHANNEL FREQUENCY (MHz)	AVERAGE POWER (dBm)	AVERAGE POWER (mW)	POWER LIMIT (dBm)	PASS/FAIL
38	5190	12.13	16.331	24	PASS
46	5230	12.12	16.293	24	PASS
54	5270	12.61	18.239	24	PASS
62	5310	12.62	18.281	24	PASS
102	5510	12.03	15.959	24	PASS
110	5550	11.98	15.776	24	PASS
134	5670	12.00	15.849	24	PASS
151	5755	12.31	17.022	30	PASS
159	5798	12.22	16.672	30	PASS

802.11ac (80MHz)

CHANNEL	CHANNEL FREQUENCY (MHz)	AVERAGE POWER (dBm)	AVERAGE POWER (mW)	POWER LIMIT (dBm)	PASS/FAIL
42	5210	10.10	10.233	24	PASS
58	5290	10.07	10.162	24	PASS
106	5530	9.77	9.484	24	PASS
155	5775	10.46	11.117	30	PASS



99% OCCUPIED BANDWIDTH & 26dB BANDWIDTH/6dB BANDWIDTH:

802.11a

CHANNEL	CHANNEL FREQUENCY (MHz)	99% OCCUPIED BANDWIDTH	26dB BANDWIDTH (MHz)	PASS/FAIL
36	5180	16.62	21.90	PASS
40	5200	16.62	22.05	PASS
48	5240	16.68	21.92	PASS
52	5260	16.74	22.80	PASS
60	5300	16.62	22.17	PASS
64	5320	16.68	22.19	PASS
100	5500	16.56	20.80	PASS
116	5580	16.56	20.90	PASS
140	5700	16.62	21.17	PASS
CHANNEL	CHANNEL FREQUENCY (MHz)	99% OCCUPIED BANDWIDTH	6dB BANDWIDTH (MHz)	PASS/FAIL
149	5745	16.86	16.34	PASS
157	5785	16.80	16.04	PASS
165	5825	17.46	16.03	PASS



802.11n (20MHz)

CHANNEL	CHANNEL FREQUENCY (MHz)	99% OCCUPIED BANDWIDTH	26dB BANDWIDTH (MHz)	PASS/FAIL
36	5180	17.94	21.65	PASS
40	5200	17.94	21.54	PASS
48	5240	17.88	21.47	PASS
52	5260	17.88	22.09	PASS
60	5300	17.94	21.62	PASS
64	5320	17.94	21.31	PASS
100	5500	17.88	21.30	PASS
116	5580	17.88	21.41	PASS
140	5700	17.88	21.34	PASS
CHANNEL	CHANNEL FREQUENCY (MHz)	99% OCCUPIED BANDWIDTH	6dB BANDWIDTH (MHz)	PASS/FAIL
149	5745	17.94	17.68	PASS
157	5785	17.94	17.70	PASS
165	5825	18.00	17.67	PASS



802.11n (40MHz)

CHANNEL	CHANNEL FREQUENCY (MHz)	99% OCCUPIED BANDWIDTH	26dB BANDWIDTH (MHz)	PASS/FAIL
38	5190	36.78	56.74	PASS
46	5230	36.60	54.20	PASS
54	5270	36.78	61.93	PASS
62	5310	36.48	48.75	PASS
102	5510	36.36	40.40	PASS
110	5550	36.54	40.52	PASS
134	5670	36.54	47.03	PASS
CHANNEL	CHANNEL FREQUENCY (MHz)	99% OCCUPIED BANDWIDTH	6dB BANDWIDTH (MHz)	PASS/FAIL
151	5755	36.72	36.35	PASS
159	5795	36.54	36.31	PASS

802.11ac (80MHz)

CHANNEL	CHANNEL FREQUENCY (MHz)	99% OCCUPIED BANDWIDTH	26dB BANDWIDTH (MHz)	PASS/FAIL
42	5210	75.48	80.54	PASS
58	5290	75.60	81.36	PASS
106	5530	75.36	80.79	PASS
CHANNEL	CHANNEL FREQUENCY (MHz)	99% OCCUPIED BANDWIDTH	6dB BANDWIDTH (MHz)	PASS/FAIL
155	5775	75.48	75.26	PASS



BUREAU VERITAS

Test Report No.: RF191120W002-3

For U-NII-1:

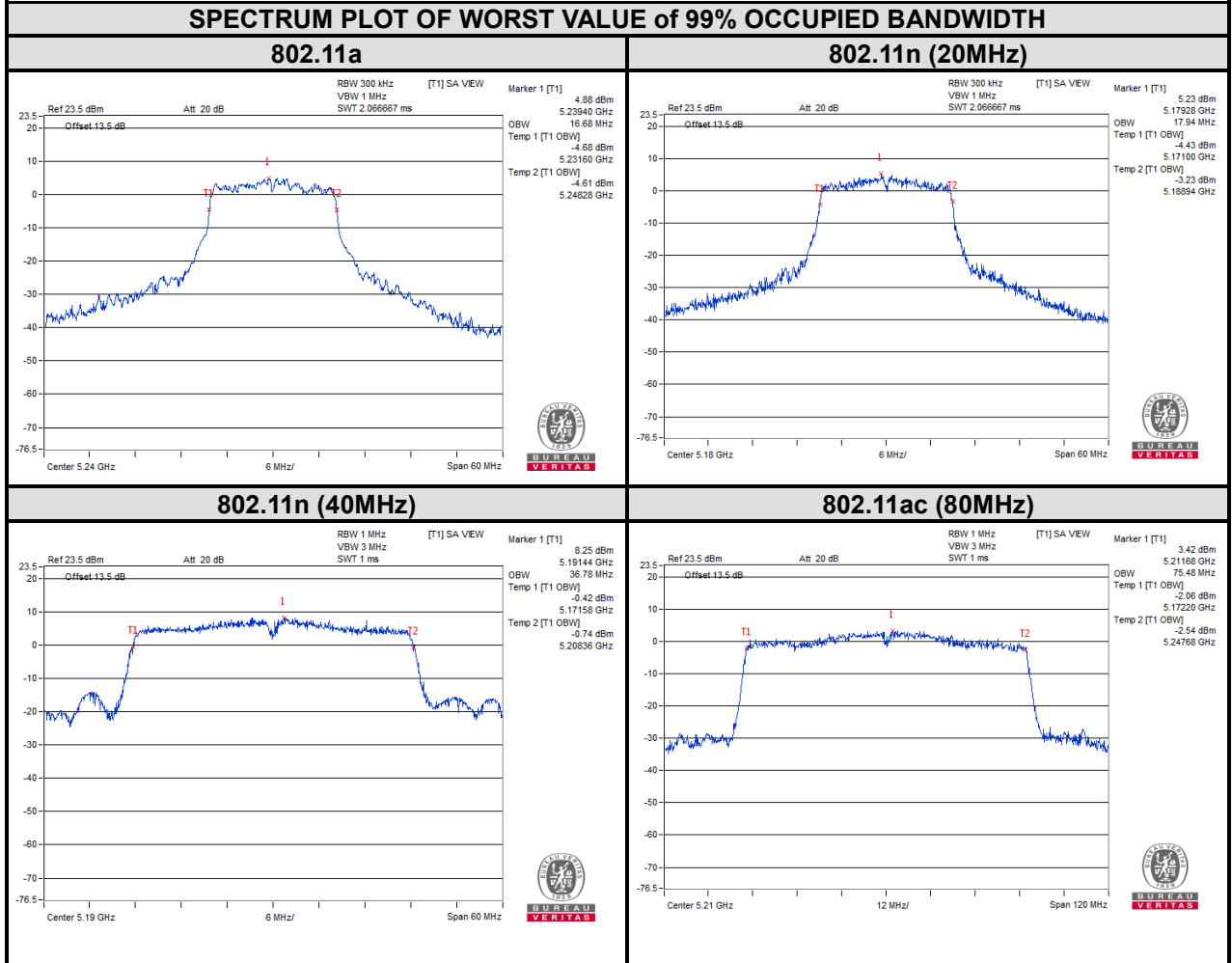

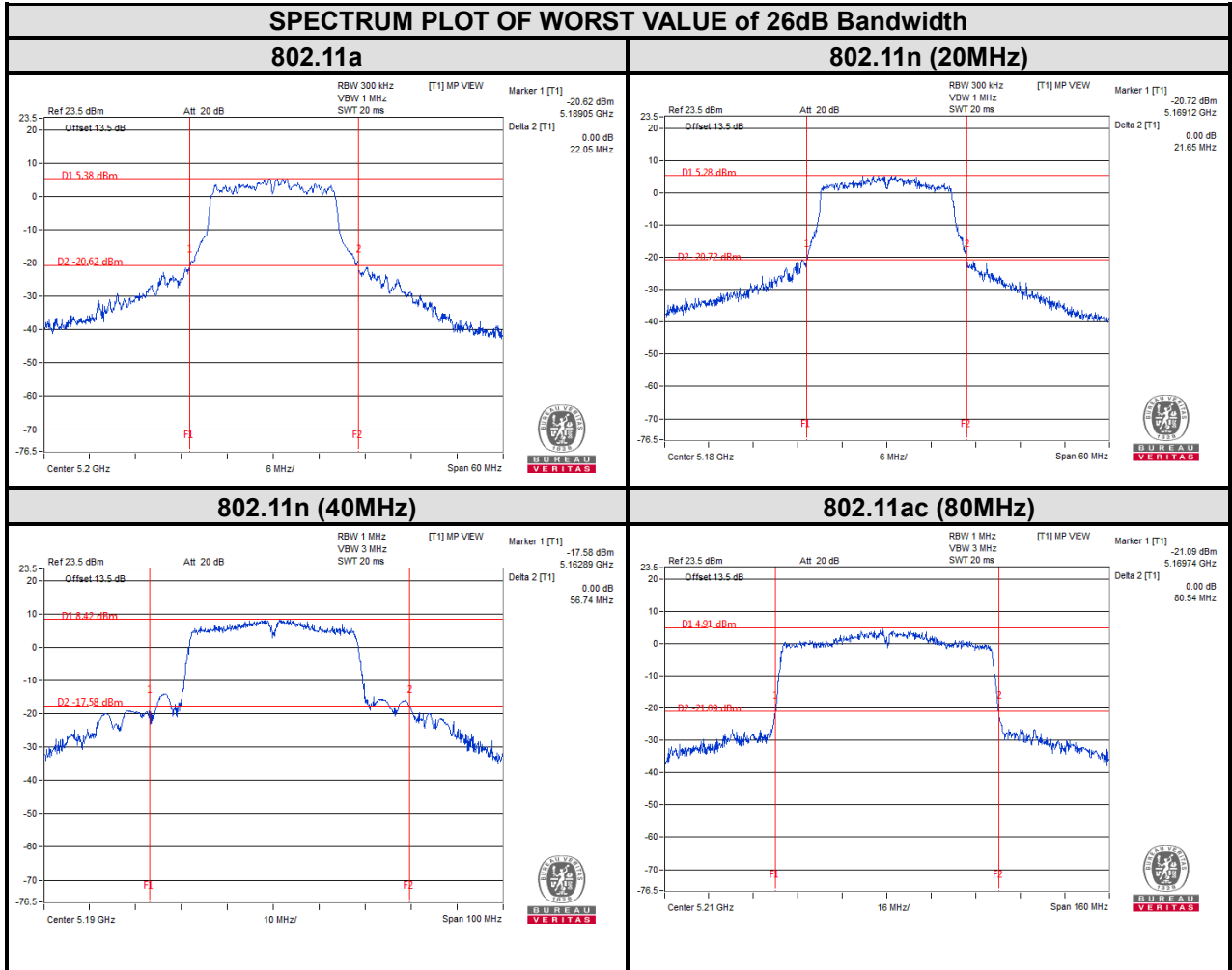



BUREAU VERITAS

Test Report No.: RF191120W002-3

For U-NII-2A:

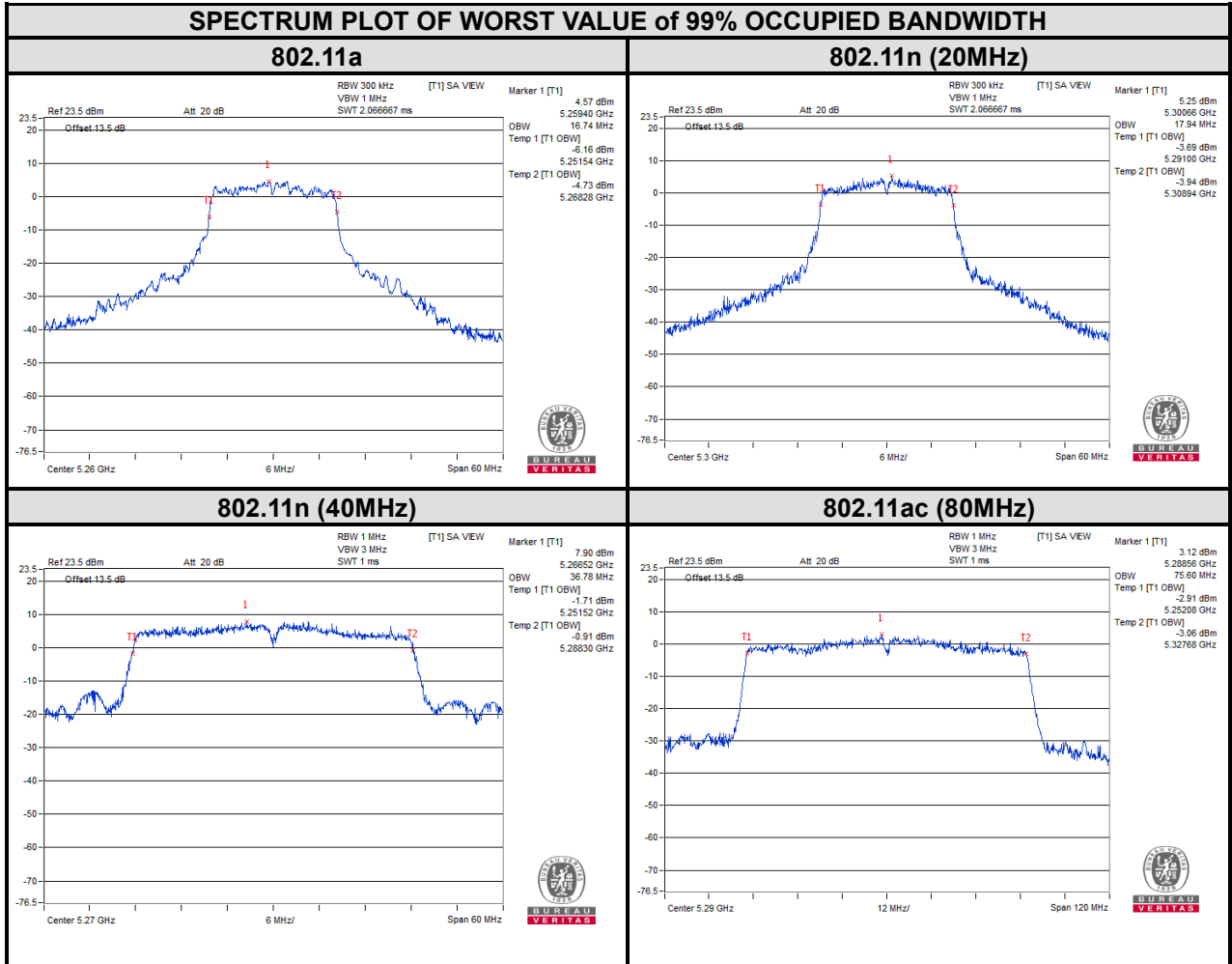

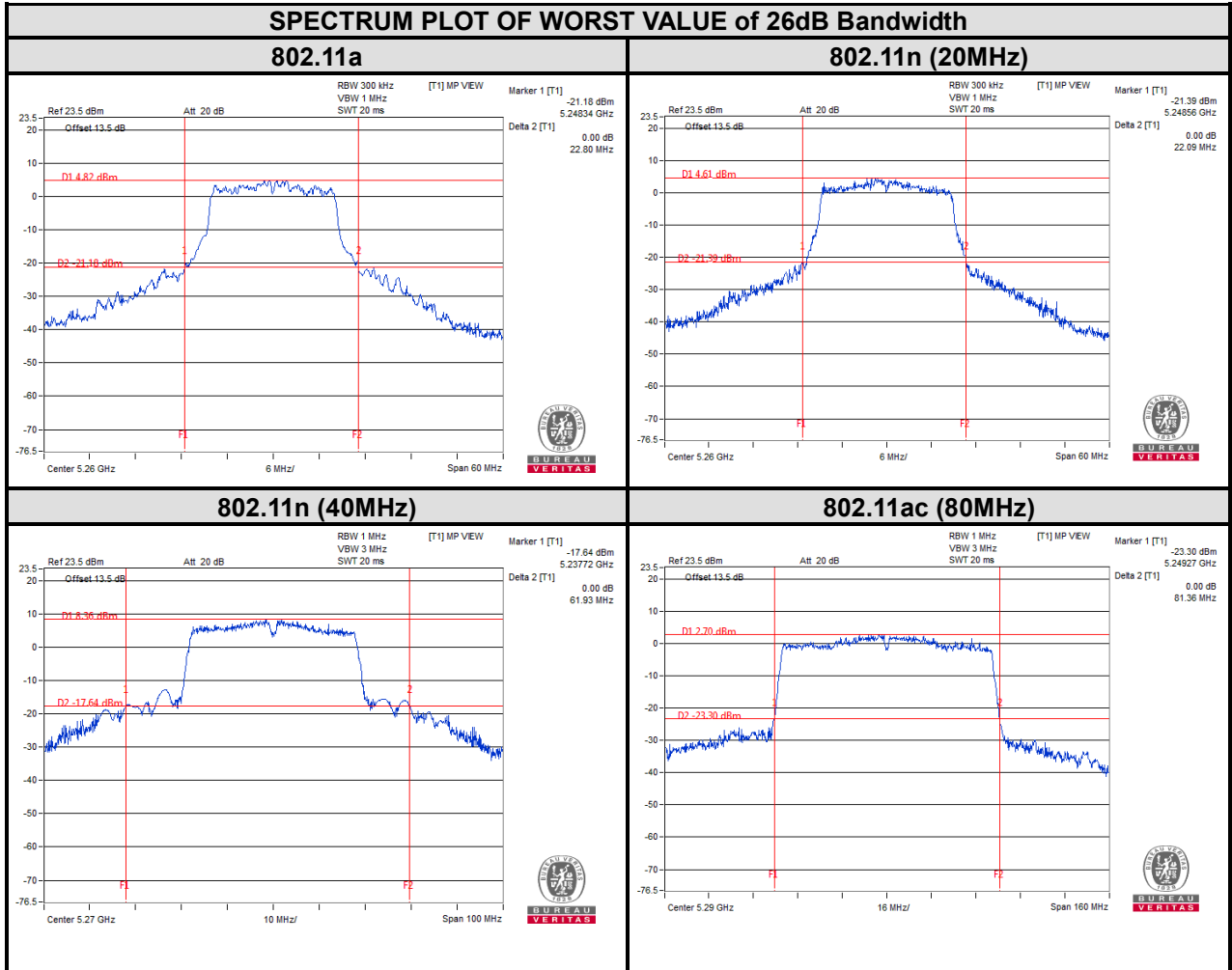



For U-NII-2C:

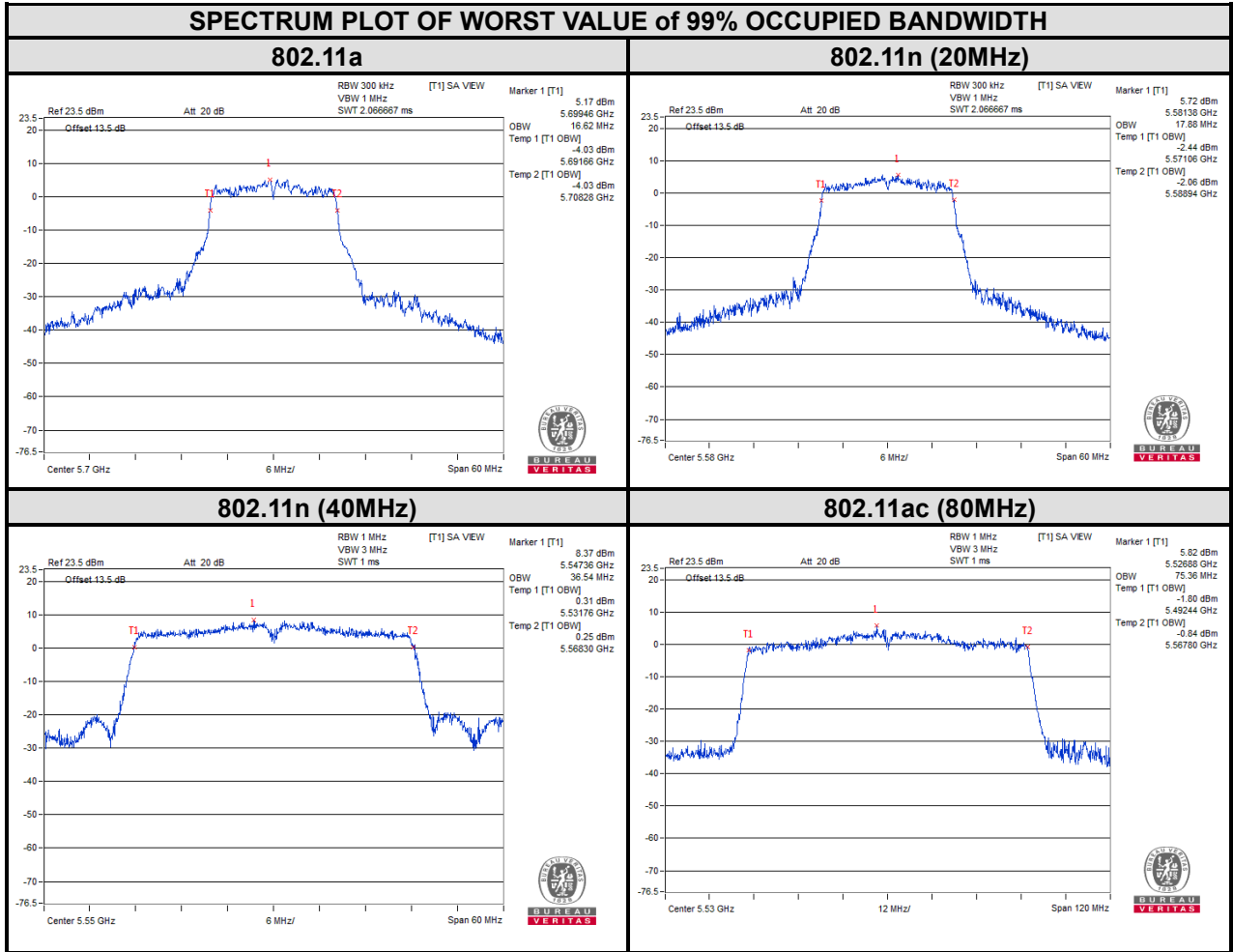

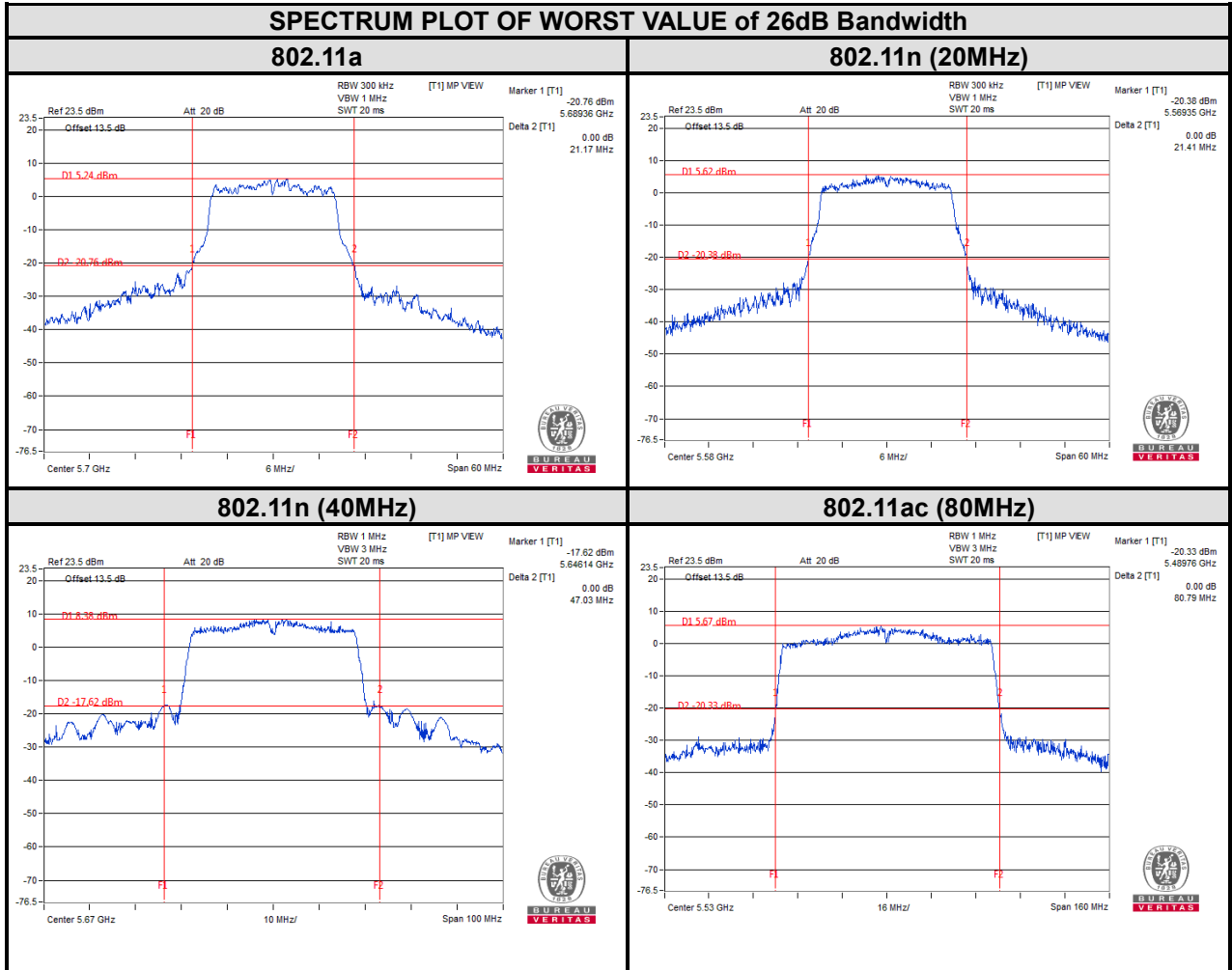



BUREAU VERITAS

Test Report No.: RF191120W002-3

For U-NII-3:

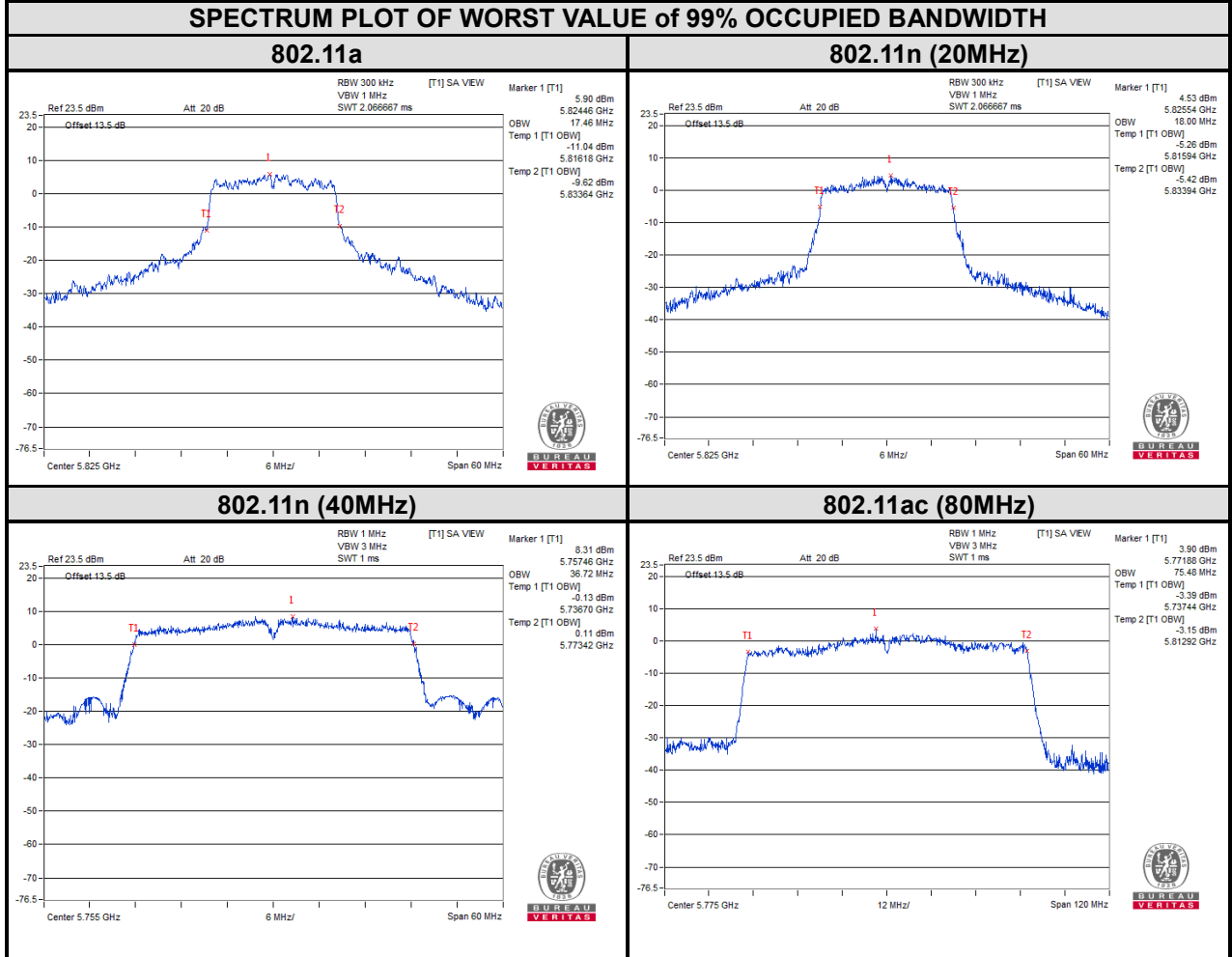

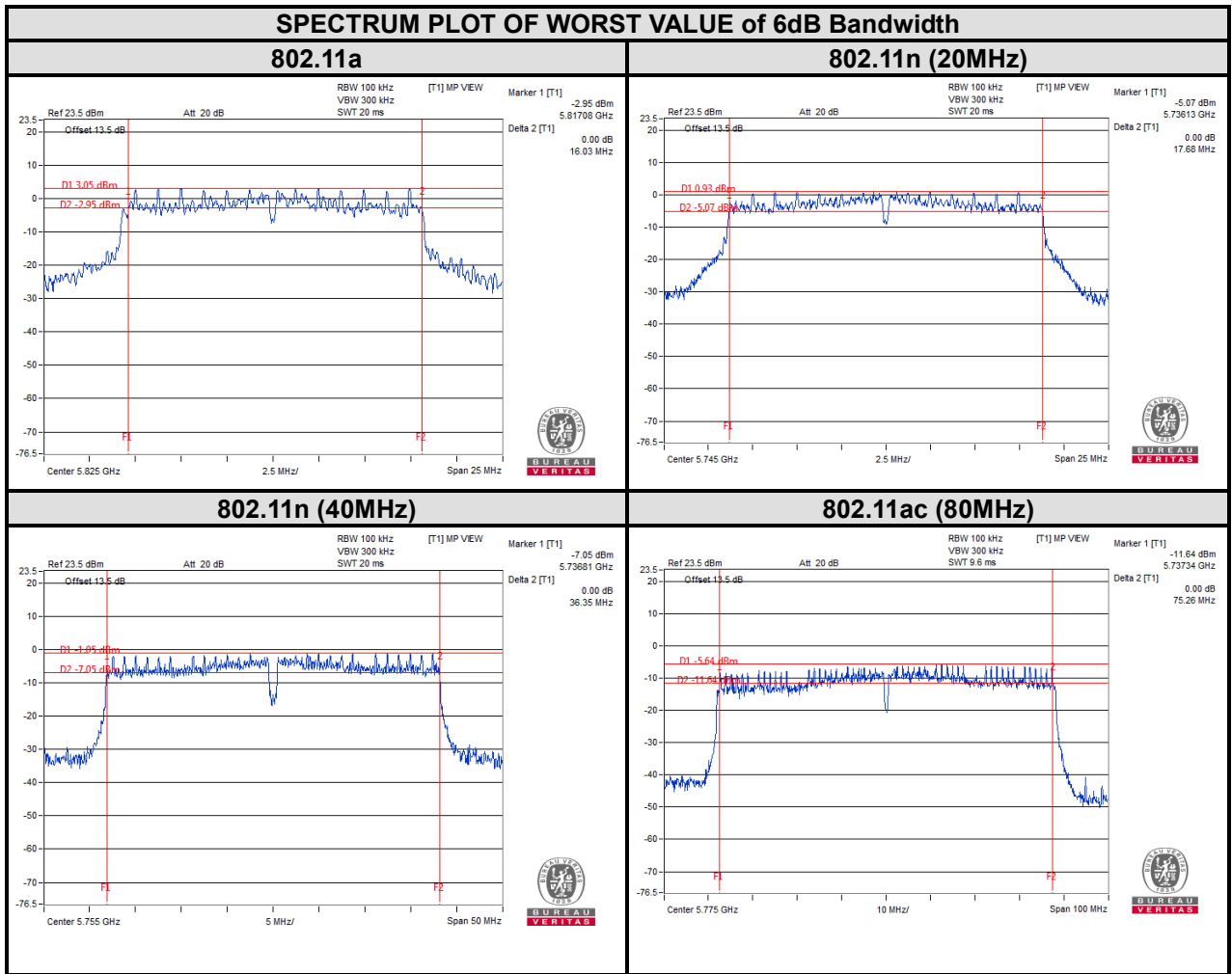



3.4 MAXIMUM POWER SPECTRAL DENSITY MEASUREMENT

3.4.1 LIMITS OF MAXIMUM POWER SPECTRAL DENSITY MEASUREMENT

Operation Band	EUT Category		LIMIT
U-NII-1		Outdoor Access Point	17dBm/ MHz
		Fixed point-to-point Access Point	
		Indoor Access Point	
	√	Client devices	11dBm/ MHz
U-NII-2A	√		11dBm/ MHz
U-NII-2C	√		11dBm/ MHz
U-NII-3	√		30dBm/ 500kHz

3.4.2 TEST SETUP

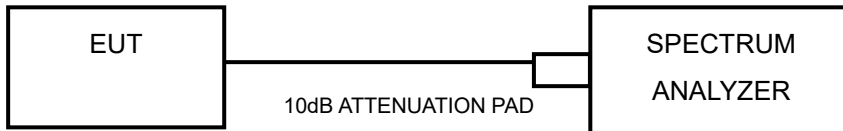

3.4.3 TEST INSTRUMENTS

Refer to section 3.3.3 to get information of above instrument.



3.4.4 TEST PROCEDURES

Using method SA-2

- 1) Set span to encompass the entire emission bandwidth (EBW) of the signal.
- 2) Set RBW = 1 MHz, Set VBW \geq 3 MHz, Detector = RMS
- 3) Set Channel power measure = 1MHz
- 4) Sweep time = auto, trigger set to "free run".
- 5) Trace average at least 100 traces in power averaging mode.
- 6) Add $10 \log(1/x)$, where x is the duty cycle, to the measured power in order to compute the average power during the actual transmission times (because the measurement represents an average over both the on and off times of the transmission).
- 7) Record the max value

3.4.5 DEVIATION FROM TEST STANDARD

No deviation.

3.4.6 EUT OPERATING CONDITIONS

Same as 3.1.6.



3.4.7 TEST RESULTS

For U-NII-1 & U-NII-2A & U-NII-2C:

802.11a

CHANNEL	FREQUENCY (MHz)	PSD w/o Duty Factor (dBm/MHz)	Duty Factor	PSD with Duty Factor (dBm/MHz)	MAXIMUM LIMIT (dBm/MHz)	PASS/FAIL
36	5180	7.79	1.16	8.95	11	PASS
40	5200	7.97	1.16	9.13	11	PASS
48	5240	8.62	1.16	9.78	11	PASS
52	5260	7.71	1.16	8.87	11	PASS
60	5300	8.21	1.16	9.37	11	PASS
64	5320	9.23	1.16	10.39	11	PASS
100	5500	7.38	1.16	8.54	11	PASS
116	5580	8.45	1.16	9.61	11	PASS
140	5700	7.92	1.16	9.08	11	PASS

802.11n (20MHz)

CHANNEL	FREQUENCY (MHz)	PSD w/o Duty Factor (dBm/MHz)	Duty Factor	PSD with Duty Factor (dBm/MHz)	MAXIMUM LIMIT (dBm/MHz)	PASS/FAIL
36	5180	8.51	1.46	9.97	11	PASS
40	5200	8.40	1.46	9.86	11	PASS
48	5240	7.13	1.46	8.59	11	PASS
52	5260	6.25	1.46	7.71	11	PASS
60	5300	8.11	1.46	9.57	11	PASS
64	5320	8.16	1.46	9.62	11	PASS
100	5500	7.74	1.46	9.2	11	PASS
116	5580	7.87	1.46	9.33	11	PASS
140	5700	8.63	1.46	10.09	11	PASS



802.11n (40MHz)

CHANNEL	FREQUENCY (MHz)	PSD w/o Duty Factor (dBm/MHz)	Duty Factor	PSD with Duty Factor (dBm/MHz)	MAXIMUM LIMIT (dBm/MHz)	PASS/FAIL
38	5190	5.24	1.89	7.13	11	PASS
46	5230	5.22	1.89	7.11	11	PASS
54	5270	6.45	1.89	8.34	11	PASS
62	5310	5.67	1.89	7.56	11	PASS
102	5510	5.30	1.89	7.19	11	PASS
110	5550	5.43	1.89	7.32	11	PASS
134	5670	5.29	1.89	7.18	11	PASS

802.11ac (80MHz)

CHANNEL	FREQUENCY (MHz)	PSD w/o Duty Factor (dBm/MHz)	Duty Factor	PSD with Duty Factor (dBm/MHz)	MAXIMUM LIMIT (dBm/MHz)	PASS/FAIL
42	5210	2.62	2.71	5.33	11	PASS
58	5290	1.02	2.71	3.73	11	PASS
106	5530	3.82	2.71	6.53	11	PASS



For U-NII-3:

802.11a

CHANNEL	FREQUENCY (MHz)	PSD w/o Duty Factor (dBm/MHz)	PSD w/o Duty Factor (dBm/500kHz)	Duty Factor	PSD with Duty Factor (dBm/500kHz)	LIMIT (dBm/500kHz)	PASS /FAIL
149	5745	2.69	-0.32	1.16	0.84	30	PASS
157	5785	3.13	0.12	1.16	1.28	30	PASS
165	5825	3.20	0.19	1.16	1.35	30	PASS

802.11n (20MHz)

CHANNEL	FREQUENCY (MHz)	PSD w/o Duty Factor (dBm/MHz)	PSD w/o Duty Factor (dBm/500kHz)	Duty Factor	PSD with Duty Factor (dBm/500kHz)	LIMIT (dBm/500kHz)	PASS /FAIL
149	5745	0.68	-2.33	1.46	-0.87	30	PASS
157	5785	0.97	-2.04	1.46	-0.58	30	PASS
165	5825	0.34	-2.67	1.46	-1.21	30	PASS

802.11n (40MHz)

CHANNEL	FREQUENCY (MHz)	PSD w/o Duty Factor (dBm/MHz)	PSD w/o Duty Factor (dBm/500kHz)	Duty Factor	PSD with Duty Factor (dBm/500kHz)	LIMIT (dBm/500kHz)	PASS /FAIL
151	5755	-2.31	-5.32	1.89	-3.43	30	PASS
159	5795	-1.89	-4.9	1.89	-3.01	30	PASS

802.11ac (80MHz)

CHANNEL	FREQUENCY (MHz)	PSD w/o Duty Factor (dBm/MHz)	PSD w/o Duty Factor (dBm/500kHz)	Duty Factor	PSD with Duty Factor (dBm/500kHz)	LIMIT (dBm/500kHz)	PASS /FAIL
155	5775	-7.61	-10.62	2.71	-7.91	30	PASS



BUREAU VERITAS

Test Report No.: RF191120W002-3

For 5180~5240MHz

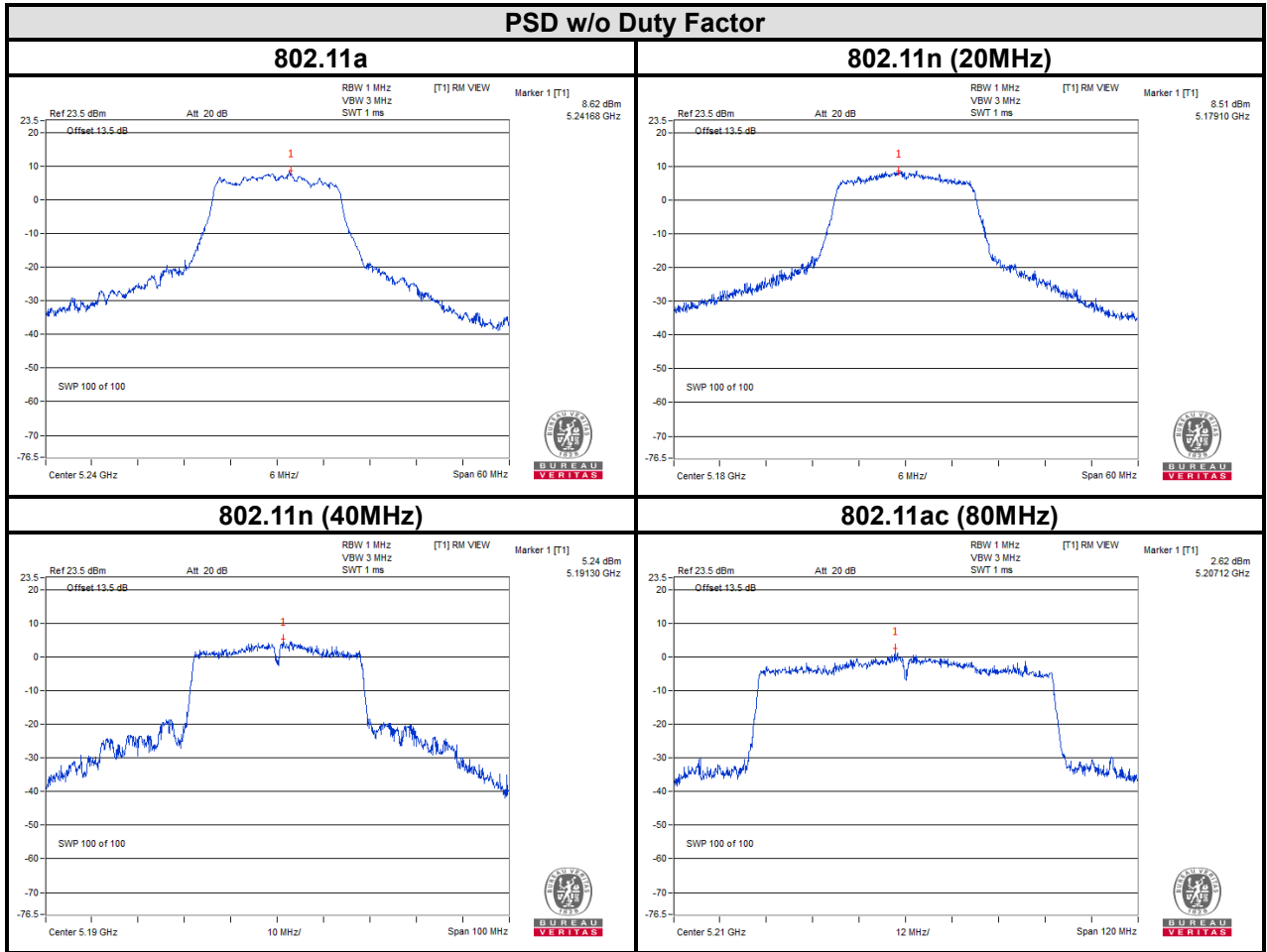



BUREAU VERITAS

Test Report No.: RF191120W002-3

For 5260~5320MHz

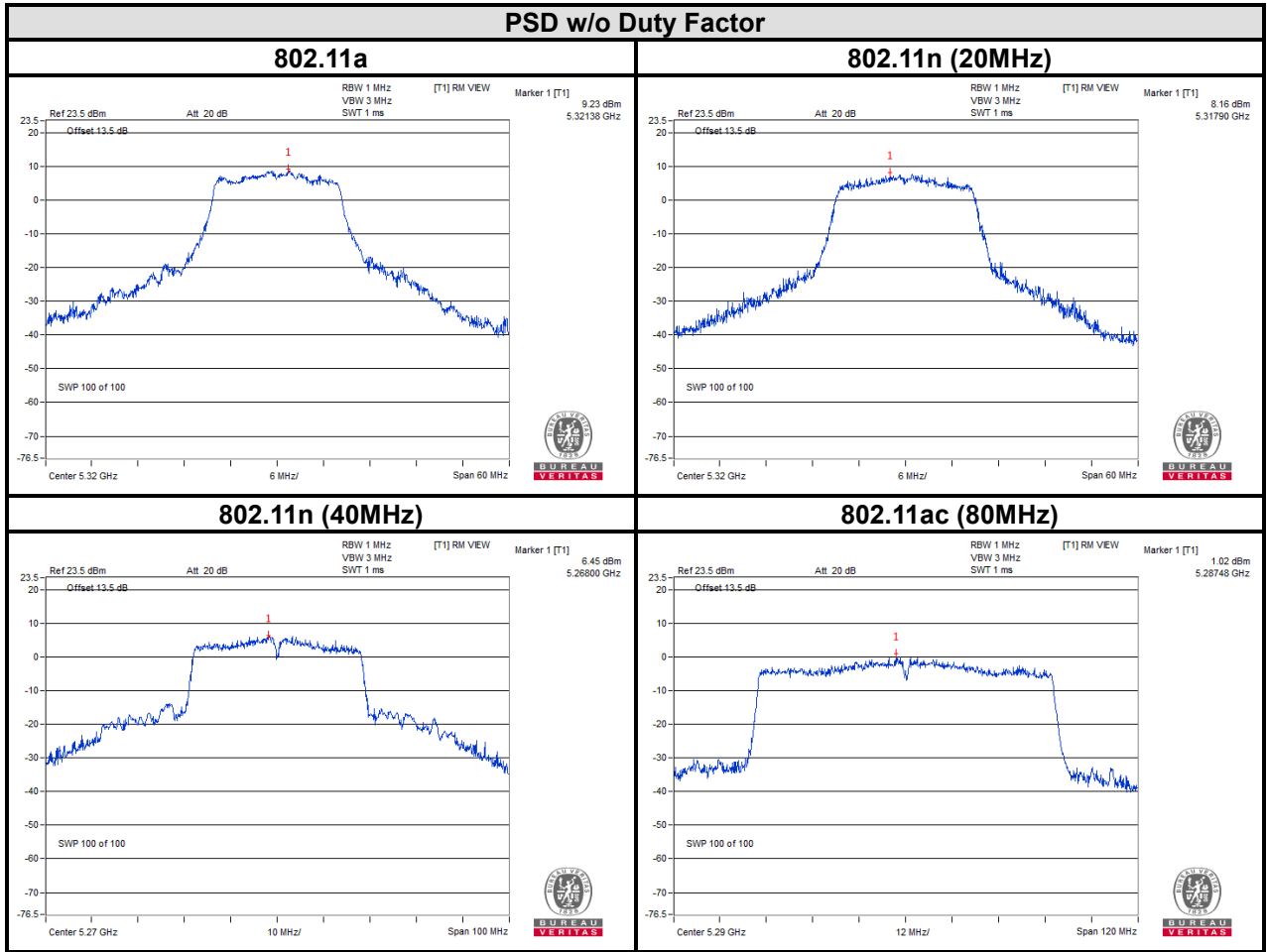



BUREAU VERITAS

Test Report No.: RF191120W002-3

For 5500~5700MHz

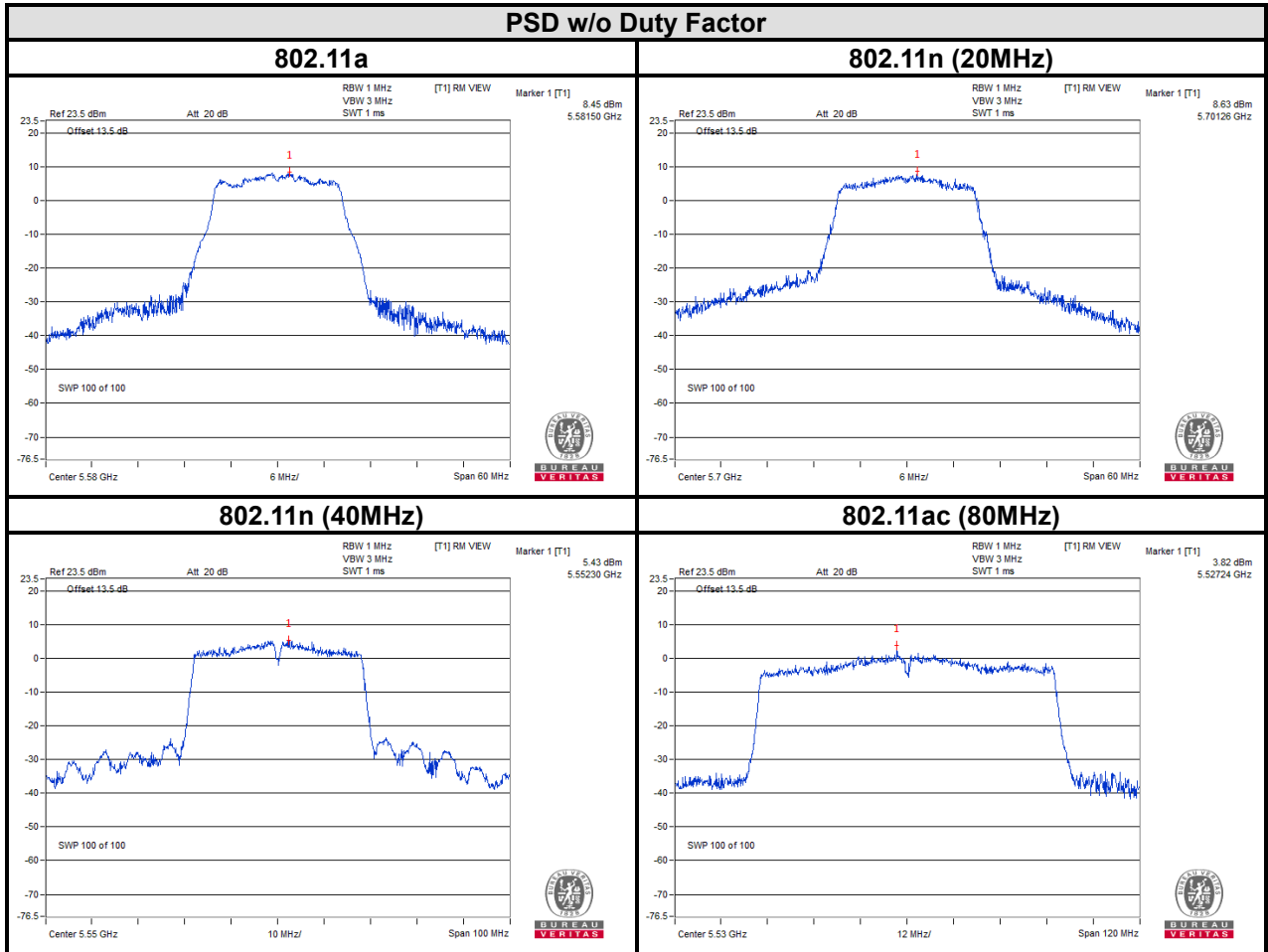



For 5745~5825MHz

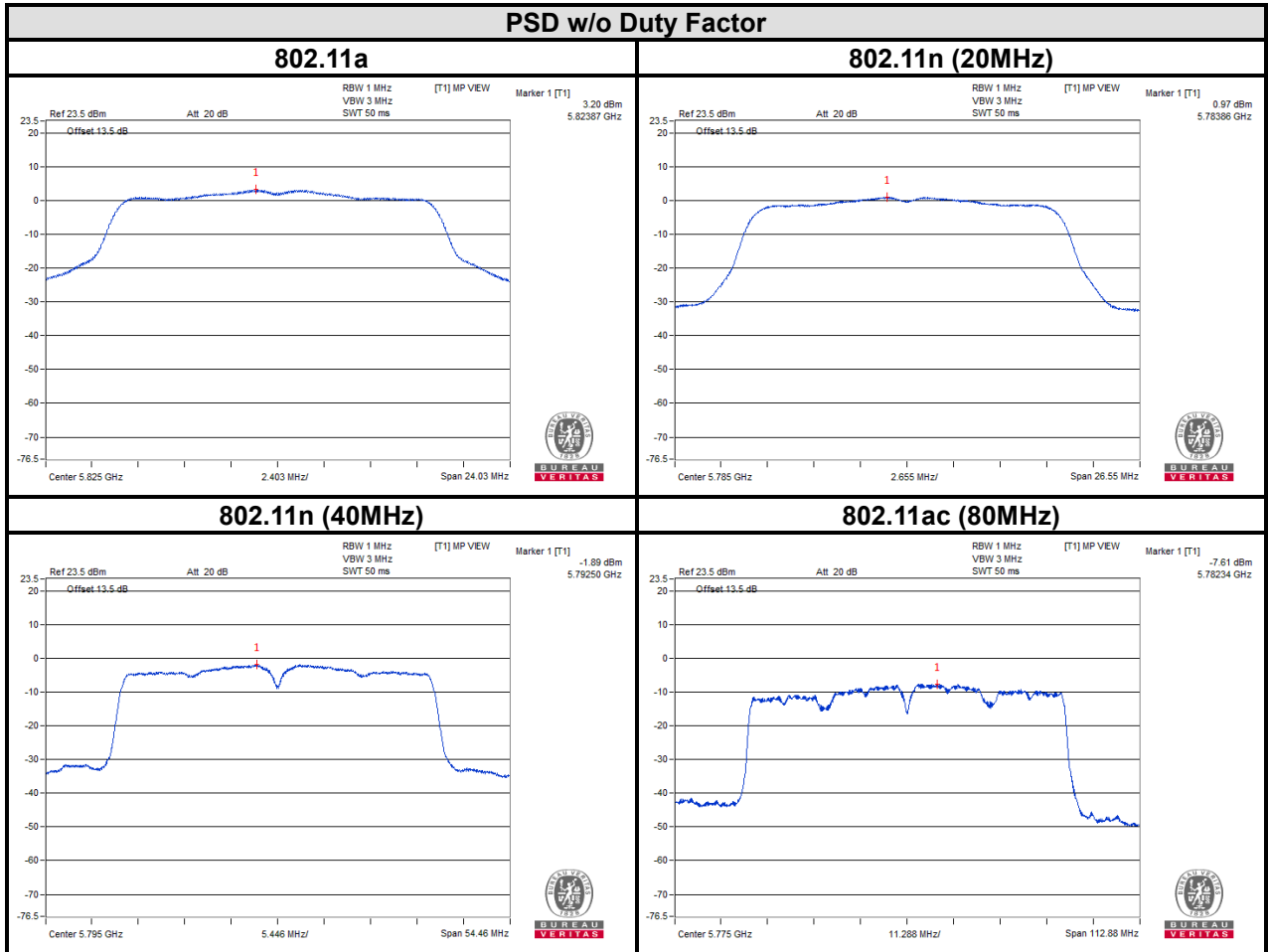



3.5 FREQUENCY STABILITY

3.5.1 LIMITS OF FREQUENCY STABILITY MEASUREMENT

The frequency of the carrier signal shall be maintained within band of operation

3.5.2 TEST SETUP

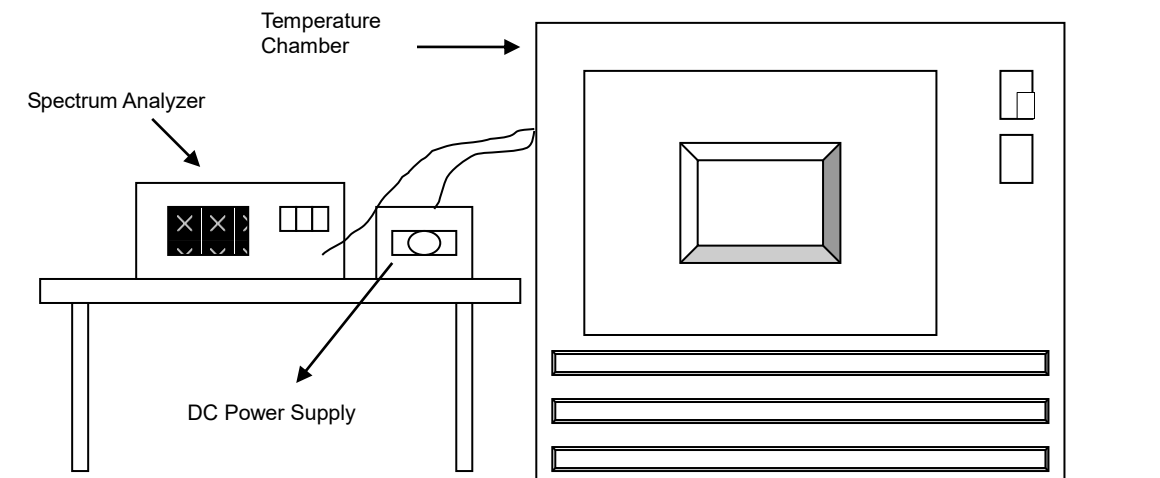

3.5.3 TEST INSTRUMENTS

Refer to section 3.3.3 to get information of above instrument.



3.5.4 TEST PROCEDURE

- a. The EUT was placed inside the environmental test chamber and powered by nominal DC voltage.
- b. Turn the EUT on and couple its output to a spectrum analyzer.
- c. Turn the EUT off and set the chamber to the highest temperature specified.
- d. Allow sufficient time (approximately 30 min) for the temperature of the chamber to stabilize, turn the EUT on and measure the operating frequency after 2, 5, and 10 minutes.
- e. Repeat step 2 and 3 with the temperature chamber set to the lowest temperature.
- f. The test chamber was allowed to stabilize at +20 degree C for a minimum of 30 minutes. The supply voltage was then adjusted on the EUT from 85% to 115% and the frequency record.

3.5.5 DEVIATION FROM TEST STANDARD

No deviation.

3.5.6 EUT OPERATING CONDITION

Set the EUT transmit at un-modulation mode to test frequency stability.



3.5.7 TEST RESULTS

FREQUENCY STABILITY VERSUS TEMP.										
OPERATING FREQUENCY: 5180MHz										
TEMP. (°C)	Power Supply (Vdc)	0 MINUTE		2 MINUTES		5 MINUTES		10 MINUTE		RESULT
		Measured Frequency (MHz)	Frequency Drift (ppm)	Measured Frequency (MHz)	Frequency Drift (ppm)	Measured Frequency (MHz)	Frequency Drift (ppm)	Measured Frequency (MHz)	Frequency Drift (ppm)	
50	120	5180.0117	2.259	5180.013	2.510	5180.0135	2.606	5180.0169	3.263	PASS
40	120	5180.0022	0.425	5180.0047	0.907	5180	0.000	5180.0074	1.429	PASS
30	120	5180.003	0.579	5179.9979	-0.405	5180.005	0.965	5180.004	0.772	PASS
20	120	5180.0098	1.892	5180.0109	2.104	5180.0025	0.483	5180.0133	2.568	PASS
10	120	5179.9872	-2.471	5179.9907	-1.795	5179.9825	-3.378	5179.9924	-1.467	PASS
0	120	5179.9993	-0.135	5179.9982	-0.347	5180.0016	0.309	5179.9971	-0.560	PASS
-10	120	5180.0112	2.162	5180.0052	1.004	5180.0044	0.849	5180.0078	1.506	PASS
-20	120	5180.0211	4.073	5180.0116	2.239	5180.018	3.475	5180.0143	2.761	PASS
-30	120	5180.0071	1.371	5180.0144	2.780	5180.0032	0.618	5180.0081	1.564	PASS

FREQUENCY STABILITY VERSUS VOLTAGE										
OPERATING FREQUENCY: 5180MHz										
TEMP. (°C)	Power Supply (Vdc)	0 MINUTE		2 MINUTE		5 MINUTE		10 MINUTE		RESULT
		Measured Frequency (MHz)	Frequency Drift (ppm)	Measured Frequency (MHz)	Frequency Drift (ppm)	Measured Frequency (MHz)	Frequency Drift (ppm)	Measured Frequency (MHz)	Frequency Drift (ppm)	
20	138	5180.0095	1.834	5180.0115	2.220	5180.0026	0.502	5180.0124	2.394	PASS
	120	5180.0098	1.892	5180.0109	2.104	5180.0025	0.483	5180.0133	2.568	PASS
	102	5180.0087	1.680	5180.0104	2.008	5180.0026	0.502	5180.0123	2.375	PASS



FREQUENCY STABILITY VERSUS TEMP.										
OPERATING FREQUENCY: 5825MHz										
TEMP. (°C)	Power Supply (Vdc)	0 MINUTE		2 MINUTES		5 MINUTES		10 MINUTE		RESULT
		Measured Frequency (MHz)	Frequency Drift (ppm)	Measured Frequency (MHz)	Frequency Drift (ppm)	Measured Frequency (MHz)	Frequency Drift (ppm)	Measured Frequency (MHz)	Frequency Drift (ppm)	
50	120	5825.0101	1.734	5825.0044	0.755	5825.01	1.717	5825.0041	0.704	PASS
40	120	5825.0003	0.052	5825.0043	0.738	5824.9954	-0.790	5824.9958	-0.721	PASS
30	120	5825.0141	2.421	5825.0135	2.318	5825.0119	2.043	5825.0064	1.099	PASS
20	120	5824.9754	-4.223	5824.9835	-2.833	5824.9797	-3.485	5824.9771	-3.931	PASS
10	120	5825.0132	2.266	5825.0119	2.043	5825.0147	2.524	5825.0112	1.923	PASS
0	120	5824.9749	-4.309	5824.9816	-3.159	5824.9842	-2.712	5824.9793	-3.554	PASS
-10	120	5824.9834	-2.850	5824.9819	-3.107	5824.9889	-1.906	5824.9936	-1.099	PASS
-20	120	5824.9974	-0.446	5825.004	0.687	5824.9992	-0.137	5825.0075	1.288	PASS
-30	120	5825.01	1.717	5825.0082	1.408	5825.0008	0.137	5825.0093	1.597	PASS

FREQUENCY STABILITY VERSUS VOLTAGE										
OPERATING FREQUENCY: 5825MHz										
TEMP. (°C)	Power Supply (Vdc)	0 MINUTE		2 MINUTE		5 MINUTE		10 MINUTE		RESULT
		Measured Frequency (MHz)	Frequency Drift (ppm)	Measured Frequency (MHz)	Frequency Drift (ppm)	Measured Frequency (MHz)	Frequency Drift (ppm)	Measured Frequency (MHz)	Frequency Drift (ppm)	
20	138	5824.9772	-3.914	5824.9844	-2.678	5824.9795	-3.519	5824.9779	-3.794	PASS
	120	5824.9754	-4.223	5824.9835	-2.833	5824.9797	-3.485	5824.9771	-3.931	PASS
	102	5824.9761	-4.103	5824.9838	-2.781	5824.9795	-3.519	5824.9765	-4.034	PASS



Test Report No.: RF191120W002-3

4 PHOTOGRAPHS OF THE TEST CONFIGURATION

Please refer to the attached file (Test Setup Photo).



Test Report No.: RF191120W002-3

5 APPENDIX A – MODIFICATIONS RECORDERS FOR ENGINEERING CHANGES TO THE EUT BY THE LAB

No modifications were made to the EUT by the lab during the test.

---END---