

FCC SAR Test Report

APPLICANT : PAX Technology Limited
EQUIPMENT : Mobile Payment Terminal
BRAND NAME : PAX
MODEL NAME : S920
MARKETING NAME : S920
FCC ID : V5PS920FDD-LTE
STANDARD : FCC 47 CFR Part 2 (2.1093)
ANSI/IEEE C95.1-1992
IEEE 1528-2013

We, SPORTON INTERNATIONAL (SHENZHEN) INC., would like to declare that the tested sample has been evaluated in accordance with the procedures and had been in compliance with the applicable technical standards.

The test results in this report apply exclusively to the tested model / sample. Without written approval of SPORTON INTERNATIONAL (SHENZHEN) INC., the test report shall not be reproduced except in full.



Prepared by: Mark Qu / Manager



Approved by: Jones Tsai / Manager



SPORTON INTERNATIONAL (SHENZHEN) INC.
1F & 2F, Building A, Morning Business Center, No. 4003 ShiGu Rd., Xili Town,
Nanshan District, Shenzhen, Guangdong, P. R. China



Table of Contents

1. Statement of Compliance 4

2. Administration Data 5

3. Guidance Standard 5

4. Equipment Under Test (EUT) Information 6

 4.1 General Information 6

 4.2 General LTE SAR Test and Reporting Considerations 7

5. RF Exposure Limits 9

 5.1 Uncontrolled Environment 9

 5.2 Controlled Environment 9

6. Specific Absorption Rate (SAR) 10

 6.1 Introduction 10

 6.2 SAR Definition 10

7. System Description and Setup 11

 7.1 E-Field Probe 12

 7.2 Data Acquisition Electronics (DAE) 12

 7.3 Phantom 13

 7.4 Device Holder 14

8. Measurement Procedures 15

 8.1 Spatial Peak SAR Evaluation 15

 8.2 Power Reference Measurement 16

 8.3 Area Scan 16

 8.4 Zoom Scan 17

 8.5 Volume Scan Procedures 17

 8.6 Power Drift Monitoring 17

9. Test Equipment List 18

10. System Verification 19

 10.1 Tissue Verification 19

 10.2 System Performance Check Results 20

11. RF Exposure Positions 21

12. Conducted RF Output Power (Unit: dBm) 22

13. Antenna Location 38

14. SAR Test Results 39

 14.1 Body SAR 41

15. Simultaneous Transmission Analysis 43

 15.1 Body Exposure Conditions 44

16. Uncertainty Assessment 45

17. References 47

Appendix A. Plots of System Performance Check

Appendix B. Plots of High SAR Measurement

Appendix C. DASYS Calibration Certificate

Appendix D. Test Setup Photos



1. Statement of Compliance

The maximum results of Specific Absorption Rate (SAR) found during testing for PAX Technology Limited, Mobile Payment Terminal, S920, are as follows.

Equipment Class	Frequency Band	Highest SAR Summary	
		Body SAR 1g SAR (W/kg) Gap(0 mm)	Highest Simultaneous Transmission 1g SAR (W/kg)
PCB	WCDMA Band V	0.74	0.87
	WCDMA Band IV	0.64	
	WCDMA Band II	0.50	
	LTE Band 17	0.59	
	LTE Band 5	0.70	
	LTE Band 4	0.60	
	LTE Band 2	0.48	
DTS	WLAN 2.4GHz Band	0.46	0.87
DSS	Bluetooth	<0.10	0.75
Date of Testing:		2015/12/24 ~ 2016/01/04	

This device is in compliance with Specific Absorption Rate (SAR) for general population/uncontrolled exposure limits (1.6 W/kg) specified in FCC 47 CFR part 2 (2.1093) and ANSI/IEEE C95.1-1992, and had been tested in accordance with the measurement methods and procedures specified in IEEE 1528-2013 and FCC KDB publications.

2. Administration Data

Testing Laboratory	
Test Site	SPORTON INTERNATIONAL (SHENZHEN) INC.
Test Site Location	1F & 2F, Building A, Morning Business Center, No. 4003 ShiGu Rd., Xili Town, Nanshan District, Shenzhen, Guangdong, P. R. China TEL: +86-755-8637-9589 FAX: +86-755-8637-9595

Applicant	
Company Name	PAX Technology Limited
Address	Room 2416, 24/F., Sun Hung Kai Centre, 30 Harbour Road, Wanchai, Hong Kong

Manufacturer	
Company Name	PAX Computer Technology (Shenzhen) Co., Ltd.
Address	4/F, No.3 Building, Software Park, Second Central Science-Tech Road, High-Tech Industrial Park, Shenzhen, Guangdong, P.R.C.

3. Guidance Standard

The Specific Absorption Rate (SAR) testing specification, method, and procedure for this device is in accordance with the following standards:

- FCC 47 CFR Part 2 (2.1093)
- ANSI/IEEE C95.1-1992
- IEEE 1528-2013
- FCC KDB 865664 D01 SAR Measurement 100 MHz to 6 GHz v01r04
- FCC KDB 865664 D02 SAR Reporting v01r02
- FCC KDB 447498 D01 General RF Exposure Guidance v06
- FCC KDB 248227 D01 802.11 Wi-Fi SAR v02r02
- FCC KDB 941225 D01 3G SAR Procedures v03r01
- FCC KDB 941225 D05 SAR for LTE Devices v02r05

4. Equipment Under Test (EUT) Information

4.1 General Information

Product Feature & Specification	
Equipment Name	Mobile Payment Terminal
Brand Name	PAX
Model Name	S920
Marketing Name	S920
FCC ID	V5PS920FDD-LTE
IMEI Code	864669020066004
Wireless Technology and Frequency Range	WCDMA Band II: 1852.4 MHz ~ 1907.6 MHz WCDMA Band IV: 1712.4 MHz ~ 1752.6 MHz WCDMA Band V: 826.4 MHz ~ 846.6 MHz LTE Band 2: 1850.7 MHz ~ 1909.3 MHz LTE Band 4: 1710.7 MHz ~ 1754.3 MHz LTE Band 5: 824.7 MHz ~ 848.3 MHz LTE Band 17: 706.5 MHz ~ 713.5 MHz WLAN 2.4GHz Band: 2412 MHz ~ 2462 MHz Bluetooth: 2402 MHz ~ 2480 MHz NFC : 13.56 MHz
Mode	· RMC 12.2Kbps · HSDPA · HSUPA · HSPA+ (16QAM uplink is not supported) · LTE: QPSK, 16QAM · 802.11b/g/n HT20 · Bluetooth v3.0+EDR, Bluetooth v4.0 LE · NFC:ASK
HW Version	v01.01.01
SW Version	14.00.02
EUT Stage	Production Unit
Remark:	
1. Voice call is not supported. 2. 802.11n-HT40 is not supported in 2.4GHz WLAN.	



4.2 General LTE SAR Test and Reporting Considerations

Summarized necessary items addressed in KDB 941225 D05 v02r05																																													
FCC ID	V5PS920FDD-LTE																																												
Equipment Name	Mobile Payment Terminal																																												
Operating Frequency Range of each LTE transmission band	LTE Band 02: 1850.7 MHz ~ 1909.3 MHz LTE Band 04: 1710.7 MHz ~ 1754.3 MHz LTE Band 05: 824.7 MHz ~ 848.3 MHz LTE Band 17: 706.5 MHz ~ 713.5 MHz																																												
Channel Bandwidth	LTE Band 02: 1.4MHz, 3MHz, 5MHz, 10MHz, 15MHz, 20MHz LTE Band 04: 1.4MHz, 3MHz, 5MHz, 10MHz, 15MHz, 20MHz LTE Band 05: 1.4MHz, 3MHz, 5MHz, 10MHz LTE Band 17: 5MHz, 10MHz																																												
uplink modulations used	QPSK, and 16QAM																																												
LTE Voice / Data requirements	Data only																																												
LTE Release Version	R8, Cat 8																																												
LTE MPR permanently built-in by design	<p align="center">Table 6.2.3-1: Maximum Power Reduction (MPR) for Power Class 3</p> <table border="1"> <thead> <tr> <th rowspan="2">Modulation</th> <th colspan="6">Channel bandwidth / Transmission bandwidth (RB)</th> <th rowspan="2">MPR (dB)</th> </tr> <tr> <th>1.4 MHz</th> <th>3.0 MHz</th> <th>5 MHz</th> <th>10 MHz</th> <th>15 MHz</th> <th>20 MHz</th> </tr> </thead> <tbody> <tr> <td>QPSK</td> <td>> 5</td> <td>> 4</td> <td>> 8</td> <td>> 12</td> <td>> 16</td> <td>> 18</td> <td>≤ 1</td> </tr> <tr> <td>16 QAM</td> <td>≤ 5</td> <td>≤ 4</td> <td>≤ 8</td> <td>≤ 12</td> <td>≤ 16</td> <td>≤ 18</td> <td>≤ 1</td> </tr> <tr> <td>16 QAM</td> <td>> 5</td> <td>> 4</td> <td>> 8</td> <td>> 12</td> <td>> 16</td> <td>> 18</td> <td>≤ 2</td> </tr> </tbody> </table>							Modulation	Channel bandwidth / Transmission bandwidth (RB)						MPR (dB)	1.4 MHz	3.0 MHz	5 MHz	10 MHz	15 MHz	20 MHz	QPSK	> 5	> 4	> 8	> 12	> 16	> 18	≤ 1	16 QAM	≤ 5	≤ 4	≤ 8	≤ 12	≤ 16	≤ 18	≤ 1	16 QAM	> 5	> 4	> 8	> 12	> 16	> 18	≤ 2
Modulation	Channel bandwidth / Transmission bandwidth (RB)						MPR (dB)																																						
	1.4 MHz	3.0 MHz	5 MHz	10 MHz	15 MHz	20 MHz																																							
QPSK	> 5	> 4	> 8	> 12	> 16	> 18	≤ 1																																						
16 QAM	≤ 5	≤ 4	≤ 8	≤ 12	≤ 16	≤ 18	≤ 1																																						
16 QAM	> 5	> 4	> 8	> 12	> 16	> 18	≤ 2																																						
LTE A-MPR	In the base station simulator configuration, Network Setting value is set to NS_01 to disable A-MPR during SAR testing and the LTE SAR tests was transmitting on all TTI frames (Maximum TTI)																																												
Spectrum plots for RB configuration	A properly configured base station simulator was used for the SAR and power measurement; therefore, spectrum plots for each RB allocation and offset configuration are not included in the SAR report.																																												



Transmission (H, M, L) channel numbers and frequencies in each LTE band												
LTE Band 2												
	Bandwidth 1.4 MHz		Bandwidth 3 MHz		Bandwidth 5 MHz		Bandwidth 10 MHz		Bandwidth 15 MHz		Bandwidth 20 MHz	
	Ch. #	Freq. (MHz)	Ch. #	Freq. (MHz)	Ch. #	Freq. (MHz)	Ch. #	Freq. (MHz)	Ch. #	Freq. (MHz)	Ch. #	Freq. (MHz)
L	18607	1850.7	18615	1851.5	18625	1852.5	18650	1855	18675	1857.5	18700	1860
M	18900	1880	18900	1880	18900	1880	18900	1880	18900	1880	18900	1880
H	19193	1909.3	19185	1908.5	19175	1907.5	19150	1905	19125	1902.5	19100	1900
LTE Band 4												
	Bandwidth 1.4 MHz		Bandwidth 3 MHz		Bandwidth 5 MHz		Bandwidth 10 MHz		Bandwidth 15 MHz		Bandwidth 20 MHz	
	Ch. #	Freq. (MHz)	Ch. #	Freq. (MHz)	Ch. #	Freq. (MHz)	Ch. #	Freq. (MHz)	Ch. #	Freq. (MHz)	Ch. #	Freq. (MHz)
L	19957	1710.7	19965	1711.5	19975	1712.5	20000	1715	20025	1717.5	20050	1720
M	20175	1732.5	20175	1732.5	20175	1732.5	20175	1732.5	20175	1732.5	20175	1732.5
H	20393	1754.3	20385	1753.5	20375	1752.5	20350	1750	20325	1747.5	20300	1745
LTE Band 5												
	Bandwidth 1.4 MHz		Bandwidth 3 MHz		Bandwidth 5 MHz		Bandwidth 10 MHz					
	Ch. #	Freq. (MHz)	Ch. #	Freq. (MHz)	Ch. #	Freq. (MHz)	Ch. #	Freq. (MHz)	Ch. #	Freq. (MHz)	Ch. #	Freq. (MHz)
L	20407	824.7	20415	825.5	20425	826.5	20450	829				
M	20525	836.5	20525	836.5	20525	836.5	20525	836.5				
H	20643	848.3	20635	847.5	20625	846.5	20600	844				
LTE Band 17												
	Bandwidth 5 MHz					Bandwidth 10 MHz						
	Channel #		Freq.(MHz)			Channel #		Freq. (MHz)				
L	23755		706.5			23780		709				
M	23790		710			23790		710				
H	23825		713.5			23800		711				

5. RF Exposure Limits

5.1 Uncontrolled Environment

Uncontrolled Environments are defined as locations where there is the exposure of individuals who have no knowledge or control of their exposure. The general population/uncontrolled exposure limits are applicable to situations in which the general public may be exposed or in which persons who are exposed as a consequence of their employment may not be made fully aware of the potential for exposure or cannot exercise control over their exposure. Members of the general public would come under this category when exposure is not employment-related; for example, in the case of a wireless transmitter that exposes persons in its vicinity.

5.2 Controlled Environment

Controlled Environments are defined as locations where there is exposure that may be incurred by persons who are aware of the potential for exposure, (i.e. as a result of employment or occupation). In general, occupational/controlled exposure limits are applicable to situations in which persons are exposed as a consequence of their employment, who have been made fully aware of the potential for exposure and can exercise control over their exposure. The exposure category is also applicable when the exposure is of a transient nature due to incidental passage through a location where the exposure levels may be higher than the general population/uncontrolled limits, but the exposed person is fully aware of the potential for exposure and can exercise control over his or her exposure by leaving the area or by some other appropriate means.

Limits for Occupational/Controlled Exposure (W/kg)

Whole-Body	Partial-Body	Hands, Wrists, Feet and Ankles
0.4	8.0	20.0

Limits for General Population/Uncontrolled Exposure (W/kg)

Whole-Body	Partial-Body	Hands, Wrists, Feet and Ankles
0.08	1.6	4.0

1. Whole-Body SAR is averaged over the entire body, partial-body SAR is averaged over any 1gram of tissue defined as a tissue volume in the shape of a cube. SAR for hands, wrists, feet and ankles is averaged over any 10 grams of tissue defined as a tissue volume in the shape of a cube.

6. Specific Absorption Rate (SAR)

6.1 Introduction

SAR is related to the rate at which energy is absorbed per unit mass in an object exposed to a radio field. The SAR distribution in a biological body is complicated and is usually carried out by experimental techniques or numerical modeling. The standard recommends limits for two tiers of groups, occupational/controlled and general population/uncontrolled, based on a person's awareness and ability to exercise control over his or her exposure. In general, occupational/controlled exposure limits are higher than the limits for general population/uncontrolled.

6.2 SAR Definition

The SAR definition is the time derivative (rate) of the incremental energy (dW) absorbed by (dissipated in) an incremental mass (dm) contained in a volume element (dv) of a given density (ρ). The equation description is as below:

$$SAR = \frac{d}{dt} \left(\frac{dW}{dm} \right) = \frac{d}{dt} \left(\frac{dW}{\rho dv} \right)$$

SAR is expressed in units of Watts per kilogram (W/kg)

$$SAR = \frac{\sigma |E|^2}{\rho}$$

Where: σ is the conductivity of the tissue, ρ is the mass density of the tissue and E is the RMS electrical field strength.

7. System Description and Setup

The DASY system used for performing compliance tests consists of the following items:

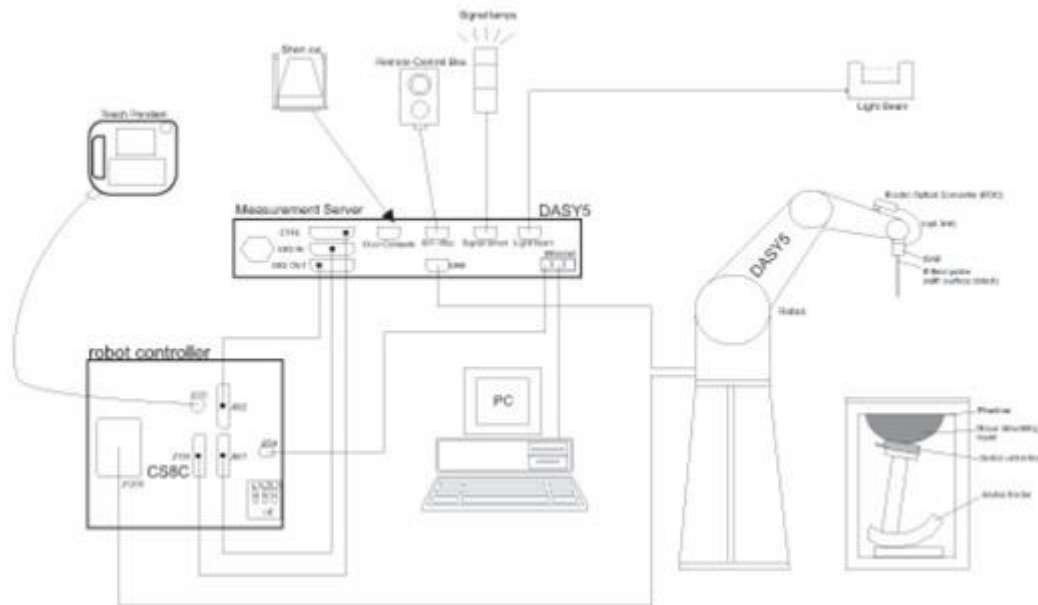

- A standard high precision 6-axis robot with controller, teach pendant and software. An arm extension for accommodating the data acquisition electronics (DAE).
- An isotropic Field probe optimized and calibrated for the targeted measurement.
- A data acquisition electronics (DAE) which performs the signal amplification, signal multiplexing, AD-conversion, offset measurements, mechanical surface detection, collision detection, etc. The unit is battery powered with standard or rechargeable batteries. The signal is optically transmitted to the EOC.
- The Electro-optical converter (EOC) performs the conversion from optical to electrical signals for the digital communication to the DAE. To use optical surface detection, a special version of the EOC is required. The EOC signal is transmitted to the measurement server.
- The function of the measurement server is to perform the time critical tasks such as signal filtering, control of the robot operation and fast movement interrupts.
- The Light Beam used is for probe alignment. This improves the (absolute) accuracy of the probe positioning.
- A computer running WinXP or Win7 and the DASY5 software.
- Remote control and teach pendant as well as additional circuitry for robot safety such as warning lamps, etc.
- The phantom, the device holder and other accessories according to the targeted measurement.

7.1 E-Field Probe

The SAR measurement is conducted with the dosimetric probe (manufactured by SPEAG).The probe is specially designed and calibrated for use in liquid with high permittivity. The dosimetric probe has special calibration in liquid at different frequency. This probe has a built in optical surface detection system to prevent from collision with phantom.

<EX3DV4 Probe>

Construction	Symmetric design with triangular core Built-in shielding against static charges PEEK enclosure material (resistant to organic solvents, e.g., DGBE)	
Frequency	10 MHz – >6 GHz Linearity: ±0.2 dB (30 MHz – 6 GHz)	
Directivity	±0.3 dB in TSL (rotation around probe axis) ±0.5 dB in TSL (rotation normal to probe axis)	
Dynamic Range	10 µW/g – >100 mW/g Linearity: ±0.2 dB (noise: typically <1 µW/g)	
Dimensions	Overall length: 337 mm (tip: 20 mm) Tip diameter: 2.5 mm (body: 12 mm) Typical distance from probe tip to dipole centers: 1 mm	

7.2 Data Acquisition Electronics (DAE)

The data acquisition electronics (DAE) consists of a highly sensitive electrometer-grade preamplifier with auto-zeroing, a channel and gain-switching multiplexer, a fast 16 bit AD-converter and a command decoder and control logic unit. Transmission to the measurement server is accomplished through an optical downlink for data and status information as well as an optical uplink for commands and the clock.

The input impedance of the DAE is 200 MOhm; the inputs are symmetrical and floating. Common mode rejection is above 80 dB.



Fig 5.1 Photo of DAE

7.3 Phantom

<SAM Twin Phantom>

Shell Thickness	2 ± 0.2 mm; Center ear point: 6 ± 0.2 mm	
Filling Volume	Approx. 25 liters	
Dimensions	Length: 1000 mm; Width: 500 mm; Height: adjustable feet	
Measurement Areas	Left Hand, Right Hand, Flat Phantom	

The bottom plate contains three pair of bolts for locking the device holder. The device holder positions are adjusted to the standard measurement positions in the three sections. A white cover is provided to tap the phantom during off-periods to prevent water evaporation and changes in the liquid parameters. On the phantom top, three reference markers are provided to identify the phantom position with respect to the robot.

<ELI Phantom>

Shell Thickness	2 ± 0.2 mm (sagging: <1%)	
Filling Volume	Approx. 30 liters	
Dimensions	Major ellipse axis: 600 mm Minor axis: 400 mm	

The ELI phantom is intended for compliance testing of handheld and body-mounted wireless devices in the frequency range of 30 MHz to 6 GHz. ELI4 is fully compatible with standard and all known tissue simulating liquids.

7.4 Device Holder

<Mounting Device for Hand-Held Transmitter>

In combination with the Twin SAM V5.0/V5.0c or ELI phantoms, the Mounting Device for Hand-Held Transmitters enables rotation of the mounted transmitter device to specified spherical coordinates. At the heads, the rotation axis is at the ear opening. Transmitter devices can be easily and accurately positioned according to IEC 62209-1, IEEE 1528, FCC, or other specifications. The device holder can be locked for positioning at different phantom sections (left head, right head, flat). And upgrade kit to Mounting Device to enable easy mounting of wider devices like big smart-phones, e-books, small tablets, etc. It holds devices with width up to 140 mm.



Mounting Device for Hand-Held Transmitters



Mounting Device Adaptor for Wide-Phones

<Mounting Device for Laptops and other Body-Worn Transmitters>

The extension is lightweight and made of POM, acrylic glass and foam. It fits easily on the upper part of the mounting device in place of the phone positioned. The extension is fully compatible with the SAM Twin and ELI phantoms.



Mounting Device for Laptops

8. Measurement Procedures

The measurement procedures are as follows:

<Conducted power measurement>

- (a) For WWAN power measurement, use base station simulator to configure EUT WWAN transmission in conducted connection with RF cable, at maximum power in each supported wireless interface and frequency band.
- (b) Read the WWAN RF power level from the base station simulator.
- (c) For WLAN/BT power measurement, use engineering software to configure EUT WLAN/BT continuously transmission, at maximum RF power in each supported wireless interface and frequency band
- (d) Connect EUT RF port through RF cable to the power meter, and measure WLAN/BT output power

<SAR measurement>

- (a) Use base station simulator to configure EUT WWAN transmission in radiated connection, and engineering software to configure EUT WLAN/BT continuously transmission, at maximum RF power, in the highest power channel.
- (b) Place the EUT in the positions as Appendix D demonstrates.
- (c) Set scan area, grid size and other setting on the DASY software.
- (d) Measure SAR results for the highest power channel on each testing position.
- (e) Find out the largest SAR result on these testing positions of each band
- (f) Measure SAR results for other channels in worst SAR testing position if the reported SAR of highest power channel is larger than 0.8 W/kg

According to the test standard, the recommended procedure for assessing the peak spatial-average SAR value consists of the following steps:

- (a) Power reference measurement
- (b) Area scan
- (c) Zoom scan
- (d) Power drift measurement

8.1 Spatial Peak SAR Evaluation

The procedure for spatial peak SAR evaluation has been implemented according to the test standard. It can be conducted for 1g and 10g, as well as for user-specific masses. The DASY software includes all numerical procedures necessary to evaluate the spatial peak SAR value.

The base for the evaluation is a "cube" measurement. The measured volume must include the 1g and 10g cubes with the highest averaged SAR values. For that purpose, the center of the measured volume is aligned to the interpolated peak SAR value of a previously performed area scan.

The entire evaluation of the spatial peak values is performed within the post-processing engine (SEMCAD). The system always gives the maximum values for the 1g and 10g cubes. The algorithm to find the cube with highest averaged SAR is divided into the following stages:

- (a) Extraction of the measured data (grid and values) from the Zoom Scan
- (b) Calculation of the SAR value at every measurement point based on all stored data (A/D values and measurement parameters)
- (c) Generation of a high-resolution mesh within the measured volume
- (d) Interpolation of all measured values from the measurement grid to the high-resolution grid
- (e) Extrapolation of the entire 3-D field distribution to the phantom surface over the distance from sensor to surface
- (f) Calculation of the averaged SAR within masses of 1g and 10g

8.2 Power Reference Measurement

The Power Reference Measurement and Power Drift Measurements are for monitoring the power drift of the device under test in the batch process. The minimum distance of probe sensors to surface determines the closest measurement point to phantom surface. This distance cannot be smaller than the distance of sensor calibration points to probe tip as defined in the probe properties.

8.3 Area Scan

The area scan is used as a fast scan in two dimensions to find the area of high field values, before doing a fine measurement around the hot spot. The sophisticated interpolation routines implemented in DASY software can find the maximum found in the scanned area, within a range of the global maximum. The range (in dB0 is specified in the standards for compliance testing. For example, a 2 dB range is required in IEEE standard 1528 and IEC 62209 standards, whereby 3 dB is a requirement when compliance is assessed in accordance with the ARIB standard (Japan), if only one zoom scan follows the area scan, then only the absolute maximum will be taken as reference. For cases where multiple maximums are detected, the number of zoom scans has to be increased accordingly.

Area scan parameters extracted from FCC KDB 865664 D01v01r04 SAR measurement 100 MHz to 6 GHz.

	≤ 3 GHz	> 3 GHz
Maximum distance from closest measurement point (geometric center of probe sensors) to phantom surface	5 ± 1 mm	$\frac{1}{2} \cdot \delta \cdot \ln(2) \pm 0.5$ mm
Maximum probe angle from probe axis to phantom surface normal at the measurement location	30° ± 1°	20° ± 1°
Maximum area scan spatial resolution: $\Delta x_{Area}, \Delta y_{Area}$	≤ 2 GHz: ≤ 15 mm 2 – 3 GHz: ≤ 12 mm	3 – 4 GHz: ≤ 12 mm 4 – 6 GHz: ≤ 10 mm
	When the x or y dimension of the test device, in the measurement plane orientation, is smaller than the above, the measurement resolution must be ≤ the corresponding x or y dimension of the test device with at least one measurement point on the test device.	

8.4 Zoom Scan

Zoom scans are used assess the peak spatial SAR values within a cubic averaging volume containing 1 gram and 10 gram of simulated tissue. The zoom scan measures points (refer to table below) within a cube shoes base faces are centered on the maxima found in a preceding area scan job within the same procedure. When the measurement is done, the zoom scan evaluates the averaged SAR for 1 gram and 10 gram and displays these values next to the job's label.

Zoom scan parameters extracted from FCC KDB 865664 D01v01r04 SAR measurement 100 MHz to 6 GHz.

		≤ 3 GHz	> 3 GHz	
Maximum zoom scan spatial resolution: $\Delta x_{Zoom}, \Delta y_{Zoom}$		≤ 2 GHz: ≤ 8 mm 2 – 3 GHz: ≤ 5 mm*	3 – 4 GHz: ≤ 5 mm* 4 – 6 GHz: ≤ 4 mm*	
Maximum zoom scan spatial resolution, normal to phantom surface	uniform grid: $\Delta z_{Zoom}(n)$	≤ 5 mm	3 – 4 GHz: ≤ 4 mm 4 – 5 GHz: ≤ 3 mm 5 – 6 GHz: ≤ 2 mm	
	graded grid	$\Delta z_{Zoom}(1)$: between 1 st two points closest to phantom surface	≤ 4 mm	3 – 4 GHz: ≤ 3 mm 4 – 5 GHz: ≤ 2.5 mm 5 – 6 GHz: ≤ 2 mm
		$\Delta z_{Zoom}(n>1)$: between subsequent points	$\leq 1.5 \cdot \Delta z_{Zoom}(n-1)$	
Minimum zoom scan volume	x, y, z	≥ 30 mm	3 – 4 GHz: ≥ 28 mm 4 – 5 GHz: ≥ 25 mm 5 – 6 GHz: ≥ 22 mm	
Note: δ is the penetration depth of a plane-wave at normal incidence to the tissue medium; see draft standard IEEE P1528-2011 for details. * When zoom scan is required and the <i>reported</i> SAR from the <i>area scan based 1-g SAR estimation</i> procedures of KDB 447498 is ≤ 1.4 W/kg, ≤ 8 mm, ≤ 7 mm and ≤ 5 mm zoom scan resolution may be applied, respectively, for 2 GHz to 3 GHz, 3 GHz to 4 GHz and 4 GHz to 6 GHz.				

8.5 Volume Scan Procedures

The volume scan is used for assess overlapping SAR distributions for antennas transmitting in different frequency bands. It is equivalent to an oversized zoom scan used in standalone measurements. The measurement volume will be used to enclose all the simultaneous transmitting antennas. For antennas transmitting simultaneously in different frequency bands, the volume scan is measured separately in each frequency band. In order to sum correctly to compute the 1g aggregate SAR, the EUT remain in the same test position for all measurements and all volume scan use the same spatial resolution and grid spacing. When all volume scan were completed, the software, SEMCAD postprocessor can combine and subsequently superpose these measurement data to calculating the multiband SAR.

8.6 Power Drift Monitoring

All SAR testing is under the EUT install full charged battery and transmit maximum output power. In DASy measurement software, the power reference measurement and power drift measurement procedures are used for monitoring the power drift of EUT during SAR test. Both these procedures measure the field at a specified reference position before and after the SAR testing. The software will calculate the field difference in dB. If the power drifts more than 5%, the SAR will be retested.



9. Test Equipment List

Manufacturer	Name of Equipment	Type/Model	Serial Number	Calibration Last Cal.	Due Date
SPEAG	750MHz System Validation Kit	D750V3	1087	Mar. 20, 2015	Mar. 19, 2016
SPEAG	835MHz System Validation Kit	D835V2	4d200	Aug. 20, 2015	Aug. 19, 2016
SPEAG	1750MHz System Validation Kit	D1750V2	1137	Apr. 28, 2015	Apr. 27, 2016
SPEAG	1900MHz System Validation Kit	D1900V2	5d210	Aug. 19, 2015	Aug. 18, 2016
SPEAG	2450MHz System Validation Kit	D2450V2	926	Jul. 24, 2015	Jul. 23, 2016
SPEAG	Data Acquisition Electronics	DAE4	1303	Nov. 24, 2015	Nov. 23, 2016
SPEAG	Dosimetric E-Field Probe	EX3DV4	3819	Nov. 27, 2015	Nov. 26, 2016
SPEAG	ELI4 Phantom	QD OVA 002 AA	TP-1149	NCR	NCR
SPEAG	Phone Positioner	N/A	N/A	NCR	NCR
Anritsu	Radio communication analyzer	MT8820C	6201300653	Aug. 25, 2015	Aug. 24, 2016
Agilent	Wireless Communication Test Set	E5515C	MY50267224	Aug. 07, 2015	Aug. 06, 2016
R&S	Network Analyzer	ZVB8	100106	Oct. 20, 2015	Oct. 19, 2016
Speag	Dielectric Assessment KIT	DAK-3.5	1032	NCR	NCR
R&S	Signal Generator	SMBV100A	258305	Jan. 23, 2015	Jan. 22, 2016
Anritsu	Power Sensor	MA2411B	1207253	Jan. 28, 2015	Jan. 27, 2016
Anritsu	Power Meter	ML2495A	1218010	Jan. 28, 2015	Jan. 27, 2016
Anritsu	Power Sensor	MA2411B	917070	Jan. 23, 2015	Jan. 22, 2016
Anritsu	Power Meter	ML2495A	1005002	Jan. 23, 2015	Jan. 22, 2016
R&S	CBT BLUETOOTH TESTER	CBT	100963	Jan. 28, 2015	Jan. 27, 2016
R&S	Spectrum Analyzer	FSP7	101634	Aug. 07, 2015	Aug. 06, 2016
ARRA	Power Divider	A3200-2	N/A	Note1	
Agilent	Dual Directional Coupler	778D	50422	Note1	
MCL	Attenuation1	BW-S10W5	N/A	Note1	
Weinschel	Attenuation2	3M-20	N/A	Note1	
Zhongjilianhe	Attenuation3	MVE2214-03	N/A	Note1	
AR	Amplifier	5S1G4	333096	Note1	

General Note:

1. Prior to system verification and validation, the path loss from the signal generator to the system check source and the power meter, which includes the amplifier, cable, attenuator and directional coupler, was measured by the network analyzer. The reading of the power meter was offset by the path loss difference between the path to the power meter and the path to the system check source to monitor the actual power level fed to the system check source.

10. System Verification

10.1 Tissue Verification

The following tissue formulations are provided for reference only as some of the parameters have not been thoroughly verified. The composition of ingredients may be modified accordingly to achieve the desired target tissue parameters required for routine SAR evaluation.

Frequency (MHz)	Water (%)	Sugar (%)	Cellulose (%)	Salt (%)	Preventol (%)	DGBE (%)	Conductivity (σ)	Permittivity (ε _r)
For Body								
750	51.7	47.2	0	0.9	0.1	0	0.96	55.5
835	50.8	48.2	0	0.9	0.1	0	0.97	55.2
1800, 1900, 2000	70.2	0	0	0.4	0	29.4	1.52	53.3
2450	68.6	0	0	0	0	31.4	1.95	52.7

<Tissue Dielectric Parameter Check Results>

Frequency (MHz)	Tissue Type	Liquid Temp. (°C)	Conductivity (σ)	Permittivity (ε _r)	Conductivity Target (σ)	Permittivity Target (ε _r)	Delta (σ) (%)	Delta (ε _r) (%)	Limit (%)	Date
750	Body	22.5	0.966	53.934	0.96	55.50	0.63	-2.82	±5	2015/12/25
835	Body	22.5	1.000	54.086	0.97	55.20	3.09	-2.02	±5	2015/12/25
1750	Body	22.6	1.514	53.575	1.49	53.40	1.61	0.33	±5	2015/12/24
1900	Body	22.7	1.525	54.504	1.52	53.30	0.33	2.26	±5	2015/12/24
2450	Body	22.8	1.949	51.667	1.95	52.70	-0.05	-1.96	±5	2016/1/4

10.2 System Performance Check Results

Comparing to the original SAR value provided by SPEAG, the verification data should be within its specification of 10 %. Below table shows the target SAR and measured SAR after normalized to 1W input power. The table below indicates the system performance check can meet the variation criterion and the plots can be referred to Appendix A of this report.

Date	Frequency (MHz)	Tissue Type	Input Power (mW)	Dipole S/N	Probe S/N	DAE S/N	Measured 1g SAR (W/kg)	Targeted 1g SAR (W/kg)	Normalized 1g SAR (W/kg)	Deviation (%)
2015/12/25	750	Body	250	1087	SN3819	SN1303	2.27	8.57	9.08	5.95
2015/12/25	835	Body	250	4d200	SN3819	SN1303	2.39	9.55	9.56	0.10
2015/12/24	1750	Body	250	1137	SN3819	SN1303	9.17	36.90	36.68	-0.60
2015/12/24	1900	Body	250	5d210	SN3819	SN1303	9.97	40.00	39.88	-0.30
2016/1/4	2450	Body	250	926	SN3819	SN1303	13.70	51.70	54.8	6.00

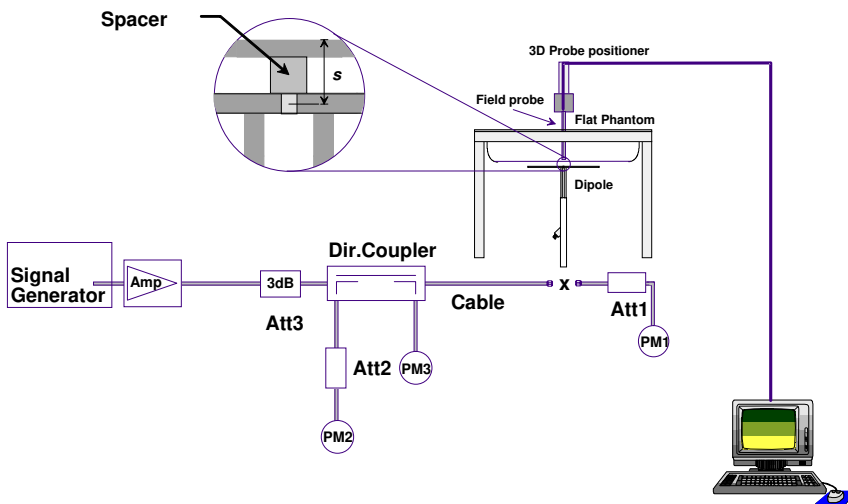

Fig 8.3.1 System Performance Check Setup



Fig 8.3.2 Setup Photo



11. RF Exposure Positions

11.1 Body Position

- (a) To position the device parallel to the phantom surface with either keypad up or down.
- (b) To adjust the device parallel to the flat phantom.
- (c) To adjust the distance between the device surface and the flat phantom to 0 cm.

<EUT Setup Photos>

Please refer to Appendix D for the test setup photos.

12. Conducted RF Output Power (Unit: dBm)

<WCDMA Conducted Power>

1. The following tests were conducted according to the test requirements outlines in 3GPP TS 34.121 specification.
2. The procedures in KDB 941225 D01v03r01 are applied for 3GPP Rel. 6 HSPA to configure the device in the required sub-test mode(s) to determine SAR test exclusion.

A summary of these settings are illustrated below:

HSDPA Setup Configuration:

- a. The EUT was connected to Base Station Agilent E5515C referred to the Setup Configuration.
- b. The RF path losses were compensated into the measurements.
- c. A call was established between EUT and Base Station with following setting:
 - i. Set Gain Factors (β_c and β_d) and parameters were set according to each
 - ii. Specific sub-test in the following table, C10.1.4, quoted from the TS 34.121
 - iii. Set RMC 12.2Kbps + HSDPA mode.
 - iv. Set Cell Power = -86 dBm
 - v. Set HS-DSCH Configuration Type to FRC (H-set 1, QPSK)
 - vi. Select HSDPA Uplink Parameters
 - vii. Set Delta ACK, Delta NACK and Delta CQI = 8
 - viii. Set Ack-Nack Repetition Factor to 3
 - ix. Set CQI Feedback Cycle (k) to 4 ms
 - x. Set CQI Repetition Factor to 2
 - xi. Power Ctrl Mode = All Up bits
- d. The transmitted maximum output power was recorded.

Table C.10.1.4: β values for transmitter characteristics tests with HS-DPCCH

Sub-test	β_c	β_d	β_d (SF)	β_c/β_d	β_{HS} (Note 1, Note 2)	CM (dB) (Note 3)	MPR (dB) (Note 3)
1	2/15	15/15	64	2/15	4/15	0.0	0.0
2	12/15 (Note 4)	15/15 (Note 4)	64	12/15 (Note 4)	24/15	1.0	0.0
3	15/15	8/15	64	15/8	30/15	1.5	0.5
4	15/15	4/15	64	15/4	30/15	1.5	0.5

Note 1: Δ_{ACK} , Δ_{NACK} and $\Delta_{CQI} = 30/15$ with $\beta_{HS} = 30/15 * \beta_c$.

Note 2: For the HS-DPCCH power mask requirement test in clause 5.2C, 5.7A, and the Error Vector Magnitude (EVM) with HS-DPCCH test in clause 5.13.1A, and HSDPA EVM with phase discontinuity in clause 5.13.1AA, Δ_{ACK} and $\Delta_{NACK} = 30/15$ with $\beta_{HS} = 30/15 * \beta_c$, and $\Delta_{CQI} = 24/15$ with $\beta_{HS} = 24/15 * \beta_c$.

Note 3: CM = 1 for $\beta_c/\beta_d = 12/15$, $\beta_{HS}/\beta_c = 24/15$. For all other combinations of DPDCCH, DPCCH and HS-DPCCH the MPR is based on the relative CM difference. This is applicable for only UEs that support HSDPA in release 6 and later releases.

Note 4: For subtest 2 the β_c/β_d ratio of 12/15 for the TFC during the measurement period (TF1, TF0) is achieved by setting the signalled gain factors for the reference TFC (TF1, TF1) to $\beta_c = 11/15$ and $\beta_d = 15/15$.

Setup Configuration

HSUPA Setup Configuration:

- a. The EUT was connected to Base Station Agilent E5515C referred to the Setup Configuration.
- b. The RF path losses were compensated into the measurements.
- c. A call was established between EUT and Base Station with following setting * :
 - i. Call Configs = 5.2B, 5.9B, 5.10B, and 5.13.2B with QPSK
 - ii. Set the Gain Factors (β_c and β_d) and parameters (AG Index) were set according to each specific sub-test in the following table, C11.1.3, quoted from the TS 34.121
 - iii. Set Cell Power = -86 dBm
 - iv. Set Channel Type = 12.2k + HSPA
 - v. Set UE Target Power
 - vi. Power Ctrl Mode= Alternating bits
 - vii. Set and observe the E-TFCl
 - viii. Confirm that E-TFCl is equal to the target E-TFCl of 75 for sub-test 1, and other subtest's E-TFCl
- d. The transmitted maximum output power was recorded.

Table C.11.1.3: β values for transmitter characteristics tests with HS-DPCCH and E-DCH

Sub-test	β_c	β_d	β_d (SF)	β_c/β_d	β_{HS} (Note 1)	β_{ec}	β_{ed} (Note 5) (Note 6)	β_{ed} (SF)	β_{ed} (Codes)	CM (dB) (Note 2)	MPR (dB) (Note 2)	AG Index (Note 6)	E-TFCl
1	11/15 (Note 3)	15/15 (Note 3)	64	11/15 (Note 3)	22/15	209/25	1309/225	4	1	1.0	0.0	20	75
2	6/15	15/15	64	6/15	12/15	12/15	94/75	4	1	3.0	2.0	12	67
3	15/15	9/15	64	15/9	30/15	30/15	$\beta_{ed1}: 47/15$ $\beta_{ed2}: 47/15$	4 4	2	2.0	1.0	15	92
4	2/15	15/15	64	2/15	4/15	2/15	56/75	4	1	3.0	2.0	17	71
5	15/15 (Note 4)	15/15 (Note 4)	64	15/15 (Note 4)	30/15	24/15	134/15	4	1	1.0	0.0	21	81

Note 1: $\Delta_{ACK}, \Delta_{NACK}$ and $\Delta_{CQI} = 30/15$ with $\beta_{hs} = 30/15 * \beta_c$.

Note 2: CM = 1 for $\beta_c/\beta_d = 12/15$, $\beta_{hs}/\beta_c = 24/15$. For all other combinations of DPDCH, DPCCH, HS- DPCCH, E-DPDCH and E-DPCCH the MPR is based on the relative CM difference.

Note 3: For subtest 1 the β_c/β_d ratio of 11/15 for the TFC during the measurement period (TF1, TF0) is achieved by setting the signalled gain factors for the reference TFC (TF1, TF1) to $\beta_c = 10/15$ and $\beta_d = 15/15$.

Note 4: For subtest 5 the β_c/β_d ratio of 15/15 for the TFC during the measurement period (TF1, TF0) is achieved by setting the signalled gain factors for the reference TFC (TF1, TF1) to $\beta_c = 14/15$ and $\beta_d = 15/15$.

Note 5: In case of testing by UE using E-DPDCH Physical Layer category 1, Sub-test 3 is omitted according to TS25.306 Table 5.1g.

Note 6: β_{ed} can not be set directly, it is set by Absolute Grant Value.

Setup Configuration



<WCDMA Conducted Power>

General Note:

1. Per KDB 941225 D01v03r01, SAR for Body exposure is measured using a 12.2 kbps RMC with TPC bits configured to all "1's".
2. Per KDB 941225 D01v03r01, RMC 12.2kbps setting is used to evaluate SAR. If the maximum output power and tune-up tolerance specified for production units in HSDPA / HSUPA is $\leq \frac{1}{4}$ dB higher than RMC 12.2Kbps or when the highest reported SAR of the RMC12.2Kbps is scaled by the ratio of specified maximum output power and tune-up tolerance of HSDPA / HSUPA to RMC12.2Kbps and the adjusted SAR is ≤ 1.2 W/kg, SAR measurement is not required for HSDPA / HSUPA.

Band		WCDMA V			Tune-up Limit (dBm)	WCDMA II			Tune-up Limit (dBm)
TX Channel		4132	4182	4233		9262	9400	9538	
Rx Channel		4357	4407	4458		9662	9800	9938	
Frequency (MHz)		826.4	836.4	846.6		1852.4	1880	1907.6	
3GPP Rel 99	RMC 12.2Kbps	23.10	22.98	22.87	23.50	22.34	22.52	22.64	23.00
3GPP Rel 6	HSDPA Subtest-1	22.29	22.08	22.09	23.00	21.54	21.38	21.42	22.00
3GPP Rel 6	HSDPA Subtest-2	22.37	22.20	22.18	23.00	21.50	21.20	21.52	22.00
3GPP Rel 6	HSDPA Subtest-3	22.21	22.05	22.19	23.00	20.79	20.68	20.76	21.00
3GPP Rel 6	HSDPA Subtest-4	22.27	22.03	22.17	23.00	20.79	20.70	20.76	21.00
3GPP Rel 6	HSUPA Subtest-1	21.91	21.60	22.03	22.50	20.84	21.05	21.41	22.00
3GPP Rel 6	HSUPA Subtest-2	20.78	20.51	20.71	21.00	19.57	19.62	19.69	20.00
3GPP Rel 6	HSUPA Subtest-3	20.92	20.79	20.69	21.00	19.03	19.08	19.60	20.00
3GPP Rel 6	HSUPA Subtest-4	20.94	20.97	21.09	21.50	19.55	19.64	19.71	20.00
3GPP Rel 6	HSUPA Subtest-5	22.20	22.00	22.10	23.00	21.30	21.10	21.50	22.00

Band		WCDMA IV			Tune-up Limit (dBm)
TX Channel		1312	1413	1513	
Rx Channel		1537	1638	1738	
Frequency (MHz)		1712.4	1732.6	1752.6	
3GPP Rel 99	RMC 12.2Kbps	22.43	22.53	22.32	23.00
3GPP Rel 6	HSDPA Subtest-1	21.07	21.20	21.10	22.00
3GPP Rel 6	HSDPA Subtest-2	21.05	21.26	21.21	22.00
3GPP Rel 6	HSDPA Subtest-3	20.50	20.73	20.55	21.00
3GPP Rel 6	HSDPA Subtest-4	20.04	20.63	20.56	21.00
3GPP Rel 6	HSUPA Subtest-1	20.83	20.76	20.70	21.00
3GPP Rel 6	HSUPA Subtest-2	19.46	19.53	19.57	20.00
3GPP Rel 6	HSUPA Subtest-3	18.74	18.93	18.79	19.00
3GPP Rel 6	HSUPA Subtest-4	19.39	20.38	20.31	21.00
3GPP Rel 6	HSUPA Subtest-5	21.10	21.10	21.20	22.00

**<LTE Conducted Power>****General Note:**

1. Anritsu MT8820C base station simulator was used to setup the connection with EUT; the frequency band, channel bandwidth, RB allocation configuration, modulation type are set in the base station simulator to configure EUT transmitting at maximum power and at different configurations which are requested to be reported to FCC, for conducted power measurement and SAR testing.
2. Per KDB 941225 D05v02r05, when a properly configured base station simulator is used for the SAR and power measurements, spectrum plots for each RB allocation and offset configuration is not required.
3. Per KDB 941225 D05v02r05, start with the largest channel bandwidth and measure SAR for QPSK with 1 RB allocation, using the RB offset and required test channel combination with the highest maximum output power for RB offsets at the upper edge, middle and lower edge of each required test channel.
4. Per KDB 941225 D05v02r05, 50% RB allocation for QPSK SAR testing follows 1RB QPSK allocation procedure.
5. Per KDB 941225 D05v02r05, For QPSK with 100% RB allocation, SAR is not required when the highest maximum output power for 100 % RB allocation is less than the highest maximum output power in 50% and 1 RB allocations and the highest reported SAR for 1 RB and 50% RB allocation are ≤ 0.8 W/kg. Otherwise, SAR is measured for the highest output power channel; and if the reported SAR is > 1.45 W/kg, the remaining required test channels must also be tested.
6. Per KDB 941225 D05v02r05, 16QAM output power for each RB allocation configuration is $>$ not $\frac{1}{2}$ dB higher than the same configuration in QPSK and the reported SAR for the QPSK configuration is ≤ 1.45 W/kg; Per KDB 941225 D05v02r05, 16QAM SAR testing is not required.
7. Per KDB 941225 D05v02r05, Smaller bandwidth output power for each RB allocation configuration is $>$ not $\frac{1}{2}$ dB higher than the same configuration in the largest supported bandwidth, and the reported SAR for the largest supported bandwidth is ≤ 1.45 W/kg; Per KDB 941225 D05v02r05, smaller bandwidth SAR testing is not required.
8. For LTE B5 / B4/ B17 the maximum bandwidth does not support three non-overlapping channels, per KDB 941225 D05v02r05, when a device supports overlapping channel assignment in a channel bandwidth configuration, the middle channel of the group of overlapping channels should be selected for testing.



<LTE Band 2>

BW [MHz]	Modulation	RB Size	RB Offset	Power Low Ch. / Freq.	Power Middle Ch. / Freq.	Power High Ch. / Freq.	Tune-up limit (dBm)	MPR (dB)
Channel				18700	18900	19100		
Frequency (MHz)				1860	1880	1900		
20	QPSK	1	0	22.01	22.08	22.01	23	0
20	QPSK	1	49	22.27	22.26	22.29		
20	QPSK	1	99	22.25	22.24	22.04		
20	QPSK	50	0	21.12	21.24	21.10	22	1
20	QPSK	50	24	21.27	21.17	21.32		
20	QPSK	50	50	21.34	21.25	21.39		
20	QPSK	100	0	21.27	21.18	21.28	22	1
20	16QAM	1	0	21.29	21.42	21.06		
20	16QAM	1	49	21.56	21.38	21.18		
20	16QAM	1	99	21.54	21.46	21.05	21	2
20	16QAM	50	0	20.15	20.17	20.20		
20	16QAM	50	24	20.18	20.14	20.31		
20	16QAM	50	50	20.25	20.11	20.34	21	2
20	16QAM	100	0	20.43	20.13	20.40		
Channel				18675	18900	19125		
Frequency (MHz)				1857.5	1880	1902.5		
15	QPSK	1	0	21.59	21.99	22.19	23	0
15	QPSK	1	37	21.86	22.00	22.25		
15	QPSK	1	74	21.99	22.01	22.11		
15	QPSK	36	0	20.87	21.08	21.13	22	1
15	QPSK	36	20	20.84	21.06	21.22		
15	QPSK	36	39	20.91	20.91	21.22		
15	QPSK	75	0	20.95	20.93	21.24	22	1
15	16QAM	1	0	20.52	20.73	20.89		
15	16QAM	1	37	20.64	20.69	21.03		
15	16QAM	1	74	20.67	20.70	20.71	21	2
15	16QAM	36	0	20.10	20.16	20.26		
15	16QAM	36	20	20.04	20.08	20.34		
15	16QAM	36	39	20.07	19.94	20.33	21	2
15	16QAM	75	0	20.09	20.04	20.34		



Channel				18650	18900	19150	Tune-up limit (dBm)	MPR (dB)
Frequency (MHz)				1855	1880	1905		
10	QPSK	1	0	21.50	21.75	22.26	23	0
10	QPSK	1	25	21.65	21.84	22.28		
10	QPSK	1	49	21.72	21.82	21.99		
10	QPSK	25	0	20.67	20.77	21.26	22	1
10	QPSK	25	12	20.69	20.85	21.23		
10	QPSK	25	25	20.66	20.78	21.23		
10	QPSK	50	0	20.73	20.89	21.20	22	1
10	16QAM	1	0	20.83	21.13	21.51		
10	16QAM	1	25	20.82	21.06	21.52		
10	16QAM	1	49	21.09	20.98	21.29	21	2
10	16QAM	25	0	20.12	20.07	20.33		
10	16QAM	25	12	20.08	20.05	20.33		
10	16QAM	25	25	20.03	20.10	20.34	21	2
10	16QAM	50	0	20.02	20.05	20.34		
Channel				18625	18900	19175	Tune-up limit (dBm)	MPR (dB)
Frequency (MHz)				1852.5	1880	1907.5		
5	QPSK	1	0	21.37	21.67	22.32	23	0
5	QPSK	1	12	21.57	21.86	22.30		
5	QPSK	1	24	21.37	21.98	22.04		
5	QPSK	12	0	20.48	20.84	21.43	22	1
5	QPSK	12	7	20.56	20.91	21.27		
5	QPSK	12	13	20.53	20.98	21.22		
5	QPSK	25	0	20.60	20.98	21.39	22	1
5	16QAM	1	0	20.70	21.17	21.59		
5	16QAM	1	12	20.76	21.20	21.49		
5	16QAM	1	24	20.65	21.17	21.29	21	2
5	16QAM	12	0	20.01	20.00	20.45		
5	16QAM	12	7	20.05	20.07	20.30		
5	16QAM	12	13	20.02	20.01	20.24	21	2
5	16QAM	25	0	20.05	20.07	20.26		



Channel				18615	18900	19185	Tune-up limit (dBm)	MPR (dB)
Frequency (MHz)				1851.5	1880	1908.5		
3	QPSK	1	0	21.20	21.57	22.16	23	0
3	QPSK	1	8	21.33	21.76	22.15		
3	QPSK	1	14	21.40	21.84	21.96		
3	QPSK	8	0	20.45	20.91	21.30	22	1
3	QPSK	8	4	20.58	20.92	21.29		
3	QPSK	8	7	20.57	20.89	21.18		
3	QPSK	15	0	20.60	20.93	21.17	22	1
3	16QAM	1	0	20.48	20.86	21.24		
3	16QAM	1	8	20.53	20.80	21.25		
3	16QAM	1	14	20.59	20.82	20.97	21	2
3	16QAM	8	0	20.01	20.12	20.31		
3	16QAM	8	4	20.02	20.10	20.28		
3	16QAM	8	7	20.06	20.04	20.16	21	2
3	16QAM	15	0	20.12	20.04	20.21		
Channel				18607	18900	19193	Tune-up limit (dBm)	MPR (dB)
Frequency (MHz)				1850.7	1880	1909.3		
1.4	QPSK	1	0	21.26	21.81	22.09	23	0
1.4	QPSK	1	3	21.52	21.94	22.05		
1.4	QPSK	1	5	21.55	21.91	21.97		
1.4	QPSK	3	0	21.49	21.91	22.14		
1.4	QPSK	3	1	21.33	21.79	22.03		
1.4	QPSK	3	3	21.33	21.73	21.84		
1.4	QPSK	6	0	20.49	20.86	20.96	22	1
1.4	16QAM	1	0	20.51	20.92	21.09	22	1
1.4	16QAM	1	3	20.36	20.81	20.98		
1.4	16QAM	1	5	20.63	20.89	20.83		
1.4	16QAM	3	0	20.63	21.02	21.28		
1.4	16QAM	3	1	20.60	20.94	21.14		
1.4	16QAM	3	3	20.56	20.88	21.22		
1.4	16QAM	6	0	20.09	20.03	20.36	21	2



<LTE Band 4>

BW [MHz]	Modulation	RB Size	RB Offset	Power Low Ch. / Freq.	Power Middle Ch. / Freq.	Power High Ch. / Freq.	Tune-up limit (dBm)	MPR (dB)
Channel				20050	20175	20300		
Frequency (MHz)				1720	1732.5	1745		
20	QPSK	1	0	21.91	21.91	22.01	22.5	0
20	QPSK	1	49	22.04	22.04	22.10		
20	QPSK	1	99	22.02	22.02	21.89		
20	QPSK	50	0	20.95	20.95	21.08	21.5	1
20	QPSK	50	24	20.94	20.94	20.85		
20	QPSK	50	50	20.88	20.88	20.72		
20	QPSK	100	0	20.97	20.97	20.95	21.5	1
20	16QAM	1	0	21.23	21.23	21.10		
20	16QAM	1	49	20.77	20.77	20.93		
20	16QAM	1	99	20.88	20.88	20.84	20.5	2
20	16QAM	50	0	20.12	20.14	20.18		
20	16QAM	50	24	20.01	20.03	20.02		
20	16QAM	50	50	20.06	20.05	20.00	20.5	2
20	16QAM	100	0	20.04	20.01	20.00		
Channel				20025	20175	20325		
Frequency (MHz)				1717.5	1732.5	1747.5		
15	QPSK	1	0	22.05	21.91	22.12	22.5	0
15	QPSK	1	37	22.06	22.17	21.80		
15	QPSK	1	74	22.10	21.93	21.81		
15	QPSK	36	0	21.08	21.13	20.90	21.5	1
15	QPSK	36	20	20.92	21.02	20.71		
15	QPSK	36	39	20.92	21.00	20.78		
15	QPSK	75	0	21.00	21.00	20.77	21.5	1
15	16QAM	1	0	20.74	20.74	20.90		
15	16QAM	1	37	20.71	20.82	20.55		
15	16QAM	1	74	20.75	20.74	20.63	20.5	2
15	16QAM	36	0	20.13	20.11	20.01		
15	16QAM	36	20	20.04	20.10	20.07		
15	16QAM	36	39	20.03	20.13	20.03	20.5	2
15	16QAM	75	0	20.09	20.07	20.02		



Channel				20000	20175	20350	Tune-up limit (dBm)	MPR (dB)
Frequency (MHz)				1715	1732.5	1750		
10	QPSK	1	0	21.91	22.09	21.84	22.5	0
10	QPSK	1	25	22.27	22.21	21.93		
10	QPSK	1	49	22.01	22.23	21.95		
10	QPSK	25	0	21.02	21.17	20.76	21.5	1
10	QPSK	25	12	21.08	21.06	20.84		
10	QPSK	25	25	20.96	21.02	20.82		
10	QPSK	50	0	20.88	20.94	20.74	21.5	1
10	16QAM	1	0	21.20	21.18	21.19		
10	16QAM	1	25	21.42	21.36	21.13		
10	16QAM	1	49	21.19	21.32	21.19	20.5	2
10	16QAM	25	0	20.12	20.08	20.07		
10	16QAM	25	12	20.10	20.03	20.02		
10	16QAM	25	25	20.10	20.08	20.03	20.5	2
10	16QAM	50	0	20.06	20.01	20.01		
Channel				19975	20175	20375		
Frequency (MHz)				1712.5	1732.5	1752.5		
5	QPSK	1	0	21.91	22.04	21.76	22.5	0
5	QPSK	1	12	22.15	22.24	21.82		
5	QPSK	1	24	22.28	22.06	21.95		
5	QPSK	12	0	21.10	21.18	20.91	21.5	1
5	QPSK	12	7	21.14	21.14	20.80		
5	QPSK	12	13	21.23	21.19	20.86		
5	QPSK	25	0	21.03	21.06	20.77	21.5	1
5	16QAM	1	0	20.71	20.94	21.14		
5	16QAM	1	12	20.99	21.03	21.15		
5	16QAM	1	24	20.97	20.91	21.24	20.5	2
5	16QAM	12	0	20.22	20.37	20.06		
5	16QAM	12	7	20.24	20.25	20.03		
5	16QAM	12	13	20.38	20.28	20.06	20.5	2
5	16QAM	25	0	20.18	20.23	20.04		



Channel				19965	20175	20385	Tune-up limit (dBm)	MPR (dB)
Frequency (MHz)				1711.5	1732.5	1753.5		
3	QPSK	1	0	21.97	22.05	21.71	22.5	0
3	QPSK	1	8	22.06	22.12	21.81		
3	QPSK	1	14	22.24	22.06	21.91		
3	QPSK	8	0	20.96	21.22	20.85	21.5	1
3	QPSK	8	4	21.09	21.30	20.98		
3	QPSK	8	7	21.06	21.30	21.03		
3	QPSK	15	0	21.02	21.20	20.90	21.5	1
3	16QAM	1	0	20.65	20.92	20.63		
3	16QAM	1	8	20.75	20.92	20.61		
3	16QAM	1	14	20.85	20.86	20.62	20.5	2
3	16QAM	8	0	20.06	20.08	20.02		
3	16QAM	8	4	20.07	20.11	20.06		
3	16QAM	8	7	20.01	20.08	20.02	20.5	2
3	16QAM	15	0	20.04	20.04	20.05		
Channel				19957	20175	20393	Tune-up limit (dBm)	MPR (dB)
Frequency (MHz)				1710.7	1732.5	1754.3		
1.4	QPSK	1	0	21.91	22.09	21.79	22.5	0
1.4	QPSK	1	3	22.05	22.13	21.96		
1.4	QPSK	1	5	21.95	22.14	21.89		
1.4	QPSK	3	0	21.98	22.22	22.00		
1.4	QPSK	3	1	22.00	22.16	21.90		
1.4	QPSK	3	3	22.00	22.13	21.82		
1.4	QPSK	6	0	20.86	21.14	20.85	21.5	1
1.4	16QAM	1	0	20.64	21.03	20.74	21.5	1
1.4	16QAM	1	3	20.77	21.01	20.79		
1.4	16QAM	1	5	20.60	21.11	20.83		
1.4	16QAM	3	0	21.12	21.27	21.11		
1.4	16QAM	3	1	21.01	21.29	21.02		
1.4	16QAM	3	3	21.00	21.35	21.15		
1.4	16QAM	6	0	20.15	20.27	20.17	20.5	2



<LTE Band 5>

BW [MHz]	Modulation	RB Size	RB Offset	Power Low Ch. / Freq.	Power Middle Ch. / Freq.	Power High Ch. / Freq.	Tune-up limit (dBm)	MPR (dB)
Channel				20450	20525	20600		
Frequency (MHz)				829	836.5	844		
10	QPSK	1	0	22.10	22.12	22.33		
10	QPSK	1	25	22.19	22.45	22.35	23	0
10	QPSK	1	49	22.18	22.28	21.82		
10	QPSK	25	0	21.15	21.15	21.11		
10	QPSK	25	12	21.05	21.38	21.00	22	1
10	QPSK	25	25	21.16	21.40	21.18		
10	QPSK	50	0	21.00	21.27	21.08		
10	16QAM	1	0	21.38	21.44	21.36	22	1
10	16QAM	1	25	21.31	21.73	21.05		
10	16QAM	1	49	21.37	21.47	21.07		
10	16QAM	25	0	20.15	20.22	20.19	21	2
10	16QAM	25	12	20.14	20.34	20.09		
10	16QAM	25	25	20.13	20.32	19.98		
10	16QAM	50	0	20.02	20.33	20.21		
Channel				20425	20525	20625	Tune-up limit (dBm)	MPR (dB)
Frequency (MHz)				826.5	836.5	846.5		
5	QPSK	1	0	22.07	22.13	21.99	23	0
5	QPSK	1	12	22.07	22.31	22.00		
5	QPSK	1	24	22.08	22.24	21.75		
5	QPSK	12	0	21.23	21.37	21.10	22	1
5	QPSK	12	7	21.11	21.58	21.09		
5	QPSK	12	13	21.10	21.49	21.13		
5	QPSK	25	0	21.14	21.31	21.02		
5	16QAM	1	0	21.15	21.16	20.91	22	1
5	16QAM	1	12	21.15	21.38	21.09		
5	16QAM	1	24	21.06	21.33	21.04		
5	16QAM	12	0	20.39	20.53	20.25	21	2
5	16QAM	12	7	20.11	20.70	20.30		
5	16QAM	12	13	20.34	20.63	20.26		
5	16QAM	25	0	20.30	20.43	20.15		



Channel				20415	20525	20635	Tune-up limit (dBm)	MPR (dB)
Frequency (MHz)				825.5	836.5	847.5		
3	QPSK	1	0	22.16	22.29	22.14	23	0
3	QPSK	1	8	22.11	22.44	22.08		
3	QPSK	1	14	22.21	22.32	21.84		
3	QPSK	8	0	21.26	21.47	21.12	22	1
3	QPSK	8	4	21.23	21.48	21.16		
3	QPSK	8	7	21.12	21.52	21.11		
3	QPSK	15	0	21.15	21.36	21.08	22	1
3	16QAM	1	0	21.52	21.73	21.44		
3	16QAM	1	8	21.46	21.69	21.34		
3	16QAM	1	14	21.42	21.69	21.01	21	2
3	16QAM	8	0	20.29	20.53	20.16		
3	16QAM	8	4	20.24	20.40	20.12		
3	16QAM	8	7	20.26	20.45	20.04	21	2
3	16QAM	15	0	20.32	20.55	20.22		
Channel				20407	20525	20643	Tune-up limit (dBm)	MPR (dB)
Frequency (MHz)				824.7	836.5	848.3		
1.4	QPSK	1	0	22.21	22.40	22.13	23	0
1.4	QPSK	1	3	22.15	22.25	22.02		
1.4	QPSK	1	5	22.09	22.24	21.98		
1.4	QPSK	3	0	22.21	22.27	22.12		
1.4	QPSK	3	1	22.09	22.23	22.04		
1.4	QPSK	3	3	22.13	22.20	22.03	22	1
1.4	QPSK	6	0	21.14	21.20	21.04		
1.4	16QAM	1	0	21.46	21.54	21.29	22	1
1.4	16QAM	1	3	21.53	21.63	21.29		
1.4	16QAM	1	5	21.38	21.62	21.22		
1.4	16QAM	3	0	21.24	21.40	21.19		
1.4	16QAM	3	1	21.08	21.48	21.12		
1.4	16QAM	3	3	21.07	21.41	21.08	21	2
1.4	16QAM	6	0	20.31	20.48	20.26		



<LTE Band 17>

BW [MHz]	Modulation	RB Size	RB Offset	Power Low Ch. / Freq.	Power Middle Ch. / Freq.	Power High Ch. / Freq.	Tune-up limit (dBm)	MPR (dB)
Channel				23780	23790	23800	23.5	0
Frequency (MHz)				709	710	711		
10	QPSK	1	0	22.95	23.00	23.05		
10	QPSK	1	25	23.02	23.09	23.07	22.5	1
10	QPSK	1	49	22.88	22.86	22.64		
10	QPSK	25	0	22.00	22.01	22.00		
10	QPSK	25	12	21.97	21.90	21.94	22.5	1
10	QPSK	25	25	21.88	21.90	21.81		
10	QPSK	50	0	21.87	21.92	21.91		
10	16QAM	1	0	22.25	22.13	22.26	22.5	1
10	16QAM	1	25	22.29	22.20	22.16		
10	16QAM	1	49	22.15	22.09	21.69		
10	16QAM	25	0	21.00	20.99	20.98	21.5	2
10	16QAM	25	12	20.97	20.95	20.94		
10	16QAM	25	25	21.00	20.90	20.92		
10	16QAM	50	0	20.98	20.92	20.92		
Channel				23755	23790	23825	Tune-up limit (dBm)	MPR (dB)
Frequency (MHz)				706.5	710	713.5		
5	QPSK	1	0	23.07	22.89	22.97	23.5	0
5	QPSK	1	12	23.08	23.06	22.98		
5	QPSK	1	24	23.02	22.96	22.44		
5	QPSK	12	0	22.09	22.07	21.99	22.5	1
5	QPSK	12	7	22.09	22.02	21.98		
5	QPSK	12	13	22.16	22.08	21.73		
5	QPSK	25	0	22.14	21.99	21.78	22.5	1
5	16QAM	1	0	22.29	22.07	22.13		
5	16QAM	1	12	22.44	22.26	22.22		
5	16QAM	1	24	22.40	22.22	21.70	21.5	2
5	16QAM	12	0	21.21	21.12	21.14		
5	16QAM	12	7	21.14	21.07	21.03		
5	16QAM	12	13	21.19	21.15	20.79		
5	16QAM	25	0	21.13	20.99	20.89		

**<WLAN Conducted Power>****General Note:**

1. Per KDB 248227 D01v02r02, SAR test reduction is determined according to 802.11 transmission mode configurations and certain exposure conditions with multiple test positions. In the 2.4 GHz band, separate SAR procedures are applied to DSSS and OFDM configurations to simplify DSSS test requirements. For OFDM, in both 2.4 and 5 GHz bands, an initial test configuration must be determined for each standalone and aggregated frequency band, according to the transmission mode configuration with the highest maximum output power specified for production units to perform SAR measurements. If the same highest maximum output power applies to different combinations of channel bandwidths, modulations and data rates, additional procedures are applied to determine which test configurations require SAR measurement. When applicable, an initial test position may be applied to reduce the number of SAR measurements required for next to the ear, UMPC mini-tablet or hotspot mode configurations with multiple test positions.
2. For 2.4 GHz 802.11b DSSS, either the initial test position procedure for multiple exposure test positions or the DSSS procedure for fixed exposure position is applied; these are mutually exclusive. For 2.4 GHz and 5 GHz OFDM configurations, the initial test configuration is applied to measure SAR using either the initial test position procedure for multiple exposure test position configurations or the initial test configuration procedures for fixed exposure test conditions. Based on the reported SAR of the measured configurations and maximum output power of the transmission mode configurations that are not included in the initial test configuration, the subsequent test configuration and initial test position procedures are applied to determine if SAR measurements are required for the remaining OFDM transmission configurations. In general, the number of test channels that require SAR measurement is minimized based on maximum output power measured for the test sample(s).
3. For OFDM transmission configurations in the 2.4 GHz and 5 GHz bands, When the same maximum power is specified for multiple transmission modes in a frequency band, the largest channel bandwidth, lowest order modulation, lowest data rate and lowest order 802.11a/g/n/ac mode is used for SAR measurement, on the highest measured output power channel for each frequency band.
4. DSSS and OFDM configurations are considered separately according to the required SAR procedures. SAR is measured in the initial test position using the 802.11 transmission mode configuration required by the DSSS procedure or initial test configuration and subsequent test configuration(s) according to the OFDM procedures.18 The initial test position procedure is described in the following:
 - a. When the reported SAR of the initial test position is ≤ 0.4 W/kg, further SAR measurement is not required for the other test positions in that exposure configuration and 802.11 transmission mode combinations within the frequency band or aggregated band.
 - b. When the reported SAR of the test position is > 0.4 W/kg, SAR is repeated for the 802.11 transmission mode configuration tested in the initial test position to measure the subsequent next closet/smallest test separation distance and maximum coupling test position on the highest maximum output power channel, until the report SAR is ≤ 0.8 W/kg or all required test position are tested.
 - c. For all positions/configurations, when the reported SAR is > 0.8 W/kg, SAR is measured for these test positions/configurations on the subsequent next highest measured output power channel(s) until the reported SAR is ≤ 1.2 W/kg or all required channels are tested.

<2.4GHz WLAN>

	Mode	Channel	Frequency (MHz)	Data Rate	Average power (dBm)	Tune-Up Limit	Duty Cycle %
2.4GHz WLAN	802.11b	CH 1	2412	1Mbps	16.27	17.00	97.61
		CH 6	2437		16.17	17.00	
		CH 11	2462		15.98	16.50	
	802.11g	CH 1	2412	6Mbps	15.59	16.00	87.46
		CH 6	2437		15.44	16.00	
		CH 11	2462		15.20	16.00	
	802.11n-HT20	CH 1	2412	MCS0	14.80	15.00	85.94
		CH 6	2437		14.67	15.00	
		CH 11	2462		14.37	15.00	



<2.4GHz Bluetooth>

General Note:

- 1. For 2.4GHz Bluetooth SAR testing was selected 1Mbps, due to its highest average power.
- 2. The duty factor is selected theoretical 83.3% perform Bluetooth SAR testing.

Mode	Channel	Frequency (MHz)	Average power (dBm)			Tune-Up Limit
			1Mbps	2Mbps	3Mbps	
V3.0 with EDR	CH 00	2402	9.16	5.72	5.73	10.0
	CH 39	2441	8.62	5.65	5.66	9.0
	CH 78	2480	7.77	4.96	4.96	8.0

Mode	Channel	Frequency (MHz)	Average power (dBm)	Tune-Up Limit
			GFSK	
v4.0 with LE	CH 00	2402	7.76	8.0
	CH 19	2440	7.26	
	CH 39	2480	6.43	

13. Antenna Location

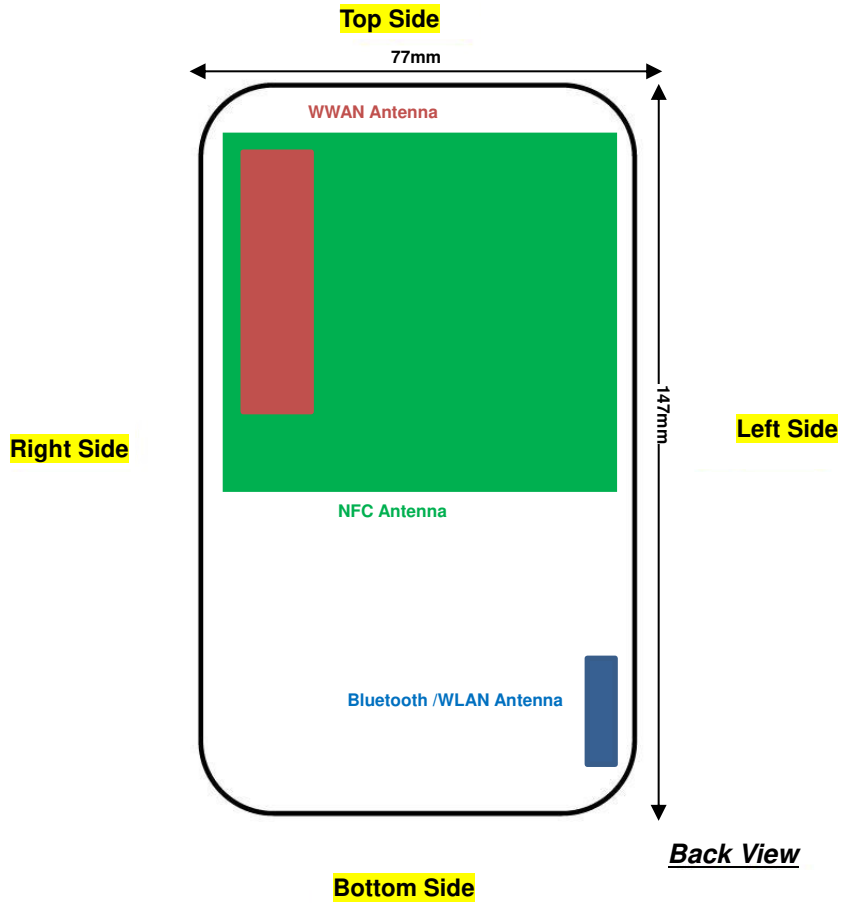



14. SAR Test Results

General Note:

1. Per KDB 447498 D01v06, the reported SAR is the measured SAR value adjusted for maximum tune-up tolerance.
 - a. Tune-up scaling Factor = tune-up limit power (mW) / EUT RF power (mW), where tune-up limit is the maximum rated power among all production units.
 - b. For SAR testing of WLAN signal with non-100% duty cycle, the measured SAR is scaled-up by the duty cycle scaling factor which is equal to "1/(duty cycle)"
 - c. For WWAN/Bluetooth: Reported SAR(W/kg)= Measured SAR(W/kg)*Tune-up Scaling Factor
 - d. For WLAN: Reported SAR(W/kg)= Measured SAR(W/kg)* Duty Cycle scaling factor * Tune-up scaling factor
2. Per KDB 447498 D01v06, for each exposure position, testing of other required channels within the operating mode of a frequency band is not required when the *reported* 1-g or 10-g SAR for the mid-band or highest output power channel is:
 - ≤ 0.8 W/kg or 2.0 W/kg, for 1-g or 10-g respectively, when the transmission band is ≤ 100 MHz
 - ≤ 0.6 W/kg or 1.5 W/kg, for 1-g or 10-g respectively, when the transmission band is between 100 MHz and 200 MHz
 - ≤ 0.4 W/kg or 1.0 W/kg, for 1-g or 10-g respectively, when the transmission band is ≥ 200 MHz
3. Per KDB 865664 D01v01r03, for each frequency band, repeated SAR measurement is required only when the measured SAR is ≥ 0.8 W/kg.

UMTS Note:

1. Per KDB 941225 D01v03r01, SAR for Body exposure is measured using a 12.2 kbps RMC with TPC bits configured to all "1's".
2. Per KDB 941225 D01v03r01, RMC 12.2kbps setting is used to evaluate SAR. If the maximum output power and tune-up tolerance specified for production units in HSDPA / HSUPA is $\leq \frac{1}{4}$ dB higher than RMC 12.2Kbps or when the highest reported SAR of the RMC12.2Kbps is scaled by the ratio of specified maximum output power and tune-up tolerance of HSDPA / HSUPA to RMC12.2Kbps and the adjusted SAR is ≤ 1.2 W/kg, SAR measurement is not required for HSDPA / HSUPA.

LTE Note:

1. Per KDB 941225 D05v02r05, start with the largest channel bandwidth and measure SAR for QPSK with 1 RB allocation, using the RB offset and required test channel combination with the highest maximum output power for RB offsets at the upper edge, middle and lower edge of each required test channel.
2. Per KDB 941225 D05v02r05, 50% RB allocation for QPSK SAR testing follows 1RB QPSK allocation procedure.
3. Per KDB 941225 D05v02r05, For QPSK with 100% RB allocation, SAR is not required when the highest maximum output power for 100 % RB allocation is less than the highest maximum output power in 50% and 1 RB allocations and the highest reported SAR for 1 RB and 50% RB allocation are ≤ 0.8 W/kg. Otherwise, SAR is measured for the highest output power channel; and if the reported SAR is > 1.45 W/kg, the remaining required test channels must also be tested.
4. Per KDB 941225 D05v02r05, 16QAM output power for each RB allocation configuration is $> \text{not } \frac{1}{2}$ dB higher than the same configuration in QPSK and the reported SAR for the QPSK configuration is ≤ 1.45 W/kg; Per KDB 941225 D05v02r05, 16QAM SAR testing is not required.
5. Per KDB 941225 D05v02r05, Smaller bandwidth output power for each RB allocation configuration is $> \text{not } \frac{1}{2}$ dB higher than the same configuration in the largest supported bandwidth, and the reported SAR for the largest supported bandwidth is ≤ 1.45 W/kg; Per KDB 941225 D05v02r05, smaller bandwidth SAR testing is not required.
6. For LTE B5 / B4 /B17 the maximum bandwidth does not support three non-overlapping channels, per KDB 941225 D05v02r05, when a device supports overlapping channel assignment in a channel bandwidth configuration, the middle channel of the group of overlapping channels should be selected for testing.



WLAN Note:

1. Per KDB 248227 D01v02r02, for 2.4GHz 802.11g/n SAR testing is not required when the highest reported SAR for DSSS is adjusted by the ratio of OFDM to DSSS specified maximum output power and the adjusted SAR is ≤ 1.2 W/kg.
2. When the reported SAR of the test position is > 0.4 W/kg, SAR is repeated for the 802.11 transmission mode configuration tested in the initial test position to measure the subsequent next closet/smallest test separation distance and maximum coupling test position on the highest maximum output power channel, until the report SAR is ≤ 0.8 W/kg or all required test position are tested.
3. For all positions / configurations, when the reported SAR is > 0.8 W/kg, SAR is measured for these test positions / configurations on the subsequent next highest measured output power channel(s) until the reported SAR is ≤ 1.2 W/kg or all required channels are tested.
4. During SAR testing the WLAN transmission was verified using a spectrum analyzer.



14.1 Body SAR

<WCDMA SAR>

Plot No.	Band	Mode	Test Position	Gap (mm)	Ch.	Freq. (MHz)	Average Power (dBm)	Tune-Up Limit (dBm)	Tune-up Scaling Factor	Power Drift (dB)	Measured 1g SAR (W/kg)	Reported 1g SAR (W/kg)
1	WCDMA Band V	RMC 12.2Kbps	Front	0mm	4132	826.4	23.10	23.50	1.096	-0.05	0.674	0.739
	WCDMA Band V	RMC 12.2Kbps	Back	0mm	4132	826.4	23.10	23.50	1.096	-0.07	0.37	0.406
2	WCDMA Band IV	RMC 12.2Kbps	Front	0mm	1413	1732.6	22.53	23.00	1.114	-0.07	0.576	0.642
	WCDMA Band IV	RMC 12.2Kbps	Back	0mm	1413	1732.6	22.53	23.00	1.114	0.12	0.228	0.254
3	WCDMA Band II	RMC 12.2Kbps	Front	0mm	9538	1907.6	22.64	23.00	1.086	-0.06	0.463	0.503
	WCDMA Band II	RMC 12.2Kbps	Back	0mm	9538	1907.6	22.64	23.00	1.086	0.04	0.286	0.311

<LTE SAR>

Plot No.	Band	BW (MHz)	Modulation	RB Size	RB offset	Test Position	Gap (mm)	Ch.	Freq. (MHz)	Average Power (dBm)	Tune-Up Limit (dBm)	Tune-up Scaling Factor	Power Drift (dB)	Measured 1g SAR (W/kg)	Reported 1g SAR (W/kg)
4	LTE Band 17	10M	QPSK	1	25	Front	0mm	23790	710	23.09	23.50	1.099	0.16	0.537	0.590
	LTE Band 17	10M	QPSK	1	25	Back	0mm	23790	710	23.09	23.50	1.099	-0.15	0.236	0.259
	LTE Band 17	10M	QPSK	25	0	Front	0mm	23790	710	22.01	22.50	1.119	-0.08	0.453	0.507
	LTE Band 17	10M	QPSK	25	0	Back	0mm	23790	710	22.01	22.50	1.119	-0.14	0.199	0.223
5	LTE Band 5	10M	QPSK	1	25	Front	0mm	20525	836.5	22.45	23.00	1.135	-0.04	0.613	0.696
	LTE Band 5	10M	QPSK	1	25	Back	0mm	20525	836.5	22.45	23.00	1.135	0.05	0.211	0.239
	LTE Band 5	10M	QPSK	25	25	Front	0mm	20525	836.5	21.40	22.00	1.148	-0.09	0.553	0.635
	LTE Band 5	10M	QPSK	25	25	Back	0mm	20525	836.5	21.40	22.00	1.148	-0.09	0.199	0.228
6	LTE Band 4	20M	QPSK	1	49	Front	0mm	20175	1732.5	22.04	22.50	1.112	-0.15	0.539	0.599
	LTE Band 4	20M	QPSK	1	49	Back	0mm	20175	1732.5	22.04	22.50	1.112	0.02	0.222	0.247
	LTE Band 4	20M	QPSK	50	0	Front	0mm	20175	1732.5	20.95	21.50	1.135	0.06	0.449	0.510
	LTE Band 4	20M	QPSK	50	0	Back	0mm	20175	1732.5	20.95	21.50	1.135	-0.06	0.181	0.205
7	LTE Band 2	20M	QPSK	1	49	Front	0mm	19100	1900	22.29	23.00	1.178	0.11	0.408	0.480
	LTE Band 2	20M	QPSK	1	49	Back	0mm	19100	1900	22.29	23.00	1.178	-0.08	0.331	0.390
	LTE Band 2	20M	QPSK	50	50	Front	0mm	19100	1900	21.39	22.00	1.151	0.18	0.348	0.400
	LTE Band 2	20M	QPSK	50	50	Back	0mm	19100	1900	21.39	22.00	1.151	-0.07	0.257	0.296

<WLAN SAR>

Plot No.	Band	Mode	Test Position	Gap (mm)	Ch.	Freq. (MHz)	Average Power (dBm)	Tune-Up Limit (dBm)	Tune-up Scaling Factor	Duty Cycle %	Duty Cycle Scaling Factor	Power Drift (dB)	Measured 1g SAR (W/kg)	Reported 1g SAR (W/kg)
8	WLAN2.4GHz	802.11b 1Mbps	Front	0mm	1	2412	16.27	17.00	1.184	97.61	1.025	-0.01	0.034	0.041
	WLAN2.4GHz	802.11b 1Mbps	Back	0mm	1	2412	16.27	17.00	1.184	97.61	1.025	-0.08	0.378	0.459



<Bluetooth SAR>

Plot No.	Band	Mode	Test Position	Gap (mm)	Ch	Freq. (MHz)	Average Power (dBm)	Tune-Up Limit (dBm)	Tune-up Scaling Factor	Power Drift (dB)	Measured 1g SAR (W/kg)	Reported 1g SAR (W/kg)
	Bluetooth	1Mbps	Front	0mm	0	2402	9.16	10.00	1.212	-0.18	0.00569	0.007
9	Bluetooth	1Mbps	Back	0mm	0	2402	9.16	10.00	1.212	0.06	0.06	0.073

15. Simultaneous Transmission Analysis

NO.	Simultaneous Transmission Configurations	Body
1.	WCDMA + WLAN2.4GHz	Yes
2.	LTE + WLAN2.4GHz	Yes
3.	WCDMA+ Bluetooth	Yes
4.	LTE + Bluetooth	Yes

General Note:

1. EUT will choose each WCDMA and LTE according to the network signal condition; therefore, they will not operate simultaneously at any moment.
2. WLAN and Bluetooth share the same antenna, and cannot transmit simultaneously.
3. The Reported SAR summation is calculated based on the same configuration and test position.
4. Per KDB 447498 D01v06, simultaneous transmission SAR is compliant if,
 - i) Scalar SAR summation < 1.6W/kg.
 - ii) $SPLSR = (SAR1 + SAR2)^{1.5} / (\text{min. separation distance, mm})$, and the peak separation distance is determined from the square root of $[(x1-x2)^2 + (y1-y2)^2 + (z1-z2)^2]$, where (x1, y1, z1) and (x2, y2, z2) are the coordinates of the extrapolated peak SAR locations in the zoom scan.
 - iii) If $SPLSR \leq 0.04$, simultaneously transmission SAR measurement is not necessary.
 - iv) Simultaneously transmission SAR measurement, and the reported multi-band SAR < 1.6W/kg.



15.1 Body Exposure Conditions

WWAN Band		Exposure Position	1	2	3	1+2 Summed 1g SAR (W/kg)	1+3 Summed 1g SAR (W/kg)
			WWAN	2.4GHz WLAN	Bluetooth		
			1g SAR (W/kg)	1g SAR (W/kg)	Estimated 1g SAR (W/kg)		
WCDMA	WCDMA Band V	Front	0.739	0.041	0.007	0.78	0.75
		Back	0.406	0.459	0.073	0.87	0.48
	WCDMA Band IV	Front	0.642	0.041	0.007	0.68	0.65
		Back	0.254	0.459	0.073	0.71	0.33
	WCDMA Band II	Front	0.503	0.041	0.007	0.54	0.51
		Back	0.311	0.459	0.073	0.77	0.38
LTE	LTE Band 17	Front	0.590	0.041	0.007	0.63	0.60
		Back	0.259	0.459	0.073	0.72	0.33
	LTE Band 5	Front	0.696	0.041	0.007	0.74	0.70
		Back	0.239	0.459	0.073	0.70	0.31
	LTE Band 4	Front	0.599	0.041	0.007	0.64	0.61
		Back	0.247	0.459	0.073	0.71	0.32
	LTE Band 2	Front	0.480	0.041	0.007	0.52	0.49
		Back	0.390	0.459	0.073	0.85	0.46

Test Engineer : Luke Lu

16. Uncertainty Assessment

The component of uncertainty may generally be categorized according to the methods used to evaluate them. The evaluation of uncertainty by the statistical analysis of a series of observations is termed a Type A evaluation of uncertainty. The evaluation of uncertainty by means other than the statistical analysis of a series of observation is termed a Type B evaluation of uncertainty. Each component of uncertainty, however evaluated, is represented by an estimated standard deviation, termed standard uncertainty, which is determined by the positive square root of the estimated variance.

A Type A evaluation of standard uncertainty may be based on any valid statistical method for treating data. This includes calculating the standard deviation of the mean of a series of independent observations; using the method of least squares to fit a curve to the data in order to estimate the parameter of the curve and their standard deviations; or carrying out an analysis of variance in order to identify and quantify random effects in certain kinds of measurement.

A type B evaluation of standard uncertainty is typically based on scientific judgment using all of the relevant information available. These may include previous measurement data, experience, and knowledge of the behavior and properties of relevant materials and instruments, manufacture’s specification, data provided in calibration reports and uncertainties assigned to reference data taken from handbooks. Broadly speaking, the uncertainty is either obtained from an outdoor source or obtained from an assumed distribution, such as the normal distribution, rectangular or triangular distributions indicated in table below.

Uncertainty Distributions	Normal	Rectangular	Triangular	U-Shape
Multi-plying Factor ^(a)	1/ κ ^(b)	1/ $\sqrt{3}$	1/ $\sqrt{6}$	1/ $\sqrt{2}$

(a) standard uncertainty is determined as the product of the multiplying factor and the estimated range of variations in the measured quantity

(b) κ is the coverage factor

Table 16.1. Standard Uncertainty for Assumed Distribution

The combined standard uncertainty of the measurement result represents the estimated standard deviation of the result. It is obtained by combining the individual standard uncertainties of both Type A and Type B evaluation using the usual “root-sum-squares” (RSS) methods of combining standard deviations by taking the positive square root of the estimated variances.

Expanded uncertainty is a measure of uncertainty that defines an interval about the measurement result within which the measured value is confidently believed to lie. It is obtained by multiplying the combined standard uncertainty by a coverage factor. Typically, the coverage factor ranges from 2 to 3. Using a coverage factor allows the true value of a measured quantity to be specified with a defined probability within the specified uncertainty range. For purpose of this document, a coverage factor two is used, which corresponds to confidence interval of about 95 %. The DASY uncertainty Budget is shown in the following tables.



Error Description	Uncertainty Value (±%)	Probability	Divisor	(Ci) 1g	(Ci) 10g	Standard Uncertainty (1g) (±%)	Standard Uncertainty (10g) (±%)
Measurement System							
Probe Calibration	6.0	N	1	1	1	6.0	6.0
Axial Isotropy	4.7	R	1.732	0.7	0.7	1.9	1.9
Hemispherical Isotropy	9.6	R	1.732	0.7	0.7	3.9	3.9
Boundary Effects	1.0	R	1.732	1	1	0.6	0.6
Linearity	4.7	R	1.732	1	1	2.7	2.7
System Detection Limits	1.0	R	1.732	1	1	0.6	0.6
Modulation Response	3.2	R	1.732	1	1	1.8	1.8
Readout Electronics	0.3	N	1	1	1	0.3	0.3
Response Time	0.0	R	1.732	1	1	0.0	0.0
Integration Time	2.6	R	1.732	1	1	1.5	1.5
RF Ambient Noise	3.0	R	1.732	1	1	1.7	1.7
RF Ambient Reflections	3.0	R	1.732	1	1	1.7	1.7
Probe Positioner	0.4	R	1.732	1	1	0.2	0.2
Probe Positioning	2.9	R	1.732	1	1	1.7	1.7
Max. SAR Eval.	2.0	R	1.732	1	1	1.2	1.2
Test Sample Related							
Device Positioning	3.0	N	1	1	1	3.0	3.0
Device Holder	3.6	N	1	1	1	3.6	3.6
Power Drift	5.0	R	1.732	1	1	2.9	2.9
Power Scaling	0.0	R	1.732	1	1	0.0	0.0
Phantom and Setup							
Phantom Uncertainty	6.1	R	1.732	1	1	3.5	3.5
SAR correction	0.0	R	1.732	1	0.84	0.0	0.0
Liquid Conductivity Repeatability	0.2	N	1	0.78	0.71	0.1	0.1
Liquid Conductivity (target)	5.0	R	1.732	0.78	0.71	2.3	2.0
Liquid Conductivity (mea.)	2.5	R	1.732	0.78	0.71	1.1	1.0
Temp. unc. - Conductivity	3.4	R	1.732	0.78	0.71	1.5	1.4
Liquid Permittivity Repeatability	0.15	N	1	0.23	0.26	0.0	0.0
Liquid Permittivity (target)	5.0	R	1.732	0.23	0.26	0.7	0.8
Liquid Permittivity (mea.)	2.5	R	1.732	0.23	0.26	0.3	0.4
Temp. unc. - Permittivity	0.83	R	1.732	0.23	0.26	0.1	0.1
Combined Std. Uncertainty						11.4%	11.4%
Coverage Factor for 95 %						K=2	K=2
Expanded STD Uncertainty						22.9%	22.7%

Table 16.2. Uncertainty Budget for frequency range 300 MHz to 3 GHz



17. References

- [1] FCC 47 CFR Part 2 "Frequency Allocations and Radio Treaty Matters; General Rules and Regulations"
- [2] ANSI/IEEE Std. C95.1-1992, "IEEE Standard for Safety Levels with Respect to Human Exposure to Radio Frequency Electromagnetic Fields, 3 kHz to 300 GHz", September 1992
- [3] IEEE Std. 1528-2013, "IEEE Recommended Practice for Determining the Peak Spatial-Average Specific Absorption Rate (SAR) in the Human Head from Wireless Communications Devices: Measurement Techniques", Sep 2013
- [4] SPEAG DASY System Handbook
- [5] FCC KDB 248227 D01 v02r02, "SAR Guidance for IEEE 802.11 (WiFi) Transmitters", Oct 2015.
- [6] FCC KDB 447498 D01 v06, "Mobile and Portable Device RF Exposure Procedures and Equipment Authorization Policies", Oct 2015
- [7] FCC KDB 941225 D01 v03r01, "3G SAR MEAUREMENT PROCEDURES", Oct 2015
- [8] FCC KDB 941225 D05 v02r05, "SAR Evaluation Considerations for LTE Devices", Dec 2015
- [9] FCC KDB 865664 D01 v01r04, "SAR Measurement Requirements for 100 MHz to 6 GHz", Aug 2015.
- [10] FCC KDB 865664 D02 v01r02, "RF Exposure Compliance Reporting and Documentation Considerations" Oct 2015.



Appendix A. Plots of System Performance Check

The plots are shown as follows.

System Check_Body_750MHz_151225

DUT: Dipole 750 MHz

Communication System: UID 0, CW; Frequency: 750 MHz; Duty Cycle: 1:1

Medium: MSL_750_151225 Medium parameters used: $f = 750 \text{ MHz}$; $\sigma = 0.966 \text{ S/m}$; $\epsilon_r = 53.934$; $\rho = 1000 \text{ kg/m}^3$

Ambient Temperature : $23.3 \text{ }^\circ\text{C}$; Liquid Temperature : $22.5 \text{ }^\circ\text{C}$

DASY5 Configuration:

- Probe: EX3DV4 - SN3819; ConvF(9.69, 9.69, 9.69); Calibrated: 2015.11.27;
- Sensor-Surface: 2mm (Mechanical Surface Detection)
- Electronics: DAE4 Sn1303; Calibrated: 2015.11.24
- Phantom: SAM3; Type: QDOVA002AA; Serial: TP:1149
- Measurement SW: DASY52, Version 52.8 (8); SEMCAD X Version 14.6.10 (7331)

Pin=250mW/Area Scan (61x61x1): Interpolated grid: $dx=15\text{mm}$, $dy=15\text{mm}$

Maximum value of SAR (interpolated) = 2.81 W/kg

Pin=250mW/Zoom Scan (5x5x7)/Cube 0: Measurement grid: $dx=8\text{mm}$, $dy=8\text{mm}$, $dz=5\text{mm}$

Reference Value = 49.84 V/m ; Power Drift = 0.03 dB

Peak SAR (extrapolated) = 3.28 W/kg

SAR(1 g) = 2.27 W/kg ; SAR(10 g) = 1.52 W/kg

Maximum value of SAR (measured) = 2.83 W/kg

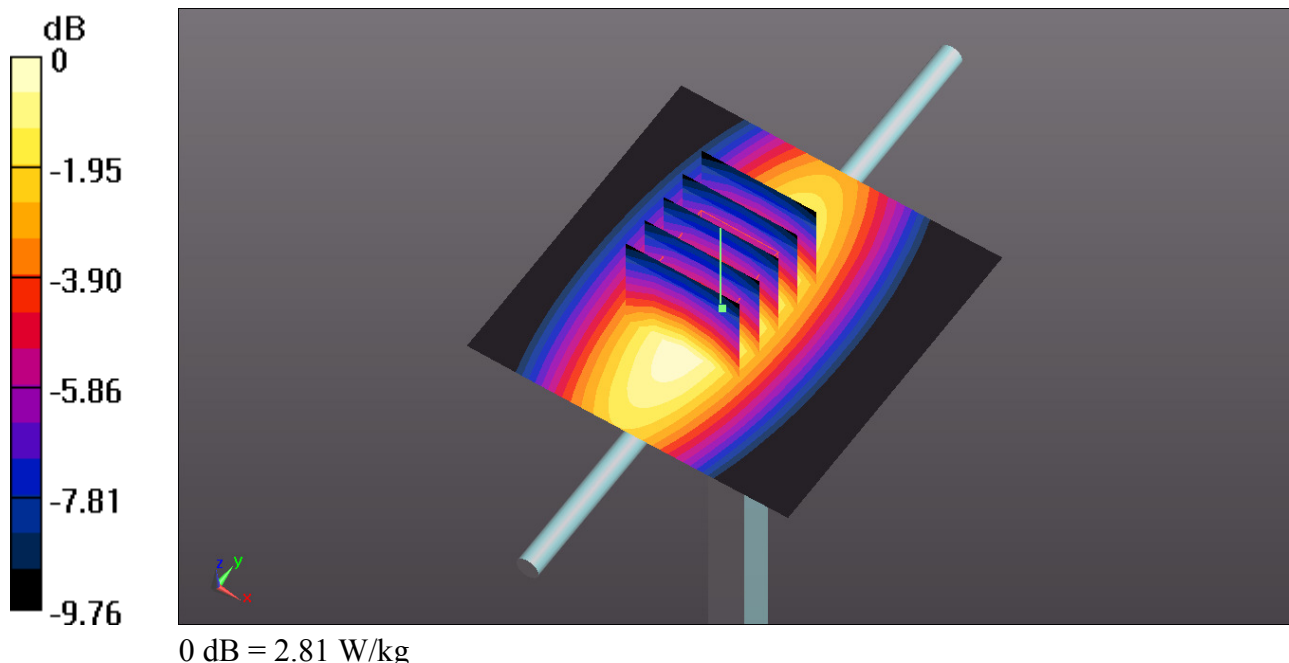

System Check_Body_835MHz_151225

DUT: Dipole 835 MHz

Communication System: UID 0, CW; Frequency: 835 MHz; Duty Cycle: 1:1

Medium: MSL_835_151225 Medium parameters used: $f = 835 \text{ MHz}$; $\sigma = 1 \text{ S/m}$; $\epsilon_r = 54.086$; $\rho = 1000 \text{ kg/m}^3$

Ambient Temperature : 23.6 °C; Liquid Temperature : 22.5 °C

DASY5 Configuration:

- Probe: EX3DV4 - SN3819; ConvF(9.47, 9.47, 9.47); Calibrated: 2015.11.27;
- Sensor-Surface: 2mm (Mechanical Surface Detection)
- Electronics: DAE4 Sn1303; Calibrated: 2015.11.24
- Phantom: SAM3; Type: QDOVA002AA; Serial: TP:1149
- Measurement SW: DASY52, Version 52.8 (8); SEMCAD X Version 14.6.10 (7331)

Pin=250mW/Area Scan (61x61x1): Interpolated grid: dx=15mm, dy=15mm

Maximum value of SAR (interpolated) = 2.61 W/kg

Pin=250mW/Zoom Scan (5x5x7)/Cube 0: Measurement grid: dx=8mm, dy=8mm, dz=5mm

Reference Value = 51.47 V/m; Power Drift = -0.12 dB

Peak SAR (extrapolated) = 3.48 W/kg

SAR(1 g) = 2.39 W/kg; SAR(10 g) = 1.58 W/kg

Maximum value of SAR (measured) = 2.57 W/kg

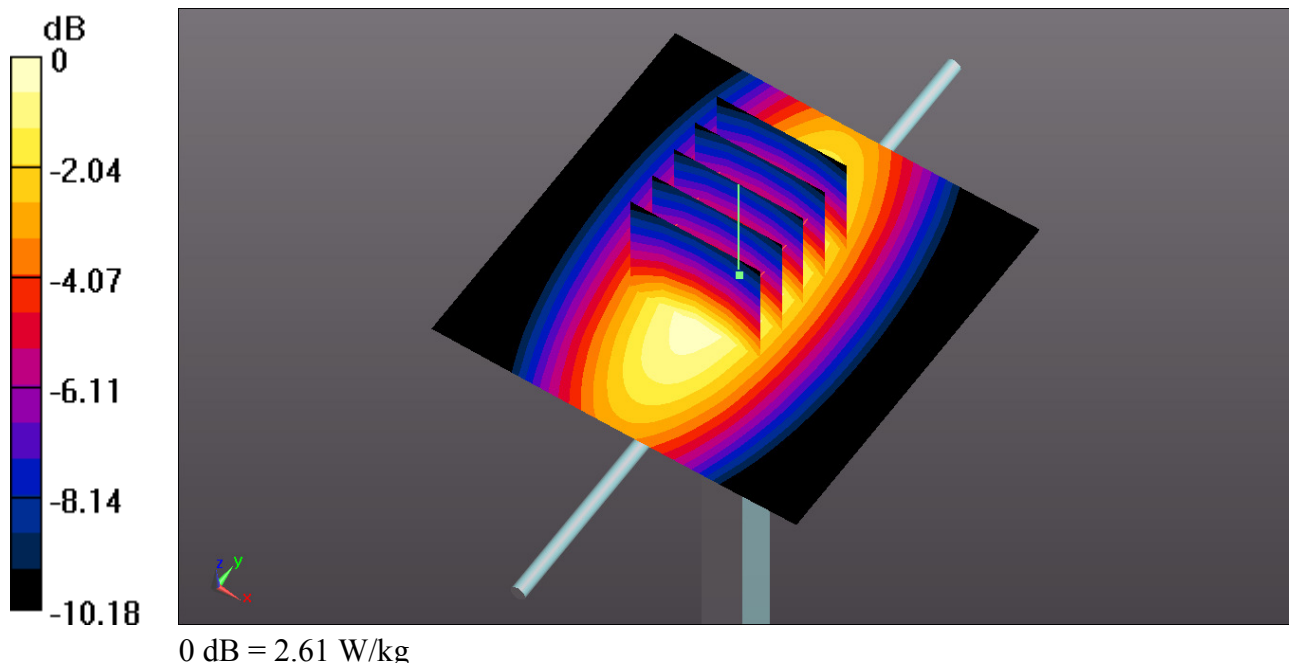

System Check_Body_1750MHz_151224

DUT: Dipole 1750 MHz

Communication System: UID 0, CW; Frequency: 1750 MHz; Duty Cycle: 1:1

Medium: MSL_1800_151224 Medium parameters used: $f = 1750$ MHz; $\sigma = 1.514$ S/m; $\epsilon_r = 53.575$; $\rho = 1000$ kg/m³

Ambient Temperature : 23.4 °C; Liquid Temperature : 22.6 °C

DASY5 Configuration:

- Probe: EX3DV4 - SN3819; ConvF(7.71, 7.71, 7.71); Calibrated: 2015.11.27;
- Sensor-Surface: 2mm (Mechanical Surface Detection)
- Electronics: DAE4 Sn1303; Calibrated: 2015.11.24
- Phantom: SAM3; Type: QDOVA002AA; Serial: TP:1149
- Measurement SW: DASY52, Version 52.8 (8); SEMCAD X Version 14.6.10 (7331)

Pin=250mW/Area Scan (61x61x1): Interpolated grid: dx=15mm, dy=15mm

Maximum value of SAR (interpolated) = 12.9 W/kg

Pin=250mW/Zoom Scan (5x5x7)/Cube 0: Measurement grid: dx=8mm, dy=8mm, dz=5mm

Reference Value = 94.70 V/m; Power Drift = 0.03 dB

Peak SAR (extrapolated) = 16.0 W/kg

SAR(1 g) = 9.17 W/kg; SAR(10 g) = 4.9 W/kg

Maximum value of SAR (measured) = 12.8 W/kg

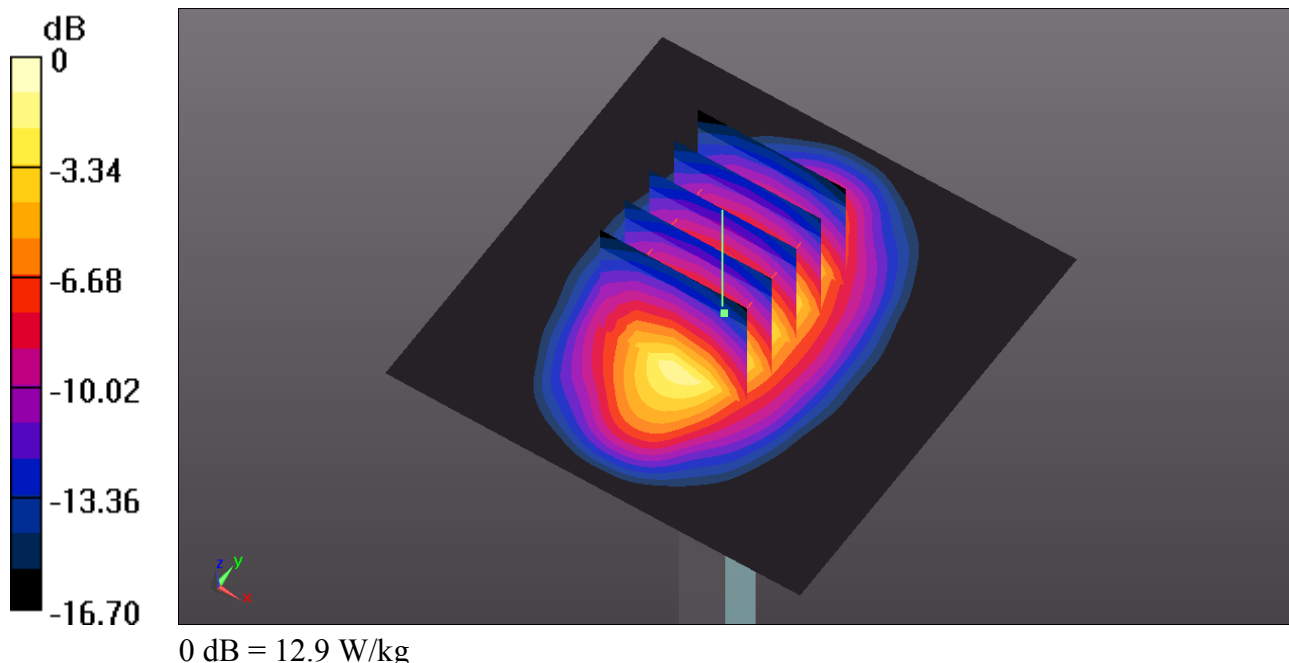

System Check_Body_1900MHz_151224

DUT: D1900V2

Communication System: UID 0, CW; Frequency: 1900 MHz; Duty Cycle: 1:1

Medium: MSL_1900_151224 Medium parameters used: $f = 1900$ MHz; $\sigma = 1.525$ S/m; $\epsilon_r = 54.504$; $\rho = 1000$ kg/m³

Ambient Temperature : 23.5 °C; Liquid Temperature : 22.7 °C

DASY5 Configuration:

- Probe: EX3DV4 - SN3819; ConvF(7.39, 7.39, 7.39); Calibrated: 2015.11.27;
- Sensor-Surface: 2mm (Mechanical Surface Detection)
- Electronics: DAE4 Sn1303; Calibrated: 2015.11.24
- Phantom: SAM3; Type: QDOVA002AA; Serial: TP:1149
- Measurement SW: DASY52, Version 52.8 (8); SEMCAD X Version 14.6.10 (7331)

Pin=250mW/Area Scan (61x61x1): Interpolated grid: dx=15mm, dy=15mm

Maximum value of SAR (interpolated) = 14.2 W/kg

Pin=250mW/Zoom Scan (5x5x7)/Cube 0: Measurement grid: dx=8mm, dy=8mm, dz=5mm

Reference Value = 85.32 V/m; Power Drift = 0.06 dB

Peak SAR (extrapolated) = 18.0 W/kg

SAR(1 g) = 9.97 W/kg; SAR(10 g) = 5.14 W/kg

Maximum value of SAR (measured) = 14.3 W/kg

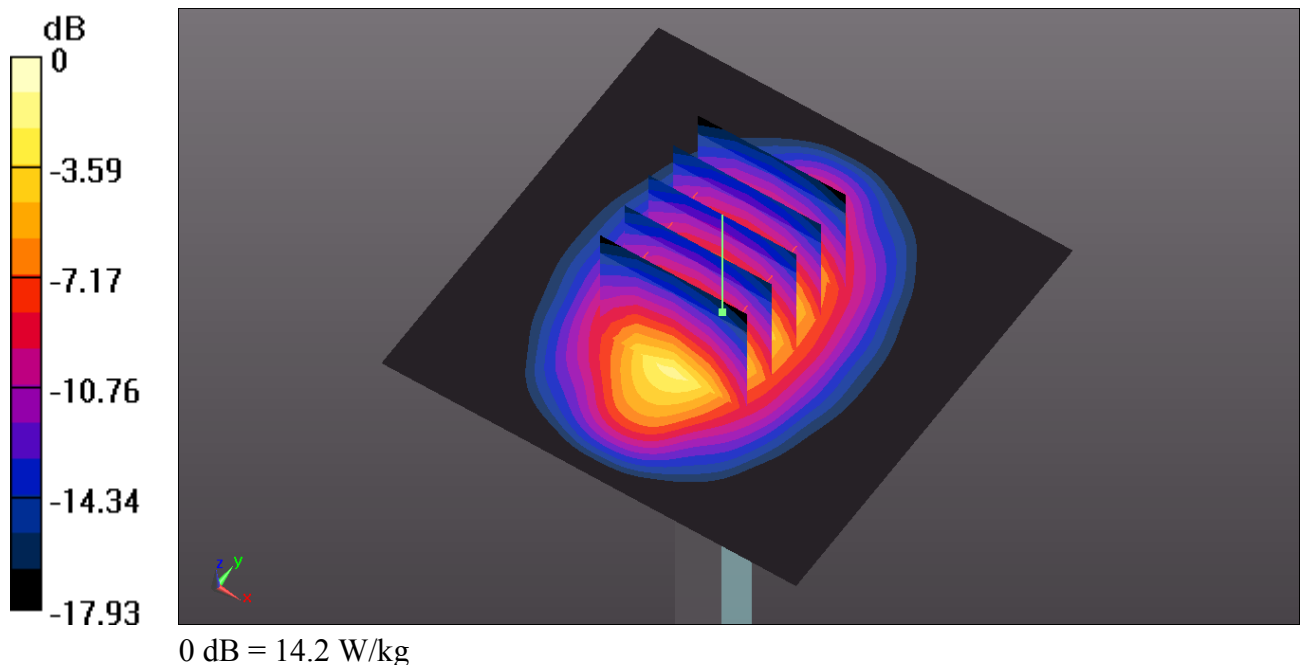

System Check_Body_2450MHz_160104

DUT: Dipole 2450 MHz

Communication System: UID 0, CW; Frequency: 2450 MHz; Duty Cycle: 1:1

Medium: MSL_2450_160104 Medium parameters used: $f = 2450$ MHz; $\sigma = 1.949$ S/m; $\epsilon_r = 51.667$; $\rho = 1000$ kg/m³

Ambient Temperature : 23.4 °C; Liquid Temperature : 22.8 °C

DASY5 Configuration:

- Probe: EX3DV4 - SN3819; ConvF(7.08, 7.08, 7.08); Calibrated: 2015.11.27;
- Sensor-Surface: 2mm (Mechanical Surface Detection)
- Electronics: DAE4 Sn1303; Calibrated: 2015.11.24
- Phantom: SAM3; Type: QDOVA002AA; Serial: TP:1149
- Measurement SW: DASY52, Version 52.8 (8); SEMCAD X Version 14.6.10 (7331)

Pin=250mW/Area Scan (81x81x1): Interpolated grid: dx=12mm, dy=12mm

Maximum value of SAR (interpolated) = 21.7 W/kg

Pin=250mW/Zoom Scan (7x7x7)/Cube 0: Measurement grid: dx=5mm, dy=5mm, dz=5mm

Reference Value = 91.30 V/m; Power Drift = 0.05 dB

Peak SAR (extrapolated) = 28.9 W/kg

SAR(1 g) = 13.7 W/kg; SAR(10 g) = 6.02 W/kg

Maximum value of SAR (measured) = 22.1 W/kg

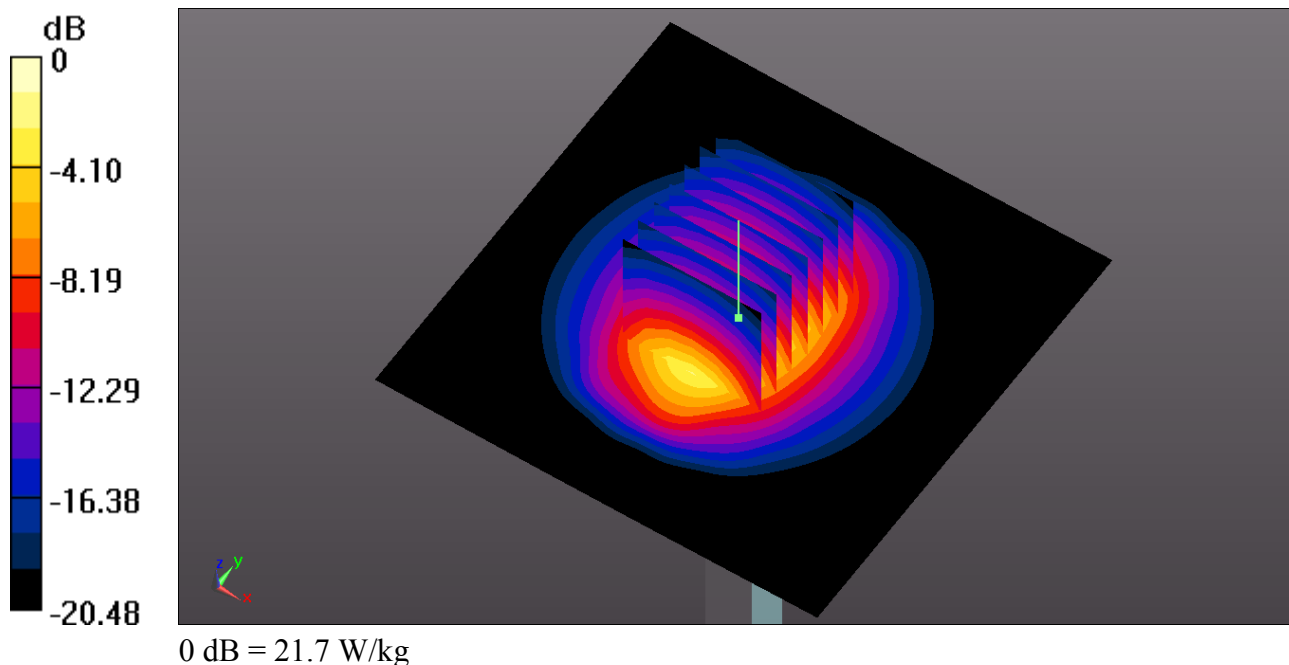



Appendix B. Plots of High SAR Measurement

The plots are shown as follows.

1_WCDMA V_RMC 12.2Kbps_Front_0mm_Ch4132

Communication System: UID 0, UMTS (0); Frequency: 826.4 MHz; Duty Cycle: 1:1
 Medium: MSL_835_151225 Medium parameters used: $f = 826.4$ MHz; $\sigma = 0.99$ S/m; $\epsilon_r = 54.181$; $\rho = 1000$ kg/m³
 Ambient Temperature : 23.6 °C; Liquid Temperature : 22.5 °C

DASY5 Configuration:

- Probe: EX3DV4 - SN3819; ConvF(9.47, 9.47, 9.47); Calibrated: 2015.11.27;
- Sensor-Surface: 2mm (Mechanical Surface Detection)
- Electronics: DAE4 Sn1303; Calibrated: 2015.11.24
- Phantom: SAM3; Type: QDOVA002AA; Serial: TP:1149
- Measurement SW: DASY52, Version 52.8 (8); SEMCAD X Version 14.6.10 (7331)

Ch4132/Area Scan (81x131x1): Interpolated grid: dx=15mm, dy=15mm
 Maximum value of SAR (interpolated) = 0.895 W/kg

Ch4132/Zoom Scan (5x5x7)/Cube 0: Measurement grid: dx=8mm, dy=8mm, dz=5mm
 Reference Value = 3.030 V/m; Power Drift = -0.05 dB
 Peak SAR (extrapolated) = 1.10 W/kg
SAR(1 g) = 0.674 W/kg; SAR(10 g) = 0.416 W/kg
 Maximum value of SAR (measured) = 0.892 W/kg

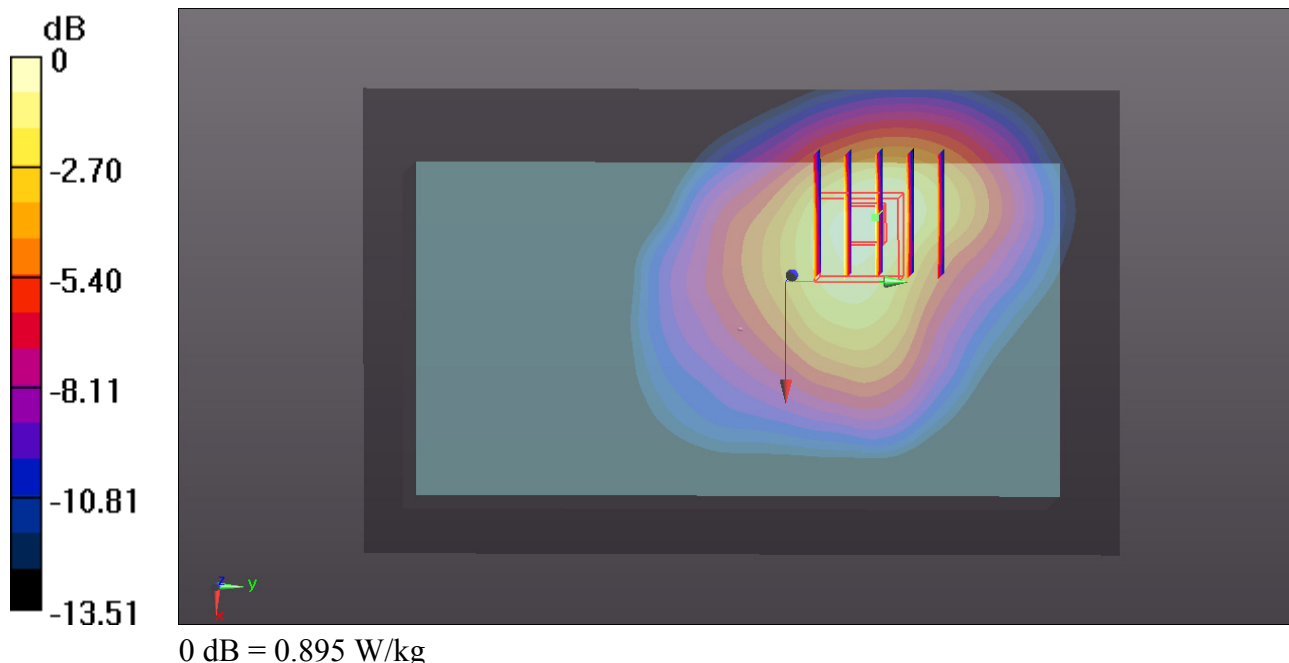

2_WCDMA IV_RMC 12.2Kbps_Front_0mm_Ch1413

Communication System: UID 0, UMTS (0); Frequency: 1732.6 MHz; Duty Cycle: 1:1
Medium: MSL_1800_151224 Medium parameters used: $f = 1732.6$ MHz; $\sigma = 1.496$ S/m; $\epsilon_r = 53.644$;
 $\rho = 1000$ kg/m³

Ambient Temperature : 23.4 °C; Liquid Temperature : 22.6 °C

DASY5 Configuration:

- Probe: EX3DV4 - SN3819; ConvF(7.71, 7.71, 7.71); Calibrated: 2015.11.27;
- Sensor-Surface: 2mm (Mechanical Surface Detection)
- Electronics: DAE4 Sn1303; Calibrated: 2015.11.24
- Phantom: SAM3; Type: QDOVA002AA; Serial: TP:1149
- Measurement SW: DASY52, Version 52.8 (8); SEMCAD X Version 14.6.10 (7331)

Ch1413/Area Scan (81x131x1): Interpolated grid: dx=15mm, dy=15mm

Maximum value of SAR (interpolated) = 0.655 W/kg

Ch1413/Zoom Scan (5x5x7)/Cube 0: Measurement grid: dx=8mm, dy=8mm, dz=5mm

Reference Value = 2.367 V/m; Power Drift = -0.07 dB

Peak SAR (extrapolated) = 1.01 W/kg

SAR(1 g) = 0.576 W/kg; SAR(10 g) = 0.314 W/kg

Maximum value of SAR (measured) = 0.735 W/kg

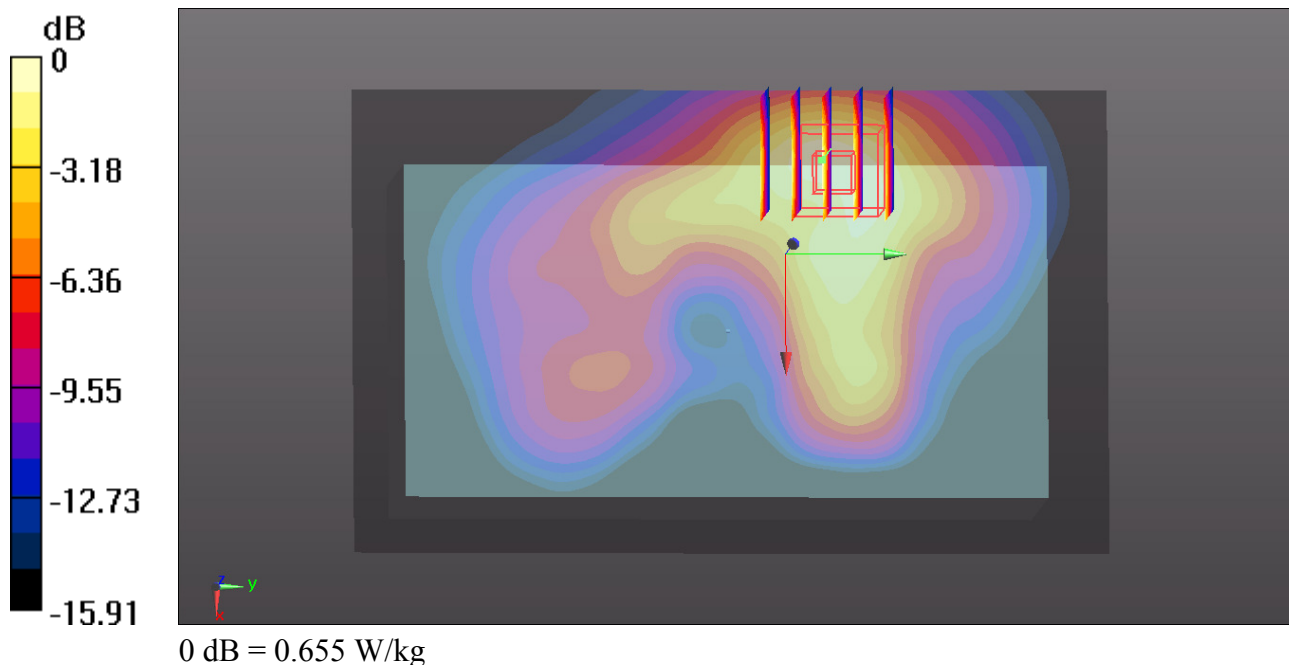

3_WCDMA II_RMC 12.2Kbps_Front_0mm_Ch9538

Communication System: UID 0, UMTS (0); Frequency: 1907.6 MHz; Duty Cycle: 1:1
 Medium: MSL_1900_151224 Medium parameters used: $f = 1907.6$ MHz; $\sigma = 1.532$ S/m; $\epsilon_r = 54.489$;
 $\rho = 1000$ kg/m³

Ambient Temperature : 23.5 °C ; Liquid Temperature : 22.7 °C

DASY5 Configuration:

- Probe: EX3DV4 - SN3819; ConvF(7.39, 7.39, 7.39); Calibrated: 2015.11.27;
- Sensor-Surface: 2mm (Mechanical Surface Detection)
- Electronics: DAE4 Sn1303; Calibrated: 2015.11.24
- Phantom: SAM3; Type: QDOVA002AA; Serial: TP:1149
- Measurement SW: DASY52, Version 52.8 (8); SEMCAD X Version 14.6.10 (7331)

Ch9538/Area Scan (81x131x1): Interpolated grid: dx=15mm, dy=15mm

Maximum value of SAR (interpolated) = 0.575 W/kg

Ch9538/Zoom Scan (5x5x7)/Cube 0: Measurement grid: dx=8mm, dy=8mm, dz=5mm

Reference Value = 3.130 V/m; Power Drift = -0.06 dB

Peak SAR (extrapolated) = 0.696 W/kg

SAR(1 g) = 0.463 W/kg; SAR(10 g) = 0.275 W/kg

Maximum value of SAR (measured) = 0.577 W/kg

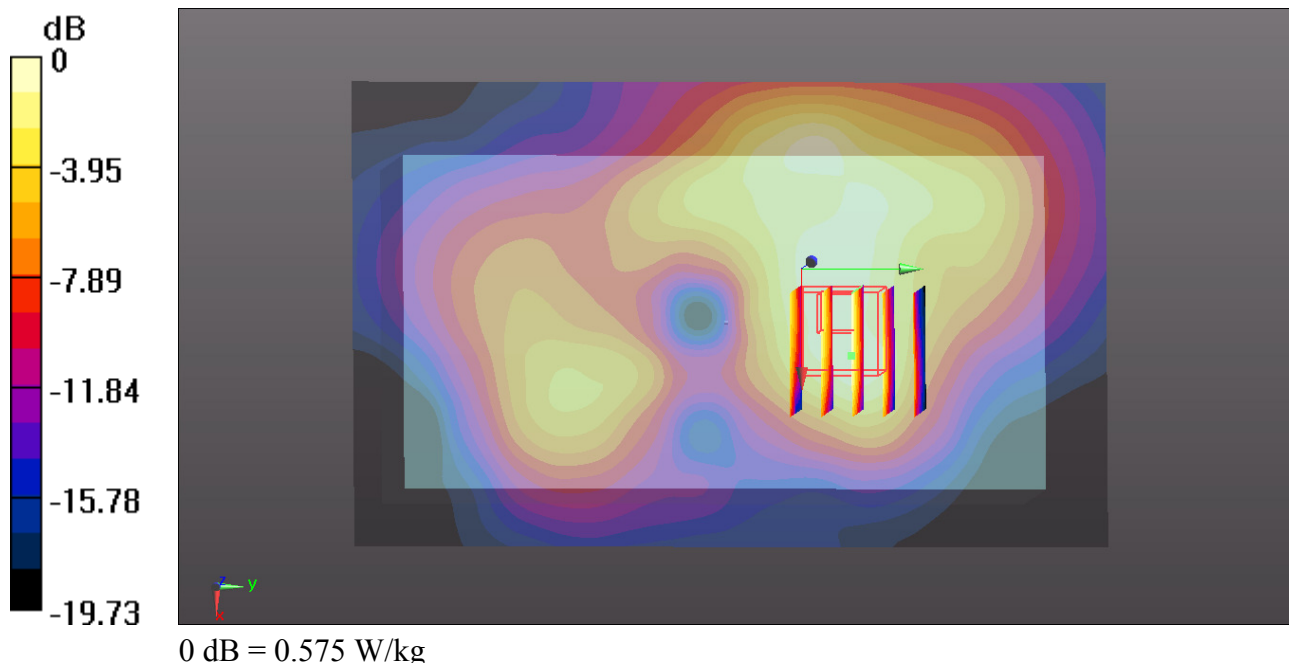

4_LTE Band 17_10M_QPSK_1RB_25Offset_Front_0mm_Ch23790

Communication System: UID 0, LTE (0); Frequency: 710 MHz; Duty Cycle: 1:1
 Medium: MSL_750_151225 Medium parameters used: $f = 710 \text{ MHz}$; $\sigma = 0.934 \text{ S/m}$; $\epsilon_r = 54.822$; $\rho = 1000 \text{ kg/m}^3$
 Ambient Temperature : $23.3 \text{ }^\circ\text{C}$; Liquid Temperature : $22.5 \text{ }^\circ\text{C}$

DASY5 Configuration:

- Probe: EX3DV4 - SN3819; ConvF(9.69, 9.69, 9.69); Calibrated: 2015.11.27;
- Sensor-Surface: 2mm (Mechanical Surface Detection)
- Electronics: DAE4 Sn1303; Calibrated: 2015.11.24
- Phantom: SAM3; Type: QDOVA002AA; Serial: TP:1149
- Measurement SW: DASY52, Version 52.8 (8); SEMCAD X Version 14.6.10 (7331)

Ch23790/Area Scan (81x131x1): Interpolated grid: $dx=15\text{mm}$, $dy=15\text{mm}$
 Maximum value of SAR (interpolated) = 0.680 W/kg

Ch23790/Zoom Scan (5x5x7)/Cube 0: Measurement grid: $dx=8\text{mm}$, $dy=8\text{mm}$, $dz=5\text{mm}$
 Reference Value = 2.610 V/m ; Power Drift = 0.16 dB
 Peak SAR (extrapolated) = 0.810 W/kg
SAR(1 g) = 0.537 W/kg ; SAR(10 g) = 0.358 W/kg
 Maximum value of SAR (measured) = 0.668 W/kg

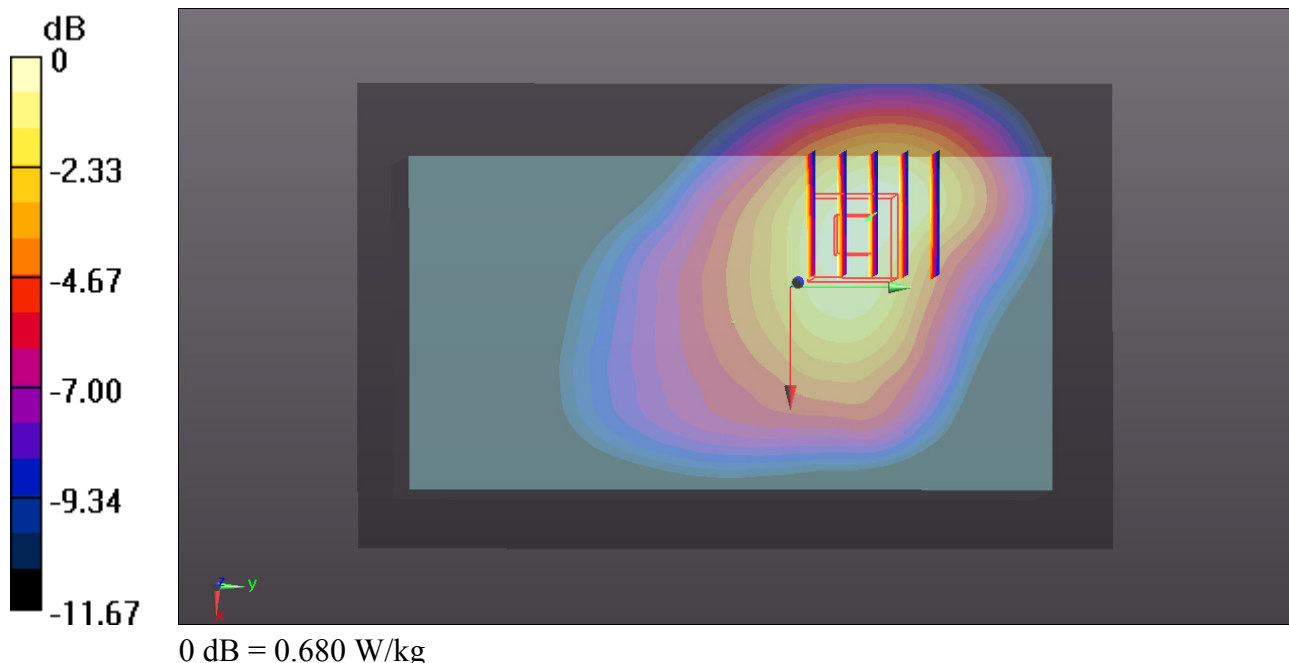

5_LTE Band 5_10M_QPSK_1RB_25Offset_Front_0mm_Ch20525

Communication System: UID 0, LTE (0); Frequency: 836.5 MHz; Duty Cycle: 1:1

Medium: MSL_835_151225 Medium parameters used: $f = 836.5$ MHz; $\sigma = 1.002$ S/m; $\epsilon_r = 54.071$; $\rho = 1000$ kg/m³

Ambient Temperature : 23.6 °C; Liquid Temperature : 22.5 °C

DASY5 Configuration:

- Probe: EX3DV4 - SN3819; ConvF(9.47, 9.47, 9.47); Calibrated: 2015.11.27;
- Sensor-Surface: 2mm (Mechanical Surface Detection)
- Electronics: DAE4 Sn1303; Calibrated: 2015.11.24
- Phantom: SAM3; Type: QDOVA002AA; Serial: TP:1149
- Measurement SW: DASY52, Version 52.8 (8); SEMCAD X Version 14.6.10 (7331)

Ch20525/Area Scan (81x131x1): Interpolated grid: dx=15mm, dy=15mm

Maximum value of SAR (interpolated) = 0.813 W/kg

Ch20525/Zoom Scan (5x5x7)/Cube 0: Measurement grid: dx=8mm, dy=8mm, dz=5mm

Reference Value = 2.941 V/m; Power Drift = -0.04 dB

Peak SAR (extrapolated) = 0.996 W/kg

SAR(1 g) = 0.613 W/kg; SAR(10 g) = 0.379 W/kg

Maximum value of SAR (measured) = 0.810 W/kg

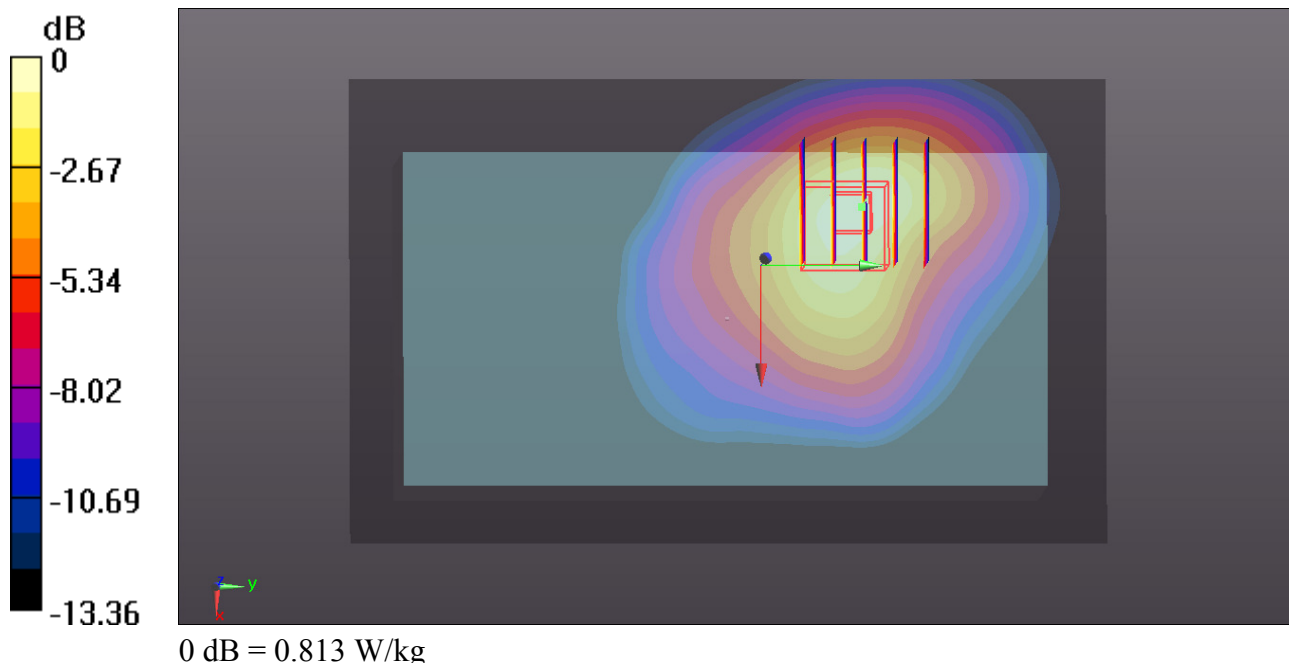

6_LTE Band 4_20M_QPSK_1RB_49Offset_Front_0mm_Ch20175

Communication System: UID 0, LTE (0); Frequency: 1732.5 MHz; Duty Cycle: 1:1
 Medium: MSL_1800_151224 Medium parameters used: $f = 1732.5$ MHz; $\sigma = 1.496$ S/m; $\epsilon_r = 53.649$;
 $\rho = 1000$ kg/m³
 Ambient Temperature : 23.4 °C; Liquid Temperature : 22.6 °C

DASY5 Configuration:

- Probe: EX3DV4 - SN3819; ConvF(7.71, 7.71, 7.71); Calibrated: 2015.11.27;
- Sensor-Surface: 2mm (Mechanical Surface Detection)
- Electronics: DAE4 Sn1303; Calibrated: 2015.11.24
- Phantom: SAM3; Type: QDOVA002AA; Serial: TP:1149
- Measurement SW: DASY52, Version 52.8 (8); SEMCAD X Version 14.6.10 (7331)

Ch20175/Area Scan (81x131x1): Interpolated grid: dx=15mm, dy=15mm

Maximum value of SAR (interpolated) = 0.623 W/kg

Ch20175/Zoom Scan (5x5x7)/Cube 0: Measurement grid: dx=8mm, dy=8mm, dz=5mm

Reference Value = 2.227 V/m; Power Drift = -0.15 dB

Peak SAR (extrapolated) = 0.951 W/kg

SAR(1 g) = 0.539 W/kg; SAR(10 g) = 0.295 W/kg

Maximum value of SAR (measured) = 0.712 W/kg

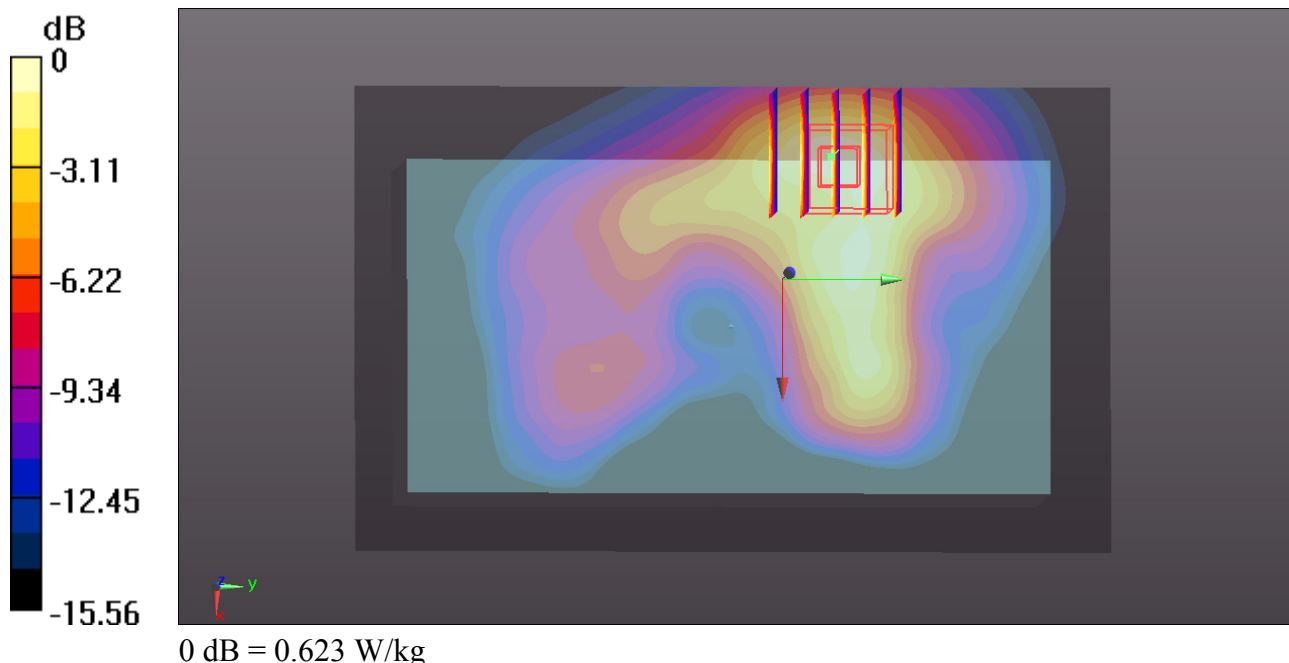

7_LTE Band 2_20M_QPSK_1RB_49Offset_Front_0mm_Ch19100

Communication System: UID 0, LTE (0); Frequency: 1900 MHz; Duty Cycle: 1:1
Medium: MSL_1900_151224 Medium parameters used: $f = 1900$ MHz; $\sigma = 1.525$ S/m; $\epsilon_r = 54.504$; $\rho = 1000$ kg/m³
Ambient Temperature : 23.5 °C; Liquid Temperature : 22.7 °C

DASY5 Configuration:

- Probe: EX3DV4 - SN3819; ConvF(7.39, 7.39, 7.39); Calibrated: 2015.11.27;
- Sensor-Surface: 2mm (Mechanical Surface Detection)
- Electronics: DAE4 Sn1303; Calibrated: 2015.11.24
- Phantom: SAM3; Type: QDOVA002AA; Serial: TP:1149
- Measurement SW: DASY52, Version 52.8 (8); SEMCAD X Version 14.6.10 (7331)

Ch19100/Area Scan (81x131x1): Interpolated grid: dx=15mm, dy=15mm

Maximum value of SAR (interpolated) = 0.546 W/kg

Ch19100/Zoom Scan (5x5x7)/Cube 0: Measurement grid: dx=8mm, dy=8mm, dz=5mm

Reference Value = 3.129 V/m; Power Drift = 0.11 dB

Peak SAR (extrapolated) = 0.614 W/kg

SAR(1 g) = 0.408 W/kg; SAR(10 g) = 0.250 W/kg

Maximum value of SAR (measured) = 0.514 W/kg

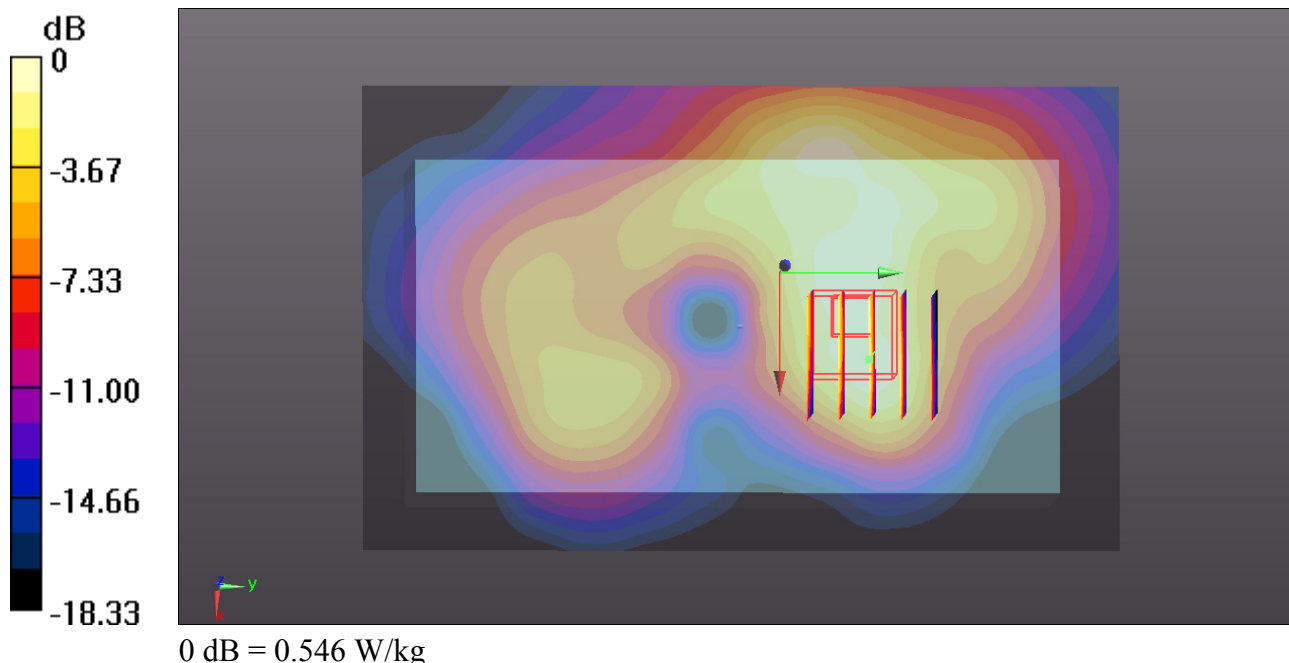

8_WLAN2.4GHz_802.11b 1Mbps_Back_0mm_Ch1

Communication System: UID 0, WIFI (0); Frequency: 2412 MHz; Duty Cycle: 1:1.025
 Medium: MSL_2450_160104 Medium parameters used: $f = 2412 \text{ MHz}$; $\sigma = 1.899 \text{ S/m}$; $\epsilon_r = 51.803$; $\rho = 1000 \text{ kg/m}^3$
 Ambient Temperature : 23.4 °C; Liquid Temperature : 22.8 °C

DASY5 Configuration:

- Probe: EX3DV4 - SN3819; ConvF(7.08, 7.08, 7.08); Calibrated: 2015.11.27;
- Sensor-Surface: 2mm (Mechanical Surface Detection)
- Electronics: DAE4 Sn1303; Calibrated: 2015.11.24
- Phantom: SAM3; Type: QDOVA002AA; Serial: TP:1149
- Measurement SW: DASY52, Version 52.8 (8); SEMCAD X Version 14.6.10 (7331)

Ch1/Area Scan (101x161x1): Interpolated grid: $dx=12\text{mm}$, $dy=12\text{mm}$
 Maximum value of SAR (interpolated) = 0.533 W/kg

Ch1/Zoom Scan (7x7x7)/Cube 0: Measurement grid: $dx=5\text{mm}$, $dy=5\text{mm}$, $dz=5\text{mm}$
 Reference Value = 1.041 V/m; Power Drift = -0.08 dB
 Peak SAR (extrapolated) = 0.707 W/kg
SAR(1 g) = 0.378 W/kg; SAR(10 g) = 0.194 W/kg
 Maximum value of SAR (measured) = 0.542 W/kg

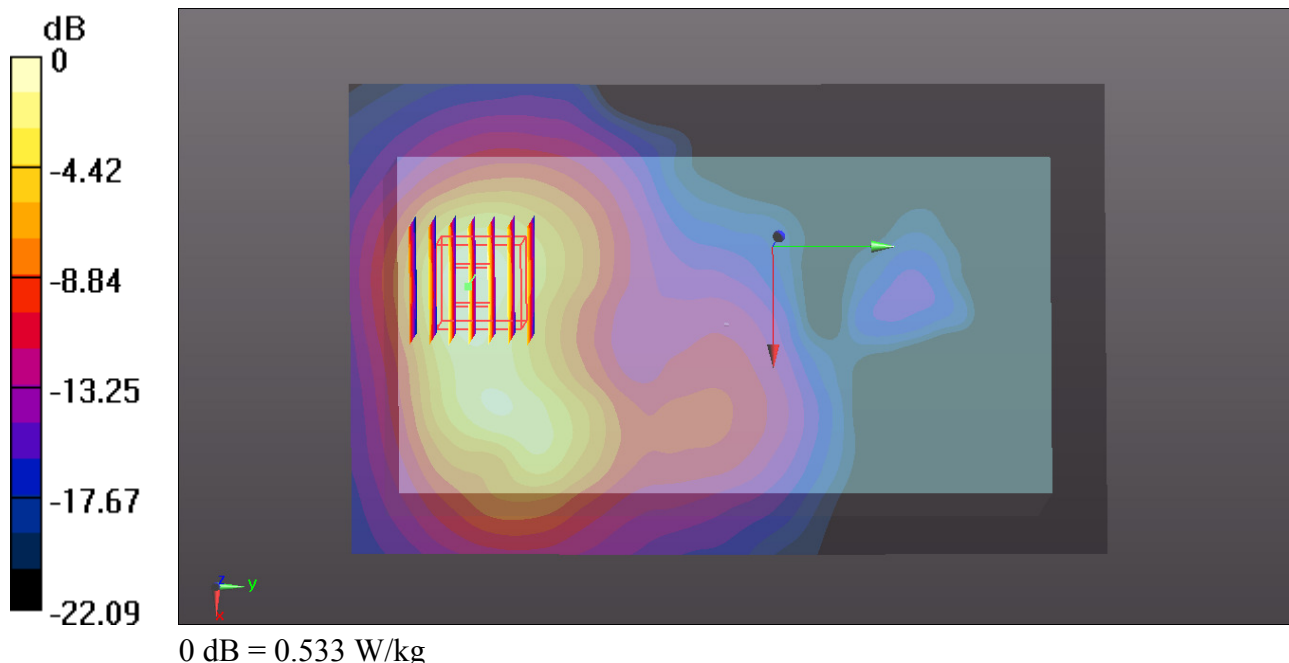

9_Bluetooth_DH5_Back_0mm_Ch0

Communication System: UID 0, Bluetooth (0); Frequency: 2402 MHz; Duty Cycle: 1:1.2
 Medium: MSL_2450_160104 Medium parameters used: $f = 2402$ MHz; $\sigma = 1.885$ S/m; $\epsilon_r = 51.834$; $\rho = 1000$ kg/m³
 Ambient Temperature : 23.4 °C; Liquid Temperature : 22.8 °C

DASY5 Configuration:

- Probe: EX3DV4 - SN3819; ConvF(7.08, 7.08, 7.08); Calibrated: 2015.11.27;
- Sensor-Surface: 2mm (Mechanical Surface Detection)
- Electronics: DAE4 Sn1303; Calibrated: 2015.11.24
- Phantom: SAM3; Type: QDOVA002AA; Serial: TP:1149
- Measurement SW: DASY52, Version 52.8 (8); SEMCAD X Version 14.6.10 (7331)

Ch0/Area Scan (101x161x1): Interpolated grid: dx=12mm, dy=12mm
 Maximum value of SAR (interpolated) = 0.0883 W/kg

Ch0/Zoom Scan (7x7x7)/Cube 0: Measurement grid: dx=5mm, dy=5mm, dz=5mm
 Reference Value = 0.5490 V/m; Power Drift = 0.06 dB
 Peak SAR (extrapolated) = 0.113 W/kg
SAR(1 g) = 0.060 W/kg; SAR(10 g) = 0.031 W/kg
 Maximum value of SAR (measured) = 0.0862 W/kg

