



# FCC RF Test Report

**APPLICANT** : PAX Technology Limited  
**EQUIPMENT** : Mobile payment terminal  
**BRAND NAME** : PAX  
**MODEL NAME** : S920  
**MARKETING NAME** : S920  
**FCC ID** : V5PS920  
**STANDARD** : FCC Part 15 Subpart C §15.225  
**CLASSIFICATION** : (DXX) Low Power Communication Device Transmitter

The product was received on Apr. 23, 2015 and testing was completed on May 28, 2015. We, SPORTON INTERNATIONAL (SHENZHEN) INC., would like to declare that the tested sample has been evaluated in accordance with the test procedures and has been in compliance with the applicable technical standards.

The test results in this report apply exclusively to the tested model / sample. Without written approval of SPORTON INTERNATIONAL (SHENZHEN) INC., the test report shall not be reproduced except in full.

Reviewed by: Joseph Lin / Supervisor

Approved by: Jones Tsai / Manager



**SPORTON INTERNATIONAL (SHENZHEN) INC.**

**1F & 2F, Building A, Morning Business Center, No. 4003 ShiGu Rd., Xili Town,  
Nanshan District, Shenzhen, Guangdong, P. R. China**



Table of Contents

SUMMARY OF THE TEST RESULT .....4
1. GENERAL INFORMATION.....5
1.1 Applicant .....5
1.2 Manufacturer.....5
1.3 Product Details .....5
1.4 Modification of EUT.....6
1.5 Testing Location .....6
1.6 Applicable Standards .....7
1.7 Test Modes .....7
1.8 Test Configurations .....8
1.9 Table for Supporting Units .....9
2. CONDUCTED EMISSION TEST .....10
2.1 Measuring Instruments .....10
2.2 Test setup .....10
2.3 Test Result of Conducted Emission Test.....10
2.4 AC Power Line Conducted Emissions Measurement .....11
3. CONDUCTED TEST ITEMS .....12
3.1 Measuring Instruments .....12
3.2 Test Setup .....12
3.3 Test Result of Conducted Test Items.....12
3.4 20dB Spectrum Bandwidth Measurement .....13
3.5 Frequency Stability Measurement .....13
4. RADIATED TEST ITEMS .....14
4.1 Measuring Instruments .....14
4.2 Test Setup .....14
4.3 Test Result of Radiated Test Items .....14
4.4 Field Strength of Fundamental Emissions and Mask Measurement .....15
4.5 Radiated Emissions Measurement .....16
5. LIST OF MEASURING EQUIPMENT .....18
APPENDIX A. SETUP PHOTOGRAPHS OF EUT
APPENDIX B. TEST RESULTS OF CONDUCTED EMISSION TEST
APPENDIX C. TEST RESULTS OF CONDUCTED TEST ITEMS
C.1. Test Result of 20dB Spectrum Bandwidth
C.2 Test Result of Frequency Stability
APPENDIX D. TEST RESULTS OF RADIATED TEST ITEMS
D.1 Test Result of Field Strength of Fundamental Emissions
D.2 Results of Radiated Emissions (9 kHz~30MHz)
D.3 Results of Radiated Emissions (30MHz~1GHz)



### REVISION HISTORY

REPORT NO.	VERSION	DESCRIPTION	ISSUED DATE
FR542305D	Rev. 01	Initial issue of report	Jul. 07, 2015



### SUMMARY OF THE TEST RESULT

Applied Standard: 47 CFR FCC Part 15 Subpart C				
Part	FCC Rule	Description of Test	Result	Under Limit
3.1	15.207	AC Power Line Conducted Emissions	Complies	9.76 dB at 0.180MHz
3.2	15.225(a)(b)(c)	Field Strength of Fundamental Emissions	Complies	71.19 dB at 13.560 MHz
3.3	2.1049	20dB Spectrum Bandwidth	Complies	-
3.4	15.225(d) 15.209	Radiated Emissions	Complies	5.45 dB at 56.190 MHz
3.5	15.225(e)	Frequency Stability	Complies	-
3.6	15.203	Antenna Requirements	Complies	-

Test Items	Uncertainty	Remark
AC Power Line Conducted Emissions	2.3 dB	Confidence levels of 95%
Radiated Emissions (30MHz~1000MHz)	3.9 dB	Confidence levels of 95%



## 1. GENERAL INFORMATION

### 1.1 Applicant

**PAX Technology Limited**

Room 2416, 24/F., Sun Hung Kai Centre, 30 Harbour Road, Wanchai, Hong Kong

### 1.2 Manufacturer

**PAX Computer Technology (Shenzhen) Co., Ltd.**

4/F, No.3 Building, Software Park, Second Central Science-Tech Road, High-Tech industrial Park, Shenzhen, Guangdong, P. R. C.

### 1.3 Product Details

Items	Description
Tx/Rx Frequency Range	13.553 ~ 13.567MHz
Channel Number	1
20dBW	2.68 kHz
99%OBW	2.24 kHz
Antenna Type	PCB Antenna
IMEI Code	Conducted: N/A Radiated: 354524043107383 Conduction: 354524043212084
Type of Modulation	ASK

**Remark:** The above EUT's information was declared by manufacturer. Please refer to the specifications or user's manual for more detailed description.



1.4 Modification of EUT

No modifications are made to the EUT during all test items.

1.5 Testing Location

<b>Test Site</b>	SPORTON INTERNATIONAL (SHENZHEN) INC.	
<b>Test Site Location</b>	1F & 2F, Building A, Morning Business Center, No. 4003 ShiGu Rd., Xili Town, Nanshan District, Shenzhen, Guangdong, P. R. China TEL: +86-755-8637-9589 FAX: +86-755-8637-9595	
<b>Test Site No.</b>	<b>Sporton Site No.</b>	
	TH01-SZ	CO01-SZ
<b>Test Engineer</b>	Tiny You	Min Yang
<b>Temperature</b>	24~26°C	21~23°C
<b>Relative Humidity</b>	50~53%	41~43%

<b>Test Site</b>	SPORTON INTERNATIONAL (SHENZHEN) INC.	
<b>Test Site Location</b>	No. 3 Building, the third floor of south, Shahe River west, Fengzeyuan warehouse, Nanshan District, Shenzhen, Guangdong, P. R. China TEL: +86-755- 3320-2398	
<b>Test Site No.</b>	<b>Sporton Site No.</b>	<b>FCC Registration No.</b>
	03CH01-SZ	831040
<b>Test Engineer</b>	Jack Tian	
<b>Temperature</b>	23~25°C	
<b>Relative Humidity</b>	48~52%	

Note: The test site complies with ANSI C63.4 2009 requirement.



### 1.6 Applicable Standards

According to the specifications of the manufacturer, the EUT must comply with the requirements of the following standards:

- ♦ FCC Part 15 Subpart C §15.225
- ♦ ANSI C63.10-2013

### 1.7 Test Modes

Investigation has been done on all the possible configurations for searching the worst cases. The following table is a list of the test modes shown in this test report.

Test Items	
AC Power Line Conducted Emissions	Field Strength of Fundamental Emissions
20dB Spectrum Bandwidth	Frequency Stability
Radiated Emissions 9kHz~30MHz	Radiated Emissions 30MHz~1GHz
<b>Note:</b> 1. The EUT was programmed to be in continuously transmitting mode. 2. The ancillary equipment, NFC card, is used to make the EUT (NFC) continuously transmit at 13.56MHz and is placed around 3 cm gap to the EUT.	

## 1.8 Test Configurations

### <AC Conducted Emissions>

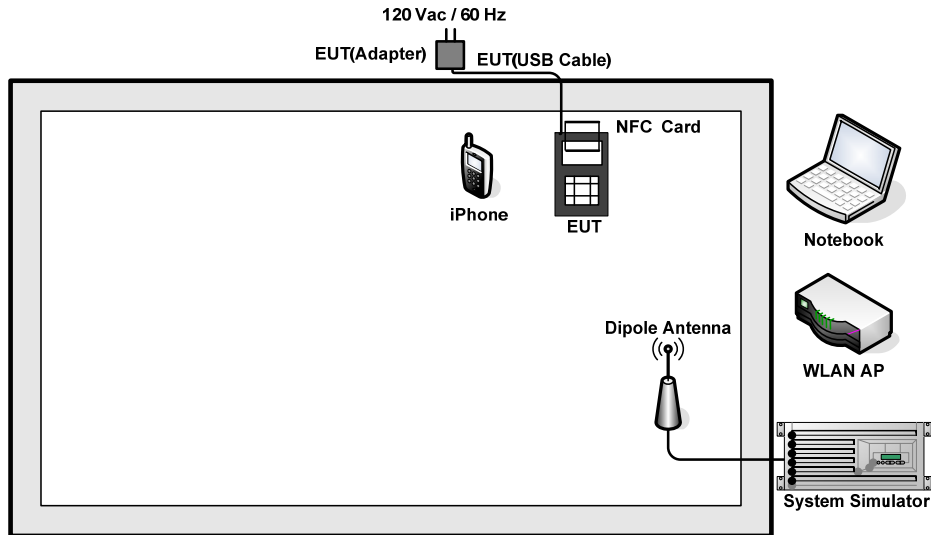

### <For Fundamental Emissions and Mask and Radiated Emissions Measurement>

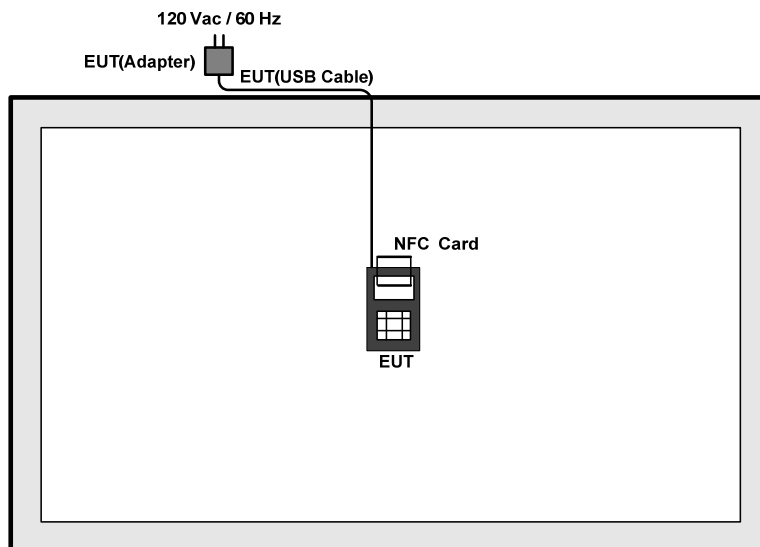





1.9 Table for Supporting Units

Support Unit	Manufacturer	Model	FCC ID
NFC Card	N/A	N/A	N/A
AC Source(AVR)	Chroma	61601	N/A
iPhone	Apple	N/A	N/A
WLAN AP	D-Link	DIR-628	KA2DIR628A2
Notebook	Lenovo	G480	PRC4
System Simulator	Anritsu	MT8820C	N/A

## 2. CONDUCTED EMISSION TEST

### 2.1 Measuring Instruments

See list of measuring instruments of this test report.

### 2.2 Test setup

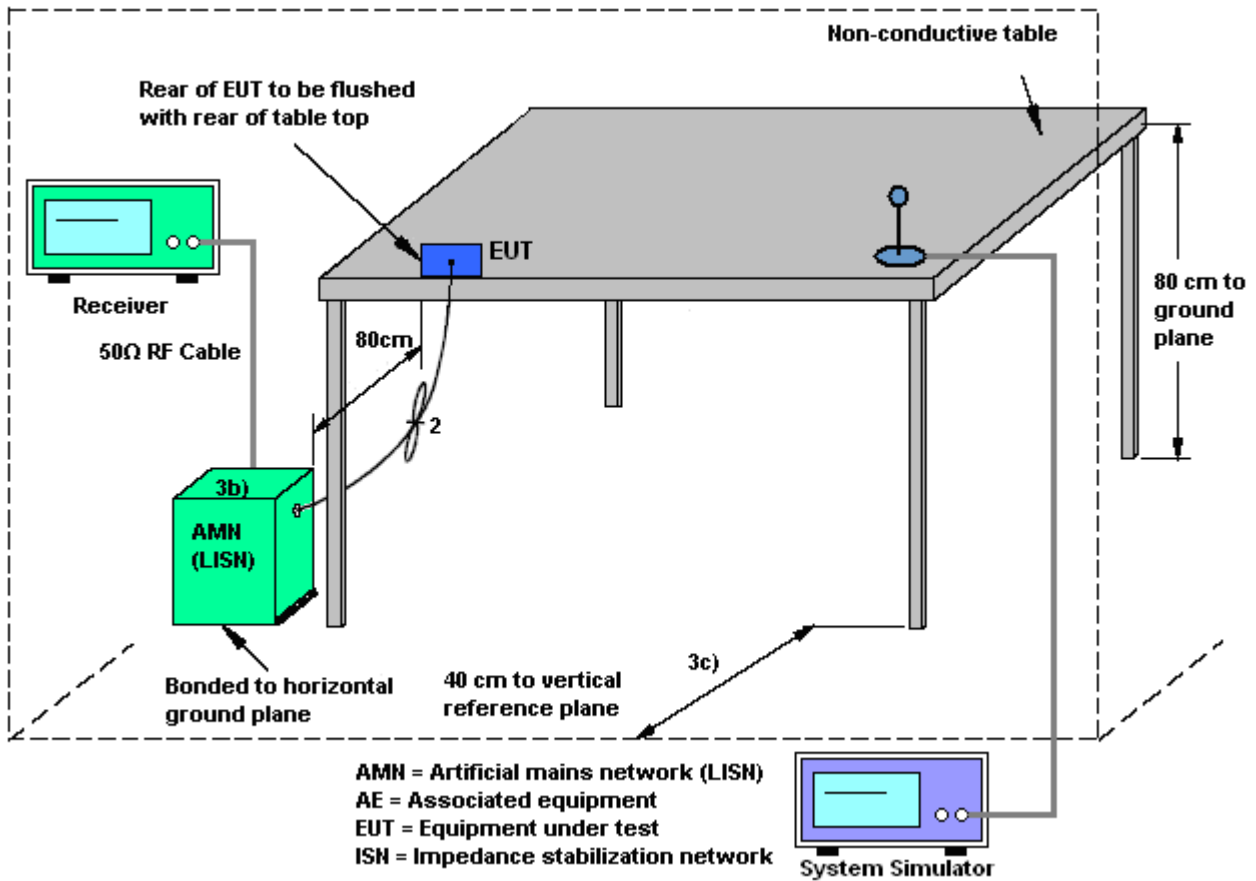

### 2.3 Test Result of Conducted Emission Test

Please refer to Appendix B.

## 2.4 AC Power Line Conducted Emissions Measurement

### 2.4.1 Limit

For equipment that is designed to be connected to the public utility (AC) power line, the radio frequency voltage that is conducted back onto the AC power line on any frequency or frequencies within the band 150 kHz to 30 MHz shall not exceed the limits in the following table.

Frequency of Emission (MHz)	Conducted Limit (dB $\mu$ V)	
	Quasi-Peak	Average
0.15-0.5	66 to 56*	56 to 46*
0.5-5	56	46
5-30	60	50

\*Decreases with the logarithm of the frequency.

### 2.4.2 Test Procedures

1. The EUT was placed 0.4 meter from the conducting wall of the shielding room, and it was kept at least 80 centimeters from any other grounded conducting surface.
2. Connect EUT to the power mains through a line impedance stabilization network (LISN).
3. All the support units are connecting to the other LISN.
4. The LISN provides 50 ohm coupling impedance for the measuring instrument.
5. The FCC states that a 50 ohm, 50 microhenry LISN should be used.
6. Both sides of AC line were checked for maximum conducted interference.
7. The frequency range from 150 kHz to 30 MHz was searched.
8. Set the test-receiver system to Peak Detect Function and specified bandwidth (IF Bandwidth = 9kHz) with Maximum Hold Mode. Then measurement is also conducted by Average Detector and Quasi-Peak Detector Function respectively.

### 3. CONDUCTED TEST ITEMS

#### 3.1 Measuring Instruments

See list of measuring instruments of this test report.

#### 3.2 Test Setup

##### 3.2.1 20dB Spectrum Bandwidth

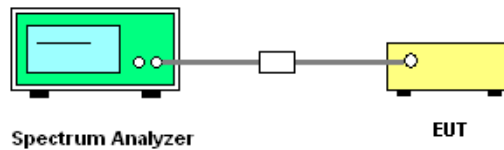

##### 3.2.2 Frequency Stability

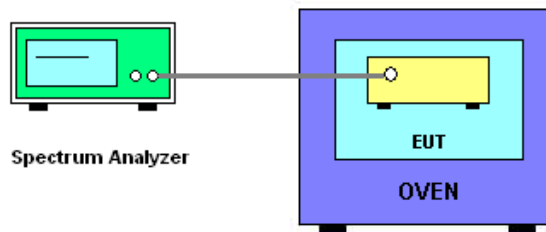

#### 3.3 Test Result of Conducted Test Items

Please refer to Appendix C.



### 3.4 20dB Spectrum Bandwidth Measurement

#### 3.4.1 Limit

Intentional radiators must be designed to ensure that the 20 dB bandwidth of the emissions in the specific band 13.553~13.567MHz

#### 3.4.2 Test Procedures

1. The transmitter output (antenna port) was connected to the spectrum analyzer in peak Max hold mode.
2. The resolution bandwidth of 1 kHz and the video bandwidth of 3 kHz were used.
3. Measured the spectrum width with power higher than 20dB below carrier.

### 3.5 Frequency Stability Measurement

#### 3.5.1 Limit

The frequency tolerance of the carrier signal shall be maintained within +/- 0.01% (100ppm) of the operating frequency over a temperature variation of -20 degrees to +50 degrees C at normal supply voltage, and for a variation in the primary supply voltage from 85% to 115% of the rated supply voltage at a temperature of 20 degrees C. For battery operated equipment, the equipment tests shall be performed using a new battery.

#### 3.5.2 Test Procedures

1. The transmitter output (antenna port) was connected to the spectrum analyzer.
2. EUT have transmitted signal and fixed channelize.
3. Set the spectrum analyzer span to view the entire emissions bandwidth.
4. Set RBW = 1 kHz, VBW = 3 kHz with peak detector and maxhold settings.
5. The  $f_c$  is declaring of channel frequency. Then the frequency error formula is  $(f_c - f) / f_c \times 10^6$  ppm and the limit is less than  $\pm 100$ ppm.
6. Extreme temperature rule is -20°C~50°C.

## 4. RADIATED TEST ITEMS

### 4.1 Measuring Instruments

See list of measuring instruments of this test report.

### 4.2 Test Setup

#### 4.2.1 For radiated emissions below 30MHz

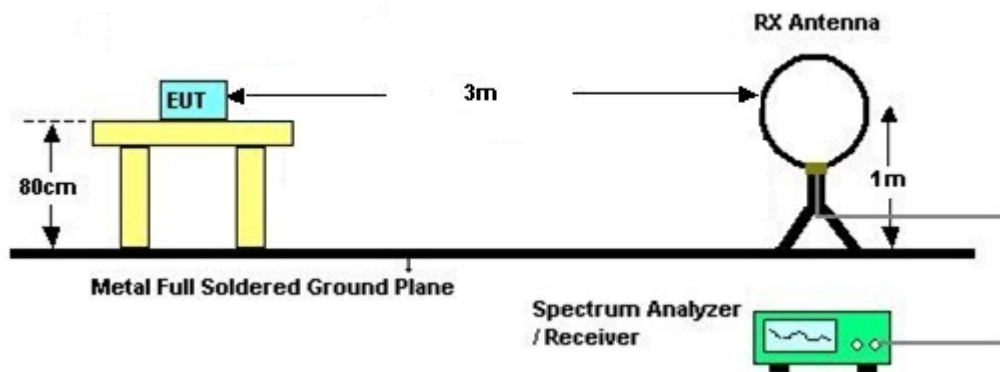

#### 4.2.2 For radiated emissions above 30MHz

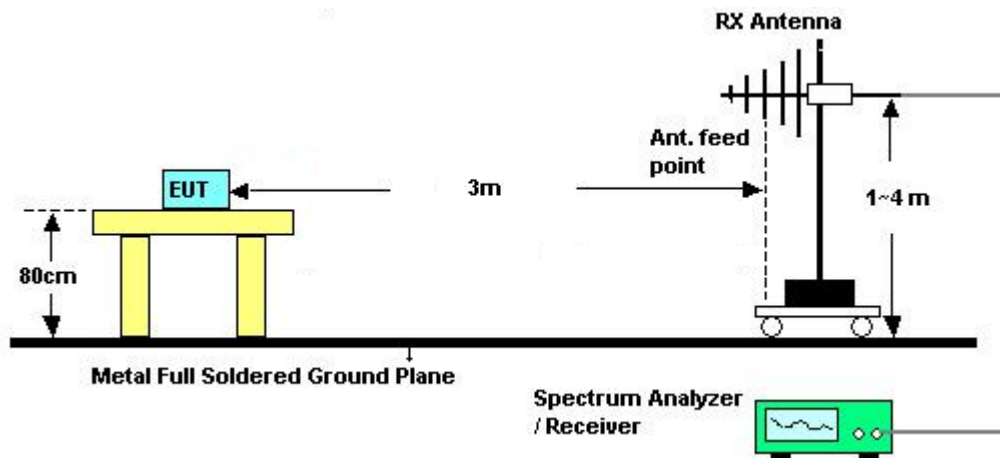

### 4.3 Test Result of Radiated Test Items

Please refer to Appendix D.



#### 4.4 Field Strength of Fundamental Emissions and Mask Measurement

##### 4.4.1 Limit

Rules and specifications	CFR 47 Part 15 section 15.225(a)-(d)			
Description	Compliance with the spectrum mask is tested using a spectrum analyzer with RBW set to a 9kHz for the band 13.553~13.567MHz			
Freq. of Emission (MHz)	Field Strength (μV/m) at 30m	Field Strength (dBμV/m) at 30m	Field Strength (dBμV/m) at 10m	Field Strength (dBμV/m) at 3m
1.705~13.110	30	29.5	48.58	69.5
13.110~13.410	106	40.5	59.58	80.5
13.410~13.553	334	50.5	69.58	90.5
13.553~13.567	15848	84.0	103.08	124.0
13.567~13.710	334	50.5	69.58	90.5
13.710~14.010	106	40.5	59.58	80.5
14.010~30.000	30	29.5	48.58	69.5

##### 4.4.2 Test Procedures

1. Configure the EUT according to ANSI C63.10. The EUT was placed on the top of the turntable 0.8 meter above ground. The phase center of the loop receiving antenna mounted antenna tower was placed 3 meters far away from the turntable.
2. Power on the EUT and all the supporting units. The turntable was rotated by 360 degrees to determine the position of the highest radiation.
3. The height of the receiving antenna was fixed at one meter above ground to find the maximum emissions field strength.
4. For Fundamental emissions, use the receiver to measure QP reading.
5. When the radiated emissions limits are expressed in terms of the average value of the emissions, and pulsed operation is employed, the measurement field strength shall be determined by averaging over one complete pulse train, including blanking intervals, as long as the pulse train does not exceed 0.1 seconds. As an alternative (provided the transmitter operates for longer than 0.1 seconds) or in cases where the pulse train exceeds 0.1 seconds, the measured field strength shall be determined from the average absolute voltage during a 0.1 second interval during which the field strength is at its maximum value.
6. Compliance with the spectrum mask is tested using a spectrum analyzer with RBW set to a 9kHz for the band 13.553~13.567MHz.

Note: Emission level (dBμV/m) = 20 log Emission level (μV/m).

## 4.5 Radiated Emissions Measurement

### 4.5.1 Limit

The field strength of any emissions which appear outside of 13.553~13.567MHz band shall not exceed the general radiated emissions limits.

Frequencies (MHz)	Field Strength ( $\mu\text{V/m}$ )	Measurement Distance (meters)
0.009~0.490	2400/F(kHz)	300
0.490~1.705	24000/F(kHz)	30
1.705~30.0	30	30
30~88	100	3
88~216	150	3
216~960	200	3
Above 960	500	3

### 4.5.2 Measuring Instrument Setting

The following table is the setting of receiver.

Receiver Parameter	Setting
Attenuation	Auto
Frequency Range: 9kHz~150kHz	RBW 200Hz for QP
Frequency Range: 150kHz~30MHz	RBW 9kHz for QP
Frequency Range: 30MHz~1000MHz	RBW 120kHz for Peak

**Note:** The emission limits shown in the above table are based on measurements employing a CISPR quasi-peak detector except for the frequency bands 9-90 kHz, 110-490 kHz. Radiated emission limits in these two bands are based on measurements employing an average detector.





### 4.5.3 Test Procedures

1. Configure the EUT according to ANSI C63.10. The EUT was placed on the top of the turntable 0.8 meter above ground. The phase center of the receiving antenna mounted on the top of a height-variable antenna tower was placed 3 meters far away from the turntable.
2. Power on the EUT and all the supporting units. The turntable was rotated by 360 degrees to determine the position of the highest radiation.
3. The height of the broadband receiving antenna was varied between one meter and four meters above ground to find the maximum emissions field strength of both horizontal and vertical polarization.
4. For each suspected emissions, the antenna tower was scan (from 1 M to 4 M) and then the turntable was rotated (from 0 degree to 360 degrees) to find the maximum reading.
5. Set the test-receiver system to Peak or CISPR quasi-peak Detect Function with specified bandwidth under Maximum Hold Mode.
6. When the radiated emissions limits are expressed in terms of the average value of the emissions, and pulsed operation is employed, the measurement field strength shall be determined by averaging over one complete pulse train, including blanking intervals, as long as the pulse train does not exceed 0.1 seconds. As an alternative (provided the transmitter operates for longer than 0.1 seconds) or in cases where the pulse train exceeds 0.1 seconds, the measured field strength shall be determined from the average absolute voltage during a 0.1 second interval during which the field strength is at its maximum value.
7. In case the emission is lower than 30MHz, loop antenna has to be used for measurement and the recorded data should be QP measured by receiver. Antenna Requirements.

### 4.5.4 Limit

Except for special regulations, the Low-power Radio-frequency Devices must not be equipped with any jacket for installing an antenna with extension cable. An intentional radiator shall be designed to ensure that no antenna other than that furnished by the responsible party shall be used with the device. The use of a permanently attached antenna or of an antenna that uses a unique coupling to the intentional radiator shall be considered sufficient to comply with the provisions of this Section. The manufacturer may design the unit so that the user can replace a broken antenna, but the use of a standard antenna jack or electrical connector is prohibited.

### 4.5.5 Antenna Anti-Replacement Construction

An embedded-in antenna design is used.



5. LIST OF MEASURING EQUIPMENT

Instrument	Manufacturer	Model No.	Serial No.	Characteristics	Calibration Date	Test Date	Due Date	Remark
Spectrum Analyzer	R&S	FSP30	101400	9kHz~40GHz	Jan. 28, 2015	May 12, 2015	Jan. 27, 2016	Conducted (TH01-SZ)
Thermal Chamber	Hongzhangroup	LP-150U	H2014081803	-40~+150°C	Sep. 16, 2014	May 12, 2015	Sep. 15, 2015	Conducted (TH01-SZ)
EMI Receiver	R&S	ESC17	100724	9kHz~3GHz	Jan. 28, 2015	May 05, 2015~ May 07, 2015	Jan. 27, 2016	Conduction (CO01-SZ)
AC LISN	EMCO	3816/2SH	103892	9kHz~30MHz	Feb. 02, 2015	May 05, 2015~ May 07, 2015	Feb. 01, 2016	Conduction (CO01-SZ)
AC LISN (for auxiliary equipment)	MessTec	AN3016	16850	9kHz~30MHz	Feb. 02, 2015	May 05, 2015~ May 07, 2015	Feb. 01, 2016	Conduction (CO01-SZ)
AC Power Source	Chroma	61602	616020000891	100Vac~250Vac	Sep. 29, 2014	May 05, 2015~ May 07, 2015	Sep. 28, 2015	Conduction (CO01-SZ)
Pulse Limiter	COM-POWER	LIT-153 Transient Limiter	53139	150kHz~30MHz	Oct. 24, 2014	May 05, 2015~ May 07, 2015	Oct. 23, 2015	Conduction (CO01-SZ)
EMI Test Receiver&SA	Agilent Technologies	N9038A	MY52260185	20Hz~26.5GHz	May 26, 2015	May 28, 2015	May 25, 2016	Radiation (03CH01-SZ)
Loop Antenna	R&S	HFH2-Z2	100354	9kHz~30MHz	May 06, 2015	May 28, 2015	May 05, 2016	Radiation (03CH01-KS)
Bilog Antenna	TeseQ	CBL6112D	23188	30MHz~2GHz	Nov. 07, 2014	May 28, 2015	Nov. 06, 2015	Radiation (03CH01-SZ)
Amplifier	ADVANTEST	BB525C	E9007003	9kHz~3000MHz / 30 dB	Jan. 28, 2015	May 28, 2015	Jan. 27, 2016	Radiation (03CH01-SZ)
AC Power Source	Chroma	61601	616010001985	N/A	NCR	May 28, 2015	NCR	Radiation (03CH01-SZ)
Turn Table	EM	EM1000	N/A	0~360 degree	NCR	May 28, 2015	NCR	Radiation (03CH01-SZ)
Antenna Mast	EM	EM1000	N/A	1 m~4 m	NCR	May 28, 2015	NCR	Radiation (03CH01-SZ)

## Appendix B. Test Results of Conducted Emission Test

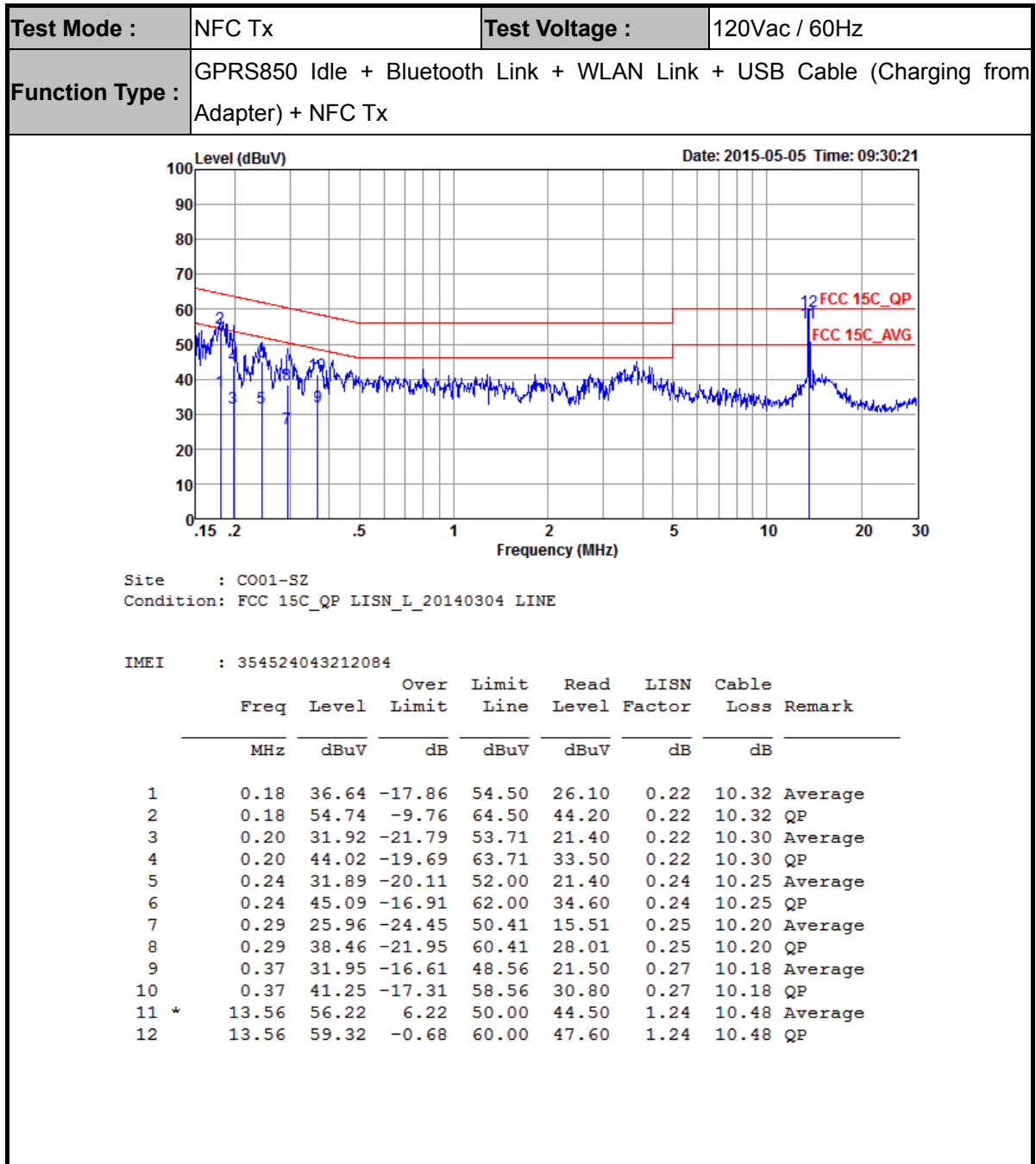

(1) The EUT is with NFC antenna during testing.



Test Mode :	NFC Tx	Test Voltage :	120Vac / 60Hz
Function Type :	GPRS850 Idle + Bluetooth Link + WLAN Link + USB Cable (Charging from Adapter) + NFC Tx		

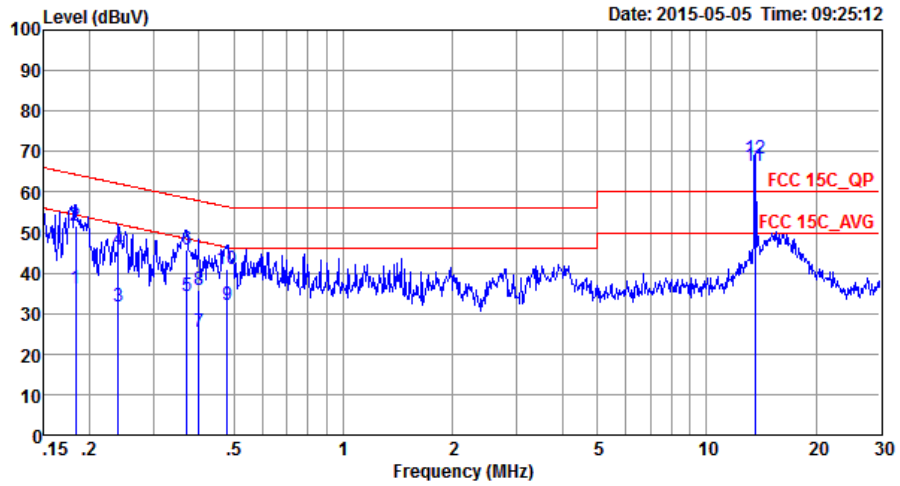

Site : CO01-SZ  
 Condition: FCC 15C\_QP LISN\_N\_20140304 NEUTRAL

IMEI : 354524043212084

	Freq	Level	Over Limit	Limit Line	Read Level	LISN Factor	Cable Loss	Remark
	MHz	dBuV	dB	dBuV	dBuV	dB	dB	
1	0.18	36.25	-18.08	54.33	25.62	0.32	10.31	Average
2	0.18	51.84	-12.49	64.33	41.21	0.32	10.31	QP
3	0.24	31.79	-20.29	52.08	21.20	0.34	10.25	Average
4	0.24	45.69	-16.39	62.08	35.10	0.34	10.25	QP
5	0.37	34.36	-14.11	48.47	23.80	0.38	10.18	Average
6	0.37	45.86	-12.61	58.47	35.30	0.38	10.18	QP
7	0.40	25.56	-22.30	47.86	15.00	0.39	10.17	Average
8	0.40	35.86	-22.00	57.86	25.30	0.39	10.17	QP
9	0.48	32.26	-14.10	46.36	21.69	0.41	10.16	Average
10	0.48	41.06	-15.30	56.36	30.49	0.41	10.16	QP
11 *	13.56	66.36	16.36	50.00	54.49	1.39	10.48	Average
12 !	13.56	68.26	8.26	60.00	56.39	1.39	10.48	QP

(1) The EUT is with NFC antenna during testing.



Test Mode :	NFC Tx	Test Voltage :	120Vac / 60Hz
Function Type :	GPRS850 Idle + Bluetooth Link + WLAN Link + USB Cable (Charging from Adapter) + NFC Tx		

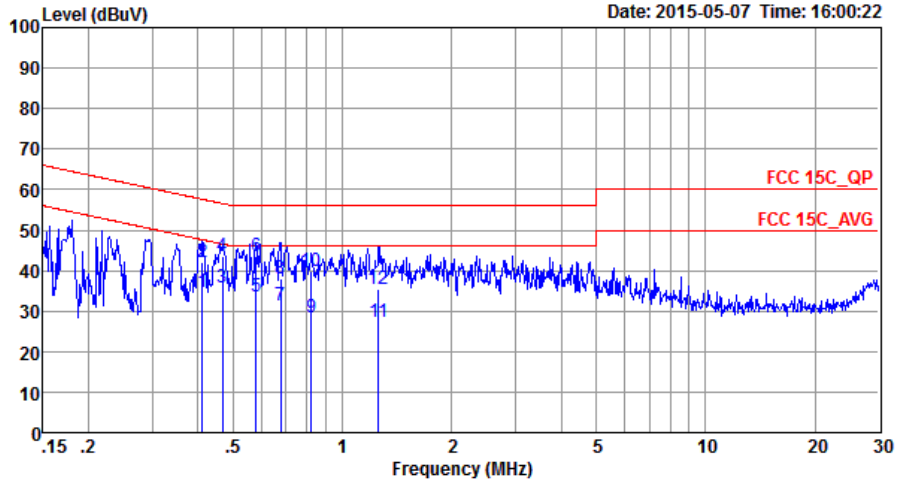

Site : CO01-SZ  
 Condition: FCC 15C\_QP LISN\_L\_20140304 LINE

IMEI : 354524043212084

	Freq	Level	Over Limit	Limit Line	Read Level	LISN Factor	Cable Loss	Remark
	MHz	dBuV	dB	dBuV	dBuV	dB	dB	
1	0.41	34.55	-13.04	47.59	24.10	0.28	10.17	Average
2	0.41	42.15	-15.44	57.59	31.70	0.28	10.17	QP
3 *	0.47	35.65	-10.89	46.54	25.20	0.29	10.16	Average
4	0.47	43.45	-13.09	56.54	33.00	0.29	10.16	QP
5	0.58	33.60	-12.40	46.00	23.20	0.25	10.15	Average
6	0.58	43.50	-12.50	56.00	33.10	0.25	10.15	QP
7	0.68	31.34	-14.66	46.00	21.00	0.19	10.15	Average
8	0.68	38.04	-17.96	56.00	27.70	0.19	10.15	QP
9	0.82	28.46	-17.54	46.00	18.10	0.21	10.15	Average
10	0.82	39.86	-16.14	56.00	29.50	0.21	10.15	QP
11	1.26	27.21	-18.79	46.00	16.80	0.25	10.16	Average
12	1.26	35.31	-20.69	56.00	24.90	0.25	10.16	QP

(2) The NFC antenna is replaced by a dummy load during test.



Test Mode :	NFC Tx	Test Voltage :	120Vac / 60Hz
Function Type :	GPRS850 Idle + Bluetooth Link + WLAN Link + USB Cable (Charging from Adapter) + NFC Tx		

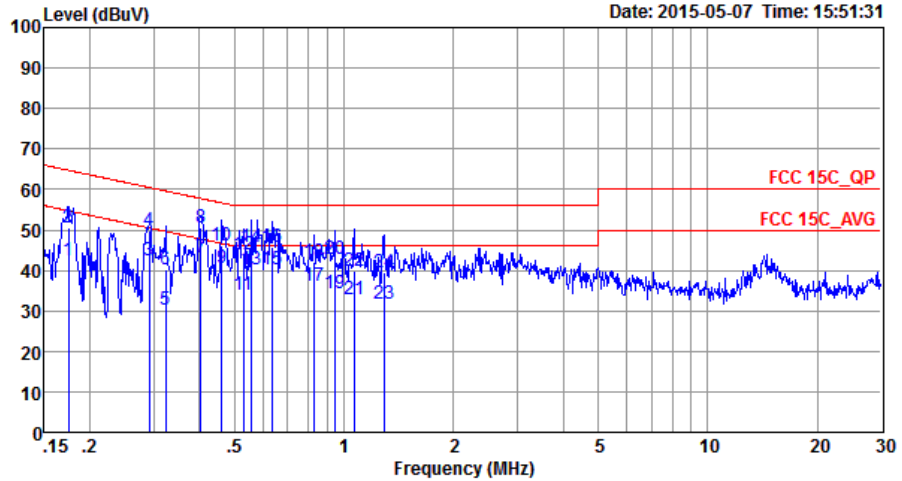

Site : CO01-SZ  
 Condition: FCC 15C\_QP LISN\_N\_20140304 NEUTRAL

IMEI : 354524043212084

	Freq	Level	Over Limit	Limit Line	Read Level	LISN Factor	Cable Loss	Remark
	MHz	dBuV	dB	dBuV	dBuV	dB	dB	
1	0.17	42.45	-12.27	54.72	31.81	0.32	10.32	Average
2	0.17	50.65	-14.07	64.72	40.01	0.32	10.32	QP
3	0.29	42.56	-7.94	50.50	31.99	0.36	10.21	Average
4	0.29	49.76	-10.74	60.50	39.19	0.36	10.21	QP
5	0.32	30.26	-19.36	49.62	19.70	0.37	10.19	Average
6	0.32	40.06	-19.56	59.62	29.50	0.37	10.19	QP
7 *	0.40	43.16	-4.61	47.77	32.60	0.39	10.17	Average
8	0.40	50.66	-7.11	57.77	40.10	0.39	10.17	QP
9	0.46	40.76	-5.91	46.67	30.20	0.40	10.16	Average
10	0.46	46.26	-10.41	56.67	35.70	0.40	10.16	QP
11	0.53	33.94	-12.06	46.00	23.41	0.38	10.15	Average
12	0.53	44.04	-11.96	56.00	33.51	0.38	10.15	QP
13	0.56	40.11	-5.89	46.00	29.60	0.36	10.15	Average
14	0.56	45.91	-10.09	56.00	35.40	0.36	10.15	QP
15	0.64	40.05	-5.95	46.00	29.60	0.30	10.15	Average
16	0.64	45.85	-10.15	56.00	35.40	0.30	10.15	QP
17	0.83	36.14	-9.86	46.00	25.70	0.29	10.15	Average
18	0.83	42.24	-13.76	56.00	31.80	0.29	10.15	QP
19	0.94	34.47	-11.53	46.00	24.00	0.32	10.15	Average
20	0.94	42.67	-13.33	56.00	32.20	0.32	10.15	QP
21	1.07	32.79	-13.21	46.00	22.31	0.33	10.15	Average
22	1.07	39.79	-16.21	56.00	29.31	0.33	10.15	QP
23	1.29	31.71	-14.29	46.00	21.21	0.34	10.16	Average
24	1.29	39.51	-16.49	56.00	29.01	0.34	10.16	QP

(2) The NFC antenna is replaced by a dummy load during test.

## Appendix C. Test Results of Conducted Test Items

### C.1 Test Result of 20dB Spectrum Bandwidth

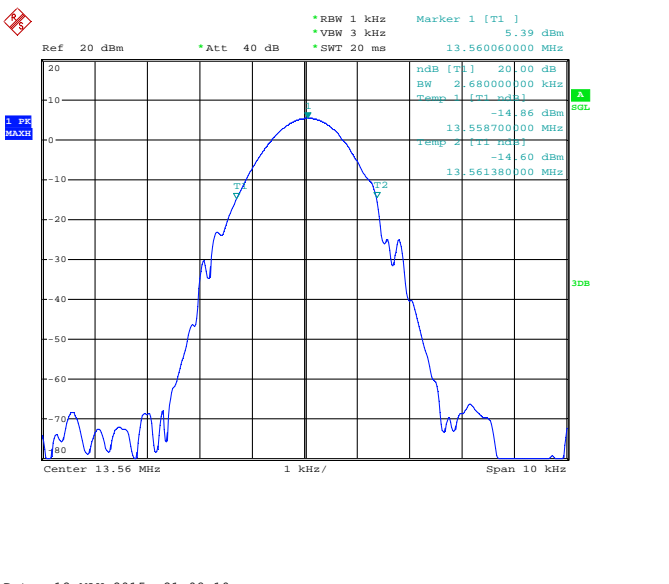
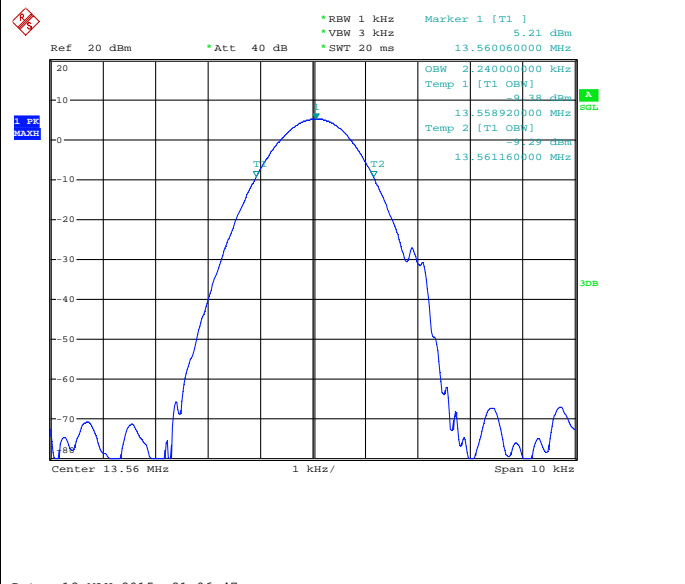
Test mode	NFC Tx	Test Frequency (MHz)	13.56
 <p>Ref 20 dBm *Att 40 dB *RBW 1 kHz Marker 1 [T1] 5.39 dBm *VBW 3 kHz *SWT 20 ms 13.560060000 MHz</p> <p>ncdB [T1] 20.00 dB BW 2.680000000 kHz Temp 1 [T1] -14.86 dBm 13.558700000 MHz Temp 2 [T1] -14.60 dBm 13.561380000 MHz</p> <p>Center 13.56 MHz 1 kHz/ Span 10 kHz</p> <p>Date: 12.MAY.2015 21:08:10</p>		 <p>Ref 20 dBm *Att 40 dB *RBW 1 kHz Marker 1 [T1] 5.21 dBm *VBW 3 kHz *SWT 20 ms 13.560060000 MHz</p> <p>OBW 2.240000000 kHz Temp 1 [T1] -14.18 dBm 13.558920000 MHz Temp 2 [T1] -14.29 dBm 13.561160000 MHz</p> <p>Center 13.56 MHz 1 kHz/ Span 10 kHz</p> <p>Date: 12.MAY.2015 21:06:47</p>	
20dB Bandwidth (kHz)	2.68	99% Occupied BW (kHz)	2.24
Frequency range (MHz)	$f_L > 13.553$	13.55870	Test Result
	$f_H < 13.567$	13.56138	Complies



C.2 Test Result of Frequency Stability

Voltage vs. Frequency Stability		Temperature vs. Frequency Stability	
Voltage (Vac)	Measurement Frequency (MHz)	Temperature (°C)	Measurement Frequency (MHz)
120	13.560060	-20	13.560060
102	13.560040	-10	13.560080
138	13.560030	0	13.560040
-	-	10	13.560080
-	-	20	13.560040
-	-	30	13.560030
-	-	40	13.560030
-	-	50	13.560050
<b>Max.Deviation (MHz)</b>	0.000060	<b>Max.Deviation (MHz)</b>	0.000080
<b>Max.Deviation (ppm)</b>	4.4248	<b>Max.Deviation (ppm)</b>	5.8997
<b>Limit</b>	<b>FS &lt; ±100 ppm</b>	<b>Limit</b>	<b>FS &lt; ±100 ppm</b>
<b>Test Result</b>	<b>PASS</b>	<b>Test Result</b>	<b>PASS</b>



## Appendix D. Test Results of Radiated Test Items

### D.1 Test Result of Field Strength of Fundamental Emissions

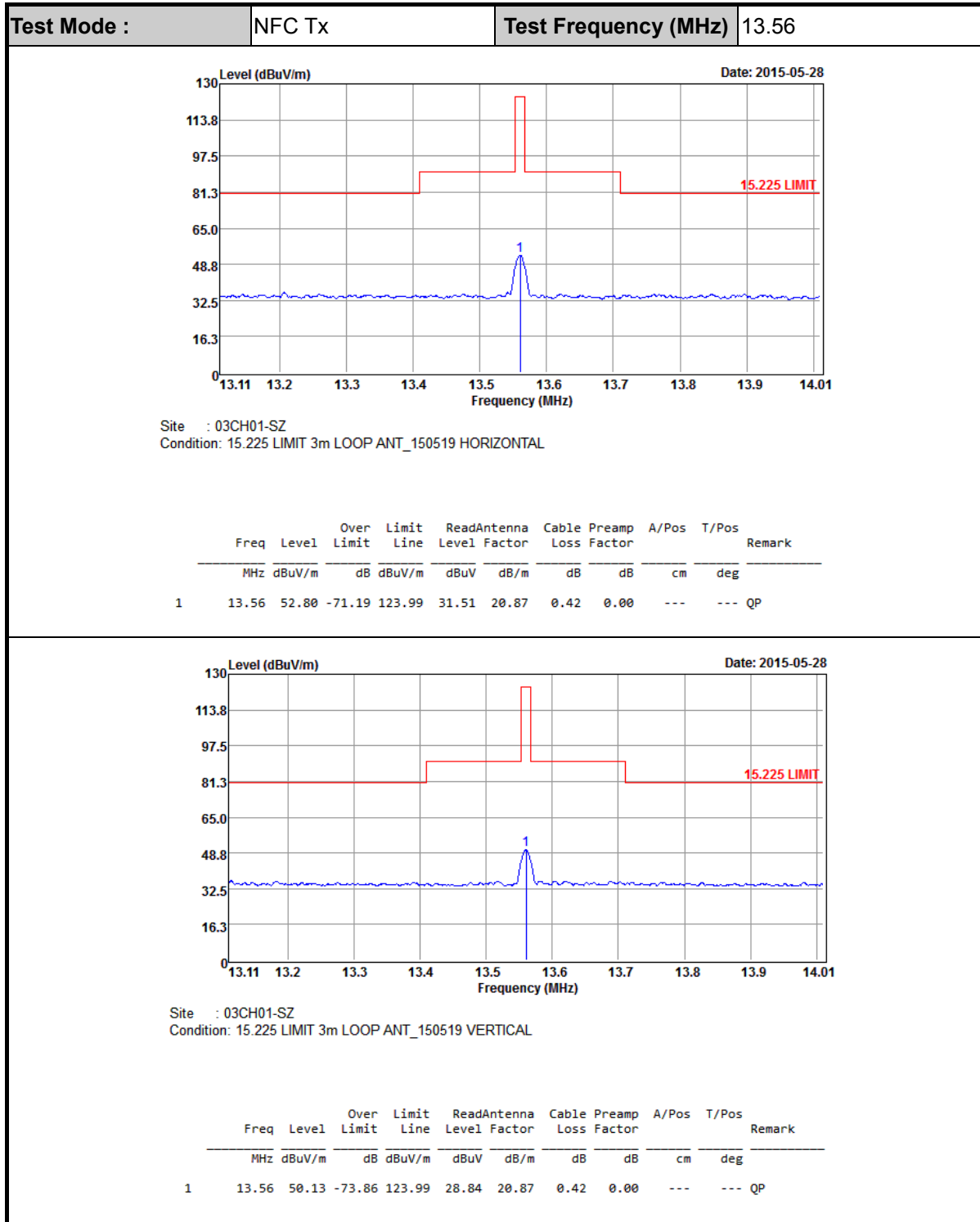

**Note:** All NFC's spurious emissions are below 20dB of limits.



D.2 Results of Radiated Emissions (9 kHz~30MHz)

Test Mode :		NFC Tx			Polarization :		Horizontal		
Frequency ( MHz )	Level ( dBμV/m )	Over Limit ( dB )	Limit Line ( dBμV/m )	Read Level (dBμV)	Antenna Factor ( dB )	Cable Loss ( dB )	Ant Pos ( cm )	Table Pos ( deg )	Remark
0.04	25.4	-90.15	115.55	2.15	23.1	0.15	-	-	Average
0.06	49.06	-62.87	111.93	26.01	22.9	0.15	-	-	Average
0.11	44.07	-62.66	106.73	21.02	22.9	0.15	-	-	Average
0.12	46.78	-59.08	105.86	23.86	22.77	0.15	-	-	Average
0.24	46.84	-53.14	99.98	24.34	22.35	0.15	-	-	Average
3.62	36.77	-33.23	70	14.86	21.68	0.23	-	-	QP
8.44	35.86	-34.14	70	14.14	21.39	0.33	-	-	QP
19.83	34.14	-35.86	70	12.07	21.57	0.5	-	-	QP
28.56	36.8	-33.2	70	13.46	22.73	0.61	-	-	QP



Test Mode :	NFC Tx			Polarization :	Vertical				
Frequency ( MHz )	Level ( dB $\mu$ V/m )	Over Limit ( dB )	Limit Line ( dB $\mu$ V/m )	Read Level (dB $\mu$ V)	Antenna Factor ( dB )	Cable Loss ( dB )	Ant Pos ( cm )	Table Pos ( deg )	Remark
0.04	26.17	-89.36	115.53	2.92	23.1	0.15	-	-	Average
0.06	45.86	-66.09	111.95	22.81	22.9	0.15	-	-	Average
0.11	44.02	-62.71	106.73	20.97	22.9	0.15	-	-	Average
0.12	43.08	-62.84	105.92	20.16	22.77	0.15	-	-	Average
0.24	47.47	-52.57	100.04	24.97	22.35	0.15	-	-	Average
3.61	37.31	-32.69	70	15.4	21.68	0.23	-	-	QP
8.9	35.58	-34.42	70	13.87	21.37	0.34	-	-	QP
19.78	34.24	-35.76	70	12.18	21.56	0.5	-	-	QP
27.74	35.59	-34.41	70	12.36	22.63	0.6	-	-	QP

**Note:**

1. The amplitude of spurious emissions which are attenuated by more than 20dB below the permissible value has no need to be reported.
2. Distance extrapolation factor = 40 log (specific distance / test distance) (dB);
3. Limit line = specific limits (dB $\mu$ V) + distance extrapolation factor.

**D.3 Results of Radiated Emissions (30MHz~1GHz)**

Test Mode :		NFC Tx			Polarization :		Horizontal			
Frequency ( MHz )	Level ( dB $\mu$ V/m )	Over Limit ( dB )	Limit Line ( dB $\mu$ V/m )	Read Level ( dB $\mu$ V )	Antenna Factor ( dB )	Cable Loss ( dB )	Preamp Factor ( dB )	Ant Pos ( cm )	Table Pos ( deg )	Remark
106.63	29.72	-13.78	43.5	49.54	12.15	1.38	33.35	-	-	Peak
124.09	30.65	-12.85	43.5	50.8	11.77	1.38	33.3	190	156	Peak
301.6	29.32	-16.68	46	46.57	13.85	1.94	33.04	-	-	Peak
347.19	30.2	-15.8	46	45.99	15.08	2.04	32.91	-	-	Peak
813.76	31.24	-14.76	46	39.47	20.32	2.99	31.54	-	-	Peak
874.87	31.54	-14.46	46	38.98	20.87	3.03	31.34	-	-	Peak

Test Mode :		NFC Tx			Polarization :		Vertical			
Frequency ( MHz )	Level ( dB $\mu$ V/m )	Over Limit ( dB )	Limit Line ( dB $\mu$ V/m )	Read Level ( dB $\mu$ V )	Antenna Factor ( dB )	Cable Loss ( dB )	Preamp Factor ( dB )	Ant Pos ( cm )	Table Pos ( deg )	Remark
56.19	34.55	-5.45	40	59.42	7.34	1.14	33.35	150	236	Peak
122.15	30.95	-12.55	43.5	51.07	11.81	1.38	33.31	-	-	Peak
287.05	25.71	-20.29	46	43.6	13.33	1.83	33.05	-	-	Peak
323.91	24.99	-21.01	46	41.57	14.46	1.94	32.98	-	-	Peak
528.58	22.89	-23.11	46	34.71	18.15	2.41	32.38	-	-	Peak
786.6	26.41	-19.59	46	35.03	20.1	2.91	31.63	-	-	Peak

**Note:**

1. The amplitude of spurious emissions which are attenuated by more than 20dB below the permissible value has no need to be reported.
2. Emission level (dB $\mu$ V/m) = 20 log Emission level ( $\mu$ V/m).
3. Corrected Reading: Antenna Factor + Cable Loss + Read Level - Preamp Factor= Level