



# FCC RF Test Report

APPLICANT : PAX Technology Limited  
EQUIPMENT : Wireless POS terminal  
BRAND NAME : PAX  
MODEL NAME : S90 WCDMA  
MARKETING NAME : S90  
FCC ID : V5PS90WCDMA  
STANDARD : FCC 47 CFR Part 2, 22(H), 24(E)  
CLASSIFICATION : PCS Licensed Transmitter (PCB)

The product was received on Mar. 08, 2013 and completely tested on Apr. 10, 2013. We, SPORTON INTERNATIONAL (SHENZHEN) INC., would like to declare that the tested sample has been evaluated in accordance with the procedures given in ANSI / TIA / EIA-603-C-2004 and shown compliance with the applicable technical standards.

The test results in this report apply exclusively to the tested model / sample. Without written approval of SPORTON INTERNATIONAL (SHENZHEN) INC., the test report shall not be reproduced except in full.

Reviewed by:

Jones Tsai / Manager



## **SPORTON INTERNATIONAL (SHENZHEN) INC.**

**No. 3 Building, the third floor of south, Shahe River west, Fengzeyuan warehouse, Nanshan District, Shenzhen, Guangdong, P.R.C.**



# TABLE OF CONTENTS

**REVISION HISTORY..... 3**

**SUMMARY OF TEST RESULT ..... 4**

**1 GENERAL DESCRIPTION ..... 5**

    1.1 Applicant..... 5

    1.2 Manufacturer ..... 5

    1.3 Feature of Equipment Under Test..... 5

    1.4 Product Specification of Equipment Under Test ..... 6

    1.5 Maximum ERP/EIRP Power, Frequency Tolerance, and Emission Designator ..... 7

    1.6 Testing Site ..... 7

    1.7 Applied Standards ..... 8

**2 TEST CONFIGURATION OF EQUIPMENT UNDER TEST ..... 9**

    2.1 Test Mode..... 9

    2.2 Connection Diagram of Test System ..... 11

    2.3 Support Unit used in test configuration and system..... 11

    2.4 Measurement Results Explanation Example ..... 11

**3 TEST RESULT ..... 12**

    3.1 Conducted Output Power Measurement..... 12

    3.2 Peak-to-Average Ratio ..... 14

    3.3 Effective Radiated Power and Effective Isotropic Radiated Power Measurement ..... 22

    3.4 99% Occupied Bandwidth and 26dB Bandwidth Measurement..... 28

    3.5 Band Edge Measurement..... 48

    3.6 Conducted Spurious Emission Measurement..... 61

    3.7 Field Strength of Spurious Radiation Measurement ..... 77

    3.8 Frequency Stability Measurement..... 92

**4 LIST OF MEASURING EQUIPMENT ..... 96**

**5 UNCERTAINTY OF EVALUATION ..... 97**

**APPENDIX A. PHOTOGRAPHS OF EUT**

**APPENDIX B. SETUP PHOTOGRAPHS**



## REVISION HISTORY

REPORT NO.	VERSION	DESCRIPTION	ISSUED DATE
FG330801	Rev. 01	Initial issue of report	Apr. 26, 2013



## SUMMARY OF TEST RESULT

Report Section	FCC Rule	IC Rule	Description	Limit	Result	Remark
3.1	§2.1046	RSS-132 (5.4) RSS-133 (6.4)	Conducted Output Power	N/A	PASS	-
3.2	§24.232(d)	RSS-132(5.4) RSS-133(6.4)	Peak-to-Average Ratio	< 13 dB	PASS	-
3.3	§22.913(a)(2)	RSS-132(5.4) SRSP-503(5.1.3)	Effective Radiated Power	< 7 Watts	PASS	-
3.3	§24.232(c)	RSS-133 (6.4) SRSP-510(5.1.2)	Equivalent Isotropic Radiated Power	< 2 Watts	PASS	-
3.4	§2.1049 §22.917(a) §24.238(a)	RSS-GEN(4.6.1) RSS-133(2.3)	Occupied Bandwidth	N/A	PASS	-
3.5	§2.1051 §22.917(a) §24.238(a)	RSS-132 (5.5) RSS-133 (6.5)	Band Edge Measurement	< 43+10log <sub>10</sub> (P[Watts])	PASS	-
3.6	§2.1051 §22.917(a) §24.238(a)	RSS-132 (5.5) RSS-133 (6.5)	Conducted Spurious Emission	< 43+10log <sub>10</sub> (P[Watts])	PASS	-
3.7	§2.1053 §22.917(a) §24.238(a)	RSS-132 (5.5) RSS-133 (6.5)	Field Strength of Spurious Radiation	< 43+10log <sub>10</sub> (P[Watts])	PASS	Under limit 28.14 dB at 3760.000 MHz
3.8	§2.1055 §22.355 §24.235	RSS-132(5.3) RSS-133(6.3)	Frequency Stability for Temperature & Voltage	< 2.5 ppm	PASS	-



# 1 General Description

## 1.1 Applicant

**PAX Technology Limited**

Room 2416, 24/F., Sun Hung Kai Centre, 30 Harbour Road, Wanchai, Hong Kong

## 1.2 Manufacturer

**PAX Computer Technology (Shenzhen) Co., Ltd.**

4/F, No.3 Building, Software Park, Second Central Science-Tech Road, High-Tech industrial Park, Shenzhen, Guangdong, P.R.C.

## 1.3 Feature of Equipment Under Test

Product Feature	
Equipment	Wireless POS terminal
Brand Name	PAX
Model Name	S90 WCDMA
Marketing Name	S90
FCC ID	V5PS90WCDMA
EUT supports Radios application	GSM/GPRS/EGPRS/WCDMA/HSDPA/NFC
HW Version	S90-XXX-XX3-0XXX
SW Version	S90 PED 3.1
EUT Stage	Production Unit

**Remark:** The above EUT's information was declared by manufacturer. Please refer to the specifications or user's manual for more detailed description.

### 1.4 Product Specification of Equipment Under Test

Product Specification subjective to this standard	
<b>Tx Frequency</b>	GSM850: 824.2 MHz ~ 848.8 MHz GSM1900: 1850.2 MHz ~ 1909.8MHz WCDMA Band V: 826.4 MHz ~ 846.6 MHz WCDMA Band II: 1852.4 MHz ~ 1907.6 MHz
<b>Rx Frequency</b>	GSM850: 869.2 MHz ~ 893.8 MHz GSM1900: 1930.2 MHz ~ 1989.8 MHz WCDMA Band V: 871.4 MHz ~ 891.6 MHz WCDMA Band II: 1932.4 MHz ~ 1987.6 MHz
<b>Maximum Output Power to Antenna</b>	GSM850 : 33.12 dBm GSM1900 : 29.59 dBm WCDMA Band V : 21.94 dBm WCDMA Band II : 22.44 dBm
<b>Antenna Type</b>	PCB Antenna
<b>Type of Modulation</b>	GSM: GMSK GPRS: GMSK EDGE: GMSK / 8PSK WCDMA: QPSK (Uplink) HSDPA: QPSK (Uplink)

### 1.5 Maximum ERP/EIRP Power, Frequency Tolerance, and Emission Designator

FCC Rule	System	Type of Modulation	Maximum ERP/EIRP (W)	Frequency Tolerance (% , Hz, ppm)	Emission Designator
Part 22	GSM850 GSM	GMSK	0.6823	0.05 ppm	246KGXW
Part 22	GSM850 EDGE 8	8PSK	0.2553	0.05 ppm	248KG7W
Part 22	WCDMA Band V RMC 12.2Kbps	QPSK	0.0711	0.03 ppm	4M16F9W
Part 24	GSM1900 GSM	GMSK	0.8872	0.02 ppm	246KGXW
Part 24	GSM1900 EDGE 8	8PSK	0.4603	0.03 ppm	248KG7W
Part 24	WCDMA Band II RMC 12.2Kbps	QPSK	0.2009	0.02 ppm	4M18F9W

### 1.6 Testing Site

<b>Test Site</b>	SPORTON INTERNATIONAL (SHENZHEN) INC.		
<b>Test Site Location</b>	No. 3 Building, the third floor of south, Shahe River west, Fengzeyuan warehouse, Nanshan District, Shenzhen, Guangdong, P.R.C. TEL: +86-755- 3320-2398		
<b>Test Site No.</b>	<b>Sporton Site No.</b>		<b>FCC/IC Registration No.</b>
	TH01-SZ	03CH01-SZ	831040/4086F-1

## 1.7 Applied Standards

According to the specifications of the manufacturer, the EUT must comply with the requirements of the following standards:

- ♦ Preliminary Guidance for Receiving Applications for Certification of 3G Device. May 9, 2006.
- ♦ FCC 47 CFR Part 2, 22(H), 24(E)
- ♦ ANSI / TIA / EIA-603-C-2004
- ♦ FCC KDB 971168 D01 Power Meas. License Digital Systems v01

### **Remark:**

1. All test items were verified and recorded according to the standards and without any deviation during the test.
2. This EUT has also been tested and complied with the requirements of FCC Part 15, Subpart B, recorded in a separate test report.



## 2 Test Configuration of Equipment Under Test

### 2.1 Test Mode

During all testing, EUT is in link mode with base station emulator at maximum power level. The spurious emission measurements were carried out in semi-anechoic chamber with 3-meter test range.

Frequency range investigated for radiated emission is as follows:

1. 30 MHz to 9000 MHz for GSM850 and WCDMA Band V.
2. 30 MHz to 19000 MHz for GSM1900 and WCDMA Band II.

Test Modes		
Band	Radiated TCs	Conducted TCs
GSM 850	<ul style="list-style-type: none"> <li>■ GSM Link</li> <li>■ EDGE 8 Link</li> </ul>	<ul style="list-style-type: none"> <li>■ GSM Link</li> <li>■ EDGE 8 Link</li> </ul>
GSM 1900	<ul style="list-style-type: none"> <li>■ GSM Link</li> <li>■ EDGE 8 Link</li> </ul>	<ul style="list-style-type: none"> <li>■ GSM Link</li> <li>■ EDGE 8 Link</li> </ul>
WCDMA Band V	<ul style="list-style-type: none"> <li>■ RMC 12.2Kbps Link</li> </ul>	<ul style="list-style-type: none"> <li>■ RMC 12.2Kbps Link</li> </ul>
WCDMA Band II	<ul style="list-style-type: none"> <li>■ RMC 12.2Kbps Link</li> </ul>	<ul style="list-style-type: none"> <li>■ RMC 12.2Kbps Link</li> </ul>

**Note:** The maximum power levels are GSM mode for GSM link, EDGE multi-slot class 8 mode for 8PSK link, RMC 12.2Kbps mode for WCDMA band V, and RMC 12.2Kbps mode for WCDMA band II, only these modes were used for all tests.



The conducted power tables are as follows:

Conducted Power (*Unit: dBm)						
Band	GSM850			GSM1900		
Channel	128	189	251	512	661	810
Frequency	824.2	836.4	848.8	1850.2	1880.0	1909.8
GSM	32.71	33.12	32.73	29.59	29.21	28.91
GPRS 8	32.70	33.10	32.72	29.55	29.18	28.89
GPRS 10	30.21	30.54	30.18	29.51	29.16	28.88
EGPRS 8	27.21	27.60	27.27	26.00	25.67	25.39
EGPRS 10	27.20	27.58	27.27	26.00	25.66	25.39
EGPRS 11	27.17	27.55	27.23	25.99	25.64	25.36
EGPRS 12	27.09	27.50	27.20	25.93	25.63	25.36

Conducted Power (*Unit: dBm)						
Band	WCDMA Band V			WCDMA Band II		
Channel	4132	4182	4233	9262	9400	9538
Frequency	826.4	836.4	846.6	1852.4	1880.0	1907.6
RMC 12.2K	21.80	21.94	21.82	22.00	22.44	22.35
HSDPA Subtest-1	21.79	21.82	21.71	21.98	22.43	22.33
HSDPA Subtest-2	21.78	21.80	21.73	21.94	22.41	22.33
HSDPA Subtest-3	21.61	21.79	21.74	21.96	22.42	22.25
HSDPA Subtest-4	21.62	21.68	21.69	21.95	22.40	22.30

## 2.2 Connection Diagram of Test System

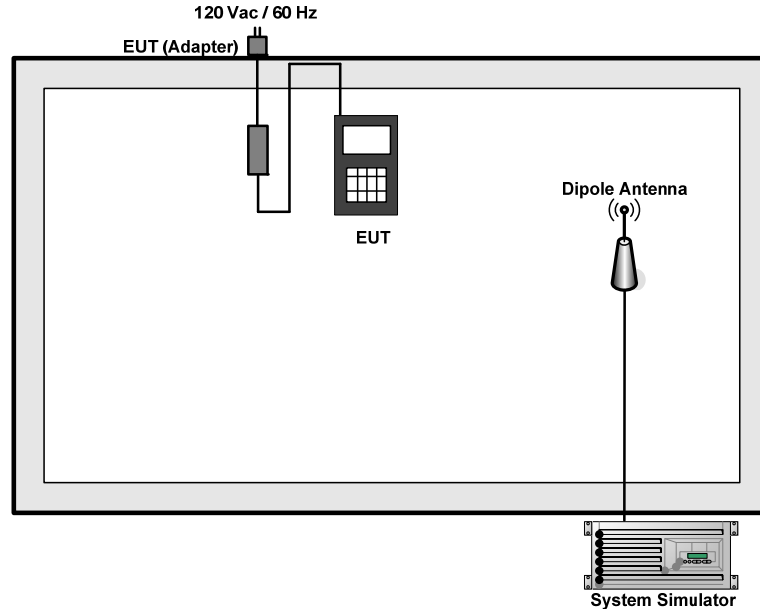

## 2.3 Support Unit used in test configuration and system

Item	Equipment	Trade Name	Model No.	FCC ID	Data Cable	Power Cord
1.	System Simulator	Agilent	E5515C	N/A	N/A	Unshielded, 1.8 m
2.	DC Power Supply	TOPWORD	3303DR	N/A	N/A	Unshielded, 1.8 m

## 2.4 Measurement Results Explanation Example

For all conducted test items:

The offset level is set in the spectrum analyzer to compensate the RF cable loss and attenuator factor between EUT conducted output port and spectrum analyzer. With the offset compensation, the spectrum analyzer reading level is exactly the EUT RF output level.

The spectrum analyzer offset is derived from RF cable loss and attenuator factor.

*Offset = RF cable loss + attenuator factor.*

Following shows an offset computation example with cable loss 4.2 dB and 10dB attenuator.

Example :

$$\begin{aligned} \text{Offset(dB)} &= \text{RF cable loss(dB)} + \text{attenuator factor(dB)} \\ &= 4.2 + 10 = 14.2 \text{ (dB)} \end{aligned}$$

### 3 Test Result

#### 3.1 Conducted Output Power Measurement

##### 3.1.1 Description of the Conducted Output Power Measurement

A base station simulator was used to establish communication with the EUT. Its parameters were set to transmit the maximum power on the EUT. The measured power in the radio frequency on the transmitter output terminals shall be reported.

##### 3.1.2 Measuring Instruments

See list of measuring instruments of this test report.

##### 3.1.3 Test Procedures

1. The transmitter output port was connected to base station.
2. The RF output of EUT was connected to the spectrum analyzer by RF cable and attenuator. The path loss was compensated to the results for each measurement.
3. Set EUT at maximum power through base station.
4. Select lowest, middle, and highest channels for each band and different modulation.
5. Measure the maximum burst average power for GSM and maximum average power for other modulation signal.

##### 3.1.4 Test Setup

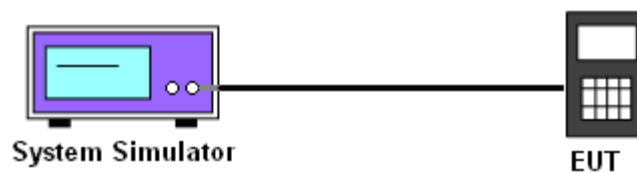

### 3.1.5 Test Result of Conducted Output Power

Cellular Band									
Modes	GSM850 (GSM)			GSM850 (EDGE 8)			WCDMA Band V (RMC 12.2Kbps)		
Channel	128 (Low)	189 (Mid)	251 (High)	128 (Low)	189 (Mid)	251 (High)	4132 (Low)	4182 (Mid)	4233 (High)
Frequency (MHz)	824.2	836.4	848.8	824.2	836.4	848.8	826.4	836.4	846.6
Conducted Power (dBm)	32.71	33.12	32.73	27.21	27.60	27.27	21.80	21.94	21.82
Conducted Power (Watts)	1.87	2.05	1.87	0.53	0.58	0.53	0.15	0.16	0.15

PCS Band									
Modes	GSM1900 (GSM)			GSM1900 (EDGE 8)			WCDMA Band II (RMC 12.2Kbps)		
Channel	512 (Low)	661 (Mid)	810 (High)	512 (Low)	661 (Mid)	810 (High)	9262 (Low)	9400 (Mid)	9538 (High)
Frequency (MHz)	1850.2	1880	1909.8	1850.2	1880	1909.8	1852.4	1880	1907.6
Conducted Power (dBm)	29.59	29.21	28.91	26.00	25.67	25.39	22.00	22.44	22.35
Conducted Power (Watts)	0.91	0.83	0.78	0.40	0.37	0.35	0.16	0.18	0.17

**Note:** maximum burst average power for GSM, and maximum average power for WCDMA.

## 3.2 Peak-to-Average Ratio

### 3.2.1 Description of the PAR Measurement

The peak-to-average ratio (PAR) of the transmission may not exceed 13 dB.

### 3.2.2 Measuring Instruments

See list of measuring instruments of this test report.

### 3.2.3 Test Procedures

1. The EUT was connected to Spectrum Analyzer and System Simulator via power divider.
2. For GSM/EGPRS operating modes:
  - a. Set EUT in maximum power output.
  - b. Set the RBW = 1MHz, VBW = 3MHz, Peak detector in spectrum analyzer for first trace.
  - c. Set the RBW = 1MHz, VBW = 3MHz, RMS detector in spectrum analyzer for second trace.
  - d. The wanted burst signal is triggered by spectrum analyzer, and measured respectively the peak level and Mean level without burst-off time, after system simulator synchronized with the spectrum analyzer.
3. For UMTS operating modes:
  - a. Set the CCDF (Complementary Cumulative Distribution Function) option in spectrum analyzer.
  - b. The highest RF powers were measured and recorded the maximum PAPR level associated with a probability of 0.1 %.
4. Record the deviation as Peak to Average Ratio.

### 3.2.4 Test Setup

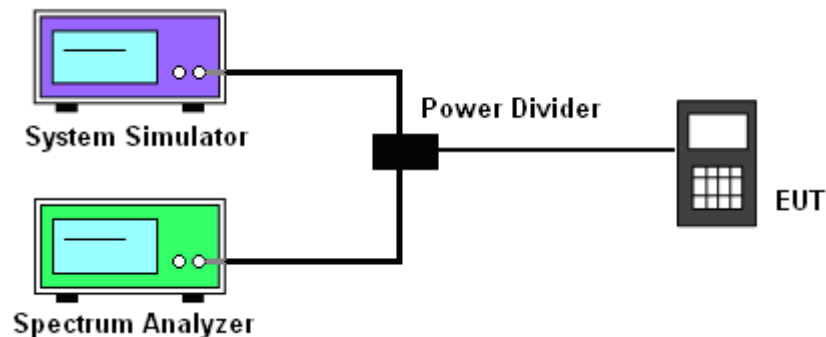

3.2.5 Test Result of Peak-to-Average Ratio

PCS Band									
Modes	GSM1900 (GSM)			GSM1900 (EDGE 8)			WCDMA Band II (RMC 12.2Kbps)		
Channel	512 (Low)	661 (Mid)	810 (High)	512 (Low)	661 (Mid)	810 (High)	9262 (Low)	9400 (Mid)	9538 (High)
Frequency (MHz)	1850.2	1880	1909.8	1850.2	1880	1909.8	1852.4	1880	1907.6
Peak-to-Average Ratio (dB)	0.26	0.27	0.25	2.99	2.90	2.86	3.12	3.28	3.20



### 3.2.6 Test Result (Plots) of Peak-to-Average Ratio

Band :	GSM 1900	Test Mode :	GSM Link
--------	----------	-------------	----------

Peak-to-Average Ratio on Channel 512 (1850.2 MHz)

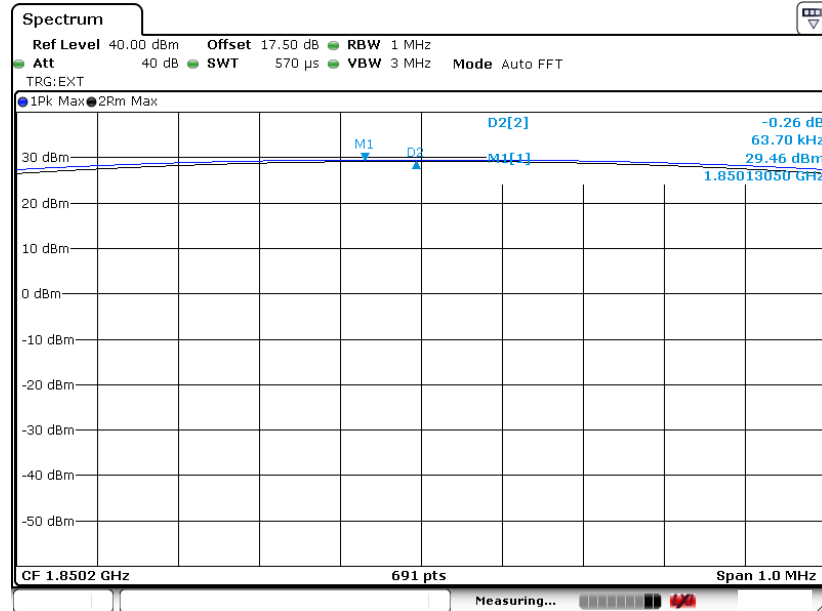

Peak-to-Average Ratio on Channel 661 (1880.0 MHz)

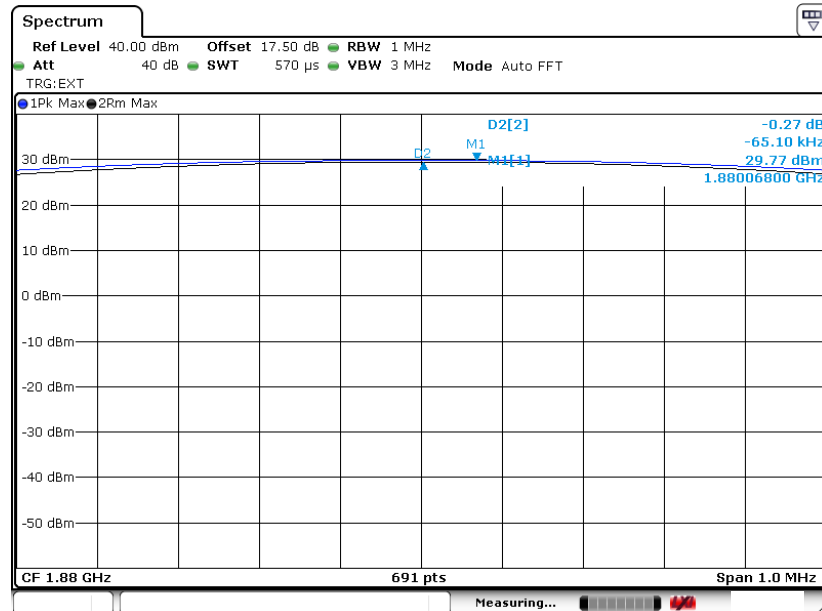





Peak-to-Average Ratio on Channel 810 (1909.8 MHz)

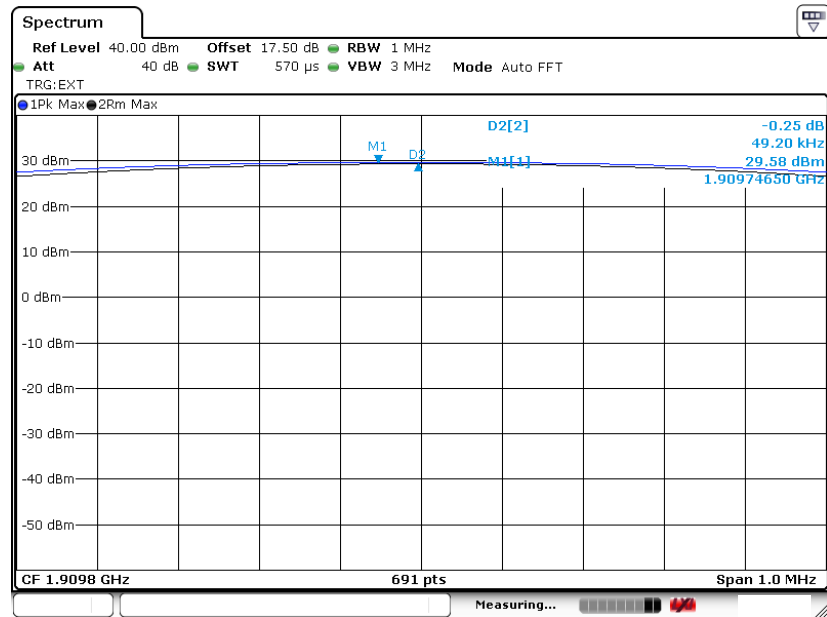



Band :	GSM 1900	Test Mode :	EDGE 8 Link
--------	----------	-------------	-------------

Peak-to-Average Ratio on Channel 512 (1850.2 MHz)

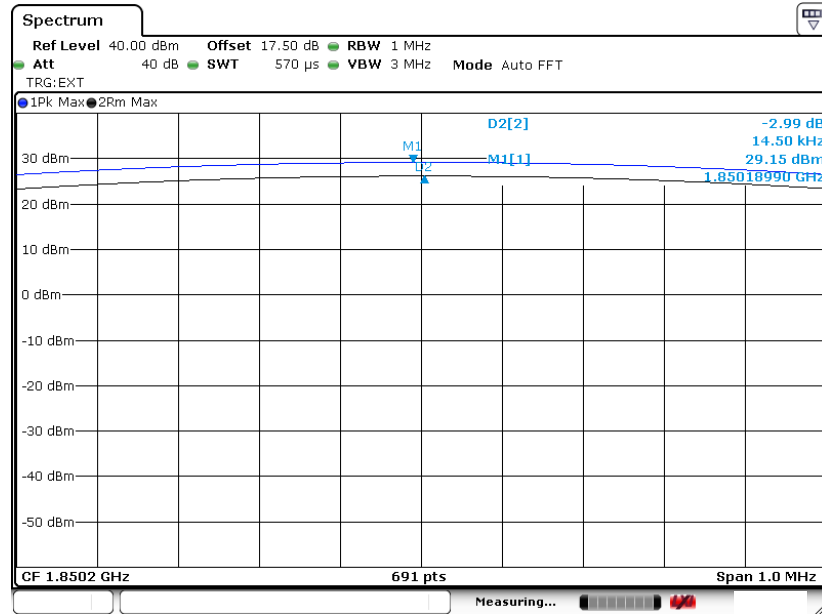

Peak-to-Average Ratio on Channel 661 (1880.0 MHz)

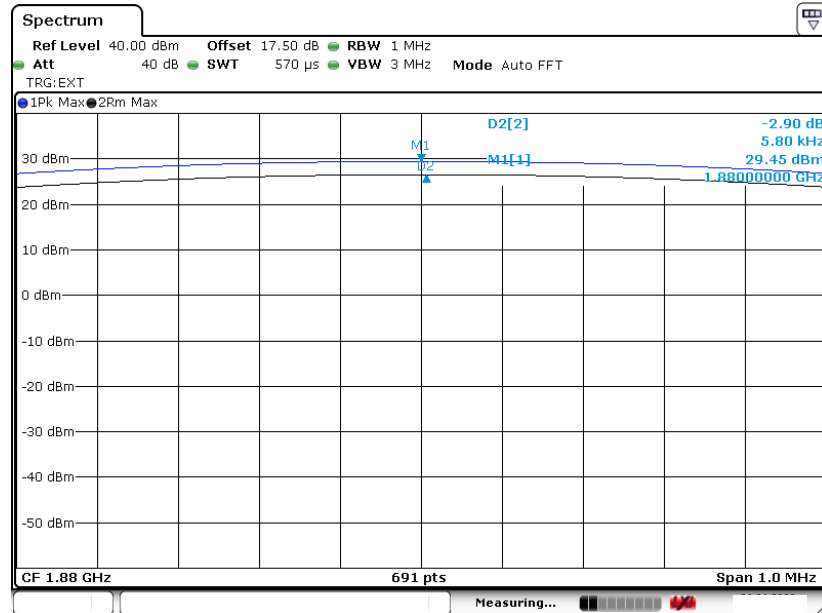



Peak-to-Average Ratio on Channel 810 (1909.8 MHz)

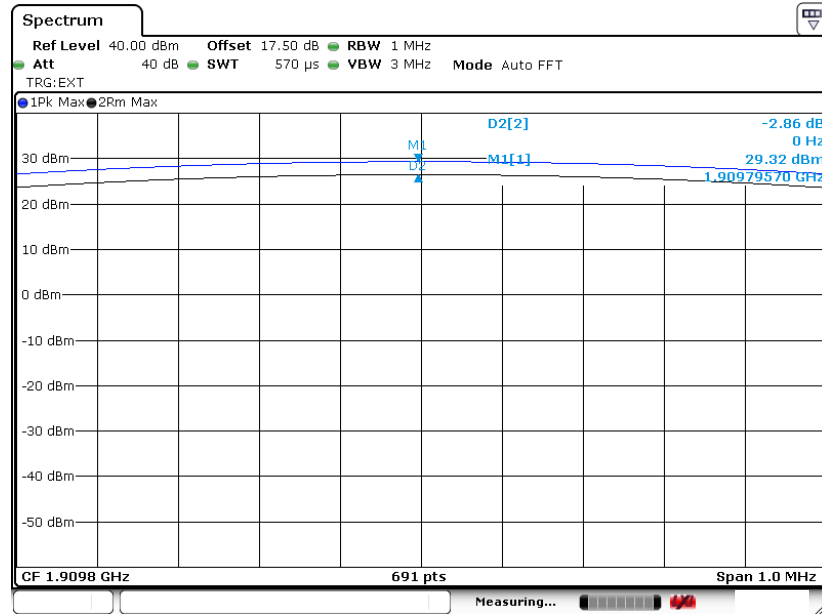



Band :	WCDMA Band II	Test Mode :	RMC 12.2Kbps Link
--------	---------------	-------------	-------------------

Peak-to-Average Ratio on Channel 9262 (1852.4 MHz)

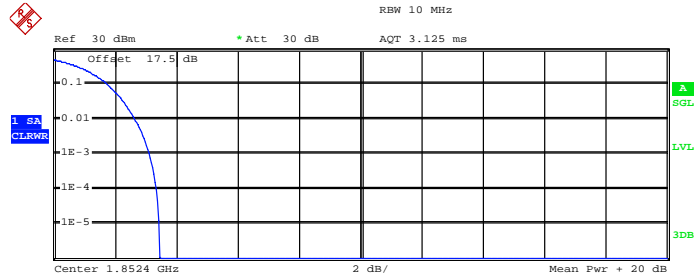

Complementary Cumulative Distribution Function (100000 samples)

Trace 1  
 Mean 22.22 dBm  
 Peak 25.66 dBm  
 Crest 3.45 dB

10 % 1.76 dB  
 1 % 2.64 dB  
 .1 % 3.12 dB  
 .01 % 3.36 dB

Date: 25.MAR.2013 20:05:18

Peak-to-Average Ratio on Channel 9400 (1880.0 MHz)

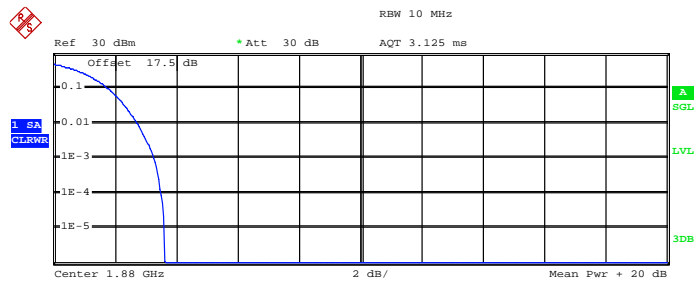

Complementary Cumulative Distribution Function (100000 samples)

Trace 1  
 Mean 22.05 dBm  
 Peak 25.66 dBm  
 Crest 3.62 dB

10 % 1.80 dB  
 1 % 2.72 dB  
 .1 % 3.28 dB  
 .01 % 3.52 dB

Date: 25.MAR.2013 20:04:50



Peak-to-Average Ratio on Channel 9538 (1907.6 MHz)

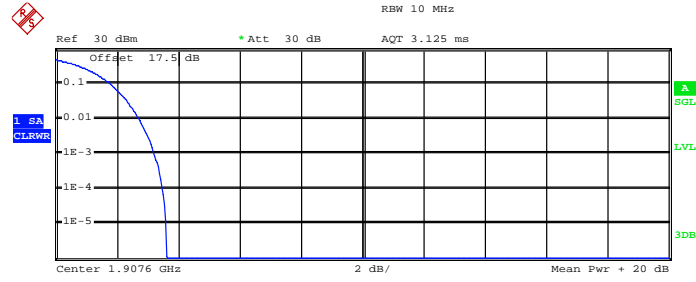

Complementary Cumulative Distribution Function (100000 samples)

Trace 1  
Mean 22.19 dBm  
Peak 25.81 dBm  
Crest 3.62 dB  
  
10 % 1.80 dB  
1 % 2.72 dB  
.1 % 3.20 dB  
.01 % 3.48 dB

Date: 25.MAR.2013 20:04:15

### 3.3 Effective Radiated Power and Effective Isotropic Radiated Power Measurement

#### 3.3.1 Description of the ERP/EIRP Measurement

The substitution method, in ANSI / TIA / EIA-603-C-2004, was used for ERP/EIRP measurement, and the spectrum analyzer configuration follows KDB 971168 D01 Power Meas. License Digital Systems v01. The ERP of mobile transmitters must not exceed 7 Watts and the EIRP of mobile transmitters are limited to 2 Watts.

#### 3.3.2 Measuring Instruments

See list of measuring instruments of this test report.

#### 3.3.3 Test Procedures

1. The EUT was placed on a turntable with 1.5 meter height in a fully anechoic chamber.
2. The EUT was set at 3 meters from the receiving antenna, which was mounted on the antenna tower.
3. GSM operating modes: Set RBW= 1MHz, VBW= 3MHz, RMS detector over burst;  
UMTS operating modes: Set RBW= 100 KHz, VBW= 300 KHz, RMS detector over frame, and use channel power option with bandwidth=5MHz, per section 4.0 of KDB 971168 D01.
4. The table was rotated 360 degrees to determine the position of the highest radiated power.
5. The height of the receiving antenna is adjusted to look for the maximum ERP/EIRP.
6. Taking the record of maximum ERP/EIRP.
7. A dipole antenna was substituted in place of the EUT and was driven by a signal generator.
8. The conducted power at the terminal of the dipole antenna is measured.
9. Repeat step 3 to step 5 to get the maximum ERP/EIRP of the substitution antenna.
10.  $ERP/EIRP = P_s + E_t - E_s + G_s = P_s + R_t - R_s + G_s$

$P_s$  (dBm) : Input power to substitution antenna.

$G_s$  (dBi or dBd) : Substitution antenna Gain.

$E_t = R_t + AF$

$E_s = R_s + AF$

AF (dB/m) : Receive antenna factor

$R_t$  : The highest received signal in spectrum analyzer for EUT.

$R_s$  : The highest received signal in spectrum analyzer for substitution antenna.

### 3.3.4 Test Setup

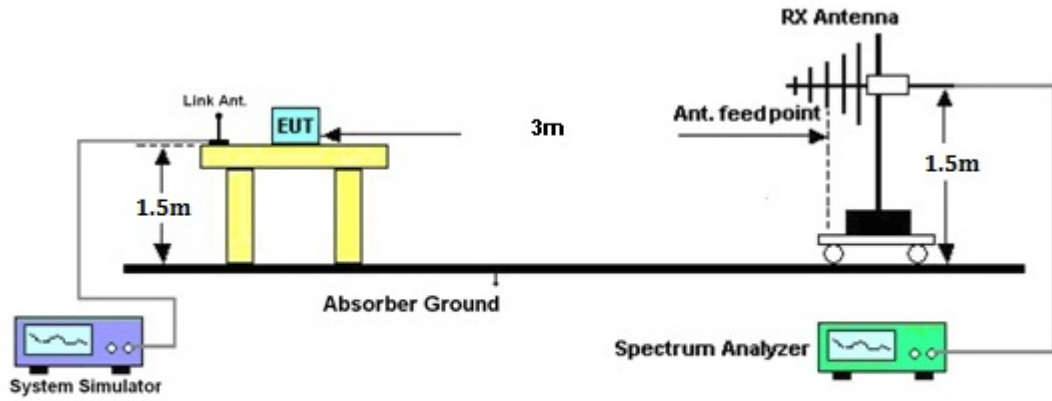

**3.3.5 Test Result of ERP**

<b>GSM850 (GSM) Radiated Power ERP</b>						
Horizontal Polarization						
<b>Frequency (MHz)</b>	<b>Rt (dBm)</b>	<b>Rs (dBm)</b>	<b>Ps (dBm)</b>	<b>Gs (dBd)</b>	<b>ERP (dBm)</b>	<b>ERP (W)</b>
824.20	-19.71	-48.12	0.00	-1.08	27.33	0.5408
836.40	-20.15	-48.28	0.00	-0.93	27.20	0.5248
848.80	-19.25	-48.35	0.00	-0.76	28.34	0.6823
Vertical Polarization						
<b>Frequency (MHz)</b>	<b>Rt (dBm)</b>	<b>Rs (dBm)</b>	<b>Ps (dBm)</b>	<b>Gs (dBd)</b>	<b>ERP (dBm)</b>	<b>ERP (W)</b>
824.20	-19.76	-47.97	0.00	-1.08	27.13	0.5164
836.40	-19.98	-48.01	0.00	-0.93	27.10	0.5129
848.80	-19.35	-48.05	0.00	-0.76	27.94	0.6223

<b>GSM850 (EDGE 8) Radiated Power ERP</b>						
Horizontal Polarization						
<b>Frequency (MHz)</b>	<b>Rt (dBm)</b>	<b>Rs (dBm)</b>	<b>Ps (dBm)</b>	<b>Gs (dBd)</b>	<b>ERP (dBm)</b>	<b>ERP (W)</b>
824.20	-25.53	-48.12	0.00	-1.08	21.51	0.1416
836.40	-24.44	-48.28	0.00	-0.93	22.91	0.1954
848.80	-23.52	-48.35	0.00	-0.76	24.07	0.2553
Vertical Polarization						
<b>Frequency (MHz)</b>	<b>Rt (dBm)</b>	<b>Rs (dBm)</b>	<b>Ps (dBm)</b>	<b>Gs (dBd)</b>	<b>ERP (dBm)</b>	<b>ERP (W)</b>
824.20	-25.67	-47.97	0.00	-1.08	21.22	0.1324
836.40	-24.51	-48.01	0.00	-0.93	22.57	0.1807
848.80	-23.58	-48.05	0.00	-0.76	23.71	0.2350





WCDMA Band V (RMC 12.2Kbps) Radiated Power ERP						
Horizontal Polarization						
Frequency (MHz)	Rt (dBm)	Rs (dBm)	Ps (dBm)	Gs (dBd)	ERP (dBm)	ERP (W)
826.40	-30.80	-48.12	0.00	-1.08	16.24	0.0421
836.40	-28.83	-48.28	0.00	-0.93	18.52	0.0711
846.60	-30.36	-48.35	0.00	-0.76	17.23	0.0528
Vertical Polarization						
Frequency (MHz)	Rt (dBm)	Rs (dBm)	Ps (dBm)	Gs (dBd)	ERP (dBm)	ERP (W)
826.40	-30.49	-47.97	0.00	-1.08	16.40	0.0437
836.40	-28.76	-48.01	0.00	-0.93	18.32	0.0679
846.60	-30.49	-48.05	0.00	-0.76	16.80	0.0479

3.3.6 Test Result of EIRP

GSM1900 (GSM) Radiated Power EIRP						
Horizontal Polarization						
Frequency (MHz)	Rt (dBm)	Rs (dBm)	Ps (dBm)	Gs (dBi)	EIRP (dBm)	EIRP (W)
1850.20	-25.51	-51.88	0.00	1.96	28.33	0.6808
1880.00	-25.70	-52.99	0.00	2.00	29.29	0.8492
1909.80	-26.78	-54.28	0.00	1.98	29.48	0.8872
Vertical Polarization						
Frequency (MHz)	Rt (dBm)	Rs (dBm)	Ps (dBm)	Gs (dBi)	EIRP (dBm)	EIRP (W)
1850.20	-24.69	-52.13	0.00	1.96	29.40	0.8710
1880.00	-26.71	-53.17	0.00	2.00	28.46	0.7015
1909.80	-28.40	-54.13	0.00	1.98	27.71	0.5902

GSM1900 (EDGE 8) Radiated Power EIRP						
Horizontal Polarization						
Frequency (MHz)	Rt (dBm)	Rs (dBm)	Ps (dBm)	Gs (dBi)	EIRP (dBm)	EIRP (W)
1850.20	-28.99	-51.88	0.00	1.96	24.85	0.3055
1880.00	-29.65	-52.99	0.00	2.00	25.34	0.3420
1909.80	-30.88	-54.28	0.00	1.98	25.38	0.3451
Vertical Polarization						
Frequency (MHz)	Rt (dBm)	Rs (dBm)	Ps (dBm)	Gs (dBi)	EIRP (dBm)	EIRP (W)
1850.20	-27.46	-52.13	0.00	1.96	26.63	0.4603
1880.00	-29.97	-53.17	0.00	2.00	25.20	0.3311
1909.80	-31.45	-54.13	0.00	1.98	24.66	0.2924



WCDMA Band II (RMC 12.2Kbps) Radiated Power EIRP						
Horizontal Polarization						
Frequency (MHz)	Rt (dBm)	Rs (dBm)	Ps (dBm)	Gs (dBi)	EIRP (dBm)	EIRP (W)
1852.40	-31.41	-51.88	0.00	1.96	22.43	0.1750
1880.00	-32.62	-52.99	0.00	2.00	22.37	0.1726
1907.60	-33.23	-54.28	0.00	1.98	23.03	0.2009
Vertical Polarization						
Frequency (MHz)	Rt (dBm)	Rs (dBm)	Ps (dBm)	Gs (dBi)	EIRP (dBm)	EIRP (W)
1852.40	-31.73	-52.13	0.00	1.96	22.36	0.1722
1880.00	-33.42	-53.17	0.00	2.00	21.75	0.1496
1907.60	-34.37	-54.13	0.00	1.98	21.74	0.1493

### 3.4 99% Occupied Bandwidth and 26dB Bandwidth Measurement

#### 3.4.1 Description of 99% Occupied Bandwidth and 26dB Bandwidth Measurement

The 99% occupied bandwidth is the width of a frequency band such that, below the lower and above the upper frequency limits, the mean powers emitted are each equal to a specified percentage 0.5% of the total mean transmitted power.

The emission bandwidth is defined as the width of the signal between two points, located at the 2 sides of the carrier frequency, outside of which all emissions are attenuated at least 26 dB below the transmitter power.

#### 3.4.2 Measuring Instruments

See list of measuring instruments of this test report.

#### 3.4.3 Test Procedures

1. The EUT was connected to Spectrum Analyzer and Base Station via power divider.
2. The RF output of EUT was connected to the spectrum analyzer by RF cable and attenuator. The path loss was compensated to the results for each measurement.
3. The 99% occupied bandwidth and 26 dB bandwidth of the middle channel for the highest RF powers were measured.

#### 3.4.4 Test Setup

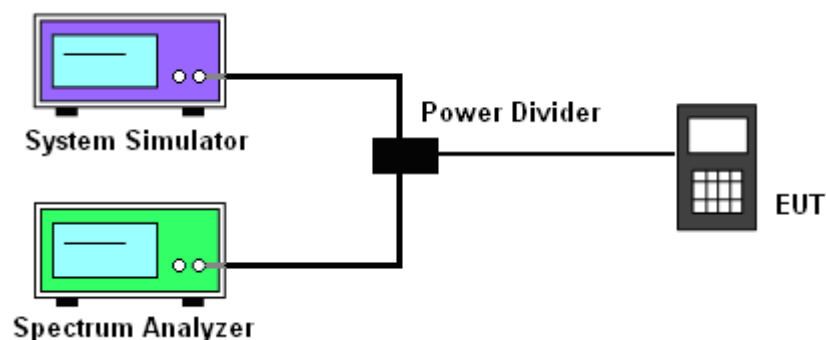

3.4.5 Test Result of 99% Occupied Bandwidth and 26dB Bandwidth

Cellular Band						
Modes	GSM850 (GSM)			GSM850 (EDGE 8)		
Channel	128 (Low)	189 (Mid)	251 (High)	128 (Low)	189 (Mid)	251 (High)
Frequency (MHz)	824.2	836.4	848.8	824.2	836.4	848.8
99% OBW (KHz)	246.00	242.00	244.00	246.00	246.00	248.00
26dB BW (KHz)	316.00	310.00	308.00	314.00	314.00	312.00

PCS Band						
Modes	GSM1900 (GSM)			GSM1900 (EDGE 8)		
Channel	512 (Low)	661 (Mid)	810 (High)	512 (Low)	661 (Mid)	810 (High)
Frequency (MHz)	1850.2	1880	1909.8	1850.2	1880	1909.8
99% OBW (KHz)	246.00	246.00	246.00	246.00	248.00	248.00
26dB BW (KHz)	308.00	306.00	308.00	314.00	310.00	310.00

Cellular Band			
Modes	WCDMA Band V (RMC 12.2Kbps)		
Channel	4132 (Low)	4182 (Mid)	4233 (High)
Frequency (MHz)	826.4	836.4	846.6
99% OBW (MHz)	4.16	4.14	4.14
26dB BW (MHz)	4.66	4.66	4.68

PCS Band			
Modes	WCDMA Band II (RMC 12.2Kbps)		
Channel	9262 (Low)	9400 (Mid)	9538 (High)
Frequency (MHz)	1852.4	1880	1907.6
99% OBW (MHz)	4.16	4.18	4.16
26dB BW (MHz)	4.68	4.68	4.68

### 3.4.6 Test Result (Plots) of 99% Occupied Bandwidth and 26dB Bandwidth

<b>Band :</b>	GSM 850	<b>Test Mode :</b>	GSM Link
---------------	---------	--------------------	----------

99% Occupied Bandwidth Plot on Channel 128 (824.2 MHz)

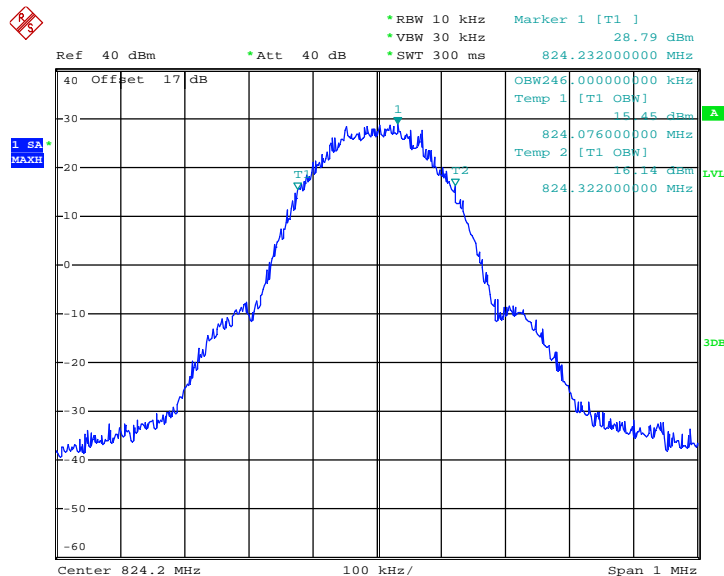

Date: 26.MAR.2013 10:28:04

26dB Bandwidth Plot on Channel 128 (824.2 MHz)

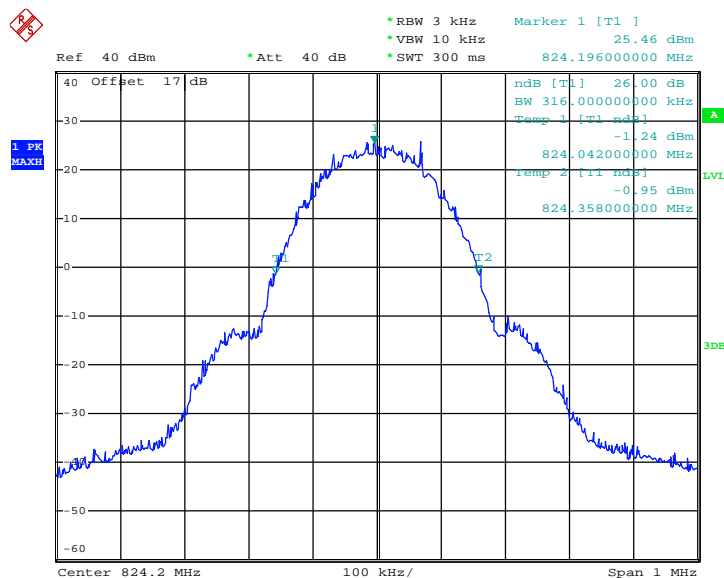

Date: 26.MAR.2013 10:15:01



99% Occupied Bandwidth Plot on Channel 189 (836.4 MHz)

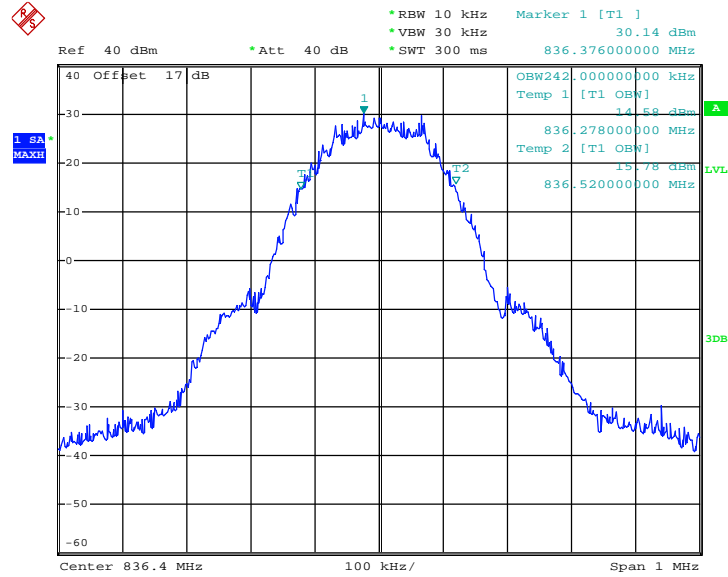

Date: 26.MAR.2013 10:30:12

26dB Bandwidth Plot on Channel 189 (836.4 MHz)

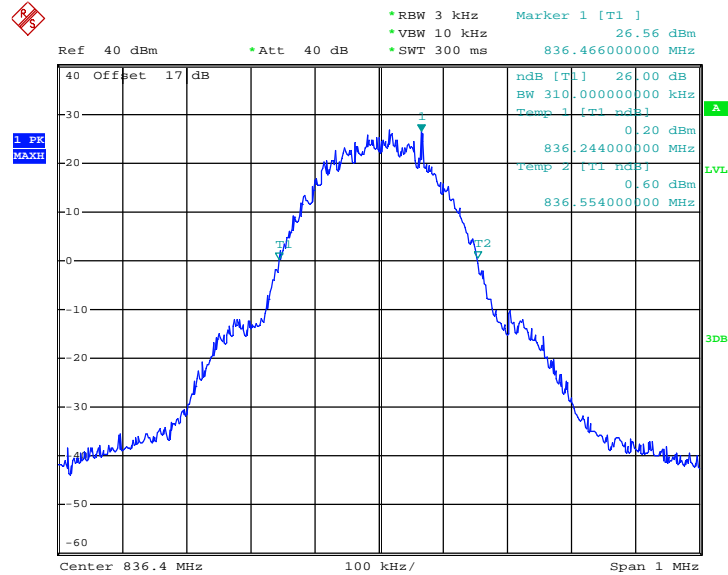

Date: 26.MAR.2013 10:10:56



99% Occupied Bandwidth Plot on Channel 251 (848.8 MHz)

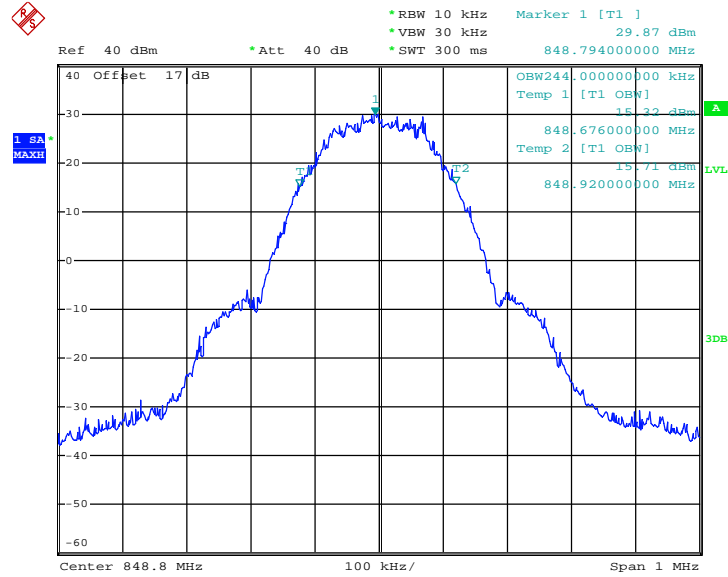

Date: 26.MAR.2013 10:36:45

26dB Bandwidth Plot on Channel 251 (848.8 MHz)

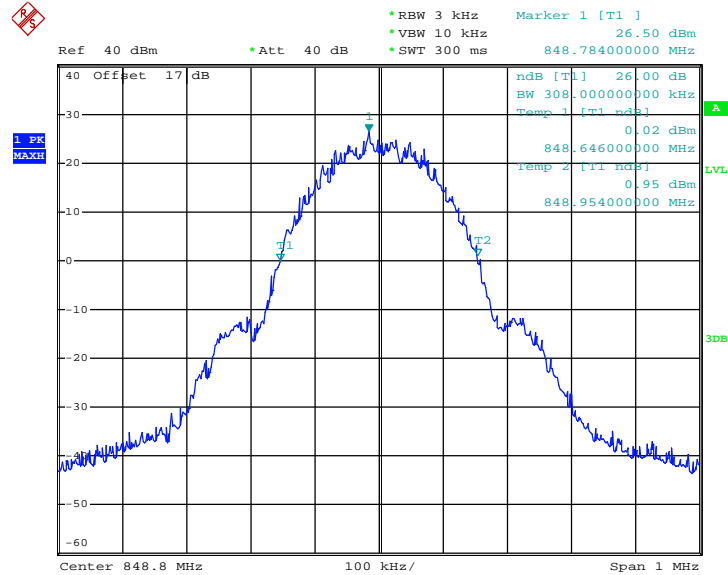

Date: 26.MAR.2013 10:09:38





Band :	GSM 850	Test Mode :	EDGE 8 Link
--------	---------	-------------	-------------

99% Occupied Bandwidth Plot on Channel 128 (824.2 MHz)

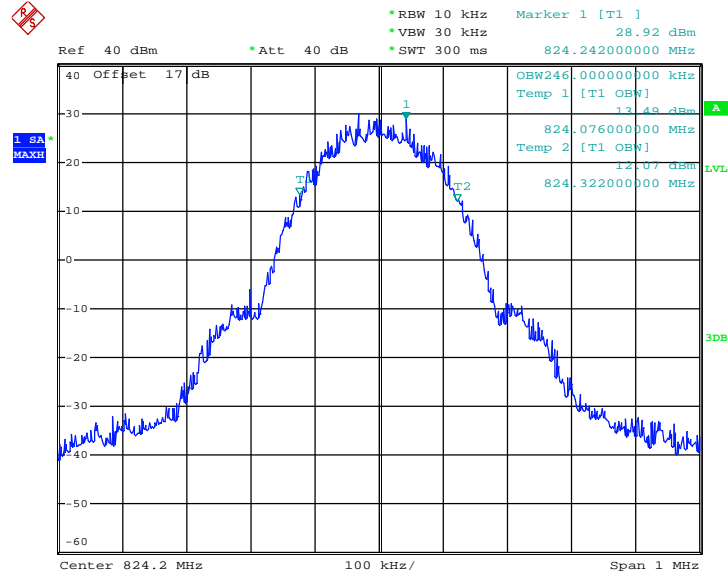

Date: 26.MAR.2013 15:42:09

26dB Bandwidth Plot on Channel 128 (824.2 MHz)

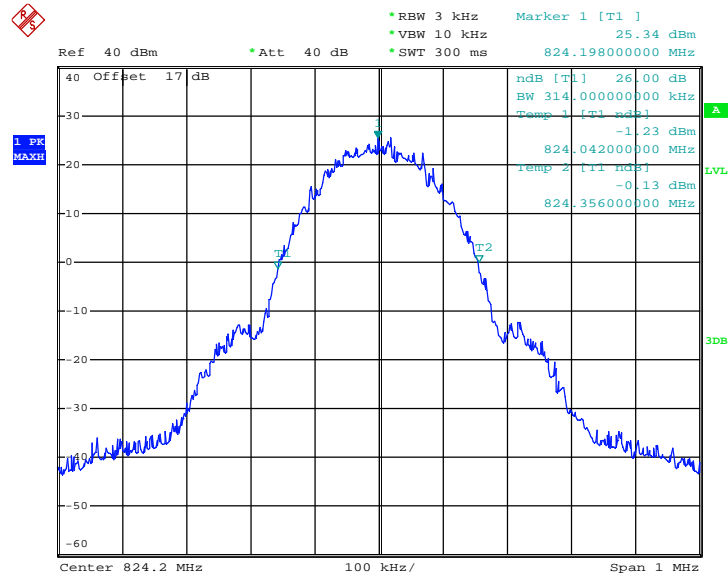

Date: 26.MAR.2013 15:38:48



99% Occupied Bandwidth Plot on Channel 189 (836.4 MHz)

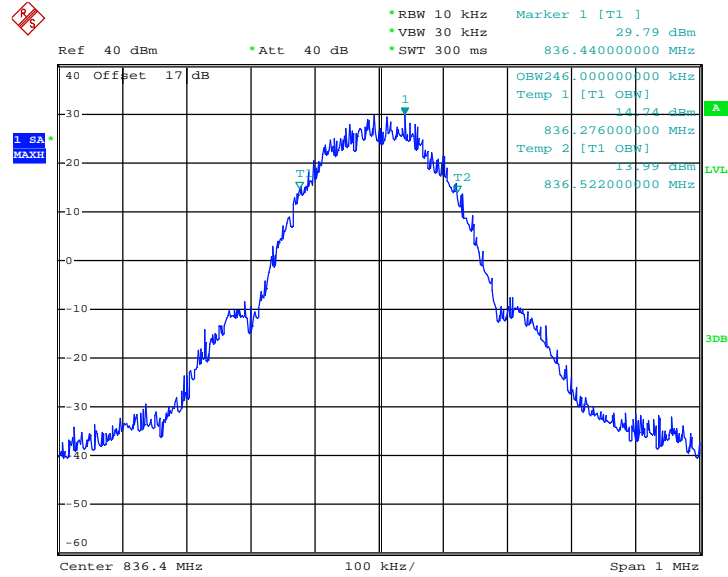

Date : 26.MAR.2013 15:43:18

26dB Bandwidth Plot on Channel 189 (836.4 MHz)

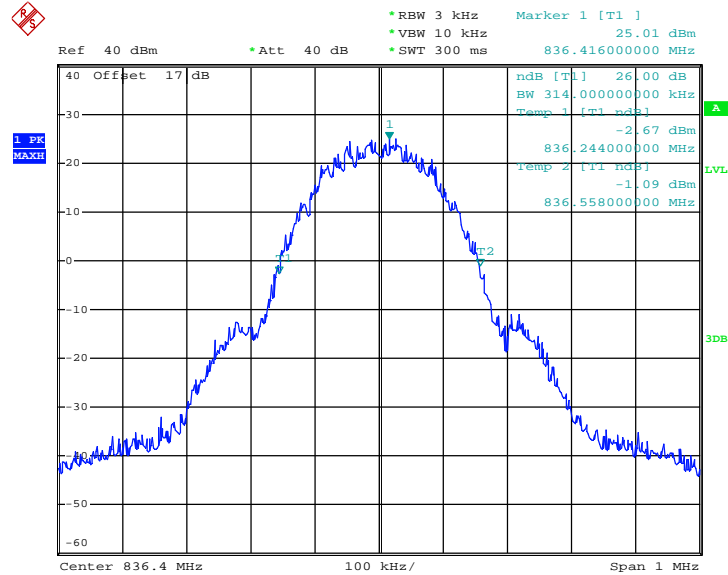

Date : 26.MAR.2013 15:37:08



99% Occupied Bandwidth Plot on Channel 251 (848.8 MHz)

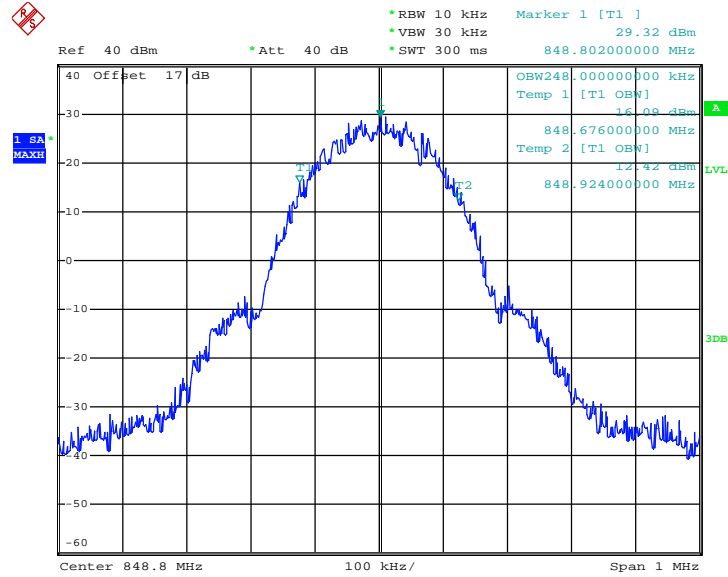

Date : 26.MAR.2013 15:44:36

26dB Bandwidth Plot on Channel 251 (848.8 MHz)

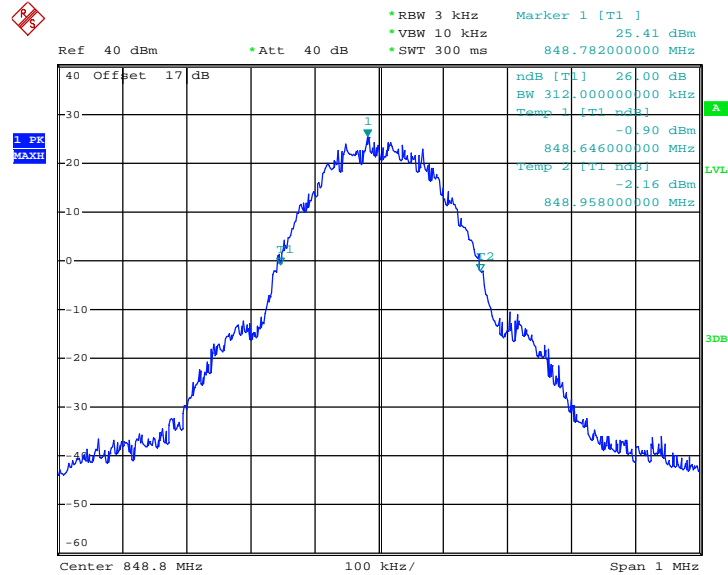

Date : 26.MAR.2013 15:36:03



Band :	GSM 1900	Test Mode :	GSM Link
--------	----------	-------------	----------

99% Occupied Bandwidth Plot on Channel 512 (1850.2 MHz)

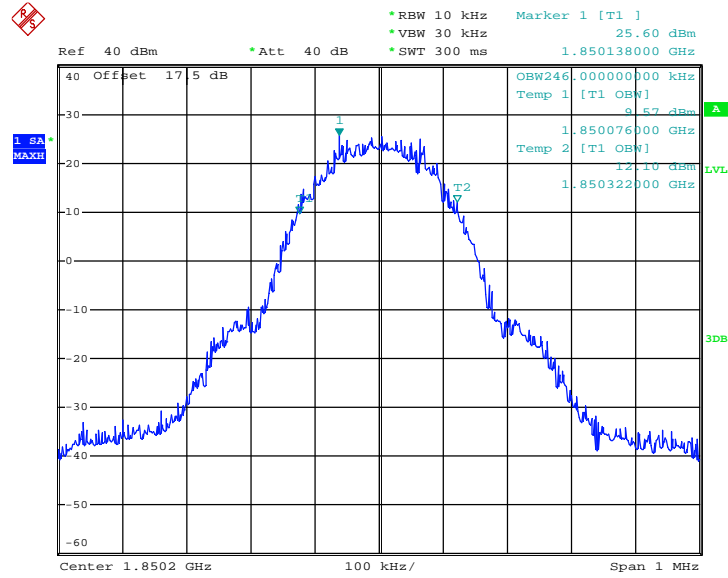

Date: 26.MAR.2013 09:38:14

26dB Bandwidth Plot on Channel 512 (1850.2 MHz)

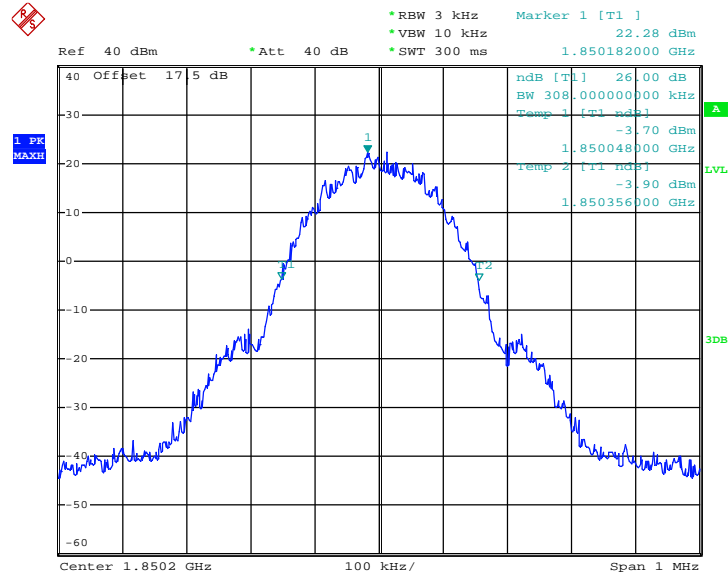

Date: 26.MAR.2013 09:31:43



99% Occupied Bandwidth Plot on Channel 661 (1880.0 MHz)

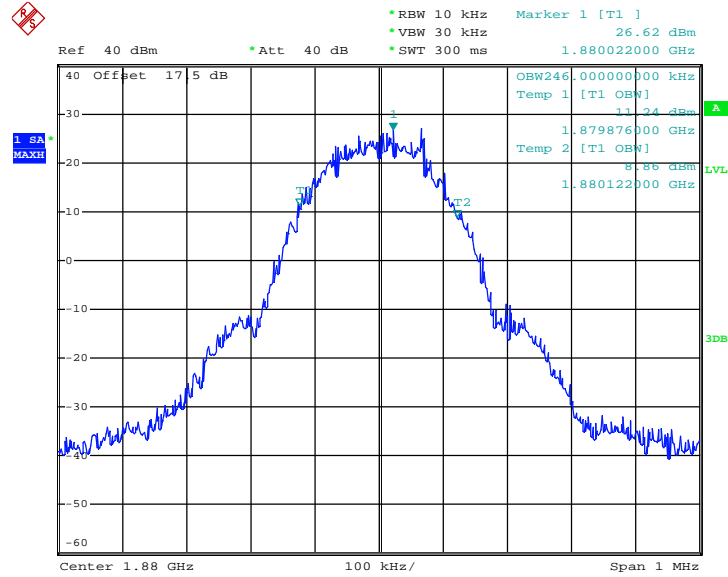

Date : 26.MAR.2013 09:36:45

26dB Bandwidth Plot on Channel 661 (1880.0 MHz)

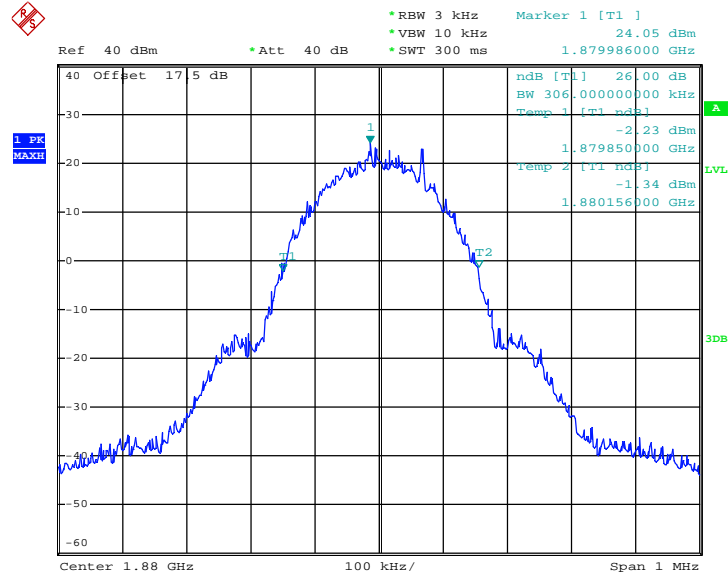

Date : 26.MAR.2013 09:30:54



### 99% Occupied Bandwidth Plot on Channel 810 (1909.8 MHz)

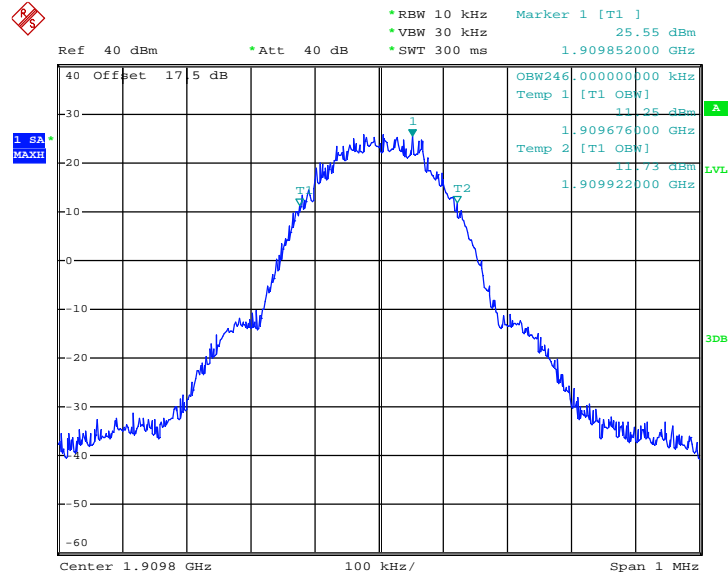

Date: 26.MAR.2013 09:35:23

### 26dB Bandwidth Plot on Channel 810 (1909.8 MHz)

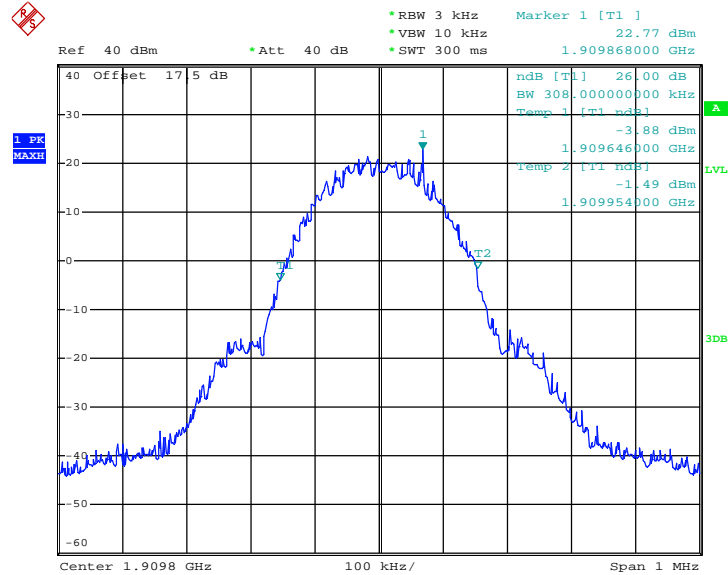

Date: 26.MAR.2013 09:32:38



Band :	GSM 1900	Test Mode :	EDGE 8 Link
--------	----------	-------------	-------------

99% Occupied Bandwidth Plot on Channel 512 (1850.2 MHz)

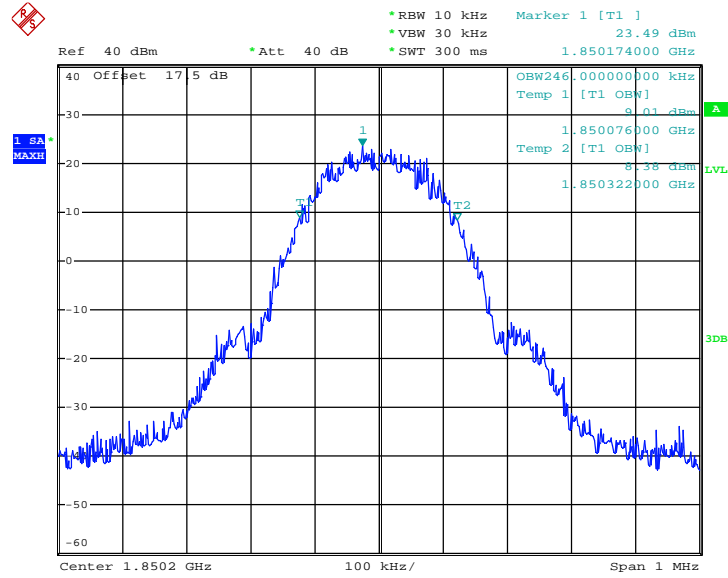

Date: 26.MAR.2013 16:18:09

26dB Bandwidth Plot on Channel 512 (1850.2 MHz)

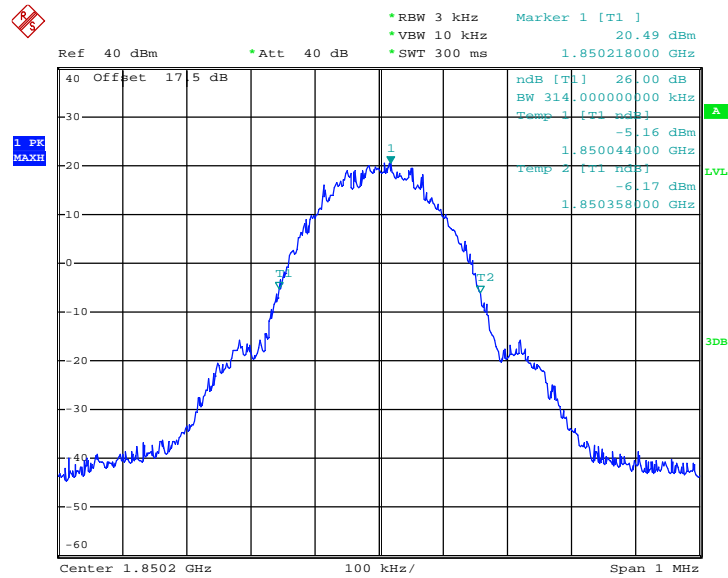

Date: 26.MAR.2013 16:12:32



### 99% Occupied Bandwidth Plot on Channel 661 (1880.0 MHz)

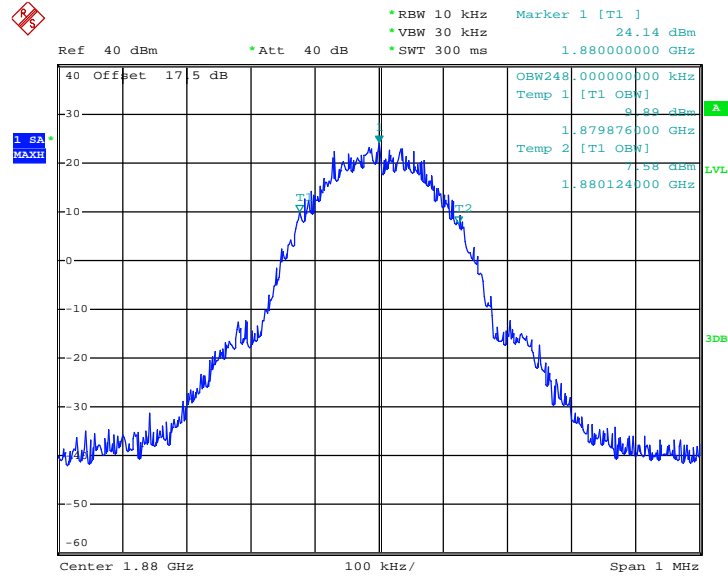

Date: 26.MAR.2013 16:17:12

### 26dB Bandwidth Plot on Channel 661 (1880.0 MHz)

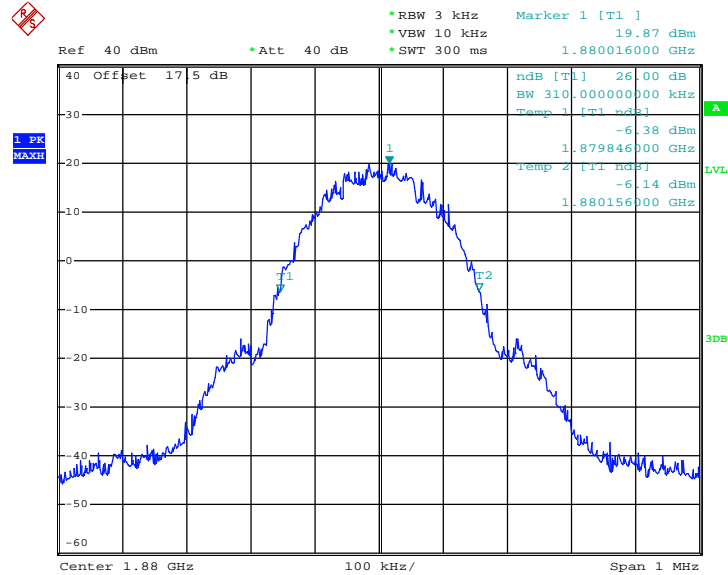

Date: 26.MAR.2013 16:13:24





99% Occupied Bandwidth Plot on Channel 810 (1909.8 MHz)

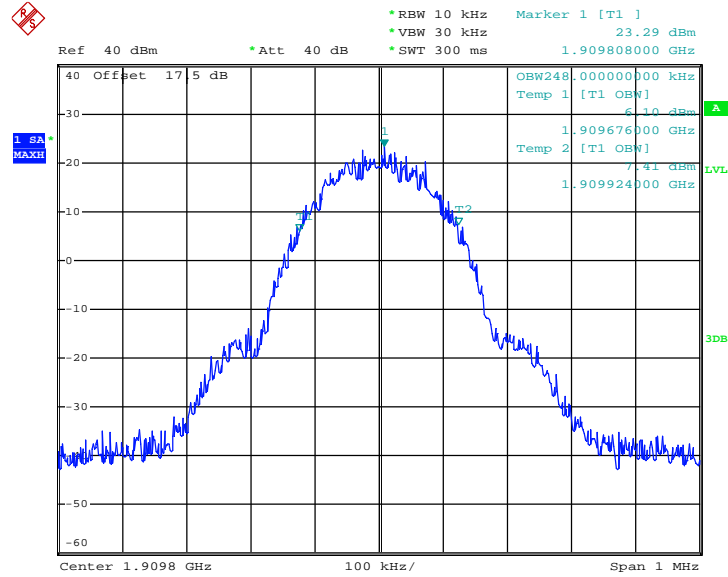

Date : 26.MAR.2013 16:16:15

26dB Bandwidth Plot on Channel 810 (1909.8 MHz)

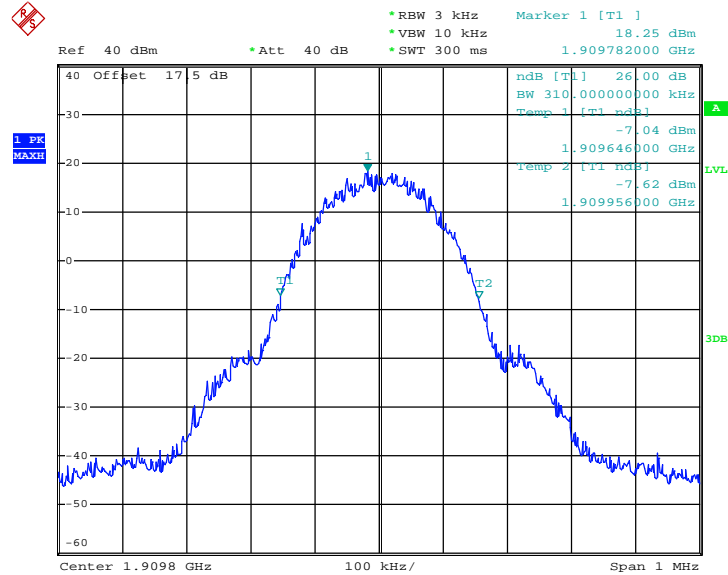

Date : 26.MAR.2013 16:14:23



Band :	WCDMA Band V	Test Mode :	RMC 12.2Kbps Link
--------	--------------	-------------	-------------------

99% Occupied Bandwidth Plot on Channel 4132 (826.4 MHz)

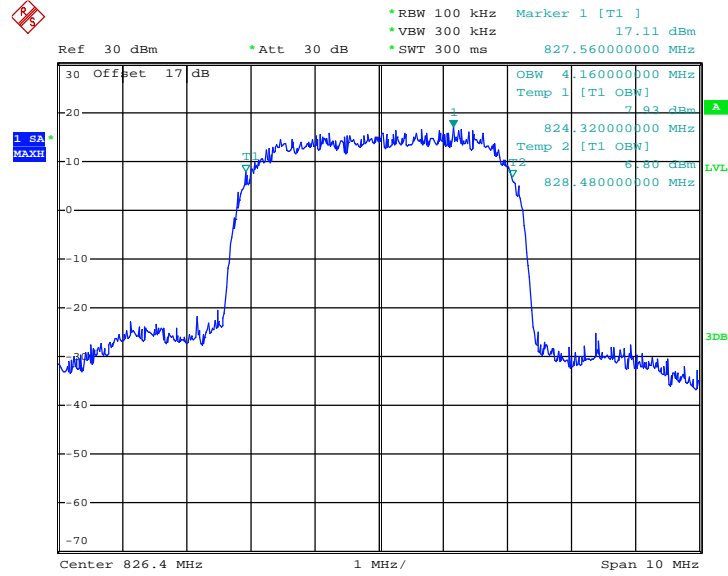

Date: 26.MAR.2013 14:45:11

26dB Bandwidth Plot on Channel 4132 (826.4 MHz)

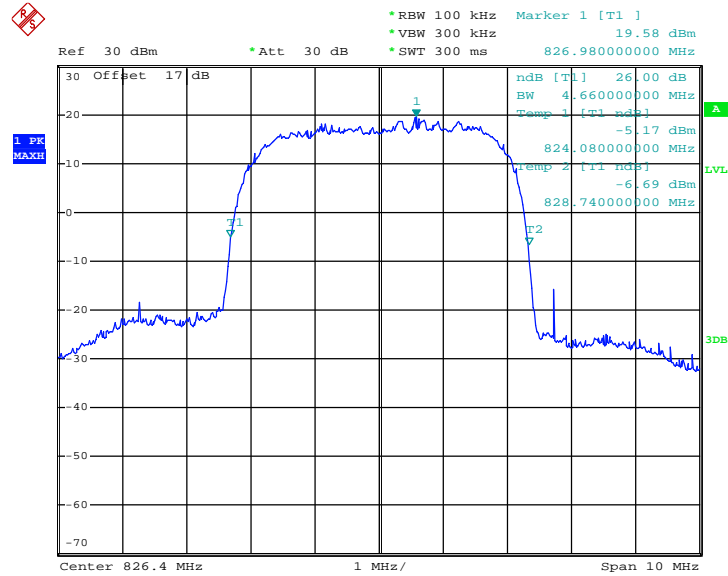

Date: 26.MAR.2013 14:52:04



99% Occupied Bandwidth Plot on Channel 4182 (836.4 MHz)

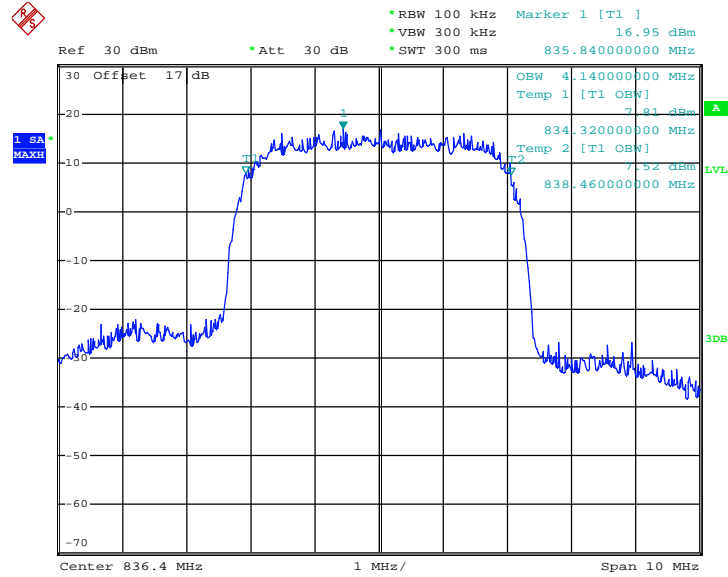

Date: 26.MAR.2013 14:44:24

26dB Bandwidth Plot on Channel 4182 (836.4 MHz)

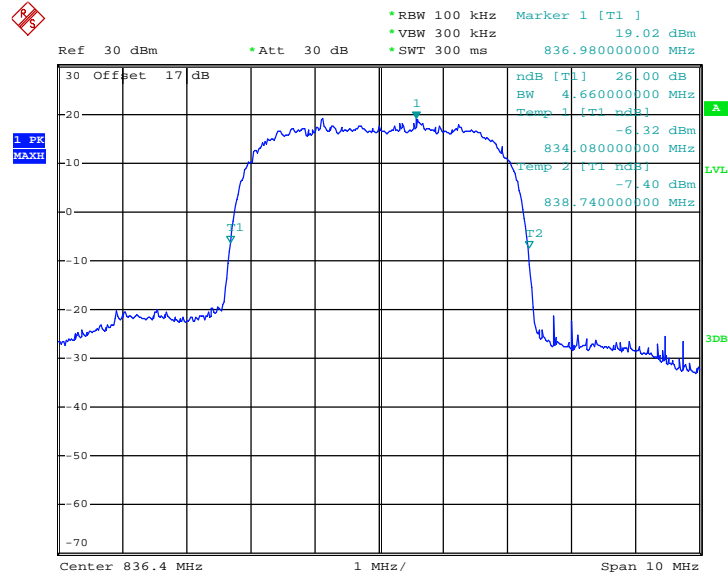

Date: 26.MAR.2013 14:56:04



99% Occupied Bandwidth Plot on Channel 4233 (846.6 MHz)

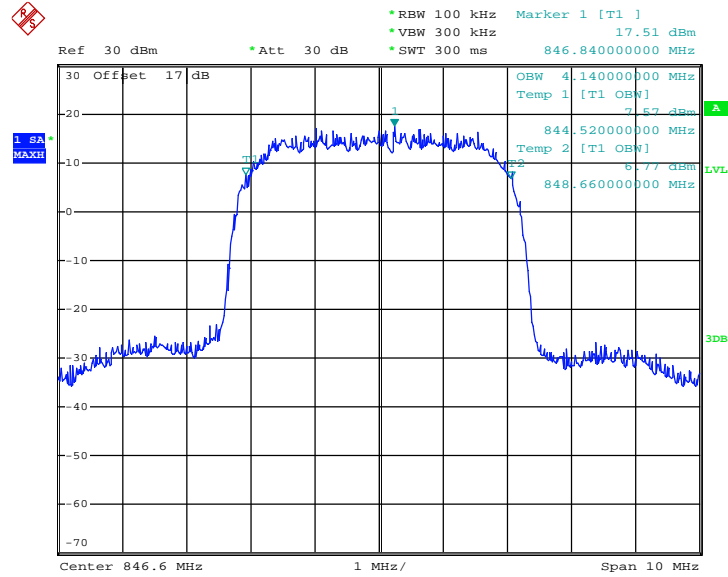

Date: 26.MAR.2013 14:43:36

26dB Bandwidth Plot on Channel 4233 (846.6 MHz)

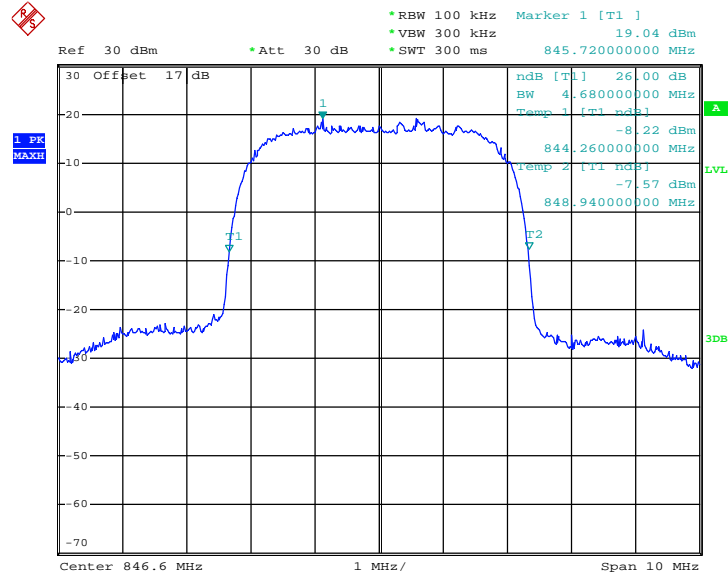

Date: 26.MAR.2013 14:56:37



Band :	WCDMA Band II	Test Mode :	RMC 12.2Kbps Link
--------	---------------	-------------	-------------------

99% Occupied Bandwidth Plot on Channel 9262 (1852.4 MHz)

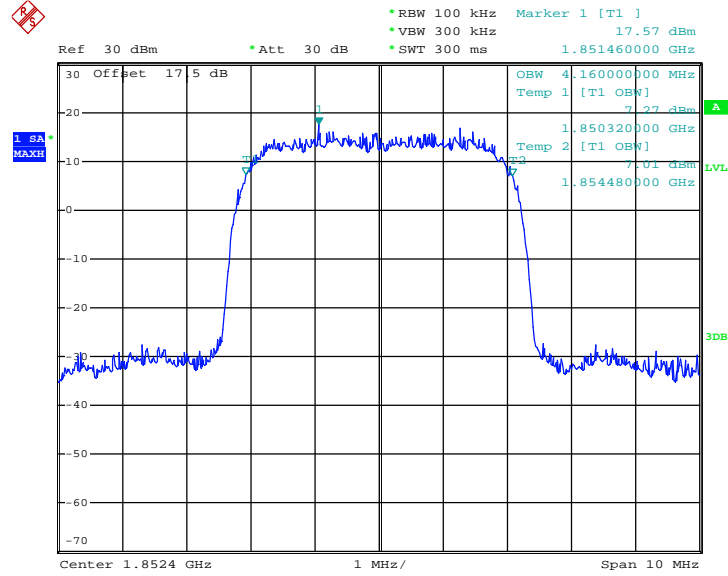

Date: 25.MAR.2013 19:51:54

26dB Bandwidth Plot on Channel 9262 (1852.4 MHz)

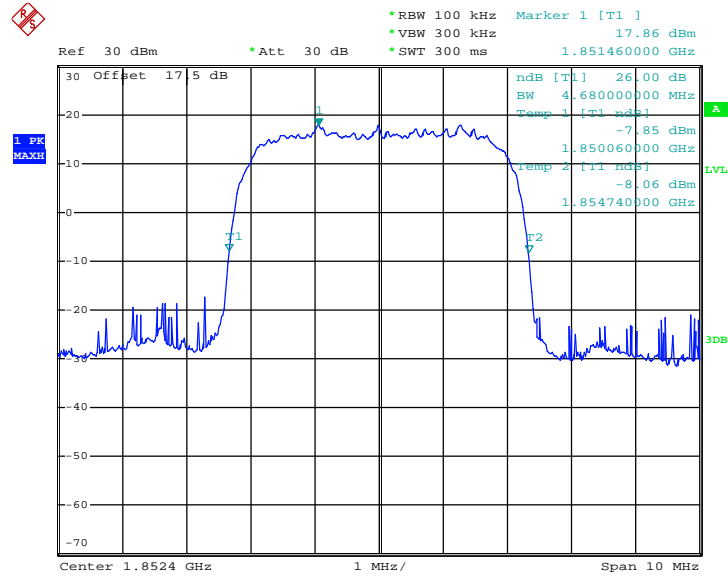

Date: 25.MAR.2013 19:45:10



99% Occupied Bandwidth Plot on Channel 9400 (1880.0 MHz)

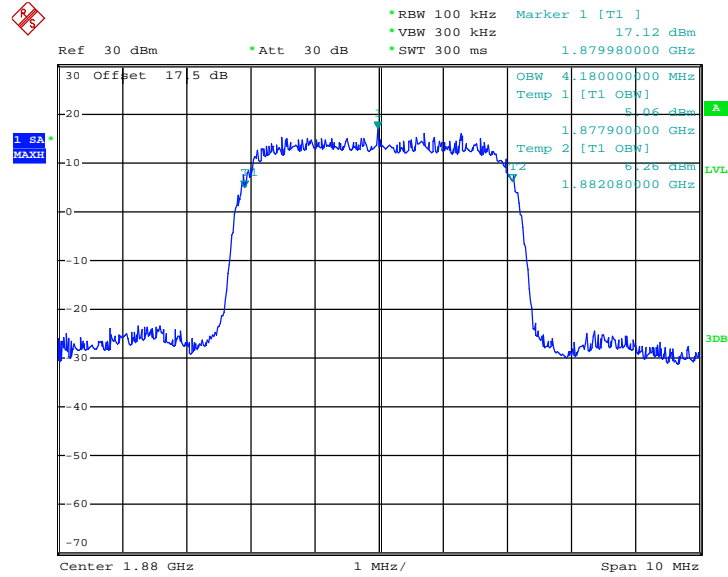

Date: 25.MAR.2013 19:50:49

26dB Bandwidth Plot on Channel 9400 (1880.0 MHz)

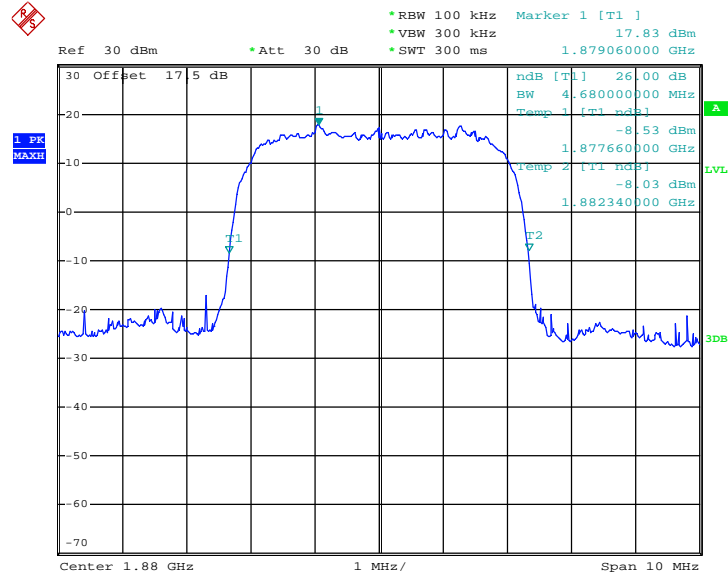

Date: 25.MAR.2013 19:44:14



99% Occupied Bandwidth Plot on Channel 9538 (1907.6 MHz)

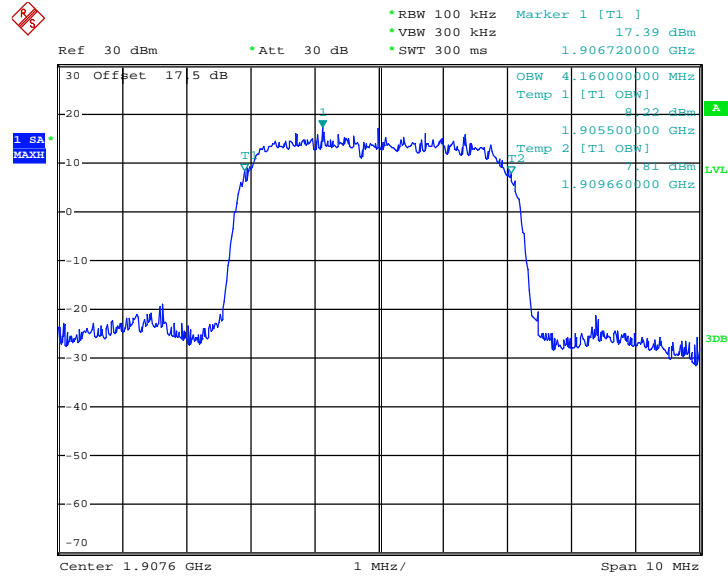

Date: 25.MAR.2013 19:48:00

26dB Bandwidth Plot on Channel 9538 (1907.6 MHz)

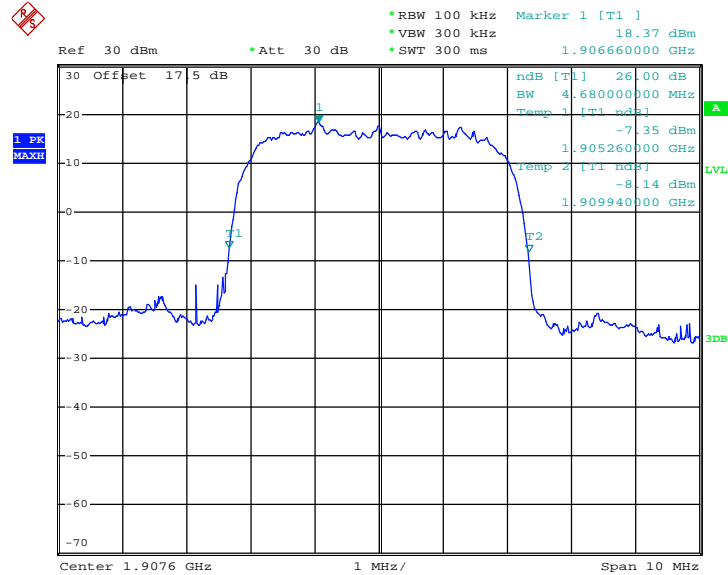

Date: 25.MAR.2013 19:46:15

## 3.5 Band Edge Measurement

### 3.5.1 Description of Band Edge Measurement

The power of any emission outside of the authorized operating frequency ranges must be lower than the transmitter power (P) by a factor of at least  $43 + 10 \log (P)$  dB.

### 3.5.2 Measuring Instruments

See list of measuring instruments of this test report.

### 3.5.3 Test Procedures

1. The EUT was connected to Spectrum Analyzer and Base Station via power divider.
2. The RF output of EUT was connected to the spectrum analyzer by RF cable and attenuator. The path loss was compensated to the results for each measurement.
3. The band edges of low and high channels for the highest RF powers were measured. Setting RBW as roughly  $BW/100$ .
4. The RF fundamental frequency should be excluded against the limit line in the operating frequency band.
5. The limit line is derived from  $43 + 10\log(P)$  dB below the transmitter power P(Watts)  
 $= P(W) - [43 + 10\log(P)] \text{ (dB)}$   
 $= [30 + 10\log(P)] \text{ (dBm)} - [43 + 10\log(P)] \text{ (dB)}$   
 $= -13\text{dBm}.$

### 3.5.4 Test Setup

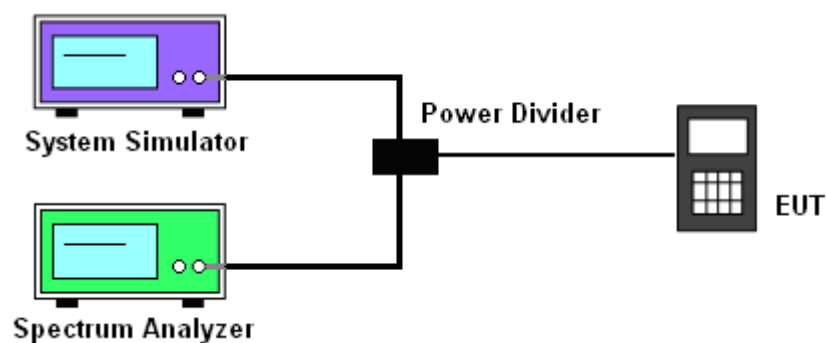



### 3.5.5 Test Result (Plots) of Conducted Band Edge

Band :	GSM850	Test Mode :	GSM Link
Correction Factor :	0.23dB	Maximum 26dB Bandwidth :	0.316MHz
Band Edge :	-16.62dBm	Measurement Value :	-16.85dBm

Lower Band Edge Plot on Channel 128 (824.2 MHz)

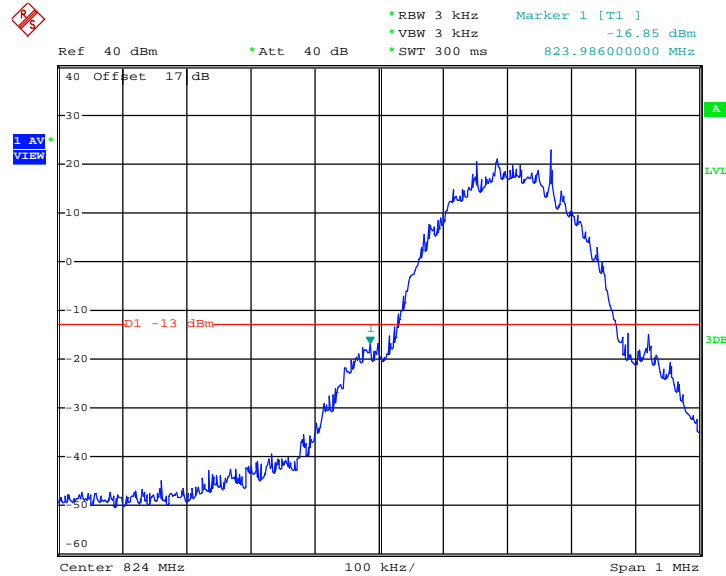

Date: 26.MAR.2013 10:05:49

1. Correction Factor(dB)=  $10\log(1\% \text{ Emission BW/RBW})$
  2. Band Edge= Measurement Value + Correction Factor(dB)
- For example,  $-16.85\text{dBm} + 0.23\text{dB} = -16.62\text{dBm}$



Band :	GSM850	Test Mode :	GSM Link
Correction Factor :	0.23dB	Maximum 26dB Bandwidth :	0.316MHz
Band Edge :	-15.37dBm	Measurement Value :	-15.60dBm

Higher Band Edge Plot on Channel 251 (848.8 MHz)

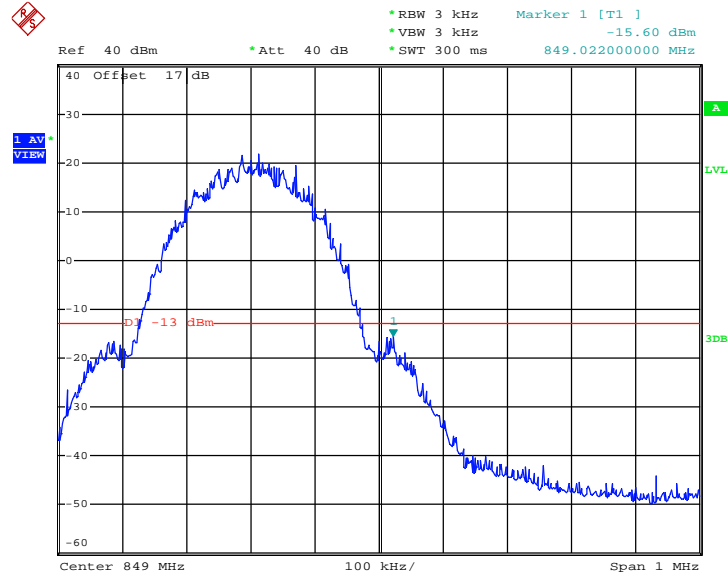

Date: 26.MAR.2013 10:03:34

1. Correction Factor(dB)= 10log(1% Emission BW/RBW)
2. Band Edge= Measurement Value + Correction Factor(dB)



Band :	GSM850	Test Mode :	EDGE 8 Link
Correction Factor :	0.20dB	Maximum 26dB Bandwidth :	0.314MHz
Band Edge :	-16.82dBm	Measurement Value :	-17.02dBm

Lower Band Edge Plot on Channel 128 (824.2 MHz)

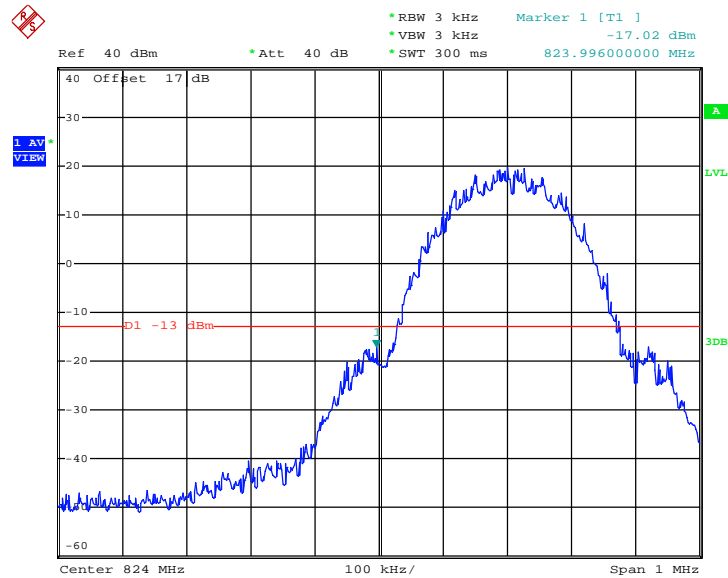

Date: 26.MAR.2013 15:52:09

1. Correction Factor(dB)= 10log(1% Emission BW/RBW)
2. Band Edge= Measurement Value + Correction Factor(dB)

Band :	GSM850	Test Mode :	EDGE 8 Link
Correction Factor :	0.20dB	Maximum 26dB Bandwidth :	0.314MHz
Band Edge :	-16.58dBm	Measurement Value :	-16.78dBm

Higher Band Edge Plot on Channel 251 (848.8 MHz)

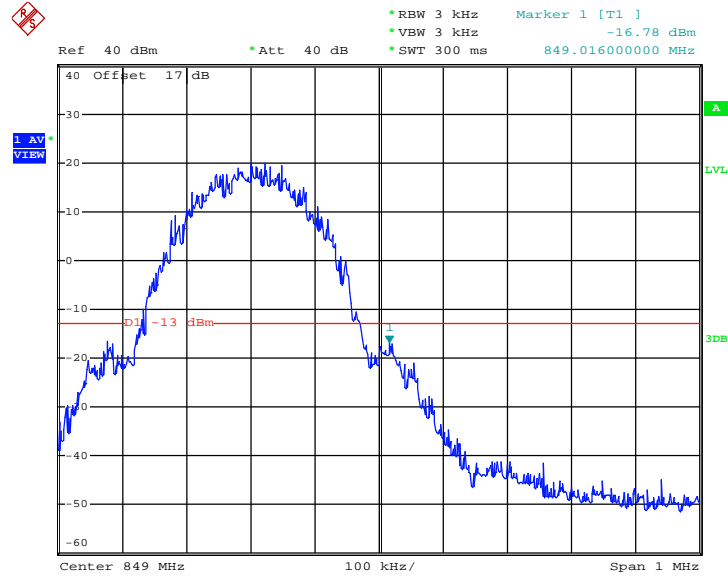

Date: 26.MAR.2013 15:53:11

1. Correction Factor(dB)=  $10\log(1\% \text{ Emission BW/RBW})$
2. Band Edge= Measurement Value + Correction Factor(dB)



Band :	GSM1900	Test Mode :	GSM Link
Correction Factor :	0.11dB	Maximum 26dB Bandwidth :	0.308MHz
Band Edge :	-20.20dBm	Measurement Value :	-20.31dBm

Lower Band Edge Plot on Channel 512 (1850.2 MHz)

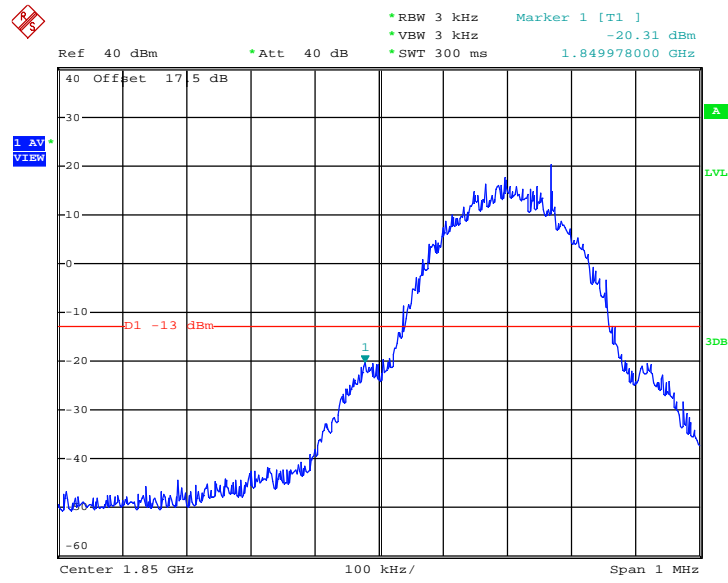

Date: 26.MAR.2013 09:52:03

1. Correction Factor(dB)= 10log(1% Emission BW/RBW)
2. Band Edge= Measurement Value + Correction Factor(dB)



Band :	GSM1900	Test Mode :	GSM Link
Correction Factor :	0.11dB	Maximum 26dB Bandwidth :	0.308MHz
Band Edge :	-20.02dBm	Measurement Value :	-20.13dBm

Higher Band Edge Plot on Channel 810 (1909.8 MHz)

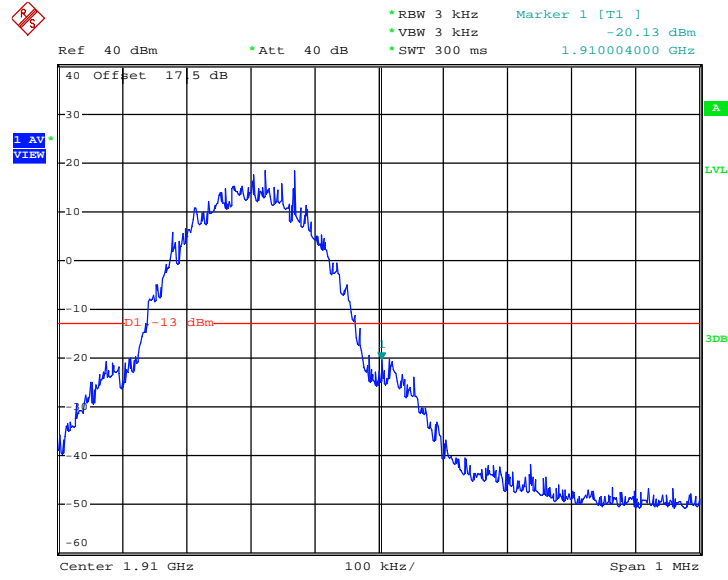

Date: 26.MAR.2013 09:50:57

1. Correction Factor(dB)= 10log(1% Emission BW/RBW)
2. Band Edge= Measurement Value + Correction Factor(dB)

Band :	GSM1900	Test Mode :	EDGE 8 Link
Correction Factor :	0.20dB	Maximum 26dB Bandwidth :	0.314MHz
Band Edge :	-22.42dBm	Measurement Value :	-22.62dBm

Lower Band Edge Plot on Channel 512 (1850.2 MHz)

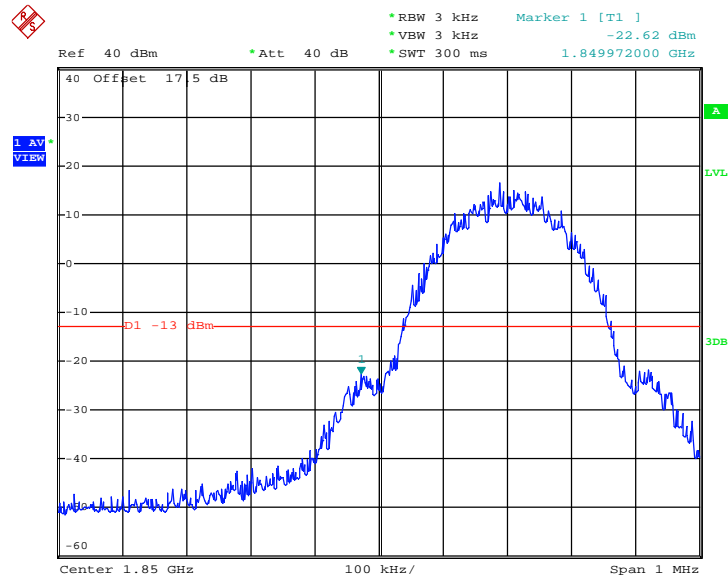

Date: 26.MAR.2013 16:24:20

1. Correction Factor(dB)= 10log(1% Emission BW/RBW)
2. Band Edge= Measurement Value + Correction Factor(dB)



Band :	GSM1900	Test Mode :	EDGE 8 Link
Correction Factor :	0.20dB	Maximum 26dB Bandwidth :	0.314MHz
Band Edge :	-22.86dBm	Measurement Value :	-23.06dBm

Higher Band Edge Plot on Channel 810 (1909.8 MHz)

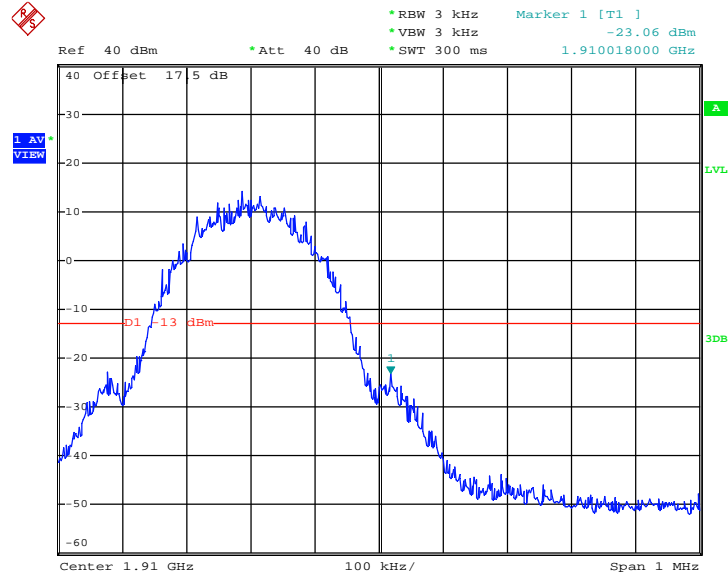

Date: 26.MAR.2013 16:22:59

1. Correction Factor(dB)= 10log(1% Emission BW/RBW)
2. Band Edge= Measurement Value + Correction Factor(dB)





Band :	WCDMA Band V	Test Mode :	RMC 12.2Kbps Link
Correction Factor :	-3.30dB	Maximum 26dB Bandwidth :	4.68MHz
Band Edge :	-30.19dBm	Measurement Value :	-26.89dBm

Lower Band Edge Plot on Channel 4132 (826.4 MHz)

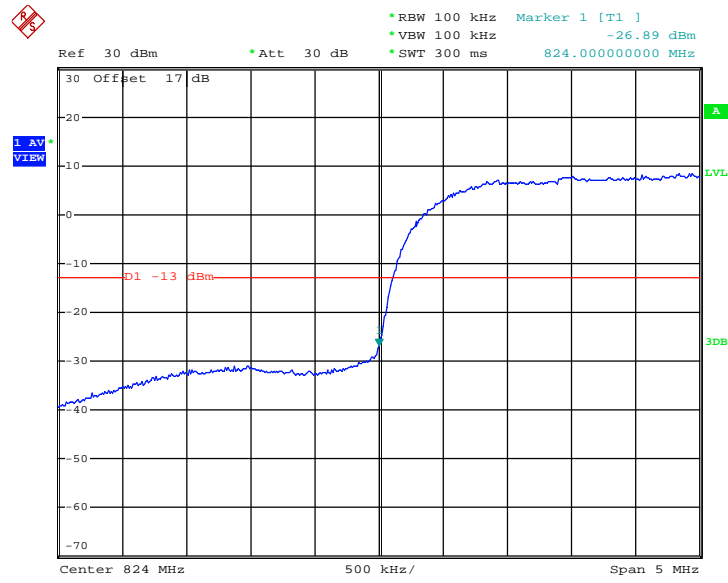

Date: 26.MAR.2013 14:47:03

1. Correction Factor(dB)=  $10\log(1\% \text{ Emission BW/RBW})$
2. Band Edge= Measurement Value + Correction Factor(dB)



Band :	WCDMA Band V	Test Mode :	RMC 12.2Kbps Link
Correction Factor :	-3.30dB	Maximum 26dB Bandwidth :	4.68MHz
Band Edge :	-31.28dBm	Measurement Value :	-27.98dBm

Higher Band Edge Plot on Channel 4233 (846.6 MHz)

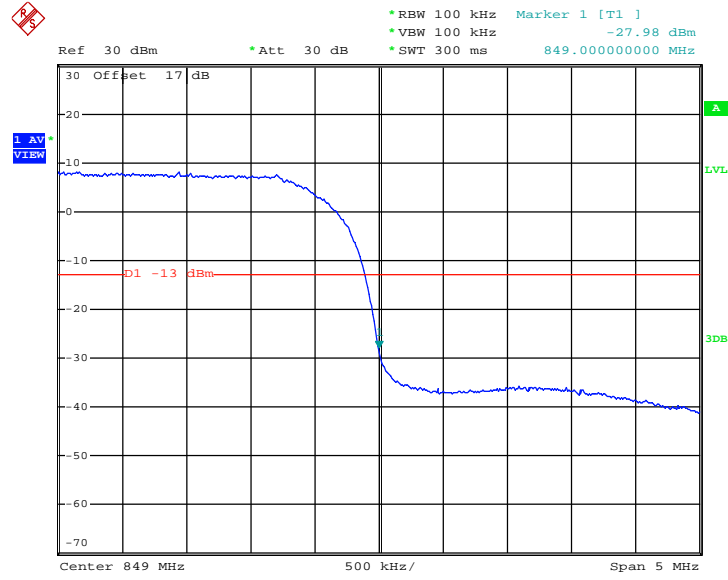

Date: 26.MAR.2013 14:47:59

1. Correction Factor(dB)=  $10\log(1\% \text{ Emission BW/RBW})$
2. Band Edge= Measurement Value + Correction Factor(dB)



Band :	WCDMA Band II	Test Mode :	RMC 12.2Kbps Link
Correction Factor :	-3.30dB	Maximum 26dB Bandwidth :	4.68MHz
Band Edge :	-31.29dBm	Measurement Value :	-27.99dBm

Lower Band Edge Plot on Channel 9262 (1852.4 MHz)

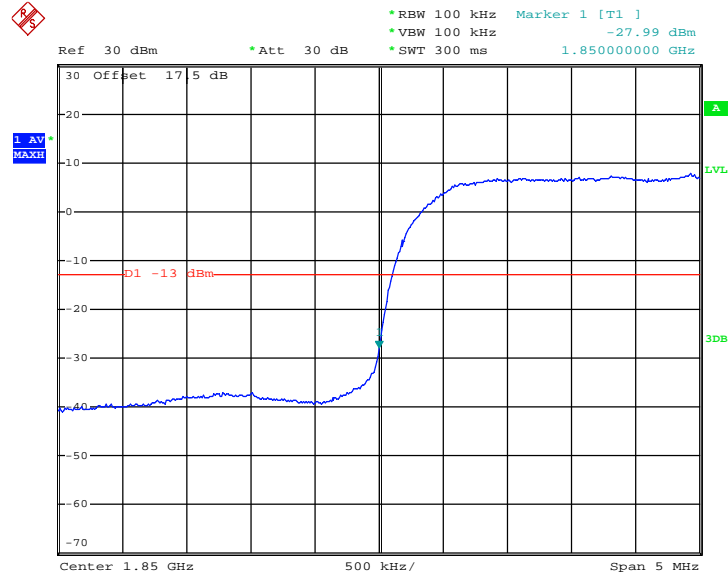

Date: 25.MAR.2013 19:56:08

1. Correction Factor(dB)=  $10\log(1\% \text{ Emission BW/RBW})$
2. Band Edge= Measurement Value + Correction Factor(dB)



Band :	WCDMA Band II	Test Mode :	RMC 12.2Kbps Link
Correction Factor :	-3.30dB	Maximum 26dB Bandwidth :	4.68MHz
Band Edge :	-30.09dBm	Measurement Value :	-26.79dBm

Higher Band Edge Plot on Channel 9538 (1907.6 MHz)

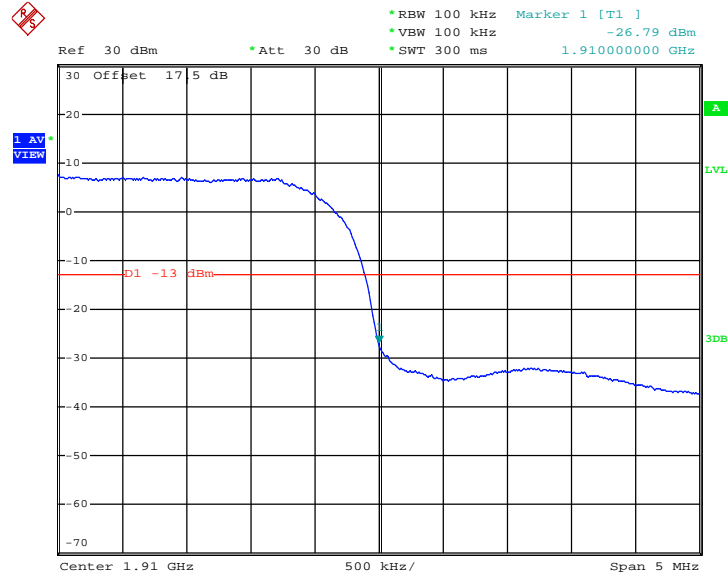

Date: 25.MAR.2013 20:00:26

1. Correction Factor(dB)=  $10\log(1\% \text{ Emission BW/RBW})$
2. Band Edge= Measurement Value + Correction Factor(dB)

### 3.6 Conducted Spurious Emission Measurement

#### 3.6.1 Description of Conducted Spurious Emission Measurement

The power of any emission outside of the authorized operating frequency ranges must be lower than the transmitter power (P) by a factor of at least  $43 + 10 \log (P)$  dB.

It is measured by means of a calibrated spectrum analyzer and scanned from 30 MHz up to a frequency including its 10<sup>th</sup> harmonic.

#### 3.6.2 Measuring Instruments

See list of measuring instruments of this test report.

#### 3.6.3 Test Procedures

1. The EUT was connected to spectrum analyzer and base station via power divider.
2. The RF output of EUT was connected to the spectrum analyzer by RF cable and attenuator. The path loss was compensated to the results for each measurement.
3. The middle channel for the highest RF power within the transmitting frequency was measured.
4. The conducted spurious emission for the whole frequency range was taken.
5. The RF fundamental frequency should be excluded against the limit line in the operating frequency band.
6. The limit line is derived from  $43 + 10\log(P)$  dB below the transmitter power P(Watts)
  - =  $P(W) - [43 + 10\log(P)]$  (dB)
  - =  $[30 + 10\log(P)]$  (dBm) -  $[43 + 10\log(P)]$  (dB)
  - = -13dBm.

#### 3.6.4 Test Setup

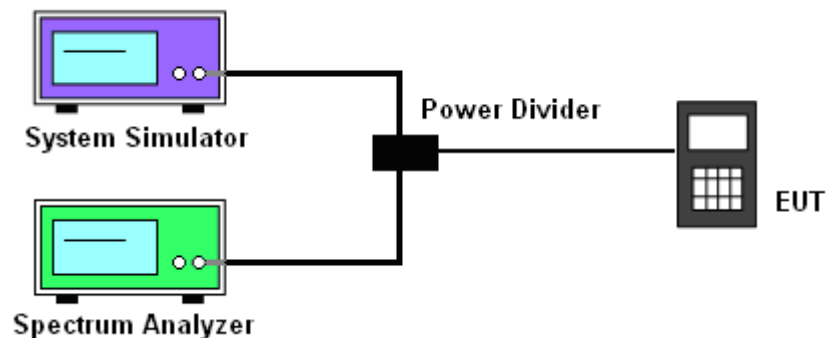



### 3.6.5 Test Result (Plots) of Conducted Spurious Emission

Band :	GSM850	Channel :	CH189
Test Mode :	GSM Link	Frequency :	836.4 MHz

Conducted Spurious Emission Plot between 30MHz ~ 1GHz

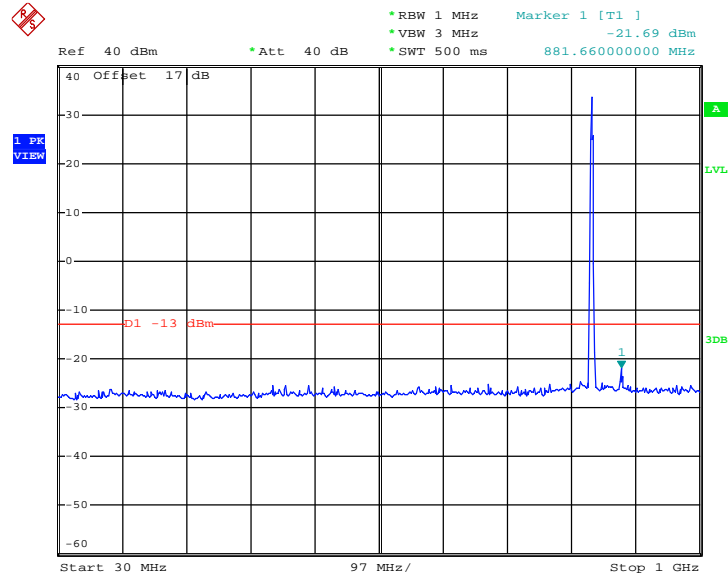

Date: 27.MAR.2013 17:50:10

Conducted Spurious Emission Plot between 1GHz ~ 3GHz

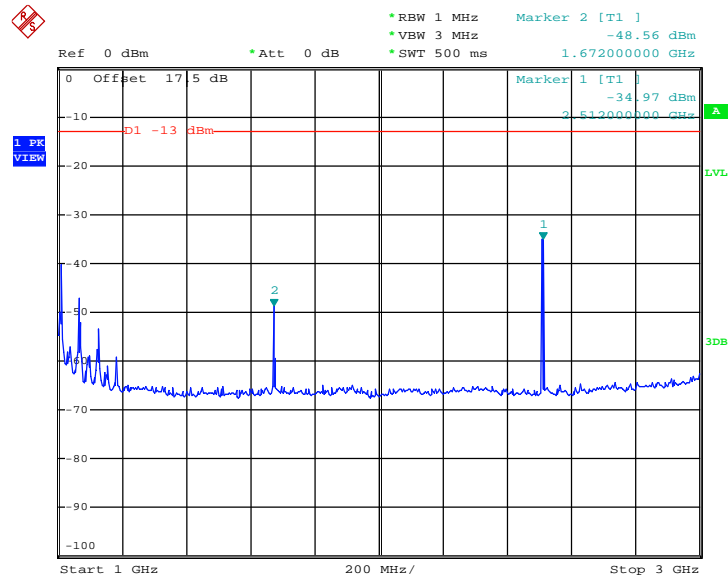

Date: 27.MAR.2013 17:54:44



### Conducted Spurious Emission Plot between 3GHz ~ 7GHz

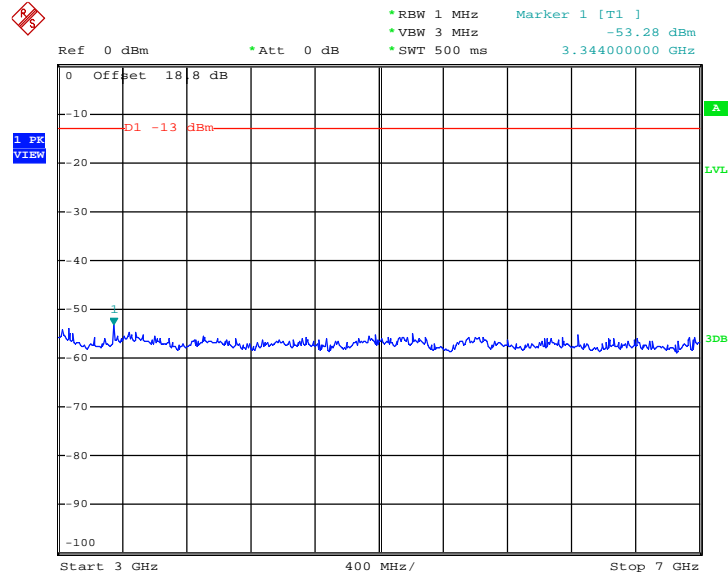

Date: 27.MAR.2013 17:55:37

### Conducted Spurious Emission Plot between 7GHz ~ 9GHz

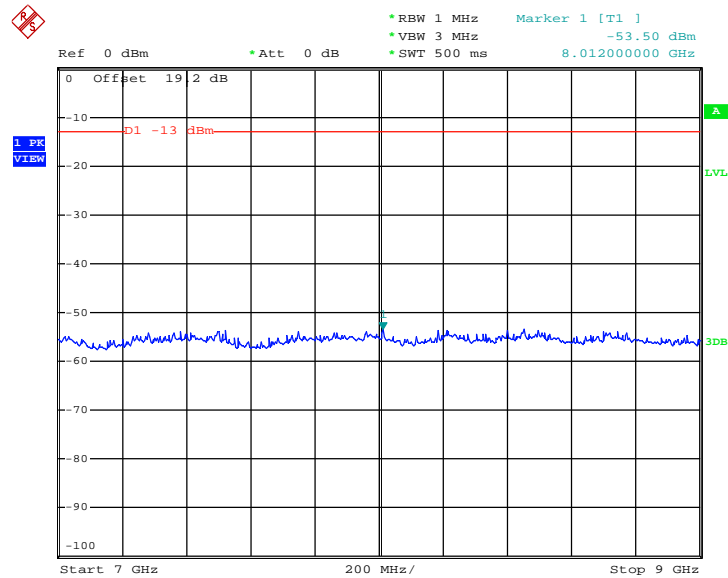

Date: 27.MAR.2013 17:56:35



Band :	GSM850	Channel :	CH189
Test Mode :	EDGE 8 Link	Frequency :	836.4 MHz

Conducted Spurious Emission Plot between 30MHz ~ 1GHz

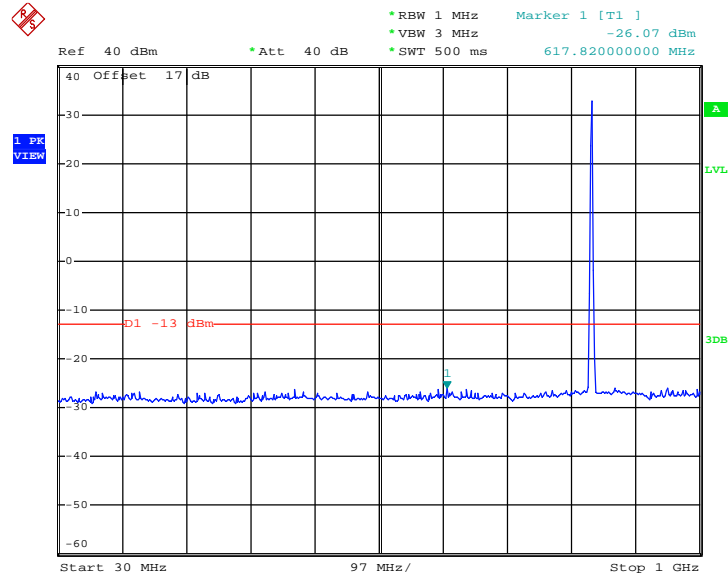

Date: 26.MAR.2013 15:57:41

Conducted Spurious Emission Plot between 1GHz ~ 3GHz

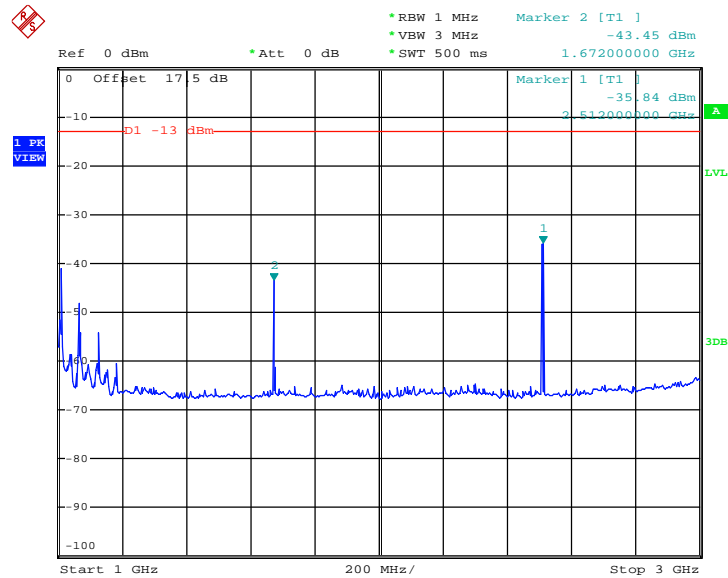

Date: 26.MAR.2013 16:02:32



Conducted Spurious Emission Plot between 3GHz ~ 7GHz

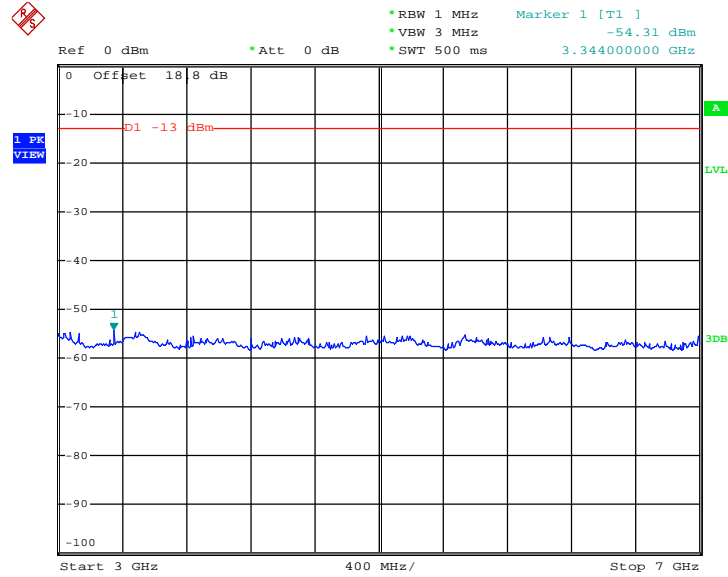

Date: 26.MAR.2013 16:04:37

Conducted Spurious Emission Plot between 7GHz ~ 9GHz

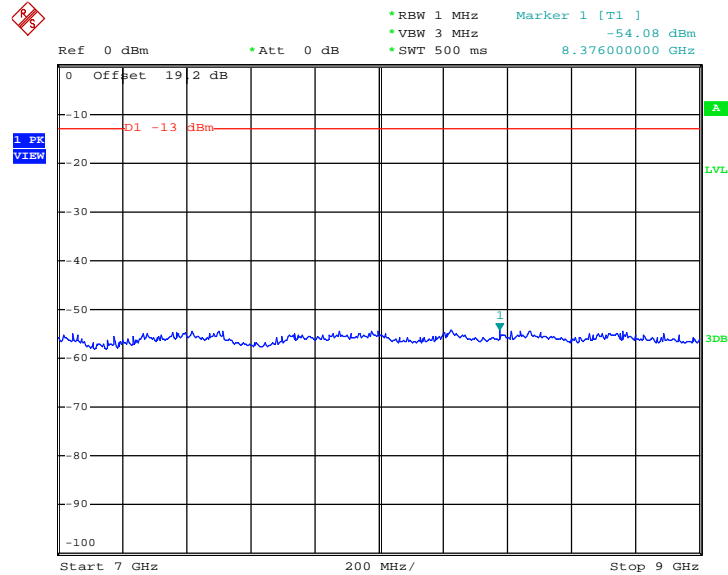

Date: 26.MAR.2013 16:06:22



Band :	GSM1900	Channel :	CH661
Test Mode :	GSM Link	Frequency :	1880.0 MHz

Conducted Spurious Emission Plot between 30MHz ~ 1GHz

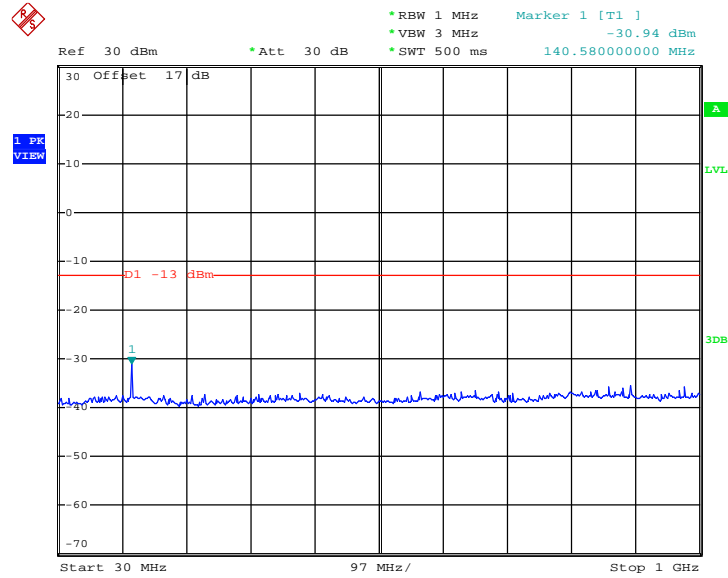

Date: 26.MAR.2013 09:27:35

Conducted Spurious Emission Plot between 1GHz ~ 3GHz

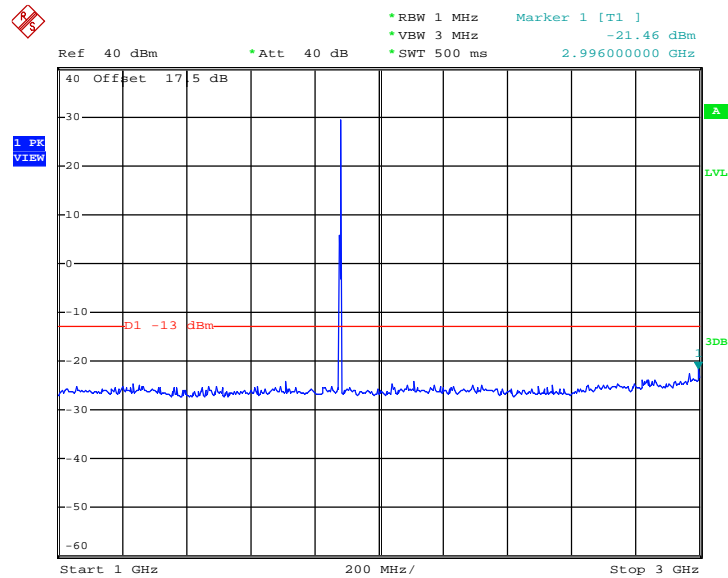

Date: 26.MAR.2013 09:28:23



### Conducted Spurious Emission Plot between 3GHz ~ 7GHz

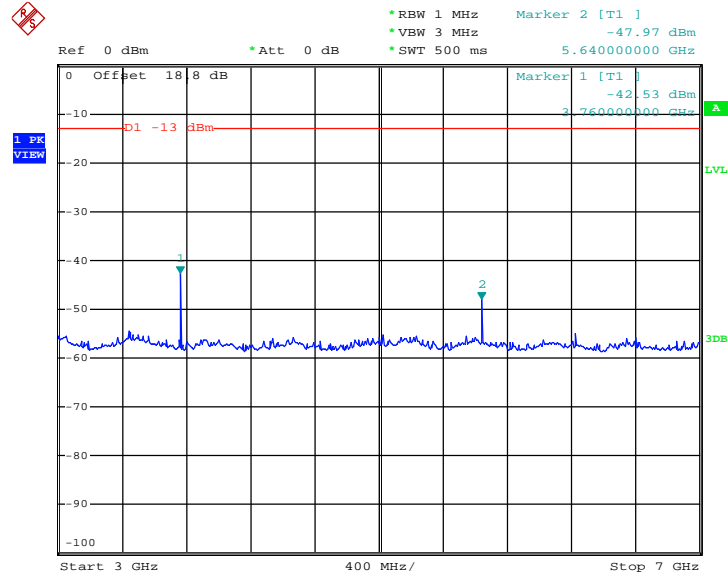

Date: 26.MAR.2013 09:25:35

### Conducted Emission Plot between 7GHz ~ 13.6GHz

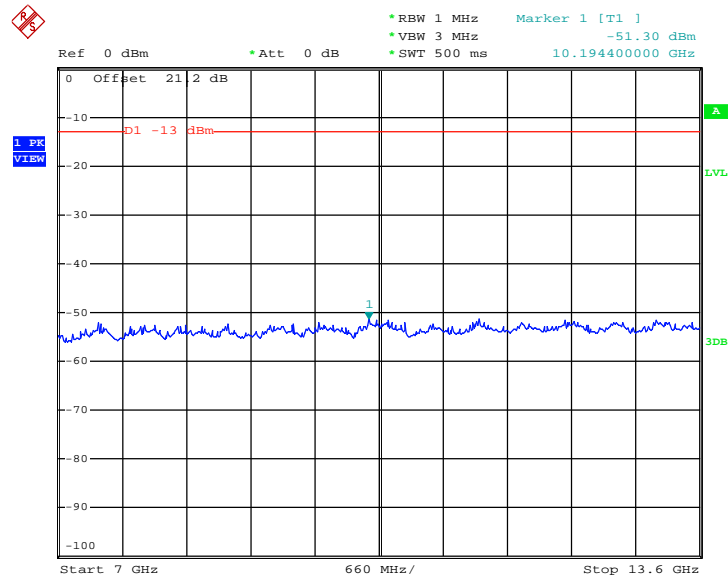

Date: 26.MAR.2013 09:24:38



Conducted Spurious Emission Plot between 13.6GHz ~ 19.1GHz

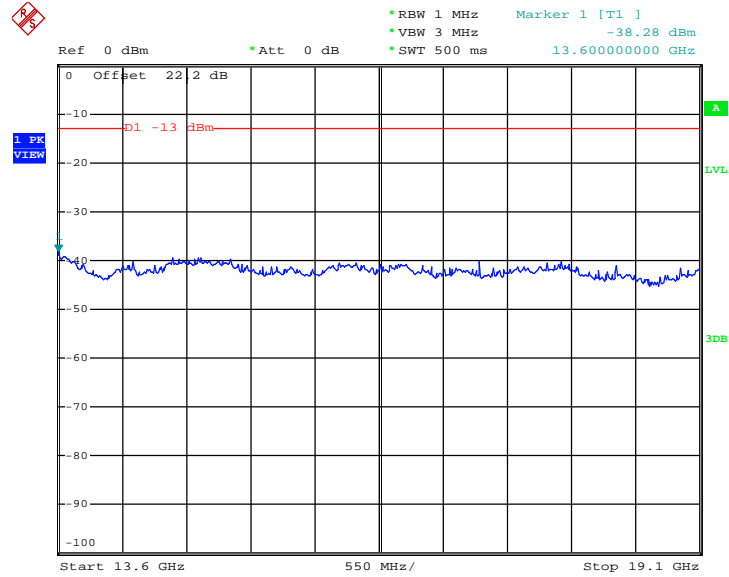

Date: 26.MAR.2013 09:23:53



Band :	GSM1900	Channel :	CH661
Test Mode :	EDGE 8 Link	Frequency :	1880.0 MHz

Conducted Spurious Emission Plot between 30MHz ~ 1GHz

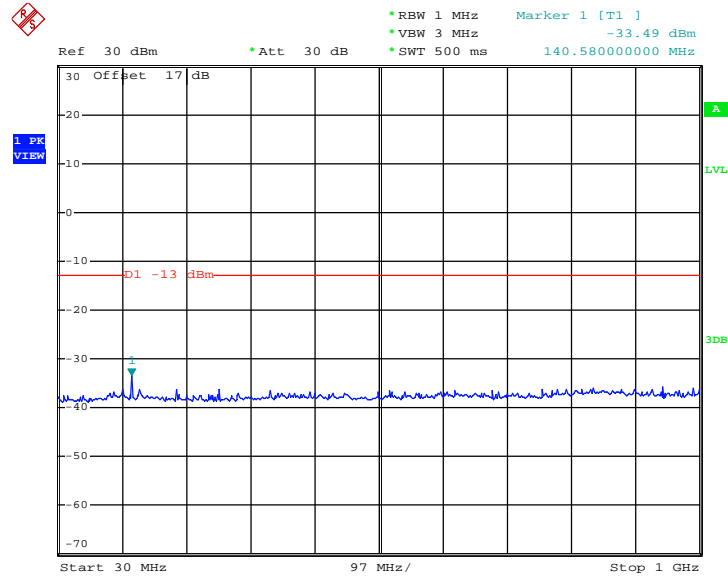

Date: 26.MAR.2013 16:28:59

Conducted Spurious Emission Plot between 1GHz ~ 3GHz

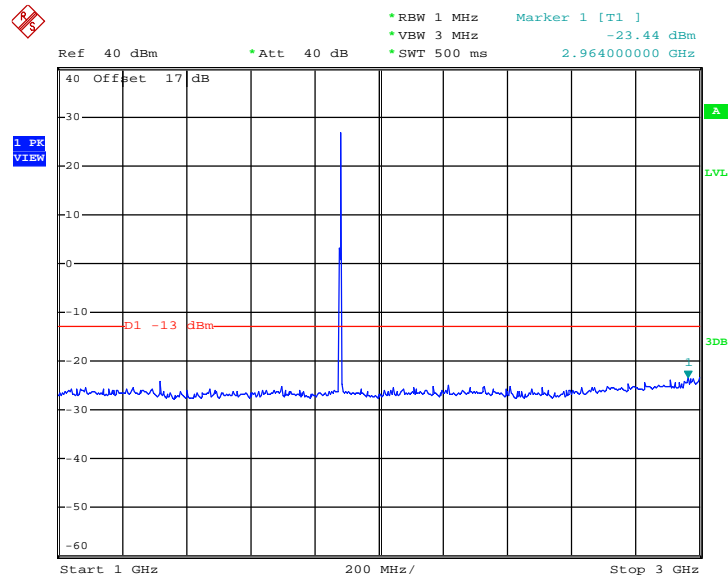

Date: 26.MAR.2013 16:30:30



### Conducted Spurious Emission Plot between 3GHz ~ 7GHz

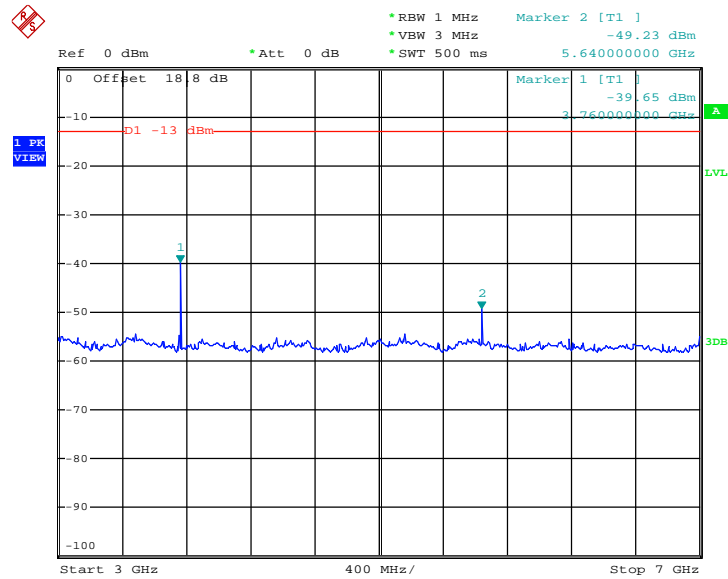

Date: 26.MAR.2013 16:33:35

### Conducted Spurious Emission Plot between 7GHz ~ 13.6GHz

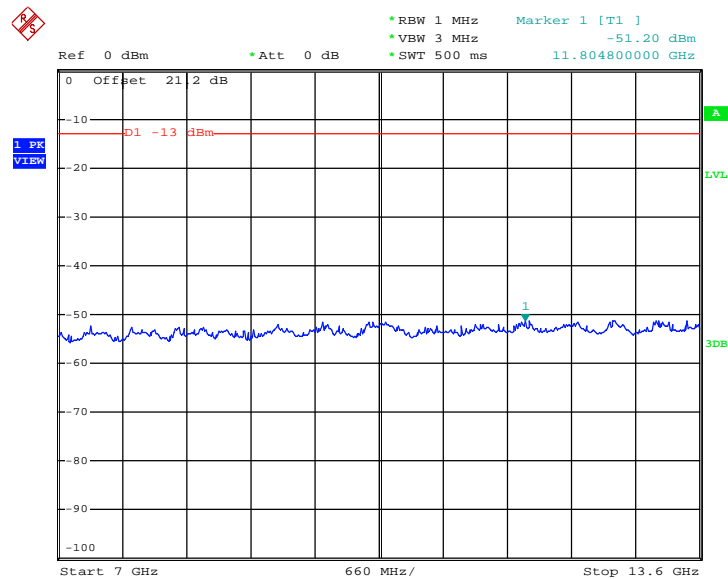

Date: 26.MAR.2013 16:35:38



Conducted Spurious Emission Plot between 13.6GHz ~ 19.1GHz

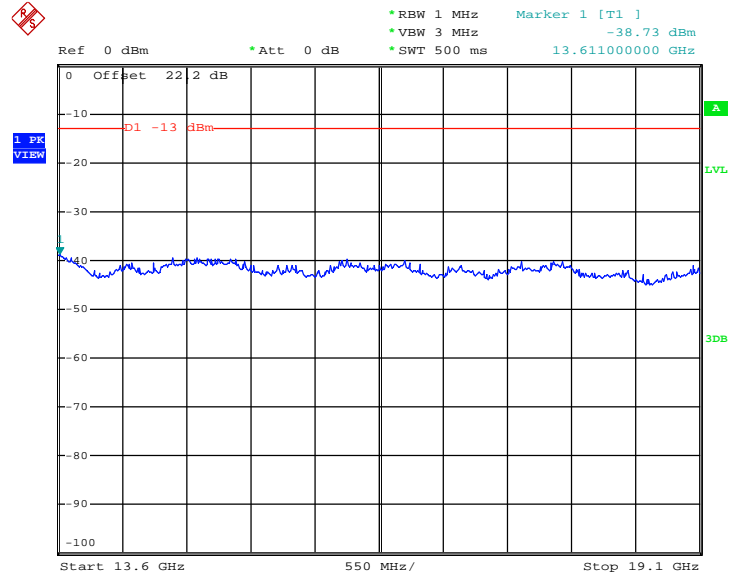

Date: 26.MAR.2013 16:36:34



Band :	WCDMA Band V	Channel :	CH4182
Test Mode :	RMC 12.2Kbps Link	Frequency :	836.4 MHz

Conducted Spurious Emission Plot between 30MHz ~ 1GHz

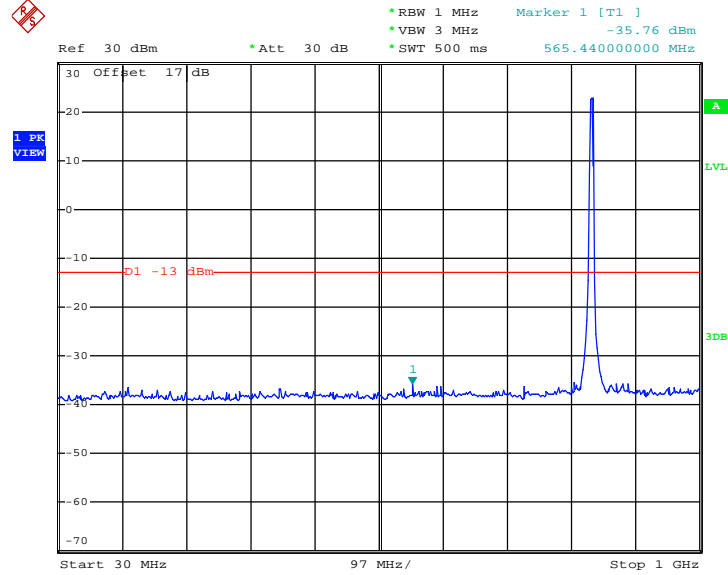

Date: 26.MAR.2013 15:03:24

Conducted Spurious Emission Plot between 1GHz ~ 3GHz

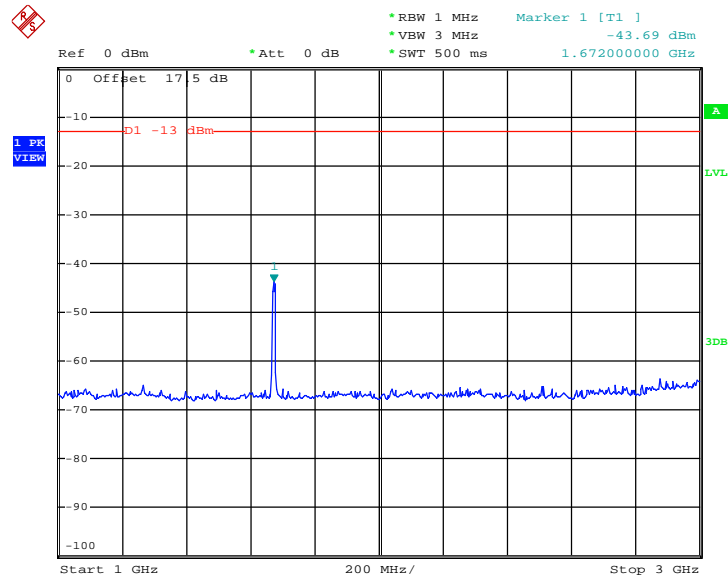

Date: 26.MAR.2013 15:07:04





### Conducted Spurious Emission Plot between 3GHz ~ 7GHz

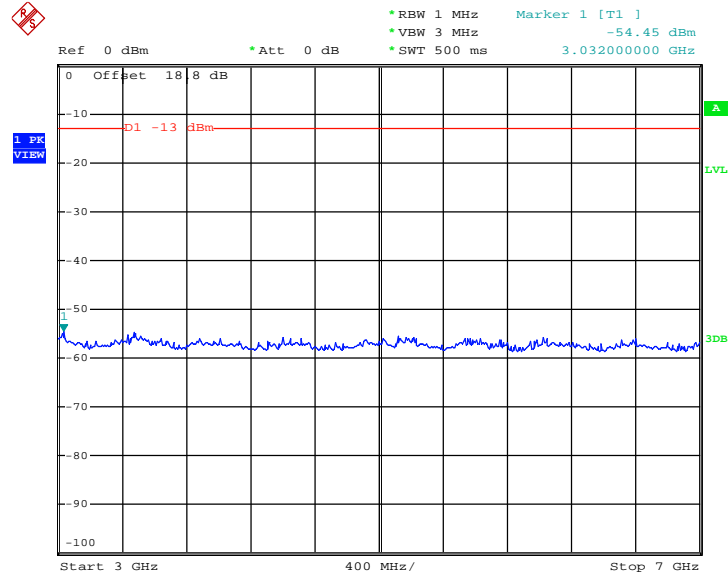

Date: 26.MAR.2013 15:18:09

### Conducted Spurious Emission Plot between 7GHz ~ 9GHz

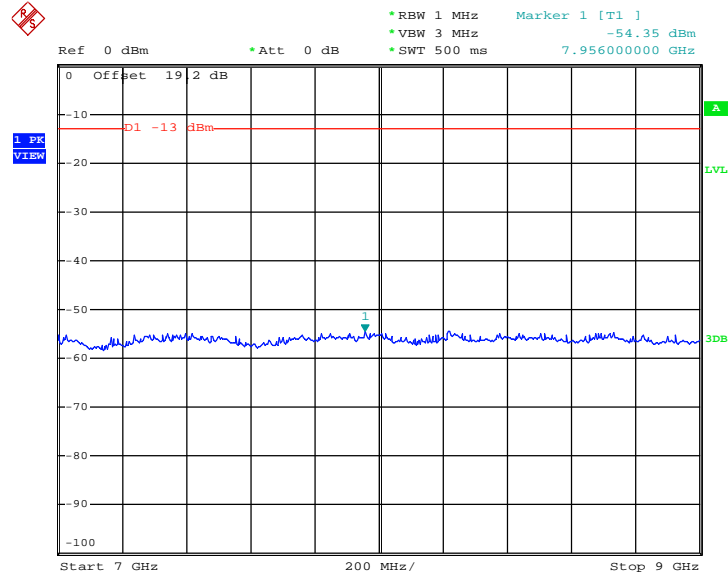

Date: 26.MAR.2013 15:19:27



Band :	WCDMA Band II	Channel :	CH9400
Test Mode :	RMC 12.2Kbps Link	Frequency :	1880.0 MHz

Conducted Spurious Emission Plot between 30MHz ~ 1GHz

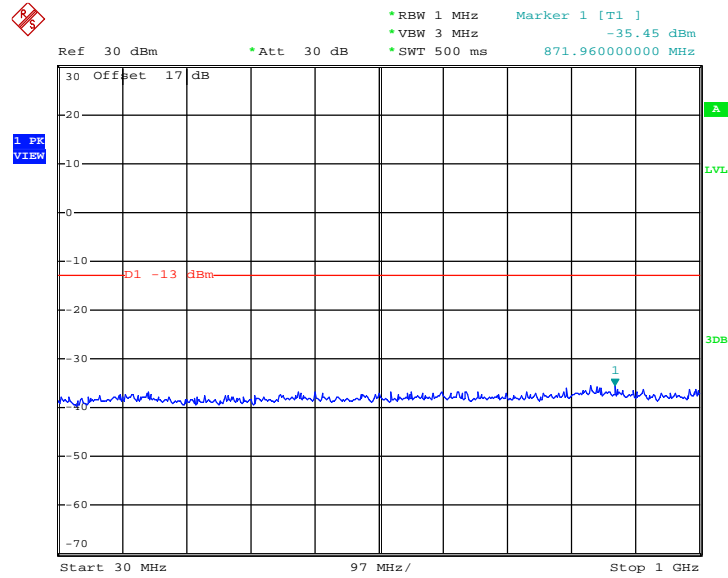

Date: 26.MAR.2013 09:10:58

Conducted Spurious Emission Plot between 1GHz ~ 3GHz

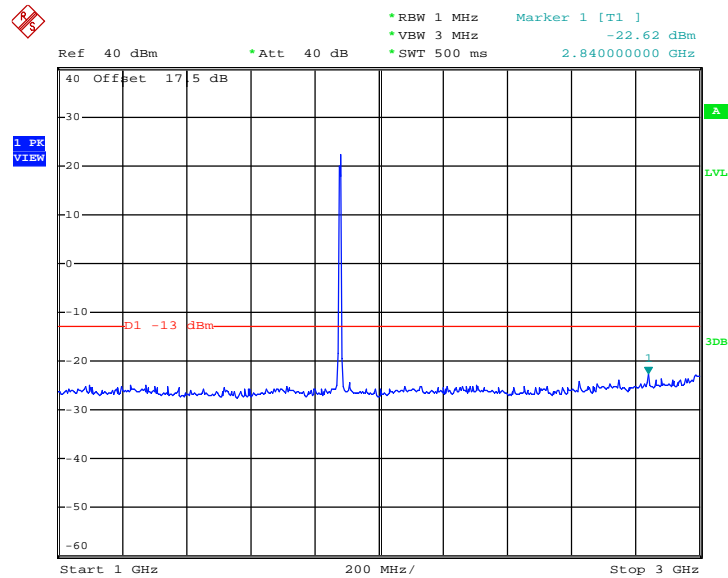

Date: 26.MAR.2013 09:11:44



### Conducted Spurious Emission Plot between 3GHz ~ 7GHz

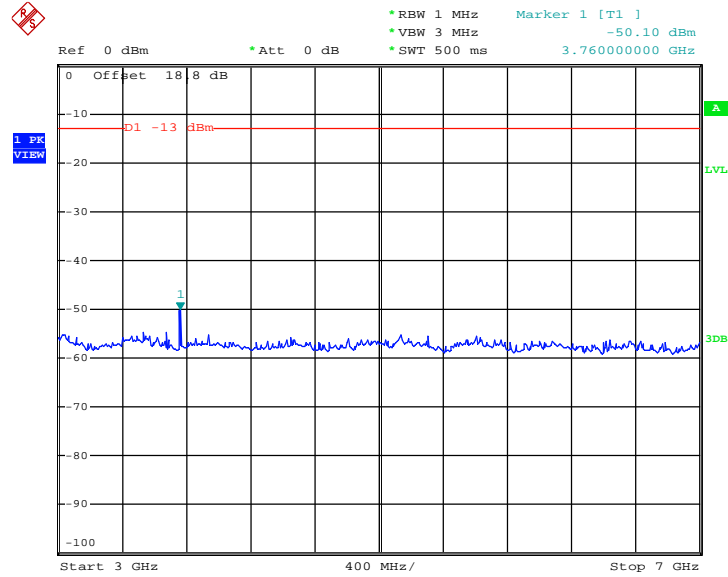

Date: 26.MAR.2013 09:17:23

### Conducted Spurious Emission Plot between 7GHz ~ 13.6GHz

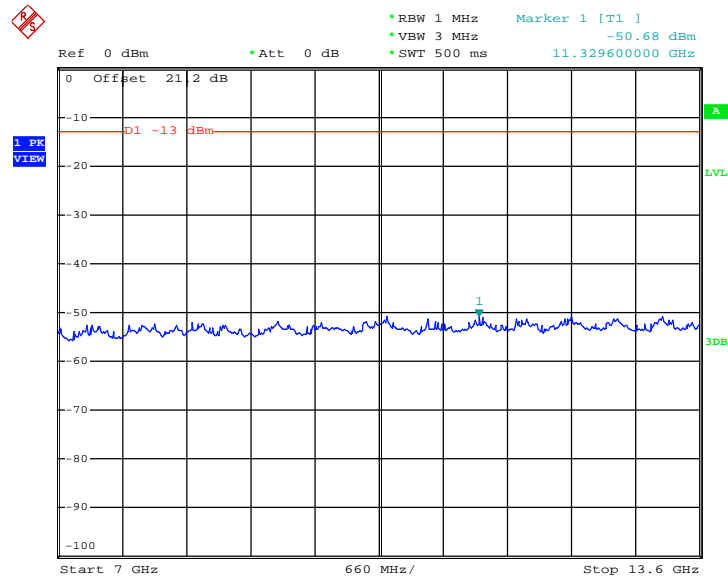

Date: 26.MAR.2013 09:18:15



Conducted Spurious Emission Plot between 13.6GHz ~ 19.1GHz

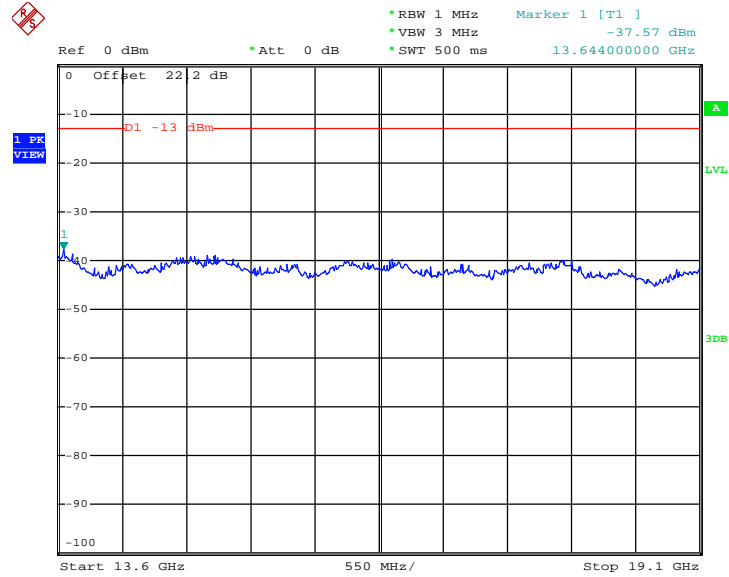

Date: 26.MAR.2013 09:18:54

## 3.7 Field Strength of Spurious Radiation Measurement

### 3.7.1 Description of Field Strength of Spurious Radiated Measurement

The power of any emission outside of the authorized operating frequency ranges must be attenuated below the transmitter power (P) by a factor of at least  $43 + 10 \log(P)$  dB. The spectrum is scanned from 30 MHz up to a frequency including its 10th harmonic.

### 3.7.2 Measuring Instruments

See list of measuring instruments of this test report.

### 3.7.3 Test Procedures

1. The EUT was placed on a rotatable wooden table with 0.8 meter above ground.
2. The EUT was set 3 meters from the receiving antenna, which was mounted on the antenna tower.
3. The table was rotated 360 degrees to determine the position of the highest spurious emission.
4. The height of the receiving antenna is varied between one meter and four meters to search the maximum spurious emission for both horizontal and vertical polarizations.
5. Make the measurement with the spectrum analyzer's RBW = 1MHz, VBW = 3MHz, taking the record of maximum spurious emission.
6. A horn antenna was substituted in place of the EUT and was driven by a signal generator.
7. Tune the output power of signal generator to the same emission level with EUT maximum spurious emission.
8. Taking the record of output power at antenna port.
9. Repeat step 7 to step 8 for another polarization.
10. The RF fundamental frequency should be excluded against the limit line in the operating frequency band.
11. The limit line is derived from  $43 + 10\log(P)$  dB below the transmitter power P(Watts)  
=  $P(W) - [43 + 10\log(P)]$  (dB)  
=  $[30 + 10\log(P)]$  (dBm) -  $[43 + 10\log(P)]$  (dB)  
= -13dBm.

EIRP (dBm) = S.G. Power – Tx Cable Loss + Tx Antenna Gain

ERP (dBm) = EIRP - 2.15

### 3.7.4 Test Setup

For radiated emissions below 30MHz

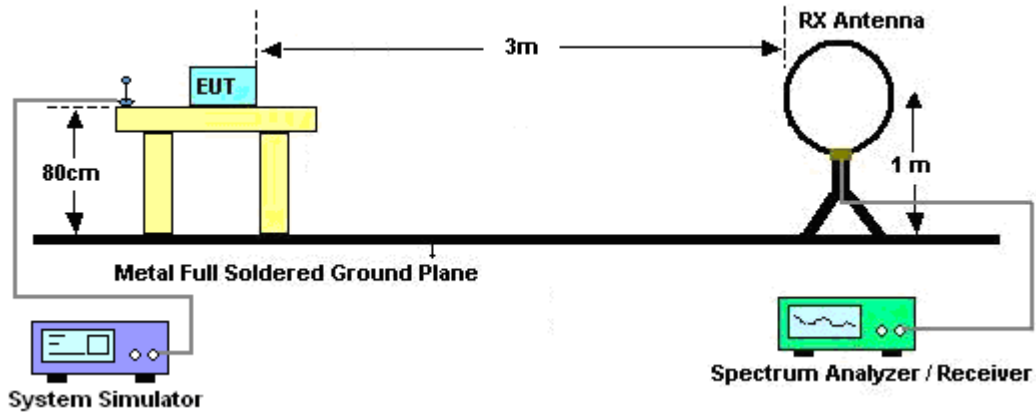

For radiated emissions from 30MHz to 1GHz

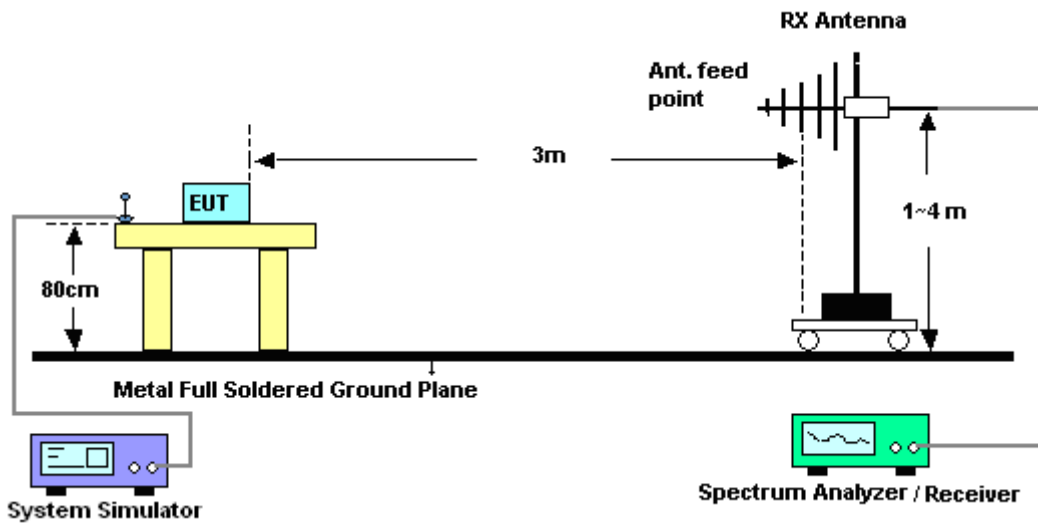

For radiated emissions above 1GHz

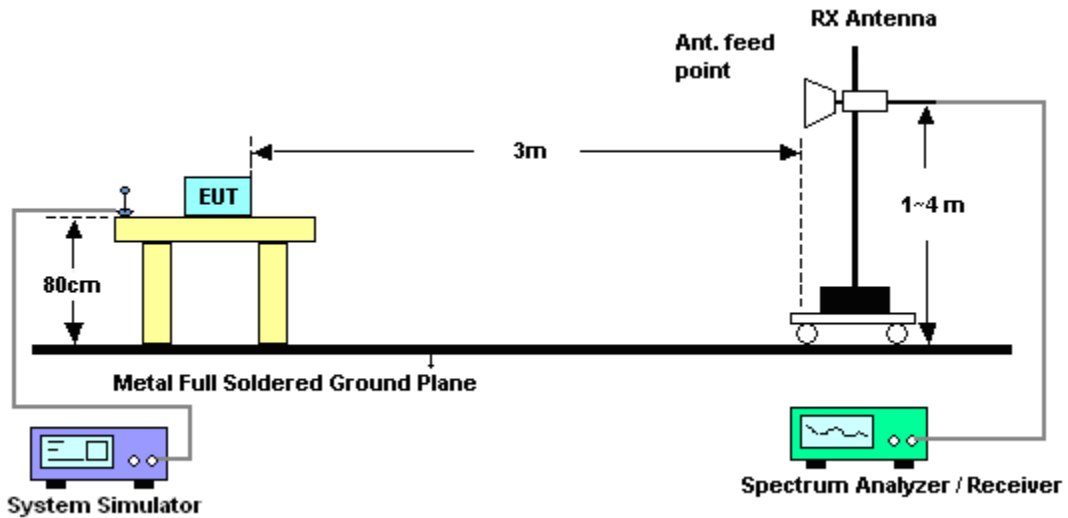

### 3.7.5 Test Results of Radiated Emissions (9 KHz ~ 30 MHz)

The low frequency, which started from 9 KHz to 30MHz, was pre-scanned and the result which was 20dB lower than the limit line per 15.31(o) was not reported.



3.7.6 Test Result of Field Strength of Spurious Radiated

Band :	GSM850	Temperature :	27~28°C
Test Mode :	GSM Link	Relative Humidity :	51~52%
Test Engineer :	John Zheng	Polarization :	Horizontal
Remark :	Spurious emissions within 30-1000MHz were found more than 20dB below limit line.		

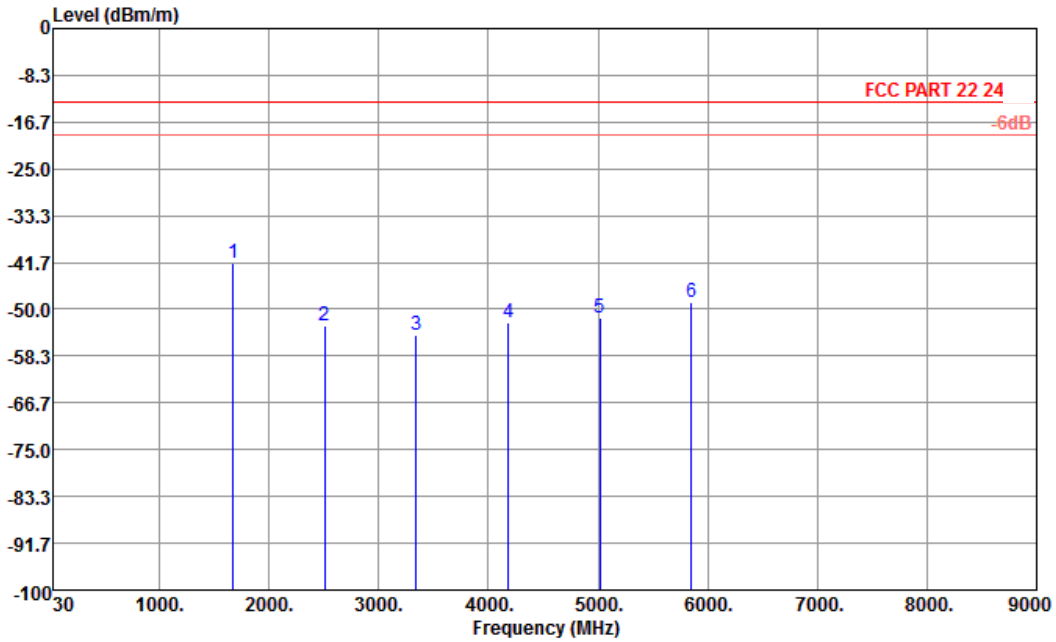

Site : 03CH01-KS  
 Condition : FCC PART 22 24 3m HF EIRP FACTOR-09020 HORIZONTAL  
 Project : (FG) 330801

Frequency ( MHz )	ERP ( dBm )	Limit ( dBm )	Over Limit ( dB )	SPA Reading ( dBm )	S.G. Power ( dBm )	TX Cable loss ( dB )	TX Antenna Gain ( dBi )	Polarization ( H/V )	Result
1672	-41.74	-13	-28.74	-58.15	-44.71	0.88	6.00	H	Pass
2510	-53.06	-13	-40.06	-72.67	-55.67	1.08	5.84	H	Pass
3345	-54.62	-13	-41.62	-65.22	-58.99	1.14	7.66	H	Pass
4182	-52.40	-13	-39.40	-67.16	-57.67	1.37	8.79	H	Pass
5018	-51.43	-13	-38.43	-69.72	-57.57	1.51	9.80	H	Pass
5854	-48.85	-13	-35.85	-67.07	-55.38	1.62	10.30	H	Pass





Band :	GSM850	Temperature :	27~28°C
Test Mode :	GSM Link	Relative Humidity :	51~52%
Test Engineer :	John Zheng	Polarization :	Vertical
Remark :	Spurious emissions within 30-1000MHz were found more than 20dB below limit line.		

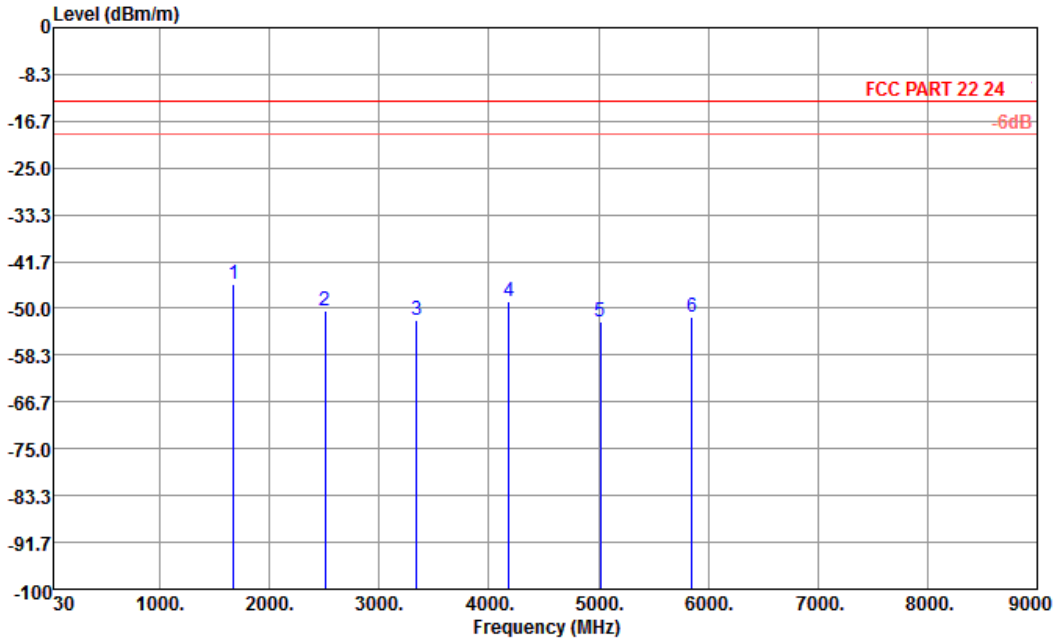

Site : 03CH01-KS  
 Condition : FCC PART 22 24 3m HF EIRP FACTOR-09020 VERTICAL  
 Project : (FG) 330801

Frequency ( MHz )	ERP ( dBm )	Limit ( dBm )	Over Limit ( dB )	SPA Reading ( dBm )	S.G. Power ( dBm )	TX Cable loss ( dB )	TX Antenna Gain ( dBi )	Polarization ( H/V )	Result
1672	-45.69	-13	-32.69	-59.04	-48.66	0.88	6.00	V	Pass
2510	-50.52	-13	-37.52	-70.19	-53.13	1.08	5.84	V	Pass
3345	-52.21	-13	-39.21	-64.04	-56.58	1.14	7.66	V	Pass
4182	-48.67	-13	-35.67	-63.89	-53.94	1.37	8.79	V	Pass
5018	-52.46	-13	-39.46	-69.91	-58.60	1.51	9.80	V	Pass
5854	-51.43	-13	-38.43	-69.33	-57.96	1.62	10.30	V	Pass



Band :	GSM850	Temperature :	27~28°C
Test Mode :	EDGE 8 Link	Relative Humidity :	51~52%
Test Engineer :	John Zheng	Polarization :	Horizontal
Remark :	Spurious emissions within 30-1000MHz were found more than 20dB below limit line.		

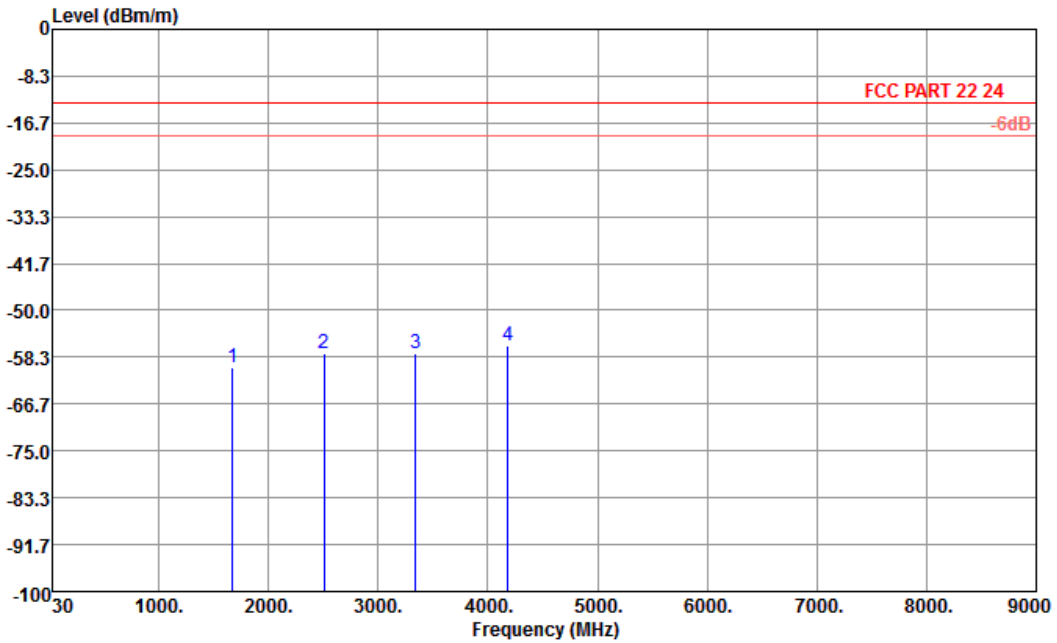

Site : 03CH01-KS  
 Condition : FCC PART 22 24 3m HF EIRP FACTOR-09020 HORIZONTAL  
 Project : (FG) 330801

Frequency ( MHz )	ERP ( dBm )	Limit ( dBm )	Over Limit ( dB )	SPA Reading ( dBm )	S.G. Power ( dBm )	TX Cable loss ( dB )	TX Antenna Gain ( dBi )	Polarization ( H/V )	Result
1672	-60.10	-13	-47.10	-73.02	-63.07	0.88	6.00	H	Pass
2510	-57.72	-13	-44.72	-77.33	-60.33	1.08	5.84	H	Pass
3345	-57.58	-13	-44.58	-68.18	-61.95	1.14	7.66	H	Pass
4182	-56.25	-13	-43.25	-71.01	-61.52	1.37	8.79	H	Pass



Band :	GSM850	Temperature :	27~28°C
Test Mode :	EDGE 8 Link	Relative Humidity :	51~52%
Test Engineer :	John Zheng	Polarization :	Vertical
Remark :	Spurious emissions within 30-1000MHz were found more than 20dB below limit line.		

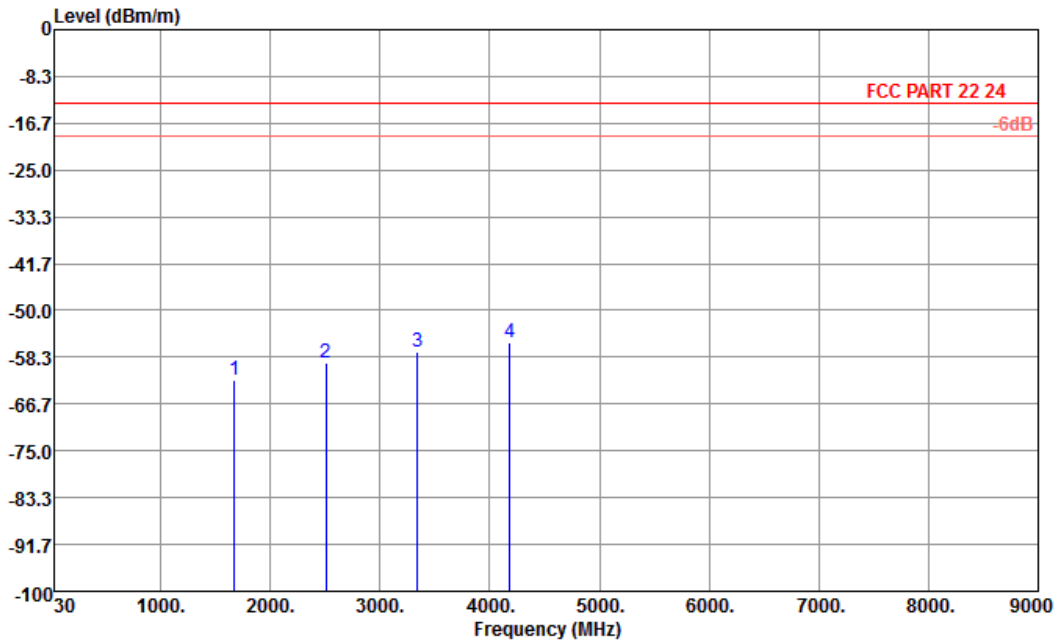

Site : 03CH01-KS  
 Condition : FCC PART 22 24 3m HF EIRP FACTOR-09020 VERTICAL  
 Project : (FG) 330801

Frequency ( MHz )	ERP ( dBm )	Limit ( dBm )	Over Limit ( dB )	SPA Reading ( dBm )	S.G. Power ( dBm )	TX Cable loss ( dB )	TX Antenna Gain ( dBi )	Polarization ( H/V )	Result
1672	-62.35	-13	-49.35	-72.98	-65.32	0.88	6.00	V	Pass
2510	-59.22	-13	-46.22	-78.07	-61.83	1.08	5.84	V	Pass
3345	-57.45	-13	-44.45	-69.28	-61.82	1.14	7.66	V	Pass
4182	-55.77	-13	-42.77	-70.99	-61.04	1.37	8.79	V	Pass



<b>Band :</b>	GSM1900	<b>Temperature :</b>	27~28°C
<b>Test Mode :</b>	GSM Link	<b>Relative Humidity :</b>	51~52%
<b>Test Engineer :</b>	John Zheng	<b>Polarization :</b>	Horizontal
<b>Remark :</b>	Spurious emissions within 30-1000MHz were found more than 20dB below limit line.		

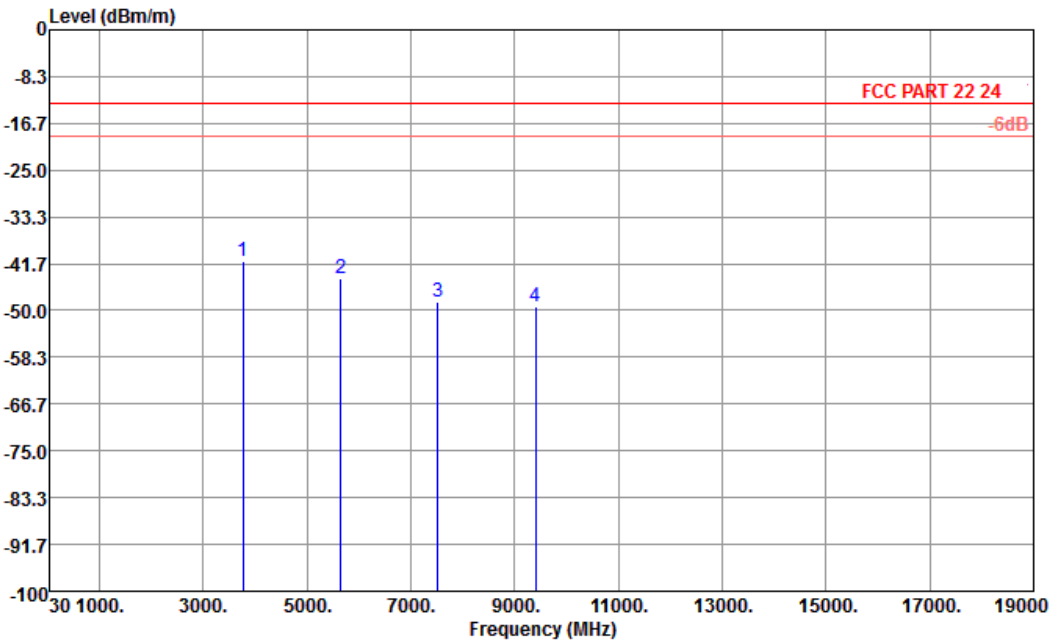

Site : 03CH01-KS  
 Condition : FCC PART 22 24 3m HF EIRP FACTOR-09020 HORIZONTAL  
 Project : (FG) 330801

Frequency ( MHz )	EIRP ( dBm )	Limit ( dBm )	Over Limit ( dB )	SPA Reading ( dBm )	S.G. Power ( dBm )	TX Cable loss ( dB )	TX Antenna Gain ( dBi )	Polarization ( H/V )	Result
3760	-41.14	-13	-28.14	-57.16	-47.88	1.28	8.02	H	Pass
5640	-44.42	-13	-31.42	-63.17	-52.84	1.58	10.00	H	Pass
7520	-48.49	-13	-35.49	-70.43	-58.81	1.78	12.10	H	Pass
9400	-49.25	-13	-36.25	-71.37	-60.03	2.22	13.00	H	Pass



<b>Band :</b>	GSM1900	<b>Temperature :</b>	27~28°C
<b>Test Mode :</b>	GSM Link	<b>Relative Humidity :</b>	51~52%
<b>Test Engineer :</b>	John Zheng	<b>Polarization :</b>	Vertical
<b>Remark :</b>	Spurious emissions within 30-1000MHz were found more than 20dB below limit line.		

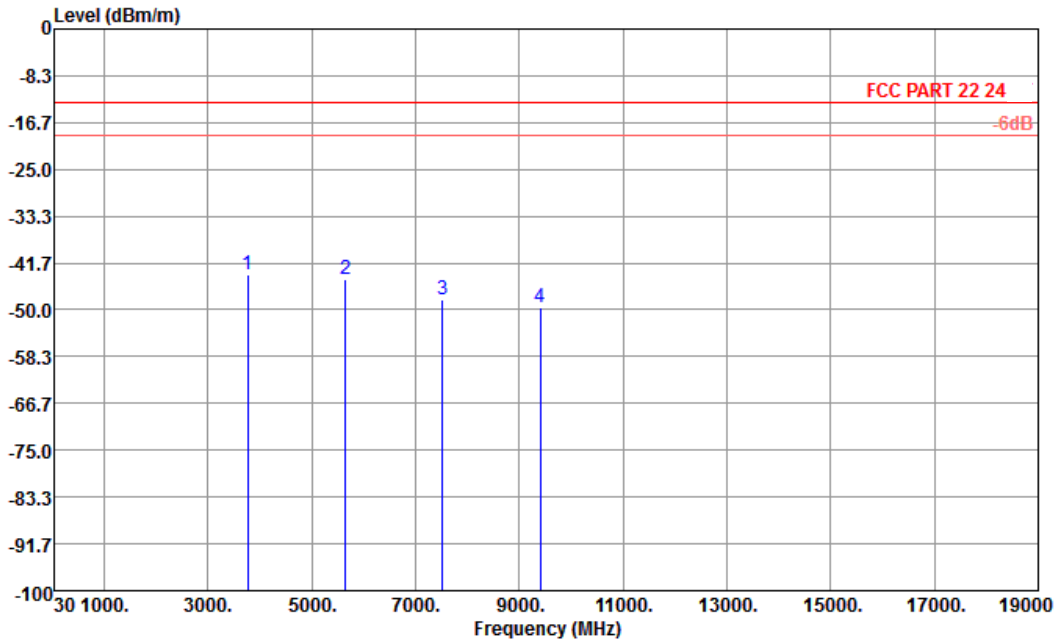

Site : 03CH01-KS  
 Condition : FCC PART 22 24 3m HF EIRP FACTOR-09020 VERTICAL  
 Project : (FG) 330801

Frequency ( MHz )	EIRP ( dBm )	Limit ( dBm )	Over Limit ( dB )	SPA Reading ( dBm )	S.G. Power ( dBm )	TX Cable loss ( dB )	TX Antenna Gain ( dBi )	Polarization ( H/V )	Result
3760	-43.63	-13	-30.63	-59.84	-50.37	1.28	8.02	V	Pass
5640	-44.50	-13	-31.50	-62.34	-52.92	1.58	10	V	Pass
7520	-48.12	-13	-35.12	-70.37	-58.44	1.78	12.1	V	Pass
9400	-49.65	-13	-36.65	-73.27	-60.43	2.22	13	V	Pass



<b>Band :</b>	GSM1900	<b>Temperature :</b>	27~28°C
<b>Test Mode :</b>	EDGE 8 Link	<b>Relative Humidity :</b>	51~52%
<b>Test Engineer :</b>	John Zheng	<b>Polarization :</b>	Horizontal
<b>Remark :</b>	Spurious emissions within 30-1000MHz were found more than 20dB below limit line.		

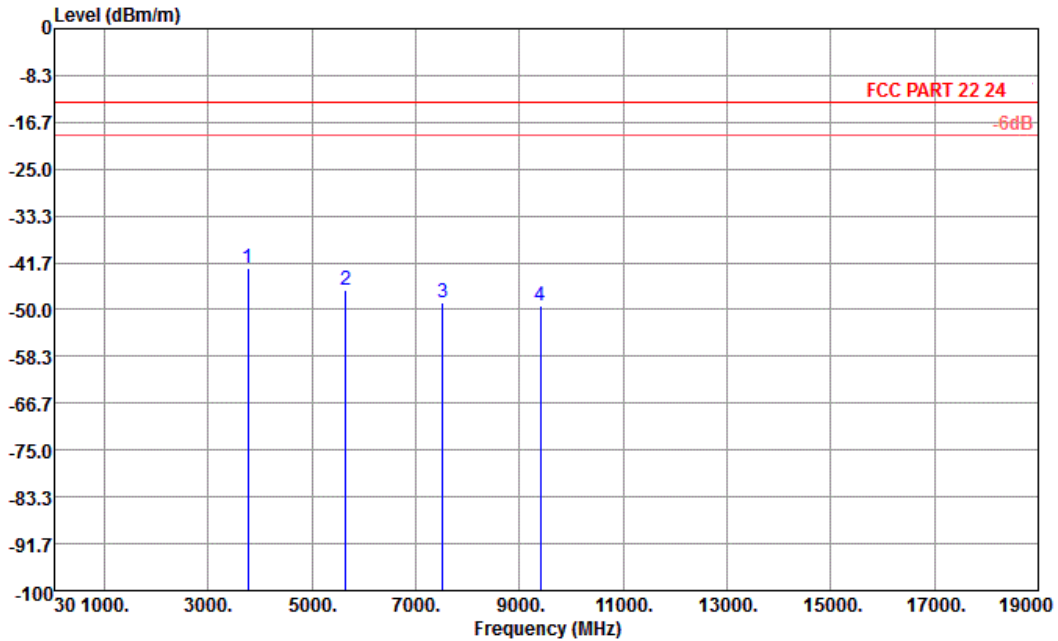

Site : 03CH01-KS  
 Condition : FCC PART 22 24 3m HF EIRP FACTOR-09020 HORIZONTAL  
 Project : (FG) 330801

Frequency ( MHz )	EIRP ( dBm )	Limit ( dBm )	Over Limit ( dB )	SPA Reading ( dBm )	S.G. Power ( dBm )	TX Cable loss ( dB )	TX Antenna Gain ( dBi )	Polarization ( H/V )	Result
3760	-42.65	-13	-29.65	-58.42	-49.39	1.28	8.02	H	Pass
5640	-46.45	-13	-33.45	-64.44	-54.87	1.58	10.00	H	Pass
7520	-48.87	-13	-35.87	-70.81	-59.19	1.78	12.10	H	Pass
9400	-49.32	-13	-36.32	-71.44	-60.10	2.22	13.00	H	Pass



Band :	GSM1900	Temperature :	27~28°C
Test Mode :	EDGE 8 Link	Relative Humidity :	51~52%
Test Engineer :	John Zheng	Polarization :	Vertical
Remark :	Spurious emissions within 30-1000MHz were found more than 20dB below limit line.		

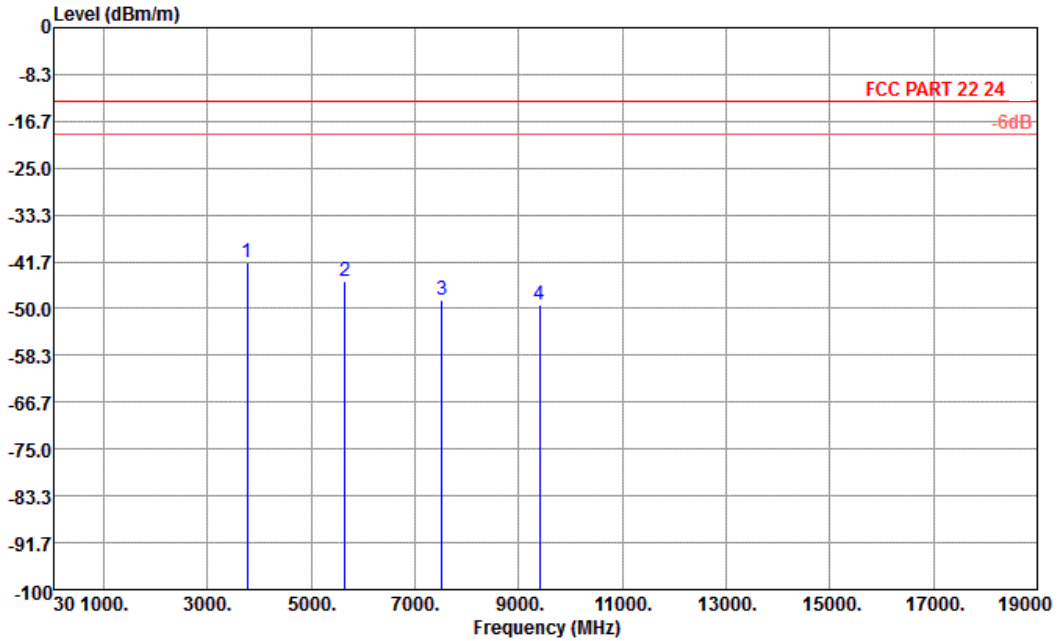

Site : 03CH01-KS  
 Condition : FCC PART 22 24 3m HF EIRP FACTOR-09020 VERTICAL  
 Project : (FG) 330801

Frequency ( MHz )	EIRP ( dBm )	Limit ( dBm )	Over Limit ( dB )	SPA Reading ( dBm )	S.G. Power ( dBm )	TX Cable loss ( dB )	TX Antenna Gain ( dBi )	Polarization ( H/V )	Result
3760	-41.81	-13	-28.81	-58.43	-48.55	1.28	8.02	V	Pass
5640	-45.07	-13	-32.07	-62.7	-53.49	1.58	10	V	Pass
7520	-48.50	-13	-35.50	-70.75	-58.82	1.78	12.1	V	Pass
9400	-49.36	-13	-36.36	-72.98	-60.14	2.22	13	V	Pass



<b>Band :</b>	WCDMA Band V	<b>Temperature :</b>	27~28°C
<b>Test Mode :</b>	RMC 12.2Kbps Link	<b>Relative Humidity :</b>	51~52%
<b>Test Engineer :</b>	John Zheng	<b>Polarization :</b>	Horizontal
<b>Remark :</b>	Spurious emissions within 30-1000MHz were found more than 20dB below limit line.		

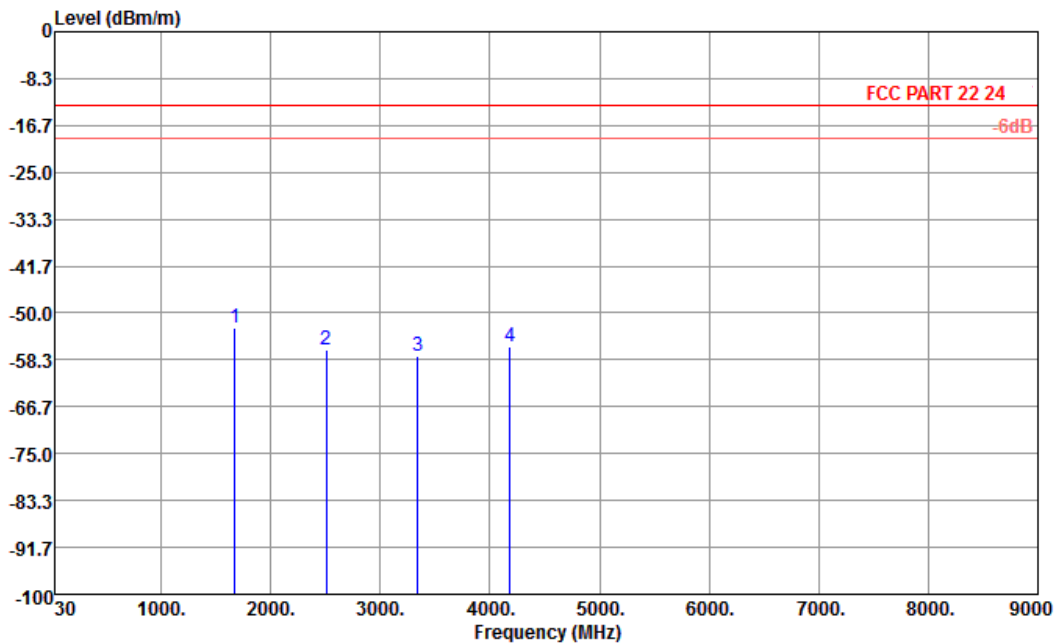

Site : 03CH01-KS  
 Condition : FCC PART 22 24 ... 3m HF EIRP FACTOR-09020 HORIZONTAL  
 Project : (FG) 330801

Frequency ( MHz )	ERP ( dBm )	Limit ( dBm )	Over Limit ( dB )	SPA Reading ( dBm )	S.G. Power ( dBm )	TX Cable loss ( dB )	TX Antenna Gain ( dBi )	Polarization ( H/V )	Result
1672	-52.63	-13	-39.63	-66.19	-55.60	0.88	6.00	H	Pass
2509	-56.68	-13	-43.68	-76.29	-59.29	1.08	5.84	H	Pass
3345	-57.74	-13	-44.74	-68.34	-62.11	1.14	7.66	H	Pass
4182	-56.12	-13	-43.12	-70.88	-61.39	1.37	8.79	H	Pass





<b>Band :</b>	WCDMA Band V	<b>Temperature :</b>	27~28°C
<b>Test Mode :</b>	RMC 12.2Kbps Link	<b>Relative Humidity :</b>	51~52%
<b>Test Engineer :</b>	John Zheng	<b>Polarization :</b>	Vertical
<b>Remark :</b>	Spurious emissions within 30-1000MHz were found more than 20dB below limit line.		

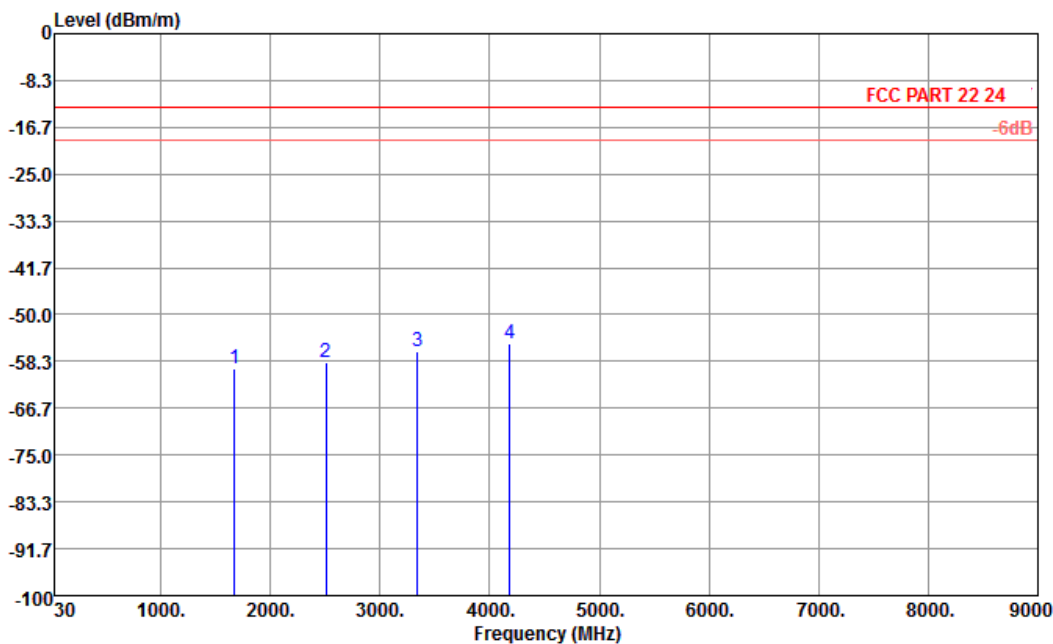

Site : 03CH01-KS  
 Condition : FCC PART 22 24 3m HF EIRP FACTOR-09020 VERTICAL  
 Project : (FG) 330801

Frequency ( MHz )	ERP ( dBm )	Limit ( dBm )	Over Limit ( dB )	SPA Reading ( dBm )	S.G. Power ( dBm )	TX Cable loss ( dB )	TX Antenna Gain ( dBi )	Polarization ( H/V )	Result
1672	-59.66	-13	-46.66	-70.29	-62.63	0.88	6.00	V	Pass
2509	-58.48	-13	-45.48	-77.33	-61.09	1.08	5.84	V	Pass
3345	-56.57	-13	-43.57	-68.40	-60.94	1.14	7.66	V	Pass
4182	-55.29	-13	-42.29	-70.51	-60.56	1.37	8.79	V	Pass



<b>Band :</b>	WCDMA Band II	<b>Temperature :</b>	27~28°C
<b>Test Mode :</b>	RMC 12.2Kbps Link	<b>Relative Humidity :</b>	51~52%
<b>Test Engineer :</b>	John Zheng	<b>Polarization :</b>	Horizontal
<b>Remark :</b>	Spurious emissions within 30-1000MHz were found more than 20dB below limit line.		

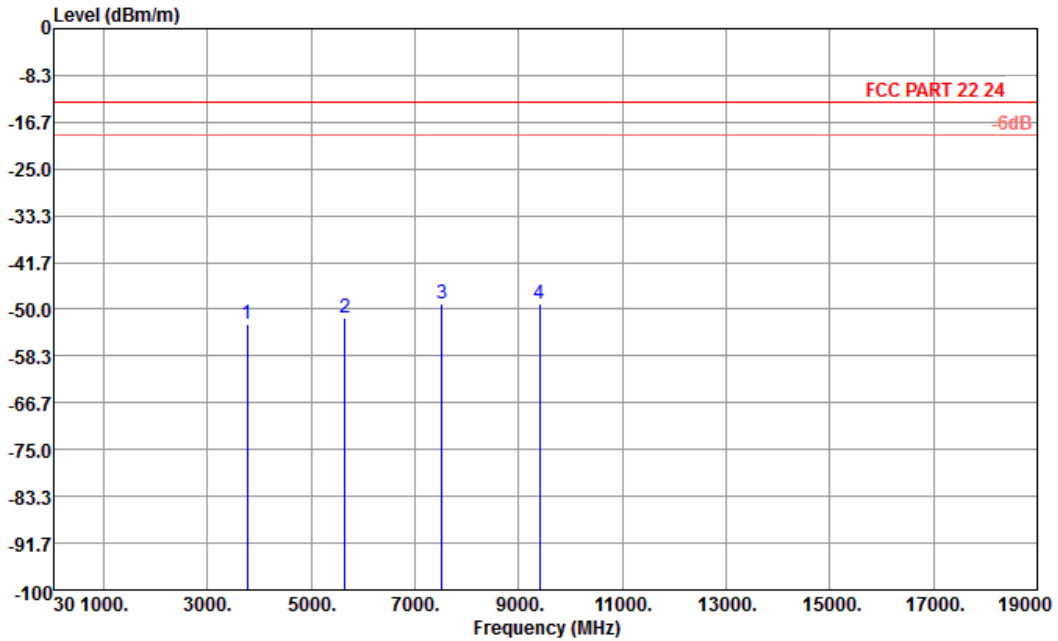

Site : 03CH01-KS  
 Condition : FCC PART 22 24 3m HF EIRP FACTOR-09020 HORIZONTAL  
 Project : (FG) 330801

Frequency ( MHz )	EIRP ( dBm )	Limit ( dBm )	Over Limit ( dB )	SPA Reading ( dBm )	S.G. Power ( dBm )	TX Cable loss ( dB )	TX Antenna Gain ( dBi )	Polarization ( H/V )	Result
3760	-52.68	-13	-39.68	-64.83	-59.42	1.28	8.02	H	Pass
5640	-51.51	-13	-38.51	-69.50	-59.93	1.58	10.00	H	Pass
7520	-49.16	-13	-36.16	-71.10	-59.48	1.78	12.10	H	Pass
9400	-49.16	-13	-36.16	-71.28	-59.94	2.22	13.00	H	Pass



<b>Band :</b>	WCDMA Band II	<b>Temperature :</b>	27~28°C
<b>Test Mode :</b>	RMC 12.2Kbps Link	<b>Relative Humidity :</b>	51~52%
<b>Test Engineer :</b>	John Zheng	<b>Polarization :</b>	Vertical
<b>Remark :</b>	Spurious emissions within 30-1000MHz were found more than 20dB below limit line.		

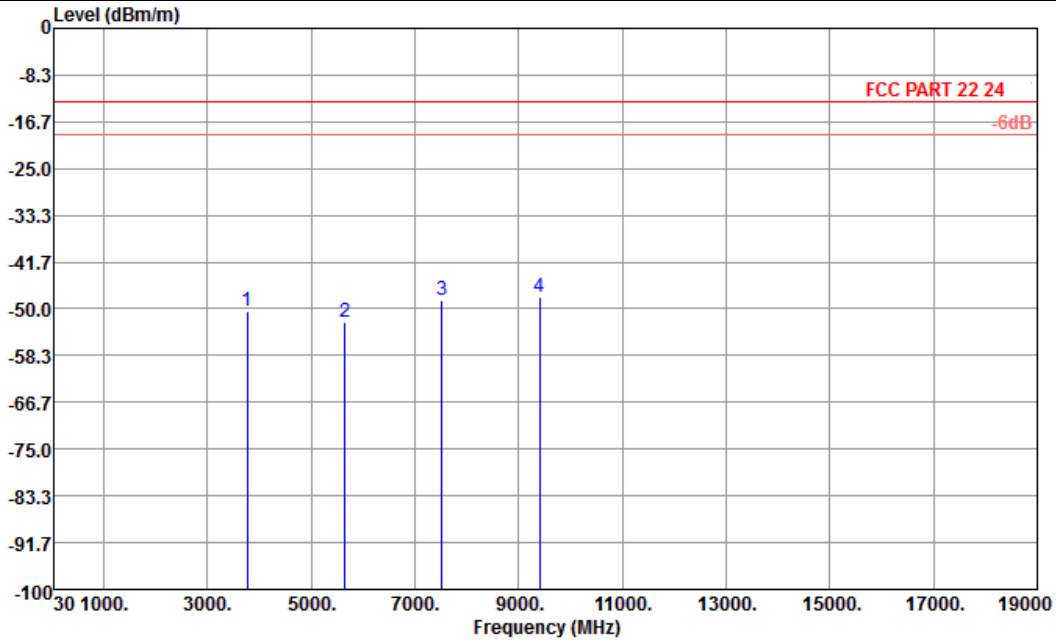

Site : 03CH01-KS  
 Condition : FCC PART 22 24 3m HF EIRP FACTOR-09020 VERTICAL  
 Project : (FG) 330801

Frequency ( MHz )	EIRP ( dBm )	Limit ( dBm )	Over Limit ( dB )	SPA Reading ( dBm )	S.G. Power ( dBm )	TX Cable loss ( dB )	TX Antenna Gain ( dBi )	Polarization ( H/V )	Result
3760	-50.50	-13	-37.50	-65.53	-57.24	1.28	8.02	V	Pass
5640	-52.39	-13	-39.39	-69.47	-60.81	1.58	10	V	Pass
7520	-48.38	-13	-35.38	-70.63	-58.70	1.78	12.1	V	Pass
9400	-47.78	-13	-34.78	-71.4	-58.56	2.22	13	V	Pass

## 3.8 Frequency Stability Measurement

### 3.8.1 Description of Frequency Stability Measurement

The frequency stability shall be measured by variation of ambient temperature and variation of primary supply voltage to ensure that the fundamental emission stays within the authorized frequency block. The frequency stability of the transmitter shall be maintained within  $\pm 0.00025\%$  ( $\pm 2.5\text{ppm}$ ) of the center frequency.

### 3.8.2 Measuring Instruments

See list of measuring instruments of this test report.

### 3.8.3 Test Procedures for Temperature Variation

1. The EUT was set up in the thermal chamber and connected with the base station.
2. With power OFF, the temperature was decreased to  $-30^{\circ}\text{C}$  and the EUT was stabilized before testing. Power was applied and the maximum change in frequency was recorded within one minute.
3. With power OFF, the temperature was raised in  $10^{\circ}\text{C}$  step up to  $50^{\circ}\text{C}$ . The EUT was stabilized at each step for at least half an hour. Power was applied and the maximum frequency change was recorded within one minute.
4. If the EUT cannot be turned on at  $-30^{\circ}\text{C}$ , the testing lowest temperature will be raised in  $10^{\circ}\text{C}$  step until the EUT can be turned on.

### 3.8.4 Test Procedures for Voltage Variation

1. The EUT was placed in a temperature chamber at  $25\pm 5^{\circ}\text{C}$  and connected with the base station.
2. The power supply voltage to the EUT was varied from BEP to 115% of the nominal value measured at the input to the EUT.
3. The variation in frequency was measured for the worst case.

### 3.8.5 Test Setup

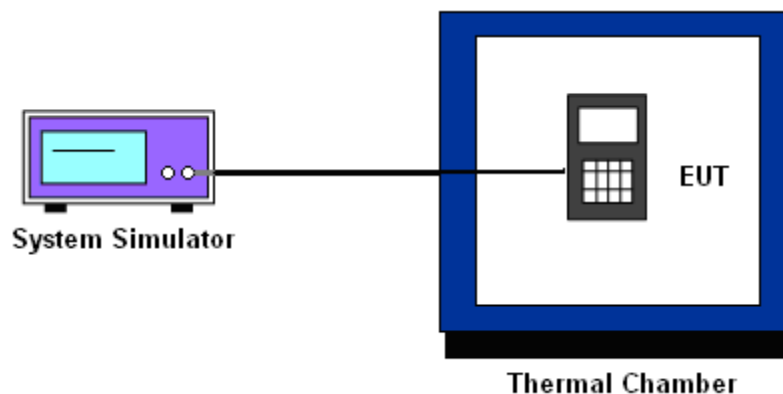



3.8.6 Test Result of Temperature Variation

Band :	GSM 850	Channel :	189
Limit (ppm) :	2.5	Frequency :	836.4 MHz

Temperature (°C)	GSM		EDGE 8		Result
	Freq. Dev. (Hz)	Deviation (ppm)	Freq. Dev. (Hz)	Deviation (ppm)	
-30	-14	-0.02	16	0.02	PASS
-20	-19	-0.02	18	0.02	
-10	-22	-0.03	15	0.02	
0	-24	-0.03	-17	-0.02	
10	-23	-0.03	-15	-0.02	
20	-22	-0.03	20	0.02	
30	-25	-0.03	42	0.05	
40	-34	-0.04	-39	-0.05	
50	-37	-0.04	-45	-0.05	

Band :	GSM 1900	Channel :	661
Limit (ppm) :	2.5	Frequency :	1880.0 MHz

Temperature (°C)	GSM		EDGE 8		Result
	Freq. Dev. (Hz)	Deviation (ppm)	Freq. Dev. (Hz)	Deviation (ppm)	
-30	23	0.01	43	0.02	PASS
-20	28	0.01	38	0.02	
-10	35	0.02	41	0.02	
0	37	0.02	37	0.02	
10	42	0.02	35	0.02	
20	36	0.02	41	0.02	
30	35	0.02	43	0.02	
40	37	0.02	51	0.03	
50	-32	-0.02	32	0.02	



<b>Band :</b>	WCDMA Band V	<b>Channel :</b>	4182
<b>Limit (ppm) :</b>	2.5	<b>Frequency :</b>	836.4 MHz

Temperature (°C)	RMC 12.2Kbps		Result
	Freq. Dev. (Hz)	Deviation (ppm)	
-30	-21	-0.02	PASS
-20	-19	-0.02	
-10	-16	-0.02	
0	-18	-0.02	
10	-21	-0.02	
20	-20	-0.02	
30	-18	-0.02	
40	-20	-0.02	
50	-22	-0.03	

<b>Band :</b>	WCDMA Band II	<b>Channel :</b>	9400
<b>Limit (ppm) :</b>	2.5	<b>Frequency :</b>	1880.0 MHz

Temperature (°C)	RMC 12.2Kbps		Result
	Freq. Dev. (Hz)	Deviation (ppm)	
-30	-38	-0.02	PASS
-20	-35	-0.02	
-10	-37	-0.02	
0	-38	-0.02	
10	-35	-0.02	
20	-37	-0.02	
30	32	0.02	
40	29	0.02	
50	-39	-0.02	

3.8.7 Test Result of Voltage Variation

Band & Channel	Mode	Voltage (Volt)	Freq. Dev. (Hz)	Deviation (ppm)	Limit (ppm)	Result
GSM 850 CH189	GSM	9.5	-41	-0.05	2.5	PASS
		BEP	-39	-0.05		
		9.975	-38	-0.04		
	EDGE 8	9.5	-33	-0.04		
		BEP	-36	-0.04		
		9.975	-46	-0.05		
GSM 1900 CH661	GSM	9.5	25	0.01		
		BEP	-32	-0.02		
		9.975	-29	-0.02		
	EDGE 8	9.5	-37	-0.02		
		BEP	-33	-0.02		
		9.975	-29	-0.02		
WCDMA Band V CH4182	RMC 12.2Kbps	9.5	-24	-0.03		
		BEP	-17	-0.02		
		9.975	-19	-0.02		
WCDMA Band II CH9400	RMC 12.2Kbps	9.5	-29	-0.02		
		BEP	-27	-0.01		
		9.975	-32	-0.02		

Note:

1. Normal Voltage = 9.5V.
2. Battery End Point (BEP) = 9 V.



## 4 List of Measuring Equipment

Instrument	Manufacturer	Model No.	Serial No.	Characteristics	Calibration Date	Test Date	Due Date	Remark
Spectrum Analyzer	R&S	FSP30	101400	9kHz~30GHz	Jun. 01, 2012	Mar. 25, 2013~ Mar. 28, 2013	May 31, 2013	Conducted (TH01-SZ)
Spectrum Analyzer	R&S	FSV30	100845	9kHz~30GHz	Nov. 06, 2012	Mar. 25, 2013~ Mar. 28, 2013	Nov. 05, 2013	Conducted (TH01-SZ)
DC Power Supply	TOPWORD	3303DR	714621	N/A	Nov. 19, 2012	Mar. 25, 2013~ Mar. 28, 2013	Nov. 18, 2013	Conducted (TH01-SZ)
Thermal Chamber	Hongzhan	LP-150U	HD20120425	N/A	Jun. 11, 2012	Mar. 25, 2013~ Mar. 28, 2013	Jun. 10, 2013	Conducted (TH01-SZ)
ESCI TEST Receiver	R&S	ESCI	100724	9K-3GHz	Mar. 28, 2013	Apr. 10, 2013	Mar. 27, 2014	Radiation (03CH01-SZ)
Spectrum Analyzer	R&S	FSP30	101362	9kHz~30GHz	Mar. 28, 2013	Apr. 10, 2013	Mar. 27, 2014	Radiation (03CH01-SZ)
Double Ridge Horn Antenna	ETS Lindgren	3117	00119436	1GHz~18GHz	Oct. 12, 2012	Apr. 10, 2013	Oct. 11, 2013	Radiation (03CH01-SZ)
Bilog Antenna	SCHAFFNER	CBL6112B	2614	30Mhz~2Ghz	Nov. 03, 2012	Apr. 10, 2013	Nov. 02, 2013	Radiation (03CH01-SZ)
Amplifier	ADVANTEST	BB525C	E9007003	9K-3000MHz GAIN 30db	Mar. 28, 2013	Apr. 10, 2013	Mar. 27, 2014	Radiation (03CH01-SZ)
Amplifier	Yiai	AV3860B	04030	2GHz~26.5GHz	Mar. 28, 2013	Apr. 10, 2013	Mar. 27, 2014	Radiation (03CH01-SZ)
SHF-EHF-Horn	Schwarzbeck	BBHA9170	BBHA9170249	14Ghz~40Ghz	Nov. 23, 2012	Apr. 10, 2013	Nov. 22, 2013	Radiation (03CH01-SZ)
Loop Antenna	R&S	HFH2-Z2	100321	9KHZ-30MHZ	Jul. 03, 2012	Apr. 10, 2013	Jul. 02, 2013	Radiation (03CH01-SZ)
System Simulator	Agilent	E5515C	MY50264168	GSM/WCDMA /CDMA2000	Oct. 09, 2012	Mar. 25, 2013~ Apr. 10, 2013	Oct. 08, 2013	-



## 5 Uncertainty of Evaluation

### Uncertainty of Radiated Emission Measurement (30 MHz ~ 1000 MHz)

Measuring Uncertainty for a Level of Confidence of 95% ( $U = 2Uc(y)$ )	2.54
---	------

### Uncertainty of Radiated Emission Measurement (1 GHz ~ 40 GHz)

Measuring Uncertainty for a Level of Confidence of 95% ( $U = 2Uc(y)$ )	4.72
---	------



## **Appendix A. Photographs of EUT**

Please refer to Sporton report number EP330801 as below.