

FCC SAR Test Report

APPLICANT : PAX Technology Limited
EQUIPMENT : Wireless POS Terminal
BRAND NAME : PAX
MODEL NAME : S900
FCC ID : V5PS900
STANDARD : FCC 47 CFR Part 2 (2.1093)
ANSI/IEEE C95.1-1992
IEEE 1528-2003

We, SPORTON INTERNATIONAL (SHENZHEN) INC., would like to declare that the tested sample has been evaluated in accordance with the procedures and had been in compliance with the applicable technical standards.

The test results in this report apply exclusively to the tested model / sample. Without written approval of SPORTON INTERNATIONAL (SHENZHEN) INC., the test report shall not be reproduced except in full.

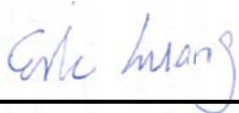

Reviewed by: Eric Huang / Deputy Manager



Approved by: Jones Tsai / Manager



SPORTON INTERNATIONAL (SHENZHEN) INC.
1F & 2F, Building A, Morning Business Center, No. 4003 ShiGu Rd., Xili Town,
Nanshan District, Shenzhen, Guangdong, P. R. China



Table of Contents

1. Statement of Compliance4

2. Administration Data5

3. Guidance Standard5

4. Equipment Under Test (EUT)6

 4.1 General Information6

 4.2 Maximum Tune-up Limit.....7

5. RF Exposure Limits8

 5.1 Uncontrolled Environment.....8

 5.2 Controlled Environment.....8

6. Specific Absorption Rate (SAR).....9

 6.1 Introduction9

 6.2 SAR Definition.....9

7. System Description and Setup10

8. Measurement Procedures11

 8.1 Spatial Peak SAR Evaluation.....11

 8.2 Power Reference Measurement.....12

 8.3 Area Scan12

 8.4 Zoom Scan.....13

 8.5 Volume Scan Procedures.....13

 8.6 Power Drift Monitoring.....13

9. Test Equipment List14

10. System Verification15

 10.1 Tissue Verification15

 10.2 System Performance Check Results.....16

11. RF Exposure Positions17

12. Conducted RF Output Power (Unit: dBm).....18

13. Antenna Location23

14. SAR Test Results24

 14.1 Body SAR25

 14.2 Repeated SAR Measurement26

15. Simultaneous Transmission Analysis27

 15.1 Body Accessory Exposure Conditions.....27

16. Uncertainty Assessment28

17. References30

Appendix A. Plots of System Performance Check

Appendix B. Plots of High SAR Measurement

Appendix C. DASYS Calibration Certificate

Appendix D. Test Setup Photos



1. Statement of Compliance

The maximum results of Specific Absorption Rate (SAR) found during testing for PAX Technology Limited, Wireless POS Terminal, S900 are as follows.

Equipment Class	Frequency Band	Highest SAR Summary	
		Wireless Router 1g SAR (W/kg) Gap(0 mm)	Highest Simultaneous Transmission 1g SAR (W/kg)
PCB	GSM850	1.20	1.26
	GSM1900	1.11	
	WCDMA Band V	0.80	
	WCDMA Band II	1.17	
DTS	WLAN 2.4GHz Band	<0.10	
Date of Testing:		Jun. 04, 2015 ~ Jun. 12, 2015	

This device is in compliance with Specific Absorption Rate (SAR) for general population/uncontrolled exposure limits (1.6 W/kg) specified in FCC 47 CFR part 2 (2.1093) and ANSI/IEEE C95.1-1992, and had been tested in accordance with the measurement methods and procedures specified in IEEE 1528-2003.



2. Administration Data

Testing Laboratory	
Test Site	SPORTON INTERNATIONAL (SHENZHEN) INC.
Test Site Location	1F & 2F, Building A, Morning Business Center, No. 4003 ShiGu Rd., Xili Town, Nanshan District, Shenzhen, Guangdong, P. R. China TEL: +86-755-8637-9589 FAX: +86-755-8637-9595

Applicant	
Company Name	PAX Technology Limited
Address	Room 2416, 24/F., Sun Hung Kai Centre, 30 Harbour Road, Wanchai, Hong Kong

Manufacturer	
Company Name	PAX Computer Technology (Shenzhen) Co., Ltd.
Address	4/F, No.3 Building, Software Park, Second Central Science-Tech Road, High-Tech Industrial Park, Shenzhen, Guangdong, P.R.C.

3. Guidance Standard

The Specific Absorption Rate (SAR) testing specification, method, and procedure for this device is in accordance with the following standards:

- FCC 47 CFR Part 2 (2.1093)
- ANSI/IEEE C95.1-1992
- IEEE 1528-2003
- FCC KDB 865664 D01 SAR Measurement 100 MHz to 6 GHz v01r03
- FCC KDB 865664 D02 SAR Reporting v01r01
- FCC KDB 447498 D01 General RF Exposure Guidance v05r02
- FCC KDB 248227 D01 802.11 Wi-Fi SAR v02r01
- FCC KDB 941225 D01 3G SAR Procedures v03



4. Equipment Under Test (EUT)

4.1 General Information

Product Feature & Specification	
Equipment Name	Wireless POS Terminal
Brand Name	PAX
Model Name	S900
FCC ID	V5PS900
IMEI Code	354524043219956
Wireless Technology and Frequency Range	GSM850: 824.2 MHz ~ 848.8 MHz GSM1900: 1850.2 MHz ~ 1909.8 MHz WCDMA Band V: 826.4 MHz ~ 846.6 MHz WCDMA Band II: 1852.4 MHz ~ 1907.6 MHz WLAN 2.4GHz Band: 2412 MHz ~ 2462 MHz NFC: 13.56MHz
Mode	<ul style="list-style-type: none"> · GPRS/EGPRS · RMC 12.2Kbps · HSDPA · 802.11b/g/n HT20 · NFC: ASK
HW Version	S900-XXX-XX3-0XXX
SW Version	S900 PED3.1
EUT Stage	Production Unit
Remark: 1. Voice call is not supported. 2. 802.11n-HT40 is not supported in 2.4GHz WLAN. 3. This device supports GRPS mode up to multi-slot class10 and EGPRS class 12.	

4.2 Maximum Tune-up Limit

Mode	Burst average power(dBm)	
	GSM 850	GSM 1900
GPRS (GMSK, 1 Tx slot)	32.5	29.5
GPRS (GMSK, 2 Tx slots)	32.5	29.5
EDGE (8PSK, 1 Tx slot)	27.0	26.0
EDGE (8PSK, 2 Tx slots)	27.0	26.0
EDGE (8PSK, 3 Tx slots)	27.0	26.0
EDGE (8PSK, 4 Tx slots)	27.0	26.0

Mode	Average power(dBm)	
	WCDMA Band V	WCDMA Band II
RMC 12.2Kbps	23.5	23.0
HSDPA Subtest-1	22.5	21.5
HSDPA Subtest-2	22.5	21.5
HSDPA Subtest-3	22.0	21.5
HSDPA Subtest-4	21.0	20.5

Mode			Average Power (dBm)
2.4GHz	802.11b	CH 1	15.5
		CH 6	15.0
		CH 11	15.0
	802.11g	CH 1	15.0
		CH 6	15.0
		CH 11	14.5
	802.11n-HT20	CH 1	13.5
		CH 6	13.5
		CH 11	13.0

5. RF Exposure Limits

5.1 Uncontrolled Environment

Uncontrolled Environments are defined as locations where there is the exposure of individuals who have no knowledge or control of their exposure. The general population/uncontrolled exposure limits are applicable to situations in which the general public may be exposed or in which persons who are exposed as a consequence of their employment may not be made fully aware of the potential for exposure or cannot exercise control over their exposure. Members of the general public would come under this category when exposure is not employment-related; for example, in the case of a wireless transmitter that exposes persons in its vicinity.

5.2 Controlled Environment

Controlled Environments are defined as locations where there is exposure that may be incurred by persons who are aware of the potential for exposure, (i.e. as a result of employment or occupation). In general, occupational/controlled exposure limits are applicable to situations in which persons are exposed as a consequence of their employment, who have been made fully aware of the potential for exposure and can exercise control over their exposure. The exposure category is also applicable when the exposure is of a transient nature due to incidental passage through a location where the exposure levels may be higher than the general population/uncontrolled limits, but the exposed person is fully aware of the potential for exposure and can exercise control over his or her exposure by leaving the area or by some other appropriate means.

Limits for Occupational/Controlled Exposure (W/kg)

Whole-Body	Partial-Body	Hands, Wrists, Feet and Ankles
0.4	8.0	20.0

Limits for General Population/Uncontrolled Exposure (W/kg)

Whole-Body	Partial-Body	Hands, Wrists, Feet and Ankles
0.08	1.6	4.0

Whole-Body SAR is averaged over the entire body, partial-body SAR is averaged over any 1gram of tissue defined as a tissue volume in the shape of a cube. SAR for hands, wrists, feet and ankles is averaged over any 10 grams of tissue defined as a tissue volume in the shape of a cube.

6. Specific Absorption Rate (SAR)

6.1 Introduction

SAR is related to the rate at which energy is absorbed per unit mass in an object exposed to a radio field. The SAR distribution in a biological body is complicated and is usually carried out by experimental techniques or numerical modeling. The standard recommends limits for two tiers of groups, occupational/controlled and general population/uncontrolled, based on a person's awareness and ability to exercise control over his or her exposure. In general, occupational/controlled exposure limits are higher than the limits for general population/uncontrolled.

6.2 SAR Definition

The SAR definition is the time derivative (rate) of the incremental energy (dW) absorbed by (dissipated in) an incremental mass (dm) contained in a volume element (dv) of a given density (ρ). The equation description is as below:

$$SAR = \frac{d}{dt} \left(\frac{dW}{dm} \right) = \frac{d}{dt} \left(\frac{dW}{\rho dv} \right)$$

SAR is expressed in units of Watts per kilogram (W/kg)

$$SAR = \frac{\sigma |E|^2}{\rho}$$

Where: σ is the conductivity of the tissue, ρ is the mass density of the tissue and E is the RMS electrical field strength.

7. System Description and Setup

The DASY system used for performing compliance tests consists of the following items:

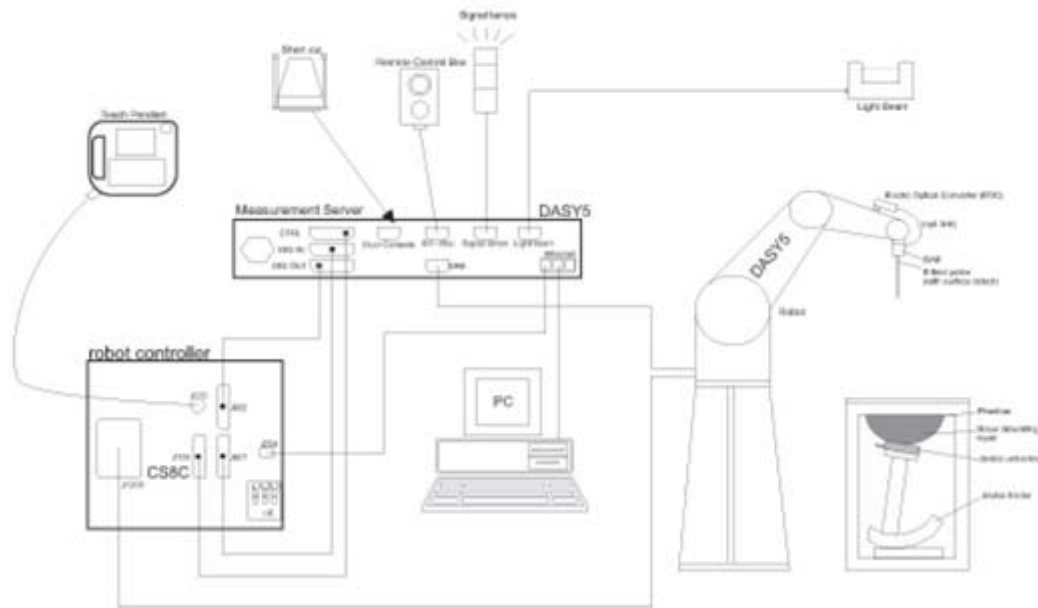

- A standard high precision 6-axis robot with controller, teach pendant and software. An arm extension for accommodating the data acquisition electronics (DAE).
- An isotropic Field probe optimized and calibrated for the targeted measurement.
- A data acquisition electronics (DAE) which performs the signal amplification, signal multiplexing, AD-conversion, offset measurements, mechanical surface detection, collision detection, etc. The unit is battery powered with standard or rechargeable batteries. The signal is optically transmitted to the EOC.
- The Electro-optical converter (EOC) performs the conversion from optical to electrical signals for the digital communication to the DAE. To use optical surface detection, a special version of the EOC is required. The EOC signal is transmitted to the measurement server.
- The function of the measurement server is to perform the time critical tasks such as signal filtering, control of the robot operation and fast movement interrupts.
- The Light Beam used is for probe alignment. This improves the (absolute) accuracy of the probe positioning.
- A computer running WinXP or Win7 and the DASY5 software.
- Remote control and teach pendant as well as additional circuitry for robot safety such as warning lamps, etc.
- The phantom, the device holder and other accessories according to the targeted measurement.

8. Measurement Procedures

The measurement procedures are as follows:

<Conducted power measurement>

- (a) For WWAN power measurement, use base station simulator to configure EUT WWAN transmission in conducted connection with RF cable, at maximum power in each supported wireless interface and frequency band.
- (b) Read the WWAN RF power level from the base station simulator.
- (c) For WLAN power measurement, use engineering software to configure EUT WLAN continuously transmission, at maximum RF power in each supported wireless interface and frequency band
- (d) Connect EUT RF port through RF cable to the power meter, and measure WLAN output power

<SAR measurement>

- (a) Use base station simulator to configure EUT WWAN transmission in radiated connection, and engineering software to configure EUT WLAN continuously transmission, at maximum RF power, in the highest power channel.
- (b) Place the EUT in the positions as Appendix D demonstrates.
- (c) Set scan area, grid size and other setting on the DASY software.
- (d) Measure SAR results for the highest power channel on each testing position.
- (e) Find out the largest SAR result on these testing positions of each band
- (f) Measure SAR results for other channels in worst SAR testing position if the reported SAR of highest power channel is larger than 0.8 W/kg

According to the test standard, the recommended procedure for assessing the peak spatial-average SAR value consists of the following steps:

- (a) Power reference measurement
- (b) Area scan
- (c) Zoom scan
- (d) Power drift measurement

8.1 Spatial Peak SAR Evaluation

The procedure for spatial peak SAR evaluation has been implemented according to the test standard. It can be conducted for 1g and 10g, as well as for user-specific masses. The DASY software includes all numerical procedures necessary to evaluate the spatial peak SAR value.

The base for the evaluation is a "cube" measurement. The measured volume must include the 1g and 10g cubes with the highest averaged SAR values. For that purpose, the center of the measured volume is aligned to the interpolated peak SAR value of a previously performed area scan.

The entire evaluation of the spatial peak values is performed within the post-processing engine (SEMCAD). The system always gives the maximum values for the 1g and 10g cubes. The algorithm to find the cube with highest averaged SAR is divided into the following stages:

- (a) Extraction of the measured data (grid and values) from the Zoom Scan
- (b) Calculation of the SAR value at every measurement point based on all stored data (A/D values and measurement parameters)
- (c) Generation of a high-resolution mesh within the measured volume
- (d) Interpolation of all measured values from the measurement grid to the high-resolution grid
- (e) Extrapolation of the entire 3-D field distribution to the phantom surface over the distance from sensor to surface
- (f) Calculation of the averaged SAR within masses of 1g and 10g

8.2 Power Reference Measurement

The Power Reference Measurement and Power Drift Measurements are for monitoring the power drift of the device under test in the batch process. The minimum distance of probe sensors to surface determines the closest measurement point to phantom surface. This distance cannot be smaller than the distance of sensor calibration points to probe tip as defined in the probe properties.

8.3 Area Scan

The area scan is used as a fast scan in two dimensions to find the area of high field values, before doing a fine measurement around the hot spot. The sophisticated interpolation routines implemented in DASY software can find the maximum found in the scanned area, within a range of the global maximum. The range (in dB) is specified in the standards for compliance testing. For example, a 2 dB range is required in IEEE standard 1528 and IEC 62209 standards, whereby 3 dB is a requirement when compliance is assessed in accordance with the ARIB standard (Japan), if only one zoom scan follows the area scan, then only the absolute maximum will be taken as reference. For cases where multiple maximums are detected, the number of zoom scans has to be increased accordingly.

Area scan parameters extracted from FCC KDB 865664 D01v01r03 SAR measurement 100 MHz to 6 GHz.

	≤ 3 GHz	> 3 GHz
Maximum distance from closest measurement point (geometric center of probe sensors) to phantom surface	5 ± 1 mm	$\frac{1}{2} \cdot \delta \cdot \ln(2) \pm 0.5$ mm
Maximum probe angle from probe axis to phantom surface normal at the measurement location	$30^\circ \pm 1^\circ$	$20^\circ \pm 1^\circ$
Maximum area scan spatial resolution: Δx_{Area} , Δy_{Area}	≤ 2 GHz: ≤ 15 mm $2 - 3$ GHz: ≤ 12 mm	$3 - 4$ GHz: ≤ 12 mm $4 - 6$ GHz: ≤ 10 mm
	When the x or y dimension of the test device, in the measurement plane orientation, is smaller than the above, the measurement resolution must be \leq the corresponding x or y dimension of the test device with at least one measurement point on the test device.	

8.4 Zoom Scan

Zoom scans are used assess the peak spatial SAR values within a cubic averaging volume containing 1 gram and 10 gram of simulated tissue. The zoom scan measures points (refer to table below) within a cube shoes base faces are centered on the maxima found in a preceding area scan job within the same procedure. When the measurement is done, the zoom scan evaluates the averaged SAR for 1 gram and 10 gram and displays these values next to the job's label.

Zoom scan parameters extracted from FCC KDB 865664 D01v01r03 SAR measurement 100 MHz to 6 GHz.

		≤ 3 GHz	> 3 GHz	
Maximum zoom scan spatial resolution: $\Delta x_{Zoom}, \Delta y_{Zoom}$		≤ 2 GHz: ≤ 8 mm 2 – 3 GHz: ≤ 5 mm*	3 – 4 GHz: ≤ 5 mm* 4 – 6 GHz: ≤ 4 mm*	
Maximum zoom scan spatial resolution, normal to phantom surface	uniform grid: $\Delta z_{Zoom}(n)$	≤ 5 mm	3 – 4 GHz: ≤ 4 mm 4 – 5 GHz: ≤ 3 mm 5 – 6 GHz: ≤ 2 mm	
	graded grid	$\Delta z_{Zoom}(1)$: between 1 st two points closest to phantom surface	≤ 4 mm	3 – 4 GHz: ≤ 3 mm 4 – 5 GHz: ≤ 2.5 mm 5 – 6 GHz: ≤ 2 mm
		$\Delta z_{Zoom}(n>1)$: between subsequent points	$\leq 1.5 \cdot \Delta z_{Zoom}(n-1)$	
Minimum zoom scan volume	x, y, z	≥ 30 mm	3 – 4 GHz: ≥ 28 mm 4 – 5 GHz: ≥ 25 mm 5 – 6 GHz: ≥ 22 mm	
Note: δ is the penetration depth of a plane-wave at normal incidence to the tissue medium; see draft standard IEEE P1528-2011 for details. * When zoom scan is required and the <i>reported</i> SAR from the <i>area scan based 1-g SAR estimation</i> procedures of KDB 447498 is ≤ 1.4 W/kg, ≤ 8 mm, ≤ 7 mm and ≤ 5 mm zoom scan resolution may be applied, respectively, for 2 GHz to 3 GHz, 3 GHz to 4 GHz and 4 GHz to 6 GHz.				

8.5 Volume Scan Procedures

The volume scan is used for assess overlapping SAR distributions for antennas transmitting in different frequency bands. It is equivalent to an oversized zoom scan used in standalone measurements. The measurement volume will be used to enclose all the simultaneous transmitting antennas. For antennas transmitting simultaneously in different frequency bands, the volume scan is measured separately in each frequency band. In order to sum correctly to compute the 1g aggregate SAR, the EUT remain in the same test position for all measurements and all volume scan use the same spatial resolution and grid spacing. When all volume scan were completed, the software, SEMCAD postprocessor can combine and subsequently superpose these measurement data to calculating the multiband SAR.

8.6 Power Drift Monitoring

All SAR testing is under the EUT install full charged battery and transmit maximum output power. In DASY measurement software, the power reference measurement and power drift measurement procedures are used for monitoring the power drift of EUT during SAR test. Both these procedures measure the field at a specified reference position before and after the SAR testing. The software will calculate the field difference in dB. If the power drifts more than 5%, the SAR will be retested.



9. Test Equipment List

Manufacturer	Name of Equipment	Type/Model	Serial Number	Calibration	
				Last Cal.	Due Date
SPEAG	835MHz System Validation Kit	D835V2	4d091	Nov. 21, 2014	Nov. 20, 2015
SPEAG	1900MHz System Validation Kit	D1900V2	5d118	Nov. 21, 2014	Nov. 20, 2015
SPEAG	2450MHz System Validation Kit	D2450V2	840	Nov. 19, 2014	Nov. 18, 2015
SPEAG	Data Acquisition Electronics	DAE4	1303	Dec. 11, 2014	Dec. 10, 2015
SPEAG	Data Acquisition Electronics	DAE4	1386	Feb. 19, 2015	Feb. 18, 2016
SPEAG	Dosimetric E-Field Probe	EX3DV4	3819	Nov. 13, 2014	Nov. 12, 2015
SPEAG	Dosimetric E-Field Probe	EX3DV4	7346	Jan. 08, 2015	Jan. 07, 2016
SPEAG	SAM Twin Phantom	QD 000 P40 CD	TP-1670	NCR	NCR
SPEAG	SAM Twin Phantom	QD 000 P40 CD	TP-1671	NCR	NCR
SPEAG	ELI4 Phantom	QD OVA 002 AA	TP-1149	NCR	NCR
SPEAG	Phone Positioner	N/A	N/A	NCR	NCR
Agilent	Wireless Communication Test Set	E5515C	MY50267224	Sep. 29, 2014	Sep. 28, 2015
R&S	Network Analyzer	ZVB8	100106	Sep. 29, 2014	Sep. 28, 2015
Speag	Dielectric Assessment KIT	DAK-3.5	1032	NCR	NCR
R&S	Signal Generator	SMBV100A	258305	Jan. 23, 2015	Jan. 22, 2016
Anritsu	Power Sensor	MA2411B	1207253	Jan. 28, 2015	Jan. 27, 2016
Anritsu	Power Meter	ML2495A	1218010	Jan. 28, 2015	Jan. 27, 2016
ARRA	Power Divider	A3200-2	N/A	NA	NA
R&S	Spectrum Analyzer	FSP30	101362	Sep. 29, 2014	Sep. 28, 2015
Agilent	Dual Directional Coupler	778D	50422	Note1	
Woken	Attenuator 1	WK0602-XX	N/A	Note1	
PE	Attenuator 2	PE7005-10	N/A	Note1	
PE	Attenuator 3	PE7005- 3	N/A	Note1	
AR	Power Amplifier	5S1G4M2	0328767	Note1	
Mini-Circuits	Power Amplifier	ZVE-3W	162601250	Note1	
Mini-Circuits	Power Amplifier	ZHL-42W+	13440021344	Note1	

General Note:

1. Prior to system verification and validation, the path loss from the signal generator to the system check source and the power meter, which includes the amplifier, cable, attenuator and directional coupler, was measured by the network analyzer. The reading of the power meter was offset by the path loss difference between the path to the power meter and the path to the system check source to monitor the actual power level fed to the system check source.

10. System Verification

10.1 Tissue Verification

The following tissue formulations are provided for reference only as some of the parameters have not been thoroughly verified. The composition of ingredients may be modified accordingly to achieve the desired target tissue parameters required for routine SAR evaluation.

Frequency (MHz)	Water (%)	Sugar (%)	Cellulose (%)	Salt (%)	Preventol (%)	DGBE (%)	Conductivity (σ)	Permittivity (ϵ_r)
For Head								
835	40.3	57.9	0.2	1.4	0.2	0	0.90	41.5
1800, 1900, 2000	55.2	0	0	0.3	0	44.5	1.40	40.0
2450	55.0	0	0	0	0	45.0	1.80	39.2
For Body								
835	50.8	48.2	0	0.9	0.1	0	0.97	55.2
1800, 1900, 2000	70.2	0	0	0.4	0	29.4	1.52	53.3
2450	68.6	0	0	0	0	31.4	1.95	52.7

<Tissue Dielectric Parameter Check Results>

Frequency (MHz)	Tissue Type	Liquid Temp. (°C)	Conductivity (σ)	Permittivity (ϵ_r)	Conductivity Target (σ)	Permittivity Target (ϵ_r)	Delta (σ) (%)	Delta (ϵ_r) (%)	Limit (%)	Date
835	Body	22.7	0.981	56.230	0.97	55.20	1.13	1.87	±5	Jun. 05, 2015
1900	Body	22.6	1.545	53.535	1.52	53.30	1.64	0.44	±5	Jun. 04, 2015
2450	Body	22.7	1.991	52.320	1.95	52.70	2.10	-0.72	±5	Jun. 12, 2015

10.2 System Performance Check Results

Comparing to the original SAR value provided by SPEAG, the verification data should be within its specification of 10 %. Below table shows the target SAR and measured SAR after normalized to 1W input power. The table below indicates the system performance check can meet the variation criterion and the plots can be referred to Appendix A of this report.

Date	Frequency (MHz)	Tissue Type	Input Power (mW)	Dipole S/N	Probe S/N	DAE S/N	Measured SAR (W/kg)	Targeted SAR (W/kg)	Normalized SAR (W/kg)	Deviation (%)
Jun. 05, 2015	835	Body	250	4d091	3819	1303	2.44	9.60	9.76	1.67
Jun. 04, 2015	1900	Body	250	5d118	7346	1386	9.43	40.00	37.72	-5.70
Jun. 12, 2015	2450	Body	250	840	3819	1303	12.60	51.00	50.4	-1.18

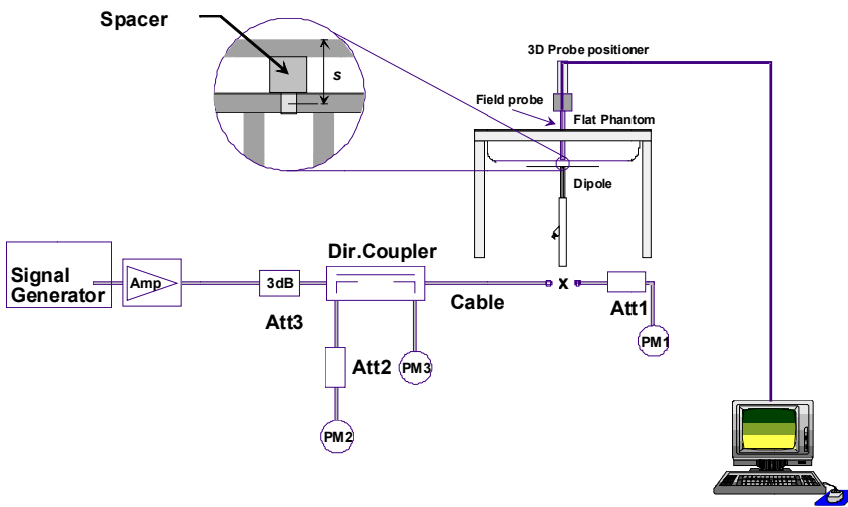

Fig 8.3.1 System Performance Check Setup



Fig 8.3.2 Setup Photo



11. RF Exposure Positions

11.1 Body Position

- (a) To position the device parallel to the phantom surface with either keypad up or down.
- (b) To adjust the device parallel to the flat phantom.
- (c) To adjust the distance between the device surface and the flat phantom to 0 cm.

<EUT Setup Photos>

Please refer to Appendix D for the test setup photos.

12. Conducted RF Output Power (Unit: dBm)

<GSM Conducted Power>

- Per KDB 447498 D01v05r02, the maximum output power channel is used for SAR testing and for further SAR test reduction.
- Per KDB 941225 D01v03, for body SAR test reduction for GPRS and EDGE modes is determined by the source-based time-averaged output power including tune-up tolerance, for modes with the same specified maximum output power and tolerance, the higher number time-slot configuration should be tested, therefore, the EUT was set in GPRS (2Tx slots) for GSM850/GSM1900.

Band GSM850	Burst Average Power (dBm)			Tune-up Limit (dBm)	Frame-Average Power (dBm)			Tune-up Limit (dBm)	
	TX Channel	128	189		251	128	189		251
Frequency (MHz)	824.2	836.4	848.8		824.2	836.4	848.8		
GPRS (GMSK, 1 Tx slot) – CS1	32.09	32.17	31.80	32.5	23.09	23.17	22.80	23.5	
GPRS (GMSK, 2 Tx slots) – CS1	32.04	32.13	31.77	32.5	26.04	26.13	25.77	26.5	
EDGE (8PSK, 1 Tx slot) – MCS5	26.72	26.73	26.41	27.0	17.72	17.73	17.41	18.0	
EDGE (8PSK, 2 Tx slots) – MCS5	26.69	26.70	26.39	27.0	20.69	20.70	20.39	21.0	
EDGE (8PSK, 3 Tx slots) – MCS5	26.54	26.59	26.33	27.0	22.28	22.33	22.07	22.74	
EDGE (8PSK, 4 Tx slots) – MCS5	26.49	26.58	26.29	27.0	23.49	23.58	23.29	24.0	
Band GSM1900		Burst Average Power (dBm)			Tune-up Limit (dBm)	Frame-Average Power (dBm)			Tune-up Limit (dBm)
TX Channel	512	661	810	512		661	810		
Frequency (MHz)	1850.2	1880	1909.8		1850.2	1880	1909.8		
GPRS (GMSK, 1 Tx slot) – CS1	29.34	28.72	28.12	29.5	20.34	19.72	19.12	20.5	
GPRS (GMSK, 2 Tx slots) – CS1	29.28	28.70	28.11	29.5	23.28	22.70	22.11	23.5	
EDGE (8PSK, 1 Tx slot) – MCS5	25.53	24.92	24.29	26.0	16.53	15.92	15.29	17.0	
EDGE (8PSK, 2 Tx slots) – MCS5	25.49	24.90	24.26	26.0	19.49	18.90	18.26	20.0	
EDGE (8PSK, 3 Tx slots) – MCS5	25.42	24.89	24.25	26.0	21.16	20.63	19.99	21.74	
EDGE (8PSK, 4 Tx slots) – MCS5	25.37	24.86	24.23	26.0	22.37	21.86	21.23	23.0	

Remark: The frame-averaged power is linearly scaled the maximum burst averaged power over 8 time slots. The calculated method are shown as below:

Frame-averaged power = Maximum burst averaged power (1 Tx Slot) - 9 dB

Frame-averaged power = Maximum burst averaged power (2 Tx Slots) - 6 dB

Frame-averaged power = Maximum burst averaged power (3 Tx Slots) - 4.26 dB

Frame-averaged power = Maximum burst averaged power (4 Tx Slots) - 3 dB

<WCDMA Conducted Power>

1. The following tests were conducted according to the test requirements outlines in 3GPP TS 34.121 specification.
A summary of these settings are illustrated below:

HSDPA Setup Configuration:

- a. The EUT was connected to Base Station Agilent E5515C referred to the Setup Configuration.
- b. The RF path losses were compensated into the measurements.
- c. A call was established between EUT and Base Station with following setting:
 - i. Set Gain Factors (β_c and β_d) and parameters were set according to each
 - ii. Specific sub-test in the following table, C10.1.4, quoted from the TS 34.121
 - iii. Set RMC 12.2Kbps + HSDPA mode.
 - iv. Set Cell Power = -86 dBm
 - v. Set HS-DSCH Configuration Type to FRC (H-set 1, QPSK)
 - vi. Select HSDPA Uplink Parameters
 - vii. Set Delta ACK, Delta NACK and Delta CQI = 8
 - viii. Set Ack-Nack Repetition Factor to 3
 - ix. Set CQI Feedback Cycle (k) to 4 ms
 - x. Set CQI Repetition Factor to 2
 - xi. Power Ctrl Mode = All Up bits
- d. The transmitted maximum output power was recorded.

Table C.10.1.4: β values for transmitter characteristics tests with HS-DPCCH

Sub-test	β_c	β_d	β_d (SF)	β_c/β_d	β_{HS} (Note 1, Note 2)	CM (dB) (Note 3)	MPR (dB) (Note 3)
1	2/15	15/15	64	2/15	4/15	0.0	0.0
2	12/15 (Note 4)	15/15 (Note 4)	64	12/15 (Note 4)	24/15	1.0	0.0
3	15/15	8/15	64	15/8	30/15	1.5	0.5
4	15/15	4/15	64	15/4	30/15	1.5	0.5

Note 1: $\Delta_{ACK}, \Delta_{NACK}$ and $\Delta_{CQI} = 30/15$ with $\beta_{HS} = 30/15 * \beta_c$.

Note 2: For the HS-DPCCH power mask requirement test in clause 5.2C, 5.7A, and the Error Vector Magnitude (EVM) with HS-DPCCH test in clause 5.13.1A, and HSDPA EVM with phase discontinuity in clause 5.13.1AA, Δ_{ACK} and $\Delta_{NACK} = 30/15$ with $\beta_{HS} = 30/15 * \beta_c$, and $\Delta_{CQI} = 24/15$ with $\beta_{HS} = 24/15 * \beta_c$.

Note 3: CM = 1 for $\beta_c/\beta_d = 12/15$, $\beta_{HS}/\beta_c = 24/15$. For all other combinations of DPDCCH, DPCCH and HS-DPCCH the MPR is based on the relative CM difference. This is applicable for only UEs that support HSDPA in release 6 and later releases.

Note 4: For subtest 2 the β_c/β_d ratio of 12/15 for the TFC during the measurement period (TF1, TF0) is achieved by setting the signalled gain factors for the reference TFC (TF1, TF1) to $\beta_c = 11/15$ and $\beta_d = 15/15$.

Setup Configuration



<WCDMA Conducted Power>

General Note:

1. Per KDB 941225 D01v03, SAR for Body exposure is measured using a 12.2 kbps RMC with TPC bits configured to all "1's".
2. Per KDB 941225 D01v03, RMC 12.2kbps setting is used to evaluate SAR. If the maximum output power and tune-up tolerance specified for production units in HSDPA is $\leq \frac{1}{4}$ dB higher than RMC 12.2Kbps or when the highest reported SAR of the RMC12.2Kbps is scaled by the ratio of specified maximum output power and tune-up tolerance of HSDPA to RMC12.2Kbps and the adjusted SAR is ≤ 1.2 W/kg, SAR measurement is not required for HSDPA.

Band			WCDMA Band V			WCDMA Band II		
TX Channel			4132	4182	4233	9262	9400	9538
Rx Channel			4357	4407	4458	9662	9800	9938
Frequency (MHz)			826.4	836.4	846.6	1852.4	1880	1907.6
MPR (dB)	3GPP Rel 99	RMC 12.2Kbps	22.64	22.45	23.16	21.65	22.45	22.60
0	3GPP Rel 5	HSDPA Subtest-1	22.14	21.57	22.26	20.62	21.20	21.18
0	3GPP Rel 5	HSDPA Subtest-2	22.22	21.55	22.20	20.62	21.24	21.09
0.5	3GPP Rel 5	HSDPA Subtest-3	21.66	21.06	21.73	20.59	21.25	21.15
0.5	3GPP Rel 5	HSDPA Subtest-4	20.71	20.06	20.69	19.53	20.25	20.10

**<WLAN Conducted Power>****General Note:**

1. Per KDB 248227 D01v02r01, SAR test reduction is determined according to 802.11 transmission mode configurations and certain exposure conditions with multiple test positions. In the 2.4 GHz band, separate SAR procedures are applied to DSSS and OFDM configurations to simplify DSSS test requirements. For OFDM, in both 2.4 and 5 GHz bands, an initial test configuration must be determined for each standalone and aggregated frequency band, according to the transmission mode configuration with the highest maximum output power specified for production units to perform SAR measurements. If the same highest maximum output power applies to different combinations of channel bandwidths, modulations and data rates, additional procedures are applied to determine which test configurations require SAR measurement. When applicable, an initial test position may be applied to reduce the number of SAR measurements required for next to the ear, UMPC mini-tablet or hotspot mode configurations with multiple test positions.
2. For 2.4 GHz 802.11b DSSS, either the initial test position procedure for multiple exposure test positions or the DSSS procedure for fixed exposure position is applied; these are mutually exclusive. For 2.4 GHz and 5 GHz OFDM configurations, the initial test configuration is applied to measure SAR using either the initial test position procedure for multiple exposure test position configurations or the initial test configuration procedures for fixed exposure test conditions. Based on the reported SAR of the measured configurations and maximum output power of the transmission mode configurations that are not included in the initial test configuration, the subsequent test configuration and initial test position procedures are applied to determine if SAR measurements are required for the remaining OFDM transmission configurations. In general, the number of test channels that require SAR measurement is minimized based on maximum output power measured for the test sample(s).
3. For OFDM transmission configurations in the 2.4 GHz and 5 GHz bands, When the same maximum power is specified for multiple transmission modes in a frequency band, the largest channel bandwidth, lowest order modulation, lowest data rate and lowest order 802.11a/g/n/ac mode is used for SAR measurement, on the highest measured output power channel for each frequency band.
4. DSSS and OFDM configurations are considered separately according to the required SAR procedures. SAR is measured in the initial test position using the 802.11 transmission mode configuration required by the DSSS procedure or initial test configuration and subsequent test configuration(s) according to the OFDM procedures.18 The initial test position procedure is described in the following:
 - a. When the reported SAR of the initial test position is ≤ 0.4 W/kg, further SAR measurement is not required for the other test positions in that exposure configuration and 802.11 transmission mode combinations within the frequency band or aggregated band.
 - b. When the reported SAR of the test position is > 0.4 W/kg, SAR is repeated for the 802.11 transmission mode configuration tested in the initial test position to measure the subsequent next closet/smallest test separation distance and maximum coupling test position on the highest maximum output power channel, until the report SAR is ≤ 0.8 W/kg or all required test position are tested.
 - c. For all positions/configurations, when the reported SAR is > 0.8 W/kg, SAR is measured for these test positions/configurations on the subsequent next highest measured output power channel(s) until the reported SAR is ≤ 1.2 W/kg or all required channels are tested.



<2.4GHz WLAN>

	Mode	Channel	Frequency (MHz)	Data Rate	Average power (dBm)
2.4GHz WLAN	802.11b	CH 1	2412	1Mbps	14.84
		CH 6	2437		14.61
		CH 11	2462		14.25
	802.11g	CH 1	2412	6Mbps	14.80
		CH 6	2437		14.53
		CH 11	2462		14.13
	802.11n-HT20	CH 1	2412	MCS0	13.30
		CH 6	2437		13.12
		CH 11	2462		12.71

13. Antenna Location

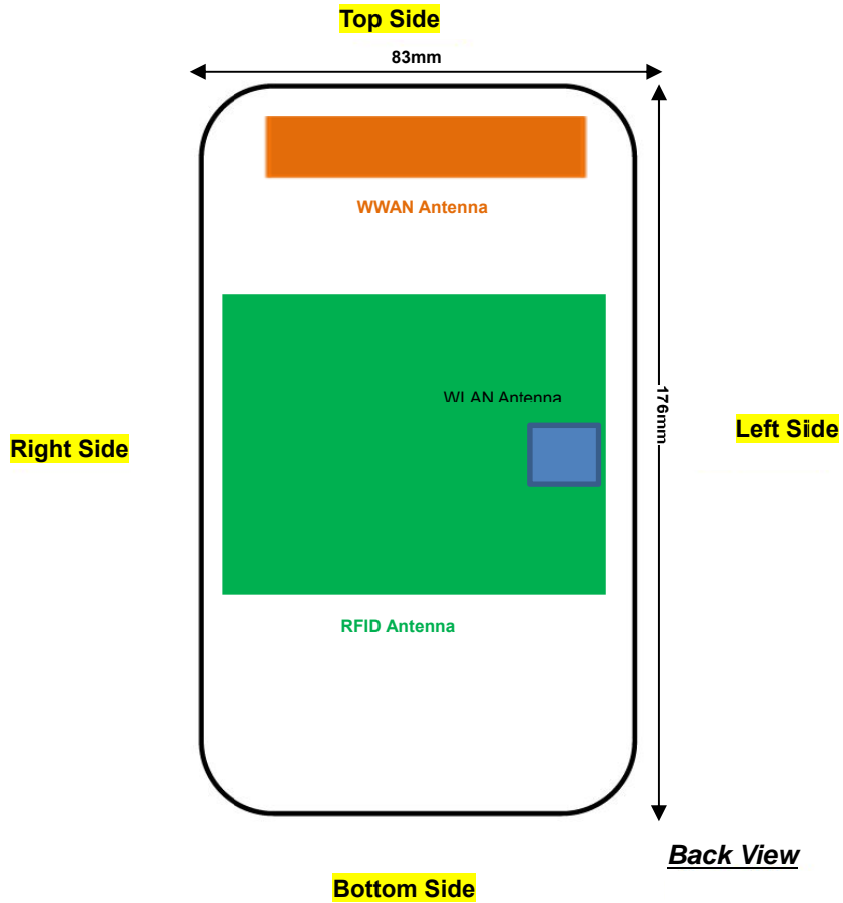



14. SAR Test Results

General Note:

1. Per KDB 447498 D01v05r02, the reported SAR is the measured SAR value adjusted for maximum tune-up tolerance.
 - a. Tune-up scaling Factor = tune-up limit power (mW) / EUT RF power (mW), where tune-up limit is the maximum rated power among all production units.
 - b. Reported SAR(W/kg)= Measured SAR(W/kg)*Tune-up Scaling Factor
2. Per KDB 447498 D01v05r02, for each exposure position, testing of other required channels within the operating mode of a frequency band is not required when the *reported* 1-g or 10-g SAR for the mid-band or highest output power channel is:
 - ≤ 0.8 W/kg or 2.0 W/kg, for 1-g or 10-g respectively, when the transmission band is ≤ 100 MHz
 - ≤ 0.6 W/kg or 1.5 W/kg, for 1-g or 10-g respectively, when the transmission band is between 100 MHz and 200 MHz
 - ≤ 0.4 W/kg or 1.0 W/kg, for 1-g or 10-g respectively, when the transmission band is ≥ 200 MHz
3. Per KDB 941225 D01v03, for body SAR test reduction for GPRS and EDGE modes is determined by the source-based time-averaged output power including tune-up tolerance, for modes with the same specified maximum output power and tolerance, the higher number time-slot configuration should be tested, therefore, the EUT was set in GPRS (2Tx slots) for GSM850/GSM1900.
4. Per KDB 941225 D01v03, SAR for Body exposure is measured using a 12.2 kbps RMC with TPC bits configured to all "1's".
5. Per KDB 941225 D01v03, RMC 12.2kbps setting is used to evaluate SAR. If the maximum output power and tune-up tolerance specified for production units in HSDPA is $\leq \frac{1}{4}$ dB higher than RMC 12.2Kbps or when the highest reported SAR of the RMC12.2Kbps is scaled by the ratio of specified maximum output power and tune-up tolerance of HSDPA to RMC12.2Kbps and the adjusted SAR is ≤ 1.2 W/kg, SAR measurement is not required for HSDPA.
6. Per KDB 248227 D01v02r01, for 2.4GHz 802.11g/n SAR testing is not required when the highest reported SAR for DSSS is adjusted by the ratio of OFDM to DSSS specified maximum output power and the adjusted SAR is ≤ 1.2 W/kg.
7. When the reported SAR of the test position is > 0.4 W/kg, SAR is repeated for the 802.11 transmission mode configuration tested in the initial test position to measure the subsequent next closet/smallest test separation distance and maximum coupling test position on the highest maximum output power channel, until the report SAR is ≤ 0.8 W/kg or all required test position are tested.
8. For all positions / configurations, when the reported SAR is > 0.8 W/kg, SAR is measured for these test positions / configurations on the subsequent next highest measured output power channel(s) until the reported SAR is ≤ 1.2 W/kg or all required channels are tested.
9. During SAR testing the WLAN transmission was verified using a spectrum analyzer.



14.1 Body SAR

<GSM SAR>

Plot No.	Band	Mode	Test Position	Gap (cm)	Ch.	Freq. (MHz)	Average Power (dBm)	Tune-Up Limit (dBm)	Tune-up Scaling Factor	Power Drift (dB)	Measured 1g SAR (W/kg)	Reported 1g SAR (W/kg)
	GSM850	GPRS(2 Tx slots)	Front	0	189	836.4	32.13	32.50	1.089	0.08	0.775	0.844
	GSM850	GPRS(2 Tx slots)	Back	0	189	836.4	32.13	32.50	1.089	0.01	0.282	0.307
	GSM850	GPRS(2 Tx slots)	Front	0	128	824.2	32.04	32.50	1.112	0.05	0.656	0.729
#01	GSM850	GPRS(2 Tx slots)	Front	0	251	848.8	31.77	32.50	1.183	0.09	1.010	1.195
	GSM1900	GPRS(2 Tx slots)	Front	0	512	1850.2	29.28	29.50	1.052	-0.01	0.935	0.984
	GSM1900	GPRS(2 Tx slots)	Back	0	512	1850.2	29.28	29.50	1.052	0.06	0.100	0.105
	GSM1900	GPRS(2 Tx slots)	Front	0	661	1880	28.70	29.50	1.202	-0.06	0.900	1.082
#02	GSM1900	GPRS(2 Tx slots)	Front	0	810	1909.8	28.11	29.50	1.377	-0.11	0.805	1.109

<WCDMA SAR>

Plot No.	Band	Mode	Test Position	Gap (cm)	Ch.	Freq. (MHz)	Average Power (dBm)	Tune-Up Limit (dBm)	Tune-up Scaling Factor	Power Drift (dB)	Measured 1g SAR (W/kg)	Reported 1g SAR (W/kg)
#03	WCDMA Band V	RMC 12.2Kbps	Front	0	4233	846.6	23.16	23.50	1.081	0.02	0.742	0.802
	WCDMA Band V	RMC 12.2Kbps	Back	0	4233	846.6	23.16	23.50	1.081	0.07	0.337	0.364
	WCDMA Band V	RMC 12.2Kbps	Front	0	4132	826.4	22.64	23.50	1.219	0.04	0.643	0.784
	WCDMA Band V	RMC 12.2Kbps	Front	0	4182	836.4	22.45	23.50	1.274	0.03	0.466	0.593
#04	WCDMA Band II	RMC 12.2Kbps	Front	0	9538	1907.6	22.60	23.00	1.096	-0.09	1.070	1.173
	WCDMA Band II	RMC 12.2Kbps	Back	0	9538	1907.6	22.60	23.00	1.096	-0.17	0.122	0.134
	WCDMA Band II	RMC 12.2Kbps	Front	0	9262	1852.4	21.65	23.00	1.365	-0.14	0.794	1.083
	WCDMA Band II	RMC 12.2Kbps	Front	0	9400	1880	22.45	23.00	1.135	-0.03	0.991	1.125

<WLAN SAR>

Plot No.	Band	Mode	Test Position	Gap (cm)	Ch.	Freq. (MHz)	Average Power (dBm)	Tune-Up Limit (dBm)	Tune-up Scaling Factor	Power Drift (dB)	Measured 1g SAR (W/kg)	Reported 1g SAR (W/kg)
#05	WLAN 2.4GHz	802.11b, 1Mbps	Front	0	1	2412	14.84	15.50	1.164	0.08	0.052	0.061
	WLAN 2.4GHz	802.11b, 1Mbps	Back	0	1	2412	14.84	15.50	1.164	0.1	0.00795	0.009
	WLAN 2.4GHz	802.11b, 1Mbps	Front	0	6	2437	14.61	15.00	1.094	0.02	0.052	0.057
	WLAN 2.4GHz	802.11b, 1Mbps	Front	0	11	2462	14.25	15.00	1.189	0.08	0.048	0.057

14.2 Repeated SAR Measurement

No.	Band	Mode	Test Position	Gap (cm)	Ch.	Freq. (MHz)	Average Power (dBm)	Tune-Up Limit (dBm)	Tune-up Scaling Factor	Power Drift (dB)	Measured 1g SAR (W/kg)	Ratio	Reported 1g SAR (W/kg)
1st	GSM850	GPRS(2 Tx slots)	Front	0	251	848.8	31.77	32.50	1.183	0.09	1.010	1	1.195
2nd	GSM850	GPRS(2 Tx slots)	Front	0	251	848.8	31.77	32.50	1.183	-0.05	0.998	1.012	1.181
1st	WCDMA Band II	RMC 12.2Kbps	Front	0	9538	1907.6	22.60	23.00	1.096	-0.09	1.070	1	1.173
2nd	WCDMA Band II	RMC 12.2Kbps	Front	0	9538	1907.6	22.60	23.00	1.096	-0.09	0.992	1.078	1.088

General Note:

1. Per KDB 865664 D01v01r03, for each frequency band, repeated SAR measurement is required only when the measured SAR is $\geq 0.8W/kg$.
2. Per KDB 865664 D01v01r03, if the ratio among the repeated measurement is ≤ 1.2 and the measured SAR $< 1.45W/kg$, only one repeated measurement is required.
3. The ratio is the difference in percentage between original and repeated *measured SAR*.
4. All measurement SAR result is scaled-up to account for tune-up tolerance and is compliant.

15. Simultaneous Transmission Analysis

NO.	Simultaneous Transmission Configurations	Body	Note
1.	GPRS/EDGE(Data) + WLAN2.4GHz(data)	Yes	2.4GHz Hotspot
2.	WCDMA(Data) + WLAN2.4GHz(data)	Yes	2.4GHz Hotspot

General Note:

1. The Scaled SAR summation is calculated based on the same configuration and test position.
2. Per KDB 447498 D01v05r02, simultaneous transmission SAR is compliant if,
 - i) Scalar SAR summation < 1.6W/kg.
 - ii) $SPLSR = (SAR_1 + SAR_2)^{1.5} / (min. \text{ separation distance, mm})$, and the peak separation distance is determined from the square root of $[(x_1-x_2)^2 + (y_1-y_2)^2 + (z_1-z_2)^2]$, where (x_1, y_1, z_1) and (x_2, y_2, z_2) are the coordinates of the extrapolated peak SAR locations in the zoom scan.
 - iii) If $SPLSR \leq 0.04$, simultaneously transmission SAR measurement is not necessary.
 - iv) Simultaneously transmission SAR measurement, and the reported multi-band SAR < 1.6W/kg.

15.1 Body Accessory Exposure Conditions

WWAN Band		Exposure Position	WWAN	WLAN	Summed SAR (W/kg)
			SAR (W/kg)	SAR (W/kg)	
GSM	GSM850	Front	1.195	0.061	1.26
		Back	0.307	0.009	0.32
	GSM1900	Front	1.109	0.061	1.17
		Back	0.105	0.009	0.11
WCDMA	Band V	Front	0.802	0.061	0.86
		Back	0.364	0.009	0.37
	Band II	Front	1.173	0.061	1.23
		Back	0.134	0.009	0.14

Test Engineer : Luke Lu

16. Uncertainty Assessment

The component of uncertainty may generally be categorized according to the methods used to evaluate them. The evaluation of uncertainty by the statistical analysis of a series of observations is termed a Type A evaluation of uncertainty. The evaluation of uncertainty by means other than the statistical analysis of a series of observation is termed a Type B evaluation of uncertainty. Each component of uncertainty, however evaluated, is represented by an estimated standard deviation, termed standard uncertainty, which is determined by the positive square root of the estimated variance.

A Type A evaluation of standard uncertainty may be based on any valid statistical method for treating data. This includes calculating the standard deviation of the mean of a series of independent observations; using the method of least squares to fit a curve to the data in order to estimate the parameter of the curve and their standard deviations; or carrying out an analysis of variance in order to identify and quantify random effects in certain kinds of measurement.

A type B evaluation of standard uncertainty is typically based on scientific judgment using all of the relevant information available. These may include previous measurement data, experience, and knowledge of the behavior and properties of relevant materials and instruments, manufacture’s specification, data provided in calibration reports and uncertainties assigned to reference data taken from handbooks. Broadly speaking, the uncertainty is either obtained from an outdoor source or obtained from an assumed distribution, such as the normal distribution, rectangular or triangular distributions indicated in table below.

Uncertainty Distributions	Normal	Rectangular	Triangular	U-Shape
Multi-plying Factor ^(a)	1/k ^(b)	1/√3	1/√6	1/√2

(a) standard uncertainty is determined as the product of the multiplying factor and the estimated range of variations in the measured quantity

(b) κ is the coverage factor

Table 16.1. Standard Uncertainty for Assumed Distribution

The combined standard uncertainty of the measurement result represents the estimated standard deviation of the result. It is obtained by combining the individual standard uncertainties of both Type A and Type B evaluation using the usual “root-sum-squares” (RSS) methods of combining standard deviations by taking the positive square root of the estimated variances.

Expanded uncertainty is a measure of uncertainty that defines an interval about the measurement result within which the measured value is confidently believed to lie. It is obtained by multiplying the combined standard uncertainty by a coverage factor. Typically, the coverage factor ranges from 2 to 3. Using a coverage factor allows the true value of a measured quantity to be specified with a defined probability within the specified uncertainty range. For purpose of this document, a coverage factor two is used, which corresponds to confidence interval of about 95 %. The DASY uncertainty Budget is shown in the following tables.

Error Description	Uncertainty Value (±%)	Probability Distribution	Divisor	Ci (1g)	Ci (10g)	Standard Uncertainty (1g)	Standard Uncertainty (10g)
Measurement System							
Probe Calibration	6.0	Normal	1	1	1	± 6.0 %	± 6.0 %
Axial Isotropy	4.7	Rectangular	√3	0.7	0.7	± 1.9 %	± 1.9 %
Hemispherical Isotropy	9.6	Rectangular	√3	0.7	0.7	± 3.9 %	± 3.9 %
Boundary Effects	1.0	Rectangular	√3	1	1	± 0.6 %	± 0.6 %
Linearity	4.7	Rectangular	√3	1	1	± 2.7 %	± 2.7 %
System Detection Limits	1.0	Rectangular	√3	1	1	± 0.6 %	± 0.6 %
Readout Electronics	0.3	Normal	1	1	1	± 0.3 %	± 0.3 %
Response Time	0.8	Rectangular	√3	1	1	± 0.5 %	± 0.5 %
Integration Time	2.6	Rectangular	√3	1	1	± 1.5 %	± 1.5 %
RF Ambient Noise	3.0	Rectangular	√3	1	1	± 1.7 %	± 1.7 %
RF Ambient Reflections	3.0	Rectangular	√3	1	1	± 1.7 %	± 1.7 %
Probe Positioner	0.4	Rectangular	√3	1	1	± 0.2 %	± 0.2 %
Probe Positioning	2.9	Rectangular	√3	1	1	± 1.7 %	± 1.7 %
Max. SAR Eval.	1.0	Rectangular	√3	1	1	± 0.6 %	± 0.6 %
Test Sample Related							
Device Positioning	2.9	Normal	1	1	1	± 2.9 %	± 2.9 %
Device Holder	3.6	Normal	1	1	1	± 3.6 %	± 3.6 %
Power Drift	5.0	Rectangular	√3	1	1	± 2.9 %	± 2.9 %
Phantom and Setup							
Phantom Uncertainty	4.0	Rectangular	√3	1	1	± 2.3 %	± 2.3 %
Liquid Conductivity (Target)	5.0	Rectangular	√3	0.64	0.43	± 1.8 %	± 1.2 %
Liquid Conductivity (Meas.)	2.5	Normal	1	0.64	0.43	± 1.6 %	± 1.1 %
Liquid Permittivity (Target)	5.0	Rectangular	√3	0.6	0.49	± 1.7 %	± 1.4 %
Liquid Permittivity (Meas.)	2.5	Normal	1	0.6	0.49	± 1.5 %	± 1.2 %
Combined Standard Uncertainty						± 11.0 %	± 10.8 %
Coverage Factor for 95 %						K=2	
Expanded Uncertainty						± 22.0 %	± 21.5 %

Table 16.2. Uncertainty Budget for frequency range 300 MHz to 3 GHz



17. References

- [1] FCC 47 CFR Part 2 "Frequency Allocations and Radio Treaty Matters; General Rules and Regulations"
- [2] ANSI/IEEE Std. C95.1-1992, "IEEE Standard for Safety Levels with Respect to Human Exposure to Radio Frequency Electromagnetic Fields, 3 kHz to 300 GHz", September 1992
- [3] IEEE Std. 1528-2003, "Recommended Practice for Determining the Peak Spatial-Average Specific Absorption Rate (SAR) in the Human Head from Wireless Communications Devices: Measurement Techniques", December 2003
- [4] SPEAG DASY System Handbook
- [5] FCC KDB 248227 D01 v02r01, "SAR Guidance for IEEE 802.11 (WiFi) Transmitters", Jun 2015.
- [6] FCC KDB 447498 D01 v05r02, "Mobile and Portable Device RF Exposure Procedures and Equipment Authorization Policies", Feb 2014
- [7] FCC KDB 941225 D01 v03, "3G SAR MEAUREMENT PROCEDURES", Oct 2014
- [8] FCC KDB 865664 D01 v01r03, "SAR Measurement Requirements for 100 MHz to 6 GHz", Feb 2014.
- [9] FCC KDB 865664 D02 v01r01, "RF Exposure Compliance Reporting and Documentation Considerations" May 2013.



Appendix A. Plots of System Performance Check

The plots are shown as follows.

System Check_Body_835MHz_150529

DUT: Dipole 835 MHz

Communication System: UID 0, CW; Frequency: 835 MHz; Duty Cycle: 1:1

Medium: MSL_835_150605 Medium parameters used: $f = 835$ MHz; $\sigma = 0.981$ S/m; $\epsilon_r = 56.23$; $\rho = 1000$ kg/m³

Ambient Temperature : 23.4 °C; Liquid Temperature : 22.7 °C

DASY5 Configuration:

- Probe: EX3DV4 - SN3819; ConvF(9.49, 9.49, 9.49); Calibrated: 2014.11.13;
- Sensor-Surface: 2mm (Mechanical Surface Detection)
- Electronics: DAE4 Sn1303; Calibrated: 2014.12.11
- Phantom: SAM2; Type: QD000P40CD; Serial: TP:1671
- Measurement SW: DASY52, Version 52.8 (7); SEMCAD X Version 14.6.10 (7164)

Pin=250mW/Area Scan (61x61x1): Interpolated grid: dx=15mm, dy=15mm

Maximum value of SAR (interpolated) = 2.63 W/kg

Pin=250mW/Zoom Scan (5x5x7)/Cube 0: Measurement grid: dx=8mm, dy=8mm, dz=5mm

Reference Value = 51.627 V/m; Power Drift = 0.01 dB

Peak SAR (extrapolated) = 3.61 W/kg

SAR(1 g) = 2.44 W/kg; SAR(10 g) = 1.61 W/kg

Maximum value of SAR (measured) = 2.62 W/kg

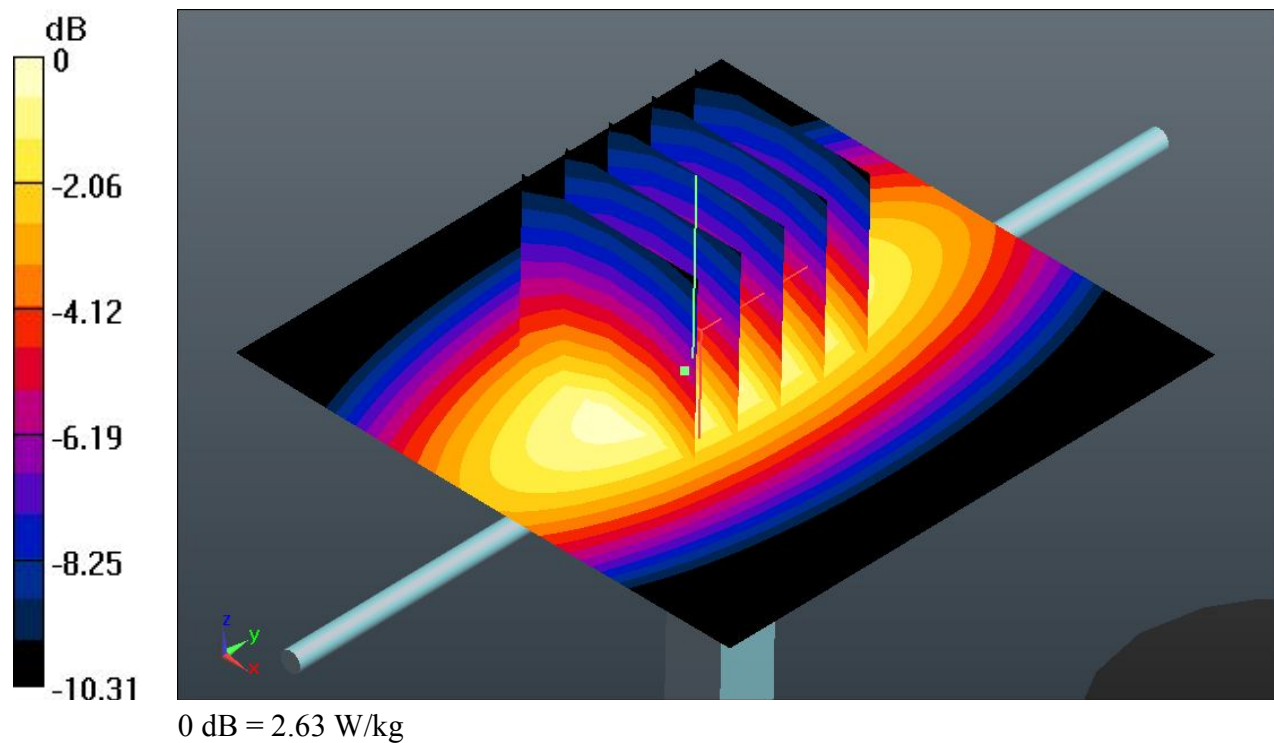

System Check_Body_1900MHz_150604

DUT: Dipole 1900 MHz

Communication System: UID 0, CW; Frequency: 1900 MHz; Duty Cycle: 1:1

Medium: MSL_1900_150604 Medium parameters used: $f = 1900$ MHz; $\sigma = 1.545$ S/m; $\epsilon_r = 53.535$;
 $\rho = 1000$ kg/m³

Ambient Temperature: 23.3 °C ; **Liquid Temperature:** 22.6 °C

DASY5 Configuration:

- Probe: EX3DV4 - SN7346; ConvF(7.57, 7.57, 7.57); Calibrated: 2015.01.08;
- Sensor-Surface: 2mm (Mechanical Surface Detection)
- Electronics: DAE4 Sn1386; Calibrated: 2015.02.19
- Phantom: SAM1; Type: QD000P40CD; Serial: TP:1670
- Measurement SW: DASY52, Version 52.8 (8); SEMCAD X Version 14.6.10 (7164)

Pin=250mW/Area Scan (61x61x1): Interpolated grid: dx=1.500 mm, dy=1.500 mm

Maximum value of SAR (interpolated) = 13.3 W/kg

Pin=250mW/Zoom Scan (5x5x7)/Cube 0: Measurement grid: dx=8mm, dy=8mm, dz=5mm

Reference Value = 82.405 V/m; Power Drift = 0.04 dB

Peak SAR (extrapolated) = 16.8 W/kg

SAR(1 g) = 9.43 W/kg; SAR(10 g) = 4.89 W/kg

Maximum value of SAR (measured) = 13.4 W/kg

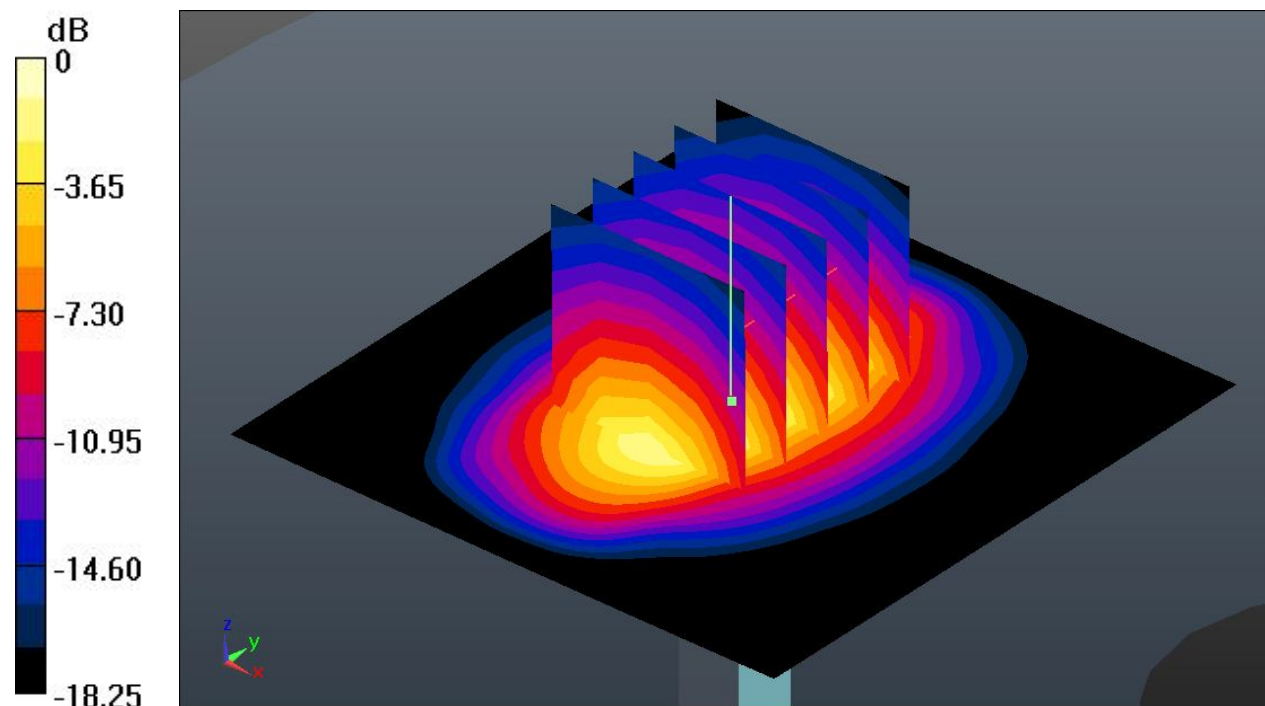

0 dB = 13.3 W/kg

System Check_Body_2450MHz_150612

DUT: Dipole 2450 MHz

Communication System: UID 0, CW; Frequency: 2450 MHz;Duty Cycle: 1:1

Medium: MSL_2450_150612 Medium parameters used: $f = 2450$ MHz; $\sigma = 1.991$ S/m; $\epsilon_r = 52.32$; $\rho = 1000$ kg/m³

Ambient Temperature: 23.2 °C ; **Liquid Temperature:** 22.7 °C

DASY5 Configuration:

- Probe: EX3DV4 - SN7346; ConvF(7.23, 7.23, 7.23); Calibrated: 2015.01.08;
- Sensor-Surface: 2mm (Mechanical Surface Detection)
- Electronics: DAE4 Sn1386; Calibrated: 2015.02.19
- Phantom: SAM2; Type: QDOVA001BB; Serial: TP:1233
- Measurement SW: DASY52, Version 52.8 (8);SEMCAD X Version 14.6.10 (7331)

Pin=250mW/Area Scan (81x81x1): Interpolated grid: dx=12mm, dy=12mm

Maximum value of SAR (interpolated) = 15.7 W/kg

Pin=250mW/Zoom Scan (7x7x7)/Cube 0: Measurement grid: dx=5mm, dy=5mm, dz=5mm

Reference Value = 73.05 V/m; Power Drift = 0.08 dB

Peak SAR (extrapolated) = 21.8 W/kg

SAR(1 g) = 12.6 W/kg; SAR(10 g) = 7.03 W/kg

Maximum value of SAR (measured) = 16.0 W/kg

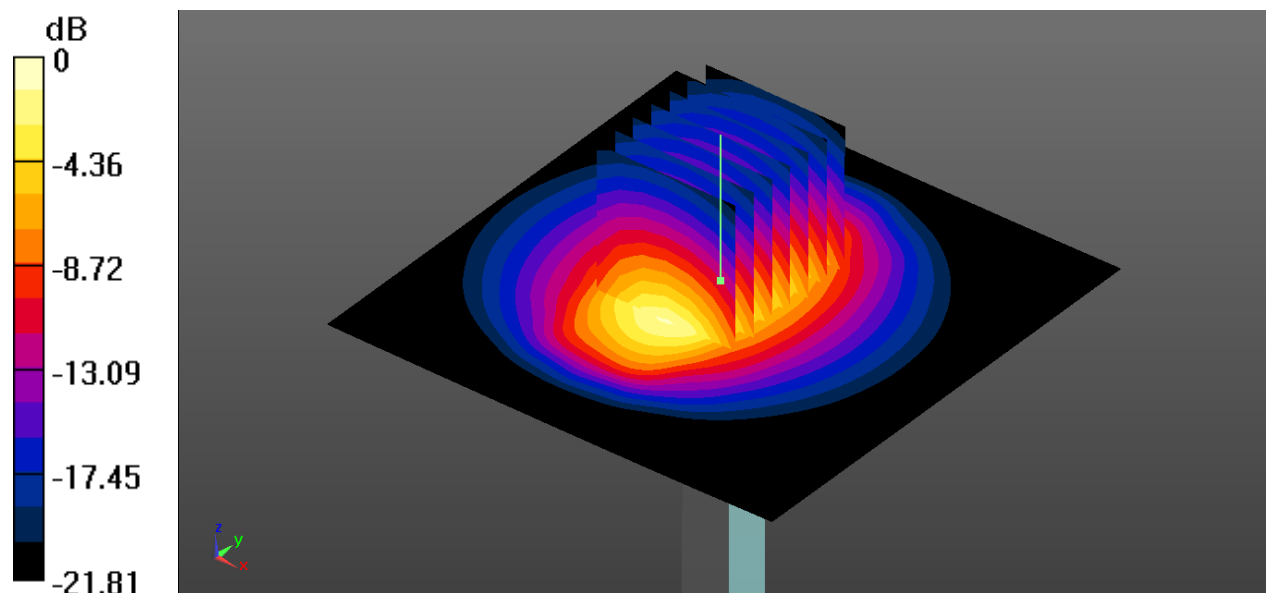

0 dB = 16.0 W/kg



Appendix B. Plots of High SAR Measurement

The plots are shown as follows.

#01_GSM850_GPRS(2 Tx slots)_Front_0mm_Ch251

Communication System: UID 0, GPRS/EDGE10 (0); Frequency: 848.8 MHz; Duty Cycle: 1:4.15
Medium: MSL_835_150605 Medium parameters used: $f = 848.8 \text{ MHz}$; $\sigma = 0.999 \text{ S/m}$; $\epsilon_r = 56.134$; $\rho = 1000 \text{ kg/m}^3$
Ambient Temperature : $23.4 \text{ }^\circ\text{C}$; Liquid Temperature : $22.7 \text{ }^\circ\text{C}$

DASY5 Configuration:

- Probe: EX3DV4 - SN3819; ConvF(9.49, 9.49, 9.49); Calibrated: 2014.11.13;
- Sensor-Surface: 2mm (Mechanical Surface Detection)
- Electronics: DAE4 Sn1303; Calibrated: 2014.12.11
- Phantom: SAM2; Type: QD000P40CD; Serial: TP:1671
- Measurement SW: DASY52, Version 52.8 (7); SEMCAD X Version 14.6.10 (7164)

Ch251/Area Scan (71x131x1): Interpolated grid: $dx=15\text{mm}$, $dy=15\text{mm}$

Maximum value of SAR (interpolated) = 1.29 W/kg

Ch251/Zoom Scan (5x5x7)/Cube 0: Measurement grid: $dx=8\text{mm}$, $dy=8\text{mm}$, $dz=5\text{mm}$

Reference Value = 3.188 V/m ; Power Drift = 0.09 dB

Peak SAR (extrapolated) = 1.62 W/kg

SAR(1 g) = 1.01 W/kg ; SAR(10 g) = 0.618 W/kg

Maximum value of SAR (measured) = 1.32 W/kg

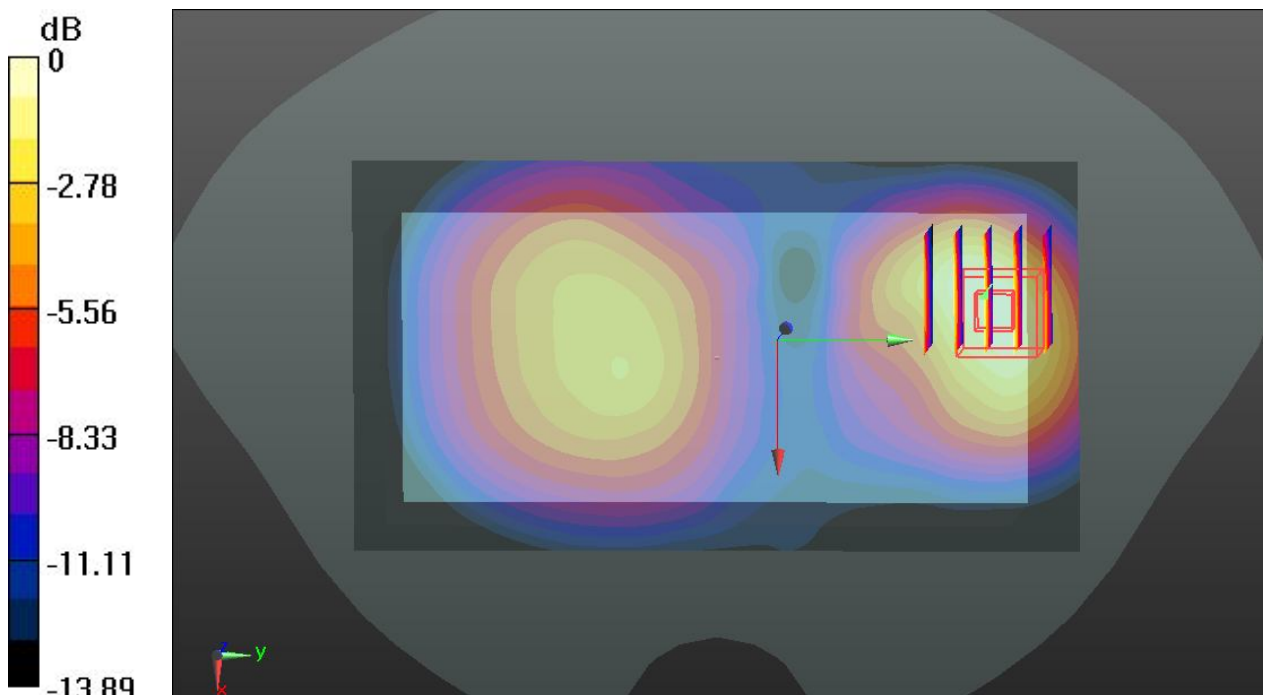

0 dB = 1.29 W/kg

#02_GSM1900_GPRS(2 Tx slots)_Front_0mm_Ch810

Communication System: UID 0, GPRS/EDGE10 (0); Frequency: 1909.8 MHz;Duty Cycle: 1:4.15
Medium: MSL_1900_150604 Medium parameters used: $f = 1909.8$ MHz; $\sigma = 1.557$ S/m; $\epsilon_r = 53.511$;
 $\rho = 1000$ kg/m³

Ambient Temperature: 23.3 °C ; **Liquid Temperature:** 22.6 °C

DASY5 Configuration:

- Probe: EX3DV4 - SN7346; ConvF(7.57, 7.57, 7.57); Calibrated: 2015.01.08;
- Sensor-Surface: 2mm (Mechanical Surface Detection)
- Electronics: DAE4 Sn1386; Calibrated: 2015.02.19
- Phantom: SAM1; Type: QD000P40CD; Serial: TP:1670
- Measurement SW: DASY52, Version 52.8 (7);SEMCAD X Version 14.6.10 (7164)

Ch810/Area Scan (71x131x1): Interpolated grid: dx=15mm, dy=15mm

Maximum value of SAR (interpolated) = 1.12 W/kg

Ch810/Zoom Scan (5x5x7)/Cube 0: Measurement grid: dx=8mm, dy=8mm, dz=5mm

Reference Value = 1.881 V/m; Power Drift = -0.11 dB

Peak SAR (extrapolated) = 1.44 W/kg

SAR(1 g) = 0.805 W/kg; SAR(10 g) = 0.421 W/kg

Maximum value of SAR (measured) = 1.06 W/kg

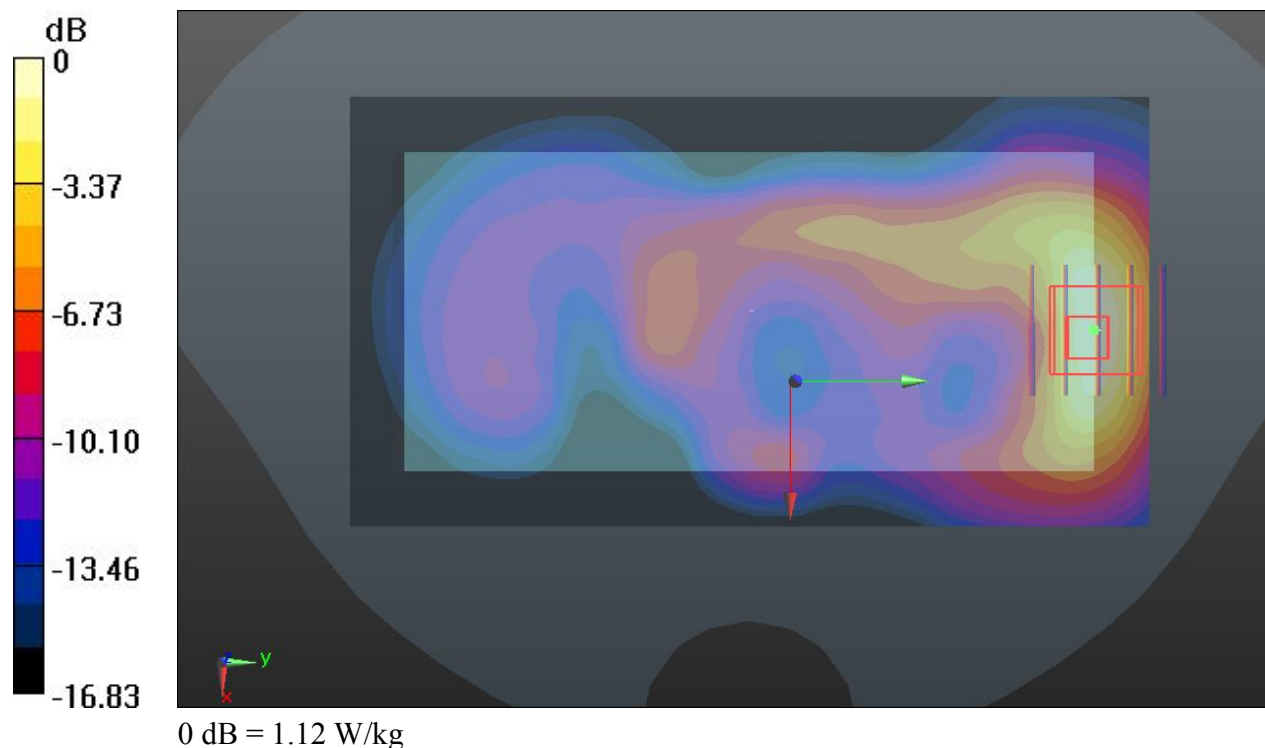

#03_WCDMA Band V_RMC 12.2Kbps_Front_0mm_Ch4233

Communication System: UID 0, UMTS (0); Frequency: 846.6 MHz; Duty Cycle: 1:1
Medium: MSL_835_150605 Medium parameters used: $f = 846.6$ MHz; $\sigma = 0.996$ S/m; $\epsilon_r = 56.151$; $\rho = 1000$ kg/m³
Ambient Temperature : 23.4 °C; Liquid Temperature : 22.7 °C

DASY5 Configuration:

- Probe: EX3DV4 - SN3819; ConvF(9.49, 9.49, 9.49); Calibrated: 2014.11.13;
- Sensor-Surface: 2mm (Mechanical Surface Detection)
- Electronics: DAE4 Sn1303; Calibrated: 2014.12.11
- Phantom: SAM2; Type: QD000P40CD; Serial: TP:1671
- Measurement SW: DASY52, Version 52.8 (7); SEMCAD X Version 14.6.10 (7164)

Ch4233/Area Scan (71x131x1): Interpolated grid: dx=15mm, dy=15mm

Maximum value of SAR (interpolated) = 0.725 W/kg

Ch4233/Zoom Scan (5x5x7)/Cube 0: Measurement grid: dx=8mm, dy=8mm, dz=5mm

Reference Value = 2.512 V/m; Power Drift = 0.02 dB

Peak SAR (extrapolated) = 1.18 W/kg

SAR(1 g) = 0.742 W/kg; SAR(10 g) = 0.444 W/kg

Maximum value of SAR (measured) = 0.931 W/kg

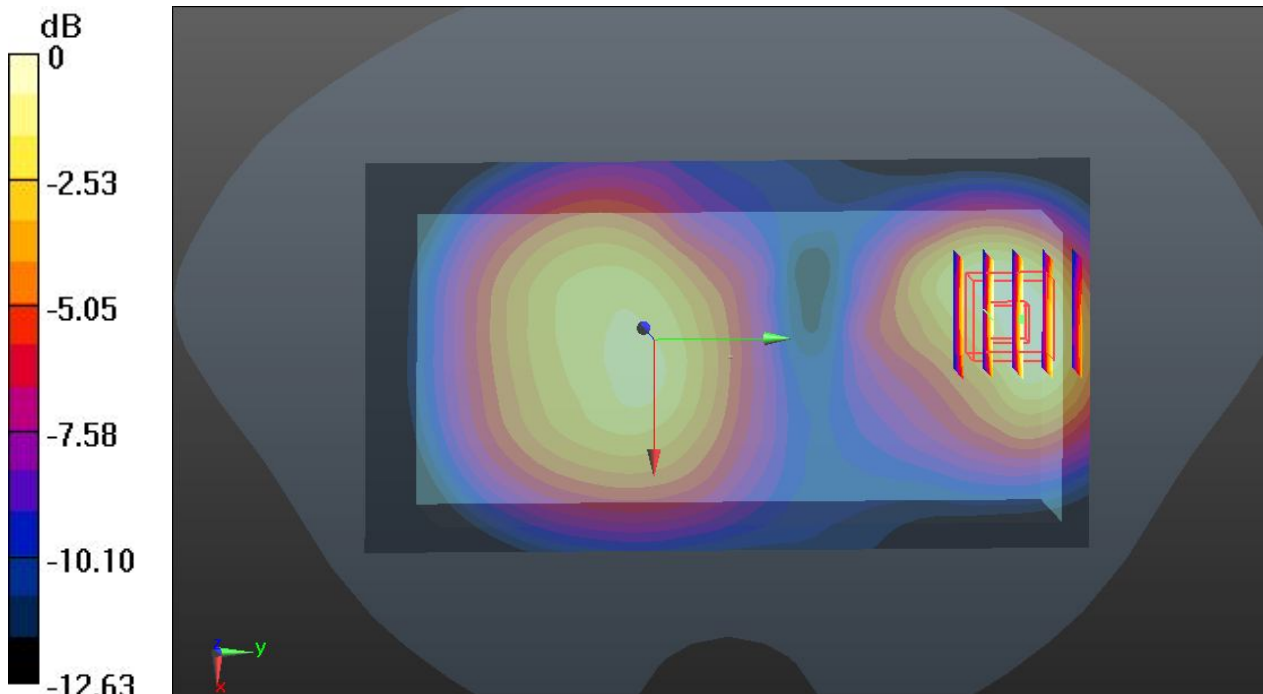

0 dB = 0.725 W/kg

#04_WCDMA Band II_RMC 12.2Kbps_Front_0mm_Ch9538

Communication System: UID 0, UMTS (0); Frequency: 1907.6 MHz;Duty Cycle: 1:1
Medium: MSL_1900_150604 Medium parameters used: $f = 1907.6$ MHz; $\sigma = 1.554$ S/m; $\epsilon_r = 53.517$;
 $\rho = 1000$ kg/m³

Ambient Temperature: 23.3 °C ; **Liquid Temperature:** 22.6 °C

DASY5 Configuration:

- Probe: EX3DV4 - SN7346; ConvF(7.57, 7.57, 7.57); Calibrated: 2015.01.08;
- Sensor-Surface: 2mm (Mechanical Surface Detection)
- Electronics: DAE4 Sn1386; Calibrated: 2015.02.19
- Phantom: SAM1; Type: QD000P40CD; Serial: TP:1670
- Measurement SW: DASY52, Version 52.8 (8);SEMCAD X Version 14.6.10 (7164)

Ch9538/Area Scan (71x131x1): Interpolated grid: dx=15mm, dy=15mm

Maximum value of SAR (interpolated) = 1.50 W/kg

Ch9538/Zoom Scan (5x5x7)/Cube 0: Measurement grid: dx=8mm, dy=8mm, dz=5mm

Reference Value = 2.126 V/m; Power Drift = -0.09 dB

Peak SAR (extrapolated) = 1.90 W/kg

SAR(1 g) = 1.07 W/kg; SAR(10 g) = 0.556 W/kg

Maximum value of SAR (measured) = 1.41 W/kg

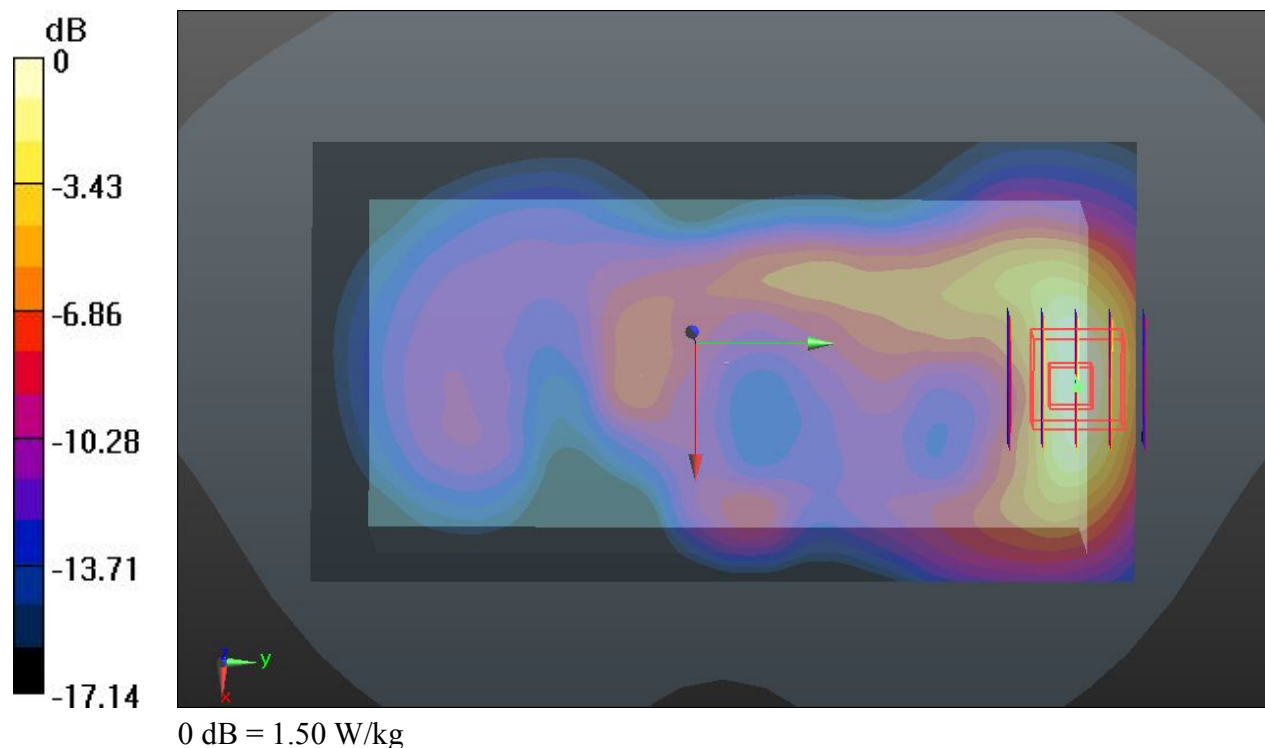

#05_WLAN2.4GHz_802.11b 1Mbps_Front_0mm_Ch1

Communication System: UID 0, WIFI (0); Frequency: 2412 MHz;Duty Cycle: 1:1
Medium: MSL_2450_150612 Medium parameters used: $f = 2412$ MHz; $\sigma = 1.946$ S/m; $\epsilon_r = 52.484$;
 $\rho = 1000$ kg/m³

Ambient Temperature: 23.2 °C ; **Liquid Temperature:** 22.7 °C

DASY5 Configuration:

- Probe: EX3DV4 - SN7346; ConvF(7.23, 7.23, 7.23); Calibrated: 2015.01.08;
- Sensor-Surface: 2mm (Mechanical Surface Detection)
- Electronics: DAE4 Sn1386; Calibrated: 2015.02.19
- Phantom: SAM2; Type: QDOVA001BB; Serial: TP:1233
- Measurement SW: DASY52, Version 52.8 (8);SEMCAD X Version 14.6.10 (7331)

Ch1/Area Scan (91x161x1): Interpolated grid: dx=12mm, dy=12mm

Maximum value of SAR (interpolated) = 0.0706 W/kg

Ch1/Zoom Scan (7x7x7)/Cube 0: Measurement grid: dx=5mm, dy=5mm, dz=5mm

Reference Value = 1.079 V/m; Power Drift = 0.08 dB

Peak SAR (extrapolated) = 0.104 W/kg

SAR(1 g) = 0.052 W/kg; SAR(10 g) = 0.028 W/kg

Maximum value of SAR (measured) = 0.0748 W/kg

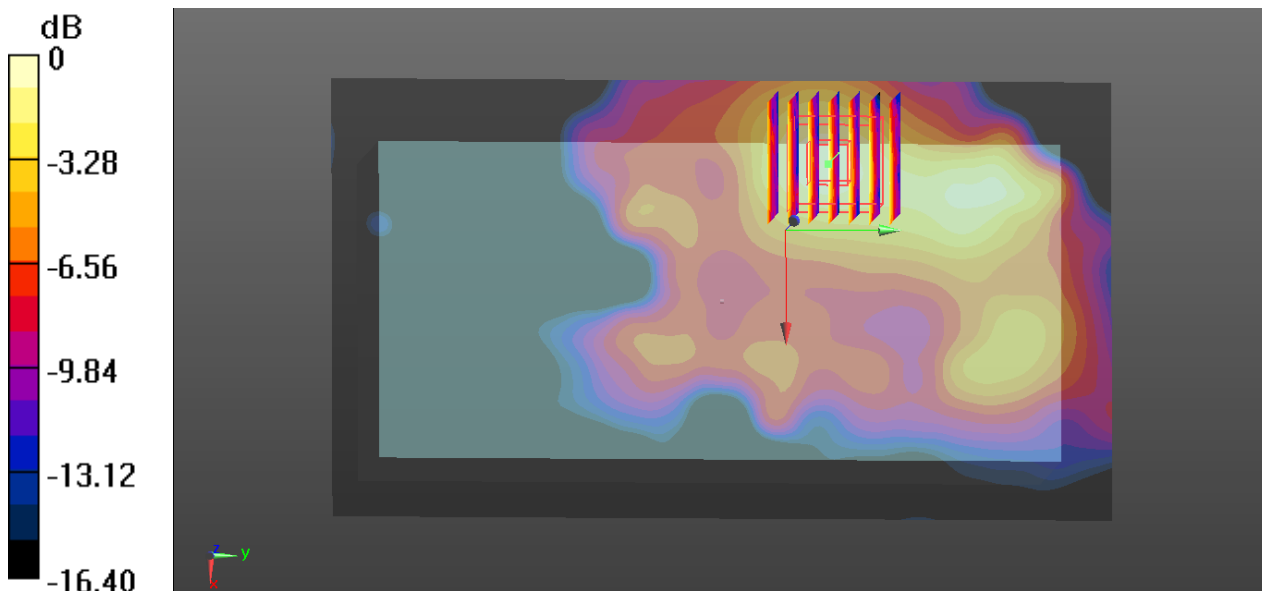

0 dB = 0.0748 W/kg