

FCC RADIO TEST REPORT

according to

47 CFR FCC Part 15 Subpart C § 15.225

Equipment : **Countertop Payment Terminal**
Brand Name : **PAX**
Model No. : **S800**
Filing Type : **New Application**
Applicant : **PAX Technology Limited**
Room 2416, 24/F., Sun Hung Kai Centre, 30 Harbour
Road, Wanchai, Hong Kong
FCC ID : **V5PS800RF**
Manufacturer : **PAX Computer Technology (Shenzhen) Co., Ltd.**
4/F No.3 Building, Software Park, Second Central
Science-Tech Road, High-Tech industrial Park, Shenzhen,
Guangdong, P.R.C.
Received Date : Mar. 18, 2013
Final Test Date : Apr. 13, 2013

Statement

The test result in this report refers exclusively to the presented test model / sample.

Without written approval of Sporton International (Shenzhen) Inc., the test report shall not be reproduced except in full.

The measurements and test results shown in this test report were made in accordance with the procedures and found in compliance with the limit given in **ANSI C63.4-2003 and ANSI C63.10-2009** and **47 CFR FCC Part 15 Subpart C**.

The test equipment used to perform the test is calibrated and traceable to NML/ROC.



SPORTON INTERNATIONAL (SHENZHEN) INC.

**No. 3 Building, the third floor of south, Shahe River west, Fengzeyuan warehouse, Nanshan District,
Shenzhen, Guangdong, P.R.C.**

Table of Contents

1. SUMMARY OF THE TEST RESULT	2
2. GENERAL INFORMATION.....	3
2.1 Product Details.....	3
2.2 Accessories.....	3
2.3 Table for Test Modes.....	4
2.4 Table for Testing Locations.....	4
2.5 Table for Supporting Units.....	4
2.6 Test Configurations.....	5
3. TEST RESULT	6
3.1 AC Power Line Conducted Emissions Measurement.....	6
3.2 Field Strength of Fundamental Emissions and Mask Measurement.....	11
3.3 20dB Spectrum Bandwidth Measurement.....	15
3.4 Radiated Emissions Measurement.....	17
3.5 Frequency Stability Measurement.....	24
3.6 Antenna Requirements.....	27
4. LIST OF MEASURING EQUIPMENT	28
5. TEST LOCATION.....	29
6. TAF CERTIFICATE OF ACCREDITATION.....	30
APPENDIX A. PHOTOGRAPHS OF EUT	A1 ~ A26
APPENDIX B. SETUP PHOTOGRAPHS.....	B1 ~ B2

REVISION HISTORY

REPORT NO.	VERSION	DESCRIPTION	ISSUED DATE
FR331812	Rev. 01	Initial issue of report	May 07, 2013

CERTIFICATE OF COMPLIANCE

according to

47 CFR FCC Part 15 Subpart C § 15.225

Equipment : Countertop Payment Terminal

Brand Name : PAX

Model No. : S800

Applicant : PAX Technology Limited

Room 2416, 24/F., Sun Hung Kai Centre, 30 Harbour
Road, Wanchai, Hong Kong

Sporton International as requested by the applicant to evaluate the EMC performance of the product sample received on Mar. 18, 2013 would like to declare that the tested sample has been evaluated and found to be in compliance with the tested rule parts. The data recorded as well as the test configuration specified is true and accurate for showing the sample's EMC nature.



Jones Tsai / Manager

SPORTON INTERNATIONAL (SHENZHEN) INC.

No. 3 Building, the third floor of south, Shahe River west, Fengzeyuan warehouse, Nanshan District, Shenzhen, Guangdong, P.R.C.

1. SUMMARY OF THE TEST RESULT

Applied Standard: 47 CFR FCC Part 15 Subpart C					
Part	FCC Rule	IC Rule	Description of Test	Result	Under Limit
3.1	15.207	Gen 7.2.2	AC Power Line Conducted Emissions	Complies	8.61dB at 0.430MHz
3.2	15.225(a)(b)(c)	A2.6	Field Strength of Fundamental Emissions	Complies	53.97dB at 13.560MHz
3.3	2.1049	-	20dB Spectrum Bandwidth	Complies	
3.4	15.225(d) 15.209	A2.6	Radiated Emissions	Complies	3.59dB at 500.450MHz
3.5	15.225(e)	A2.6	Frequency Stability	Complies	
3.6	15.203	-	Antenna Requirements	Complies	

Test Items	Uncertainty	Remark
AC Power Line Conducted Emissions	±2.3dB	Confidence levels of 95%
Field Strength of Fundamental Emissions	±0.8dB	Confidence levels of 95%
20dB Spectrum Bandwidth / Frequency Stability	±8.5×10 ⁻⁸	Confidence levels of 95%
Radiated / Band Edge Emissions (9kHz~30MHz)	±0.8dB	Confidence levels of 95%
Radiated Emissions (30MHz~1000MHz)	±1.9dB	Confidence levels of 95%
Temperature	±0.7□	Confidence levels of 95%
Humidity	±3.2%	Confidence levels of 95%
DC / AC Power Source	±1.4%	Confidence levels of 95%

2. GENERAL INFORMATION

2.1 Product Details

For more detailed features description, please refer to the manufacturer's specifications or user's manual.

Items	Description
Power Type	9Vdc from Adapter
Modulation	ASK
Channel Number	1
Channel Band Width (99%)	2.340kHz
Max. Field Strength	70.03dBuV/m
Test Freq. Range	13.553 ~ 13.567MHz
Carrier Frequencies	13.56 MHz (Ch. 1)
Antenna	PCB Antenna

2.2 Accessories

Specification of Accessory		
Adapter	Brand Name	Huntkey
	Model Name	HKA03009025-8E

2.3 Table for Test Modes

Investigation has been done on all the possible configurations for searching the worst cases. The following table is a list of the test modes shown in this test report.

Test Items	Mode	Channel
AC Power Line Conducted Emissions	CTX	-
Field Strength of Fundamental Emissions	CTX	1
20dB Spectrum Bandwidth	CTX	1
Radiated Emissions 9kHz~30MHz	CTX	1
Radiated Emissions 9kHz~10 th Harmonic Band Edge Emissions	CTX	1
Frequency Stability	Un-modulation	1

Note:

- 1, CTX=continuously transmitting.
- 2, The ancillary equipment, NFC card, is used to make the EUT (NFC) continuously transmit at 13.56MHz and is placed around 3 cm gap to the EUT.

2.4 Table for Testing Locations

Test Site No.	Site Category	Location
CO01-SZ	Conduction	Shen Zhen
TH01-SZ	OVEN Room	Shen Zhen
03CH01-KS	SAC	Kun Shan

Semi Anechoic Chamber (SAC).

2.5 Table for Supporting Units

Support Unit	Manufacturer	Model	FCC ID
DC Power Supply	TOPWORD	3303DR	N/A
RF Card	N/A	N/A	N/A

2.6 Test Configurations

<AC Conducted Emissions>

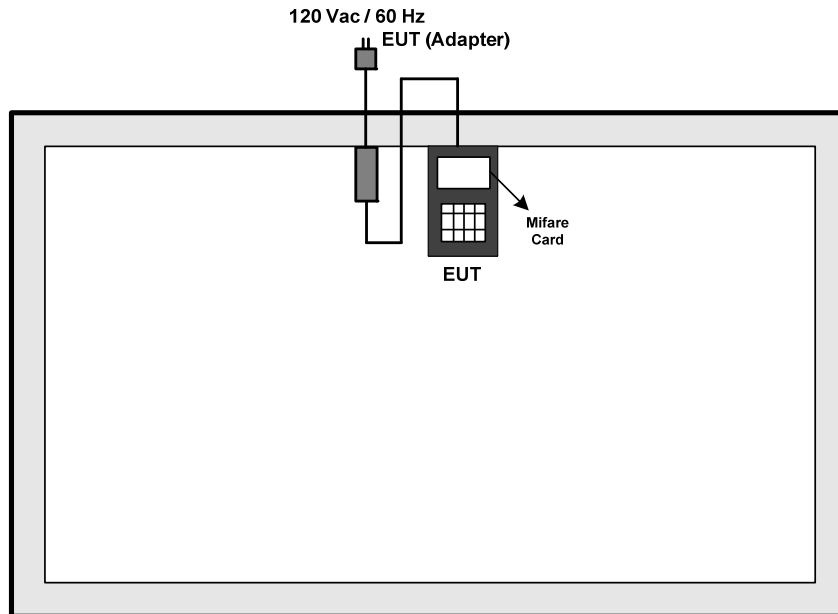

Fundamental Emissions and Mask Measurement

For radiated emissions 9kHz~30MHz/

For radiated emissions 30MHz~1GHz

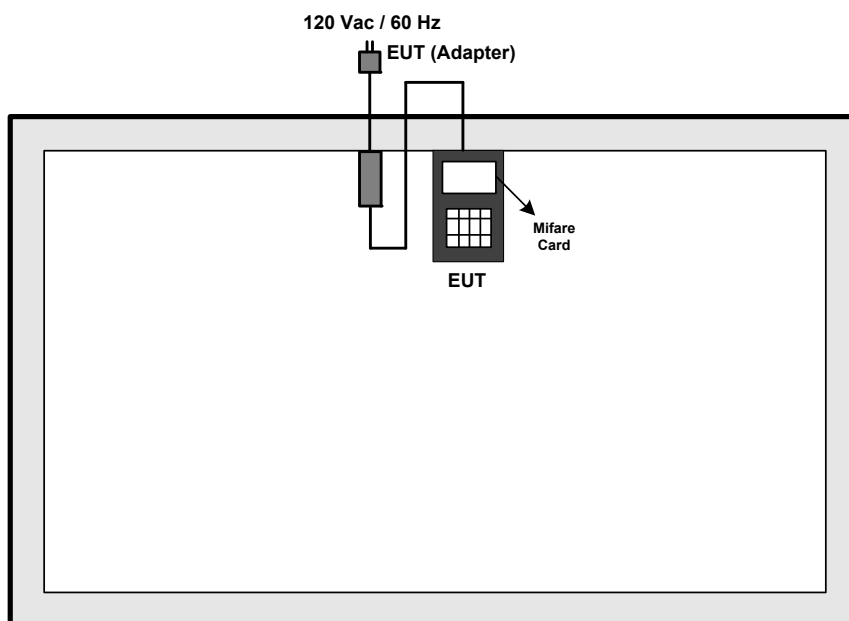

3. TEST RESULT

3.1 AC Power Line Conducted Emissions Measurement

3.1.1 Limit

For a Low-power Radio-frequency device which is designed to be connected to the AC power line, the radio frequency voltage that is conducted back onto the AC power line on any frequency or frequencies within the band 150 kHz to 30 MHz shall not exceed below limits table.

Frequency (MHz)	QP Limit (dBuV)	AV Limit (dBuV)
0.15~0.5	66~56	56~46
0.5~5	56	46
5~30	60	50

3.1.2 Measuring Instruments and Setting

Please refer to section 4 of equipments list in this report. The following table is the setting of the receiver.

Receiver Parameters	Setting
Attenuation	10 dB
Start Frequency	0.15 MHz
Stop Frequency	30 MHz
IF Bandwidth	9 KHz

3.1.3 Test Procedures

1. Configure the EUT according to ANSI C63.4. The EUT or host of EUT has to be placed 0.4 meter far from the conducting wall of the shielding room and at least 80 centimeters from any other grounded conducting surface.
2. Connect EUT or host of EUT to the power mains through a line impedance stabilization network (LISN).
3. All the support units are connected to the other LISNs. The LISN should provide 50uH/50ohms coupling impedance.
4. The frequency range from 150 KHz to 30 MHz was searched.
5. Set the test-receiver system to Peak Detect Function and Specified Bandwidth with Maximum Hold Mode.
6. The measurement has to be done between each power line and ground at the power terminal.

3.1.4 Test Setup Layout

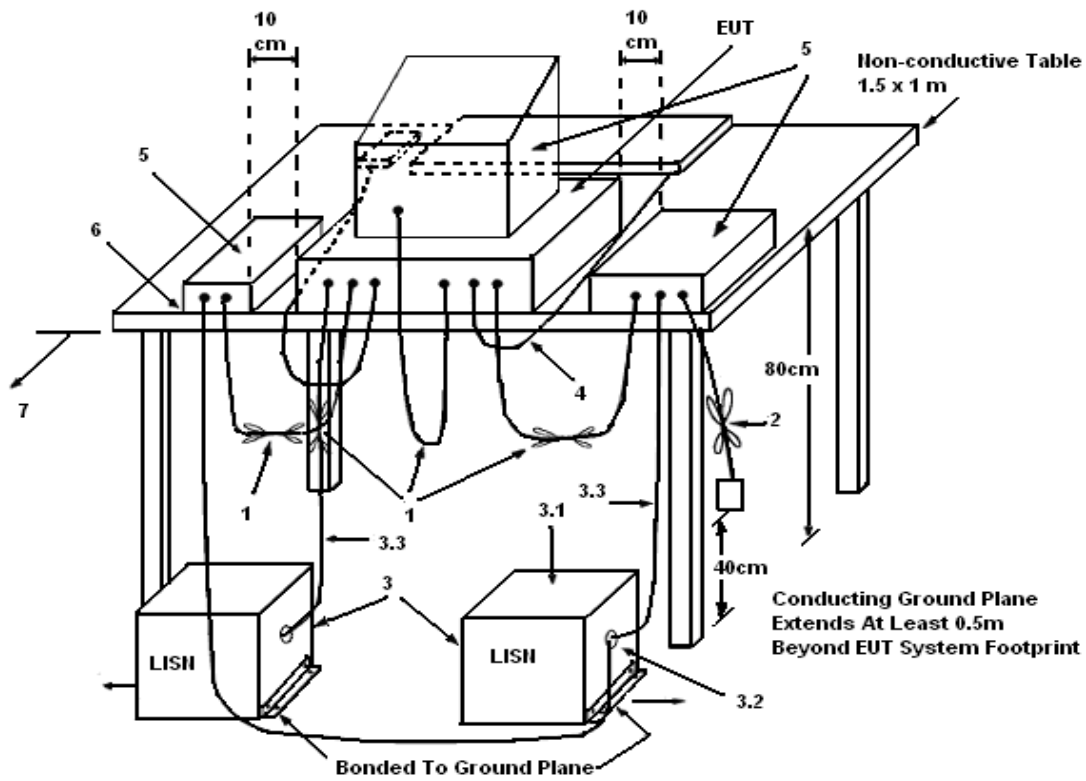

LEGEND:

- (1) Interconnecting cables that hang closer than 40 cm to the ground plane shall be folded back and forth in the center forming a bundle 30 to 40 cm long.
- (2) I/O cables that are not connected to a peripheral shall be bundled in the center. The end of the cable may be terminated, if required, using the correct terminating impedance. The overall length shall not exceed 1 m.
- (3) EUT connected to one LISN. Unused LISN measuring port connectors shall be terminated in 50 Ω. LISN can be placed on top of, or immediately beneath, reference ground plane.
 - (3.1) All other equipment powered from additional LISN(s).
 - (3.2) Multiple outlet strip can be used for multiple power cords of non-EUT equipment.
 - (3.3) LISN at least 80 cm from nearest part of EUT chassis.
- (4) Cables of hand-operated devices, such as keyboards, mice, etc., shall be placed as for normal use.
- (5) Non-EUT components of EUT system being tested.
- (6) Rear of EUT, including peripherals, shall all be aligned and flush with rear of tabletop.
- (7) Rear of tabletop shall be 40 cm removed from a vertical conducting plane that is bonded to the ground plane.



3.1.5 Test Deviation

There is no deviation with the original standard.

3.1.6 EUT Operation during Test

The EUT was placed on the test table and programmed in transmitting function.



3.1.7 Results of AC Power Line Conducted Emissions Measurement

Final Test Date	Apr. 02, 2013	Test Site No.	CO01-SZ
Temperature	23~24°C	Humidity	48~49%
Test Engineer	Leo Liao	Configuration	Transmitting Mode (13.56MHz)
Mode	NFC Tx + Adapter		

Line

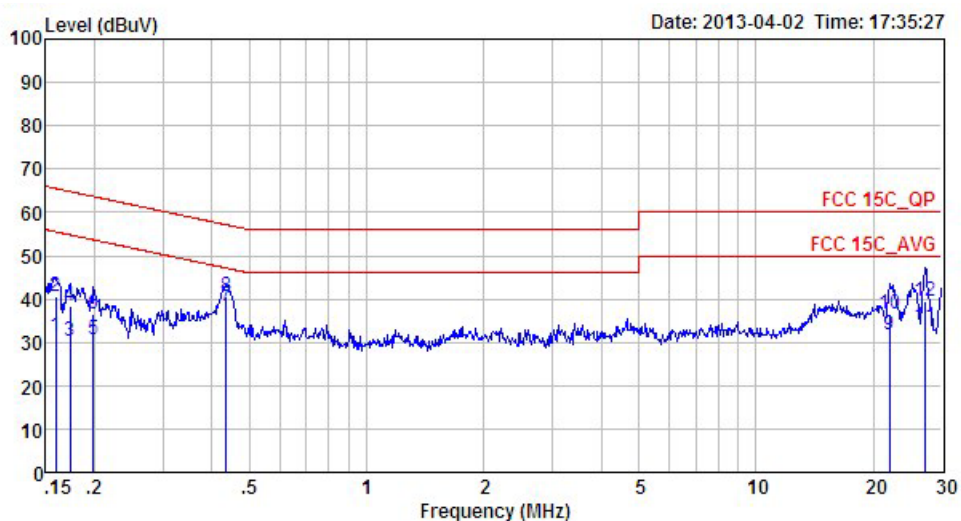

Site : CO01-SZ
 Condition: FCC 15C_QP LISN_L_2000601 LINE
 Project : (FR) 331812

	Freq	Level	Over Limit	Limit Line	Read Level	LISN Factor	Cable Loss	Remark
	MHz	dBuV	dB	dBuV	dBuV	dB	dB	
1	0.16	31.48	-24.04	55.52	21.40	0.03	10.05	Average
2	0.16	40.48	-25.04	65.52	30.40	0.03	10.05	QP
3	0.17	30.08	-24.73	54.81	20.00	0.03	10.05	Average
4	0.17	38.48	-26.33	64.81	28.40	0.03	10.05	QP
5	0.20	30.48	-23.19	53.67	20.39	0.03	10.06	Average
6	0.20	36.68	-26.99	63.67	26.59	0.03	10.06	QP
7 *	0.44	38.40	-8.75	47.15	28.30	0.02	10.08	Average
8	0.44	40.50	-16.65	57.15	30.40	0.02	10.08	QP
9	22.06	31.59	-18.41	50.00	20.70	0.42	10.47	Average
10	22.06	36.49	-23.51	60.00	25.60	0.42	10.47	QP
11	27.27	33.71	-16.29	50.00	22.70	0.58	10.43	Average
12	27.27	39.61	-20.39	60.00	28.60	0.58	10.43	QP



Neutral

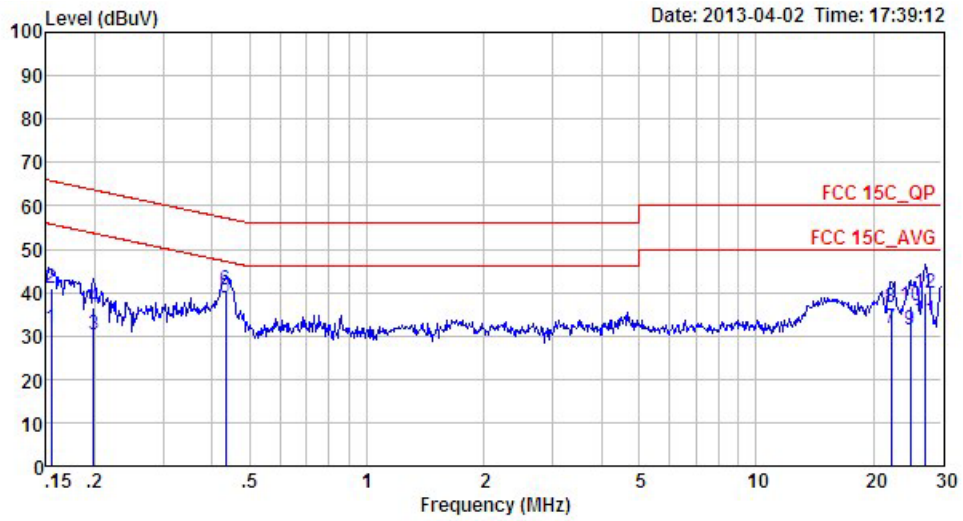

Site : CO01-SZ
 Condition: FCC 15C_QP LISN_N_2000601 NEUTRAL
 Project : (FR) 331812

	Freq	Level	Over	Limit	Read	LISN	Cable	Remark
	MHz	dBuV	Limit	Line	Level	Factor	Loss	
			dB	dBuV	dBuV	dB	dB	
1	0.15	31.77	-23.97	55.74	21.70	0.02	10.05	Average
2	0.15	41.07	-24.67	65.74	31.00	0.02	10.05	QP
3	0.20	30.27	-23.40	53.67	20.19	0.02	10.06	Average
4	0.20	36.57	-27.10	63.67	26.49	0.02	10.06	QP
5 *	0.43	38.59	-8.61	47.20	28.49	0.02	10.08	Average
6	0.43	40.69	-16.51	57.20	30.59	0.02	10.08	QP
7	22.18	31.69	-18.31	50.00	20.60	0.62	10.47	Average
8	22.18	36.69	-23.31	60.00	25.60	0.62	10.47	QP
9	24.92	31.22	-18.78	50.00	20.00	0.80	10.42	Average
10	24.92	37.02	-22.98	60.00	25.80	0.80	10.42	QP
11	27.27	33.74	-16.26	50.00	22.41	0.90	10.43	Average
12	27.27	39.74	-20.26	60.00	28.41	0.90	10.43	QP

Note: Level = Read Level + LISN Factor + Cable Loss.

3.2 Field Strength of Fundamental Emissions and Mask Measurement

3.2.1 Limit

Field strength of fundamental emissions limit:

The field strength of fundamental emissions shall not exceed 15848 microvolts/meter at 30 meters.

The emissions limit in this paragraph is based on measurement instrumentation employing a QP detector.

Frequencies (MHz)	Field Strength (microvolts/meter)	Field Strength (dBµV/m) at 10m	Field Strength (dBµV/m) at 3m
13.553 ~ 13.567MHz	15848 at 30m	103.08 (QP)	124 (QP)

Mask limit:

Rules and specifications	CFR 47 Part 15 section 15.225(a)-(d)				
Description	Compliance with the spectrum mask is tested using a spectrum analyzer with RB set to a 1kHz for the band 13.553~13.567MHz				
Limit	Freq. of Emission (MHz)	Field Strength (uV/m) at 30m	Field Strength (dBuV/m) at 30m	Field Strength (dBuV/m) at 10m	Field Strength (dBuV/m) at 3m
	1.705~13.110	30	29.5	48.58	69.5
	13.110~13.410	106	40.5	59.58	80.5
	13.410~13.553	334	50.5	69.58	90.5
	13.553~13.567	15848	84.0	103.08	124.0
	13.567~13.710	334	50.5	69.58	90.5
	13.710~14.010	106	40.5	59.58	80.5
	14.010~30.000	30	29.5	48.58	69.5

3.2.2 Measuring Instruments and Setting

Please refer to section 4 of equipments list in this report. The following table is the setting of the receiver.

Receiver Parameter	Setting
Attenuation	Auto
Center Frequency	Fundamental Frequency
RB	9 kHz
Detector	QP

3.2.3 Test Procedures

1. Configure the EUT according to ANSI C63.4. The EUT was placed on the top of the turntable 0.8 meter above ground. The phase center of the loop receiving antenna mounted antenna tower was placed 3 meters far away from the turntable.
2. Power on the EUT and all the supporting units. The turntable was rotated by 360 degrees to determine the position of the highest radiation.
3. The height of the receiving antenna was fixed at one meter above ground to find the maximum emissions field strength.
4. For Fundamental emissions, use the receiver to measure QP reading.
5. When the radiated emissions limits are expressed in terms of the average value of the emissions, and pulsed operation is employed, the measurement field strength shall be determined by averaging over one complete pulse train, including blanking intervals, as long as the pulse train does not exceed 0.1 seconds. As an alternative (provided the transmitter operates for longer than 0.1 seconds) or in cases where the pulse train exceeds 0.1 seconds, the measured field strength shall be determined from the average absolute voltage during a 0.1 second interval during which the field strength is at its maximum value.
6. Compliance with the spectrum mask is tested using a spectrum analyzer with RB set to a 1kHz for the band 13.553~13.567MHz.

3.2.4 Test Setup Layout

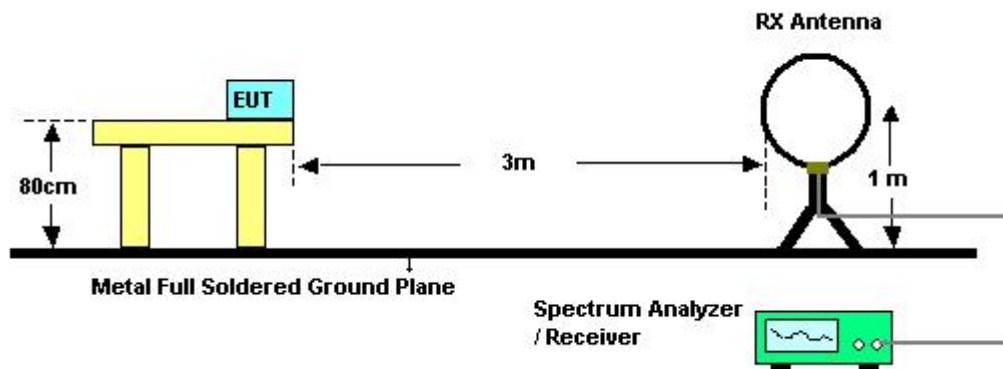

3.2.5 Test Deviation

There is no deviation with the original standard.

3.2.6 EUT Operation during Test

The EUT was programmed to be in continuously transmitting mode.



3.2.7 Test Result of Field Strength of Fundamental Emissions

Final Test Date	Apr. 13, 2013	Test Site No.	03CH01-KS
Temperature	23~24°C	Humidity	43~44%
Test Engineer	Stone Gu	Configurations	Ch. 1

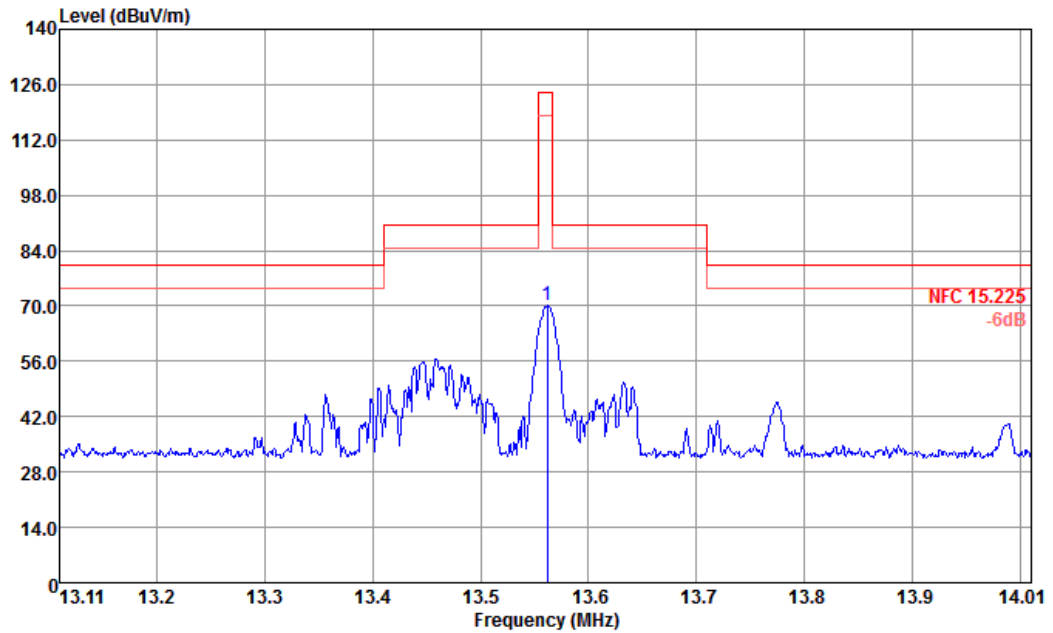

Site : 03CH01-KS
 Condition : NFC 15.225 3m LF_LOOP ANT_121026 HORIZONTAL
 Project : (FR)331812

	Freq	Level	Over Limit	Limit Line	ReadAntenna Level	Antenna Factor	Cable Loss	Preamp Loss	A/Pos	I/Pos	Remark
	MHz	dBuV/m	dB	dBuV/m	dBuV	dB/m	dB	dB	cm	deg	
1	13.56	70.03	-53.97	124.00	49.76	20.00	0.27	0.00	---	---	Peak

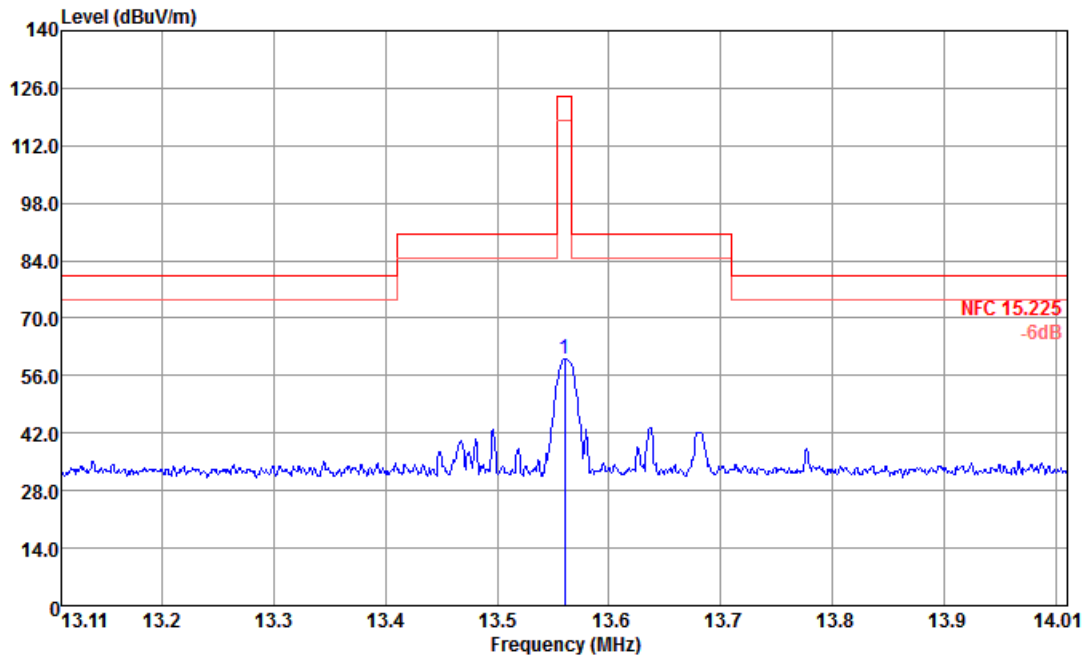

Site : 03CH01-KS
 Condition : NFC 15.225 3m LF_LOOP ANT_121026 VERTICAL
 Project : (FR)331812

Freq	Level	Over Limit	Limit Line	ReadAntenna Level	Cable Preamp	A/Pos	I/Pos	Remark	
MHz	dBuV/m	dB	dBuV/m	dBuV	dB/m	dB	dB	cm deg	
1	13.56	60.05	-63.95	124.00	39.78	20.00	0.27	0.00	--- --- Peak

Note:

Emission level (dBuV/m) = 20 log Emission level (uV/m).

Measured distance is 3m.

All emissions emit form non-NFC function of digital unintentional emissions. All NFC's spurious emissions are below 20dB of limits.

3.3 20dB Spectrum Bandwidth Measurement

3.3.1 Limit

Intentional radiators must be designed to ensure that the 20 dB bandwidth of the emissions in the specific band (13.553 ~ 13.567MHz).

3.3.2 Measuring Instruments and Setting

Please refer to section 4 of equipments list in this report. The following table is the setting of the spectrum analyzer.

Spectrum Parameters	Setting
Attenuation	Auto
Span Frequency	> 20dB Bandwidth
RB	1 kHz
VB	1 kHz
Detector	Peak
Trace	Max Hold
Sweep Time	Auto

3.3.3 Test Procedures

1. The transmitter output (antenna port) was connected to the spectrum analyzer in peak hold mode.
2. The resolution bandwidth of 1 kHz and the video bandwidth of 1 kHz were used.
3. Measured the spectrum width with power higher than 20dB below carrier.

3.3.4 Test Setup Layout

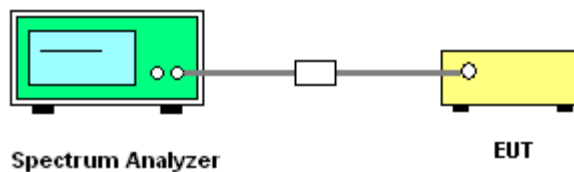

3.3.5 Test Deviation

There is no deviation with the original standard.

3.3.6 EUT Operation during Test

The EUT was programmed to be in continuously transmitting mode.

3.3.7 Test Result of 20dB Spectrum Bandwidth

Final Test Date	Apr. 09, 2013	Test Site No.	TH01-SZ
Temperature	24~26°C	Humidity	50~53%
Test Engineer	Blithe Li	Configurations	Ch. 1

Frequency	20dB BW (kHz)	99% OBW (kHz)	Frequency range (MHz) $f_L > 13.553\text{MHz}$	Frequency range (MHz) $f_H < 13.567\text{MHz}$	Test Result
13.56 MHz	2.620	2.340	13.55862	13.56124	Complies

20 dB / 99% Bandwidth Plot on 13.56 MHz

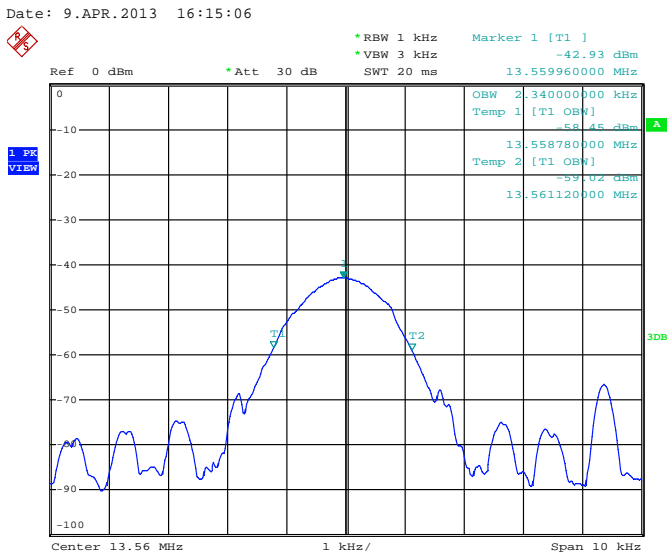
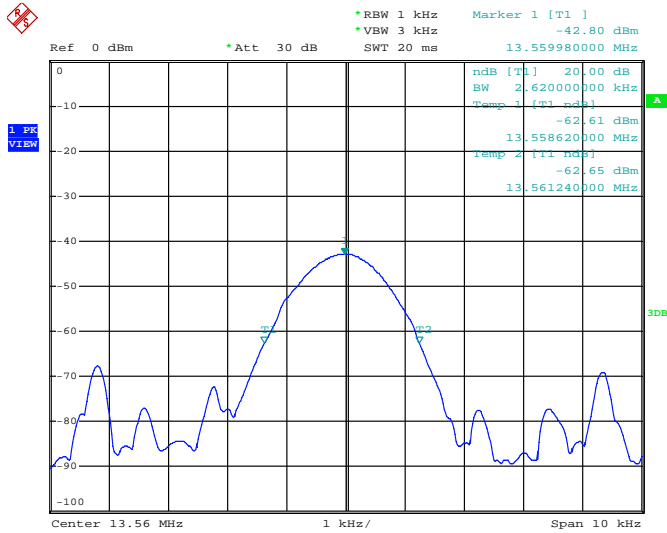

Date: 9.APR.2013 16:15:45

3.4 Radiated Emissions Measurement

3.4.1 Limit

The field strength of any emissions which appear outside of 13.553 ~ 13.567MHz band shall not exceed the general radiated emissions limits.

Frequencies (MHz)	Field Strength (micorvolts/meter)	Measurement Distance (meters)
0.009~0.490	2400/F(KHz)	300
0.490~1.705	24000/F(KHz)	30
1.705~30.0	30	30
30~88	100	3
88~216	150	3
216~960	200	3
Above 960	500	3

3.4.2 Measuring Instruments and Setting

Please refer to section 4 of equipments list in this report. The following table is the setting of receiver.

Receiver Parameter	Setting
Attenuation	Auto
Start ~ Stop Frequency	9kHz~150kHz / RB 200Hz for QP
Start ~ Stop Frequency	150kHz~30MHz / RB 9kHz for QP
Start ~ Stop Frequency	30MHz~1000MHz / RB 120kHz for QP

3.4.3 Test Procedures

1. Configure the EUT according to ANSI C63.4. The EUT was placed on the top of the turntable 0.8 meter above ground. The phase center of the receiving antenna mounted on the top of a height-variable antenna tower was placed 3 meters far away from the turntable.
2. Power on the EUT and all the supporting units. The turntable was rotated by 360 degrees to determine the position of the highest radiation.
3. The height of the broadband receiving antenna was varied between one meter and four meters above ground to find the maximum emissions field strength of both horizontal and vertical polarization.
4. For each suspected emissions, the antenna tower was scan (from 1 M to 4 M) and then the turntable was rotated (from 0 degree to 360 degrees) to find the maximum reading.
5. Set the test-receiver system to Peak or CISPR quasi-peak Detect Function with specified bandwidth under Maximum Hold Mode.
6. When the radiated emissions limits are expressed in terms of the average value of the emissions,



and pulsed operation is employed, the measurement field strength shall be determined by averaging over one complete pulse train, including blanking intervals, as long as the pulse train does not exceed 0.1 seconds. As an alternative (provided the transmitter operates for longer than 0.1 seconds) or in cases where the pulse train exceeds 0.1 seconds, the measured field strength shall be determined from the average absolute voltage during a 0.1 second interval during which the field strength is at its maximum value.

7. In case the emission is lower than 30MHz, loop antenna has to be used for measurement and the recorded data should be QP measured by receiver. High – Low scan is not required in this case.

3.4.4 Test Setup Layout

For radiated emissions below 30MHz

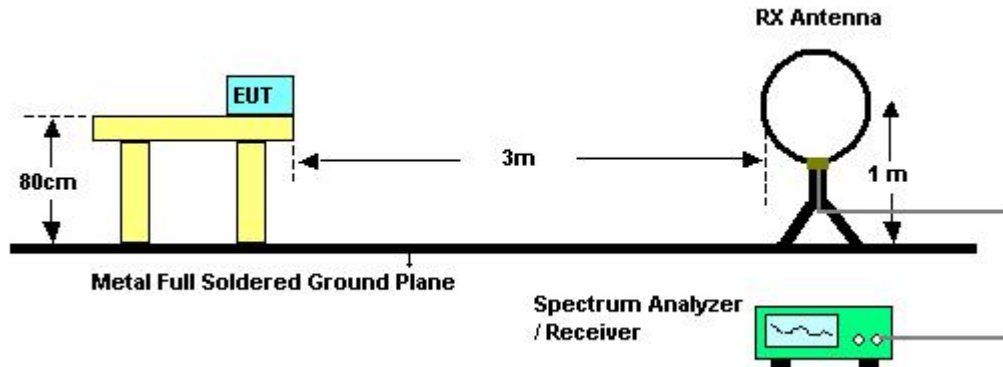

For radiated emissions above 30MHz

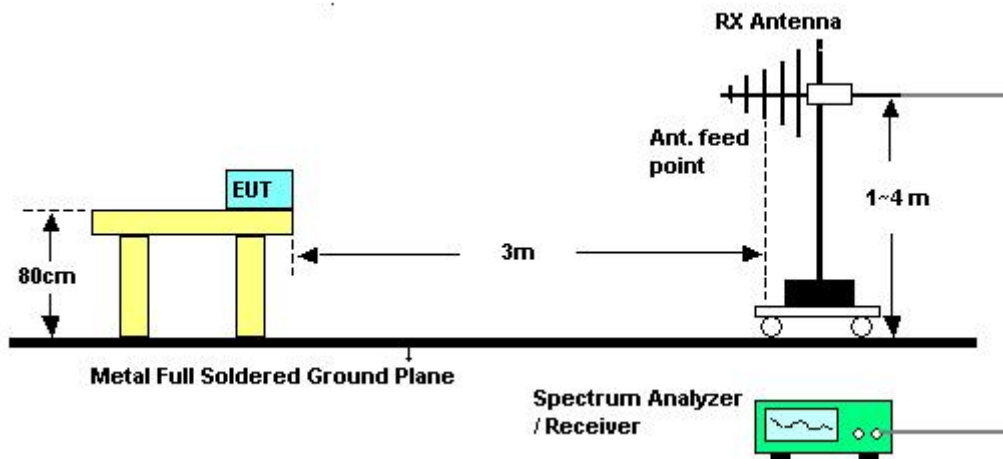

3.4.5 Test Deviation

There is no deviation with the original standard.

3.4.6 EUT Operation during Test

The EUT was programmed to be in continuously transmitting mode.



3.4.7 Results of Radiated Emissions (9 kHz~30MHz)

Final Test Date	Apr. 13, 2013	Test Site No.	03CH01-KS
Temperature	23~24°C	Humidity	43~44%
Test Engineer	Stone Gu	Configurations	Ch. 1

Horizontal

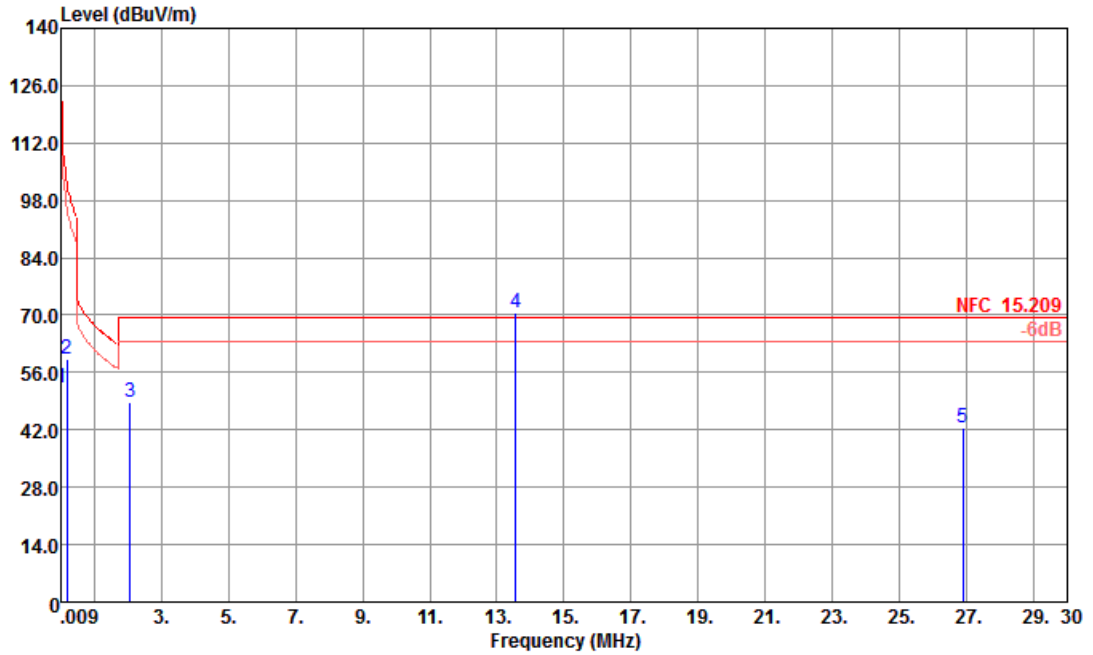

Site : 03CH01-KS
 Condition : NFC 15.209 3m LF_LOOP ANT_121026 HORIZONTAL
 Project : (FR)331812

	Freq	Level	Over	Limit	ReadAntenna	Cable	Preamp	A/Pos	T/Pos	Remark	
	MHz	dBuV/m	dB	dBuV/m	dBuV	dB/m	dB	dB	cm	deg	
1	0.02	52.09	-68.24	120.33	32.03	20.00	0.06	0.00	---	---	Peak
2	0.18	59.10	-43.40	102.50	39.09	20.00	0.01	0.00	---	---	Peak
3	2.08	48.75	-20.79	69.54	28.69	20.00	0.06	0.00	---	---	Peak
4 *	13.56	70.39			50.12	20.00	0.27	0.00	---	---	Peak
5	26.88	42.55	-26.99	69.54	22.24	20.00	0.31	0.00	---	---	Peak



Vertical

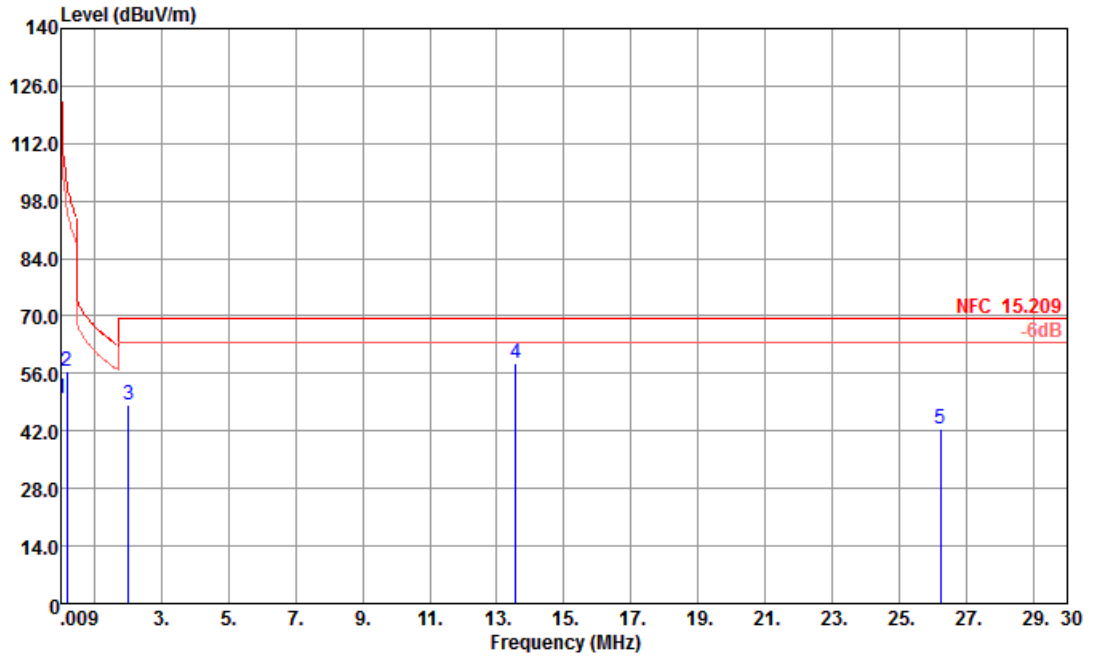

Site : 03CH01-KS
 Condition : NFC 15.209 3m LF_LOOP ANT_121026 VERTICAL
 Project : (FR)331812

	Freq	Level	Over Limit	Limit Line	ReadAntenna	Cable	Preamp	A/Pos	T/Pos	Remark	
	MHz	dBuV/m	dB	dBuV/m	dBuV	dB/m	dB	dB	cm	deg	
1	0.01	50.01	-77.98	127.99	29.95	20.00	0.06	0.00	---	---	Peak
2	0.19	56.58	-45.66	102.24	36.57	20.00	0.01	0.00	---	---	Peak
3	2.03	48.55	-20.99	69.54	28.49	20.00	0.06	0.00	---	---	Peak
4	13.56	58.55			38.28	20.00	0.27	0.00	---	---	Peak
5	26.23	42.38	-27.16	69.54	22.07	20.00	0.31	0.00	---	---	Peak

Note:

1. Remark 4 is transmitter's fundamental signal.
2. The amplitude of spurious emissions which are attenuated by more than 20dB below the permissible value has no need to be reported.

Distance extrapolation factor = 40 log (specific distance / test distance) (dB);

Limit line = specific limits (dBuV) + distance extrapolation factor.



3.4.8 Results for Radiated Emissions (30MHz~1GHz)

Final Test Date	Apr. 13, 2013	Test Site No.	03CH01-KS
Temperature	23~24°C	Humidity	43~44%
Test Engineer	Stone Gu	Configurations	Ch.1

Horizontal

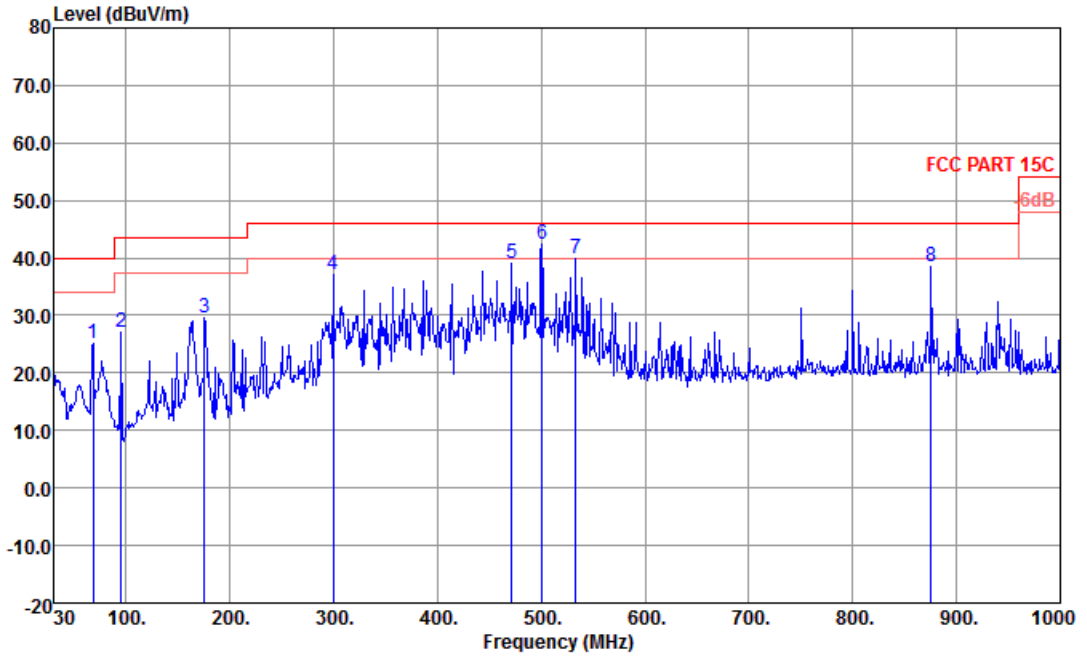

Site : 03CH01-KS
 Condition : FCC PART 15C 3m LF_ANT_100803 HORIZONTAL
 Project : (FR)331812

	Freq	Level	Over	Limit	ReadAntenna	Cable	Preamp	A/Pos	T/Pos	Remark	
	MHz	dBuV/m	dB	dBuV/m	dBuV	dB/m	dB	dB	cm	deg	
1	67.83	25.07	-14.93	40.00	52.88	5.27	0.51	33.59	---	---	Peak
2	94.99	27.00	-16.50	43.50	50.26	9.80	0.56	33.62	---	---	Peak
3	175.50	29.59	-13.91	43.50	53.59	8.80	0.77	33.57	---	---	Peak
4	299.66	36.99	-9.01	46.00	56.38	13.00	0.99	33.38	---	---	Peak
5	471.35	38.92	-7.08	46.00	54.20	16.65	1.25	33.18	---	---	Peak
6	500.45	42.41	-3.59	46.00	57.01	17.20	1.33	33.13	---	---	Peak
7	533.43	39.79	-6.21	46.00	53.37	18.14	1.33	33.05	---	---	Peak
8	875.84	38.38	-7.62	46.00	48.77	20.48	1.70	32.57	---	---	Peak



Vertical

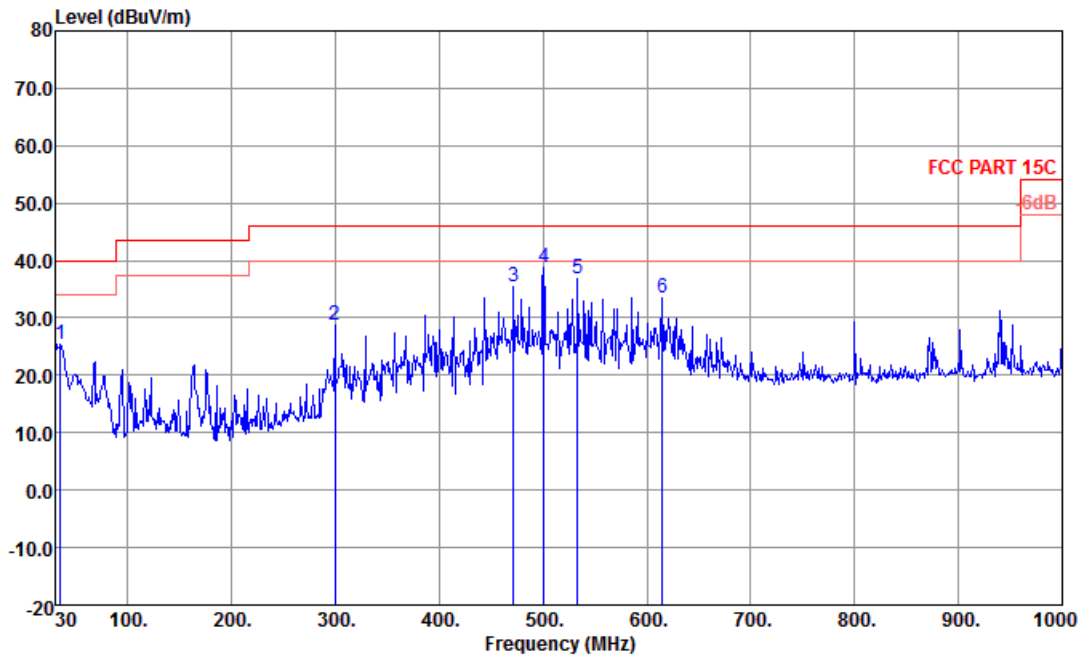

Site : 03CH01-KS
 Condition : FCC PART 15C 3m LF_ANT_100803 VERTICAL
 Project : (FR)331812

	Freq	Level	Over	Limit	ReadAntenna	Cable	Preamp	A/Pos	I/Pos	Remark
	MHz	dBuV/m	dB	dBuV/m	dBuV	dB/m	dB	cm	deg	
1	34.85	25.32	-14.68	40.00	43.46	15.10	0.37	33.61	---	Peak
2	299.66	28.78	-17.22	46.00	48.17	13.00	0.99	33.38	---	Peak
3	471.35	35.57	-10.43	46.00	50.85	16.65	1.25	33.18	---	Peak
4	500.45	38.85	-7.15	46.00	53.45	17.20	1.33	33.13	---	Peak
5	533.43	36.91	-9.09	46.00	50.49	18.14	1.33	33.05	---	Peak
6	614.91	33.51	-12.49	46.00	46.38	18.67	1.41	32.95	---	Peak

Note:

The amplitude of spurious emissions which are attenuated by more than 20dB below the permissible value has no need to be reported.

Emission level (dBuV/m) = 20 log Emission level (uV/m).

Corrected Reading: Antenna Factor + Cable Loss + Read Level - Preamp Factor= Level.

3.5 Frequency Stability Measurement

3.5.1 Limit

The frequency tolerance of the carrier signal shall be maintained within +/- 0.01% (100ppm) of the operating frequency over a temperature variation of -20 degrees to +50 degrees C at normal supply voltage, and for a variation in the primary supply voltage from 85% to 115% of the rated supply voltage at a temperature of 20 degrees C. For battery operated equipment, the equipment tests shall be performed using a new battery.

3.5.2 Measuring Instruments and Setting

Please refer to section 4 of equipments list in this report. The following table is the setting of the spectrum analyzer.

Spectrum Parameter	Setting
Attenuation	Auto
Span Frequency	Entire absence of modulation emissions bandwidth
RB	1 kHz
VB	1 kHz
Sweep Time	Auto

3.5.3 Test Procedures

1. The transmitter output (antenna port) was connected to the spectrum analyzer.
2. EUT have transmitted absence of modulation signal and fixed channelize.
3. Set the spectrum analyzer span to view the entire absence of modulation emissions bandwidth.
4. Set RBW = 1 kHz, VBW = 1 kHz with peak detector and maxhold settings.
5. fc is declaring of channel frequency. Then the frequency error formula is $(f_c - f) / f_c \times 10^6$ ppm and the limit is less than ± 100 ppm.
6. The test extreme voltage is to change the primary supply voltage from 85 to 115 percent of the nominal value
7. Extreme temperature rule is -20°C~50°C.

3.5.4 Test Setup Layout

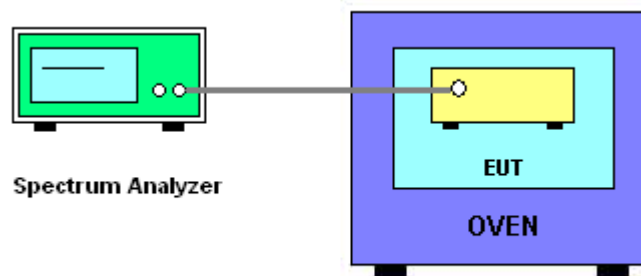

3.5.5 Test Deviation

There is no deviation with the original standard.

3.5.6 EUT Operation during Test

The EUT was programmed to be in continuously un-modulation transmitting mode.

3.5.7 Test Result of Frequency Stability

Final Test Date	Apr. 09, 2013	Test Site No.	TH01-SZ
Temperature	24~26°C	Humidity	50~53%
Test Engineer	Blithe Li	Configurations	Ch. 1

Voltage vs. Frequency Stability

Voltage(V)	Measurement Frequency (MHz)
9.0	13.560040
8.9	13.560020
9.5	13.560020
Max. Deviation (MHz)	0.000040
Max. Deviation (ppm)	2.9499

Temperature vs. Frequency Stability

Temperature (°C)	Measurement Frequency (MHz)
-20	13.559860
-10	13.559940
0	13.560060
10	13.560180
20	13.560240
30	13.560180
40	13.560140
50	13.560080
Max. Deviation (MHz)	0.000240
Max. Deviation (ppm)	17.6991



3.6 Antenna Requirements

3.6.1 Limit

Except for special regulations, the Low-power Radio-frequency Devices must not be equipped with any jacket for installing an antenna with extension cable. An intentional radiator shall be designed to ensure that no antenna other than that furnished by the responsible party shall be used with the device. The use of a permanently attached antenna or of an antenna that uses a unique coupling to the intentional radiator shall be considered sufficient to comply with the provisions of this Section. The manufacturer may design the unit so that the user can replace a broken antenna, but the use of a standard antenna jack or electrical connector is prohibited.

3.6.2 Antenna Connector Construction

Embedded in Antenna.

**4. LIST OF MEASURING EQUIPMENT**

Instrument	Manufacturer	Model No.	Serial No.	Characteristics	Calibration Date	Test Date	Due Date	Remark
Spectrum Analyzer	R&S	FSP30	101400	9kHz~30GHz	Jun. 01, 2012	Apr. 09, 2013	May 31, 2013	Conducted (TH01-SZ)
DC Power Supply	TOPWORD	3303DR	714621	N/A	Nov. 19, 2012	Apr. 09, 2013	Nov. 18, 2013	Conducted (TH01-SZ)
Thermal Chamber	Hongzhan	LP-150U	HD20120425	N/A	Jun. 11, 2012	Apr. 09, 2013	Jun. 10, 2013	Conducted (TH01-SZ)
ESCIO TEST Receiver	R&S	1142.8007.03	100724	9K-3GHz	Mar. 28, 2013	Apr. 02, 2013	Mar. 27, 2014	Conduction (CO01-SZ)
AC LISN	ETS-LINDGREN	3816/2SH	00103912	9KHZ~30MHZ	Mar. 28, 2013	Apr. 02, 2013	Mar. 27, 2014	Conduction (CO01-SZ)
AC LISN	ETS-LINDGREN	3816/2SH	00103892	9KHZ~30MHZ	Mar. 28, 2013	Apr. 02, 2013	Mar. 27, 2014	Conduction (CO01-SZ)
AVR	Throma	61602	616020000891 N/A	N/A	Nov. 20, 2013	Apr. 02, 2013	Nov. 19, 2013	Conduction (CO01-SZ)
EMI Test Receiver	R&S	ESCI	100534	9kHz~3GHz	Nov. 08, 2012	Apr. 13, 2013	Nov. 07, 2013	Radiation (03CH01-KS)
Spectrum Analyzer	R&S	FSP30	100400	9kHz~30GHz	Jun. 01, 2012	Apr. 13, 2013	May 31, 2013	Radiation (03CH01-KS)
HFH2-Z2 Loop Antenna	R&S	HFH2-Z2	100321	9KHZ-30MHZ	Oct. 22, 2012	Apr. 13, 2013	Oct. 21, 2013	Radiation (03CH01-KS)
Bilog Antenna	SCHAFFNER	CBL6112D	23182	25MHz~2GHz	Dec. 07, 2012	Apr. 13, 2013	Dec. 06, 2013	Radiation (03CH01-KS)
Amplifier	com-power	PA-103A	161069	1MHz~1GHz	Jun. 01, 2012	Apr. 13, 2013	May 31, 2013	Radiation (03CH01-KS)

5. TEST LOCATION

SHIJR	ADD : 6Fl., No. 106, Sec. 1, Shintai 5th Rd., Shijr City, Taipei, Taiwan 221, R.O.C. TEL : 886-2-2696-2468 FAX : 886-2-2696-2255
HWA YA	ADD : No. 52, Hwa Ya 1st Rd., Kwei-Shan Hsiang, Tao Yuan Hsien, Taiwan, R.O.C. TEL : 886-3-327-3456 FAX : 886-3-318-0055
LINKOU	ADD : No. 30-2, Dingfu Tsuen, Linkou Shiang, Taipei, Taiwan 244, R.O.C TEL : 886-2-2601-1640 FAX : 886-2-2601-1695
DUNGHU	ADD : No. 3, Lane 238, Kangle St., Neihu Chiu, Taipei, Taiwan 114, R.O.C. TEL : 886-2-2631-4739 FAX : 886-2-2631-9740
JUNGHE	ADD : 7Fl., No. 758, Jungjeng Rd., Junghe City, Taipei, Taiwan 235, R.O.C. TEL : 886-2-8227-2020 FAX : 886-2-8227-2626
NEIHU	ADD : 4Fl., No. 339, Hsin Hu 2 nd Rd., Taipei 114, Taiwan, R.O.C. TEL : 886-2-2794-8886 FAX : 886-2-2794-9777
JHUBEI	ADD : No.8, Lane 728, Bo-ai St., Jhubei City, HsinChu County 302, Taiwan, R.O.C. TEL : 886-3-656-9065 FAX : 886-3-656-9085
KUNSHAN	ADD : No. 3-2, PingXiang Road, Kunshan, Jiangsu Province, P.R.C. TEL : +86-0512-5790-0158 FAX : +86-0512-5790-0958
SHENZHEN	ADD : No. 3 Building, the third floor of south, Shahe River west, Fengzeyuan warehouse, Nanshan District, Shenzhen, Guangdong, P.R.C. TEL : +86-755- 3320-2398

6. TAF CERTIFICATE OF ACCREDITATION



Certificate No. : L2353-130205

財團法人全國認證基金會
Taiwan Accreditation Foundation

Certificate of Accreditation

This is to certify that

SPORTON International INC. (Shenzhen)

Mobile Communications Laboratory

No.101, Complex buiding C, Guanlong Village, Xili Town, Nanshan District, Shenzhen,
Guangdong, P.R.China

is accredited in respect of laboratory

Accreditation Criteria : ISO/IEC 17025:2005
Accreditation Number : 2353
Originally Accredited : April 06, 2011
Effective Period : April 06, 2011 to April 05, 2014
Accredited Scope : Testing Field, see described in the Appendix

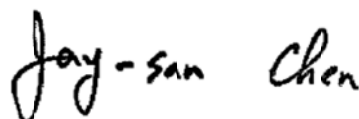

Jay-San Chen
President, Taiwan Accreditation Foundation
Date : February 05, 2013

P1, total 9 pages

The Appendix forms an integral part of this Certificate, which shall be invalid when use without the Appendix



Appendix A. Photographs of EUT

Please refer to Sporton report number EP331812 as below.