

## Box Contents

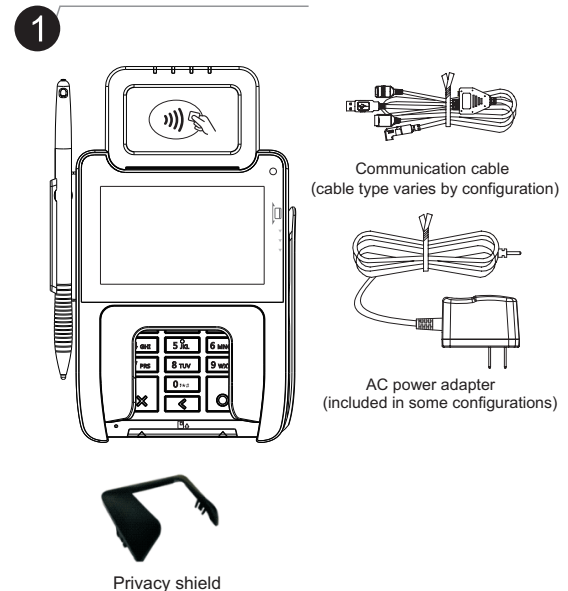

- 1 - PAX™ Q30 payment terminal
- 1 - Communication cable (varies by configuration)
- 1 - AC power adapter (not included with PUSB configurations)
- 1 - Privacy shield
- 1 - Quick Setup Guide

## Product Description

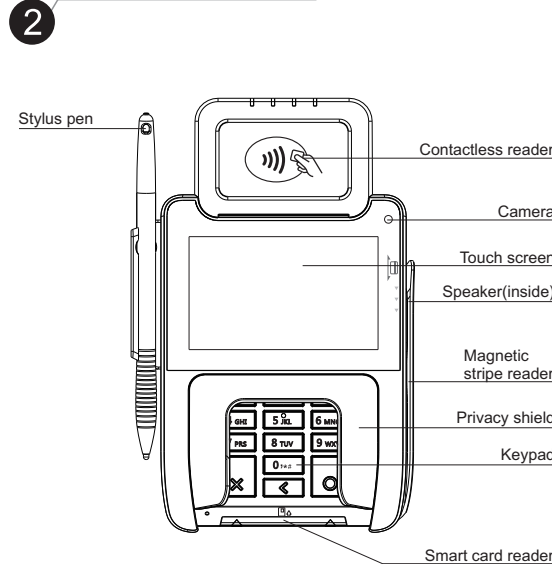

**Note:** Stylus pen is an optional configuration for the terminal, it may be not support on actual product received.

## Cable Connectors

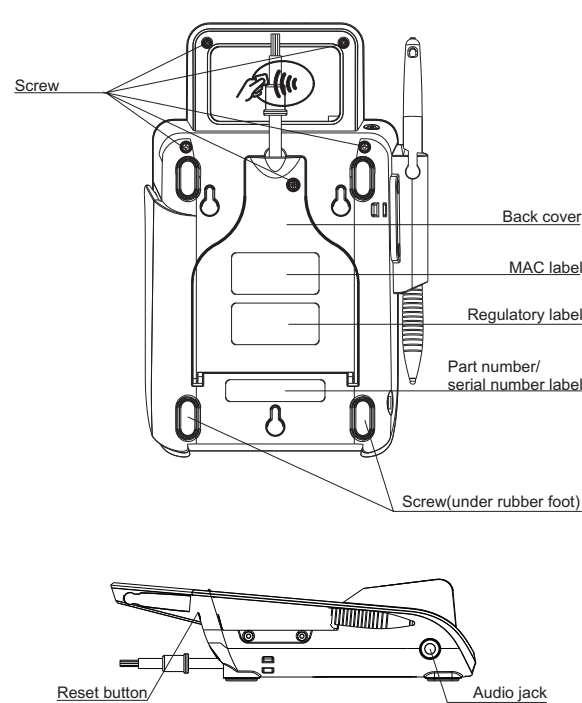

The 2x7P connector end of the provided communication cable connects to the underside of the Q30.

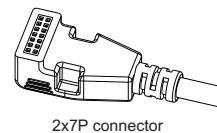

Cable connectors at the other end of the cable provide an interface to other systems for communications, to allow local downloading and to provide power. Additionally some cables allow connecting peripherals such as check readers and printers. All of the cable connectors are labeled and color-coded, as follows:

A combination of the following ports are available on the communication cable (depending on the Q30 configuration):

- DC Power - Connects AC power adapter to the Q30
- RS232A (Blue, RJ11 6P4C), RS232B (Yellow, RJ11 6P4C), or RS232 on C302 hub cable (RJ11 6P6C) - Connects an external POS device or check reader
- RS232 (Black, DB9-F) – Used to connect to POS terminal
- USB-Host (Type A) or Micro USB 2.0 - Used for local terminal downloads or external peripherals
- LAN (Red, Ethernet, RJ45-F) - Used for bi-directional Ethernet connections, TMS, and/or payment processing
- Powered USB - to connect to POS/ECR systems

**PAX TECHNOLOGY LIMITED reserves the right to change product technology specifications without notifying.**



PAX TECHNOLOGY LIMITED

Manufacturer: PAX Computer Technology (Shenzhen) Co.,Ltd.  
Address:4/F, No.3 Building, Software Park, Second Central Science-Tech Road, High-Tech Industrial Park, Shenzhen, Guangdong, P.R.C.  
Tel: 0755-86169630 Fax: 0755-86169634  
Website: <http://www.pax.com.cn>

## PAX™ Q30 Payment Terminal

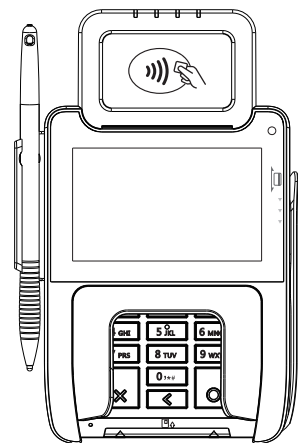

**Note:** Product images shown may be different than actual product received.

### Attach 2x7P Connector

4

To connect 2x7P end of cable:

1. Loosen the screw on the underside of the Q30 using a Philips head screwdriver.
2. Open the back cover.
3. Place the 2x7P end of the provided communication cable over its port, but do not push into place.
4. Align rubber sliding pull restraint so that it seats into its notch on the Q30.
5. Firmly press the 2x7P end of the cable into the port.
6. Close the back cover and tighten the screw, ensuring the gasket is properly seated in the opening.

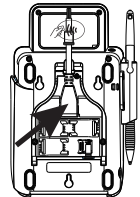
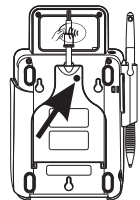

**WARNING:**

DO NOT connect the other end to the AC power source until all the other cables are connected first. Plugging in the AC power cord to the power source before the other cables are installed may result in damage to the terminal or connected devices.

### Power Connections

5

Power can be supplied to the Q30 by connecting the AC power adapter to the data cable, as in the case of RS232 or USB configurations, or via a powered USB cable (12V Powered USB) where the connected POS terminal provides the power.

### Terminal Communications

6

The Q30 supports the following types of communications:

- RS232
- High Speed Ethernet
- USB 2.0
- Powered USB
- Bluetooth BLE 4.0 + Wi-Fi (optional)

### Privacy Shield Installation

7

**CAUTION:** If the privacy shield is not installed, you must use PCI-approved alternative methods to protect PIN entry privacy.

To install the non-removable privacy shield, insert tabs to left and right of keypad and snap shield firmly in place.



Privacy shield



### SIM and Micro SD Card Installation

8

**WARNING:**

Power down the terminal before installing SIM cards or Micro SD cards. If the terminal is still powered on during an attempted SIM or SD card installation or removal, both the terminal and the card can be damaged irreparably.

To install a SIM and/or Micro SD card: Power down and remove all power from the Q30. Unscrew and open back cover. Gently press and slide SIM or Micro SD door toward outer edge of terminal and open hinged door. Seat card with gold connectors down into slot, aligning with opening. Gently press and slide door toward center of terminal to lock door closed. Close Q30 back cover and tighten back cover screw.

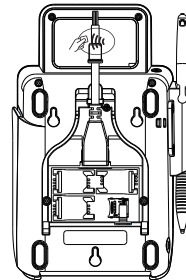

### Reset Button

9

To reset the terminal, press and hold the reset button for 4-6 seconds. using a pen or similar item. An example of when this may be used is when you are performing a download via USB stick.

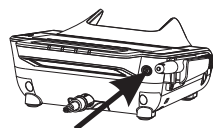

### Audio Jack

10

Audio Jack is an optional configuration for the terminal, it may be not support on actual product received. If required, a visually disabled person can connect a headphone to the terminal for audio prompting if the terminal application supports this using the 3.5mm output audio jack.

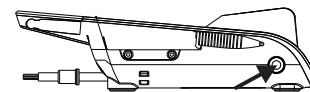

### Terminal Location

11

Locate the terminal on a counter top, desktop, or table top. It is recommended to keep the terminal away from direct sunlight, excessive dust, moisture, and heat. Avoid locating the terminal near electrical devices that might introduce interference such as microwave ovens and blow dryers.

### Stand Installation

12

Insert metal stand prongs into three stand slots on underside of terminal. Slide terminal firmly into place on stand.

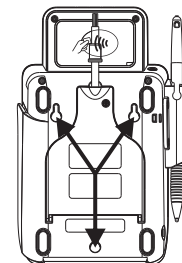

### Cleaning the Device

13

**WARNING:**

Do not use industrial strength or abrasive cleaner as it may damage or scratch the screen.

- Do not immerse device in water (or liquid).
- Do not spray water or cleaner into EMV Card Reader or ports.
- To clean screen, apply distilled water or mild glass cleaner onto a soft, lint-free cloth and gently wipe terminal screen.
- To clean terminal, apply distilled water or plastic-safe cleaner onto a soft, lint-free cloth and gently wipe terminal.

**Caution:** Changes or modifications not expressly approved by PAX Technology could void the user's authority to operate the equipment. In a domestic environment, this product may cause radio interference in which case the user may be required to take adequate measures.

### Certifications

14

The Q30 passed the following certifications:

- PCI PTS 5.x, SRED
- EMV L1 & L2
- EMV CL L1
- Mastercard PayPass
- American Express Expresspay
- Discover D-PAS
- Visa payWave
- JCB J/Speedy
- Interac Flash
- FCC
- IC
- CE
- UL
- RoHS

#### **FCC Statement**

1. This device complies with Part 15 of the FCC Rules. Operation is subject to the following two conditions:

(1) This device may not cause harmful interference.

(2) This device must accept any interference received, including interference that may cause undesired operation.

2. Changes or modifications not expressly approved by the party responsible for compliance could void the user's authority to operate the equipment.

#### **NOTE:**

This equipment has been tested and found to comply with the limits for a Class B digital device, pursuant to Part 15 of the FCC Rules. These limits are designed to provide reasonable protection against harmful interference in a residential installation.

This equipment generates uses and can radiate radio frequency energy and, if not installed and used in accordance with the instructions, may cause harmful interference to radio communications. However, there is no guarantee that interference will not occur in a particular installation. If this equipment does cause harmful interference to radio or television reception, which can be determined by turning the equipment off and on, the user is encouraged to try to correct the interference by one or more of the following measures:

Reorient or relocate the receiving antenna.

Increase the separation between the equipment and receiver.

Connect the equipment into an outlet on a circuit different from that to which the receiver is connected.

Consult the dealer or an experienced radio/TV technician for help.

#### **Body-worn Operation**

This device was tested for typical body-worn operations. To comply with RF exposure requirements, a minimum separation distance

of 0mm must be maintained between the user's body and the handset, including the antenna.

Third-party belt-clips, holsters,

and similar accessories used by this device should not contain any metallic components. Body-worn accessories that do not meet these requirements may not comply with RF exposure requirements and should be avoided. Use only the supplied or an approved antenna.

#### **IC STATEMENT**

This device complies with Industry Canada licence-exempt RSS standard(s)

Operation is subject to the following two conditions:

(1) This device may not cause interference, and

(2) This device must accept any interference, including interference that may cause undesired operation of the device.

This equipment complies with IC radiation exposure limits set forth for an uncontrolled environment. End user must follow the specific operating instructions for satisfying RF exposure compliance. This transmitter must not be co-located or operating in conjunction with any other antenna or transmitter.

To comply with RF exposure requirements, a minimum separation distance of 0mm must be maintained between the

user's body and the handset, including the antenna. Third-party belt-clips, holsters, and similar accessories used by this device should not contain any metallic components. Body-worn

accessories that do not meet these requirements may not comply with RF exposure requirements and should be avoided. Use only the supplied or an approved antenna.  
Le présent appareil est conforme aux CNR d'Industrie Canada applicables aux appareils radio exempts de licence.

Ce dispositif est conforme aux normes autoriser-exemptes du Canada RSS d'industrie

L'exploitation est autorisée aux deux conditions suivantes :

(1) l'appareil ne doit pas produire de brouillage, et

(2) l'utilisateur de l'appareil doit accepter tout brouillage radioélectrique subi, même si le brouillage est susceptible d'en compromettre le fonctionnement. Cet équipement

est conforme avec l'exposition aux radiations IC définies pour un environnement

non contrôlé. L'utilisateur final doit respecter les instructions de fonctionnement spécifiques pour satisfaire la conformité aux expositions RF. Cet émetteur ne doit pas être co-localisées

ou opérant en conjonction avec une autre antenne ou transmetteur. Ces exigences définissent

Cet appareil a été testé pour des opérations portés sur le corps typiques. Pour se conformer

aux exigences d'exposition aux radiofréquences, une distance minimale de 0mm doit être maintenue entre le corps de l'utilisateur et le combiné, y compris l'antenne. Les pinces de

ceinture, les étuis et autres accessoires similaires utilisés par cet appareil ne doivent pas

contenir de composants métalliques. Les accessoires portatifs qui ne répondent pas à ces

exigences peuvent ne pas se conformer aux exigences d'exposition RF et doit être évitée.

Utilisez uniquement l'antenne fournie ou une antenne approuvée