

**CFR 47 FCC PART 15 SUBPART C  
ISED RSS-247 ISSUE 3**

**TEST REPORT**

*For*

**POS Terminal**

**MODEL NUMBER: Q25  
HVIN: Q25S**

**REPORT NUMBER: 4790994528.2-1-RF-1**

**ISSUE DATE: November 15, 2023**

**FCC ID: V5PQ25S  
IC: 11689A-Q25S**

*Prepared for*

**PAX Technology Limited  
Room 2416, 24/F., Sun Hung Kai Centre, 30 Harbour Road, Wanchai, Hong Kong  
518057 China**

*Prepared by*

**UL Verification Services (Guangzhou) Co., Ltd, Song Shan Lake Branch**

**Building 10, Innovation Technology Park, No. 1, Li Bin Road, Song Shan Lake Hi-Tech Development Zone Dongguan, 523808, People's Republic of China**

**Tel: +86 769 22038881**

**Fax: +86 769 33244054**

**Website: [www.ul.com](http://www.ul.com)**

## Revision History

Rev.	Issue Date	Revisions	Revised By
V0	November 15, 2023	Initial Issue	

### Summary of Test Results

Test Item	Clause	Limit/Requirement	Result
Antenna Requirement	N/A	FCC Part 15.203/15.247 (c) RSS-GEN Clause 6.8	Pass
AC Power Line Conducted Emission	ANSI C63.10-2013, Clause 6.2	FCC Part 15.207 RSS-GEN Clause 8.8	Pass
Conducted Output Power	ANSI C63.10-2013, Clause 11.9.1.3	FCC Part 15.247 (b)(3) RSS-247 Clause 5.4 (d)	Pass
6dB Bandwidth and 99% Occupied Bandwidth	ANSI C63.10-2013, Clause 11.8.1	FCC Part 15.247 (a)(2) RSS-247 Clause 5.2 (a) ISED RSS-Gen Clause 6.7	Pass
Power Spectral Density	ANSI C63.10-2013, Clause 11.10.2	FCC Part 15.247 (e) RSS-247 Clause 5.2 (b)	Pass
Conducted Band edge and spurious emission	ANSI C63.10-2013, Clause 11.11	FCC Part 15.247(d) RSS-247 Clause 5.5	Pass
Radiated Band edge and Spurious Emission	ANSI C63.10-2013, Clause 11.12 & Clause 11.13	FCC Part 15.247 (d) FCC Part 15.205/15.209 RSS-247 Clause 5.5 RSS-GEN Clause 8.9	Pass
Duty Cycle	ANSI C63.10-2013, Clause 11.6	None; for reporting purposes only.	Pass

\*This test report is only published to and used by the applicant, and it is not for evidence purpose in China.

\*The measurement result for the sample received is <Pass> according to <CFR 47 FCC PART 15 SUBPART C ISED RSS-247 ISSUE 3> when <Simple Acceptance> decision rule is applied.

## CONTENTS

<b>1.</b>	<b>ATTESTATION OF TEST RESULTS.....</b>	<b>6</b>
<b>2.</b>	<b>TEST METHODOLOGY.....</b>	<b>7</b>
<b>3.</b>	<b>FACILITIES AND ACCREDITATION.....</b>	<b>7</b>
<b>4.</b>	<b>CALIBRATION AND UNCERTAINTY .....</b>	<b>8</b>
4.1.	<i>MEASURING INSTRUMENT CALIBRATION .....</i>	<i>8</i>
4.2.	<i>MEASUREMENT UNCERTAINTY.....</i>	<i>8</i>
<b>5.</b>	<b>EQUIPMENT UNDER TEST .....</b>	<b>9</b>
5.1.	<i>DESCRIPTION OF EUT .....</i>	<i>9</i>
5.2.	<i>CHANNEL LIST .....</i>	<i>10</i>
5.3.	<i>MAXIMUM POWER.....</i>	<i>10</i>
5.4.	<i>TEST CHANNEL CONFIGURATION.....</i>	<i>10</i>
5.5.	<i>THE WORSE CASE POWER SETTING PARAMETER.....</i>	<i>11</i>
5.6.	<i>WORST-CASE CONFIGURATIONS.....</i>	<i>12</i>
5.7.	<i>DESCRIPTION OF AVAILABLE ANTENNAS .....</i>	<i>12</i>
5.8.	<i>SUPPORT UNITS FOR SYSTEM TEST .....</i>	<i>13</i>
<b>6.</b>	<b>MEASURING EQUIPMENT AND SOFTWARE USED.....</b>	<b>14</b>
<b>7.</b>	<b>ANTENNA PORT TEST RESULTS .....</b>	<b>17</b>
7.1.	<i>CONDUCTED OUTPUT POWER.....</i>	<i>17</i>
7.2.	<i>6DB BANDWIDTH AND 99% OCCUPIED BANDWIDTH.....</i>	<i>18</i>
7.3.	<i>POWER SPECTRAL DENSITY .....</i>	<i>20</i>
7.4.	<i>CONDUCTED BAND EDGE AND SPURIOUS EMISSION.....</i>	<i>22</i>
7.5.	<i>DUTY CYCLE .....</i>	<i>24</i>
<b>8.</b>	<b>RADIATED TEST RESULTS.....</b>	<b>25</b>
8.1.	<i>RESTRICTED BANDEDGE .....</i>	<i>33</i>
8.2.	<i>SPURIOUS EMISSIONS(1 GHZ~3 GHZ) .....</i>	<i>44</i>
8.3.	<i>SPURIOUS EMISSIONS(3 GHZ~18 GHZ) .....</i>	<i>50</i>
8.4.	<i>SPURIOUS EMISSIONS(9 KHZ~30 MHZ) .....</i>	<i>74</i>
8.5.	<i>SPURIOUS EMISSIONS(18 GHZ~26 GHZ) .....</i>	<i>77</i>
8.6.	<i>SPURIOUS EMISSIONS(30 MHZ~1 GHZ).....</i>	<i>79</i>
<b>9.</b>	<b>ANTENNA REQUIREMENT .....</b>	<b>81</b>
<b>10.</b>	<b>AC POWER LINE CONDUCTED EMISSION .....</b>	<b>82</b>
<b>11.</b>	<b>TEST DATA.....</b>	<b>85</b>

<b>Appendix A: Duty Cycle.....</b>	<b>85</b>
<b>Appendix B: Maximum Conducted Output Power .....</b>	<b>88</b>
<b>Appendix C: -6dB Bandwidth .....</b>	<b>89</b>
<b>Appendix D: Occupied Channel Bandwidth.....</b>	<b>94</b>
<b>Appendix E: Maximum Power Spectral Density Level.....</b>	<b>99</b>
<b>Appendix F: Band Edge .....</b>	<b>104</b>
<b>Appendix G: Conducted RF Spurious Emission.....</b>	<b>111</b>

# 1. ATTESTATION OF TEST RESULTS

## Applicant Information

Company Name: PAX Technology Limited  
 Address: Room 2416, 24/F., Sun Hung Kai Centre, 30 Harbour Road, Wanchai, Hong Kong 518057 China

## Manufacturer Information

Company Name: PAX Computer Technology (Shenzhen) Co., Ltd.  
 Address: 401 and 402, Building 3, Shenzhen Software Park, Nanshan District, Shenzhen City, Guangdong Province, P.R.C

## EUT Information

EUT Name: POS Terminal  
 Model: Q25  
 Brand: PAX  
 Sample Received Date: September 8, 2023  
 Sample Status: Normal  
 Sample ID: 6434248  
 Date of Tested: September 14, 2023 to November 15, 2023

APPLICABLE STANDARDS	
STANDARD	TEST RESULTS
CFR 47 FCC PART 15 SUBPART C ISED RSS-247 ISSUE 3	Pass

Prepared By:

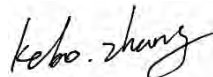

Kebo Zhang  
 Senior Project Engineer

Checked By:

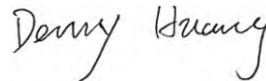

Denny Huang  
 Senior Project Engineer

Approved By:



Stephen Guo  
 Operations Manager

## 2. TEST METHODOLOGY

All tests were performed in accordance with the standard CFR 47 FCC PART 15 SUBPART C ISED RSS-247 ISSUE 3, KDB 558074 D01 15.247 Meas Guidance v05r02, KDB 414788 D01 Radiated Test Site v01r01, CFR 47 FCC Part 2, ANSI C63.10-2013 and ISED RSS-GEN Issue 5.

## 3. FACILITIES AND ACCREDITATION

Accreditation Certificate	<p><b>A2LA (Certificate No.: 4102.01)</b>          UL Verification Services (Guangzhou) Co., Ltd. Song Shan Lake Branch. has been assessed and proved to be in compliance with A2LA.</p> <p><b>FCC (FCC Designation No.: CN1187)</b>          UL Verification Services (Guangzhou) Co., Ltd. Song Shan Lake Branch. Has been recognized to perform compliance testing on equipment subject to the Commission's Declaration of Conformity (DoC) and Certification rules</p> <p><b>ISED (Company No.: 21320)</b>          UL Verification Services (Guangzhou) Co., Ltd. Song Shan Lake Branch. has been registered and fully described in a report filed with ISED. The Company Number is 21320 and the test lab Conformity Assessment Body Identifier (CABID) is CN0046.</p> <p><b>VCCI (Registration No.: G-20019, R-20004, C-20012 and T-20011)</b>          UL Verification Services (Guangzhou) Co., Ltd. Song Shan Lake Branch. has been assessed and proved to be in compliance with VCCI, the Membership No. is 3793.          Facility Name:          Chamber D, the VCCI registration No. is G-20019 and R-20004          Shielding Room B , the VCCI registration No. is C-20012 and T-20011</p>
---------------------------	--

Note 1:

All tests measurement facilities use to collect the measurement data are located at Building 10, Innovation Technology Park, No. 1, Li Bin Road, Song Shan Lake Hi-Tech Development Zone Dongguan, 523808, People's Republic of China.

Note 2:

The test anechoic chamber in UL Verification Services (Guangzhou) Co., Ltd. Song Shan Lake Branch had been calibrated and compared to the open field sites and the test anechoic chamber is shown to be equivalent to or worst case from the open field site.

Note 3:

For below 30 MHz, lab had performed measurements at test anechoic chamber and comparing to measurements obtained on an open field site. And these measurements below 30 MHz had been correlated to measurements performed on an OFS.

## 4. CALIBRATION AND UNCERTAINTY

### 4.1. MEASURING INSTRUMENT CALIBRATION

The measuring equipment utilized to perform the tests documented in this report has been calibrated in accordance with the manufacturer's recommendations and is traceable to recognized national standards.

### 4.2. MEASUREMENT UNCERTAINTY

Where relevant, the following measurement uncertainty levels have been estimated for tests performed on the apparatus:

Test Item	Uncertainty
Conduction emission	3.62 dB
Radiated Emission (Included Fundamental Emission) (9 kHz ~ 30 MHz)	2.2 dB
Radiated Emission (Included Fundamental Emission) (30 MHz ~ 1 GHz)	4.00 dB
Radiated Emission (Included Fundamental Emission) (1 GHz to 26 GHz)	5.78 dB (1 GHz ~ 18 GHz)
	5.23 dB (18 GHz ~ 26 GHz)
Duty Cycle	±0.028%
DTS and 99% Occupied Bandwidth	±0.0196%
Maximum Conducted Output Power	±0.686 dB
Maximum Power Spectral Density Level	±0.743 dB
Conducted Band-edge Compliance	±1.328 dB
Conducted Unwanted Emissions In Non-restricted Frequency Bands	±0.746 dB (9 kHz ~ 1 GHz)
	±1.328dB (1 GHz ~ 26 GHz)
Note: This uncertainty represents an expanded uncertainty expressed at approximately the 95% confidence level using a coverage factor of k=2.	



## 5. EQUIPMENT UNDER TEST

### 5.1. DESCRIPTION OF EUT

EUT Name:	POS Terminal
Model Name:	Q25
Radio Technology	IEEE802.11b/g/n HT20/HT40
Operation frequency	IEEE 802.11b: 2412MHz ~ 2462MHz IEEE 802.11g: 2412MHz ~ 2462MHz IEEE 802.11n HT20: 2412MHz ~ 2462MHz IEEE 802.11n HT40: 2422MHz ~ 2452MHz
Modulation	IEEE 802.11b: DSSS (CCK) IEEE 802.11g: OFDM (64QAM, 16QAM, QPSK, BPSK) IEEE 802.11n HT20: OFDM (64QAM, 16QAM, QPSK, BPSK) IEEE 802.11n HT40: OFDM (64QAM, 16QAM, QPSK, BPSK)
Normal Test Voltage	AC 120 V, 60 Hz

## 5.2. CHANNEL LIST

Channel List For Bandwidth=20 MHz							
Channel	Frequency (MHz)	Channel	Frequency (MHz)	Channel	Frequency (MHz)	Channel	Frequency (MHz)
1	2412	4	2427	7	2442	10	2457
2	2417	5	2432	8	2447	11	2462
3	2422	6	2437	9	2452	/	/

Channel List For Bandwidth=40 MHz							
Channel	Frequency (MHz)	Channel	Frequency (MHz)	Channel	Frequency (MHz)	Channel	Frequency (MHz)
3	2422	5	2432	7	2442	9	2452
4	2427	6	2437	8	2447	/	/

## 5.3. MAXIMUM POWER

IEEE Std. 802.11	Frequency (MHz)	Channel Number	Maximum Conducted AVG Output Power (dBm)
b	2412 ~ 2462	1-11[11]	16.54
g	2412 ~ 2462	1-11[11]	15.28
n HT20	2412 ~ 2462	1-11[11]	14.42
n HT40	2422 ~ 2452	3-9[7]	14.52

## 5.4. TEST CHANNEL CONFIGURATION

IEEE Std. 802.11	Test Channel Number	Frequency
b	CH 1(Low Channel), CH 6(MID Channel), CH 11(High Channel)	2412 MHz, 2437 MHz, 2462 MHz
g	CH 1(Low Channel), CH 6(MID Channel), CH 11(High Channel)	2412 MHz, 2437 MHz, 2462 MHz
n HT20	CH 1(Low Channel), CH 6(MID Channel), CH 11(High Channel)	2412 MHz, 2437 MHz, 2462 MHz
n HT40	CH 3(Low Channel), CH 6(MID Channel), CH 9(High Channel)	2422 MHz, 2437 MHz, 2452 MHz

### 5.5. THE WORSE CASE POWER SETTING PARAMETER

The Worse Case Power Setting Parameter under 2400 ~ 2483.5MHz Band							
Test Software		Pandora					
Modulation Mode	Transmit Antenna Number	Test Channel					
		NCB: 20MHz			NCB: 40MHz		
		CH 1	CH 6	CH 11	CH 3	CH 6	CH 9
802.11b	1	40	40	40	/		
802.11g	1	49	49	49			
802.11n HT20	1	47	47	47			
802.11n HT40	1	/			46	46	46

## 5.6. WORST-CASE CONFIGURATIONS

The EUT was tested in the following configuration(s):

Controlled in test mode using a software application on the EUT supplied by customer. The application was used to enable a continuous transmission and to select the mode, test channels, bandwidth, data rates as required.

Test channels referring to section 5.4.

Maximum power setting referring to section 5.5.

Worst-case data rates as provided by the client were:

802.11b mode: 1 Mbps

802.11g mode: 6 Mbps

802.11n HT20 mode: MCS0

802.11n HT40 mode: MCS0

The measured additional path loss was included in any path loss calculations for all RF cable used during tested.

## 5.7. DESCRIPTION OF AVAILABLE ANTENNAS

Antenna	Frequency (MHz)	Antenna Type	MAX Antenna Gain (dBi)
1	2412-2462	FPC	1.4

Test Mode	Transmit and Receive Mode	Description
IEEE 802.11b	<input checked="" type="checkbox"/> 1TX, 1RX	ANT 1 can be used as transmitting/receiving antenna.
IEEE 802.11g	<input checked="" type="checkbox"/> 1TX, 1RX	ANT 1 can be used as transmitting/receiving antenna.
IEEE 802.11n HT20	<input checked="" type="checkbox"/> 1TX, 1RX	ANT 1 can be used as transmitting/receiving antenna.
IEEE 802.11n HT40	<input checked="" type="checkbox"/> 1TX, 1RX	ANT 1 can be used as transmitting/receiving antenna.

Note:

1. WLAN 2.4G & WLAN 5G&NFC can't transmit simultaneously. (declared by client)
2. The value of the antenna gain was declared by customer.

## 5.8. SUPPORT UNITS FOR SYSTEM TEST

### SUPPORT EQUIPMENT

Item	Equipment	Mfr/Brand	Model/Type No.	Specification	Series No.
1	Laptop	Lenovo	E14	/	Laptop
2	SAM Card	N/A	N/A	N/A	N/A

### I/O CABLES

Cable No	Port	Connector Type	Cable Type	Cable Length(m)	Remarks
1	USB	Type C	/	1.0	/

### ACCESSORIES

Item	Accessory	Model Name	Description
1	Adapter	A18A-050100U-US2	Input:100-240V~, 50/60Hz, 0.2A Output: 5Vdc, 1.0A, 5W
2	Adapter	GLH50E1000HW	Input:100-240V~, 50/60Hz, 0.4A Output: 5Vdc, 1.0A, 5W

Note: Both adapters have been considered and only the worst model (GLH50E1000HW) was recorded.

### TEST SETUP

The EUT can work in engineering mode with a software through a Laptop.

### SETUP DIAGRAM FOR TESTS

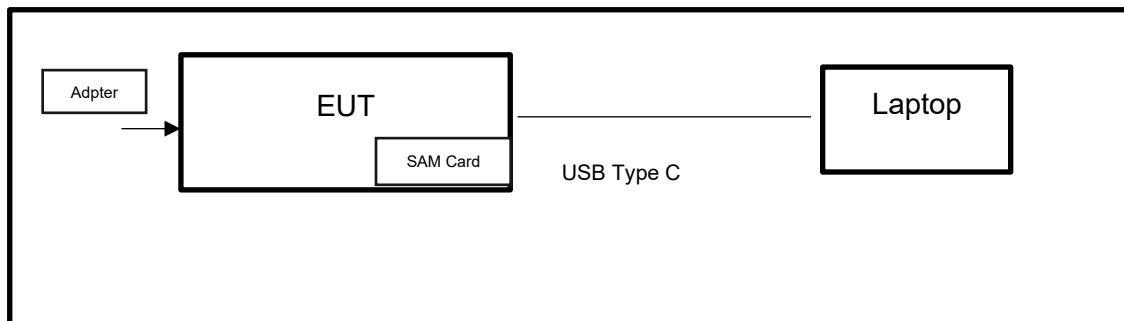

## 6. MEASURING EQUIPMENT AND SOFTWARE USED

R&S TS 8997 Test System					
Equipment	Manufacturer	Model No.	Serial No.	Last Cal.	Due. Date
Power sensor, Power Meter	R&S	OSP120	100921	Mar.31,2023	Mar.30,2024
Vector Signal Generator	R&S	SMBV100A	261637	Oct.17, 2022	Oct.16, 2023
Signal Generator	R&S	SMB100A	178553	Oct.17, 2022	Oct.16, 2023
Signal Analyzer	R&S	FSV40	101118	Oct.17, 2022	Oct.16, 2023
Software					
Description	Manufacturer	Name		Version	
For R&S TS 8997 Test System	Rohde & Schwarz	EMC 32		10.60.10	
Tonsend RF Test System					
Equipment	Manufacturer	Model No.	Serial No.	Last Cal.	Due. Date
Wideband Radio Communication Tester	R&S	CMW500	155523	Oct.17, 2022	Oct.16, 2023
Wireless Connectivity Tester	R&S	CMW270	1201.0002N75-102	Sep.28, 2022	Sep.27, 2023
PXA Signal Analyzer	Keysight	N9030A	MY55410512	Oct.17, 2022	Oct.16, 2023
MXG Vector Signal Generator	Keysight	N5182B	MY56200284	Oct.17, 2022	Oct.16, 2023
MXG Vector Signal Generator	Keysight	N5172B	MY56200301	Oct.17, 2022	Oct.16, 2023
DC power supply	Keysight	E3642A	MY55159130	Oct.17, 2022	Oct.16, 2023
Temperature & Humidity Chamber	SANMOOD	SG-80-CC-2	2088	Oct.17, 2022	Oct.16, 2023
Attenuator	Aglient	8495B	2814a12853	Oct.18, 2022	Oct.17, 2023
RF Control Unit	Tonscend	JS0806-2	23B80620666	April 18,2023	April 17,2024
Software					
Description	Manufacturer	Name		Version	
Tonsend SRD Test System	Tonsend	JS1120-3 RF Test System		V3.2.22	

Conducted Emissions					
Equipment	Manufacturer	Model No.	Serial No.	Last Cal.	Due Date
EMI Test Receiver	R&S	ESR3	101961	Oct.17, 2022	Oct.16, 2023
Two-Line V-Network	R&S	ENV216	101983	Oct.17, 2022	Oct.16, 2023
Artificial Mains Networks	Schwarzbeck	NSLK 8126	8126465	Oct.17, 2022	Oct.16, 2023
Software					
Description			Manufacturer	Name	Version
Test Software for Conducted Emissions			Farad	EZ-EMC	Ver. UL-3A1

Radiated Emissions					
Equipment	Manufacturer	Model No.	Serial No.	Last Cal.	Due Date
MXE EMI Receiver	KESIGHT	N9038A	MY56400036	Oct.17, 2022	Oct.16, 2023
Hybrid Log Periodic Antenna	TDK	HLP-3003C	130959	Aug.02, 2021	Aug.01, 2024
Preamplifier	HP	8447D	2944A09099	Oct.17, 2022	Oct.16, 2023
EMI Measurement Receiver	R&S	ESR26	101377	Oct.17, 2022	Oct.16, 2023
Horn Antenna	TDK	HRN-0118	130940	July 20, 2021	July 19, 2024
Preamplifier	TDK	PA-02-0118	TRS-305-00067	Oct.17, 2022	Oct.16, 2023
Horn Antenna	Schwarzbeck	BBHA9170	697	July 20, 2021	July 19, 2024
Preamplifier	TDK	PA-02-2	TRS-307-00003	Oct.17, 2022	Oct.16, 2023
Preamplifier	TDK	PA-02-3	TRS-308-00002	Oct.17, 2022	Oct.16, 2023
Loop antenna	Schwarzbeck	1519B	00008	Dec.14, 2021	Dec.13, 2024
Preamplifier	TDK	PA-02-001-3000	TRS-302-00050	Oct.17, 2022	Oct.16, 2023
Preamplifier	Mini-Circuits	ZX60-83LN-S+	SUP01202035	Oct.17, 2022	Oct.16, 2023
High Pass Filter	Wi	WHKX10-2700-3000-18000-40SS	23	Dec.01,2022	Nov.30,2023
Highpass Filter	Wainwright	WHKX10-5850-6500-1800-40SS	4	Dec.01,2022	Nov.30,2023
Band Reject Filter	Wainwright	WRCJV12-5695-5725-5850-5880-40SS	4	Dec.01,2022	Nov.30,2023
Band Reject Filter	Wainwright	WRCJV20-5120-5150-	2	Dec.01,2022	Nov.30,2023

		5350-5380-60SS			
Band Reject Filter	Wainwright	WRCJV20-5440-5470-5725-5755-60SS	1	Dec.01,2022	Nov.30,2023
Band Reject Filter	Wainwright	WRCJV8-2350-2400-2483.5-2533.5-40SS	4	Dec.01,2022	Nov.30,2023
Band Reject Filter	Wainwright	WRCD5-1879-1879.85-1880.15-1881-40SS	1	Dec.01,2022	Nov.30,2023
Notch Filter	Wainwright	WHJ10-882-980-7000-40SS	1	Dec.01,2022	Nov.30,2023
<b>Software</b>					
Description			Manufacturer	Name	Version
Test Software for Radiated Emissions			Farad	EZ-EMC	Ver. UL-3A1

<b>Other Instrument</b>					
Equipment	Manufacturer	Model No.	Serial No.	Last Cal.	Due Date
Temperature humidity probe	OMEGA	ITHX-SD-5	18470007	Oct.22, 2022	Oct.21, 2023
Barometer	Yiyi	Baro	N/A	Oct.24, 2022	Oct.23, 2023
Attenuator	Agilent	8495B	2814a12853	Oct.18, 2022	Oct.17, 2023



## 7. ANTENNA PORT TEST RESULTS

### 7.1. CONDUCTED OUTPUT POWER

#### LIMITS

CFR 47 FCC Part15 (15.247) Subpart C ISED RSS-247 ISSUE 3			
Section	Test Item	Limit	Frequency Range (MHz)
CFR 47 FCC 15.247(b)(3) ISED RSS-247 5.4 (d)	AVG Output Power	1 watt or 30 dBm	2400-2483.5

#### TEST PROCEDURE

Refer to ANSI C63.10-2013 clause 11.9.2.3.1.

Connect the EUT to a low loss RF cable from the antenna port to the power sensor (video bandwidth is greater than the occupied bandwidth).

Measure peak emission level, the indicated level is the average output power, after any corrections for external attenuators and cables.

The test result in dBm by adding  $[10 \log (1 / D)]$ , where D is the duty cycle.

#### TEST SETUP

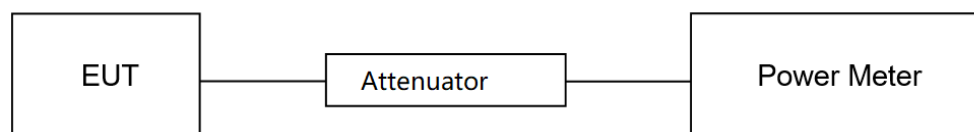

#### TEST ENVIRONMENT

Temperature	23.2°C	Relative Humidity	59%
Atmosphere Pressure	101kPa	Test Voltage	AC 120V, 60Hz

#### TEST DATE / ENGINEER

Test Date	September 14, 2023	Test By	Kebo Zhang
-----------	--------------------	---------	------------

#### TEST RESULTS

Please refer to section "Test Data" - Appendix B

## 7.2. 6DB BANDWIDTH AND 99% OCCUPIED BANDWIDTH

### LIMITS

CFR 47 FCC Part15 (15.247) Subpart C ISED RSS-247 ISSUE 3			
Section	Test Item	Limit	Frequency Range (MHz)
CFR 47 FCC 15.247(a)(2) ISED RSS-247 5.2 (a)	6 dB Bandwidth	≥ 500 kHz	2400-2483.5
ISED RSS-Gen Clause 6.7	99 % Occupied Bandwidth	For reporting purposes only.	2400-2483.5

### TEST PROCEDURE

Refer to ANSI C63.10-2013 clause 11.8 for DTS bandwidth and clause 6.9 for Occupied Bandwidth.

Connect the EUT to the spectrum analyzer and use the following settings:

Center Frequency	The center frequency of the channel under test
Frequency Span	For 6 dB Bandwidth: Enough to capture all products of the modulation carrier emission For 99 % Occupied Bandwidth: Between 1.5 times and 5.0 times the OBW
Detector	Peak
RBW	For 6 dB Bandwidth: 100 kHz For 99 % Occupied Bandwidth: 1 % to 5 % of the occupied bandwidth
VBW	For 6 dB Bandwidth: $\geq 3 \times \text{RBW}$ For 99 % Occupied Bandwidth: $\geq 3 \times \text{RBW}$
Trace	Max hold
Sweep	Auto couple

a) Use the 99 % power bandwidth function of the instrument, allow the trace to stabilize and report the measured bandwidth.

b) Allow the trace to stabilize and measure the maximum width of the emission that is constrained by the frequencies associated with the two outermost amplitude points (upper and lower frequencies) that are attenuated by 6 dB relative to the maximum level measured in the fundamental emission.

### TEST SETUP

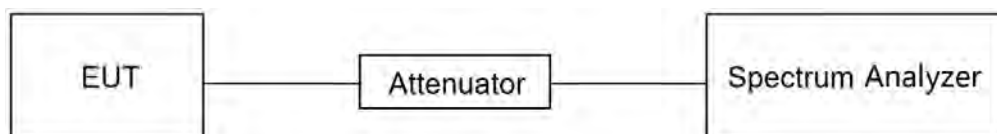

**TEST ENVIRONMENT**

Temperature	23.2°C	Relative Humidity	59%
Atmosphere Pressure	101kPa	Test Voltage	AC 120V, 60Hz

**TEST DATE / ENGINEER**

Test Date	September 14, 2023	Test By	Kebo Zhang
-----------	--------------------	---------	------------

**TEST RESULTS**

Please refer to section "Test Data" - Appendix C&D

### 7.3. POWER SPECTRAL DENSITY

#### LIMITS

CFR 47 FCC Part15 (15.247) Subpart C ISED RSS-247 ISSUE 3			
Section	Test Item	Limit	Frequency Range (MHz)
CFR 47 FCC §15.247 (e) ISED RSS-247 5.2 (b)	Power Spectral Density	8 dBm in any 3 kHz band	2400-2483.5

#### TEST PROCEDURE

Refer to ANSI C63.10-2013 clause 11.10.5.

Connect the EUT to the spectrum analyzer and use the following settings:

Center Frequency	The center frequency of the channel under test
Detector	power averaging (rms)
RBW	$3 \text{ kHz} \leq \text{RBW} \leq 100 \text{ kHz}$
VBW	$\geq 3 \times \text{RBW}$
Span	1.5 x OBW bandwidth
Trace	Employ trace averaging(rms)mode over a minimum of 100 traces
Sweep time	Auto couple

Allow trace to fully stabilize and use the peak marker function to determine the maximum amplitude level within the RBW.

If measured value exceeds limit, reduce RBW (no less than 3 kHz) and repeat.

#### TEST SETUP

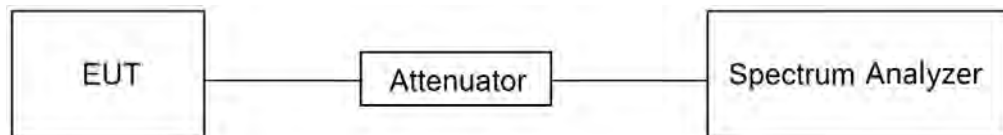

#### TEST ENVIRONMENT

Temperature	23.2°C	Relative Humidity	59%
Atmosphere Pressure	101kPa	Test Voltage	AC 120V, 60Hz

#### TEST DATE / ENGINEER

Test Date	November 15, 2023	Test By	Kebo Zhang
-----------	-------------------	---------	------------

**TEST RESULTS**

Please refer to section "Test Data" - Appendix E

## 7.4. CONDUCTED BAND EDGE AND SPURIOUS EMISSION

### TEST PROCEDURE

Refer to ANSI C63.10-2013 clause 11.11 and 11.13.

Connect the EUT to the spectrum analyzer and use the following settings for reference level measurement:

Center Frequency	The center frequency of the channel under test
Detector	Peak
RBW	100 kHz
VBW	$\geq 3 \times \text{RBW}$
Span	1.5 x DTS bandwidth
Trace	Max hold
Sweep time	Auto couple.

Allow trace to fully stabilize and use the peak marker function to determine the maximum PSD level.

Change the settings for emission level measurement:

Span	Set the center frequency and span to encompass frequency range to be measured
Detector	Peak
RBW	100 kHz
VBW	$\geq 3 \times \text{RBW}$
measurement points	$\geq \text{span}/\text{RBW}$
Trace	Max hold
Sweep time	Auto couple.

Allow trace to fully stabilize and use the peak marker function to determine the maximum PSD level. Ensure that the amplitude of all unwanted emissions outside of the authorized frequency band (excluding restricted frequency bands) is attenuated by at least the minimum requirements specified in 11.11.

### TEST SETUP

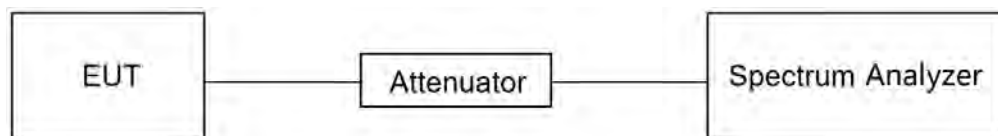

### TEST ENVIRONMENT

Temperature	23.2°C	Relative Humidity	59%
Atmosphere Pressure	101kPa	Test Voltage	AC 120V, 60Hz

### TEST DATE / ENGINEER

Test Date	October 8, 2023	Test By	Kebo Zhang
-----------	-----------------	---------	------------

**TEST RESULTS**

Please refer to section "Test Data" - Appendix F&G

## 7.5. DUTY CYCLE

### LIMITS

None; for reporting purposes only.

### TEST PROCEDURE

Refer to ANSI C63.10-2013 clause 11.6 Zero – Span Spectrum Analyzer method.

### TEST SETUP

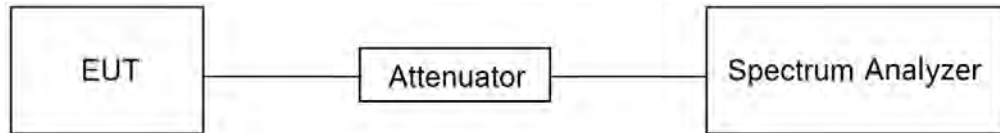

### TEST ENVIRONMENT

Temperature	23.2°C	Relative Humidity	59%
Atmosphere Pressure	101kPa	Test Voltage	AC 120V, 60Hz

### TEST DATE / ENGINEER

Test Date	September 14, 2023	Test By	Kebo Zhang
-----------	--------------------	---------	------------

### TEST RESULTS

Please refer to section "Test Data" - Appendix A



## 8. RADIATED TEST RESULTS

### LIMITS

Please refer to CFR 47 FCC §15.205 and §15.209.

Please refer to ISED RSS-GEN Clause 8.9 and Clause 8.10.

Radiation Disturbance Test Limit for FCC (Class B) (9 kHz ~ 1 GHz)

Emissions radiated outside of the specified frequency bands above 30 MHz			
Frequency Range (MHz)	Field Strength Limit (uV/m) at 3 m	Field Strength Limit (dBuV/m) at 3 m	
		Quasi-Peak	
30 - 88	100	40	
88 - 216	150	43.5	
216 - 960	200	46	
Above 960	500	54	
Above 1000	500	Peak	Average
		74	54

FCC Emissions radiated outside of the specified frequency bands below 30 MHz		
Frequency (MHz)	Field strength (microvolts/meter)	Measurement distance (meters)
0.009-0.490	2400/F(kHz)	300
0.490-1.705	24000/F(kHz)	30
1.705-30.0	30	30

ISED General field strength limits at frequencies below 30 MHz

Table 6 – General field strength limits at frequencies below 30 MHz		
Frequency	Magnetic field strength (H-Field) (uA/m)	Measurement distance (m)
9 - 490 kHz <sup>Note 1</sup>	6.37/F (F in kHz)	300
490 - 1705 kHz	63.7/F (F in kHz)	30
1.705 - 30 MHz	0.08	30

**Note 1:** The emission limits for the ranges 9-90 kHz and 110-490 kHz are based on measurements employing a linear average detector.

ISED Restricted bands please refer to ISED RSS-GEN Clause 8.10

Table 7 – Restricted frequency bands <sup>Note 1</sup>		
MHz	MHz	GHz
0.090 - 0.110	149.9 - 150.05	9.0 - 9.2
0.495 - 0.505	156.52475 - 156.52525	9.3 - 9.5
2.1735 - 2.1905	156.7 - 156.9	10.6 - 12.7
3.020 - 3.026	162.0125 - 167.17	13.25 - 13.4
4.125 - 4.128	167.72 - 173.2	14.47 - 14.5
4.17725 - 4.17775	240 - 285	15.35 - 16.2
4.20725 - 4.20775	322 - 335.4	17.7 - 21.4
5.677 - 5.683	399.9 - 410	22.01 - 23.12
6.215 - 6.218	608 - 614	23.6 - 24.0
6.26775 - 6.26825	960 - 1427	31.2 - 31.8
6.31175 - 6.31225	1435 - 1626.5	36.43 - 36.5
8.291 - 8.294	1645.5 - 1646.5	Above 38.6
8.362 - 8.366	1660 - 1710	
8.37625 - 8.38675	1718.8 - 1722.2	
8.41425 - 8.41475	2200 - 2300	
12.29 - 12.293	2310 - 2390	
12.51975 - 12.52025	2483.5 - 2500	
12.57675 - 12.57725	2655 - 2900	
13.36 - 13.41	3260 - 3267	
16.42 - 16.423	3332 - 3339	
16.69475 - 16.69525	3345.8 - 3358	
16.80425 - 16.80475	3500 - 4400	
25.5 - 25.67	4500 - 5150	
37.5 - 38.25	5350 - 5460	
73 - 74.6	7250 - 7750	
74.8 - 75.2	8025 - 8500	
108 - 138		

**Note 1:** Certain frequency bands listed in table 7 and in bands above 38.6 GHz are designated for licence-exempt applications. These frequency bands and the requirements that apply to related devices are set out in the 200 and 300 series of RSSs.

FCC Restricted bands of operation refer to FCC §15.205 (a):

MHz	MHz	MHz	GHz
0.090-0.110	16.42-16.423	399.9-410	4.5-5.15
<sup>1</sup> 0.495-0.505	16.69475-16.69525	608-614	5.35-5.46
2.1735-2.1905	16.80425-16.80475	960-1240	7.25-7.75
4.125-4.128	25.5-25.67	1300-1427	8.025-8.5
4.17725-4.17775	37.5-38.25	1435-1626.5	9.0-9.2
4.20725-4.20775	73-74.6	1645.5-1646.5	9.3-9.5
6.215-6.218	74.8-75.2	1660-1710	10.6-12.7
6.26775-6.26825	108-121.94	1718.8-1722.2	13.25-13.4
6.31175-6.31225	123-138	2200-2300	14.47-14.5
8.291-8.294	149.9-150.05	2310-2390	15.35-16.2
8.362-8.366	156.52475-156.52525	2483.5-2500	17.7-21.4
8.37625-8.38675	156.7-156.9	2690-2900	22.01-23.12
8.41425-8.41475	162.0125-167.17	3260-3267	23.6-24.0
12.29-12.293	167.72-173.2	3332-3339	31.2-31.8
12.51975-12.52025	240-285	3345.8-3358	36.43-36.5
12.57675-12.57725	322-335.4	3600-4400	( <sup>2</sup> )
13.36-13.41			

Note: <sup>1</sup>Until February 1, 1999, this restricted band shall be 0.490-0.510 MHz.

<sup>2</sup>Above 38.6c

**TEST PROCEDURE**

Below 30 MHz

## The setting of the spectrum analyzer

RBW	200 Hz (From 9 kHz to 0.15 MHz)/ 9 kHz (From 0.15 MHz to 30 MHz)
VBW	200 Hz (From 9 kHz to 0.15 MHz)/ 9 kHz (From 0.15 MHz to 30 MHz)
Sweep	Auto

1. The testing follows the guidelines in ANSI C63.10-2013 clause 6.4.
2. The EUT was arranged to its worst case and then turntable (from 0 degree to 360 degrees) to find the maximum reading. A pre-amp and a high pass filter are used for the test in order to get better signal level. Both Horizontal, Face-on and Face-off polarizations of the antenna are set to make the measurement.
3. The EUT was placed on a turntable with 80 cm above ground.
4. The EUT was set 3 meters from the interference receiving antenna, which was mounted on the top of a 1 m height antenna tower.
5. The radiated emission limits are based on measurements employing a CISPR quasi-peak detector except for the frequency bands 9-90 kHz, 110-490 kHz and above 1000 MHz Radiated emission limits in these three bands are based on measurements employing an average detector.
6. For measurement below 1 GHz, the initial step in collecting conducted emission data is a spectrum analyzer peak detector mode pre-scanning the measurement frequency range. Significant peaks are then marked and then Quasi Peak and average detector mode re-measured. If the emission level of the EUT measured by the peak detector is 3 dB lower than the applicable limit, the peak emission level will be reported. Otherwise, the emission measurement will be repeated using the quasi-peak and average detector and reported.
7. Although these tests were performed other than open field site, adequate comparison measurements were confirmed against 30m open field site. Therefore sufficient tests were made to demonstrate that the alternative site produces results that correlate with the ones of tests made in an open field site based on KDB 414788.
8. The limits in CFR 47, Part 15, Subpart C, paragraph 15.209 (a), are identical to those in RSS-GEN Section 8.9, Table 6, since the measurements are performed in terms of magnetic field strength and converted to electric field strength levels (as reported in the table) using the free space impedance of  $377\Omega$ . For example, the measurement frequency X kHz resulted in a level of Y dBuV/m, which is equivalent to  $Y-51.5 = Z$  dBuA/m, which has the same margin, W dB, to the corresponding RSS-GEN Table 6 limit as it has to be 15.209(a) limit.

Below 1 GHz and above 30 MHz

The setting of the spectrum analyzer

RBW	120 kHz
VBW	300 kHz
Sweep	Auto
Detector	Peak/QP
Trace	Max hold

1. The testing follows the guidelines in ANSI C63.10-2013 clause 6.5.
2. The EUT was arranged to its worst case and then tune the antenna tower (from 1 m to 4 m) and turntable (from 0 degree to 360 degrees) to find the maximum reading. A pre-amp and a high pass filter are used for the test in order to get better signal level. Both horizontal and vertical polarizations of the antenna are set to make the measurement.
3. The EUT was placed on a turntable with 80 cm above ground.
4. The EUT was set 3 meters from the interference receiving antenna, which was mounted on the top of a variable height antenna tower.
5. For measurement below 1 GHz, the initial step in collecting conducted emission data is a spectrum analyzer peak detector mode pre-scanning the measurement frequency range. Significant peaks are then marked and then Quasi Peak detector mode re-measured. If the emission level of the EUT measured by the peak detector is 3 dB lower than the applicable limit, the peak emission level will be reported. Otherwise, the emission measurement will be repeated using the quasi-peak detector and reported.

Above 1 GHz

The setting of the spectrum analyzer

RBW	1 MHz
VBW	PEAK: 3 MHz AVG: see note 6
Sweep	Auto
Detector	Peak
Trace	Max hold

1. The testing follows the guidelines in ANSI C63.10-2013 clause 6.6.
2. The EUT was arranged to its worst case and then tune the antenna tower (from 1 m to 4 m) and turntable (from 0 degree to 360 degrees) to find the maximum reading. A pre-amp and a high pass filter are used for the test in order to get better signal level. Both horizontal and vertical polarizations of the antenna are set to make the measurement.
3. The EUT was placed on a turntable with 1.5 m above ground.
4. The EUT was set 3 meters from the interference receiving antenna, which was mounted on the top of a variable height antenna tower.
5. For measurement above 1 GHz, the emission measurement will be measured by the peak detector. This peak level, once corrected, must comply with the limit specified in Section 15.209.
6. For measurements above 1 GHz the resolution bandwidth is set to 1 MHz, then the video bandwidth is set to 3 MHz for peak measurements and 1 MHz resolution bandwidth with 1/T video bandwidth with peak detector for average measurements. For the Duty Cycle please refer to clause 7.5. ON TIME AND DUTY CYCLE.

X axis, Y axis, Z axis positions:

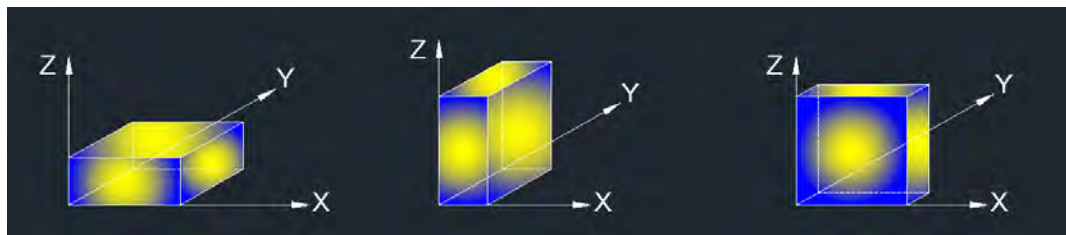

Note 1: For all radiated test, EUT in each of three orthogonal axis emissions had been tested, but only the worst case (X axis) data recorded in the report.

Note 2: The EUT was fully exercised with external accessories during the test. In the case of multiple accessory external ports, an external accessory shall be connected to one of each type of port.

For Restricted Bandedge:

Note:

1. Measurement = Reading Level + Correct Factor.
2. If the peak values are less than the average limit of 54 dBuV/m, the average result is deemed to comply with average limit.
3. PK=Peak: Peak detector.
4. AV=Average: VBW=1/Ton, where: Ton is the transmitting duration.
5. For the transmitting duration, please refer to clause 7.5.
6. Only the worst data was recorded, if it complies with the limit, the other emissions deemed to comply with the limit.
7. Both horizontal and vertical have been tested, only the worst data was recorded in the report.
8. All modes have been tested, but only the worst data was recorded in the report.

For Radiate Spurious emission (9 kHz ~ 30 MHz):

Note:

1. Measurement = Reading Level + Correct Factor.
2. If the peak values are less than the QP limit, the QP result is deemed to comply with QP limit.
3. All 3 polarizations (Horizontal, Face-on and Face-off) of the loop antenna had been tested, but only the worst data recorded in the report.
4. All modes have been tested, but only the worst data was recorded in the report.
5.  $\text{dBuA/m} = \text{dBuV/m} - 20\text{Log}_{10}[120\pi] = \text{dBuV/m} - 51.5$

For Radiate Spurious Emission (30 MHz ~ 1 GHz):

Note:

1. Result Level = Read Level + Correct Factor.
2. If the peak values are less than the QP limit, the QP result is deemed to comply with QP limit.
3. All modes have been tested, but only the worst data was recorded in the report.

For Radiate Spurious Emission (1 GHz ~ 3 GHz):

Note:

1. Measurement = Reading Level + Correct Factor.
2. If the peak values are less than the average limit of 54 dBuV/m, the average result is deemed to comply with average limit.
3. Peak: Peak detector.
4. AVG: VBW=1/Ton, where: Ton is the transmitting duration.
5. For the transmitting duration, please refer to clause 7.5.
6. Filter losses were only considered in the spurious frequency bands and the authorized band was not corrected for Band reject filter losses.
7. Proper operation of the transmitter prior to adding the filter to the measurement chain.
8. All modes have been tested, but only the worst data was recorded in the report.

For Radiate Spurious Emission (3 GHz ~ 18 GHz):

Note:

1. Peak Result = Reading Level + Correct Factor.
2. If the peak values are less than the average limit of 54 dBuV/m, the average result is deemed to comply with average limit.
3. Peak: Peak detector.
4. AVG:  $VBW=1/T_{on}$ , where:  $T_{on}$  is the transmitting duration.
5. For the transmitting duration, please refer to clause 7.5.
6. Filter losses were only considered in the spurious frequency bands and the authorized band was not corrected for High Pass Filter losses.
7. Proper operation of the transmitter prior to adding the filter to the measurement chain.
8. All modes have been tested, but only the worst data was recorded in the report.

For Radiate Spurious emission (18 GHz ~ 26 GHz):

Note:

1. Measurement = Reading Level + Correct Factor.
2. If the peak values are less than the average limit of 54 dBuV/m, the average result is deemed to comply with average limit.
3. Peak: Peak detector.
4. All modes have been tested, but only the worst data was recorded in the report.

### TEST SETUP

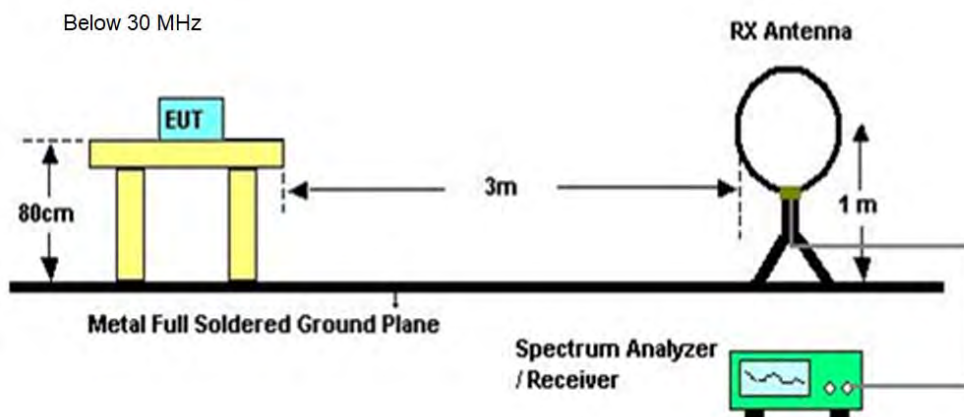

Below 1 GHz and above 30 MHz

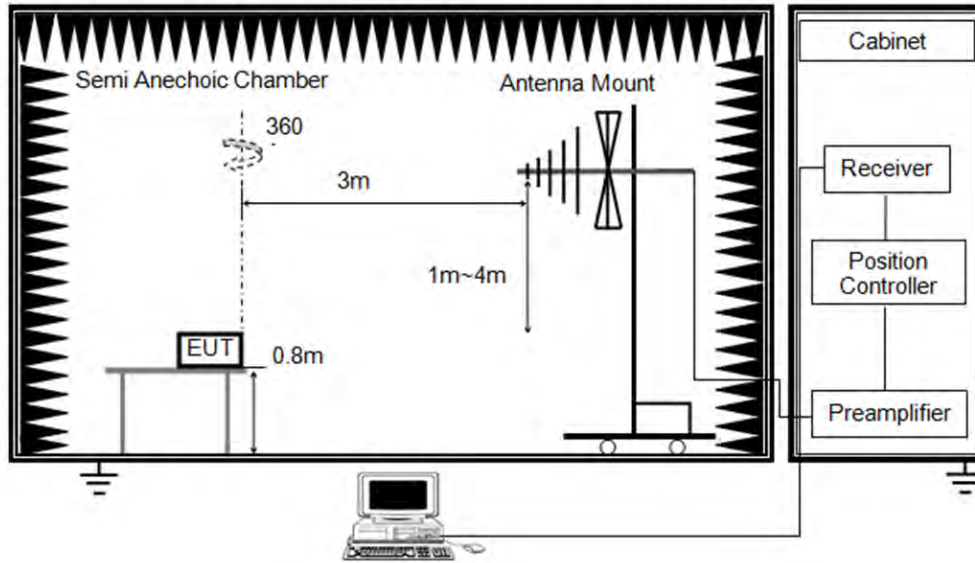

Above 1 GHz

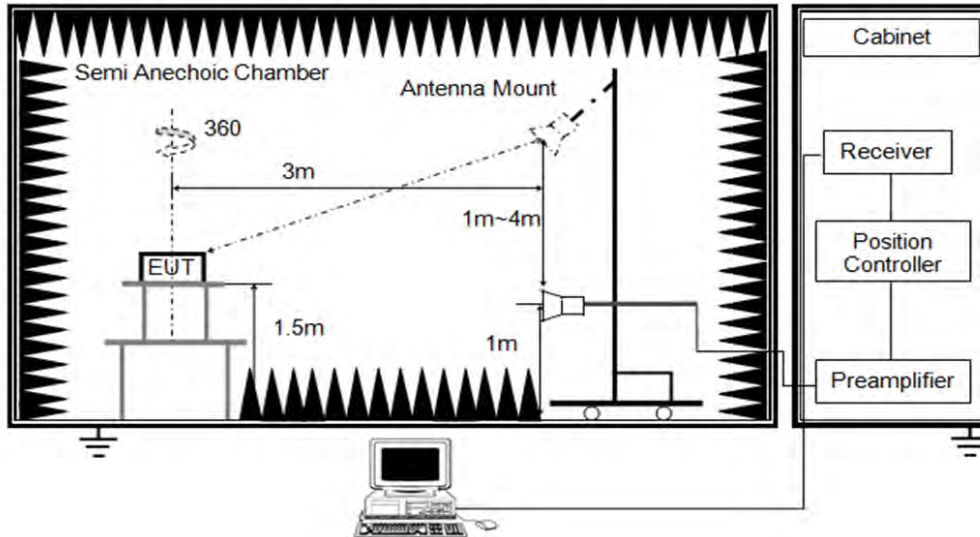

**TEST ENVIRONMENT**

Temperature	25.6°C	Relative Humidity	65%
Atmosphere Pressure	101kPa	Test Voltage	

**TEST DATE / ENGINEER**

Test Date	October 10, 2023	Test By	Rex Huang
-----------	------------------	---------	-----------

**TEST RESULTS**



## 8.1. RESTRICTED BANDEDGE

Test Mode:	802.11b PK	Frequency(MHz):	2412
Polarity:	Horizontal	Test Voltage:	AC 120V_60Hz

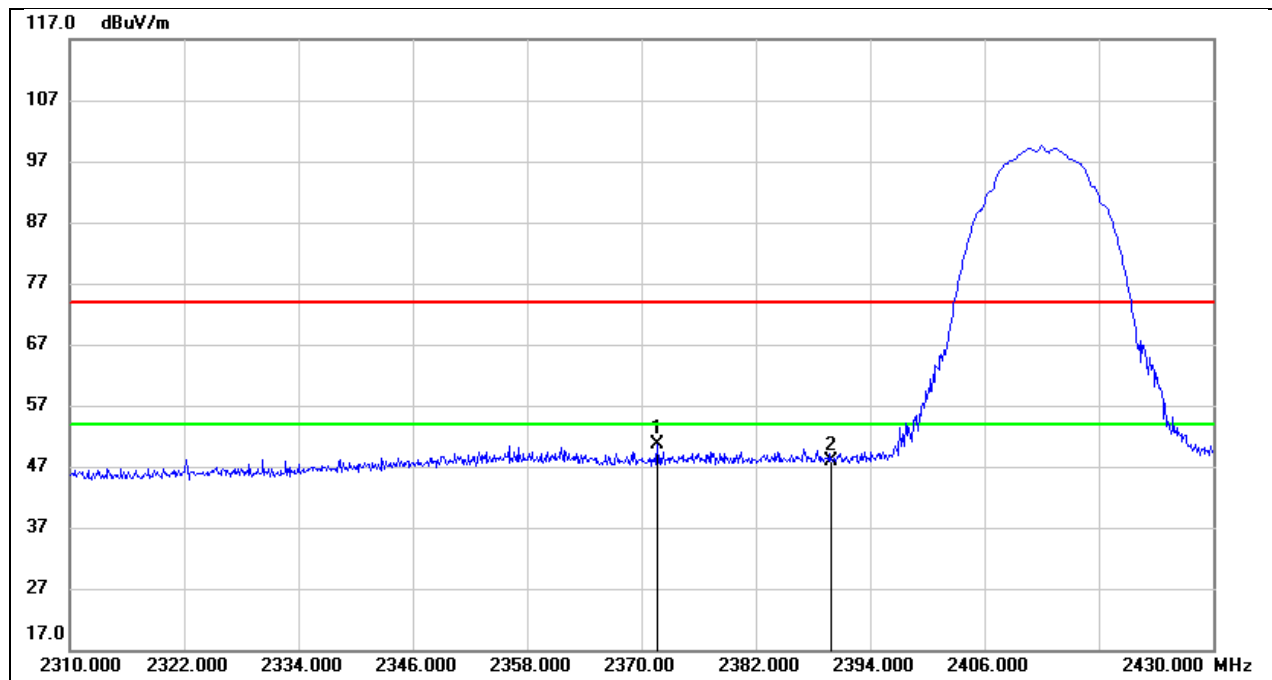

No.	Frequency (MHz)	Reading (dBuV)	Correct (dB/m)	Result (dBuV/m)	Limit (dBuV/m)	Margin (dB)	Remark
1	2371.680	18.59	32.11	50.70	74.00	-23.30	peak
2	2390.000	15.78	32.16	47.94	74.00	-26.06	peak

Test Mode:	802.11b PK	Frequency(MHz):	2412
Polarity:	Vertical	Test Voltage:	AC 120V_60Hz

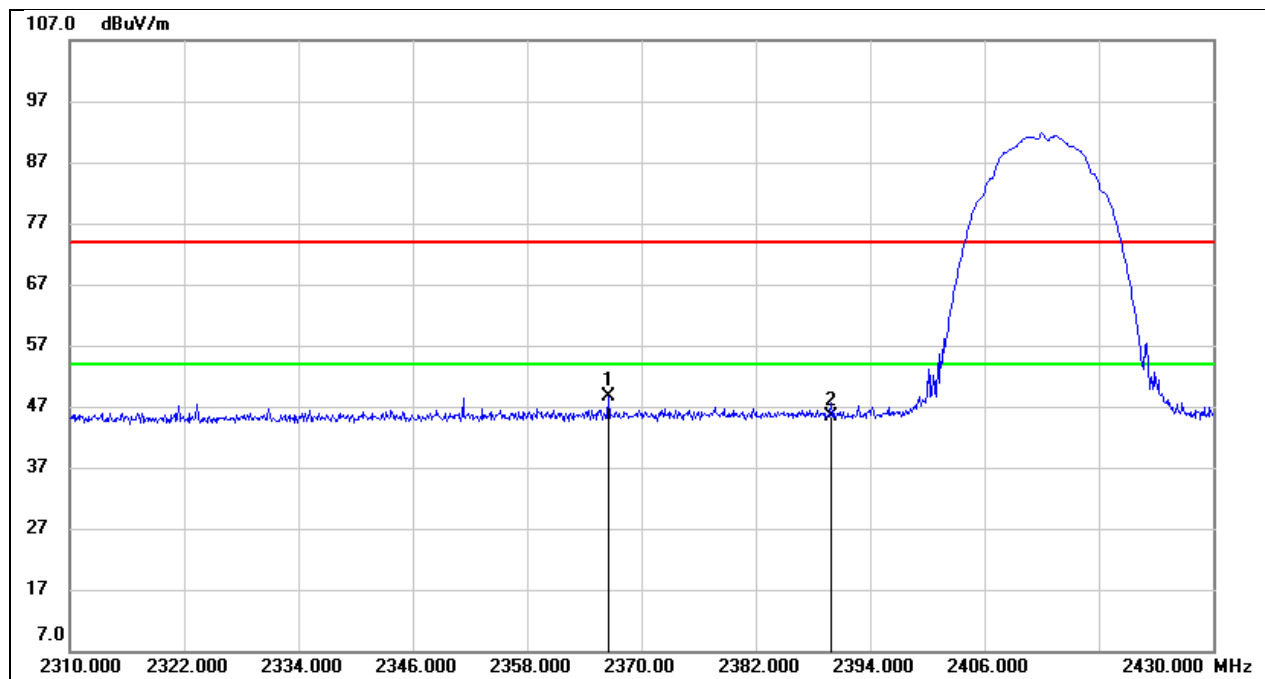

No.	Frequency (MHz)	Reading (dBuV)	Correct (dB/m)	Result (dBuV/m)	Limit (dBuV/m)	Margin (dB)	Remark
1	2366.520	16.55	32.09	48.64	74.00	-25.36	peak
2	2390.000	13.20	32.16	45.36	74.00	-28.64	peak

Test Mode:	802.11b PK	Frequency(MHz):	2462
Polarity:	Horizontal	Test Voltage:	AC 120V_60Hz

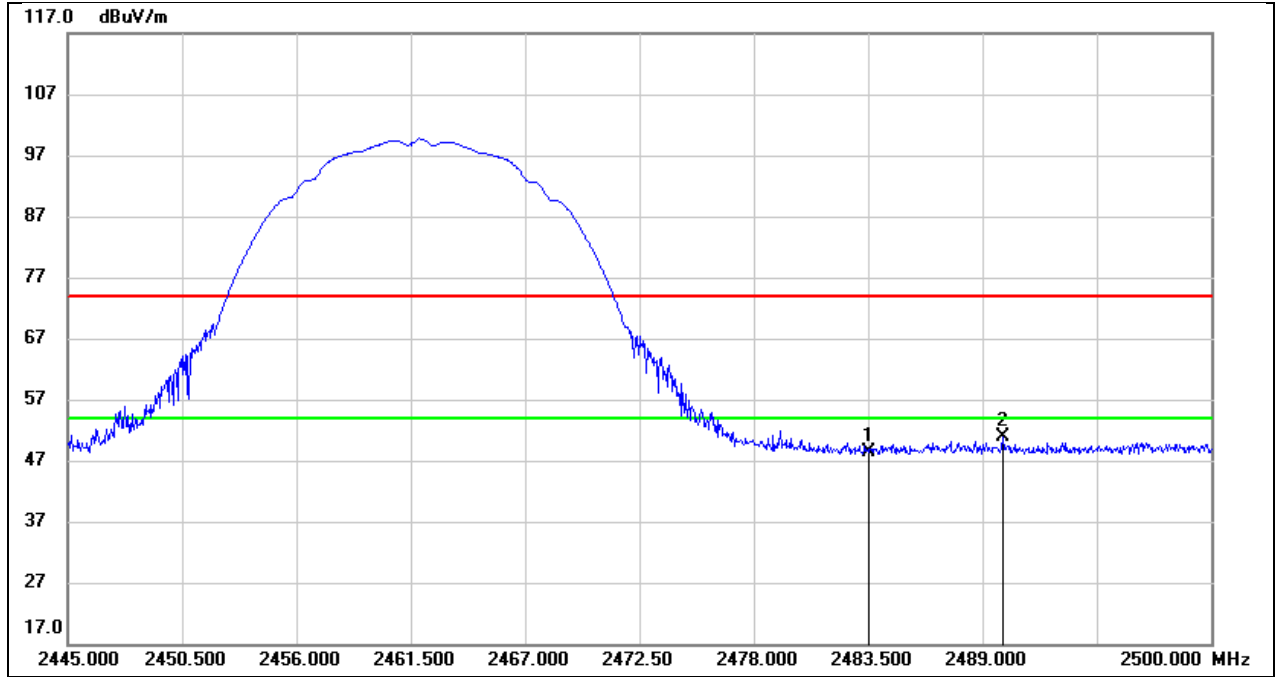

No.	Frequency (MHz)	Reading (dBuV)	Correct (dB/m)	Result (dBuV/m)	Limit (dBuV/m)	Margin (dB)	Remark
1	2483.500	15.83	32.44	48.27	74.00	-25.73	peak
2	2489.990	18.37	32.46	50.83	74.00	-23.17	peak

Test Mode:	802.11g PK	Frequency(MHz):	2412
Polarity:	Horizontal	Test Voltage:	AC 120V_60Hz

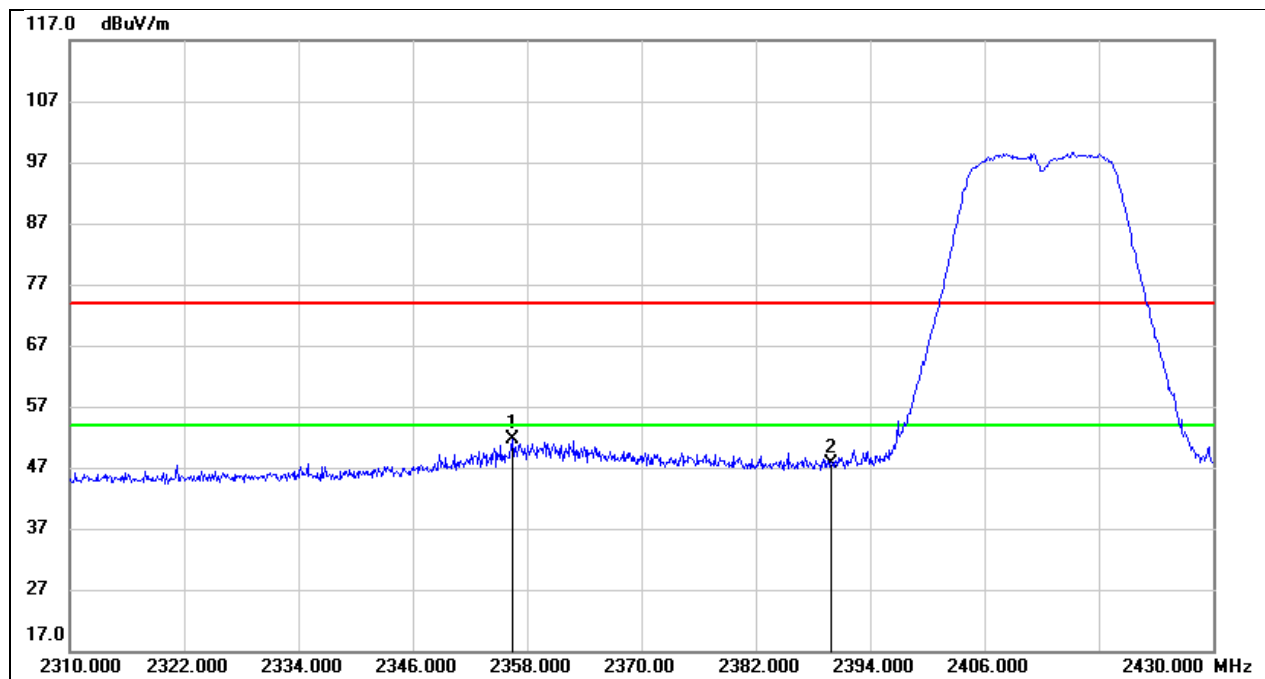

No.	Frequency (MHz)	Reading (dBuV)	Correct (dB/m)	Result (dBuV/m)	Limit (dBuV/m)	Margin (dB)	Remark
1	2356.440	19.59	32.06	51.65	74.00	-22.35	peak
2	2390.000	15.46	32.16	47.62	74.00	-26.38	peak

Test Mode:	802.11g PK	Frequency(MHz):	2462
Polarity:	Horizontal	Test Voltage:	AC 120V_60Hz

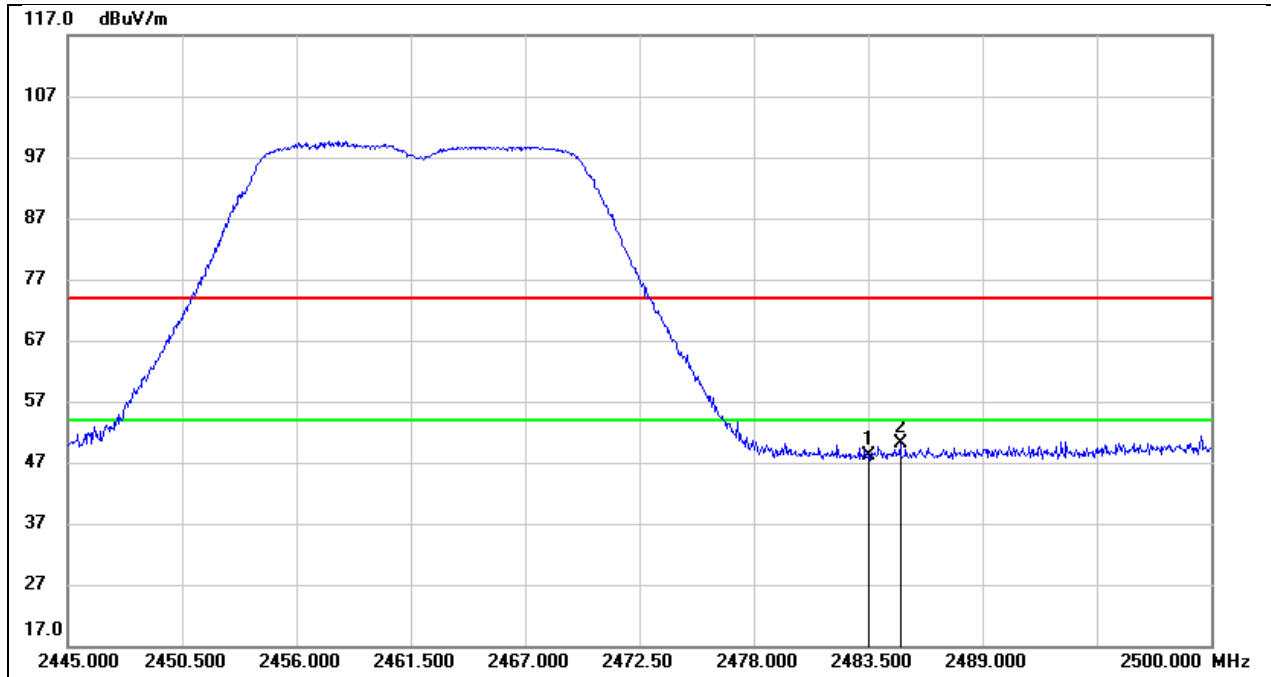

No.	Frequency (MHz)	Reading (dBuV)	Correct (dB/m)	Result (dBuV/m)	Limit (dBuV/m)	Margin (dB)	Remark
1	2483.500	15.80	32.44	48.24	74.00	-25.76	peak
2	2485.040	17.62	32.44	50.06	74.00	-23.94	peak

Test Mode:	802.11n HT20 PK	Frequency(MHz):	2412
Polarity:	Horizontal	Test Voltage:	AC 120V_60Hz

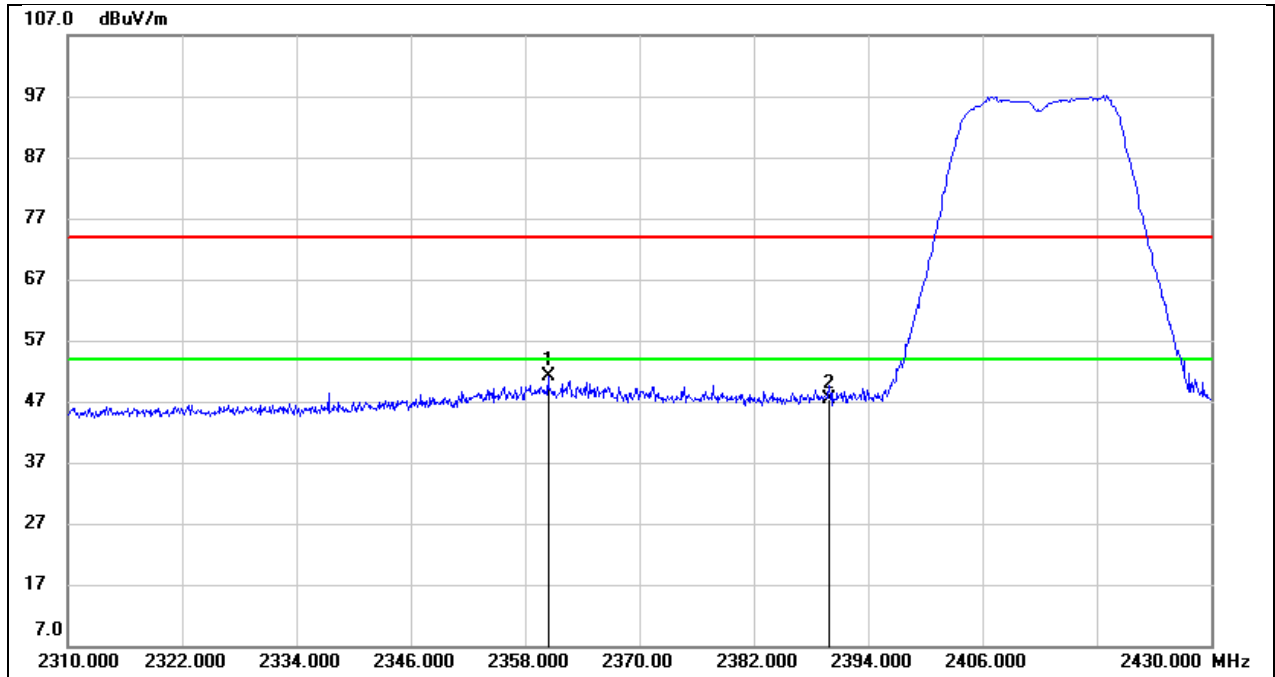

No.	Frequency (MHz)	Reading (dBuV)	Correct (dB/m)	Result (dBuV/m)	Limit (dBuV/m)	Margin (dB)	Remark
1	2360.400	19.16	32.07	51.23	74.00	-22.77	peak
2	2390.000	15.31	32.16	47.47	74.00	-26.53	peak

Test Mode:	802.11n HT20 PK	Frequency(MHz):	2462
Polarity:	Horizontal	Test Voltage:	AC 120V_60Hz

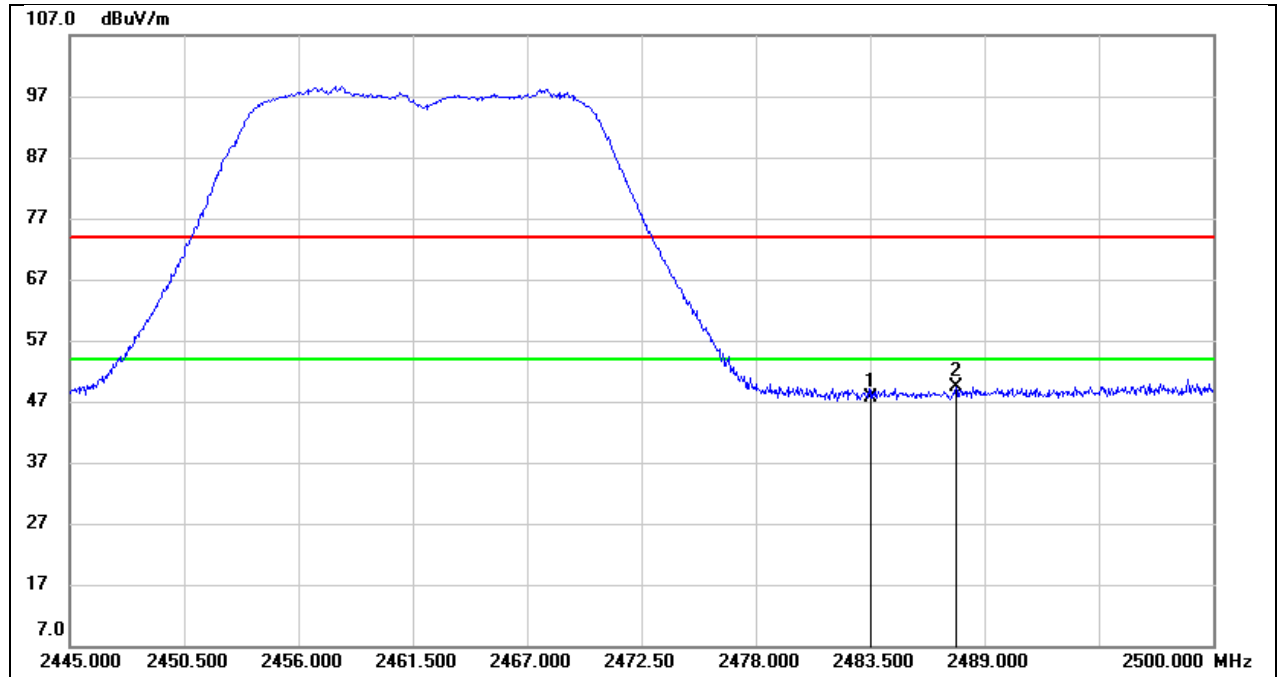

No.	Frequency (MHz)	Reading (dBuV)	Correct (dB/m)	Result (dBuV/m)	Limit (dBuV/m)	Margin (dB)	Remark
1	2483.500	15.22	32.44	47.66	74.00	-26.34	peak
2	2487.625	16.99	32.46	49.45	74.00	-24.55	peak

Test Mode:	802.11n HT40 PK	Frequency(MHz):	2422
Polarity:	Horizontal	Test Voltage:	AC 120V_60Hz

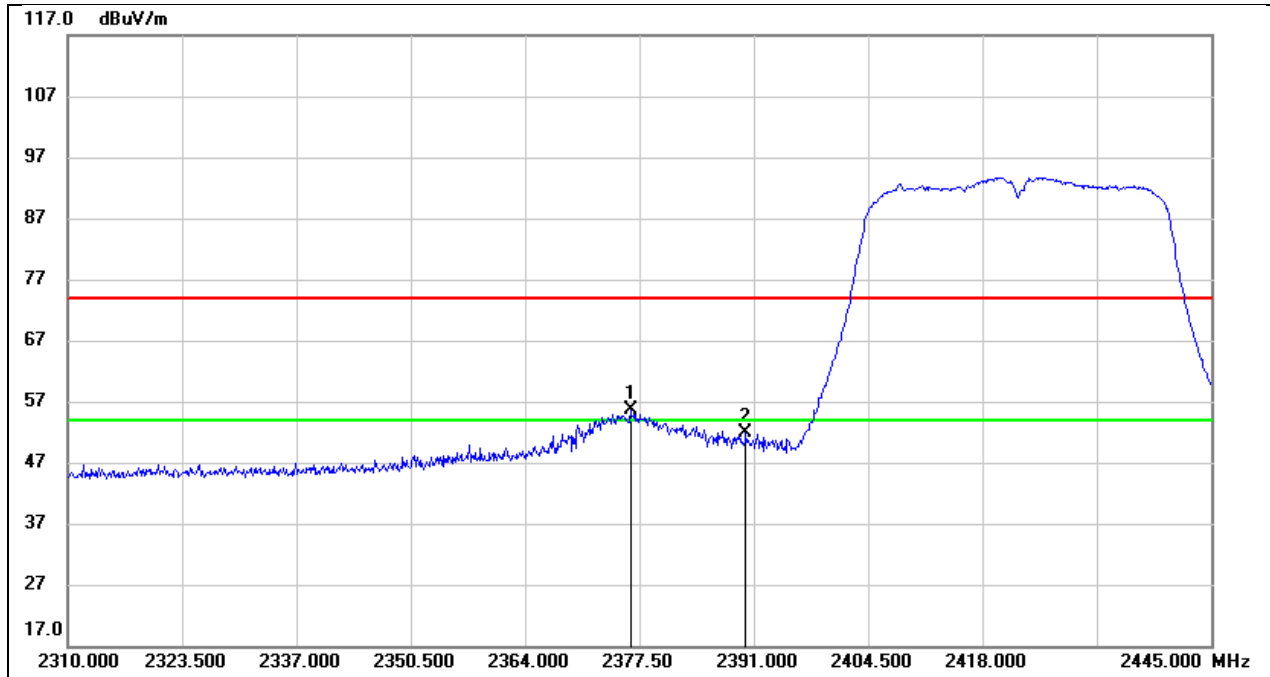

No.	Frequency (MHz)	Reading (dBuV)	Correct (dB/m)	Result (dBuV/m)	Limit (dBuV/m)	Margin (dB)	Remark
1	2376.420	23.41	32.12	55.53	74.00	-18.47	peak
2	2390.000	19.79	32.16	51.95	74.00	-22.05	peak



Test Mode:	802.11n HT40 AV	Frequency(MHz):	2422
Polarity:	Horizontal	Test Voltage:	AC 120V_60Hz

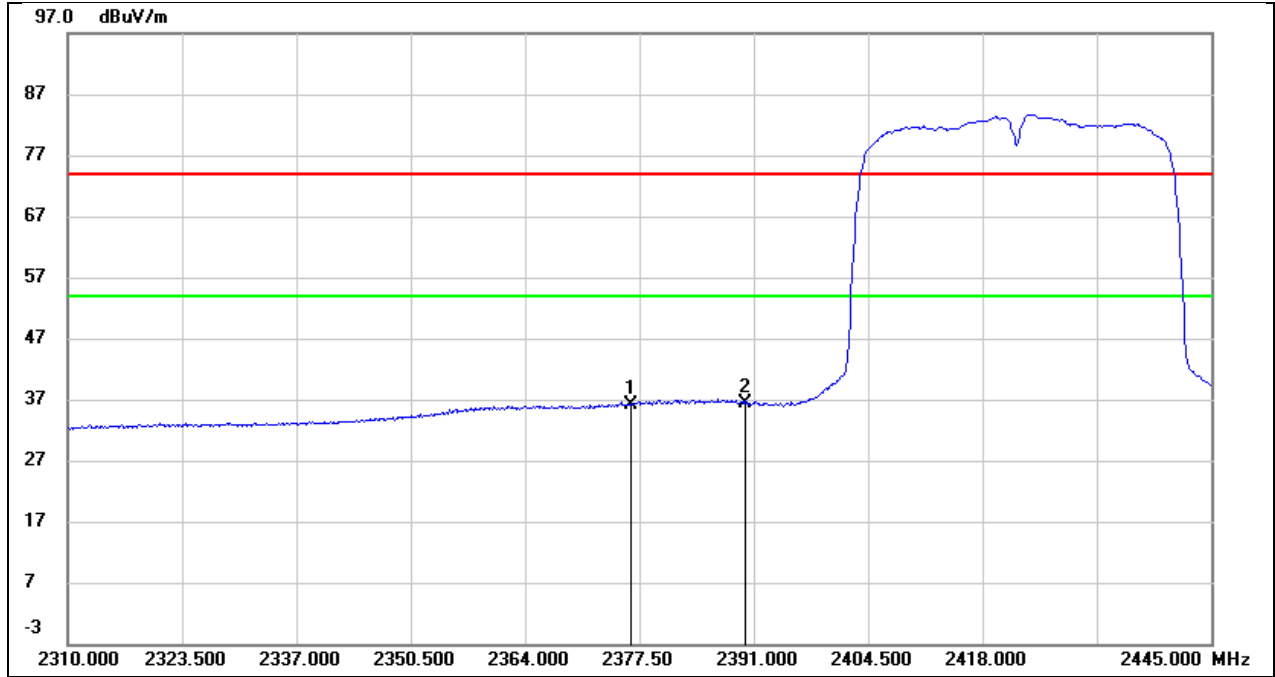

No.	Frequency (MHz)	Reading (dBuV)	Correct (dB/m)	Result (dBuV/m)	Limit (dBuV/m)	Margin (dB)	Remark
1	2376.420	4.09	32.12	36.21	54.00	-17.79	AVG
2	2390.000	4.11	32.16	36.27	54.00	-17.73	AVG

Test Mode:	802.11n HT40 PK	Frequency(MHz):	2452
Polarity:	Horizontal	Test Voltage:	AC 120V_60Hz

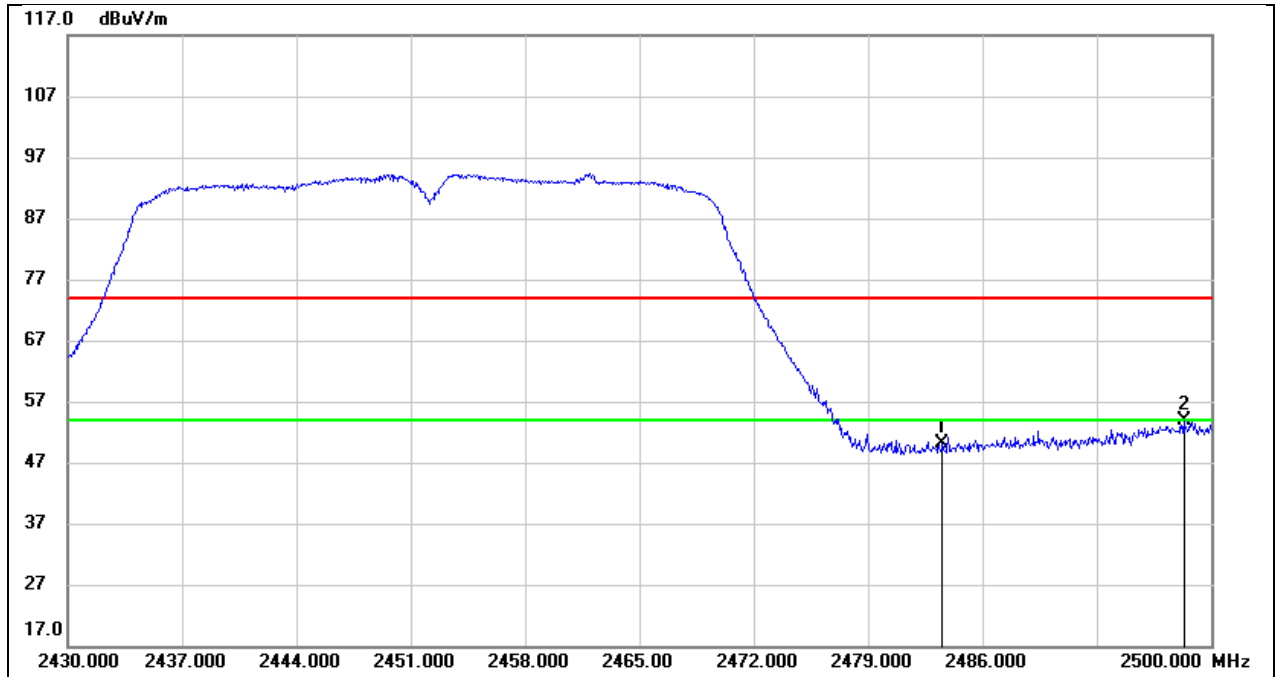

No.	Frequency (MHz)	Reading (dBuV)	Correct (dB/m)	Result (dBuV/m)	Limit (dBuV/m)	Margin (dB)	Remark
1	2483.500	17.81	32.44	50.25	74.00	-23.75	peak
2	2498.320	21.48	32.49	53.97	74.00	-20.03	peak

Test Mode:	802.11n HT40 AV	Frequency(MHz):	2452
Polarity:	Horizontal	Test Voltage:	AC 120V_60Hz

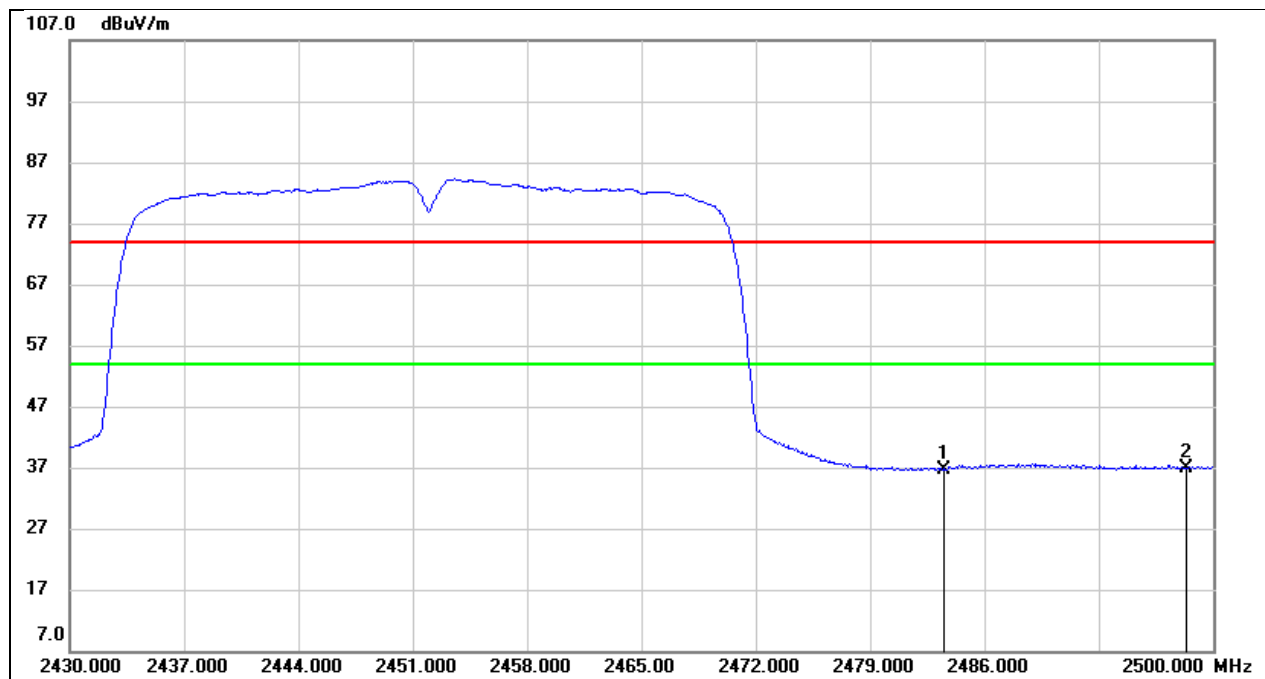

No.	Frequency (MHz)	Reading (dBuV)	Correct (dB/m)	Result (dBuV/m)	Limit (dBuV/m)	Margin (dB)	Remark
1	2483.500	4.30	32.44	36.74	54.00	-17.26	AVG
2	2498.320	4.33	32.49	36.82	54.00	-17.18	AVG

## 8.2. SPURIOUS EMISSIONS(1 GHZ~3 GHZ)

Test Mode:	802.11b	Frequency(MHz):	2412
Polarity:	Horizontal	Test Voltage:	AC 120V_60Hz

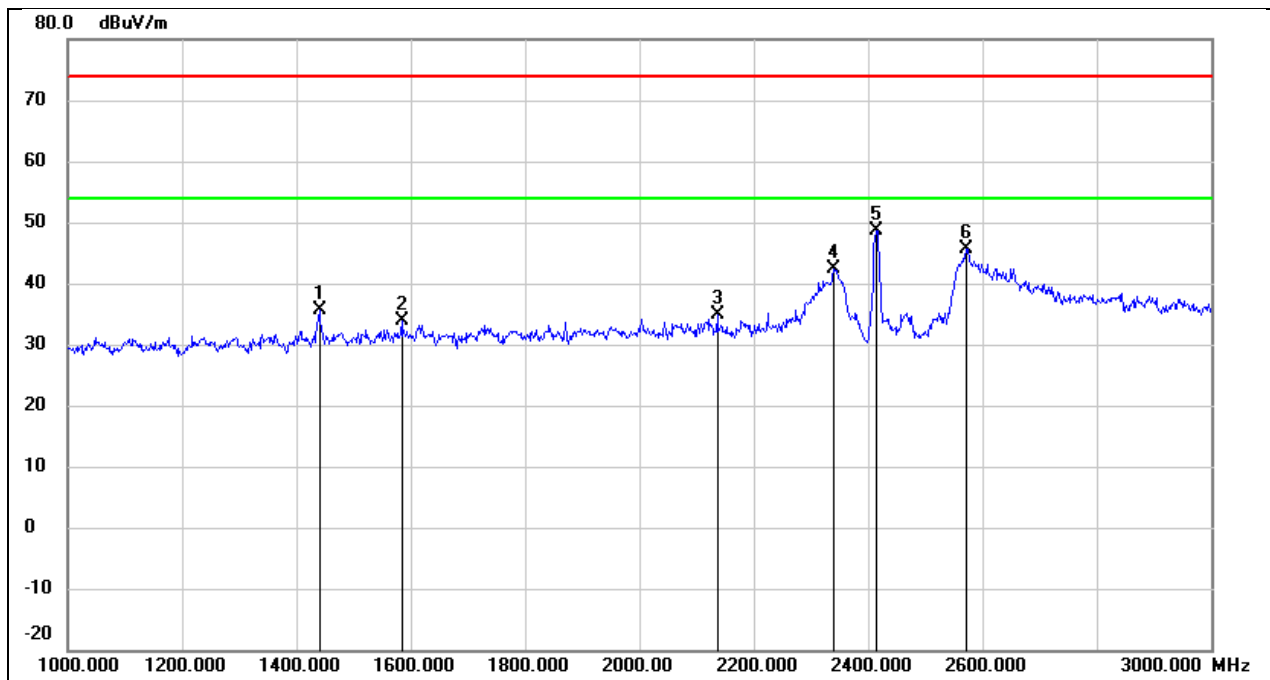

No.	Frequency (MHz)	Reading (dBuV)	Correct (dB/m)	Result (dBuV/m)	Limit (dBuV/m)	Margin (dB)	Remark
1	1440.000	48.71	-12.98	35.73	74.00	-38.27	peak
2	1584.000	46.28	-12.43	33.85	74.00	-40.15	peak
3	2136.000	45.14	-10.36	34.78	74.00	-39.22	peak
4	2340.000	51.58	-9.31	42.27	74.00	-31.73	peak
5	2412.000	57.59	-8.93	48.66	/	/	fundamental
6	2572.000	54.00	-8.27	45.73	74.00	-28.27	peak

Test Mode:	802.11b	Frequency(MHz):	2412
Polarity:	Vertical	Test Voltage:	AC 120V_60Hz

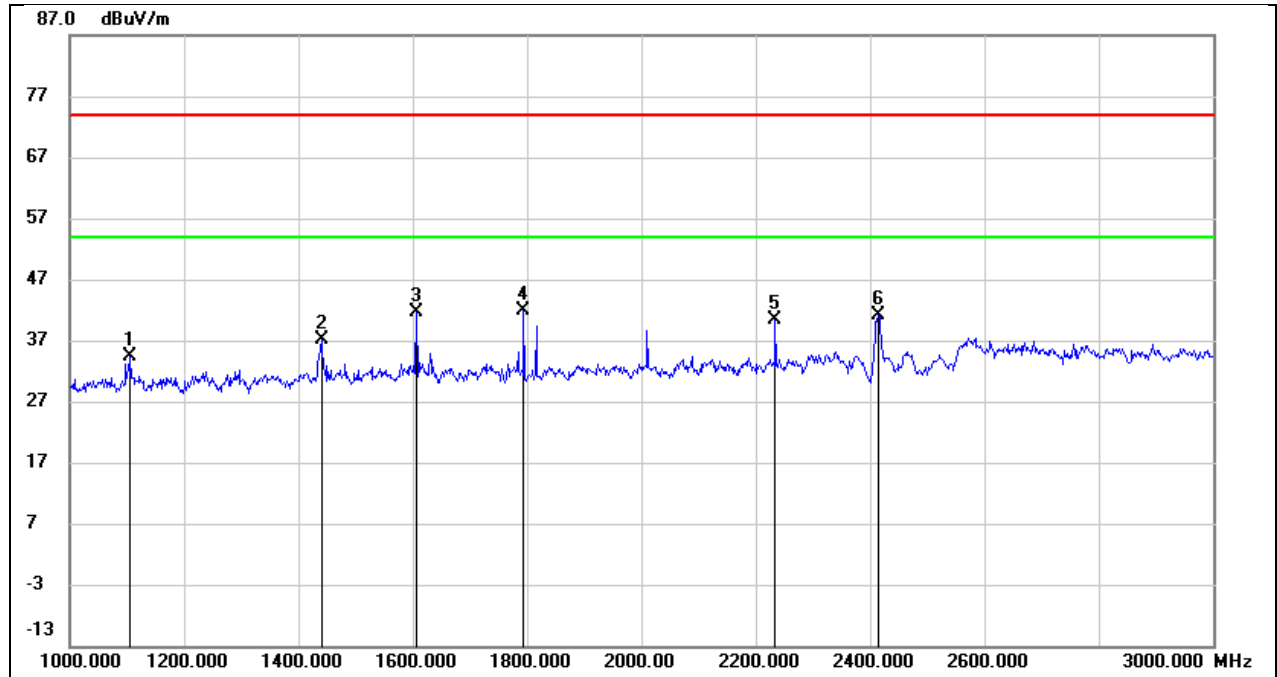

No.	Frequency (MHz)	Reading (dBuV)	Correct (dB/m)	Result (dBuV/m)	Limit (dBuV/m)	Margin (dB)	Remark
1	1106.000	49.00	-14.54	34.46	74.00	-39.54	peak
2	1440.000	50.01	-12.98	37.03	74.00	-36.97	peak
3	1606.000	54.04	-12.36	41.68	74.00	-32.32	peak
4	1794.000	53.50	-11.74	41.76	74.00	-32.24	peak
5	2234.000	50.12	-9.86	40.26	74.00	-33.74	peak
6	2412.000	49.94	-8.93	41.01	/	/	fundamental

Test Mode:	802.11b	Frequency(MHz):	2437
Polarity:	Horizontal	Test Voltage:	AC 120V_60Hz

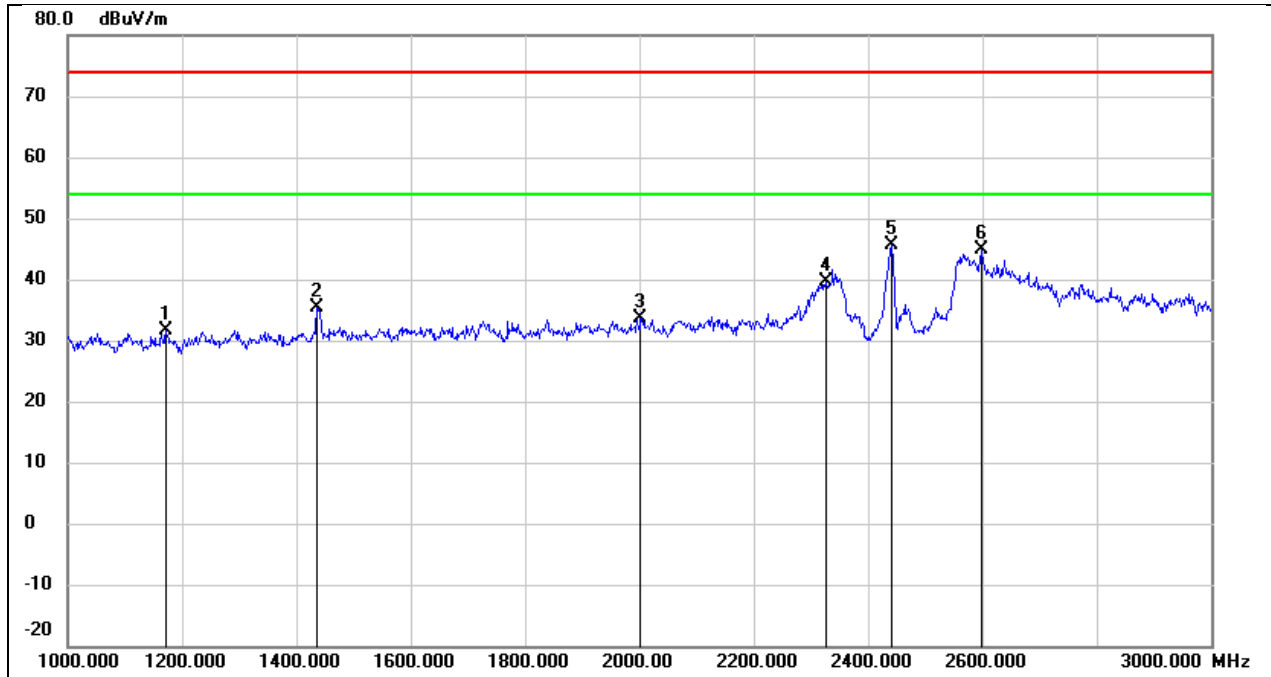

No.	Frequency (MHz)	Reading (dBuV)	Correct (dB/m)	Result (dBuV/m)	Limit (dBuV/m)	Margin (dB)	Remark
1	1172.000	45.90	-14.24	31.66	74.00	-42.34	peak
2	1436.000	48.30	-13.01	35.29	74.00	-38.71	peak
3	2002.000	44.79	-11.05	33.74	74.00	-40.26	peak
4	2326.000	49.09	-9.38	39.71	74.00	-34.29	peak
5	2437.000	54.50	-8.79	45.71	/	/	fundamental
6	2598.000	53.10	-8.19	44.91	74.00	-29.09	peak

Test Mode:	802.11b	Frequency(MHz):	2437
Polarity:	Vertical	Test Voltage:	AC 120V_60Hz

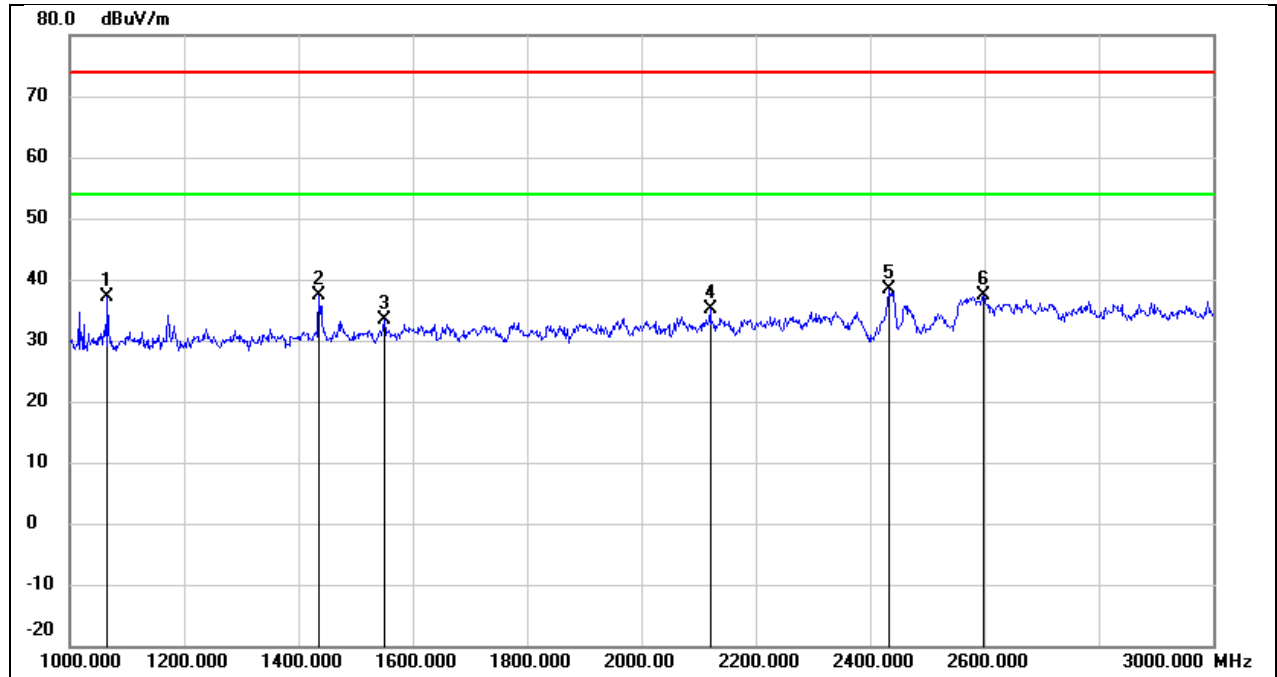

No.	Frequency (MHz)	Reading (dBuV)	Correct (dB/m)	Result (dBuV/m)	Limit (dBuV/m)	Margin (dB)	Remark
1	1066.000	51.75	-14.73	37.02	74.00	-36.98	peak
2	1436.000	50.41	-13.01	37.40	74.00	-36.60	peak
3	1550.000	45.98	-12.54	33.44	74.00	-40.56	peak
4	2120.000	45.60	-10.45	35.15	74.00	-38.85	peak
5	2437.000	47.11	-8.83	38.28	/	/	fundamental
6	2598.000	45.45	-8.19	37.26	74.00	-36.74	peak

Test Mode:	802.11b	Frequency(MHz):	2462
Polarity:	Horizontal	Test Voltage:	AC 120V_60Hz

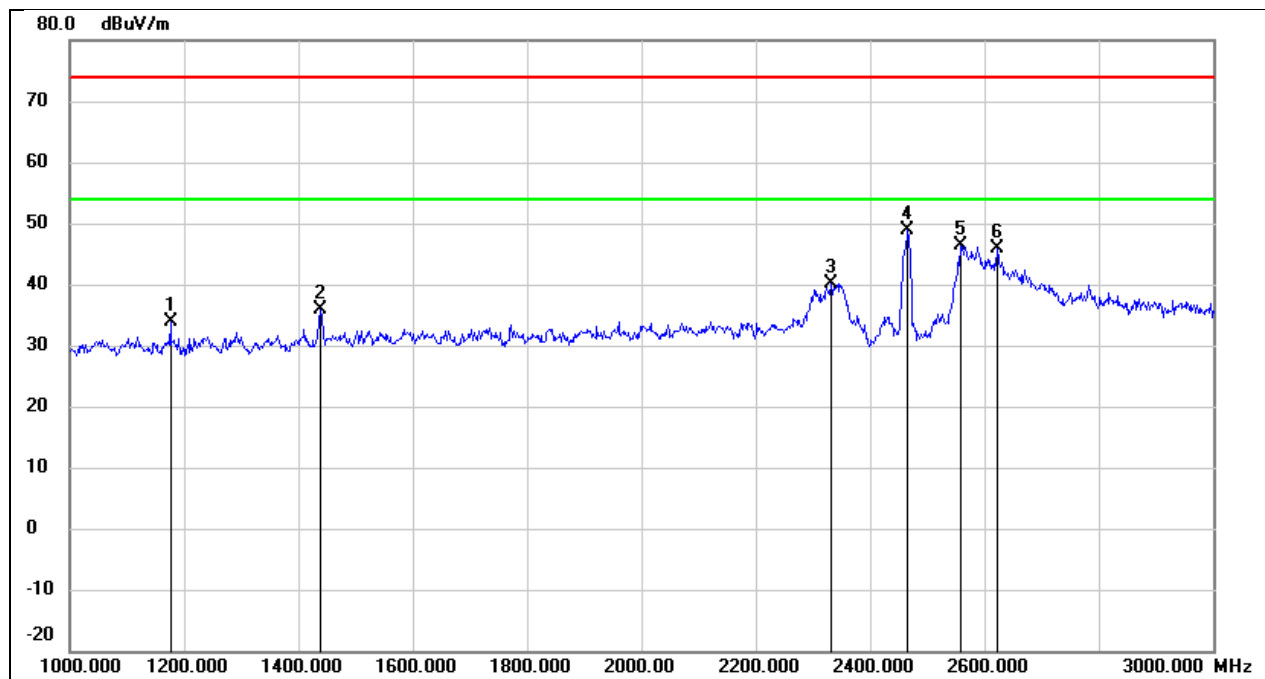

No.	Frequency (MHz)	Reading (dBuV)	Correct (dB/m)	Result (dBuV/m)	Limit (dBuV/m)	Margin (dB)	Remark
1	1176.000	48.07	-14.21	33.86	74.00	-40.14	peak
2	1438.000	48.82	-13.00	35.82	74.00	-38.18	peak
3	2332.000	49.54	-9.36	40.18	74.00	-33.82	peak
4	2462.000	57.50	-8.66	48.84	/	/	fundamental
5	2558.000	54.60	-8.32	46.28	74.00	-27.72	peak
6	2622.000	53.95	-8.12	45.83	74.00	-28.17	peak



Test Mode:	802.11b	Frequency(MHz):	2462
Polarity:	Vertical	Test Voltage:	AC 120V_60Hz

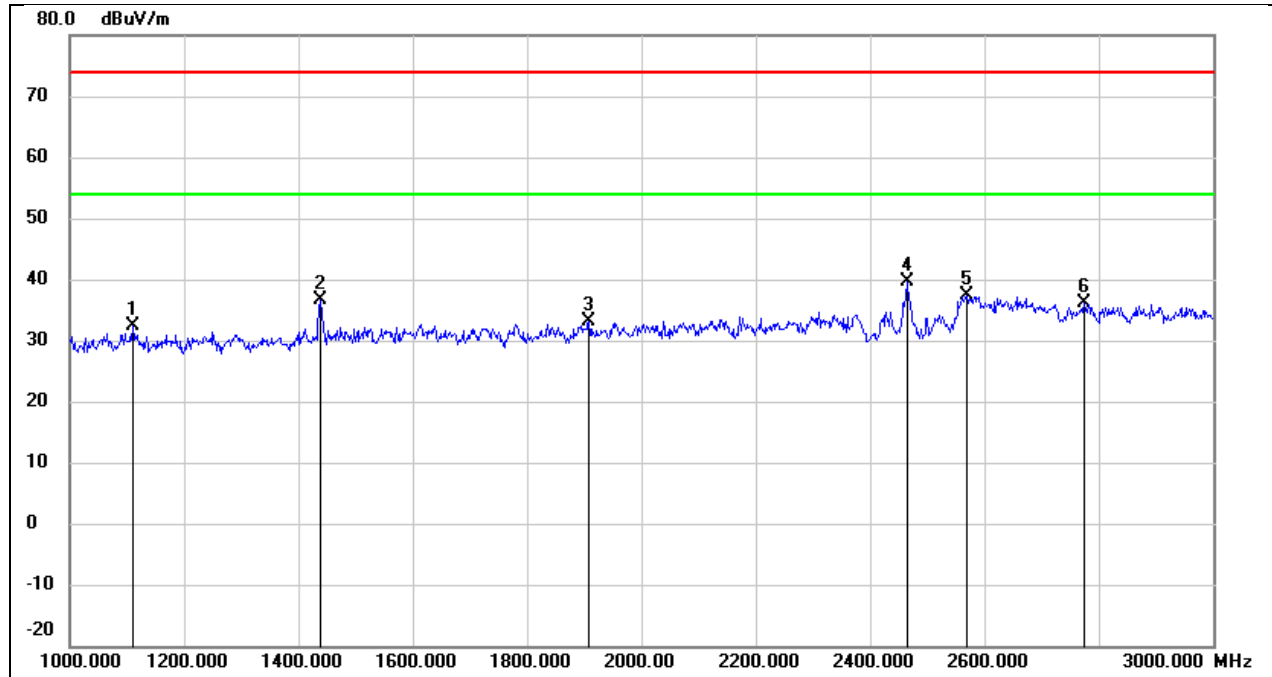

No.	Frequency (MHz)	Reading (dBuV)	Correct (dB/m)	Result (dBuV/m)	Limit (dBuV/m)	Margin (dB)	Remark
1	1110.000	46.79	-14.52	32.27	74.00	-41.73	peak
2	1438.000	49.64	-13.00	36.64	74.00	-37.36	peak
3	1908.000	44.47	-11.36	33.11	74.00	-40.89	peak
4	2462.000	48.23	-8.68	39.55	/	/	fundamental
5	2570.000	45.62	-8.27	37.35	74.00	-36.65	peak
6	2774.000	43.69	-7.67	36.02	74.00	-37.98	peak

### 8.3. SPURIOUS EMISSIONS(3 GHZ~18 GHZ)

Test Mode:	802.11b	Frequency(MHz):	2412
Polarity:	Horizontal	Test Voltage:	AC 120V_60Hz

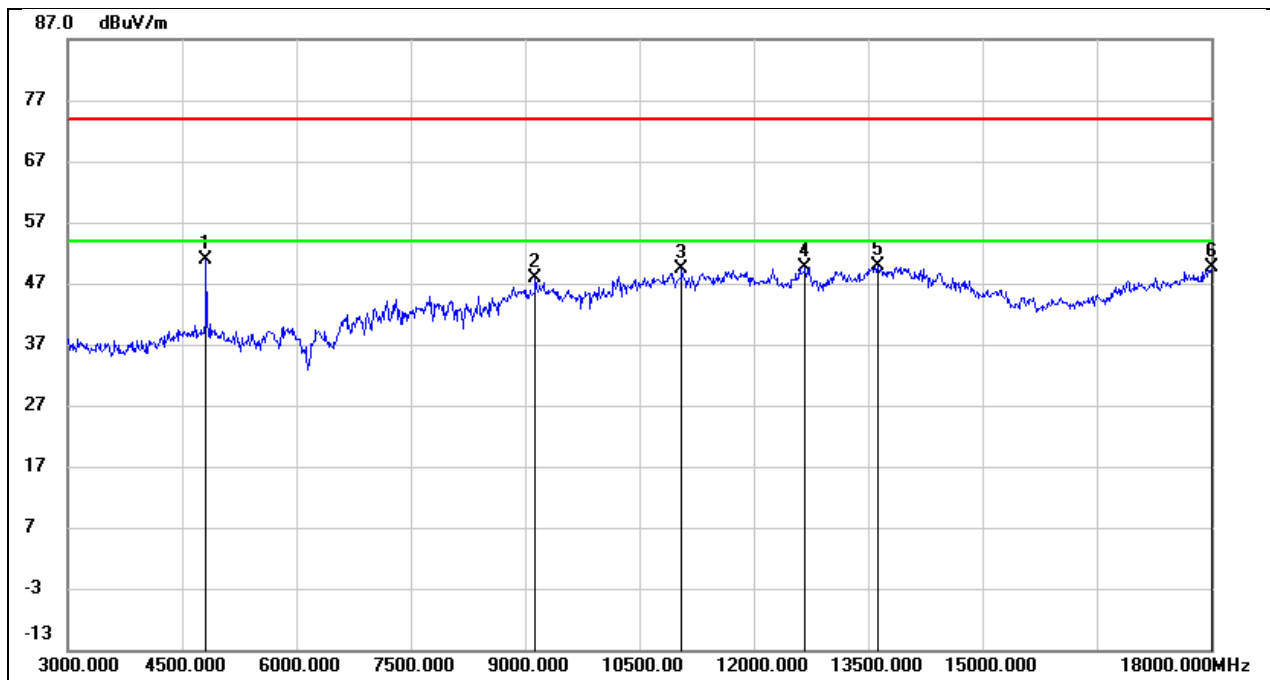

No.	Frequency (MHz)	Reading (dBuV)	Correct (dB/m)	Result (dBuV/m)	Limit (dBuV/m)	Margin (dB)	Remark
1	4815.000	51.22	-0.26	50.96	74.00	-23.04	peak
2	9135.000	37.29	10.55	47.84	74.00	-26.16	peak
3	11055.000	34.43	14.96	49.39	74.00	-24.61	peak
4	12675.000	31.74	17.99	49.73	74.00	-24.27	peak
5	13620.000	28.77	21.15	49.92	74.00	-24.08	peak
6	18000.000	23.96	25.69	49.65	74.00	-24.35	peak

Test Mode:	802.11b	Frequency(MHz):	2412
Polarity:	Vertical	Test Voltage:	AC 120V_60Hz

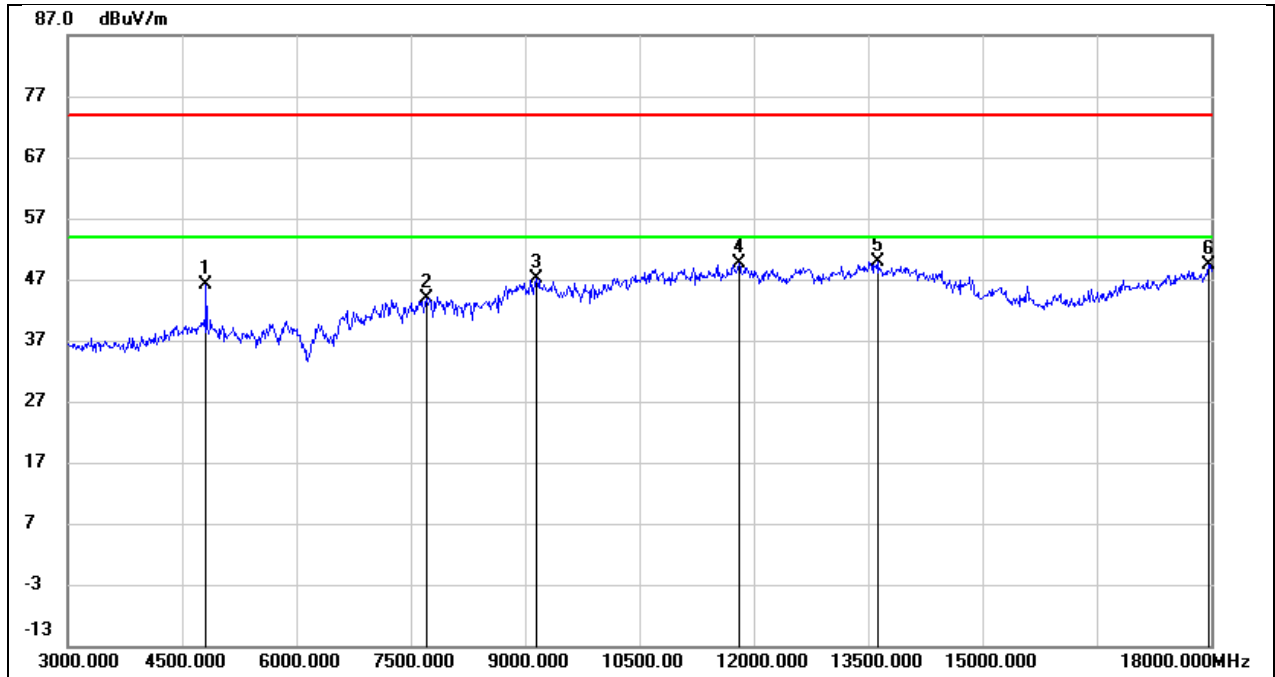

No.	Frequency (MHz)	Reading (dBuV)	Correct (dB/m)	Result (dBuV/m)	Limit (dBuV/m)	Margin (dB)	Remark
1	4815.000	46.30	-0.26	46.04	74.00	-27.96	peak
2	7710.000	37.65	6.33	43.98	74.00	-30.02	peak
3	9150.000	36.52	10.54	47.06	74.00	-26.94	peak
4	11805.000	32.13	17.43	49.56	74.00	-24.44	peak
5	13620.000	28.82	21.15	49.97	74.00	-24.03	peak
6	17970.000	23.96	25.51	49.47	74.00	-24.53	peak

Test Mode:	802.11b	Frequency(MHz):	2437
Polarity:	Horizontal	Test Voltage:	AC 120V_60Hz

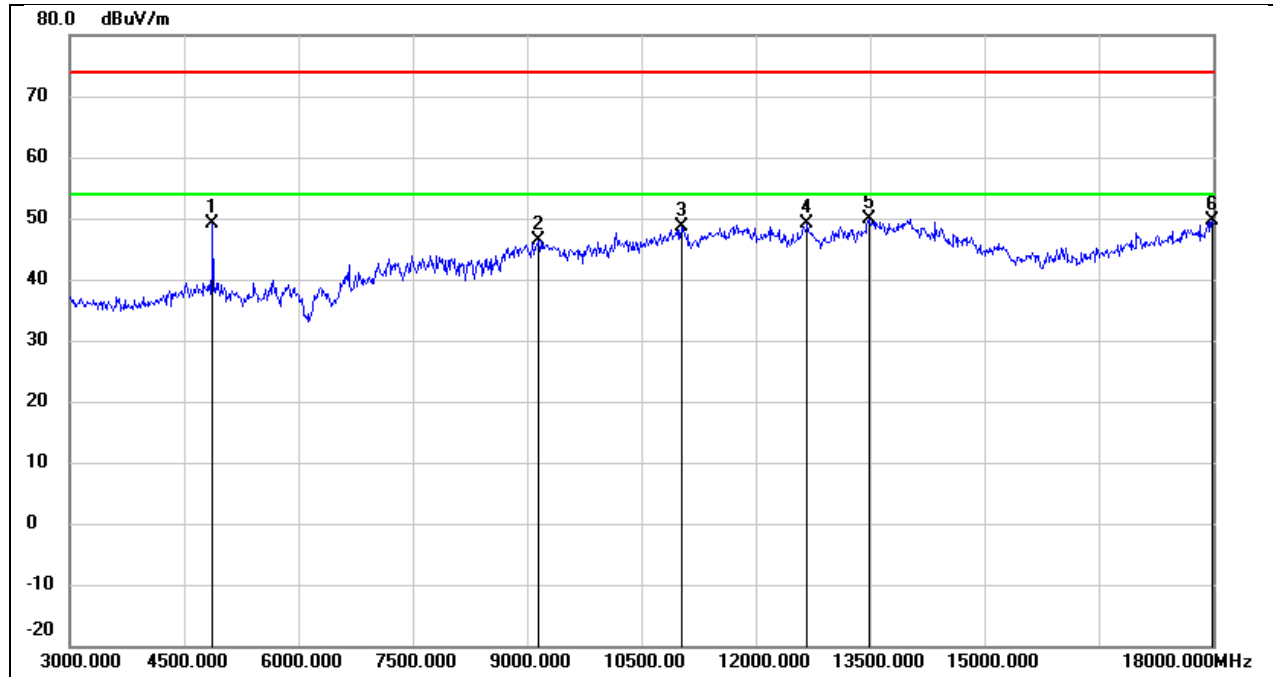

No.	Frequency (MHz)	Reading (dBuV)	Correct (dB/m)	Result (dBuV/m)	Limit (dBuV/m)	Margin (dB)	Remark
1	4875.000	49.20	-0.03	49.17	74.00	-24.83	peak
2	9150.000	35.77	10.54	46.31	74.00	-27.69	peak
3	11025.000	33.80	14.85	48.65	74.00	-25.35	peak
4	12675.000	31.05	17.99	49.04	74.00	-24.96	peak
5	13485.000	28.97	20.84	49.81	74.00	-24.19	peak
6	17985.000	23.95	25.60	49.55	74.00	-24.45	peak

Test Mode:	802.11b	Frequency(MHz):	2437
Polarity:	Vertical	Test Voltage:	AC 120V_60Hz

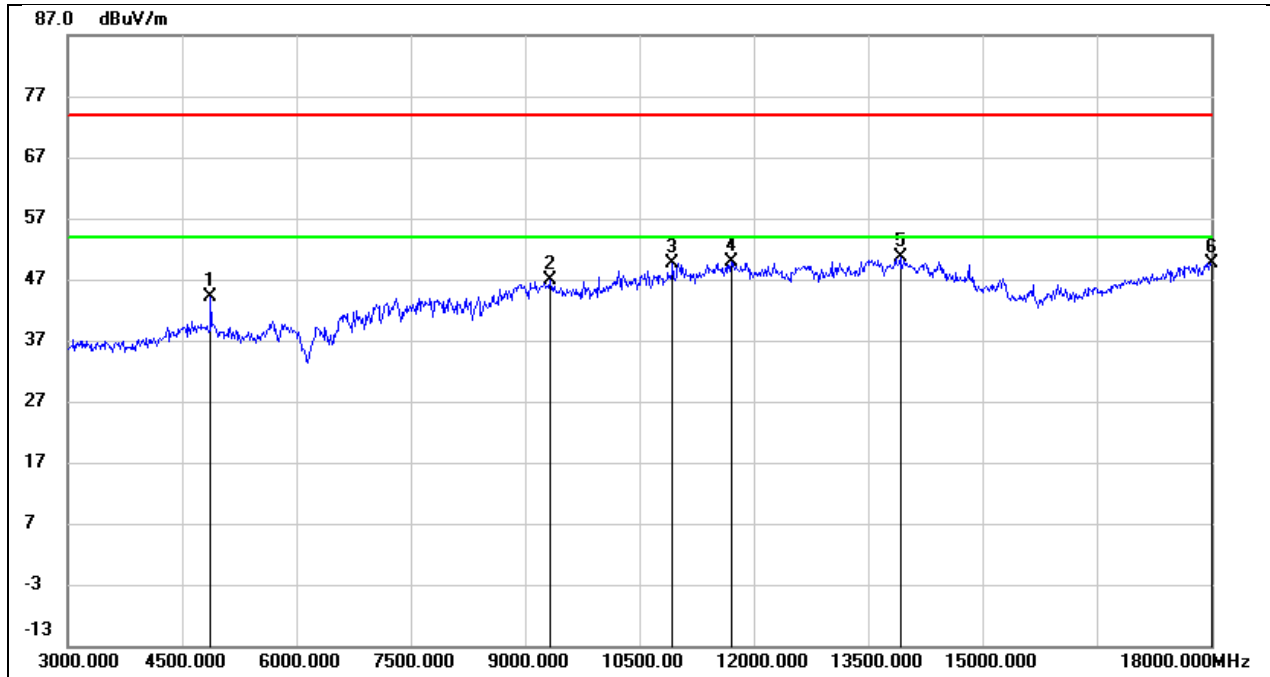

No.	Frequency (MHz)	Reading (dBuV)	Correct (dB/m)	Result (dBuV/m)	Limit (dBuV/m)	Margin (dB)	Remark
1	4875.000	44.16	-0.03	44.13	74.00	-29.87	peak
2	9330.000	36.17	10.62	46.79	74.00	-27.21	peak
3	10935.000	35.19	14.54	49.73	74.00	-24.27	peak
4	11700.000	32.78	17.14	49.92	74.00	-24.08	peak
5	13920.000	28.91	21.79	50.70	74.00	-23.30	peak
6	18000.000	23.98	25.69	49.67	74.00	-24.33	peak

Test Mode:	802.11b	Frequency(MHz):	2462
Polarity:	Horizontal	Test Voltage:	AC 120V_60Hz

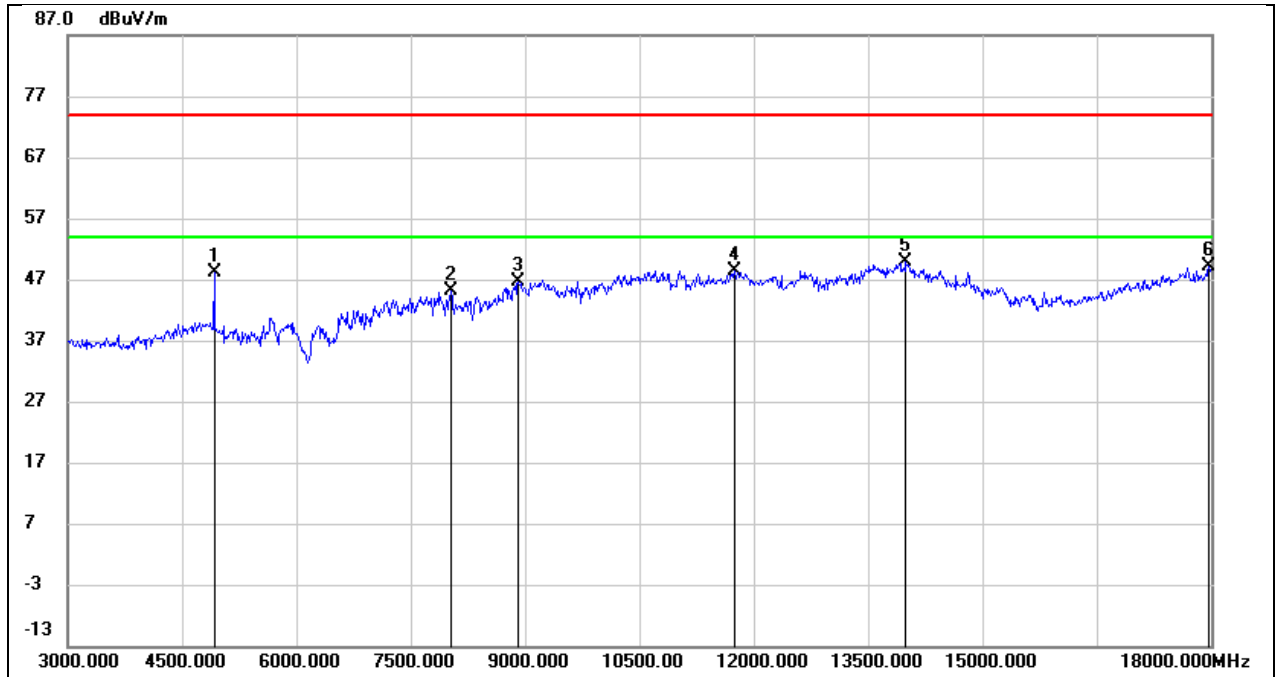

No.	Frequency (MHz)	Reading (dBuV)	Correct (dB/m)	Result (dBuV/m)	Limit (dBuV/m)	Margin (dB)	Remark
1	4920.000	47.96	0.14	48.10	74.00	-25.90	peak
2	8025.000	38.87	6.34	45.21	74.00	-28.79	peak
3	8910.000	36.78	9.82	46.60	74.00	-27.40	peak
4	11745.000	31.19	17.27	48.46	74.00	-25.54	peak
5	13995.000	27.84	21.95	49.79	74.00	-24.21	peak
6	17970.000	23.56	25.51	49.07	74.00	-24.93	peak

Test Mode:	802.11b	Frequency(MHz):	2462
Polarity:	Vertical	Test Voltage:	AC 120V_60Hz

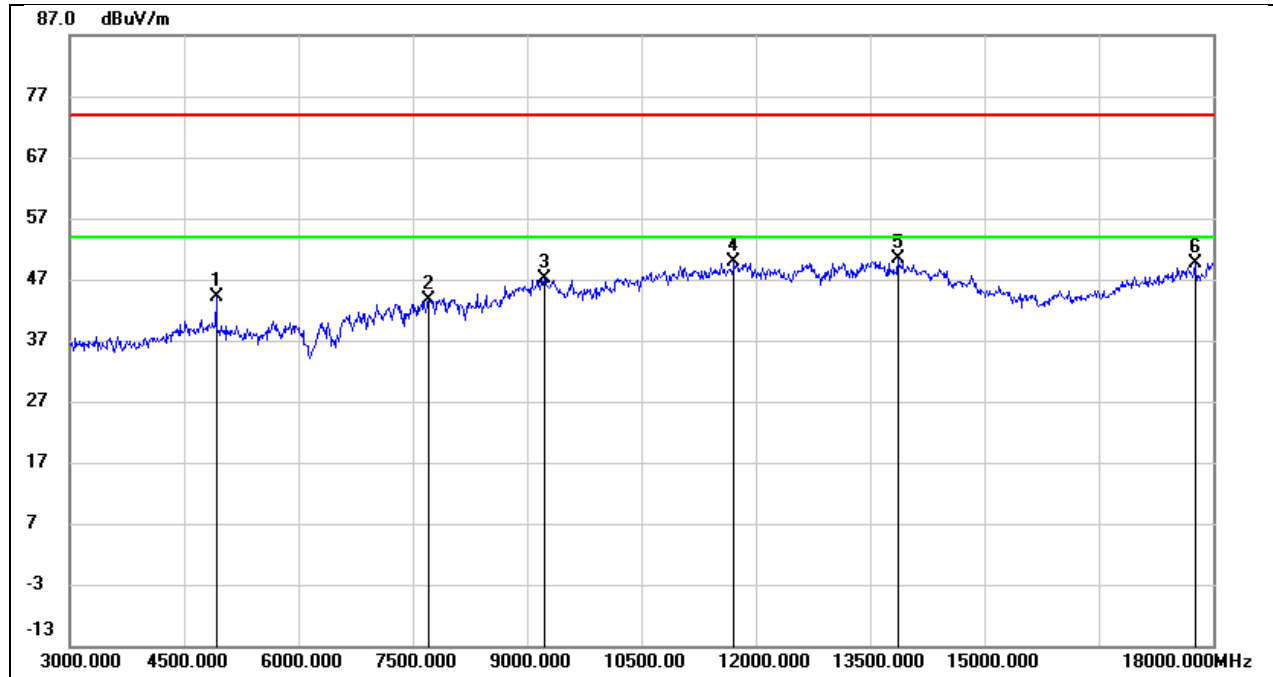

No.	Frequency (MHz)	Reading (dBuV)	Correct (dB/m)	Result (dBuV/m)	Limit (dBuV/m)	Margin (dB)	Remark
1	4920.000	44.07	0.14	44.21	74.00	-29.79	peak
2	7710.000	37.37	6.33	43.70	74.00	-30.30	peak
3	9225.000	36.51	10.58	47.09	74.00	-26.91	peak
4	11715.000	32.59	17.19	49.78	74.00	-24.22	peak
5	13860.000	28.69	21.67	50.36	74.00	-23.64	peak
6	17760.000	25.41	24.27	49.68	74.00	-24.32	peak

Test Mode:	802.11g	Frequency(MHz):	2412
Polarity:	Horizontal	Test Voltage:	AC 120V_60Hz

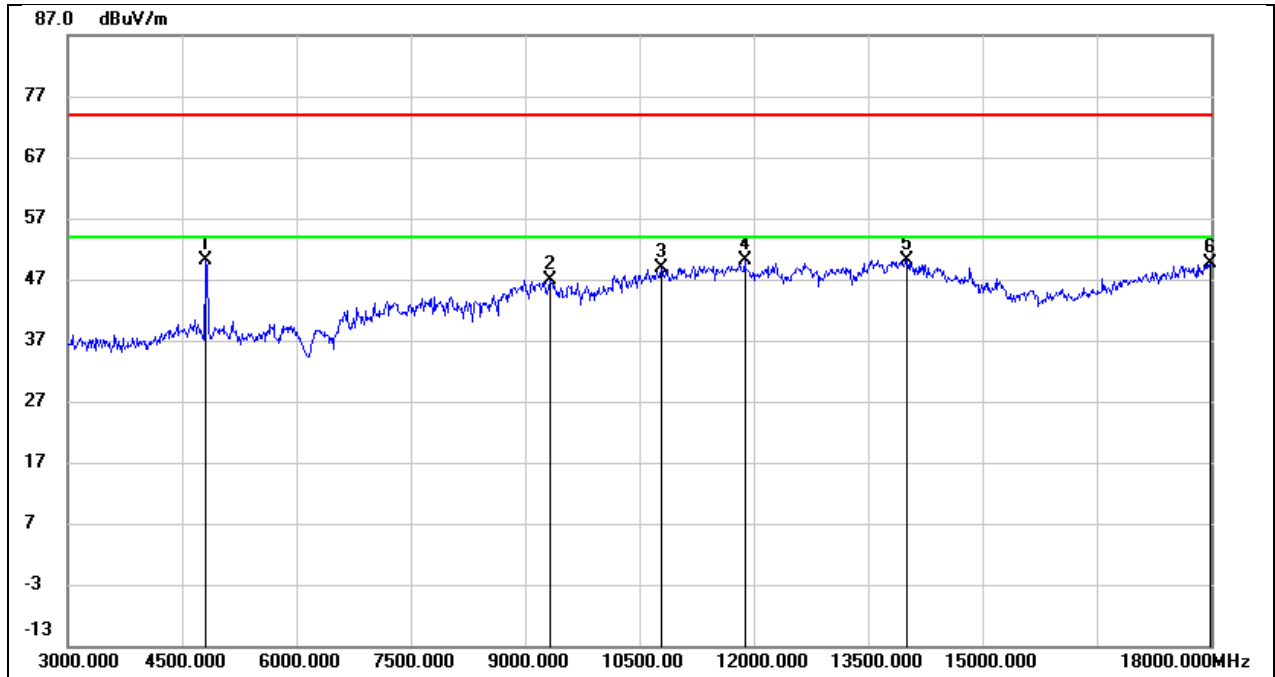

No.	Frequency (MHz)	Reading (dBuV)	Correct (dB/m)	Result (dBuV/m)	Limit (dBuV/m)	Margin (dB)	Remark
1	4815.000	50.28	-0.26	50.02	74.00	-23.98	peak
2	9330.000	36.28	10.62	46.90	74.00	-27.10	peak
3	10785.000	34.98	14.01	48.99	74.00	-25.01	peak
4	11880.000	32.59	17.63	50.22	74.00	-23.78	peak
5	14010.000	28.25	21.93	50.18	74.00	-23.82	peak
6	17985.000	24.05	25.60	49.65	74.00	-24.35	peak



Test Mode:	802.11g	Frequency(MHz):	2412
Polarity:	Vertical	Test Voltage:	AC 120V_60Hz

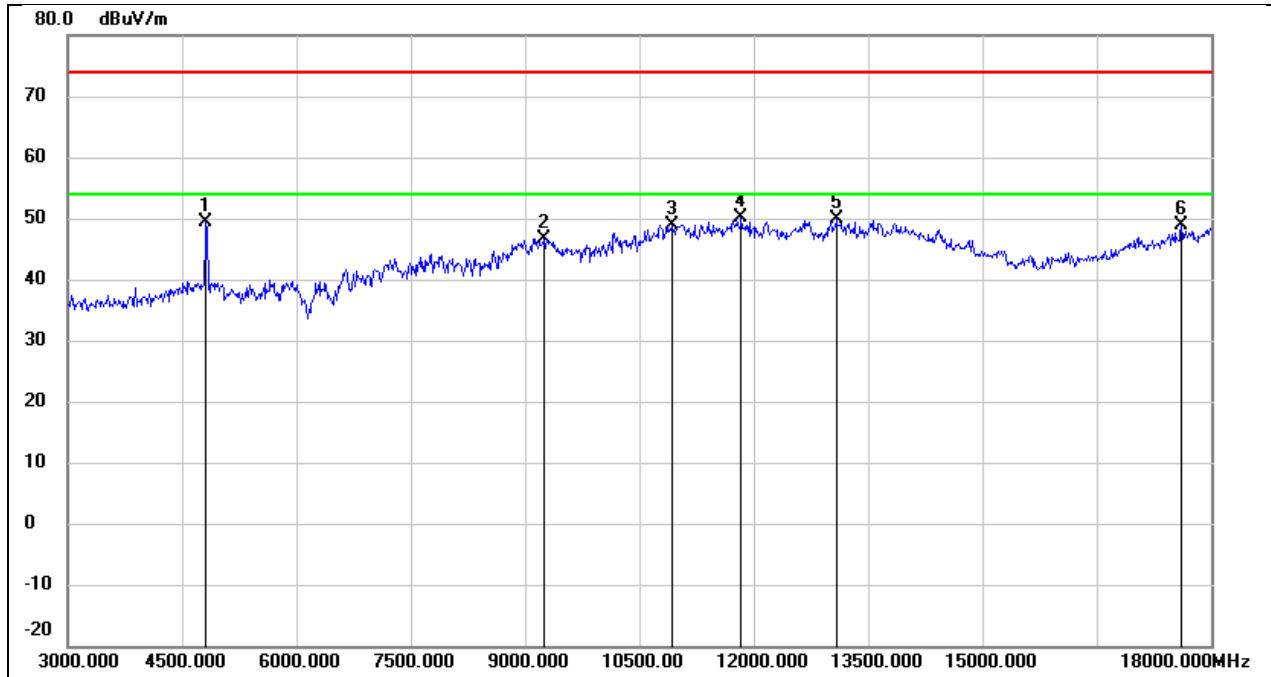

No.	Frequency (MHz)	Reading (dBuV)	Correct (dB/m)	Result (dBuV/m)	Limit (dBuV/m)	Margin (dB)	Remark
1	4815.000	49.75	-0.26	49.49	74.00	-24.51	peak
2	9240.000	36.12	10.58	46.70	74.00	-27.30	peak
3	10920.000	34.44	14.49	48.93	74.00	-25.07	peak
4	11835.000	32.70	17.51	50.21	74.00	-23.79	peak
5	13080.000	30.75	19.07	49.82	74.00	-24.18	peak
6	17610.000	25.39	23.38	48.77	74.00	-25.23	peak

Test Mode:	802.11g	Frequency(MHz):	2437
Polarity:	Horizontal	Test Voltage:	AC 120V_60Hz

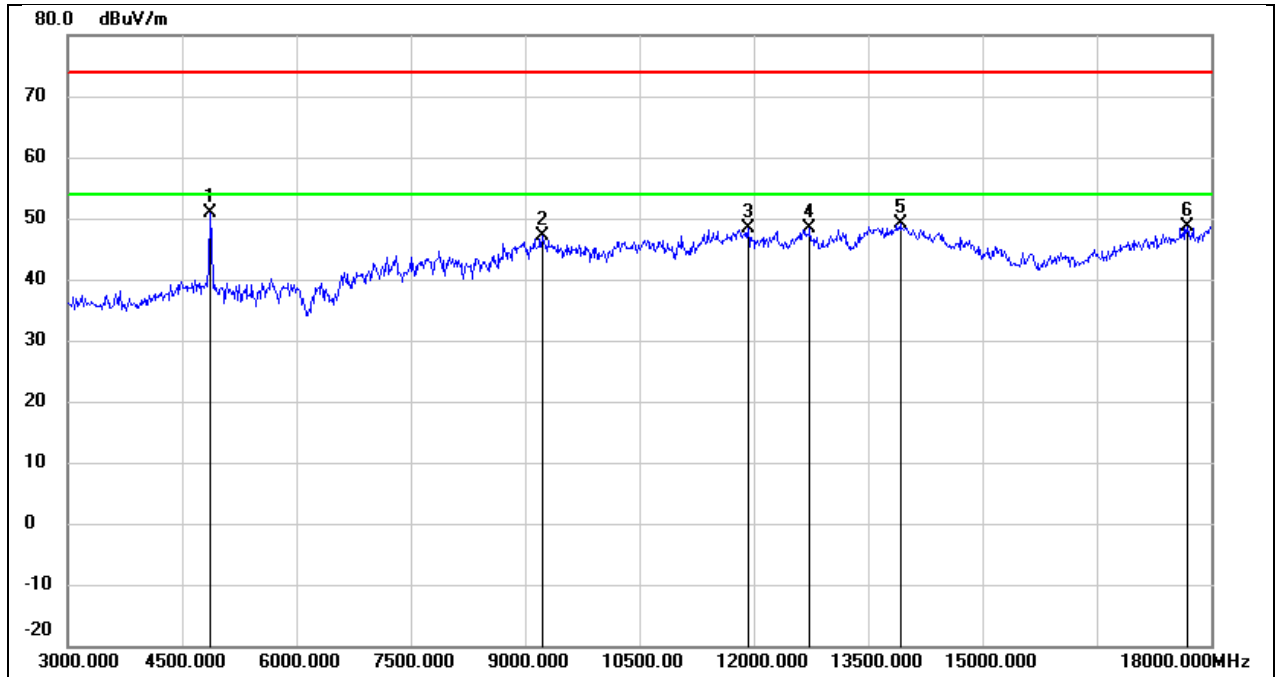

No.	Frequency (MHz)	Reading (dBuV)	Correct (dB/m)	Result (dBuV/m)	Limit (dBuV/m)	Margin (dB)	Remark
1	4860.000	50.94	-0.09	50.85	74.00	-23.15	peak
2	9225.000	36.52	10.58	47.10	74.00	-26.90	peak
3	11925.000	30.57	17.75	48.32	74.00	-25.68	peak
4	12735.000	30.26	18.12	48.38	74.00	-25.62	peak
5	13920.000	27.34	21.79	49.13	74.00	-24.87	peak
6	17685.000	24.76	23.82	48.58	74.00	-25.42	peak

Test Mode:	802.11g	Frequency(MHz):	2437
Polarity:	Vertical	Test Voltage:	AC 120V_60Hz

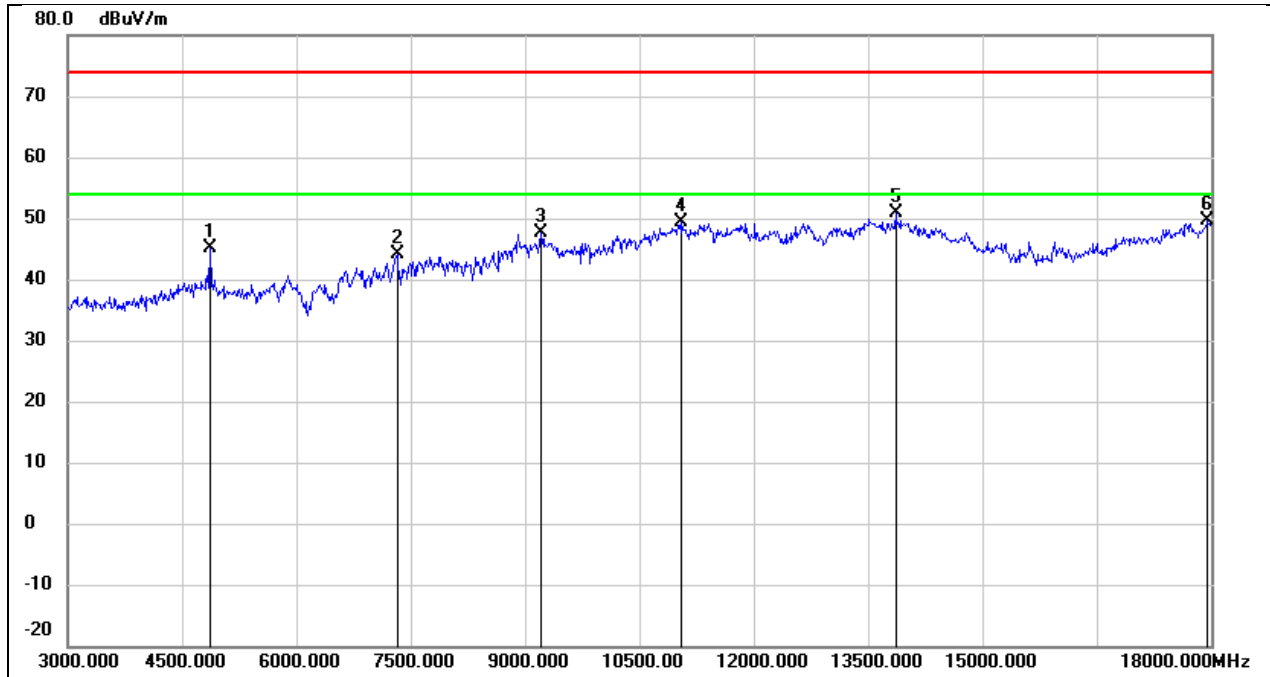

No.	Frequency (MHz)	Reading (dBuV)	Correct (dB/m)	Result (dBuV/m)	Limit (dBuV/m)	Margin (dB)	Remark
1	4860.000	45.12	-0.09	45.03	74.00	-28.97	peak
2	7320.000	37.65	6.46	44.11	74.00	-29.89	peak
3	9210.000	37.01	10.57	47.58	74.00	-26.42	peak
4	11055.000	34.31	14.96	49.27	74.00	-24.73	peak
5	13860.000	29.25	21.67	50.92	74.00	-23.08	peak
6	17955.000	24.11	25.42	49.53	74.00	-24.47	peak

Test Mode:	802.11g	Frequency(MHz):	2462
Polarity:	Horizontal	Test Voltage:	AC 120V_60Hz

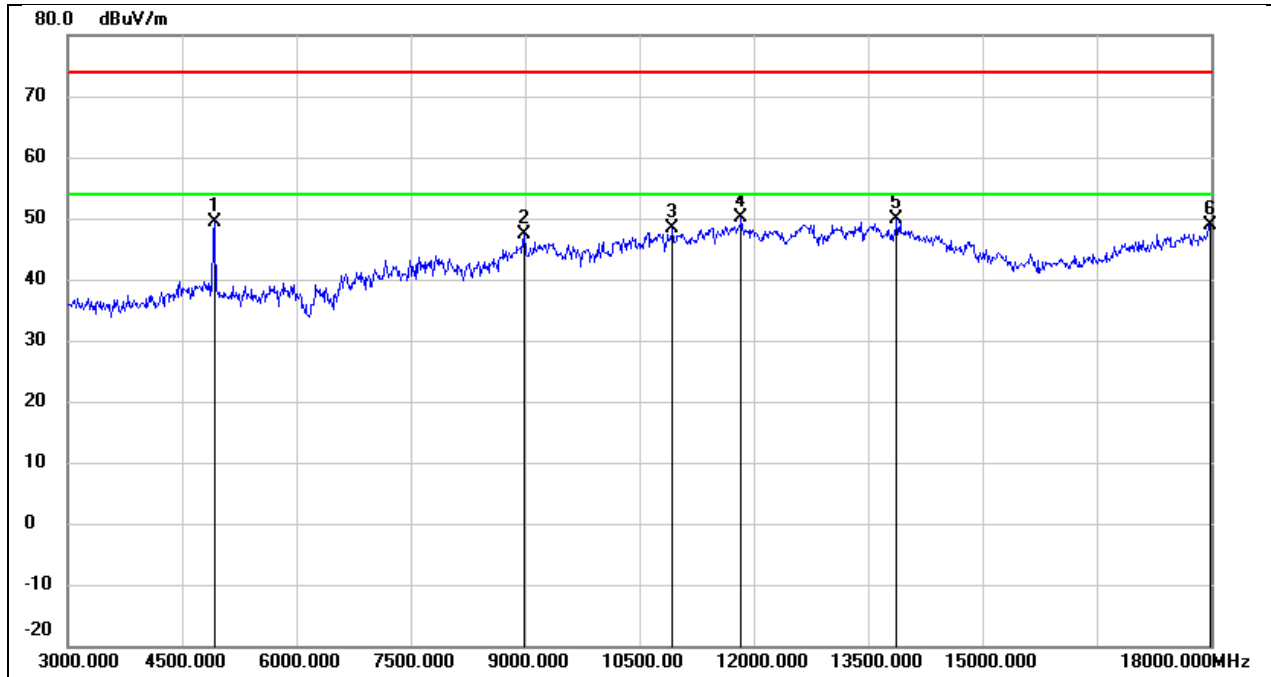

No.	Frequency (MHz)	Reading (dBuV)	Correct (dB/m)	Result (dBuV/m)	Limit (dBuV/m)	Margin (dB)	Remark
1	4920.000	49.13	0.14	49.27	74.00	-24.73	peak
2	8985.000	36.97	10.37	47.34	74.00	-26.66	peak
3	10935.000	33.94	14.54	48.48	74.00	-25.52	peak
4	11835.000	32.50	17.51	50.01	74.00	-23.99	peak
5	13875.000	28.22	21.70	49.92	74.00	-24.08	peak
6	17985.000	23.37	25.60	48.97	74.00	-25.03	peak

Test Mode:	802.11g	Frequency(MHz):	2462
Polarity:	Vertical	Test Voltage:	AC 120V_60Hz

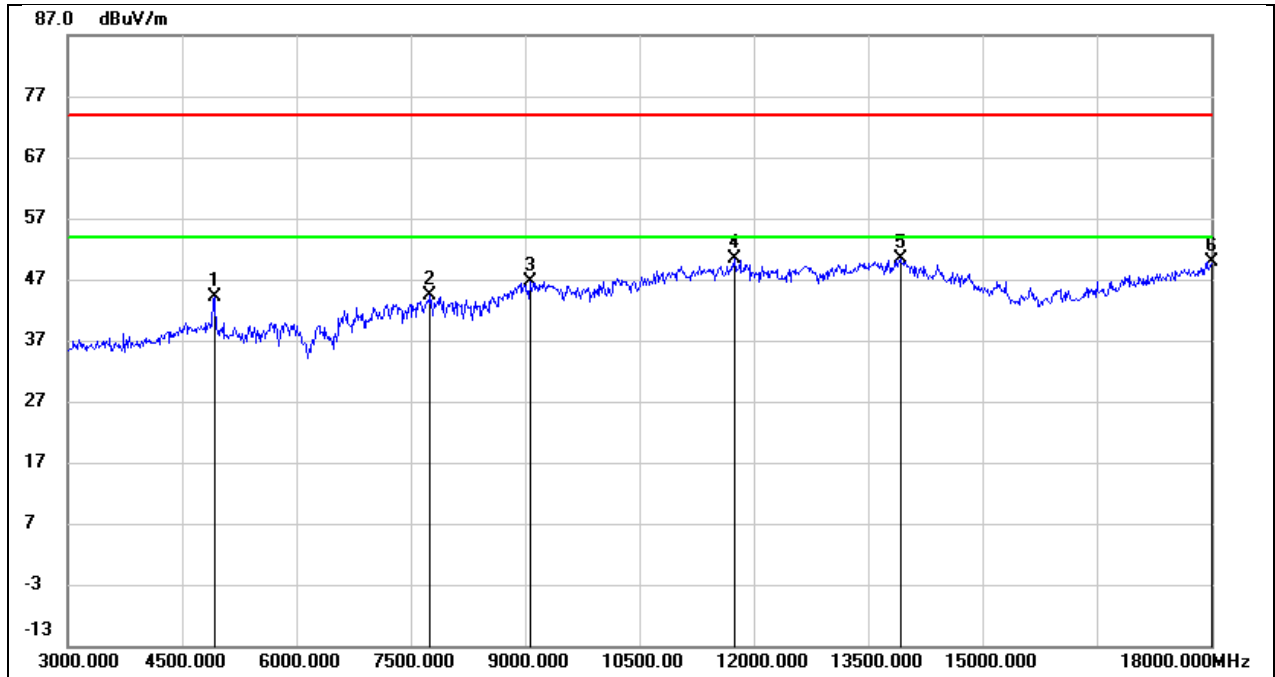

No.	Frequency (MHz)	Reading (dBuV)	Correct (dB/m)	Result (dBuV/m)	Limit (dBuV/m)	Margin (dB)	Remark
1	4920.000	43.96	0.14	44.10	74.00	-29.90	peak
2	7755.000	38.06	6.31	44.37	74.00	-29.63	peak
3	9060.000	36.21	10.51	46.72	74.00	-27.28	peak
4	11745.000	33.06	17.27	50.33	74.00	-23.67	peak
5	13920.000	28.53	21.79	50.32	74.00	-23.68	peak
6	18000.000	24.11	25.69	49.80	74.00	-24.20	peak

Test Mode:	802.11n HT20	Frequency(MHz):	2412
Polarity:	Horizontal	Test Voltage:	AC 120V_60Hz

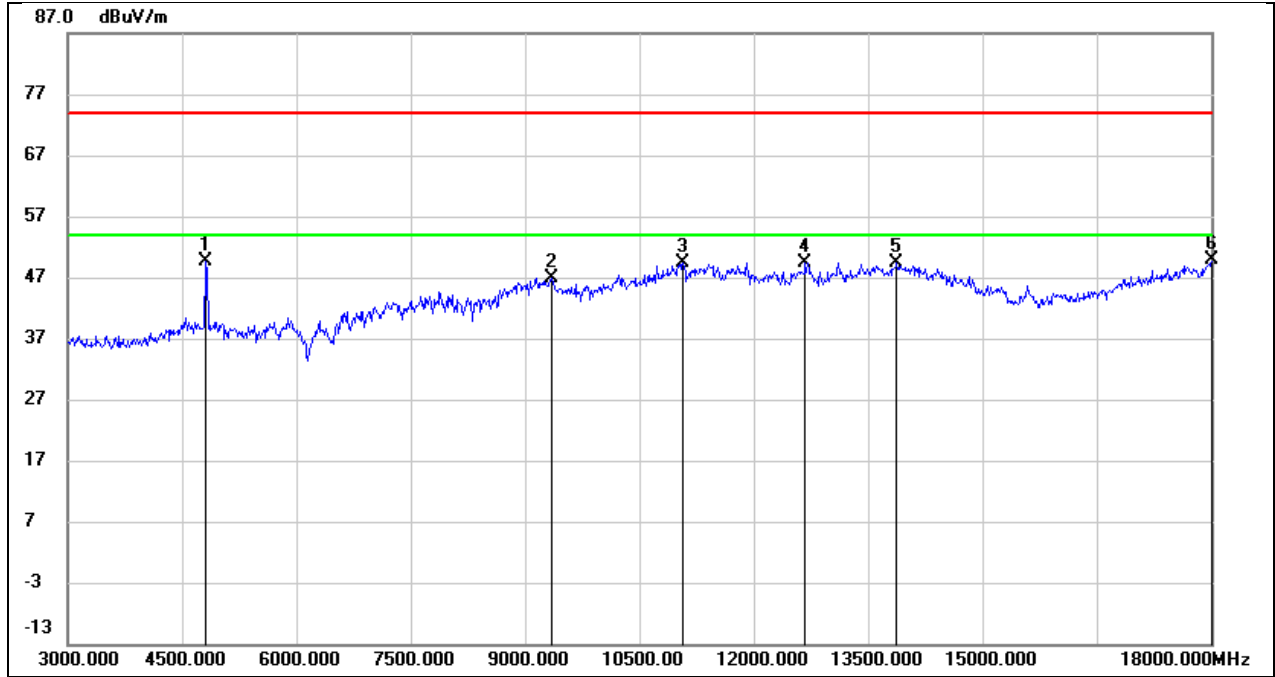

No.	Frequency (MHz)	Reading (dBuV)	Correct (dB/m)	Result (dBuV/m)	Limit (dBuV/m)	Margin (dB)	Remark
1	4815.000	49.80	-0.26	49.54	74.00	-24.46	peak
2	9345.000	36.35	10.63	46.98	74.00	-27.02	peak
3	11070.000	34.31	15.03	49.34	74.00	-24.66	peak
4	12675.000	31.42	17.99	49.41	74.00	-24.59	peak
5	13875.000	27.78	21.70	49.48	74.00	-24.52	peak
6	18000.000	24.20	25.69	49.89	74.00	-24.11	peak

Test Mode:	802.11n HT20	Frequency(MHz):	2412
Polarity:	Vertical	Test Voltage:	AC 120V_60Hz

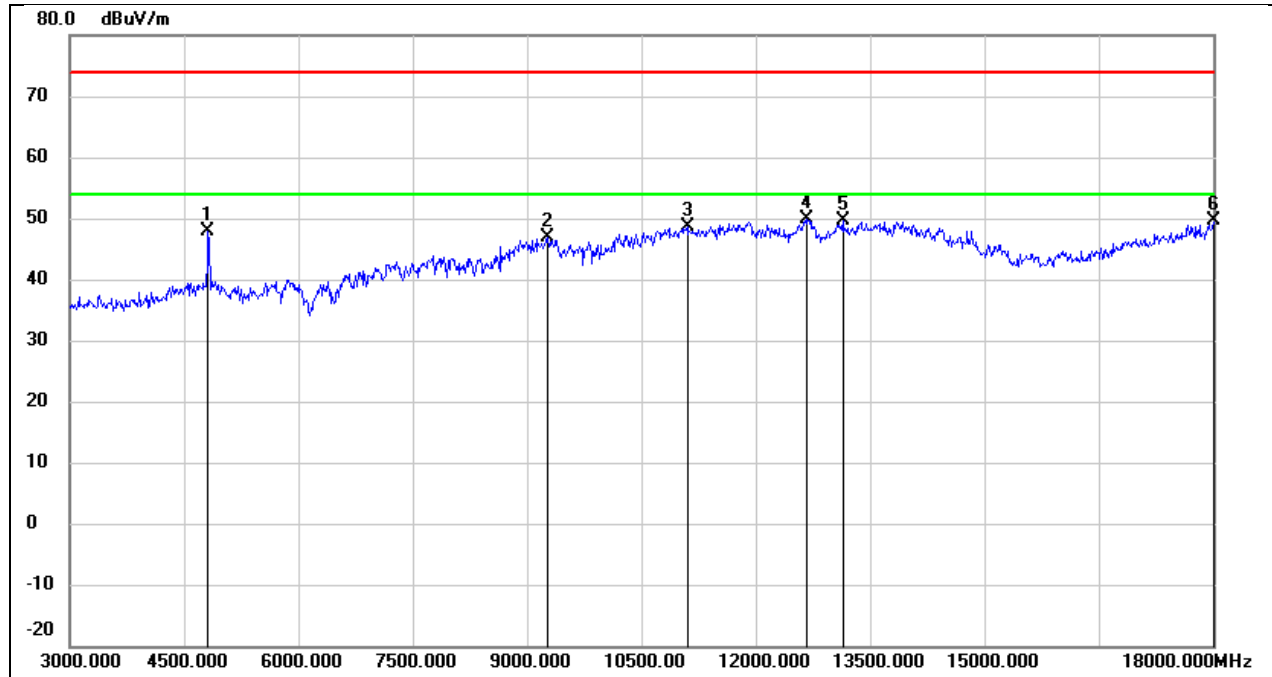

No.	Frequency (MHz)	Reading (dBuV)	Correct (dB/m)	Result (dBuV/m)	Limit (dBuV/m)	Margin (dB)	Remark
1	4815.000	48.03	-0.26	47.77	74.00	-26.23	peak
2	9270.000	36.35	10.59	46.94	74.00	-27.06	peak
3	11100.000	33.51	15.14	48.65	74.00	-25.35	peak
4	12675.000	31.80	17.99	49.79	74.00	-24.21	peak
5	13140.000	30.32	19.33	49.65	74.00	-24.35	peak
6	18000.000	23.86	25.69	49.55	74.00	-24.45	peak

Test Mode:	802.11n HT20	Frequency(MHz):	2437
Polarity:	Horizontal	Test Voltage:	AC 120V_60Hz

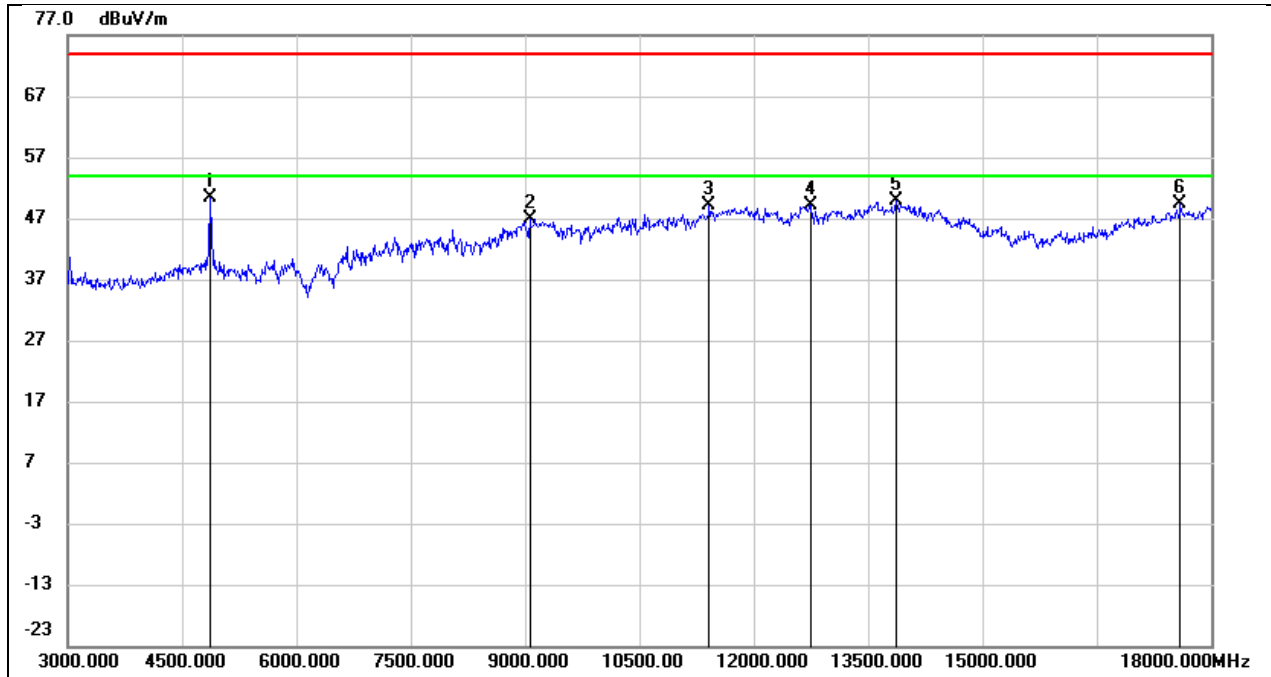

No.	Frequency (MHz)	Reading (dBuV)	Correct (dB/m)	Result (dBuV/m)	Limit (dBuV/m)	Margin (dB)	Remark
1	4860.000	50.57	-0.09	50.48	74.00	-23.52	peak
2	9060.000	36.35	10.51	46.86	74.00	-27.14	peak
3	11415.000	32.89	16.29	49.18	74.00	-24.82	peak
4	12750.000	30.90	18.16	49.06	74.00	-24.94	peak
5	13860.000	28.12	21.67	49.79	74.00	-24.21	peak
6	17595.000	26.05	23.29	49.34	74.00	-24.66	peak



Test Mode:	802.11n HT20	Frequency(MHz):	2437
Polarity:	Vertical	Test Voltage:	AC 120V_60Hz

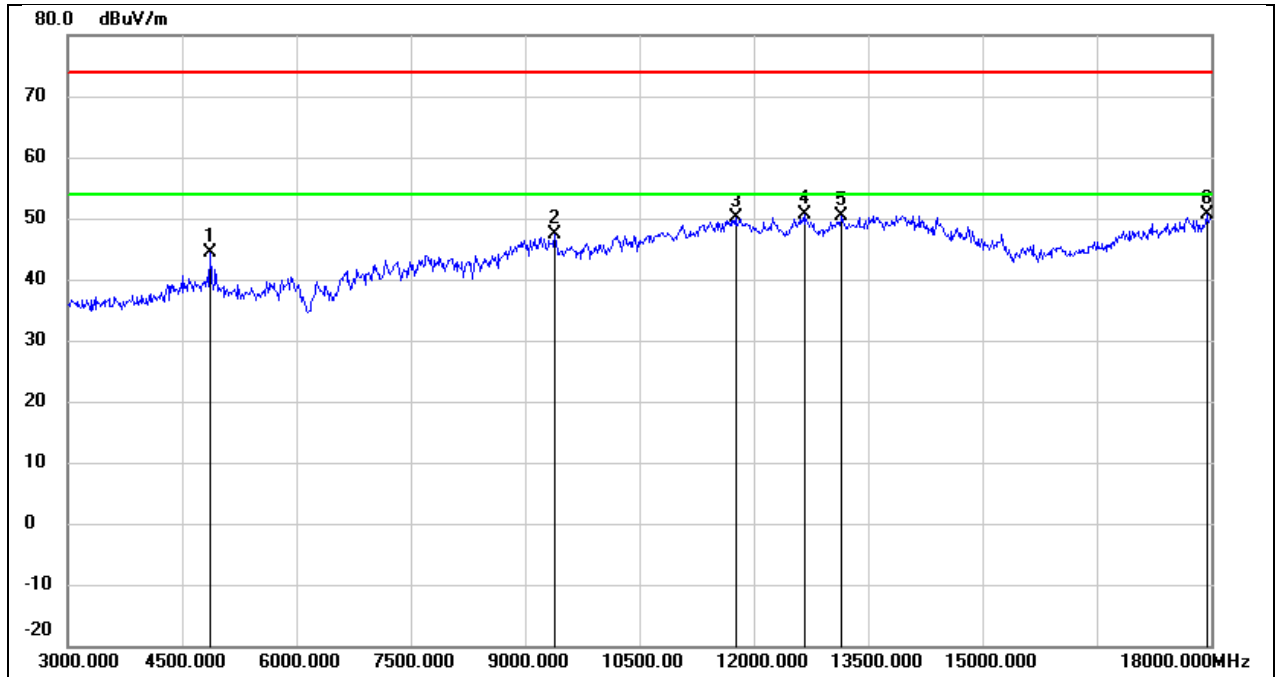

No.	Frequency (MHz)	Reading (dBuV)	Correct (dB/m)	Result (dBuV/m)	Limit (dBuV/m)	Margin (dB)	Remark
1	4860.000	44.58	-0.09	44.49	74.00	-29.51	peak
2	9390.000	36.67	10.64	47.31	74.00	-26.69	peak
3	11760.000	32.90	17.31	50.21	74.00	-23.79	peak
4	12675.000	32.74	17.99	50.73	74.00	-23.27	peak
5	13155.000	31.09	19.40	50.49	74.00	-23.51	peak
6	17940.000	25.28	25.34	50.62	74.00	-23.38	peak

Test Mode:	802.11n HT20	Frequency(MHz):	2462
Polarity:	Horizontal	Test Voltage:	AC 120V_60Hz

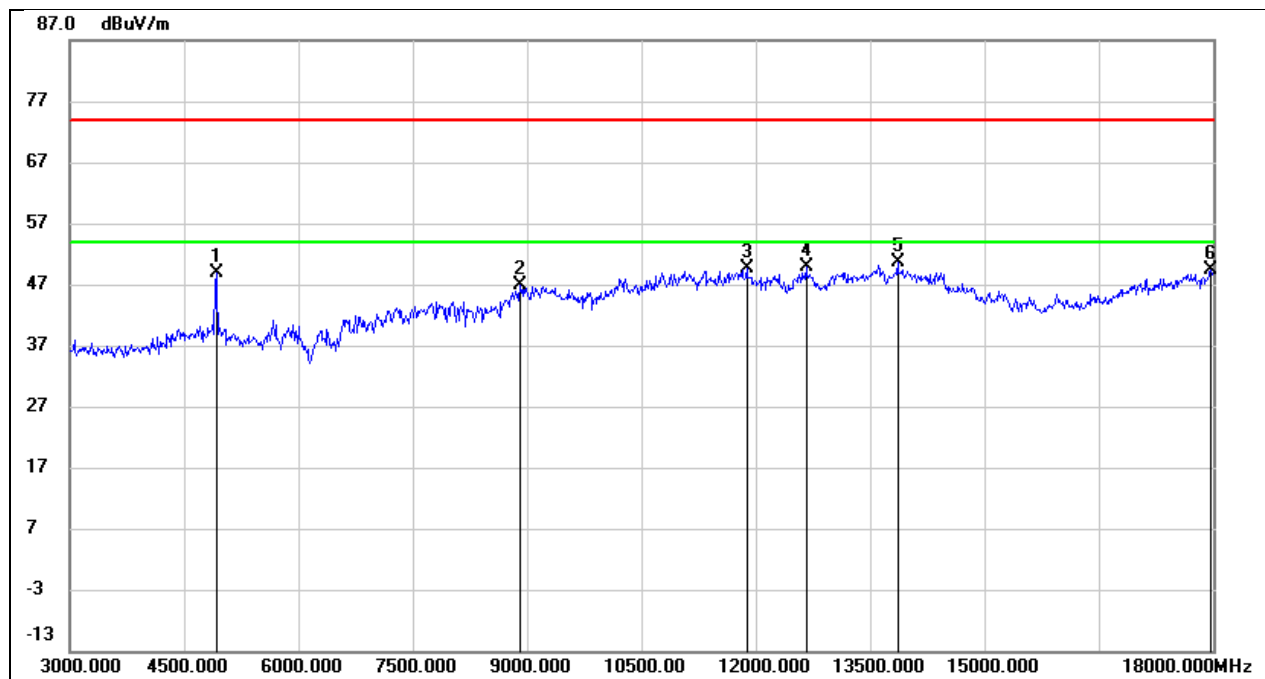

No.	Frequency (MHz)	Reading (dBuV)	Correct (dB/m)	Result (dBuV/m)	Limit (dBuV/m)	Margin (dB)	Remark
1	4920.000	48.67	0.14	48.81	74.00	-25.19	peak
2	8910.000	36.95	9.82	46.77	74.00	-27.23	peak
3	11880.000	31.99	17.63	49.62	74.00	-24.38	peak
4	12660.000	31.83	17.95	49.78	74.00	-24.22	peak
5	13860.000	29.06	21.67	50.73	74.00	-23.27	peak
6	17970.000	23.82	25.51	49.33	74.00	-24.67	peak

Test Mode:	802.11n HT20	Frequency(MHz):	2462
Polarity:	Vertical	Test Voltage:	AC 120V_60Hz

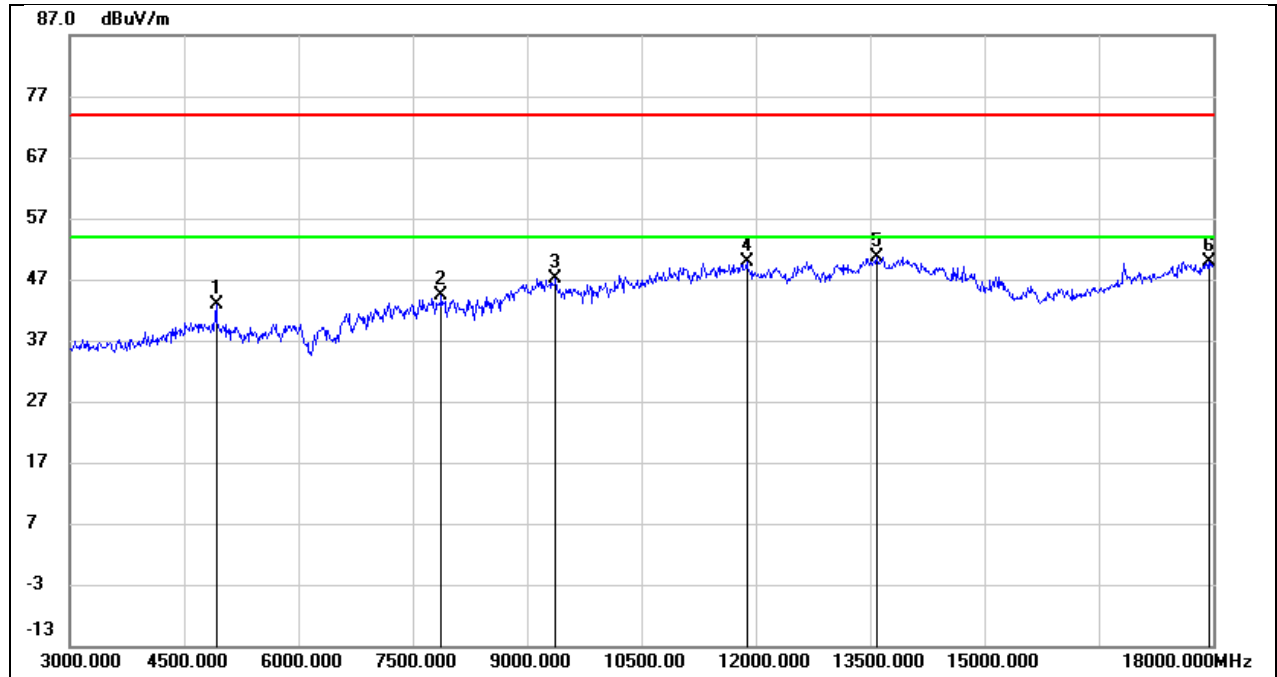

No.	Frequency (MHz)	Reading (dBuV)	Correct (dB/m)	Result (dBuV/m)	Limit (dBuV/m)	Margin (dB)	Remark
1	4920.000	42.71	0.14	42.85	74.00	-31.15	peak
2	7875.000	38.10	6.31	44.41	74.00	-29.59	peak
3	9375.000	36.61	10.64	47.25	74.00	-26.75	peak
4	11880.000	32.20	17.63	49.83	74.00	-24.17	peak
5	13590.000	29.66	21.09	50.75	74.00	-23.25	peak
6	17940.000	24.52	25.34	49.86	74.00	-24.14	peak

Test Mode:	802.11n HT40	Frequency(MHz):	2422
Polarity:	Horizontal	Test Voltage:	AC 120V_60Hz

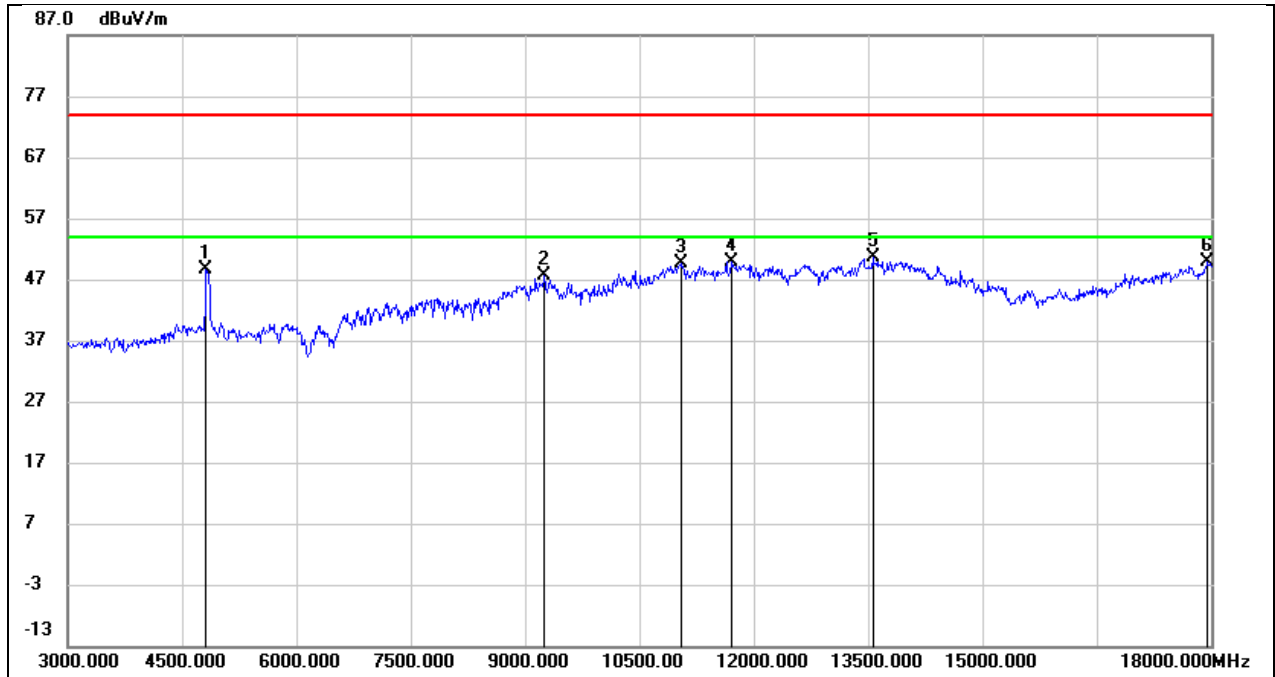

No.	Frequency (MHz)	Reading (dBuV)	Correct (dB/m)	Result (dBuV/m)	Limit (dBuV/m)	Margin (dB)	Remark
1	4815.000	48.81	-0.26	48.55	74.00	-25.45	peak
2	9255.000	36.98	10.59	47.57	74.00	-26.43	peak
3	11055.000	34.78	14.96	49.74	74.00	-24.26	peak
4	11700.000	32.66	17.14	49.80	74.00	-24.20	peak
5	13560.000	29.65	21.04	50.69	74.00	-23.31	peak
6	17955.000	24.40	25.42	49.82	74.00	-24.18	peak

Test Mode:	802.11n HT40	Frequency(MHz):	2422
Polarity:	Vertical	Test Voltage:	AC 120V_60Hz

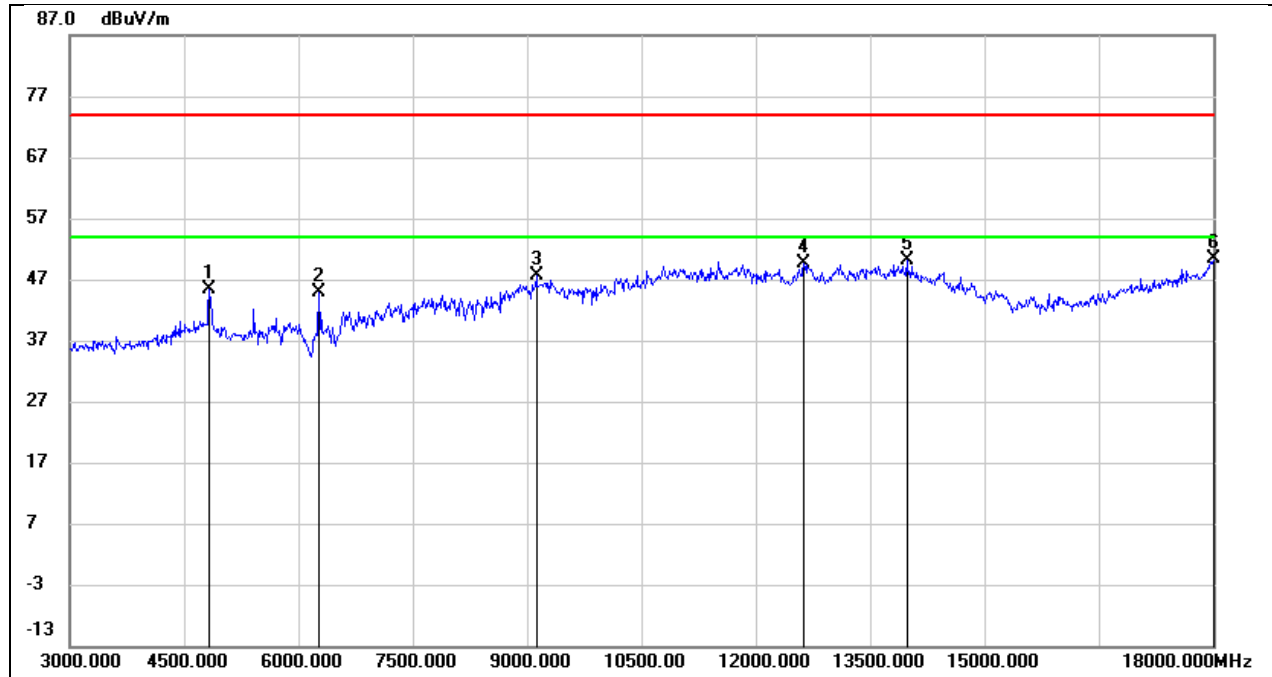

No.	Frequency (MHz)	Reading (dBuV)	Correct (dB/m)	Result (dBuV/m)	Limit (dBuV/m)	Margin (dB)	Remark
1	4830.000	45.49	-0.20	45.29	74.00	-28.71	peak
2	6270.000	41.54	3.32	44.86	74.00	-29.14	peak
3	9120.000	37.12	10.53	47.65	74.00	-26.35	peak
4	12630.000	31.64	17.89	49.53	74.00	-24.47	peak
5	13980.000	28.09	21.92	50.01	74.00	-23.99	peak
6	18000.000	24.75	25.69	50.44	74.00	-23.56	peak

Test Mode:	802.11n HT40	Frequency(MHz):	2437
Polarity:	Horizontal	Test Voltage:	AC 120V_60Hz

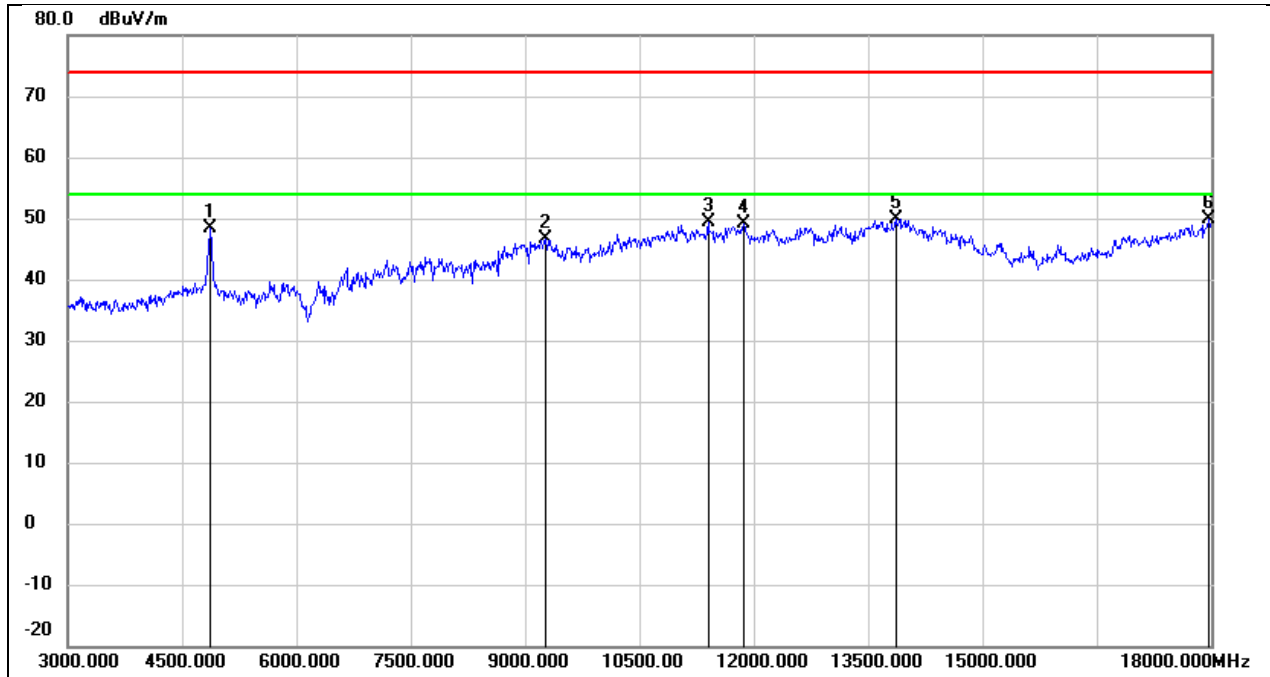

No.	Frequency (MHz)	Reading (dBuV)	Correct (dB/m)	Result (dBuV/m)	Limit (dBuV/m)	Margin (dB)	Remark
1	4875.000	48.50	-0.03	48.47	74.00	-25.53	peak
2	9270.000	35.97	10.59	46.56	74.00	-27.44	peak
3	11400.000	33.03	16.23	49.26	74.00	-24.74	peak
4	11865.000	31.50	17.59	49.09	74.00	-24.91	peak
5	13860.000	28.28	21.67	49.95	74.00	-24.05	peak
6	17970.000	24.41	25.51	49.92	74.00	-24.08	peak

Test Mode:	802.11n HT40	Frequency(MHz):	2437
Polarity:	Vertical	Test Voltage:	AC 120V_60Hz

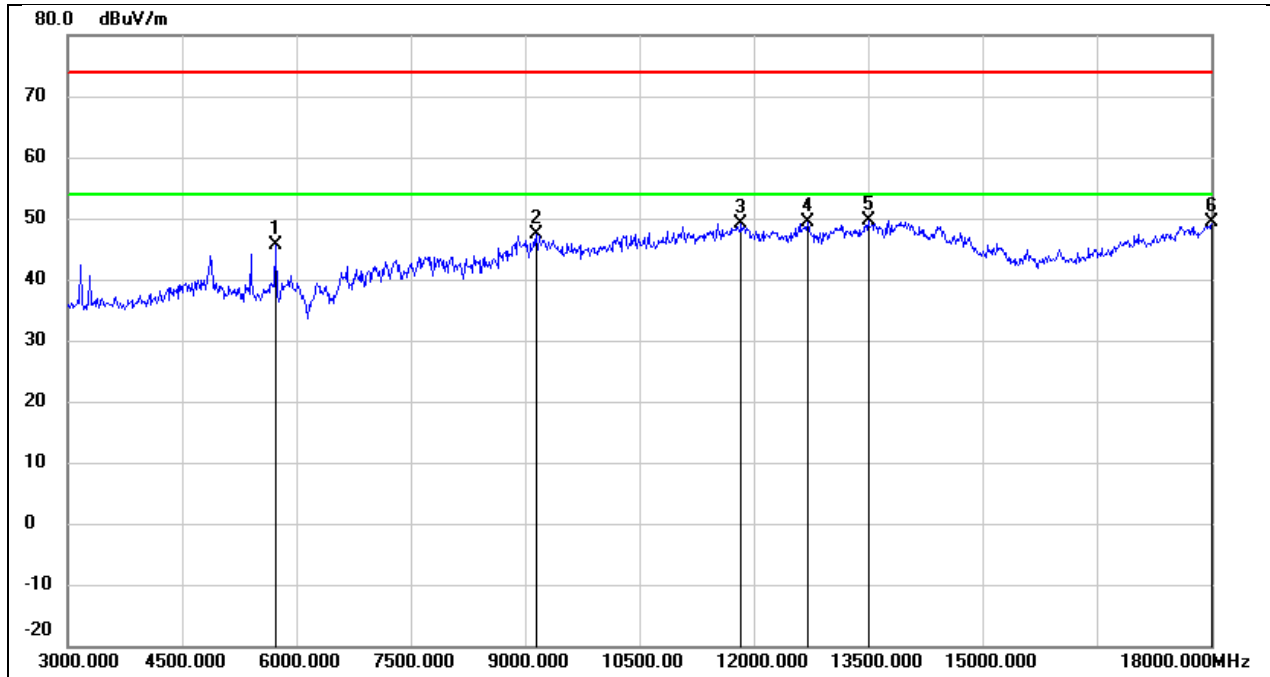

No.	Frequency (MHz)	Reading (dBuV)	Correct (dB/m)	Result (dBuV/m)	Limit (dBuV/m)	Margin (dB)	Remark
1	5730.000	44.16	1.49	45.65	74.00	-28.35	peak
2	9150.000	36.80	10.54	47.34	74.00	-26.66	peak
3	11835.000	31.54	17.51	49.05	74.00	-24.95	peak
4	12705.000	31.20	18.06	49.26	74.00	-24.74	peak
5	13500.000	28.73	20.90	49.63	74.00	-24.37	peak
6	18000.000	23.65	25.69	49.34	74.00	-24.66	peak

Test Mode:	802.11n HT40	Frequency(MHz):	2452
Polarity:	Horizontal	Test Voltage:	AC 120V_60Hz

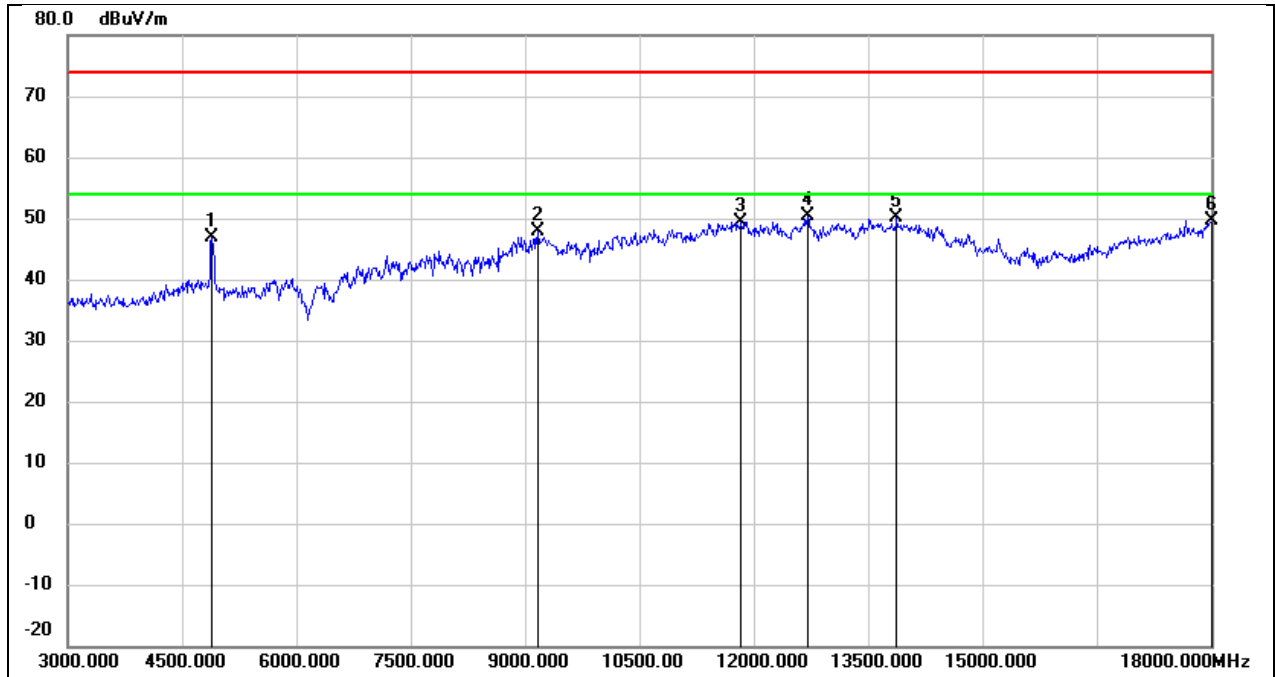

No.	Frequency (MHz)	Reading (dBuV)	Correct (dB/m)	Result (dBuV/m)	Limit (dBuV/m)	Margin (dB)	Remark
1	4890.000	46.80	0.03	46.83	74.00	-27.17	peak
2	9165.000	37.21	10.55	47.76	74.00	-26.24	peak
3	11835.000	31.99	17.51	49.50	74.00	-24.50	peak
4	12705.000	32.38	18.06	50.44	74.00	-23.56	peak
5	13875.000	28.36	21.70	50.06	74.00	-23.94	peak
6	18000.000	23.90	25.69	49.59	74.00	-24.41	peak



Test Mode:	802.11n HT40	Frequency(MHz):	2452
Polarity:	Vertical	Test Voltage:	AC 120V_60Hz

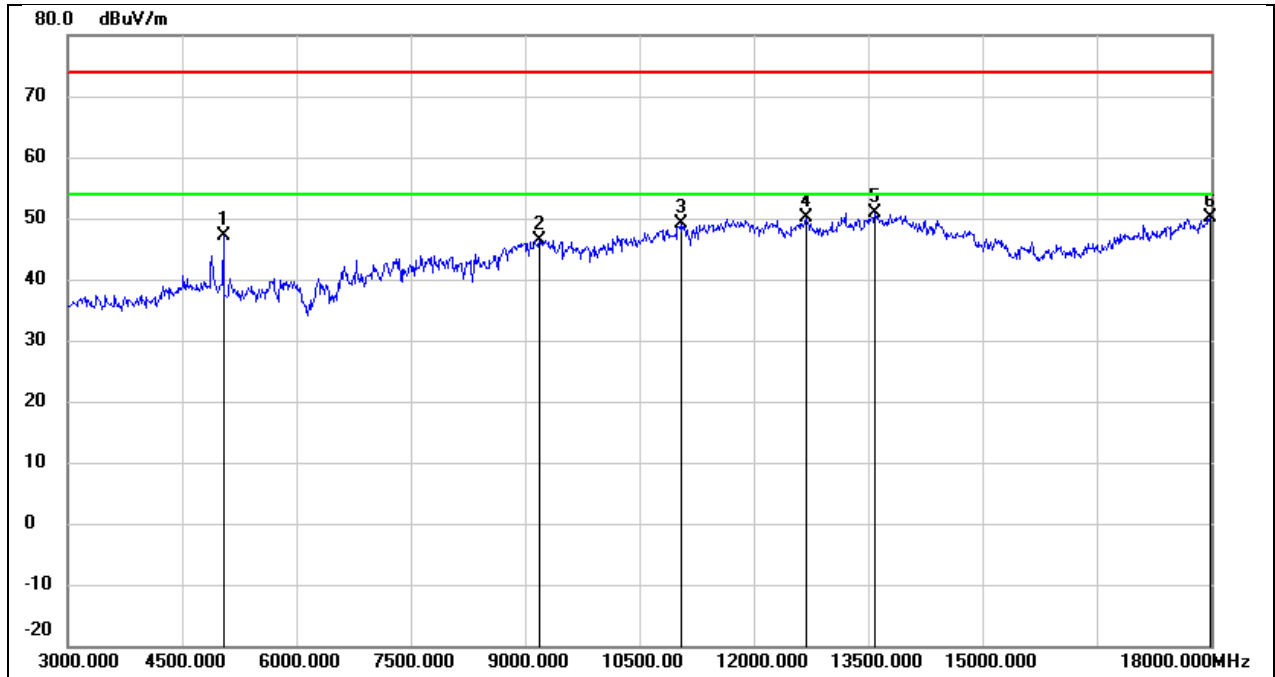

No.	Frequency (MHz)	Reading (dBuV)	Correct (dB/m)	Result (dBuV/m)	Limit (dBuV/m)	Margin (dB)	Remark
1	5040.000	46.63	0.48	47.11	74.00	-26.89	peak
2	9180.000	35.93	10.56	46.49	74.00	-27.51	peak
3	11055.000	34.09	14.96	49.05	74.00	-24.95	peak
4	12690.000	32.02	18.02	50.04	74.00	-23.96	peak
5	13590.000	29.81	21.09	50.90	74.00	-23.10	peak
6	17985.000	24.45	25.60	50.05	74.00	-23.95	peak

### 8.4. SPURIOUS EMISSIONS(9 KHZ~30 MHZ)

Test Mode:	802.11b	Frequency(MHz):	2412
Polarity:	Horizontal	Test Voltage:	AC 120 V, 50HZ

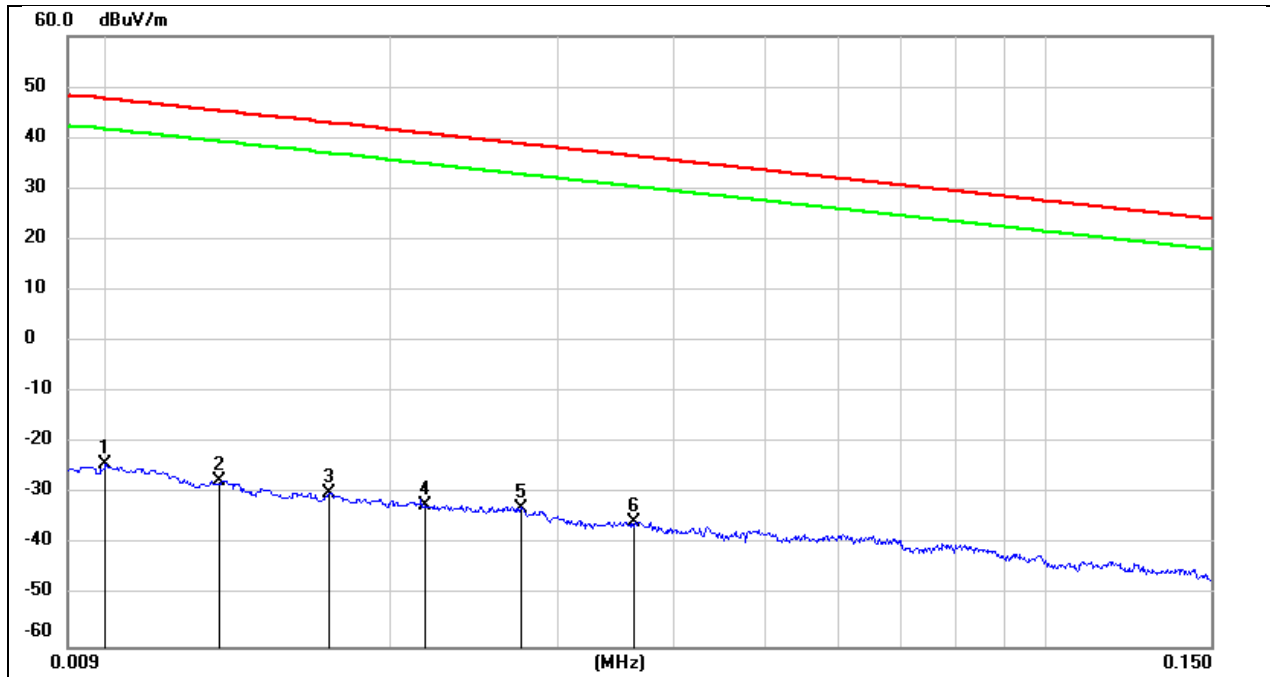

No.	Frequency (MHz)	Reading (dBuV)	Correct (dB/m)	FCC Result (dBuV/m)	FCC Limit (dBuV/m)	ISED Result (dBuA/m)	ISED Limit (dBuA/m)	Margin (dB)	Remark
1	0.01	77.22	-101.4	-24.18	47.6	-75.68	-3.9	-71.78	peak
2	0.0131	73.95	-101.38	-27.43	45.25	-78.93	-6.25	-72.68	peak
3	0.0171	71.38	-101.36	-29.98	42.94	-81.48	-8.56	-72.92	peak
4	0.0217	69.19	-101.35	-32.16	40.87	-83.66	-10.63	-73.03	peak
5	0.0275	68.6	-101.38	-32.78	38.82	-84.28	-12.68	-71.6	peak
6	0.0362	65.88	-101.42	-35.54	36.43	-87.04	-15.07	-71.97	peak

Test Mode:	802.11b	Frequency(MHz):	2412
Polarity:	Horizontal	Test Voltage:	AC 120 V, 50HZ

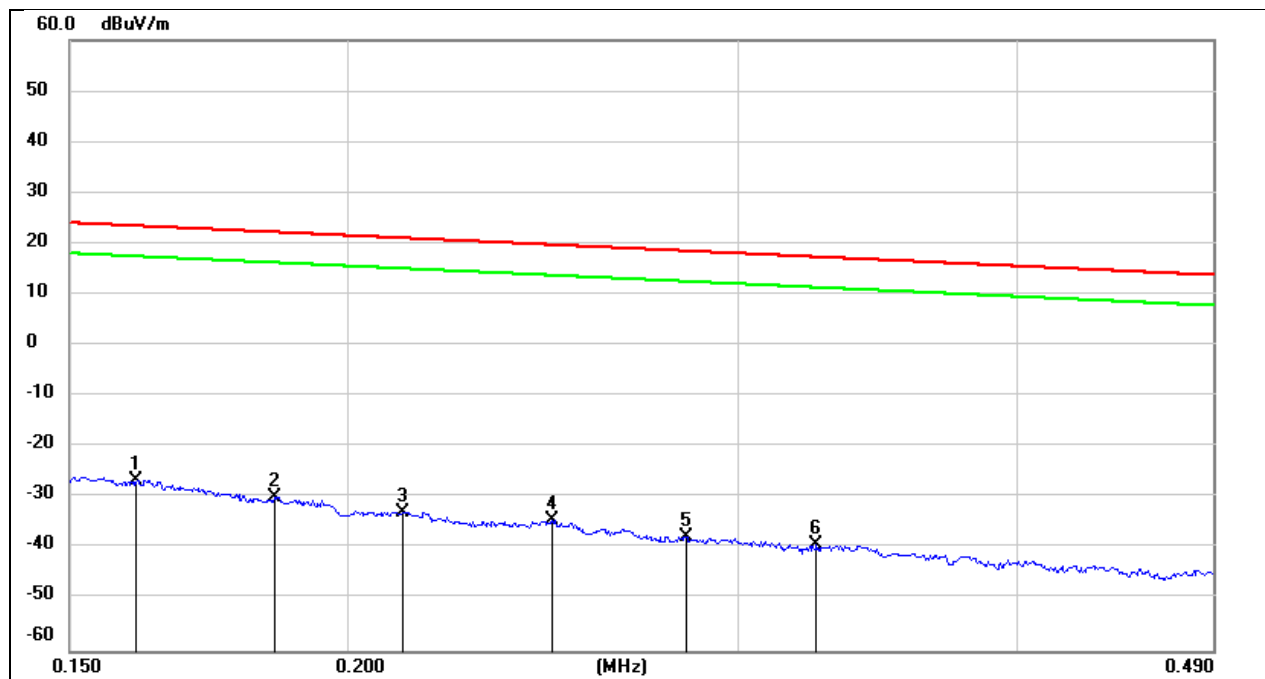

No.	Frequency (MHz)	Reading (dBuV)	Correct (dB/m)	FCC Result (dBuV/m)	FCC Limit (dBuV/m)	ISED Result (dBuA/m)	ISED Limit (dBuA/m)	Margin (dB)	Remark
1	0.1607	75.04	-101.65	-26.61	23.48	-78.11	-28.02	-50.09	peak
2	0.1853	71.9	-101.7	-29.8	22.25	-81.3	-29.25	-52.05	peak
3	0.2116	69.03	-101.73	-32.7	21.09	-84.2	-30.41	-53.79	peak
4	0.2472	67.45	-101.8	-34.35	19.74	-85.85	-31.76	-54.09	peak
5	0.2837	64.22	-101.83	-37.61	18.54	-89.11	-32.96	-56.15	peak
6	0.3251	62.71	-101.88	-39.17	17.36	-90.67	-34.14	-56.53	peak

Test Mode:	802.11b	Frequency(MHz):	2412
Polarity:	Horizontal	Test Voltage:	AC 120 V, 50HZ

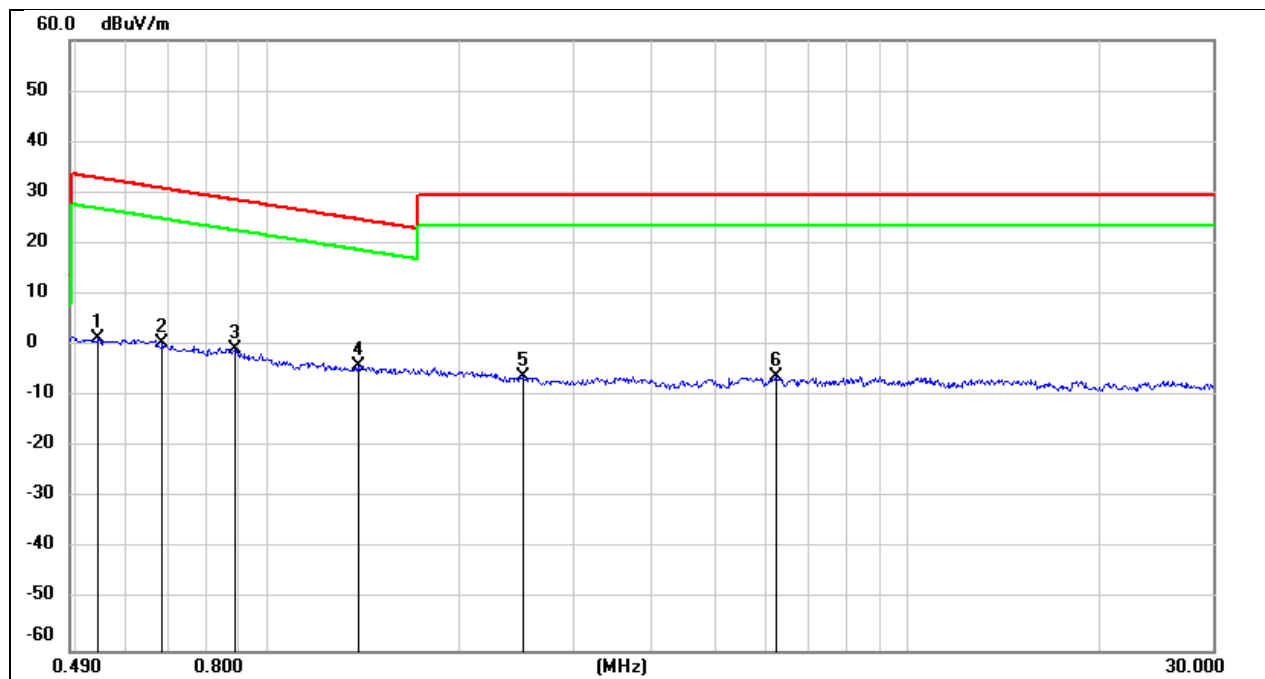

No.	Frequency (MHz)	Reading (dBuV)	Correct (dB/m)	FCC Result (dBuV/m)	FCC Limit (dBuV/m)	ISED Result (dBuA/m)	ISED Limit (dBuA/m)	Margin (dB)	Remark
1	0.5431	63.4	-62.08	1.32	32.91	-50.18	-18.59	-31.59	peak
2	0.6834	62.71	-62.11	0.6	30.91	-50.9	-20.59	-30.31	peak
3	0.8898	61.45	-62.2	-0.75	28.62	-52.25	-22.88	-29.37	peak
4	1.381	57.97	-62.1	-4.13	24.8	-55.63	-26.7	-28.93	peak
5	2.5095	55.55	-61.7	-6.15	29.54	-57.65	-21.96	-35.69	peak
6	6.2445	55.13	-61.32	-6.19	29.54	-57.69	-21.96	-35.73	peak

### 8.5. SPURIOUS EMISSIONS(18 GHZ~26 GHZ)

Test Mode:	802.11b	Frequency(MHz):	2412
Polarity:	Horizontal	Test Voltage:	AC 120 V, 50HZ

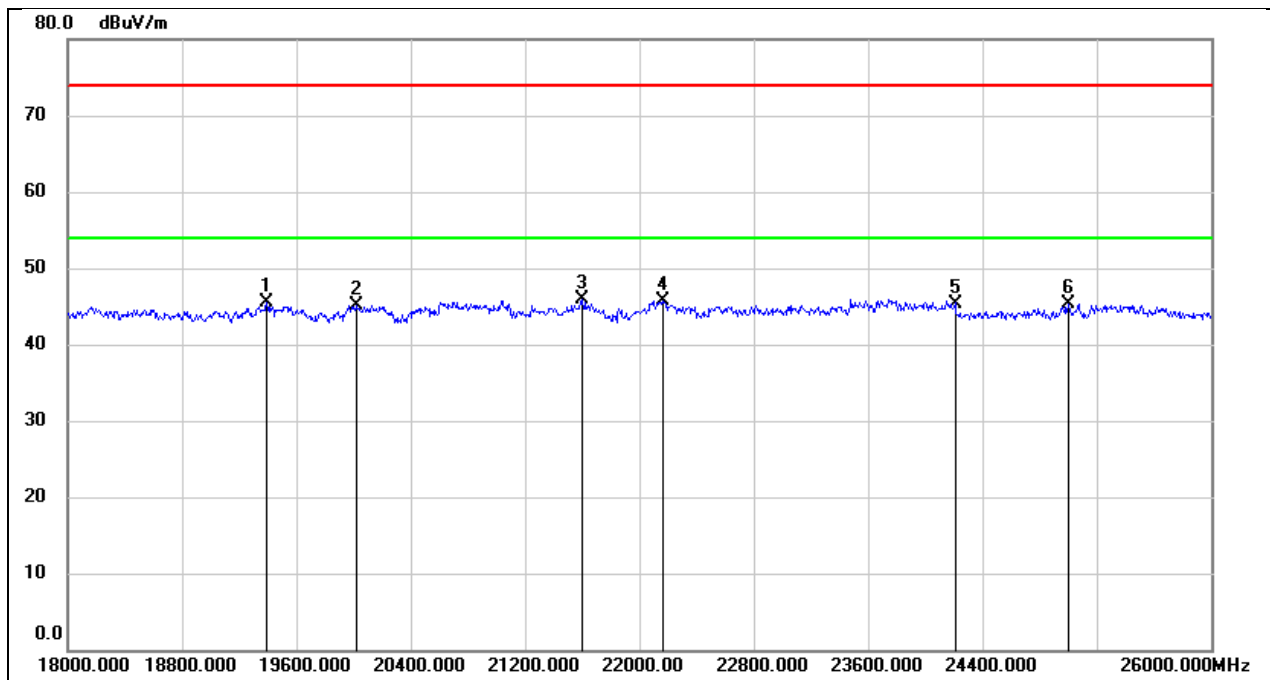

No.	Frequency (MHz)	Reading (dBuV)	Correct (dB/m)	Result (dBuV/m)	Limit (dBuV/m)	Margin (dB)	Remark
1	19392.000	51.12	-5.57	45.55	74.00	-28.45	peak
2	20016.000	50.56	-5.47	45.09	74.00	-28.91	peak
3	21600.000	50.52	-4.54	45.98	74.00	-28.02	peak
4	22160.000	50.08	-4.31	45.77	74.00	-28.23	peak
5	24208.000	48.21	-2.81	45.40	74.00	-28.60	peak
6	25000.000	47.36	-2.10	45.26	74.00	-28.74	peak

Test Mode:	802.11b	Frequency(MHz):	2412
Polarity:	Vertical	Test Voltage:	AC 120 V, 50HZ

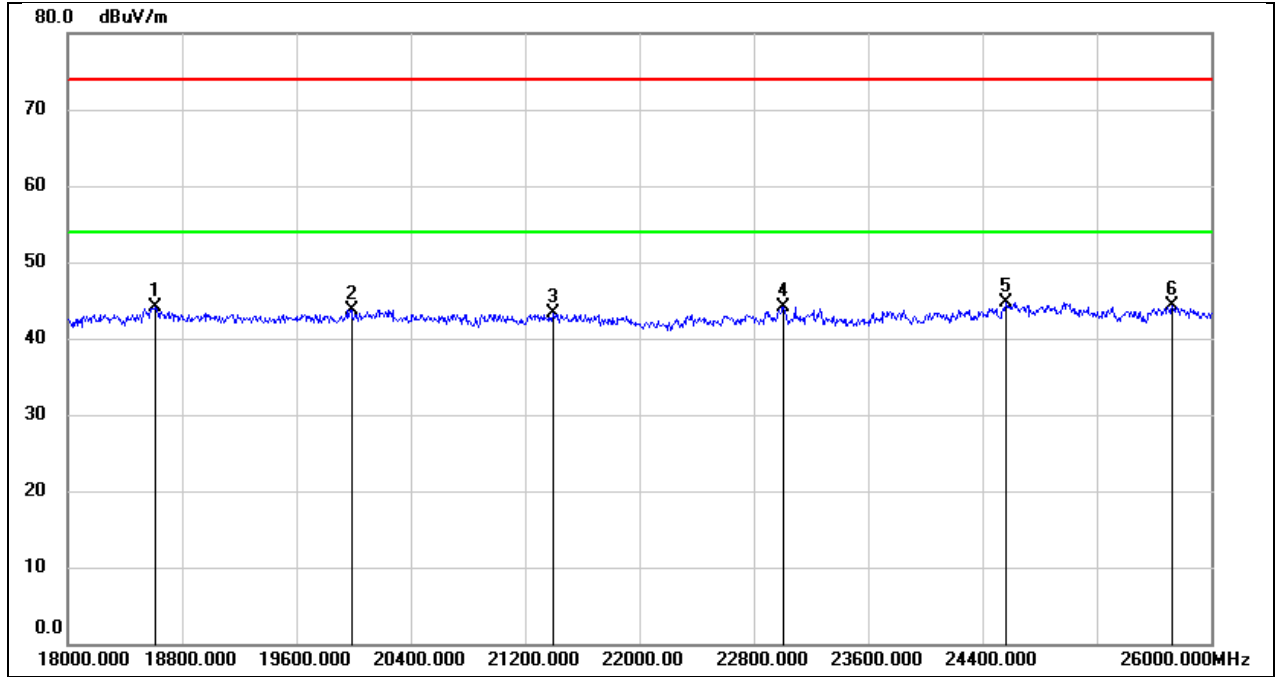

No.	Frequency (MHz)	Reading (dBuV)	Correct (dB/m)	Result (dBuV/m)	Limit (dBuV/m)	Margin (dB)	Remark
1	18616.000	49.39	-5.34	44.05	74.00	-29.95	peak
2	19984.000	49.21	-5.44	43.77	74.00	-30.23	peak
3	21400.000	48.04	-4.72	43.32	74.00	-30.68	peak
4	23008.000	47.60	-3.44	44.16	74.00	-29.84	peak
5	24568.000	47.10	-2.33	44.77	74.00	-29.23	peak
6	25728.000	45.11	-0.72	44.39	74.00	-29.61	peak

## 8.6. SPURIOUS EMISSIONS(30 MHZ~1 GHZ)

Test Mode:	802.11b	Frequency(MHz):	2412
Polarity:	Horizontal	Test Voltage:	AC120V_60Hz

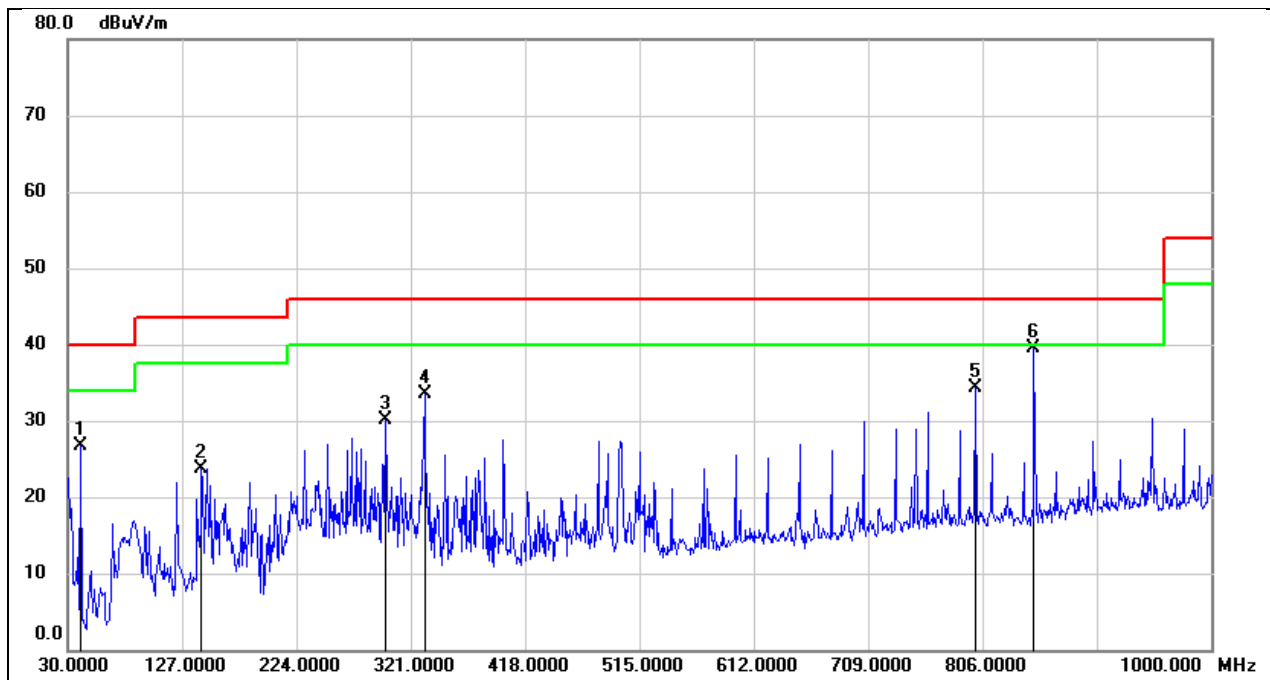

No.	Frequency (MHz)	Reading (dBuV)	Correct (dB/m)	Result (dBuV/m)	Limit (dBuV/m)	Margin (dB)	Remark
1	40.6699	46.69	-19.94	26.75	40.00	-13.25	QP
2	143.4900	42.44	-18.69	23.75	43.50	-19.75	QP
3	299.6600	45.44	-15.31	30.13	46.00	-15.87	QP
4	332.6400	47.20	-13.74	33.46	46.00	-12.54	QP
5	800.1800	40.84	-6.63	34.21	46.00	-11.79	QP
6	849.6500	45.71	-6.26	39.45	46.00	-6.55	QP

Test Mode:	802.11b	Frequency(MHz):	2412
Polarity:	Vertical	Test Voltage:	AC120V_60Hz

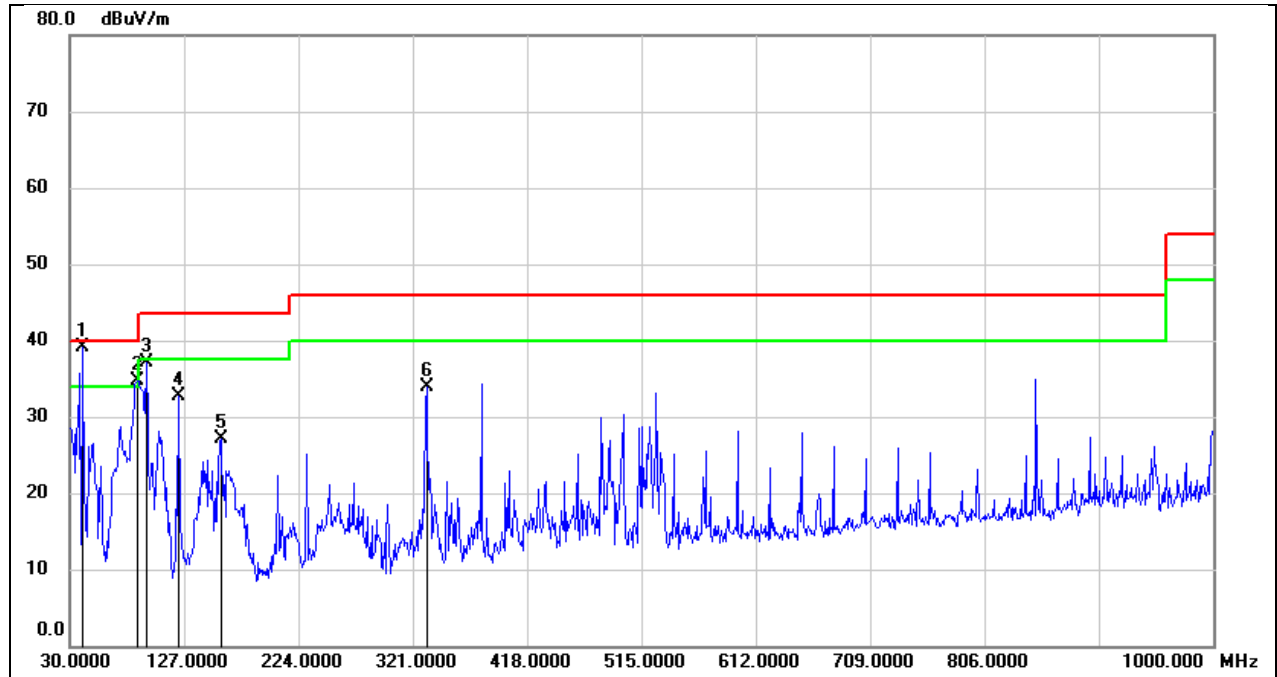

No.	Frequency (MHz)	Reading (dBuV)	Correct (dB/m)	Result (dBuV/m)	Limit (dBuV/m)	Margin (dB)	Remark
1	40.6699	59.09	-19.94	39.15	40.00	-0.85	QP
2	87.2300	56.65	-22.00	34.65	40.00	-5.35	QP
3	94.9900	58.82	-21.72	37.10	43.50	-6.40	QP
4	122.1500	52.52	-19.74	32.78	43.50	-10.72	QP
5	158.0399	44.89	-17.71	27.18	43.50	-16.32	QP
6	332.6400	47.61	-13.74	33.87	46.00	-12.13	QP



## 9. ANTENNA REQUIREMENT

### REQUIREMENT

Please refer to FCC part 15.203

An intentional radiator shall be designed to ensure that no antenna other than that furnished by the responsible party shall be used with the device. The use of a permanently attached antenna or of an antenna that uses a unique coupling to the intentional radiator shall be considered sufficient to comply with the provisions of this section. The manufacturer may design the unit so that a broken antenna can be replaced by the user, but the use of a standard antenna jack or electrical connector is prohibited.

Please refer to FCC part 15.247(b)(4)

The conducted output power limit specified in paragraph (b) of this section is based on the use of antennas with directional gains that do not exceed 6 dBi. Except as shown in paragraph (c) of this section, if transmitting antennas of directional gain greater than 6 dBi are used, the conducted output power from the intentional radiator shall be reduced below the stated values in paragraphs (b)(1), (b)(2), and (b)(3) of this section, as appropriate, by the amount in dB that the directional gain of the antenna exceeds 6 dBi.

### DESCRIPTION

Pass

## 10. AC POWER LINE CONDUCTED EMISSION

### LIMITS

Please refer to CFR 47 FCC §15.207 (a) and ISED RSS-Gen Clause 8.8

FREQUENCY (MHz)	Quasi-peak	Average
0.15 -0.5	66 - 56 *	56 - 46 *
0.50 -5.0	56.00	46.00
5.0 -30.0	60.00	50.00

### TEST PROCEDURE

The EUT is put on a table of non-conducting material that is 80 cm high. The vertical conducting wall of shielding is located 40 cm to the rear of the EUT. The power line of the EUT is connected to the AC mains through a Artificial Mains Network (A.M.N.). A EMI Measurement Receiver (R&S Test Receiver ESR3) is used to test the emissions from both sides of AC line. According to the requirements in Section 6.2 of ANSI C63.10-2013. Conducted emissions from the EUT measured in the frequency range between 0.15 MHz and 30 MHz using CISPR Quasi-Peak and average detector mode. The bandwidth of EMI test receiver is set at 9 kHz.

The arrangement of the equipment is installed to meet the standards and operating in a manner, which tends to maximize its emission characteristics in a normal application.

### TEST SETUP

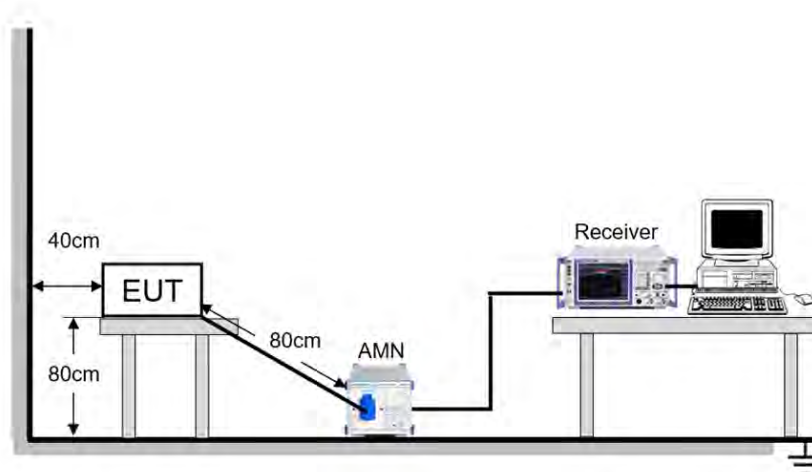

### TEST ENVIRONMENT

Temperature	23.8°C	Relative Humidity	59%
Atmosphere Pressure	101kPa	Test Voltage	AC 120 V, 60 Hz

### TEST DATE / ENGINEER

Test Date	October 9, 2023	Test By	Wite Chen
-----------	-----------------	---------	-----------

**TEST RESULTS**

Test Mode:	802.11b	Frequency(MHz):	2412
Line:	Line		

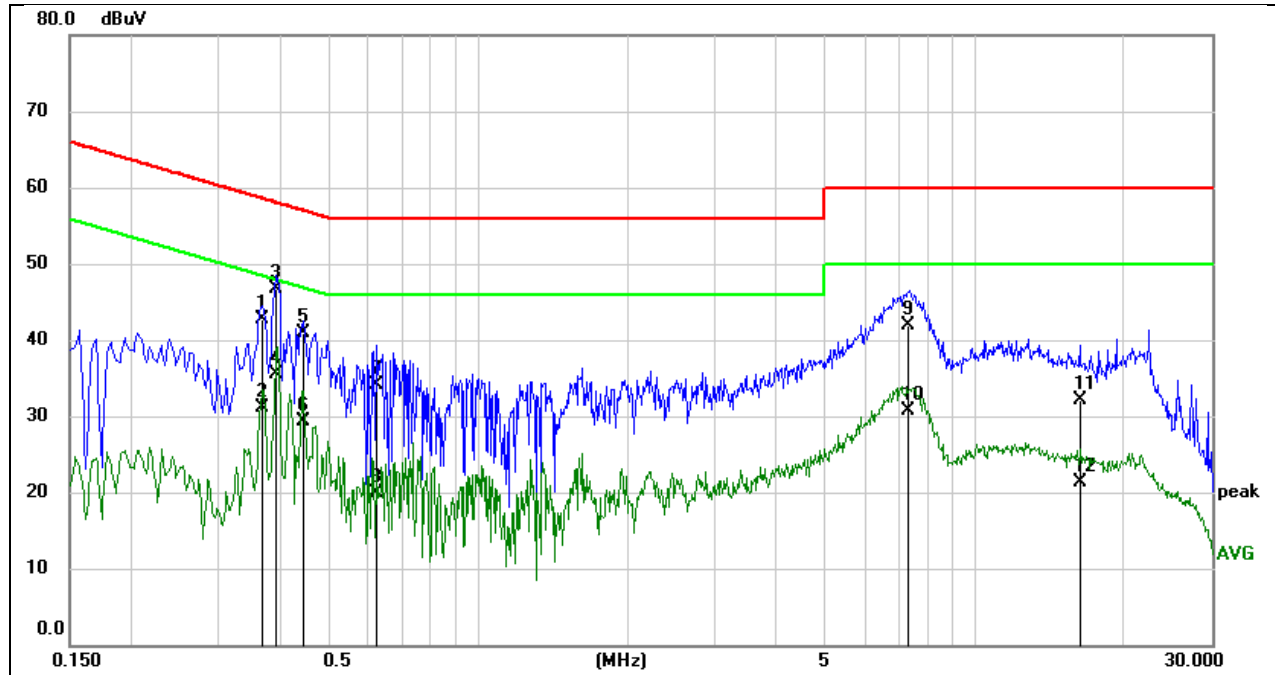

No.	Frequency (MHz)	Reading (dBuV)	Correct (dB)	Result (dBuV)	Limit (dBuV)	Margin (dB)	Remark
1	0.3667	33.03	9.59	42.62	58.58	-15.96	QP
2	0.3667	21.47	9.59	31.06	48.58	-17.52	AVG
3	0.3927	37.10	9.59	46.69	58.01	-11.32	QP
4	0.3927	25.90	9.59	35.49	48.01	-12.52	AVG
5	0.4457	31.22	9.60	40.82	56.95	-16.13	QP
6	0.4457	19.66	9.60	29.26	46.95	-17.69	AVG
7	0.6299	24.48	9.60	34.08	56.00	-21.92	QP
8	0.6299	10.40	9.60	20.00	46.00	-26.00	AVG
9	7.3440	32.16	9.72	41.88	60.00	-18.12	QP
10	7.3440	21.00	9.72	30.72	50.00	-19.28	AVG
11	16.2058	22.36	9.75	32.11	60.00	-27.89	QP
12	16.2058	11.50	9.75	21.25	50.00	-28.75	AVG

**Note:**

1. Result = Reading + Correct Factor.
2. If QP Result complies with AV limit, AV Result is deemed to comply with AV limit.
3. Test setup: RBW: 200 Hz (9 kHz ~ 150 kHz), 9 kHz (150 kHz ~ 30 MHz).
4. Step size: 80 Hz (0.009 MHz ~ 0.15 MHz), 4 kHz (0.15 MHz ~ 30 MHz), Scan time: auto.

Note: All the modes have been tested, only the worst data was recorded in the report.

Test Mode:	802.11b	Frequency(MHz):	2412
Line:	Neutral		

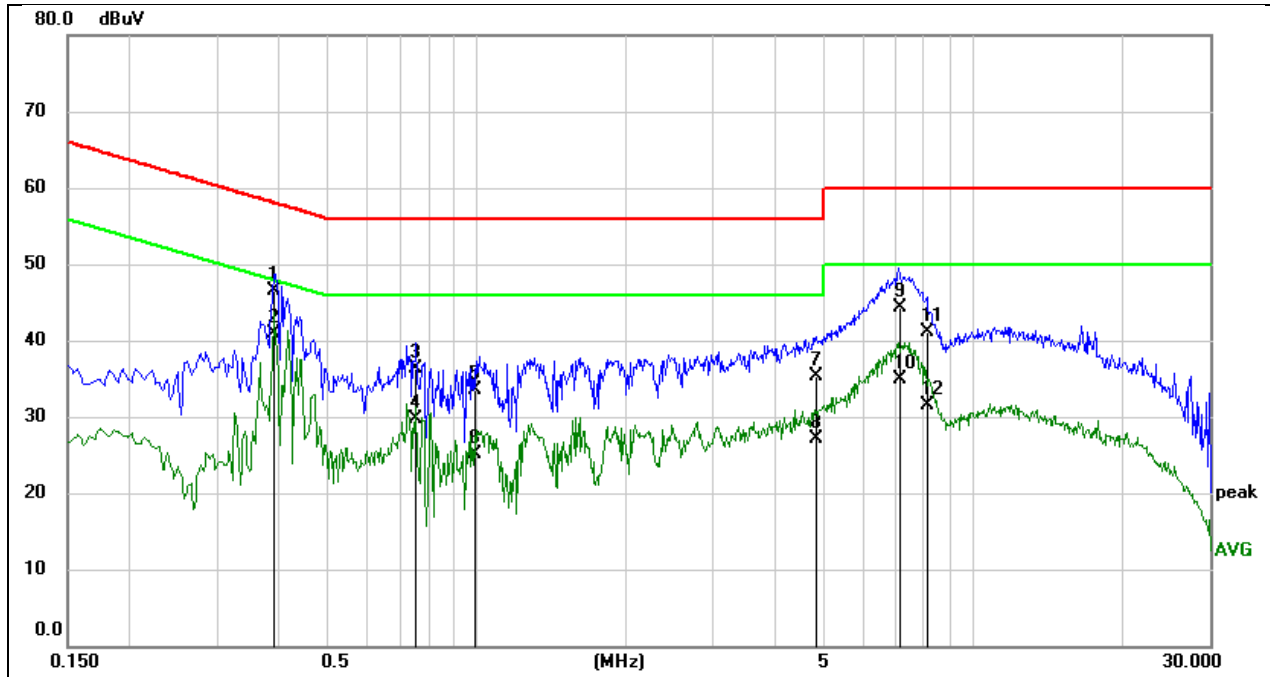

No.	Frequency (MHz)	Reading (dBuV)	Correct (dB)	Result (dBuV)	Limit (dBuV)	Margin (dB)	Remark
1	0.3891	36.88	9.59	46.47	58.08	-11.61	QP
2	0.3891	31.25	9.59	40.84	48.08	-7.24	AVG
3	0.7548	26.64	9.60	36.24	56.00	-19.76	QP
4	0.7548	20.19	9.60	29.79	46.00	-16.21	AVG
5	0.9871	23.99	9.61	33.60	56.00	-22.40	QP
6	0.9871	15.44	9.61	25.05	46.00	-20.95	AVG
7	4.8592	25.59	9.71	35.30	56.00	-20.70	QP
8	4.8592	17.42	9.71	27.13	46.00	-18.87	AVG
9	7.1831	34.58	9.72	44.30	60.00	-15.70	QP
10	7.1831	25.18	9.72	34.90	50.00	-15.10	AVG
11	8.0308	31.30	9.71	41.01	60.00	-18.99	QP
12	8.0308	21.83	9.71	31.54	50.00	-18.46	AVG

**Note:**

1. Result = Reading + Correct Factor.
2. If QP Result complies with AV limit, AV Result is deemed to comply with AV limit.
3. Test setup: RBW: 200 Hz (9 kHz ~ 150 kHz), 9 kHz (150 kHz ~ 30 MHz).
4. Step size: 80 Hz (0.009 MHz ~ 0.15 MHz), 4 kHz (0.15 MHz ~ 30 MHz), Scan time: auto.

Note: All the modes have been tested, only the worst data was recorded in the report.

## 11. TEST DATA

### Appendix A: Duty Cycle

Mode	On Time (msec)	Period (msec)	Duty Cycle x (Linear)	Duty Cycle (%)	Duty Cycle Correction Factor (dB)	1/T Minimum VBW (kHz)	Final setting For VBW (kHz)
b	12.32	12.42	0.9919	99.19	0.04	0.08	0.01
g	2.07	2.24	0.9241	92.41	0.34	0.48	1
n20	1.92	2.00	0.9600	96.00	0.18	0.52	1
n40	0.95	1.10	0.8636	86.36	0.64	1.05	2

Note:

Duty Cycle Correction Factor =  $10 \log (1/x)$ .

Where: x is Duty Cycle (Linear)

Where: T is On Time

If that calculated VBW is not available on the analyzer then the next higher value should be used.

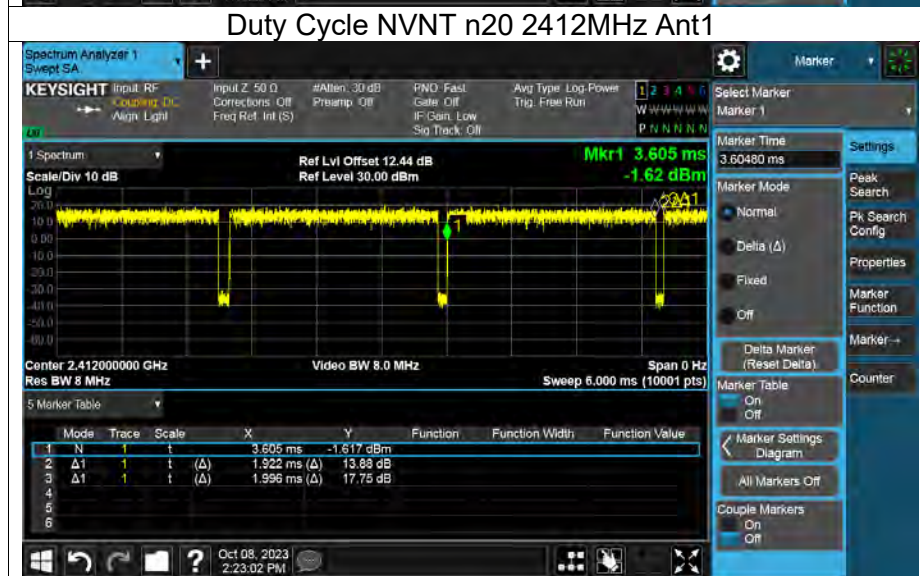
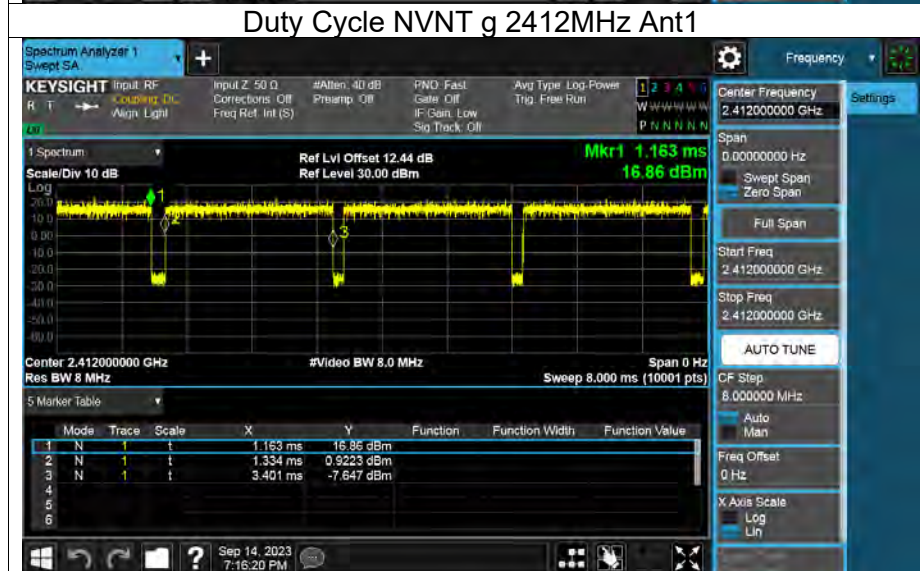
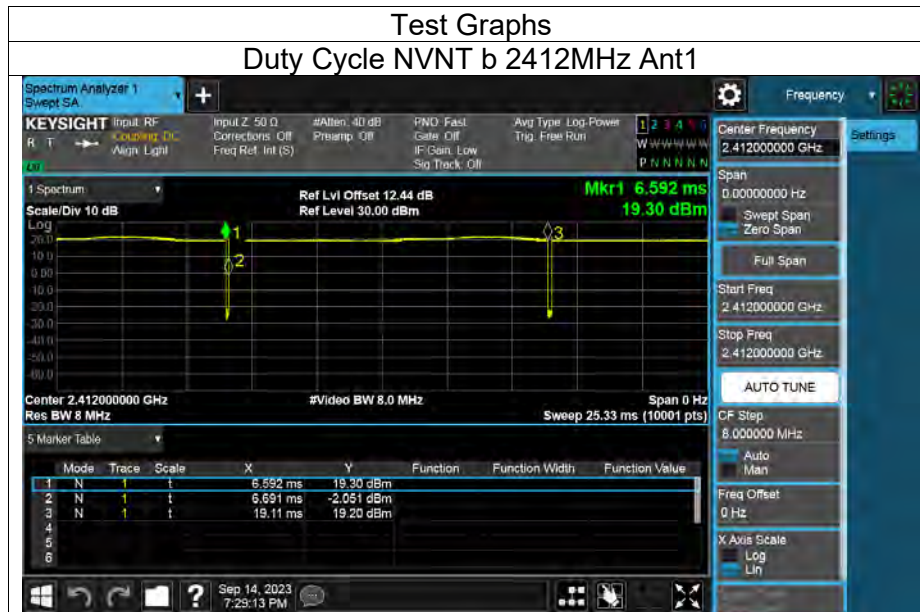

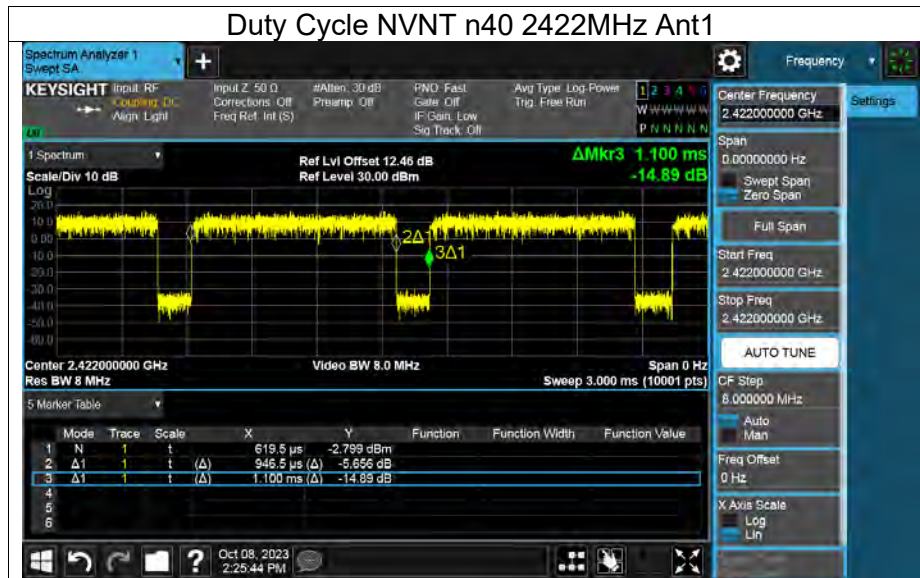

## Appendix B: Maximum Conducted Output Power

Mode	Frequency (MHz)	Antenna	Conducted Power (dBm)	Limit (dBm)	Verdict
b	2412	Ant1	16.61	≤30	Pass
b	2437	Ant1	16.54	≤30	Pass
b	2462	Ant1	16.35	≤30	Pass
g	2412	Ant1	15.28	≤30	Pass
g	2437	Ant1	15.12	≤30	Pass
g	2462	Ant1	15.15	≤30	Pass
n20	2412	Ant1	14.42	≤30	Pass
n20	2437	Ant1	13.98	≤30	Pass
n20	2462	Ant1	13.94	≤30	Pass
n40	2422	Ant1	14.52	≤30	Pass
n40	2437	Ant1	14.01	≤30	Pass
n40	2452	Ant1	14.03	≤30	Pass

Note: 1. Conducted Power=Meas. Level+ Correction Factor

2. The Duty Cycle Factor (refer to section 7.5) had already compensated for the test data.



## Appendix C: -6dB Bandwidth

Mode	Frequency (MHz)	Antenna	-6 dB Bandwidth (MHz)	Limit -6 dB Bandwidth (MHz)	Verdict
b	2412	Ant1	10.053	≥0.5	Pass
b	2437	Ant1	10.056	≥0.5	Pass
b	2462	Ant1	10.05	≥0.5	Pass
g	2412	Ant1	16.335	≥0.5	Pass
g	2437	Ant1	16.326	≥0.5	Pass
g	2462	Ant1	16.379	≥0.5	Pass
n20	2412	Ant1	17.541	≥0.5	Pass
n20	2437	Ant1	17.547	≥0.5	Pass
n20	2462	Ant1	17.544	≥0.5	Pass
n40	2422	Ant1	36.04	≥0.5	Pass
n40	2437	Ant1	36.029	≥0.5	Pass
n40	2452	Ant1	36.04	≥0.5	Pass



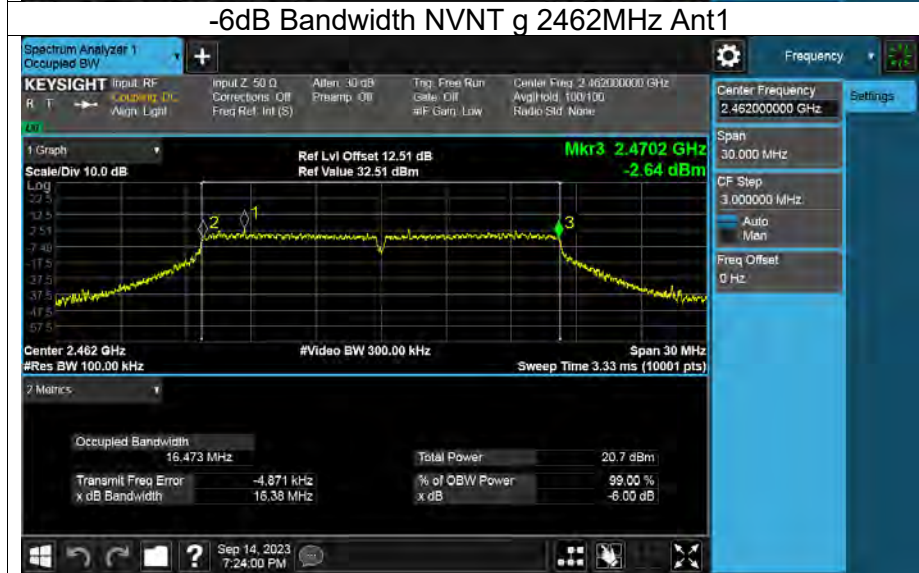

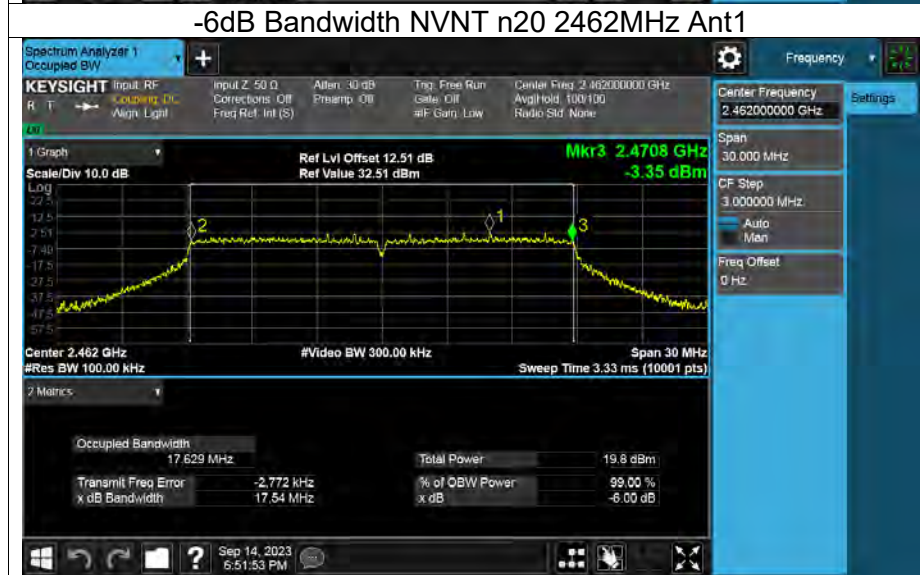
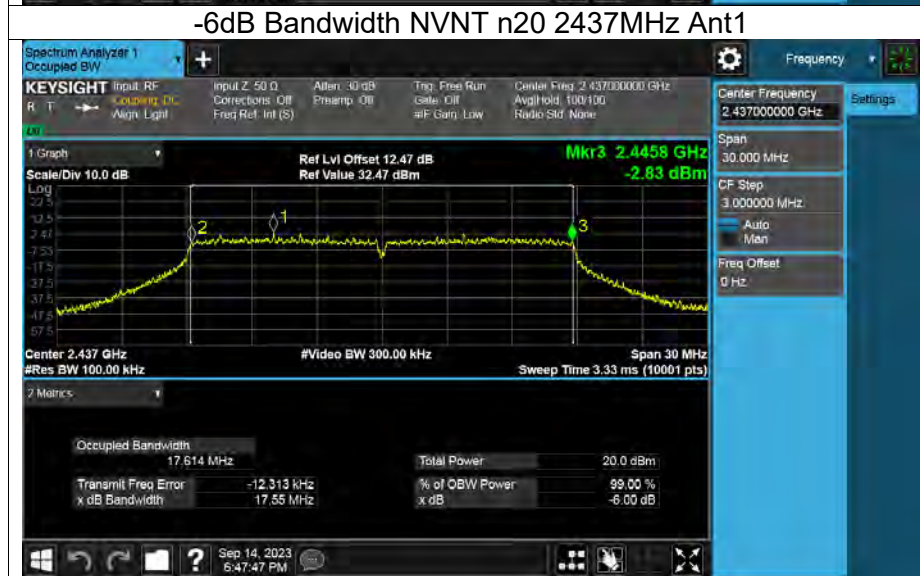
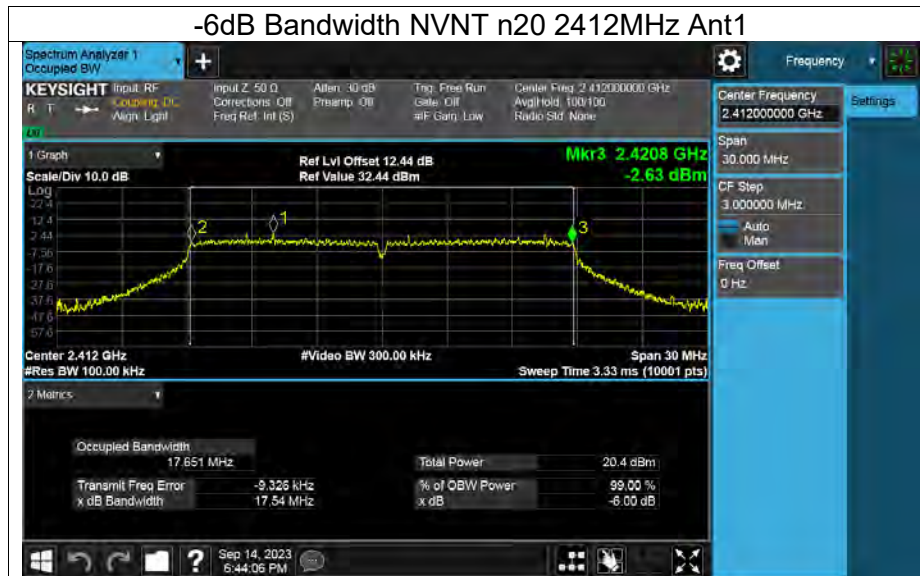

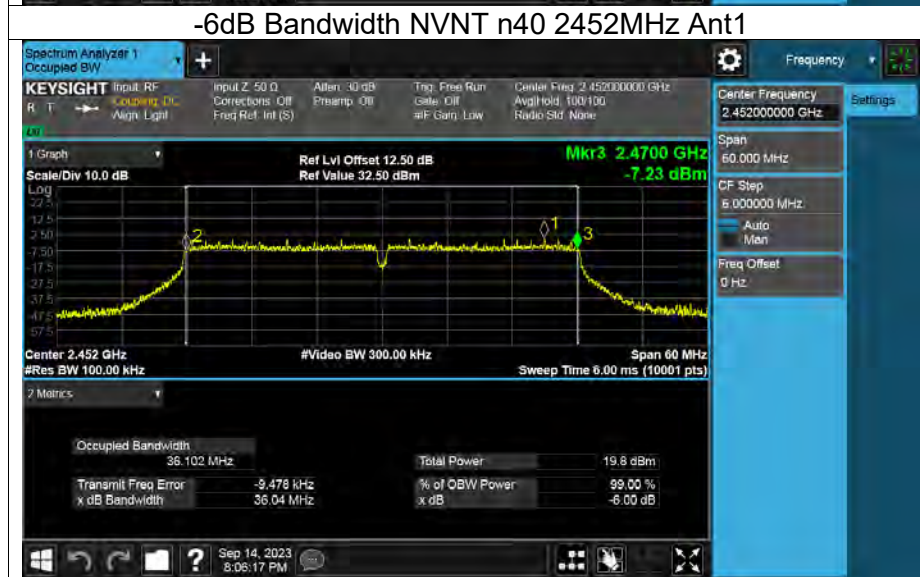
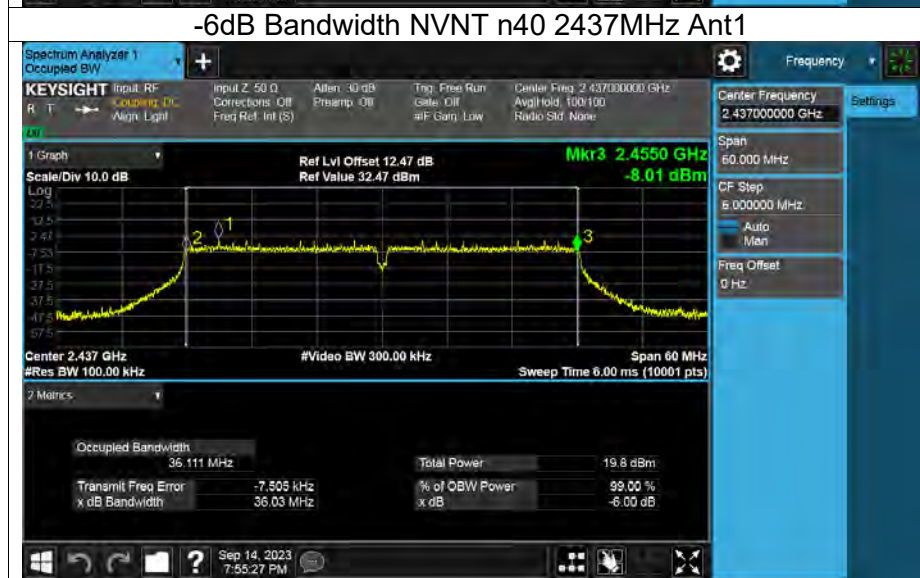
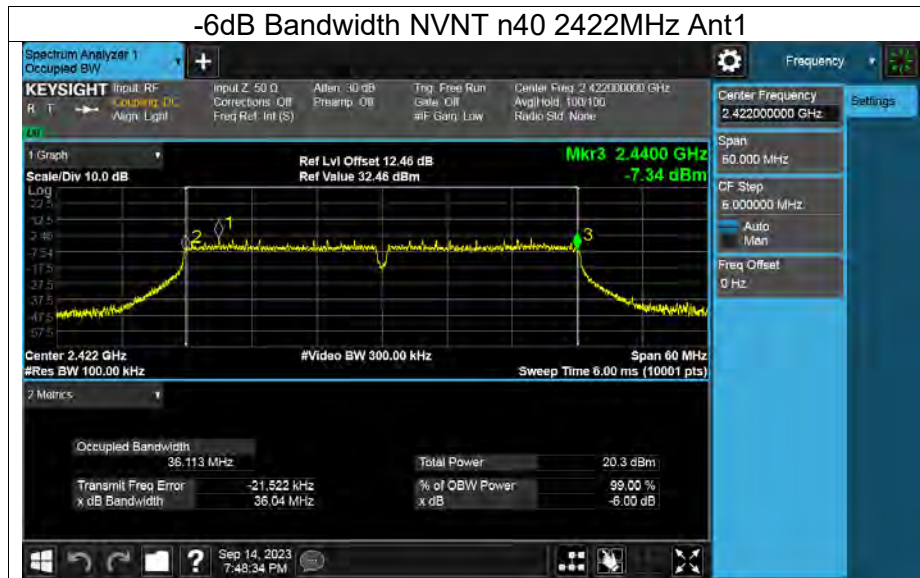

## Appendix D: Occupied Channel Bandwidth

Mode	Frequency (MHz)	Antenna	99% OBW (MHz)
b	2412	Ant1	15.052
b	2437	Ant1	15.05
b	2462	Ant1	15.052
g	2412	Ant1	16.559
g	2437	Ant1	16.652
g	2462	Ant1	16.584
n20	2412	Ant1	17.726
n20	2437	Ant1	17.684
n20	2462	Ant1	17.689
n40	2422	Ant1	36.27
n40	2437	Ant1	36.3
n40	2452	Ant1	36.257



OBW NVNT g 2412MHz Ant1



OBW NVNT g 2437MHz Ant1

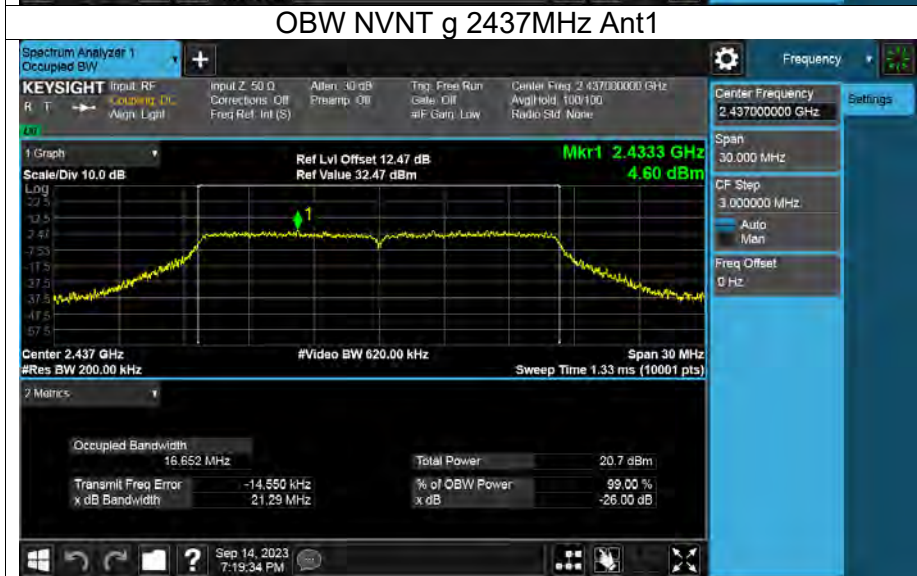

OBW NVNT g 2462MHz Ant1

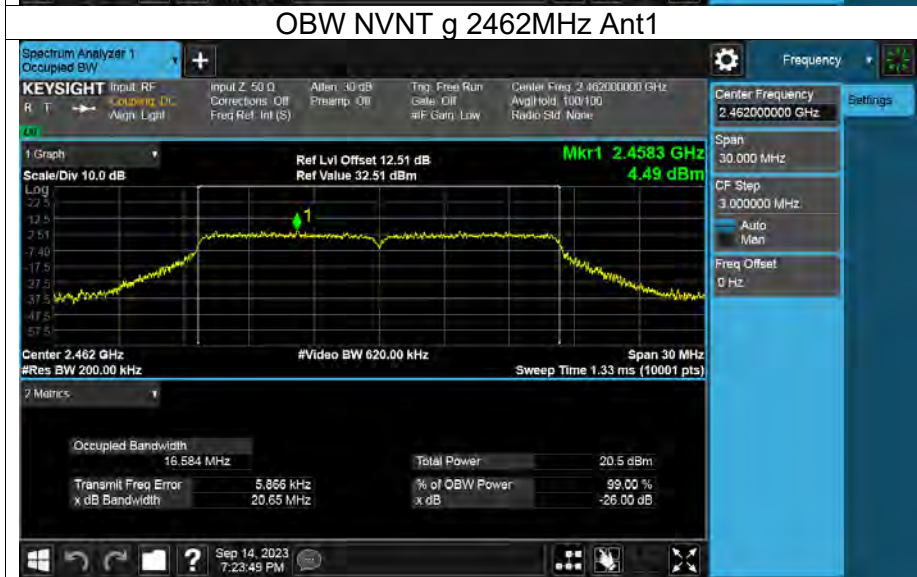



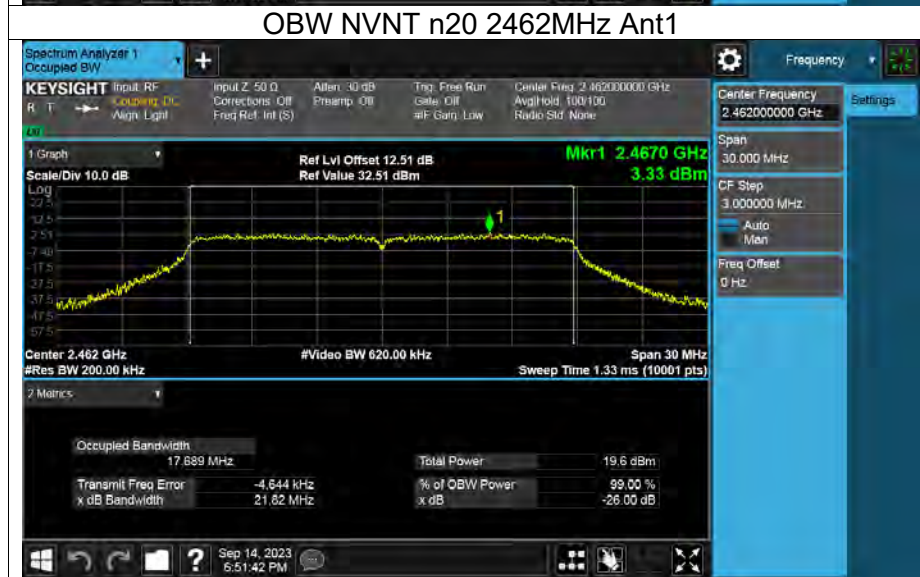
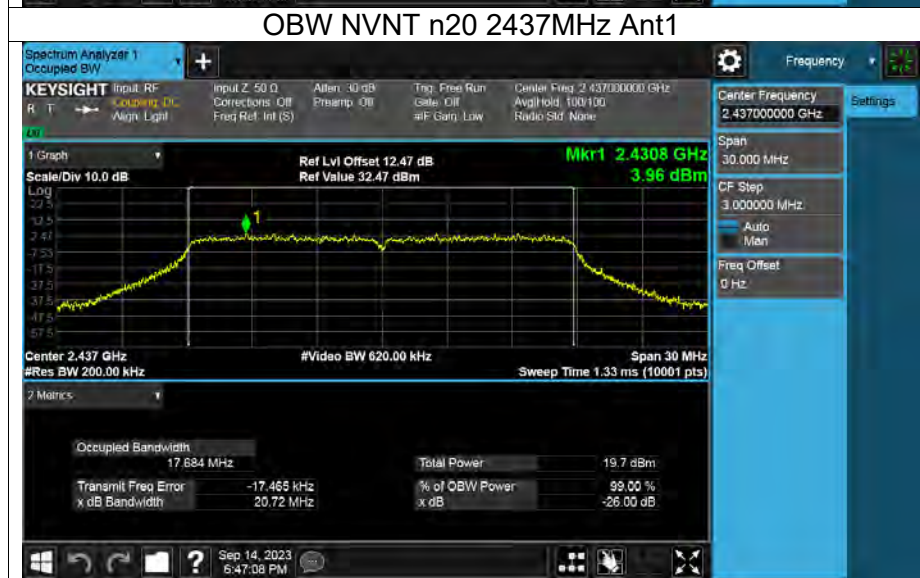
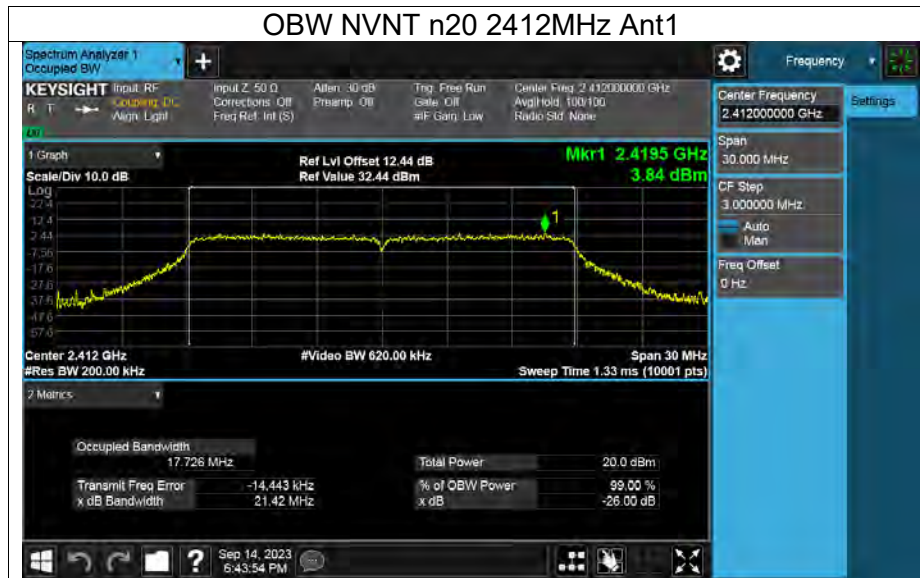

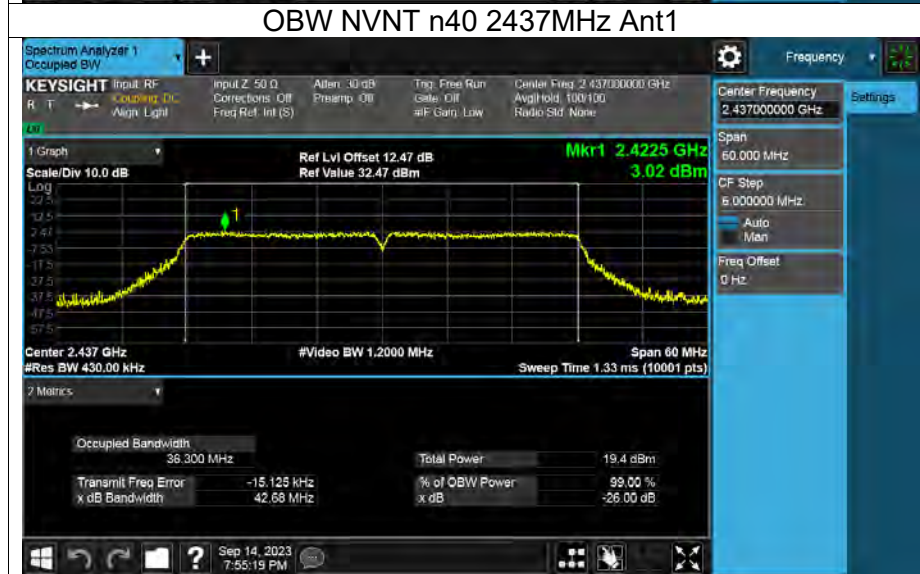

## Appendix E: Maximum Power Spectral Density Level

Mode	Frequency (MHz)	Antenna	Conducted PSD (dBm/3kHz)	Total PSD (dBm/3kHz)	Limit (dBm/3kHz)	Verdict
b	2412	Ant1	-18.22	-18.22	8	Pass
b	2437	Ant1	-18.61	-18.61	8	Pass
b	2462	Ant1	-18.63	-18.63	8	Pass
g	2412	Ant1	-19.31	-18.96	8	Pass
g	2437	Ant1	-19.91	-19.6	8	Pass
g	2462	Ant1	-19.04	-18.73	8	Pass
n20	2412	Ant1	-21.41	-21.08	8	Pass
n20	2437	Ant1	-21.29	-21	8	Pass
n20	2462	Ant1	-21.65	-21.3	8	Pass
n40	2422	Ant1	-25.27	-24.92	8	Pass
n40	2437	Ant1	-25.31	-24.95	8	Pass
n40	2452	Ant1	-24.34	-23.99	8	Pass

Note: 1. The Duty Cycle Factor (refer to section 7.5) had already compensated for the test data.



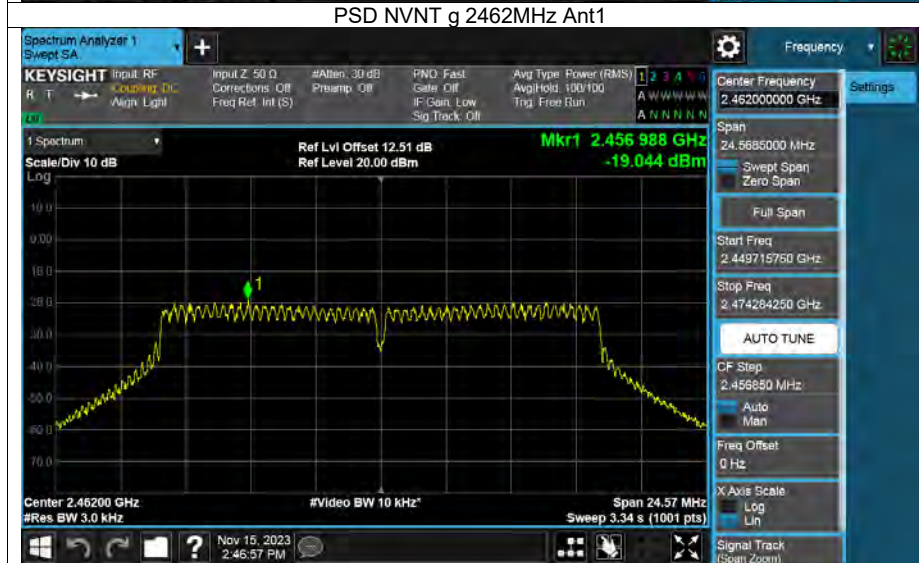
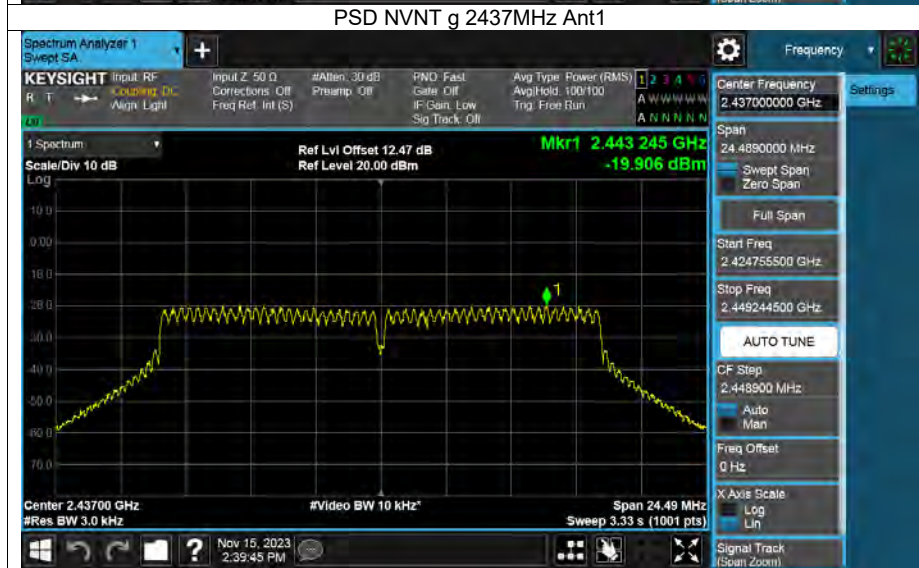
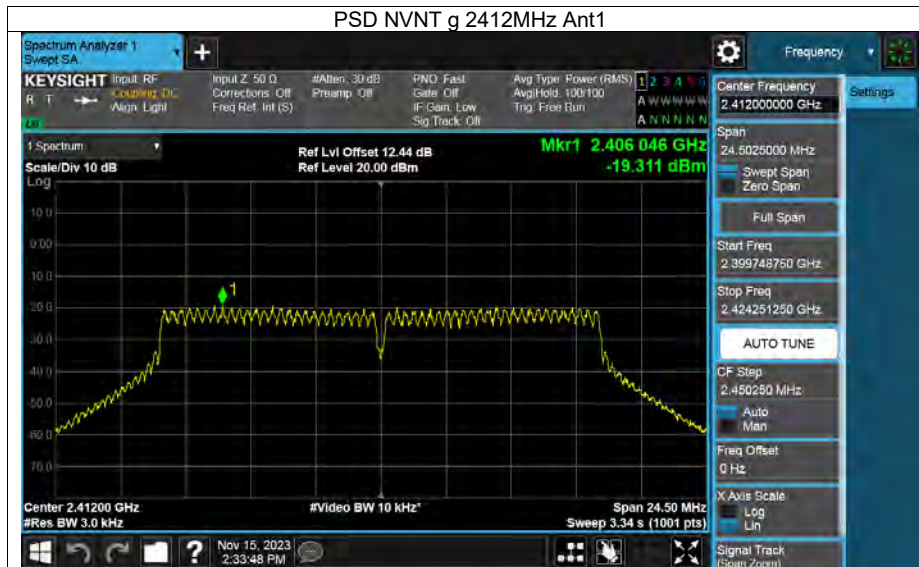

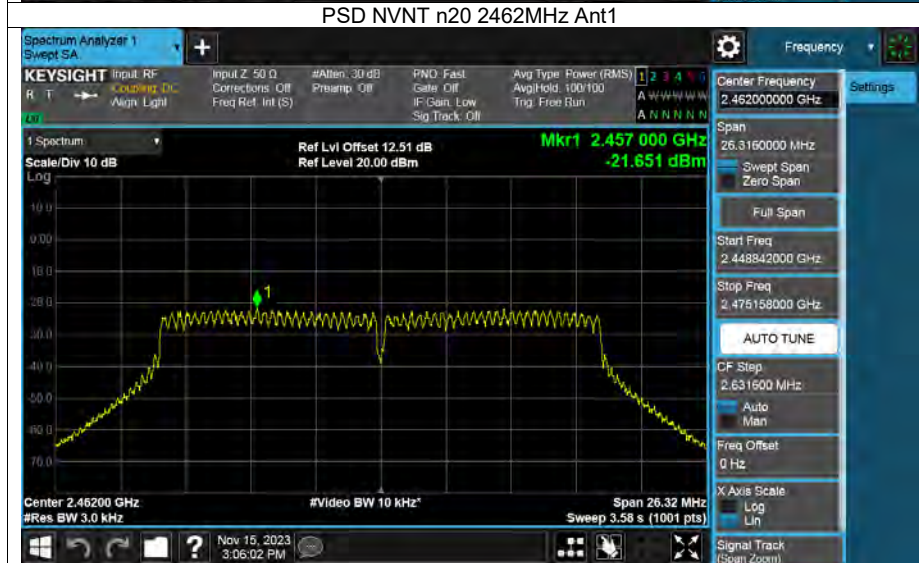
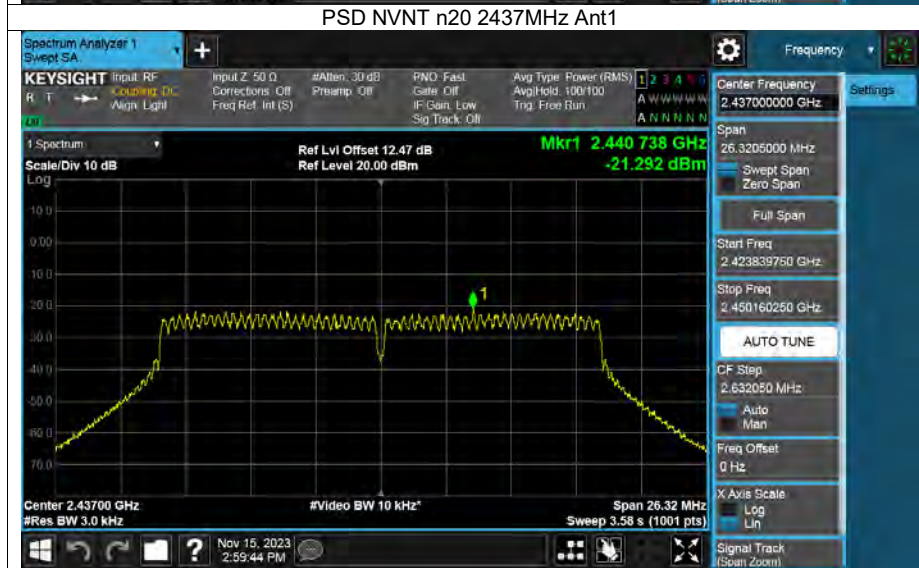
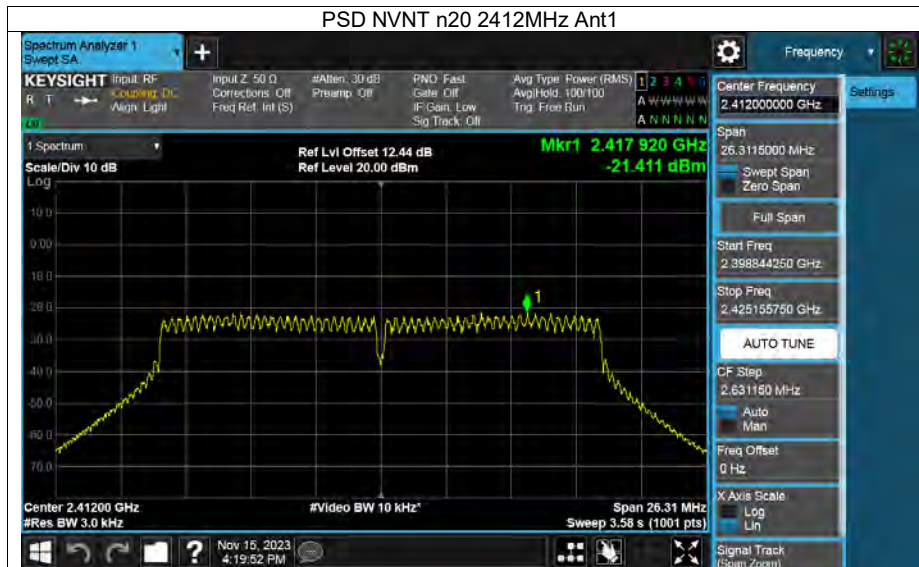

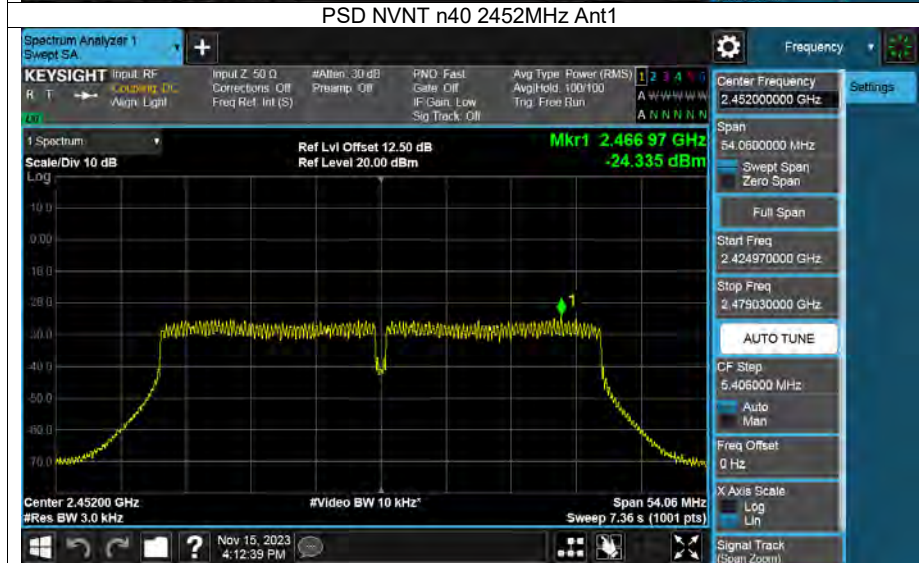
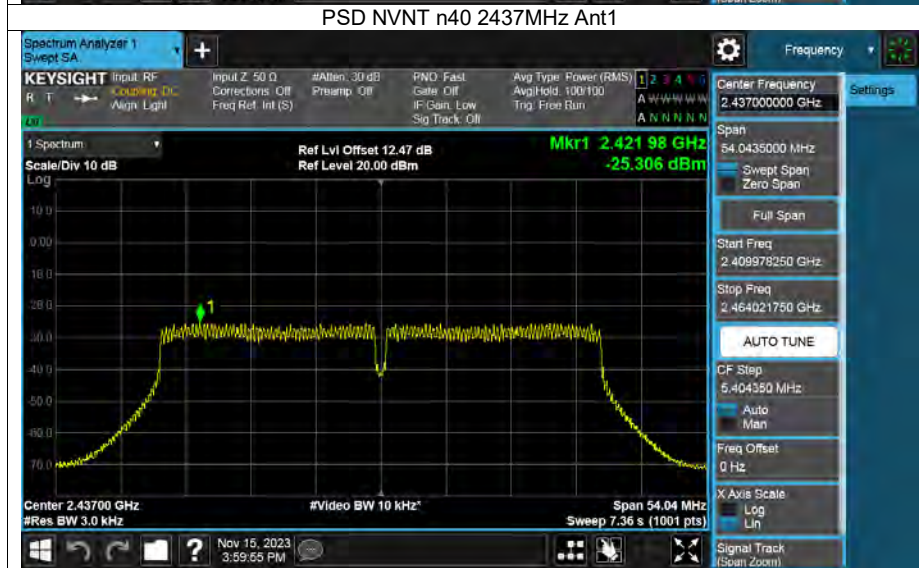
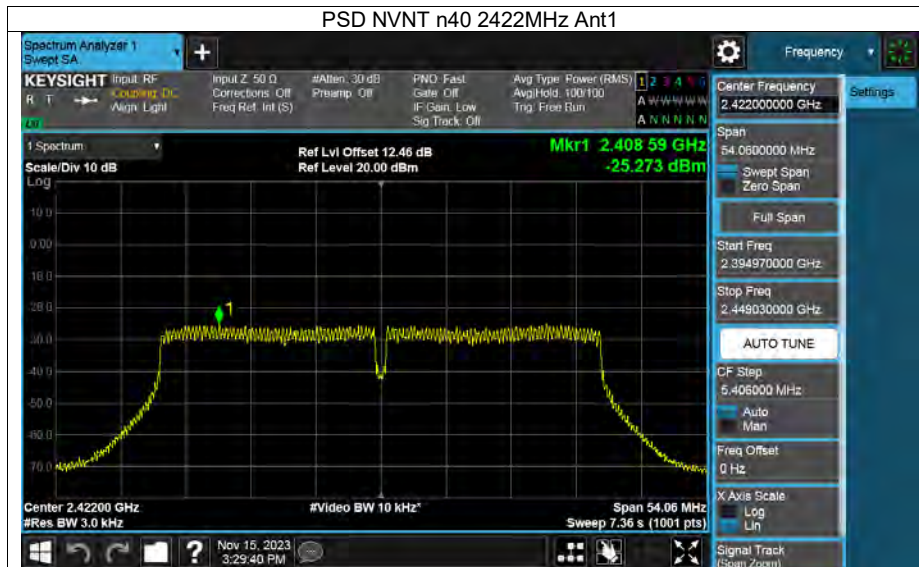

## Appendix F: Band Edge

Mode	Frequency (MHz)	Antenna	Max Value (dBc)	Limit (dBc)	Verdict
b	2412	Ant1	-42.7	$\leq -30$	Pass
b	2462	Ant1	-52.42	$\leq -30$	Pass
g	2412	Ant1	-36.37	$\leq -30$	Pass
g	2462	Ant1	-48.64	$\leq -30$	Pass
n20	2412	Ant1	-38.14	$\leq -30$	Pass
n20	2462	Ant1	-48.52	$\leq -30$	Pass
n40	2422	Ant1	-35.77	$\leq -30$	Pass
n40	2452	Ant1	-43.65	$\leq -30$	Pass



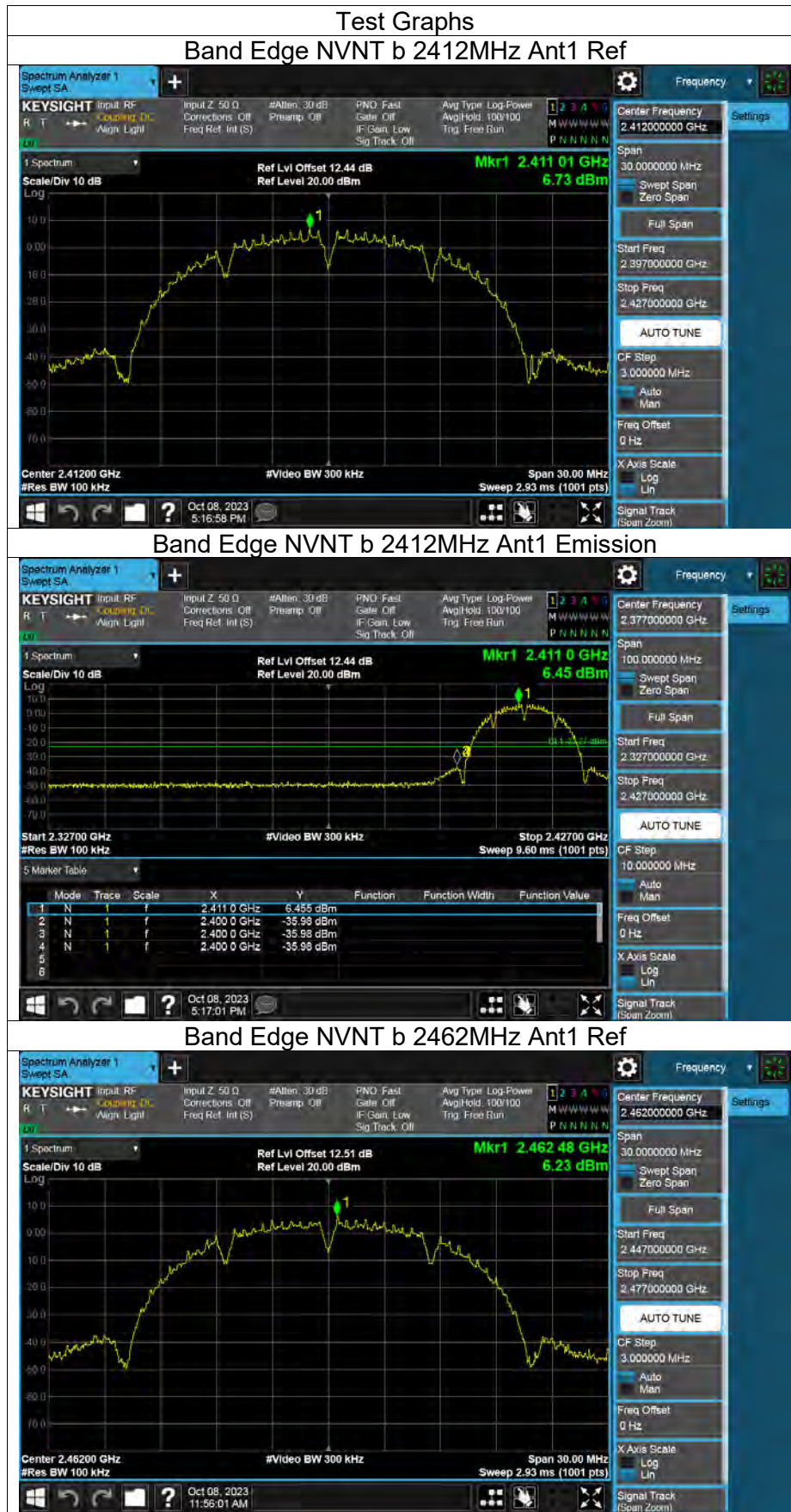

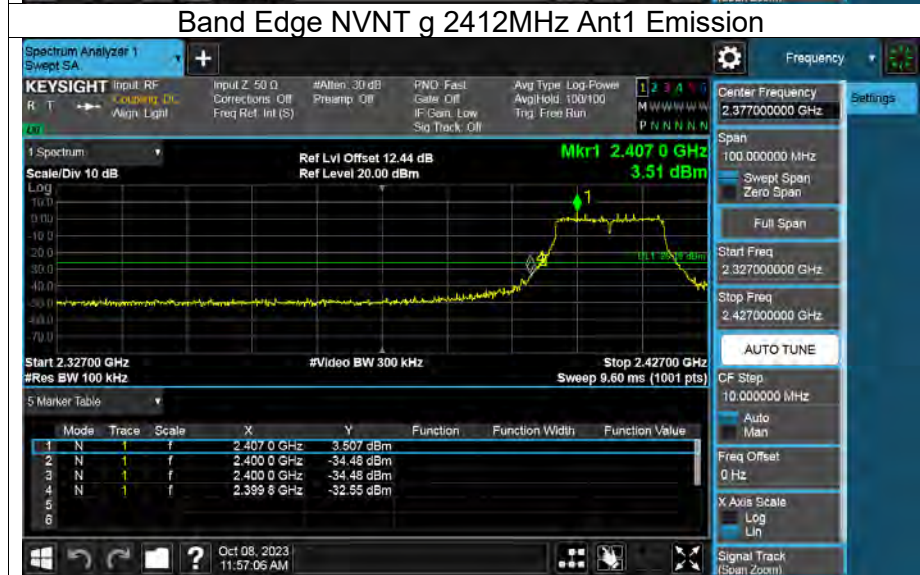
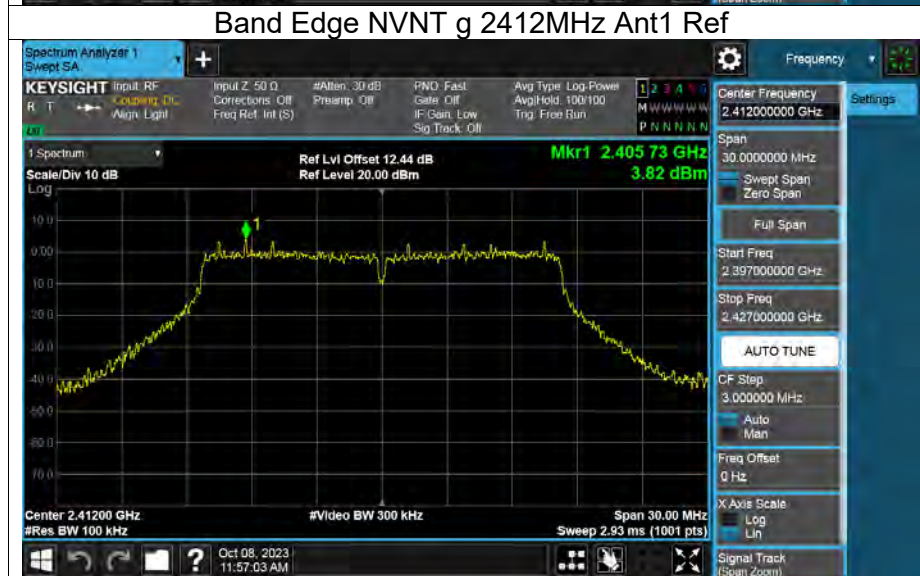
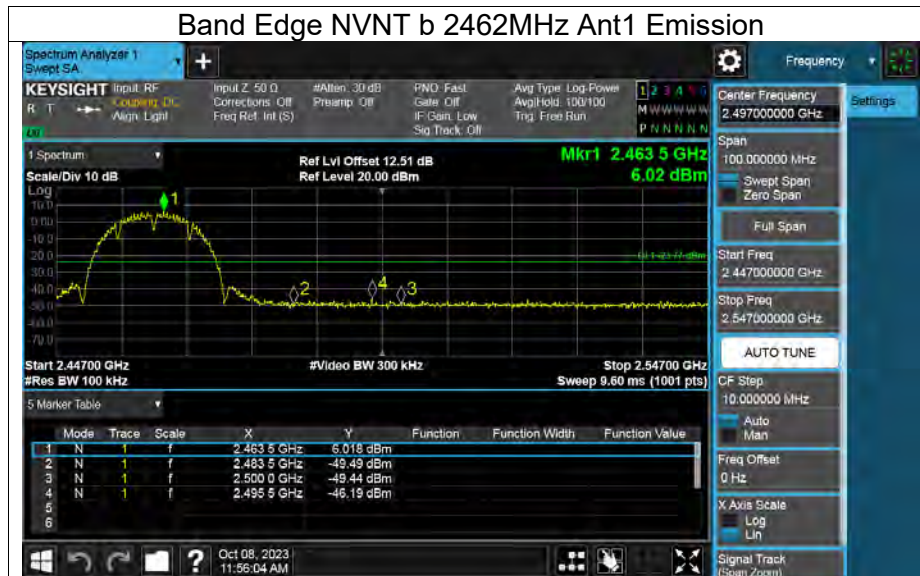

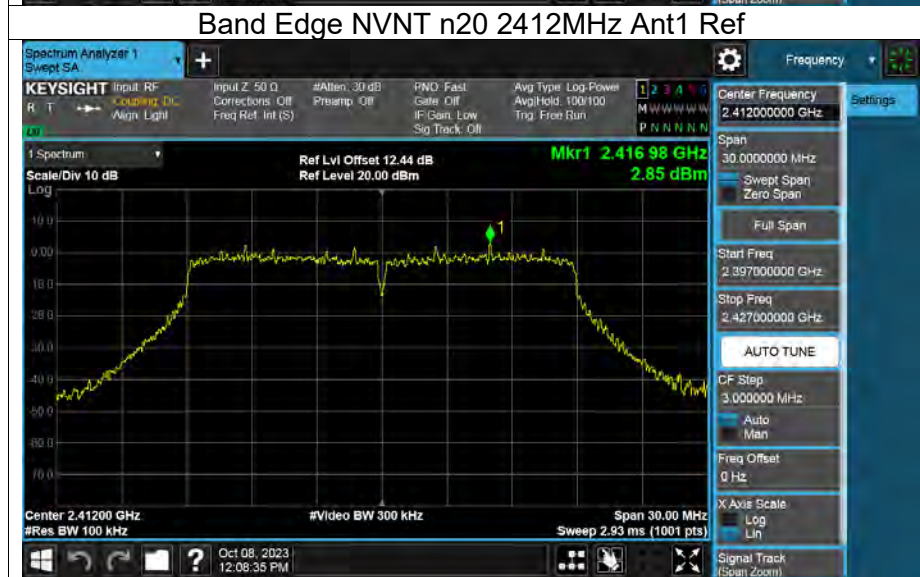
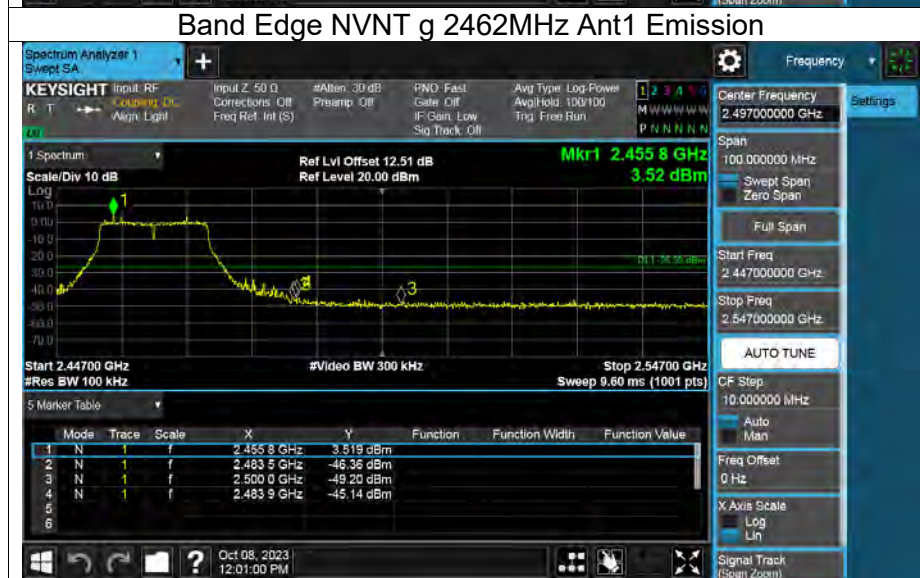
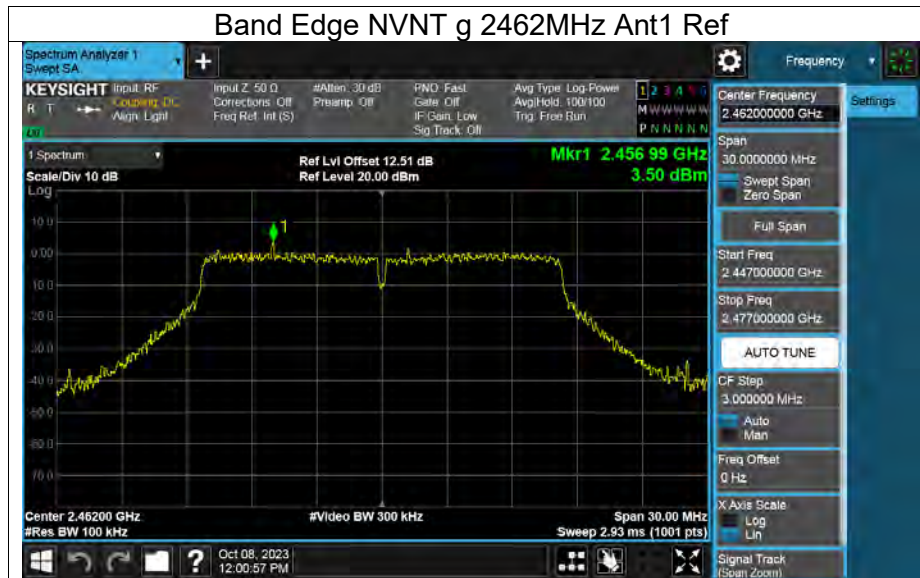

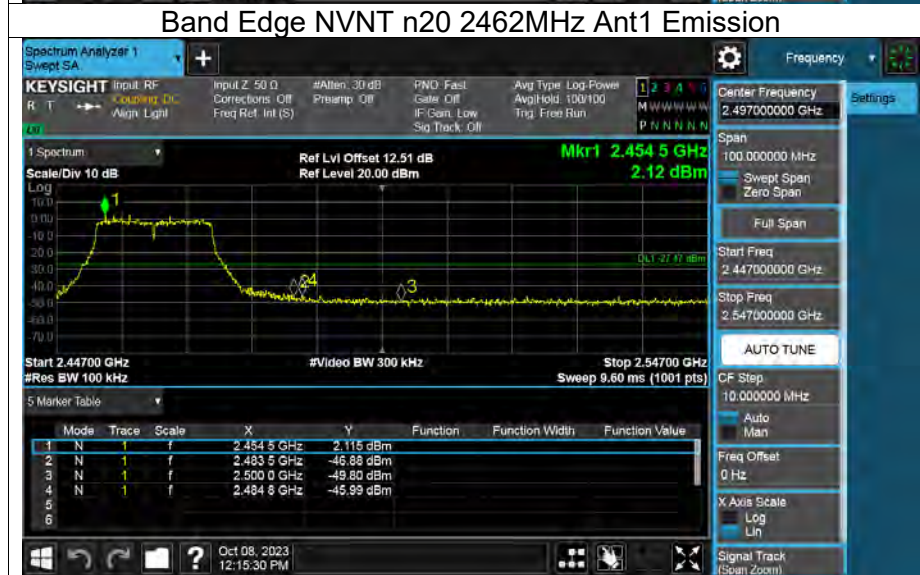
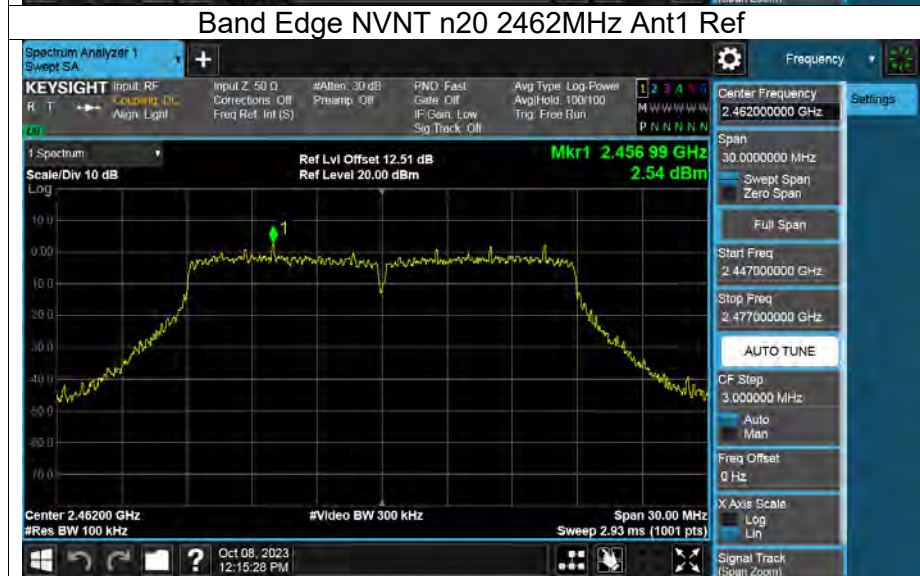
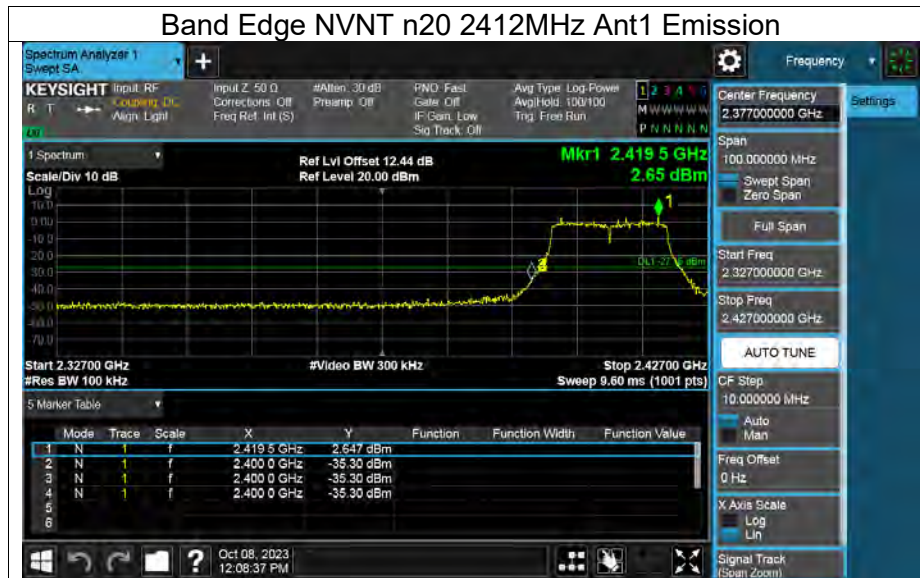

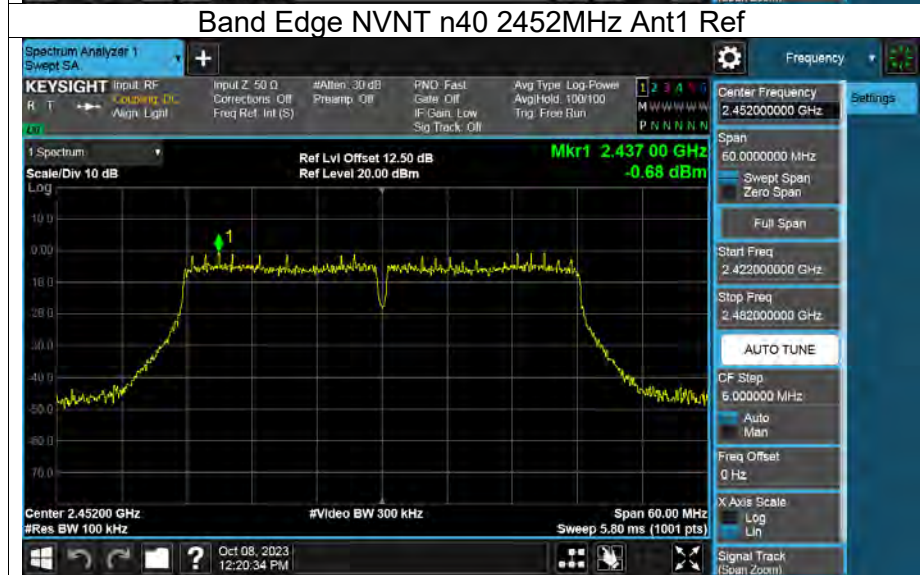
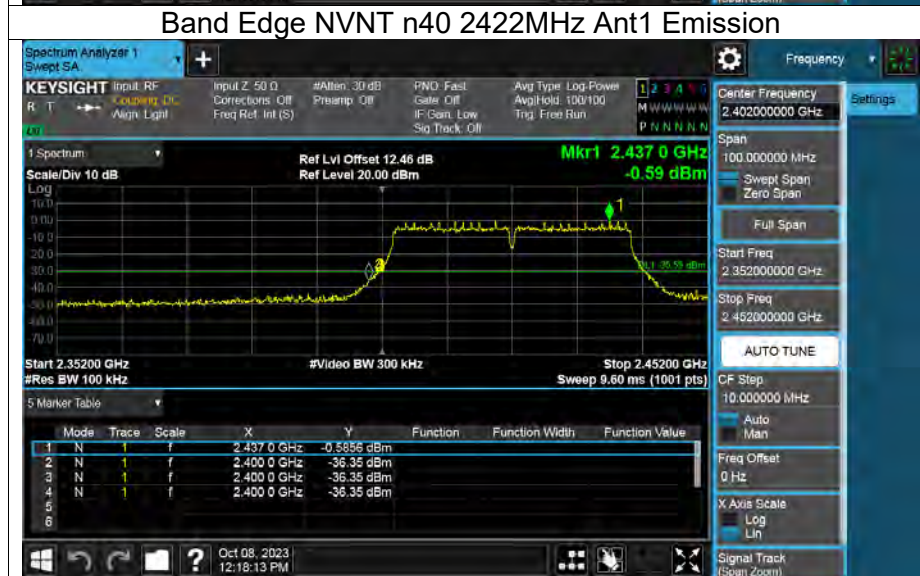
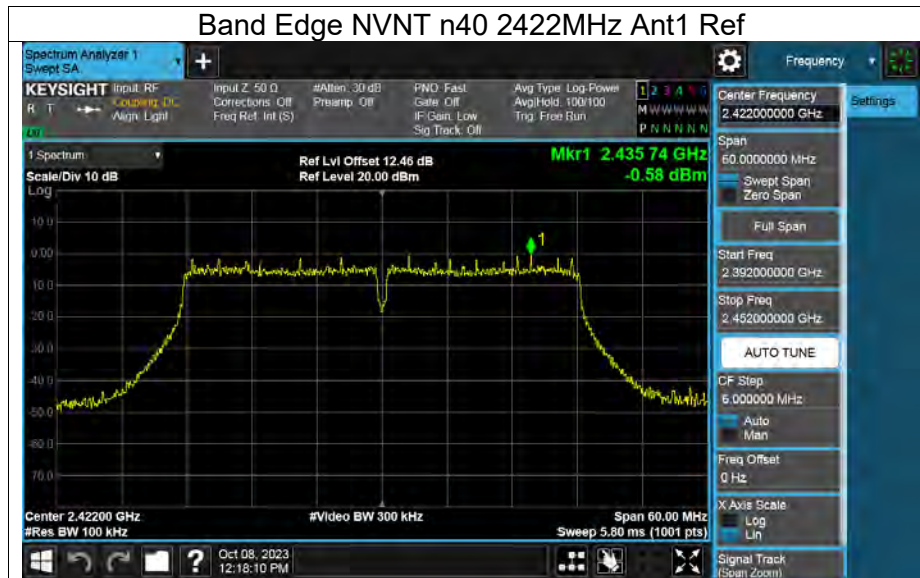

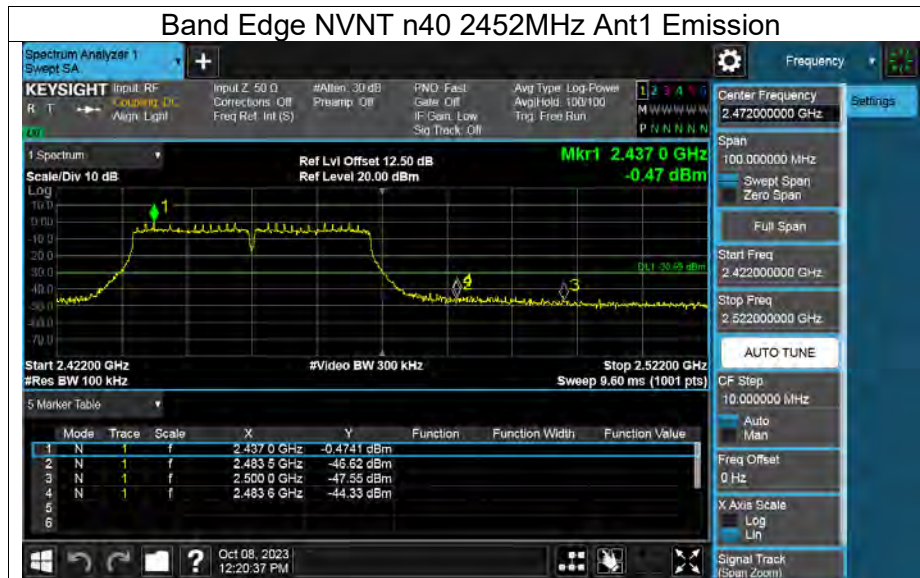

## Appendix G: Conducted RF Spurious Emission

Mode	Frequency (MHz)	Antenna	Max Value (dBc)	Limit (dBc)	Verdict
b	2412	Ant1	-45.97	≤-30	Pass
b	2437	Ant1	-45.35	≤-30	Pass
b	2462	Ant1	-45.73	≤-30	Pass
g	2412	Ant1	-43.99	≤-30	Pass
g	2437	Ant1	-43.1	≤-30	Pass
g	2462	Ant1	-43.1	≤-30	Pass
n20	2412	Ant1	-42.15	≤-30	Pass
n20	2437	Ant1	-42	≤-30	Pass
n20	2462	Ant1	-40.34	≤-30	Pass
n40	2422	Ant1	-38.88	≤-30	Pass
n40	2437	Ant1	-38.74	≤-30	Pass
n40	2452	Ant1	-38.23	≤-30	Pass

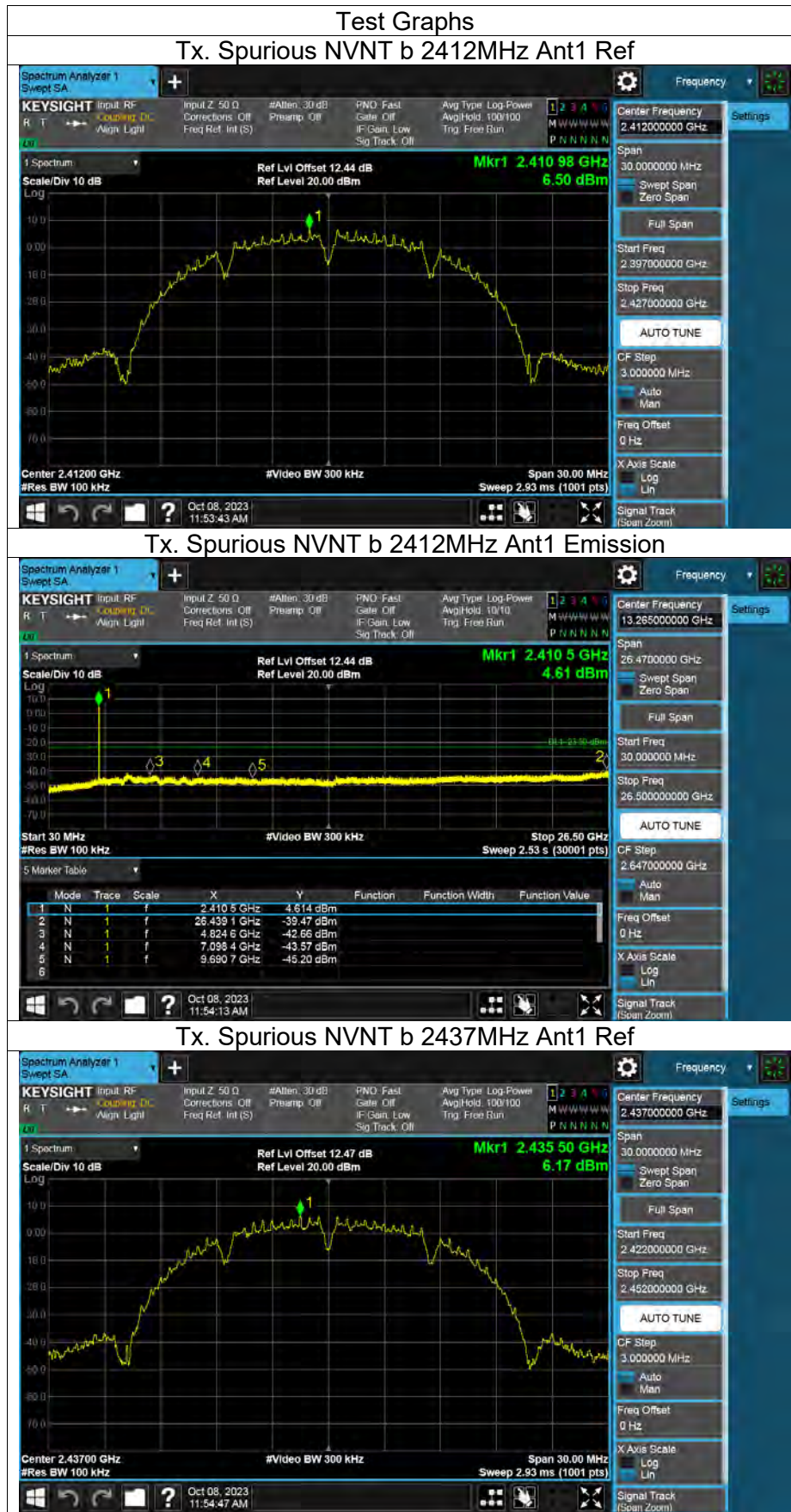



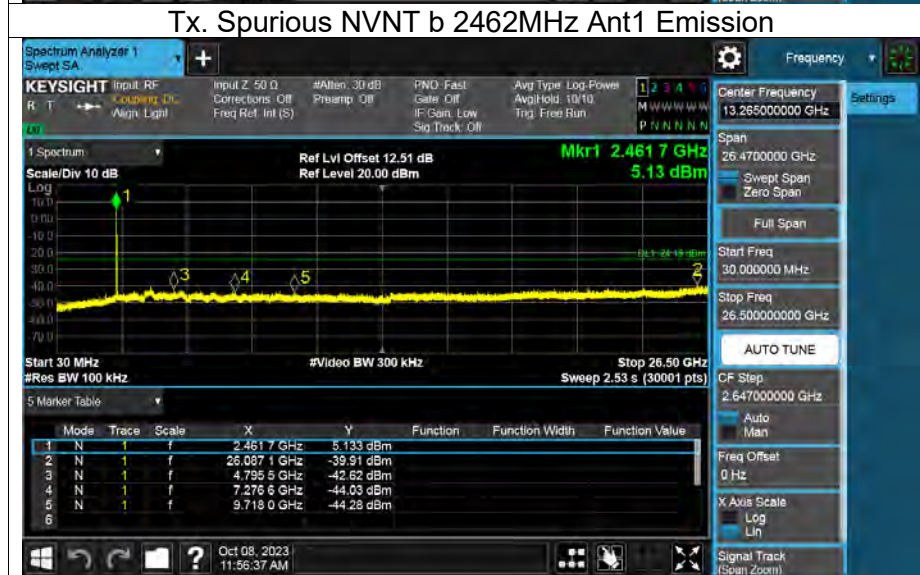
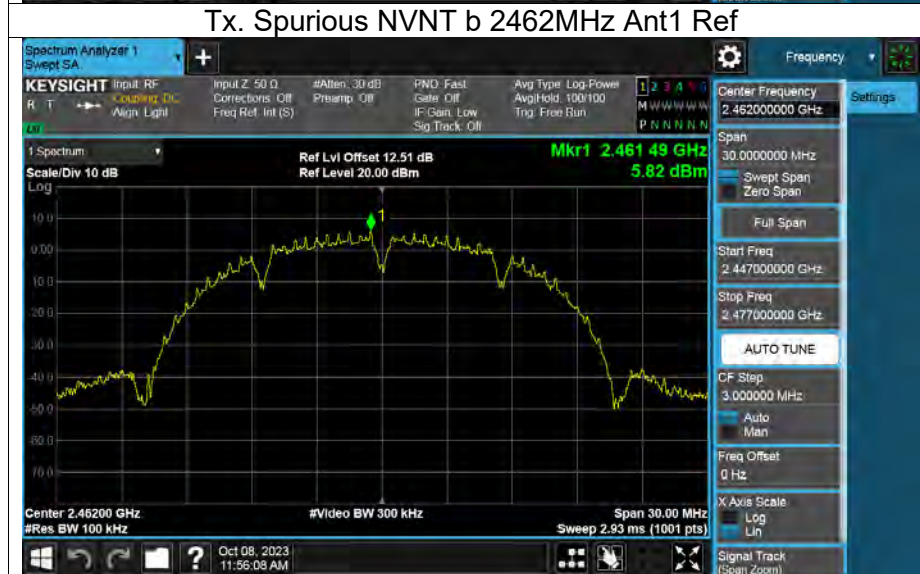
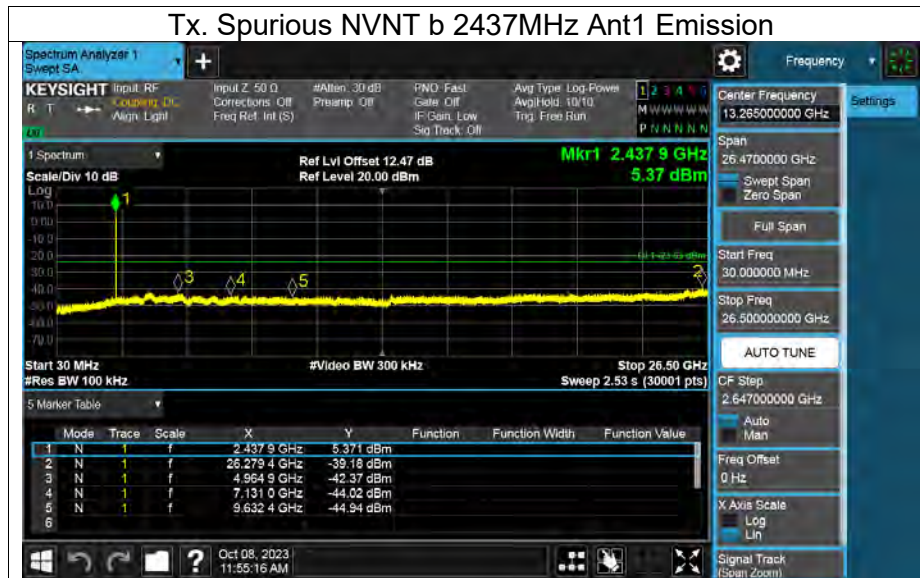

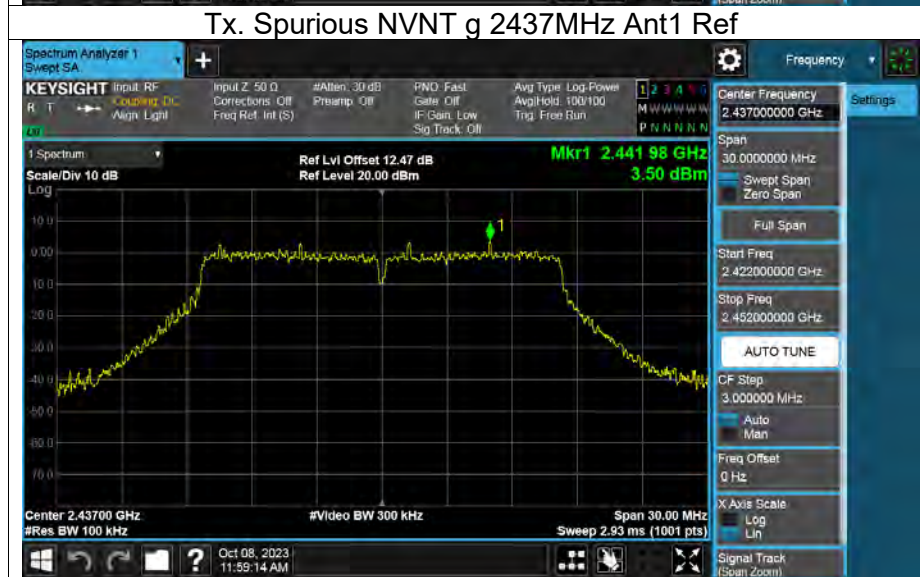
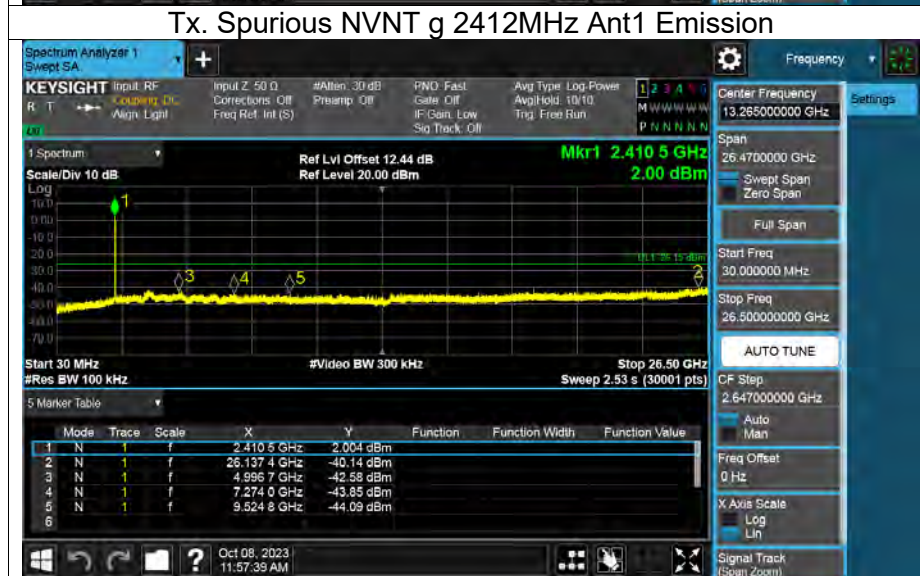
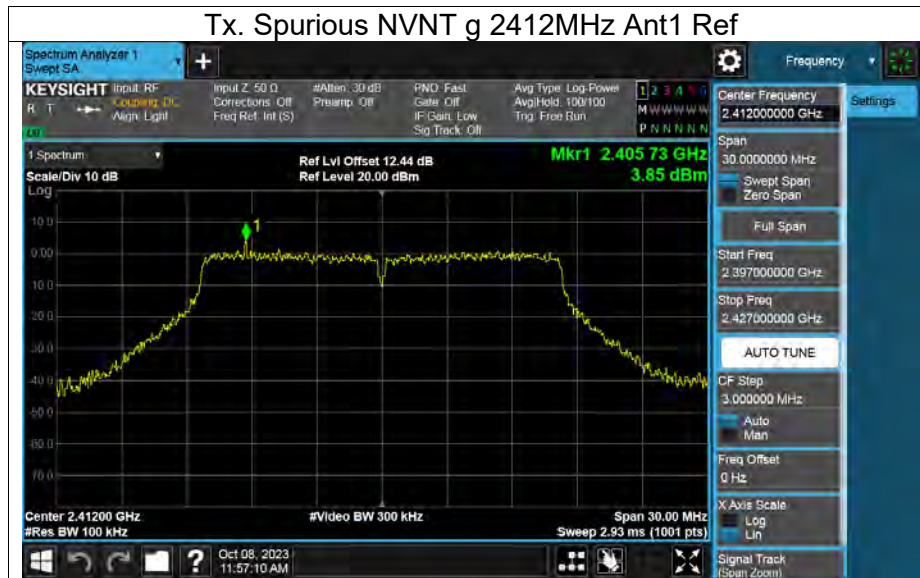

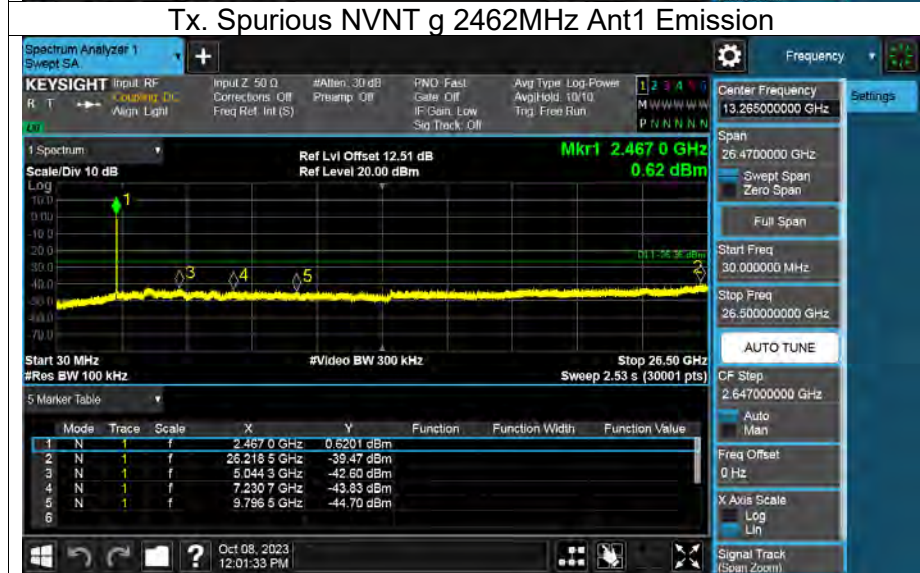
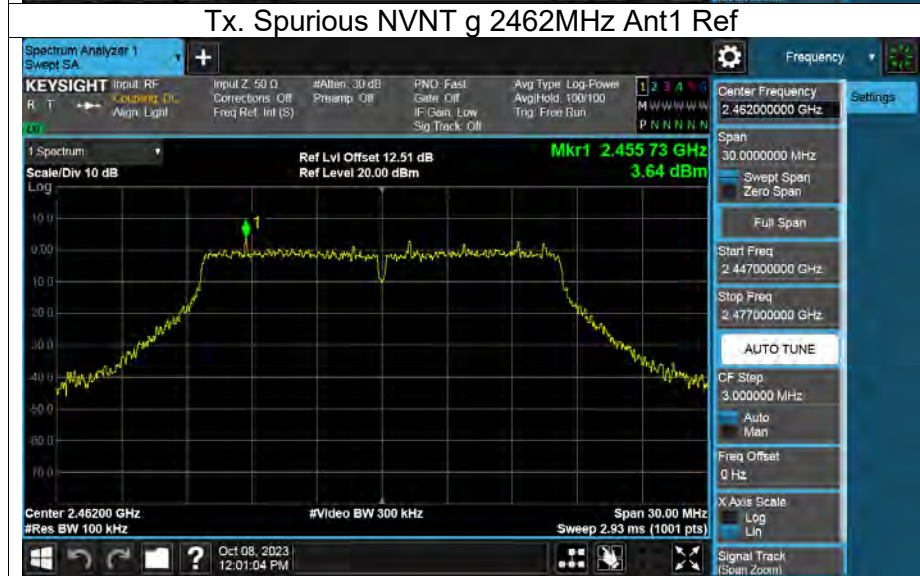
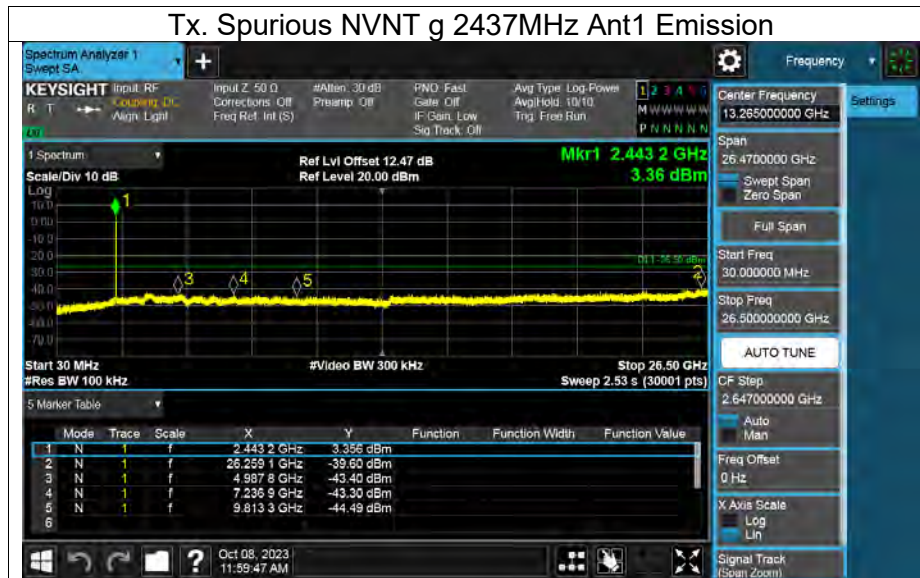

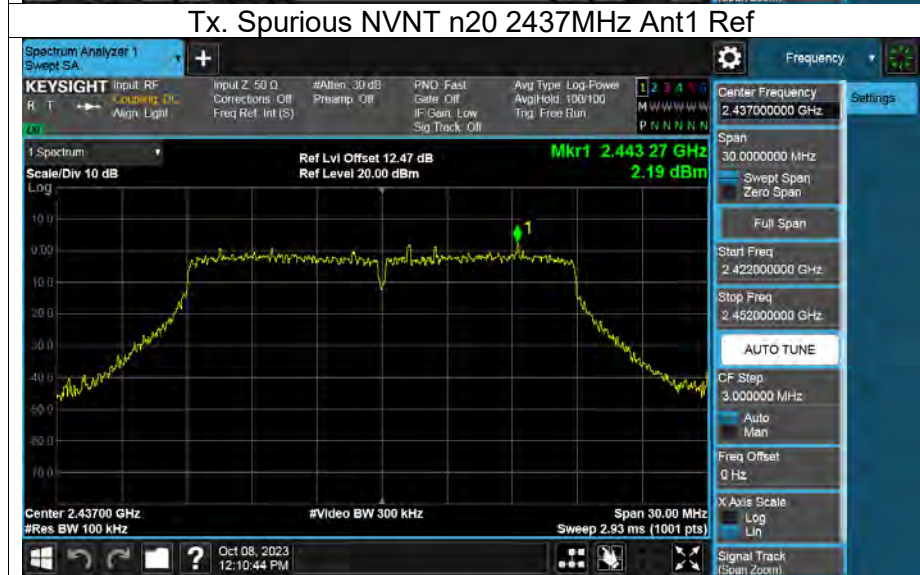
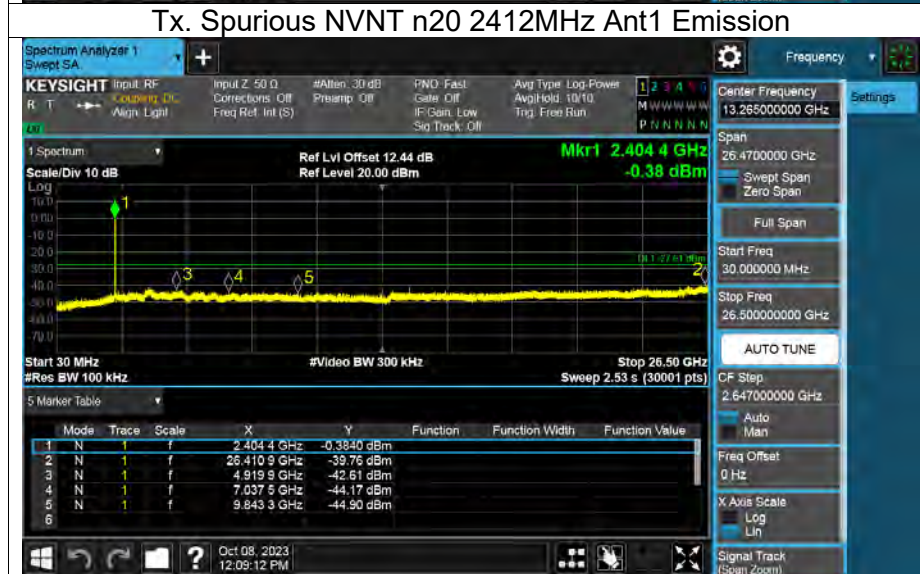
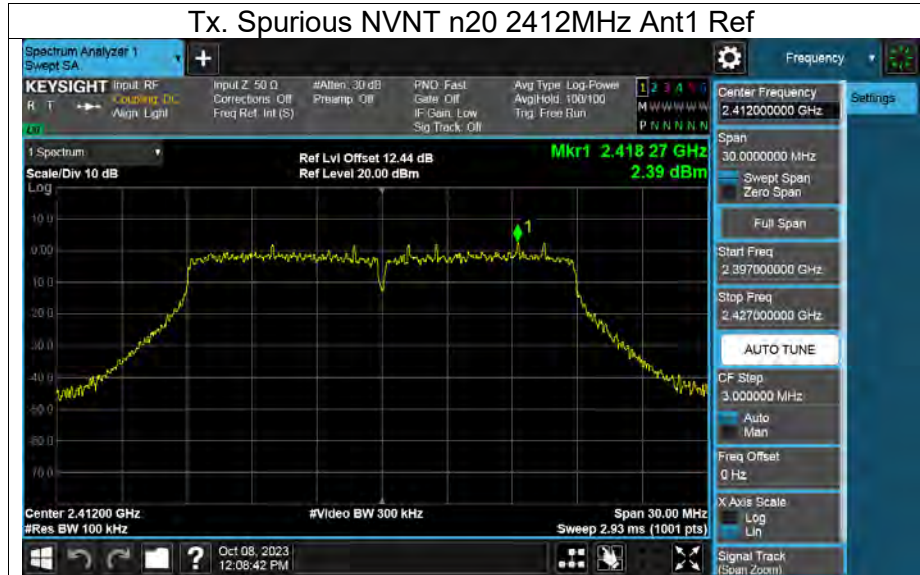

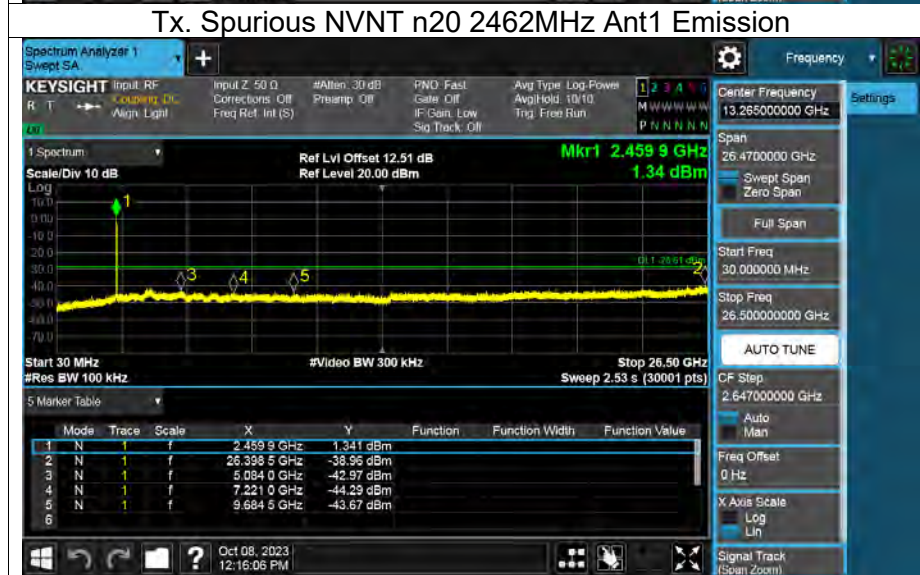
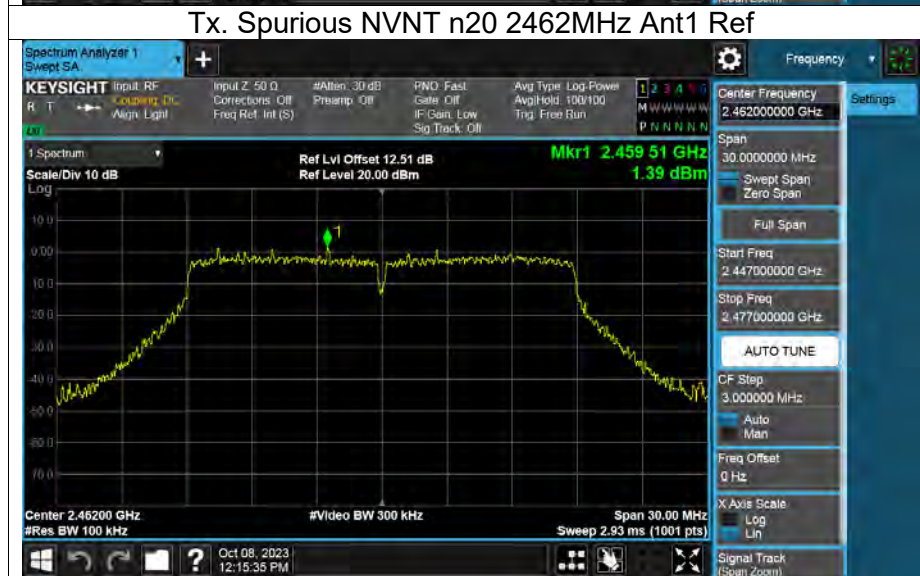
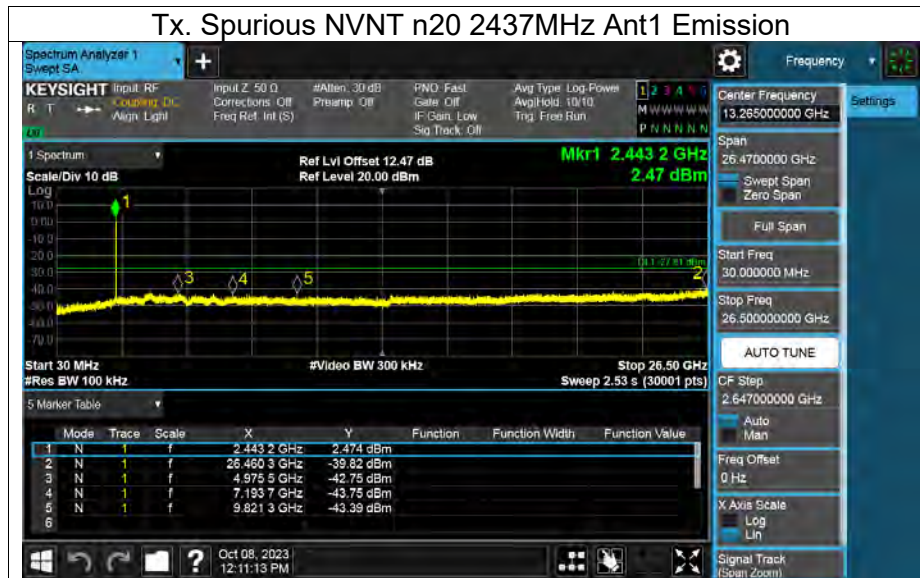

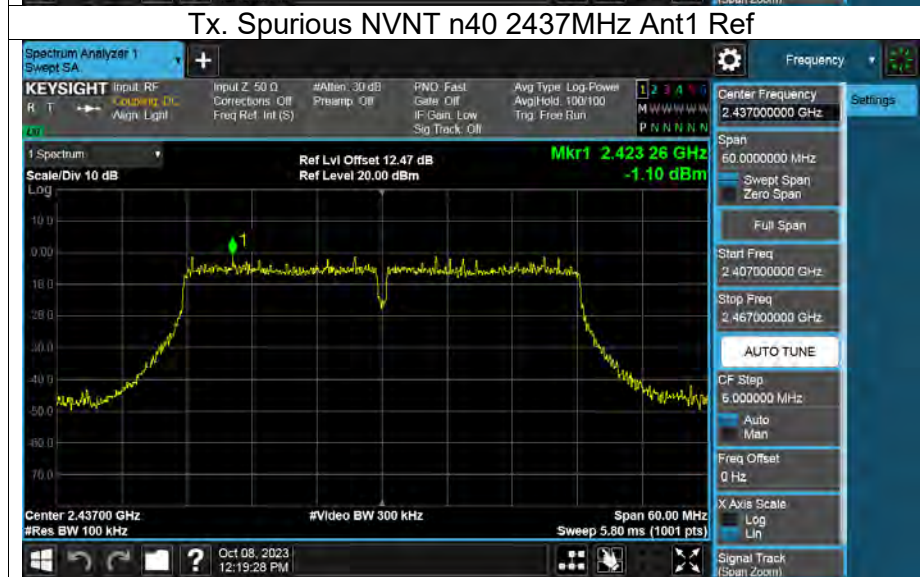
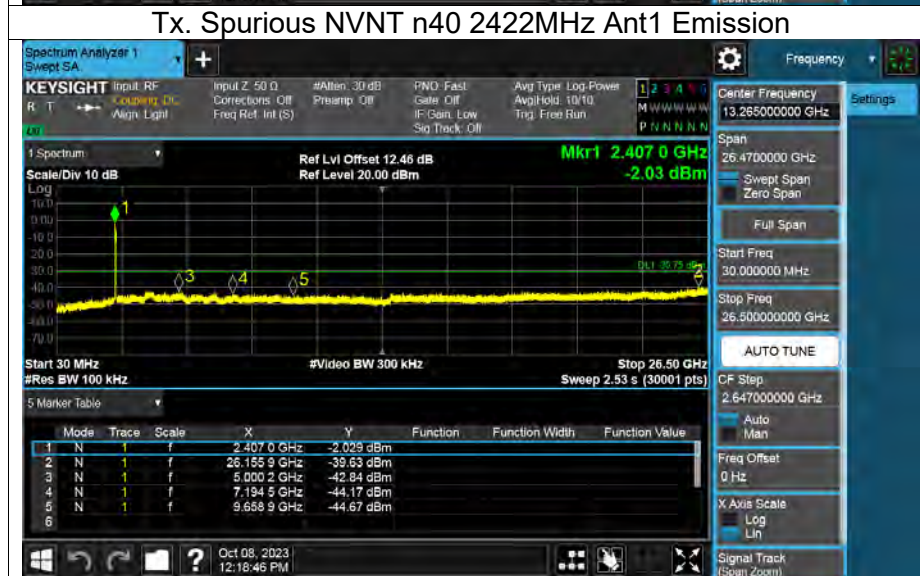
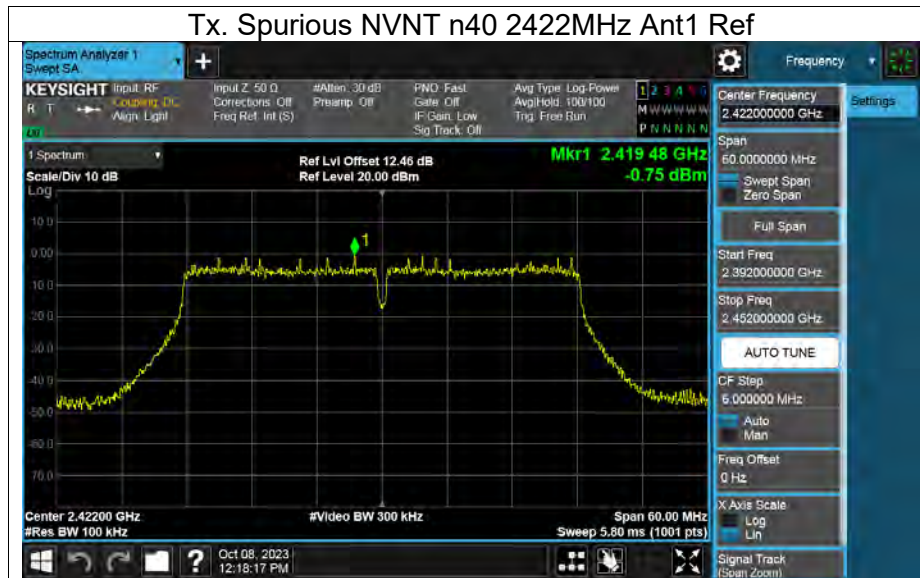

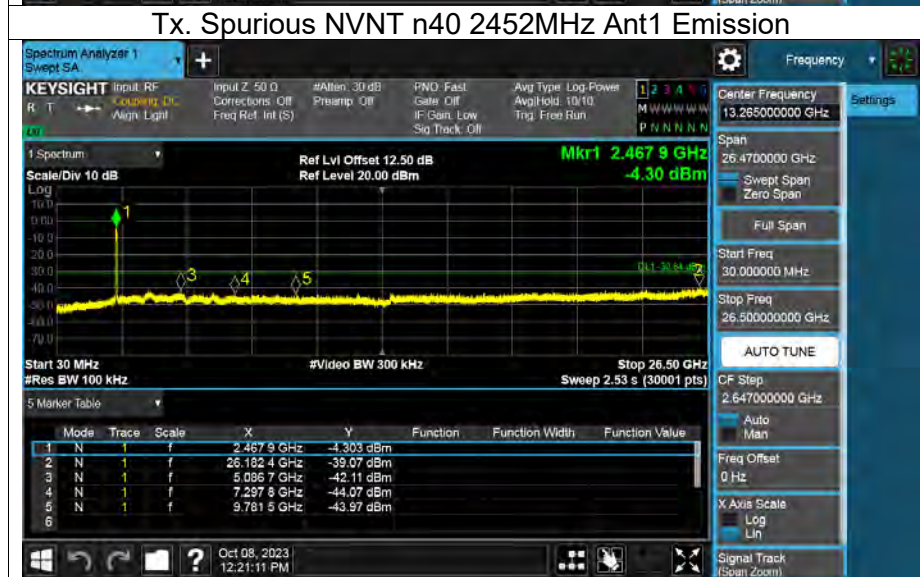
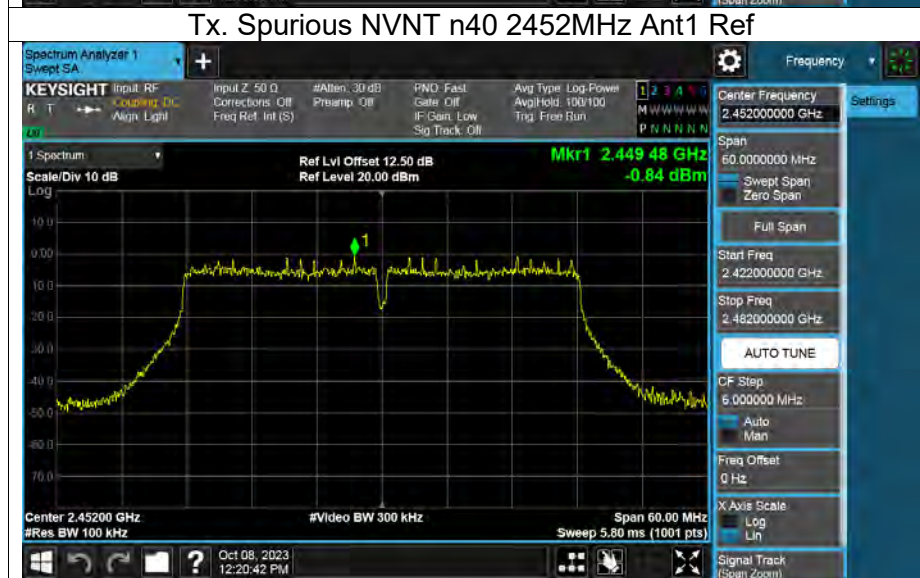
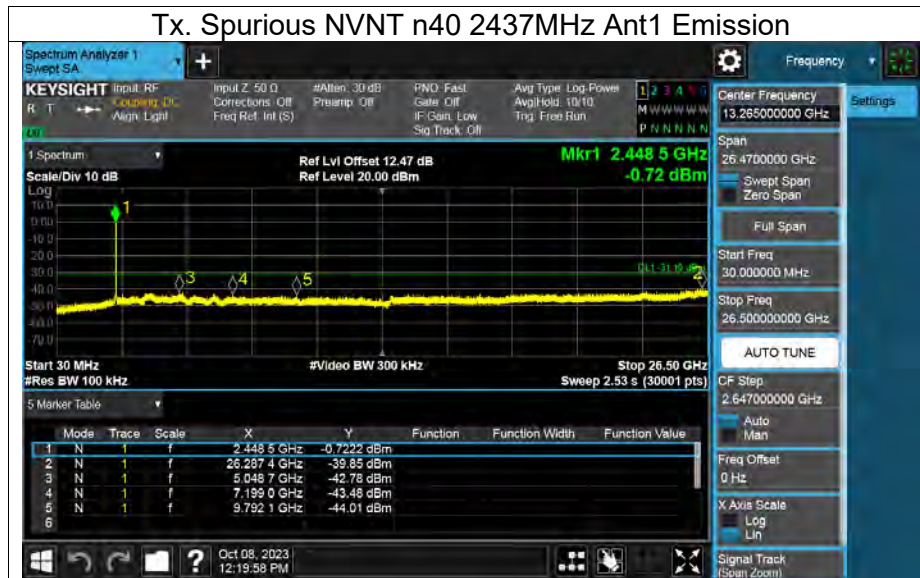

**END OF REPORT**