

FCC REPORT

Applicant: PAX Technology Limited

Address of Applicant: Room 2416, 24/F., Sun Hung Kai Centre, 30 Harbour Road, Wanchai, Hong Kong

Equipment Under Test (EUT)

Product Name: POS Terminal

Model No.: Q25

Trade mark: PAX

FCC ID: V5PQ25LR

Applicable standards: FCC CFR Title 47 Part 15 Subpart C Section 15.225

Date of sample receipt: 11 Sep., 2020

Date of Test: 12 Sep., to 28 Oct., 2020

Date of report issue: 10 Nov., 2020

Test Result: PASS*

* In the configuration tested, the EUT complied with the standards specified above.

Authorized Signature:



Bruce Zhang
Laboratory Manager

This report details the results of the testing carried out on one sample. The results contained in this test report do not relate to other samples of the same product and does not permit the use of the JYT product certification mark. The manufacturer should ensure that all products in series production are in conformity with the product sample detailed in this report.

This report may only be reproduced and distributed in full. If the product in this report is used in any configuration other than that detailed in the report, the manufacturer must ensure the new system complies with all relevant standards.

This document cannot be reproduced except in full, without prior written approval of the Company. Any unauthorized alteration, forgery or falsification of the content or appearance of this document is unlawful and offenders may be prosecuted to the fullest extent of the law. Unless otherwise stated the results shown in this test report refer only to the sample(s) tested and such sample(s) are retained for 90 days only.

2 Version

Version No.	Date	Description
00	29 Oct., 2020	Original
01	10 Nov., 2020	Update Page 4,5

Tested by: YT Yang
Test Engineer

Date: 10 Nov., 2020

Reviewed by: Winner Zhang
Project Engineer

Date: 10 Nov., 2020

3 Contents

	Page
1 COVER PAGE.....	1
2 VERSION.....	2
3 CONTENTS.....	3
4 TEST SUMMARY.....	4
5 GENERAL INFORMATION.....	5
5.1 CLIENT INFORMATION.....	5
5.2 GENERAL DESCRIPTION OF E.U.T.....	5
5.3 TEST MODE AND TEST SAMPLES PLANS	5
5.4 DESCRIPTION OF SUPPORT UNITS.....	5
5.5 MEASUREMENT UNCERTAINTY.....	6
5.6 ADDITIONS TO, DEVIATIONS, OR EXCLUSIONS FROM THE METHOD.....	6
5.7 LABORATORY FACILITY.....	6
5.8 LABORATORY LOCATION	6
5.9 TEST INSTRUMENTSLIST.....	7
6 TEST RESULTS AND MEASUREMENT DATA.....	8
6.1 ANTENNA REQUIREMENT	8
6.2 RADIATED EMISSION	9
6.3 20dB BANDWIDTH.....	16
6.4 FREQUENCY TOLERANCE.....	18
6.5 CONDUCTED EMISSION	20
7 TEST SETUP PHOTOS.....	23
8 EUT CONSTRUCTIONAL DETAILS	25

4 Test Summary

Test Item	Section in CFR 47	Result
Antenna requirement	15.203	Pass
Field strength of the fundamental signal and Within the bands	15.225 (a)&(b)&(c)	Pass
Spurious emissions	15.225(d)& 15.209	Pass
20dB Bandwidth	15.215(c)	Pass
Frequency tolerance	15.225 (e)	Pass
Conducted Emission	15.207	Pass
<p><i>Remark:</i></p> <ol style="list-style-type: none"> 1. <i>Pass: The EUT complies with the essential requirements in the standard.</i> 2. <i>The cable insertion loss used by "RF Output Power" and other conduction measurement items is 0.5dB (provided by the customer).</i> 		
Test Method:	ANSI C63.4-2014 ANSI C63.10-2013	

5 General Information

5.1 Client Information

Applicant:	PAX Technology Limited
Address:	Room 2416, 24/F., Sun Hung Kai Centre, 30 Harbour Road, Wanchai, Hong Kong
Manufacturer:	PAX Computer Technology (Shenzhen) Co., Ltd.
Address:	4/F, No.3 Building, Software Park, Second Central Science-Tech Road, High-Tech industrial Park, Shenzhen, Guangdong, P. R. C.

5.2 General Description of E.U.T.

Product Name:	POS Terminal
Model No.:	Q25
Operation Frequency:	13.56MHz
Channel numbers:	1
Modulation type:	ASK
Antenna Type:	Induction Coil Antenna
AC adapter:	Model: A18A-050100U-US2 Input: AC100-240V, 50/60Hz, 0.2A Output: DC 5.0V, 1.0A
Test Sample Condition:	The test samples were provided in good working order with no visible defects.

5.3 Test mode and test samples plans

Transmitting mode:	Keep the EUT in transmitting mode with modulation		
Pre-Test Mode:			
JYTSZ has verified the construction and function in typical operation, The EUT was placed on three different polar directions; i.e. X axis, Y axis, Z axis. which was shown in this test report and defined as follows:			
Axis	X	Y	Z
Field Strength(dBuV/m)	61.34	60.55	61.03

5.4 Description of Support Units

Manufacturer	Description	Model	S/N	FCC ID/DoC
LENOVO	LAPTOP	SL510	2847A65	DOC

5.5 Measurement Uncertainty

Parameters	Expanded Uncertainty
Conducted Emission (9kHz ~ 30MHz)	±1.60 dB (k=2)
Radiated Emission (9kHz ~ 30MHz)	±3.12 dB (k=2)
Radiated Emission (30MHz ~ 1000MHz)	±4.32 dB (k=2)

5.6 Additions to, deviations, or exclusions from the method

No

5.7 Laboratory Facility

The test facility is recognized, certified, or accredited by the following organizations:

- **FCC - Designation No.: CN1211**
JianYan Testing Group Shenzhen Co., Ltd. has been accredited as a testing laboratory by FCC(Federal Communications Commission). The test firm Registration No. is 727551.
- **ISED – CAB identifier.: CN0021**
The 3m Semi-anechoic chamber of JianYan Testing Group Shenzhen Co., Ltd. has been Registered by Certification and Engineering Bureau of Industry Canada for radio equipment testing with Registration No.: 10106A-1.
- **A2LA - Registration No.: 4346.01**
This laboratory is accredited in accordance with the recognized International Standard ISO/IEC 17025:2005 General requirements for the competence of testing and calibration laboratories. The test scope can be found as below link: <https://portal.a2la.org/scopepdf/4346-01.pdf>

5.8 Laboratory Location

JianYan Testing Group Shenzhen Co., Ltd.
 Address: No.110~116, Building B, Jinyuan Business Building, Xixiang Road, Bao'an District, Shenzhen, Guangdong, China
 Tel: +86-755-23118282, Fax:+86-755-23116366
 Email: info@ccis-cb.com, Website: <http://www.ccis-cb.com>

5.9 Test Instrumentslist

Radiated Emission:					
Test Equipment	Manufacturer	Model No.	Serial No.	Cal.Date (mm-dd-yy)	Cal. Due date (mm-dd-yy)
3m SAC	SAEMC	9m*6m*6m	966	07-22-2020	07-21-2021
BiConiLog Antenna	SCHWARZBECK	VULB9163	497	03-07-2020	03-06-2021
Biconical Antenna	SCHWARZBECK	VUBA9117	359	06-22-2020	06-21-2021
Horn Antenna	SCHWARZBECK	BBHA9120D	916	03-07-2020	03-06-2021
Horn Antenna	SCHWARZBECK	BBHA9120D	1805	06-22-2020	06-21-2021
Horn Antenna	SCHWARZBECK	BBHA 9170	BBHA9170582	11-18-2019	11-17-2020
Loop Antenna	SCHWARZBECK	FMZB 1519 B	00044	03-07-2020	03-06-2021
EMI Test Software	AUDIX	E3	Version: 6.110919b		
Pre-amplifier	HP	8447D	2944A09358	03-07-2020	03-06-2021
Pre-amplifier	CD	PAP-1G18	11804	03-07-2020	03-06-2021
Spectrum analyzer	Rohde & Schwarz	FSP30	101454	03-07-2020	03-06-2021
Spectrum analyzer	Rohde & Schwarz	FSP40	100363	11-18-2019	11-17-2020
EMI Test Receiver	Rohde & Schwarz	ESRP7	101070	03-07-2020	03-06-2021
Signal Generator	Rohde & Schwarz	SMX	835454/016	03-07-2020	03-06-2021
Signal Generator	R&S	SMR20	1008100050	03-07-2020	03-06-2021
Cable	ZDECL	Z108-NJ-NJ-81	1608458	03-07-2020	03-06-2021
Cable	MICRO-COAX	MFR64639	K10742-5	03-07-2020	03-06-2021
Cable	SUHNER	SUCOFLEX100	58193/4PE	03-07-2020	03-06-2021

Conducted Emission:					
Test Equipment	Manufacturer	Model No.	Serial No.	Cal.Date (mm-dd-yy)	Cal.Due date (mm-dd-yy)
Shielding Room	ZhongShuo Electron	11.0(L)x4.0(W)x3.0(H)	11*4*3	07-22-2020	07-21-2021
EMI Test Receiver	Rohde & Schwarz	ESCI	101189	03-07-2020	03-06-2021
LISN	CHASE	MN2050D	1447	03-07-2020	03-06-2021
LISN	Rohde & Schwarz	ESH3-Z5	843862/010	07-21-2020	07-20-2021
Coaxial Cable	CCIS	N/A	N/A	03-07-2020	03-06-2021
EMI Test Software	AUDIX	E3	Version: 6.110919b		

6 Test results and Measurement Data

6.1 Antenna requirement

Standard requirement:	FCC Part15 C Section 15.203
15.203 requirement: An intentional radiator shall be designed to ensure that no antenna other than that furnished by the responsible party shall be used with the device. The use of a permanently attached antenna or of an antenna that uses a unique coupling to the intentional radiator, the manufacturer may design the unit so that a broken antenna can be replaced by the user, but the use of a standard antenna jack or electrical connector is prohibited.	
E.U.T Antenna:	
The EUT make use of an Induction coil antenna.	

6.2 Radiated Emission

Test Requirement:	FCC Part15 C Section 15.225(a)&(b)&(c) and 15.209				
Test Frequency Range:	9 kHz to 1000MHz				
Test site:	Measurement Distance: 3m(Semi-Anechoic Chamber)				
Receiver setup:	Frequency	Detector	RBW	VBW	Remark
	9kHz-150kHz	Quasi-peak	200Hz	600Hz	Quasi-peak Value
	150kHz-30MHz	Quasi-peak	9kHz	30kHz	Quasi-peak Value
	30MHz-1GHz	Quasi-peak	120kHz	300KHz	Quasi-peak Value
	Above 1GHz	Peak	1MHz	3MHz	Peak Value
Limit: (Field strength of the fundamental signal)	Frequency	Limit (uV/m @30m)		Limit (dBuV/m @3m)	
	13.553MHz-13.567MHz	15848		124.0	
	13.410MHz-13.553MHz & 13.567MHz-13.710MHz	334		90.5	
	13.110MHz-13.410MHz & 13.710MHz-14.010MHz	106		80.5	
Remark: Per FCC part 15.31, when performing measurements at a distance which is closer than specified, the field strength results shall be extrapolated to the specified distance by using the square of an inverse linear distance extrapolation factor (i.e., 40 dB/decade) in conjunction with the slant-range distance defined in §15.3(hh) of this part.					
Limit: (Spurious Emissions)	Frequency (MHz)	Limit (uV/m @3m)		Distance (m)	
	0.009-0.490	2400/F(kHz)		300	
	0.490-1.705	24000/F(kHz)		30	
	1.705-30	30		30	
	30-88	100		3	
	88-216	150		3	
	216-960	200		3	
	Above 1GHz	500		3	
Test Procedure:	<p>a. The EUT was placed on the top of a rotating table 0.8 meters above the ground at a 3 meter semi-anechoic chamber. The table was rotated 360 degrees to determine the position of the highest radiation.</p> <p>b. The EUT was set 3 meters away from the interference-receiving antenna, which was mounted on the top of a variable-height antenna tower.</p> <p>c. The antenna height is varied from one meter to four meters above the ground to determine the maximum value of the field strength. Both horizontal and vertical polarizations of the antenna are set to make the measurement.</p> <p>d. For each suspected emission, the EUT was arranged to its worst case and then the antenna was tuned to heights from 1 meter to 4 meters and the rotating table was turned from 0 degrees to 360 degrees to find the maximum reading.</p> <p>e. The test-receiver system was set to Peak Detect Function and Specified Bandwidth with Maximum Hold Mode.</p> <p>f. If the emission level of the EUT in peak mode was 10dB lower than the limit specified, then testing could be stopped and the peak values of the EUT would be reported. Otherwise the emissions that did not have 10dB margin would be re-tested one by one using peak, quasi-peak or average method as specified and then reported in a data sheet.</p>				
Test setup:	9kHz-30MHz				

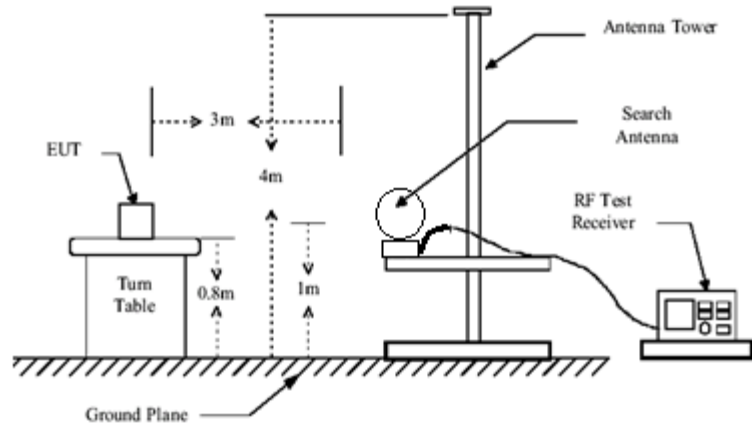

30MHz-1GHz

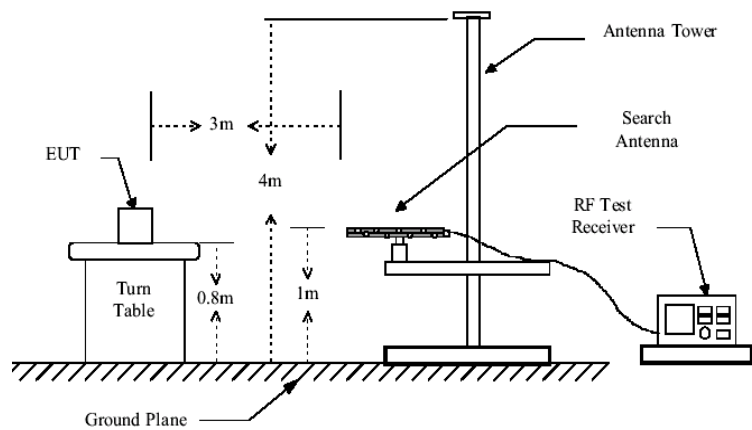

Above 1GHz

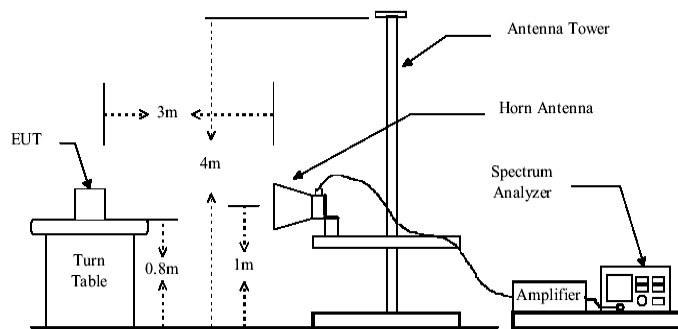

Test Instruments:	Refer to section 5.9 for details
Test mode:	Refer to section 5.3 for details
Test results:	Pass

Measurement Data:

Field Strength of fundamental signal and Within the bands:

Product Name:	POS Terminal	Product Model:	Q25
Test By:	YT	Test mode:	NFC Tx mode
Test Voltage:	AC 120/60Hz	Environment:	Temp: 24°C Humi: 57%

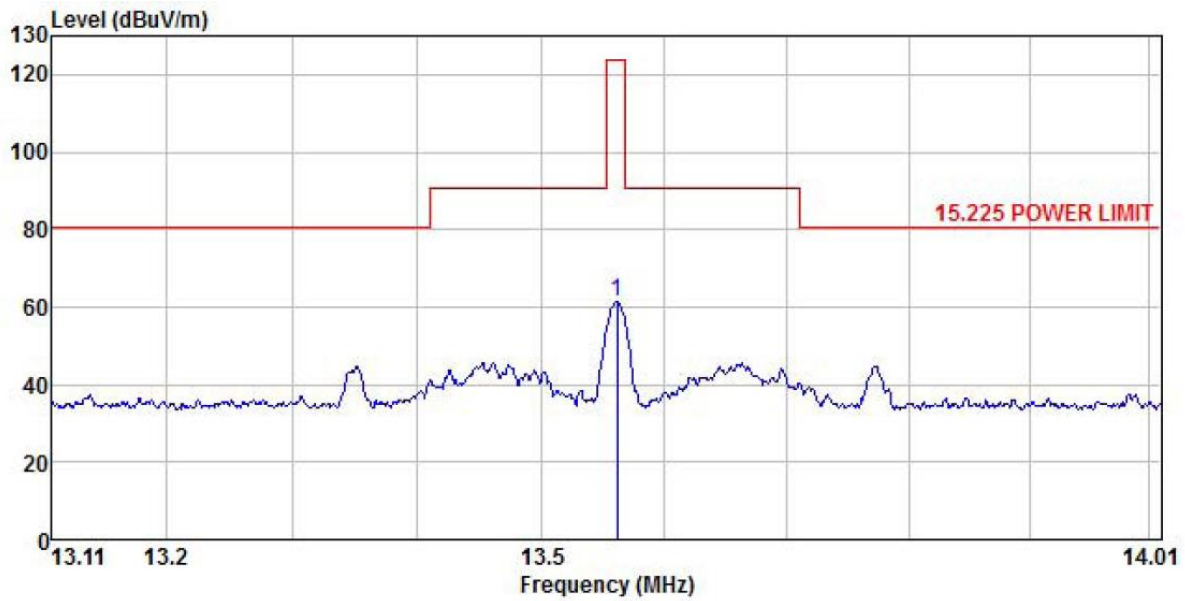

	Freq	ReadAntenna	Cable	Aux	Preamp	Level	Limit	Over	Remark
	MHz	Level	Factor	Loss	Factor	Factor	Line	Limit	
		dBuV	dB/m	dB	dB	dB	dBuV/m	dBuV/m	dB
1	13.562	41.34	19.59	0.41	0.00	0.00	61.34	124.00	-62.66

Remark:

1. Final Level = Receiver Read level + Antenna Factor + Cable Loss – Preamplifier Factor.

Spurious Emissions:

Test frequency range: 9 kHz- 30 MHz

Product Name:	POS Terminal	Product Model:	Q25
Test By:	YT	Test mode:	NFC Tx mode
Test Frequency:	150 kHz ~ 30 MHz	Polarization:	Vertical
Test Voltage:	AC 120/60Hz	Environment:	Temp: 24°C Huni: 57%

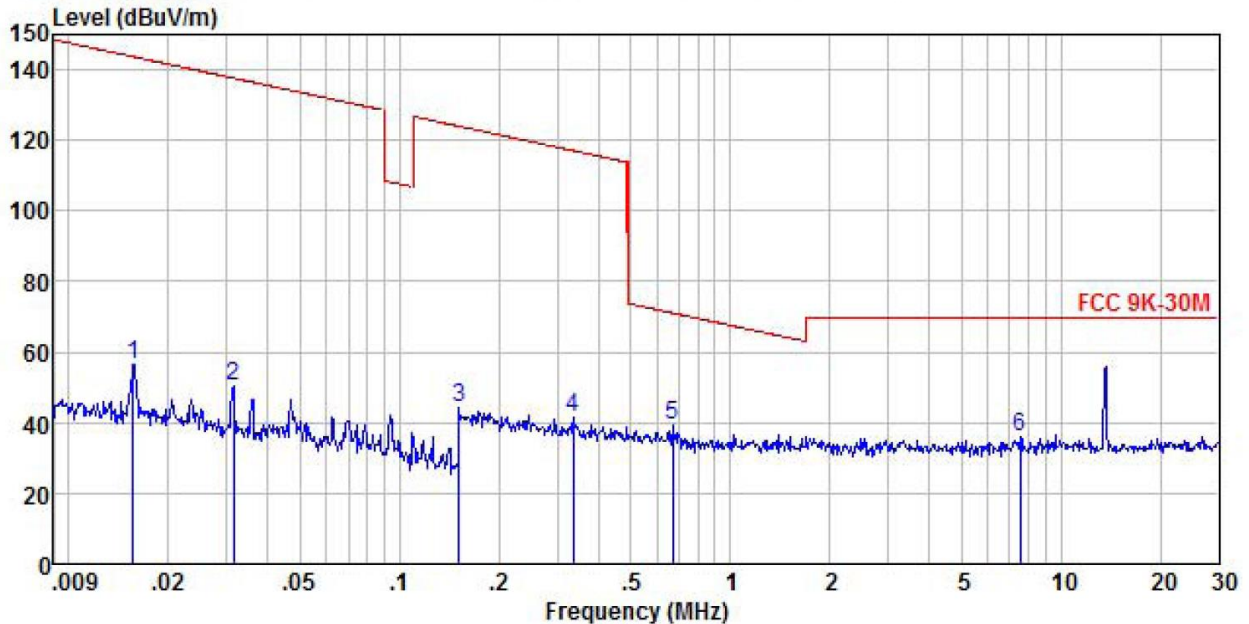

	Read	Antenna	Cable	Aux	Preamp	Limit	Over		
Freq	Level	Factor	Loss	Factor	Factor	Line	Limit	Remark	
MHz	dBuV	dB/m	dB	dB	dB	dBuV/m	dBuV/m	dB	
1	0.016	35.98	20.38	0.01	0.00	0.00	56.37	143.71	-87.34 Peak
2	0.031	29.94	20.24	0.02	0.00	0.00	50.20	137.65	-87.45 Peak
3	0.151	24.14	20.20	0.03	0.00	0.00	44.37	124.02	-79.65 Peak
4	0.335	20.87	20.60	0.06	0.00	0.00	41.53	117.10	-75.57 Peak
5	0.668	18.32	20.67	0.09	0.00	0.00	39.08	71.11	-32.03 Peak
6	7.555	15.59	20.16	0.33	0.00	0.00	36.08	69.50	-33.42 Peak

Remark:

1. Final Level = Receiver Read level + Antenna Factor + Cable Loss – Pre-amplifier Factor.
2. The Aux Factor is a notch filter switch box loss, this item is not used.

Product Name:	POS Terminal	Product Model:	Q25
Test By:	YT	Test mode:	NFC Tx mode
Test Frequency:	150 kHz ~ 30 MHz	Polarization:	Horizontal
Test Voltage:	AC 120/60Hz	Environment:	Temp: 24°C Huni: 57%

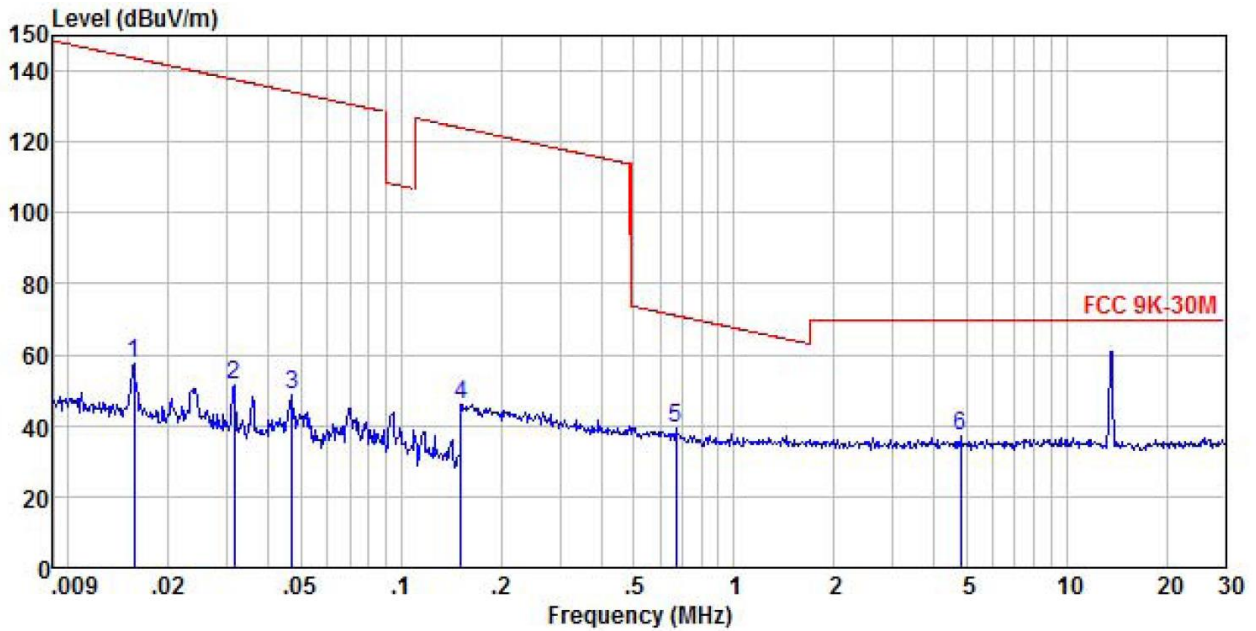

	ReadAntenna	Cable	Aux	Preamp	Limit	Over			
Freq	Level	Factor	Loss	Factor	Factor	Level	Line	Limit	Remark
MHz	dBuV	dB/m	dB	dB	dB	dBuV/m	dBuV/m	dB	
1	0.016	37.01	20.38	0.01	0.00	0.00	57.40	143.64	-86.24 Peak
2	0.031	31.20	20.24	0.02	0.00	0.00	51.46	137.65	-86.19 Peak
3	0.047	28.28	20.56	0.02	0.00	0.00	48.86	134.13	-85.27 Peak
4	0.151	25.56	20.20	0.03	0.00	0.00	45.79	124.02	-78.23 Peak
5	0.668	18.32	20.67	0.09	0.00	0.00	39.08	71.11	-32.03 Peak
6	4.797	16.72	20.12	0.28	0.00	0.00	37.12	69.50	-32.38 Peak

Remark:

- Final Level = Receiver Read level + Antenna Factor + Cable Loss – Pre-amplifier Factor.
- The Aux Factor is a notch filter switch box loss, this item is not used.

Test frequency range: 30MHz-1000MHz

Product Name:	POS Terminal	Product Model:	Q25
Test By:	YT	Test mode:	NFC Tx mode
Test Frequency:	30 MHz ~ 1 GHz	Polarization:	Vertical
Test Voltage:	AC 120/60Hz	Environment:	Temp: 24°C Humi: 57%

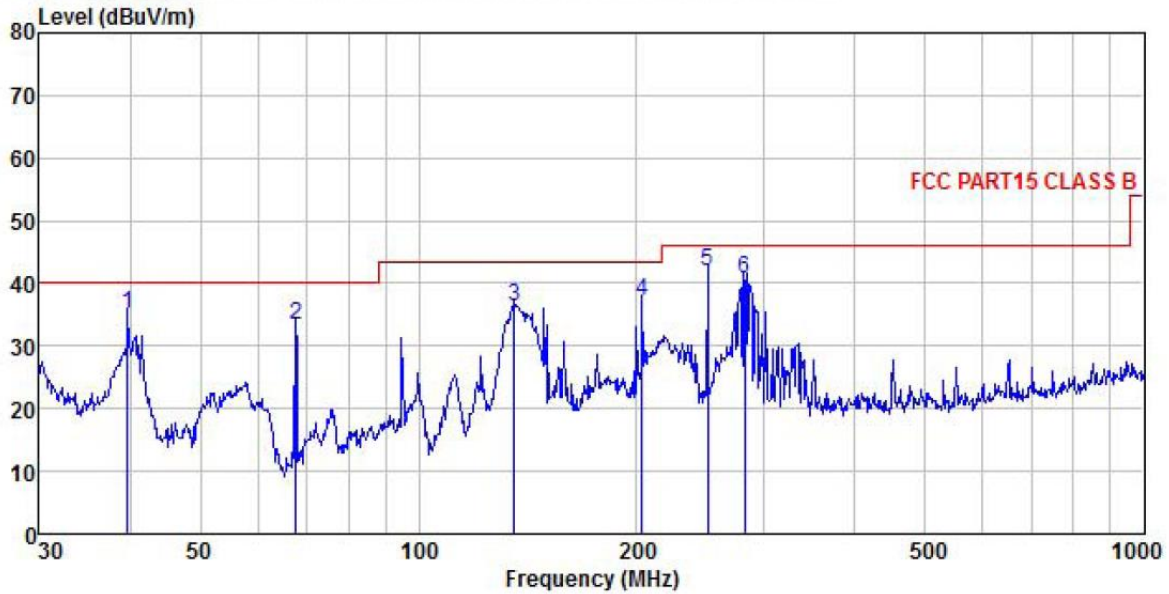

	Read	Antenna	Cable	Aux	Preamp	Level	Limit	Over	Remark
Freq	Level	Factor	Loss	Factor	Factor	Level	Line	Limit	
MHz	dBuV	dB/m	dB	dB	dB	dBuV/m	dBuV/m	dB	
1	39.715	51.79	12.79	0.35	0.00	29.90	35.03	40.00	-4.97 QP
2	67.675	52.77	9.96	0.44	0.00	29.74	33.43	40.00	-6.57 QP
3	135.506	51.58	13.53	0.59	0.00	29.30	36.40	43.50	-7.10 QP
4	203.523	46.97	18.32	0.72	0.00	28.81	37.20	43.50	-6.30 QP
5	250.301	51.19	18.50	0.78	0.00	28.54	41.93	46.00	-4.07 QP
6	281.995	49.79	18.63	0.84	0.00	28.48	40.78	46.00	-5.22 QP

Remark:

1. Final Level = Receiver Read level + Antenna Factor + Cable Loss – Pre-amplifier Factor.
2. The emission levels of other frequencies are very lower than the limit and not show in test report.
3. The Aux Factor is a notch filter switch box loss, this item is not used.

Product Name:	POS Terminal	Product Model:	Q25
Test By:	YT	Test mode:	NFC Tx mode
Test Frequency:	30 MHz ~ 1 GHz	Polarization:	Horizontal
Test Voltage:	AC 120/60Hz	Environment:	Temp: 24°C Huni: 57%

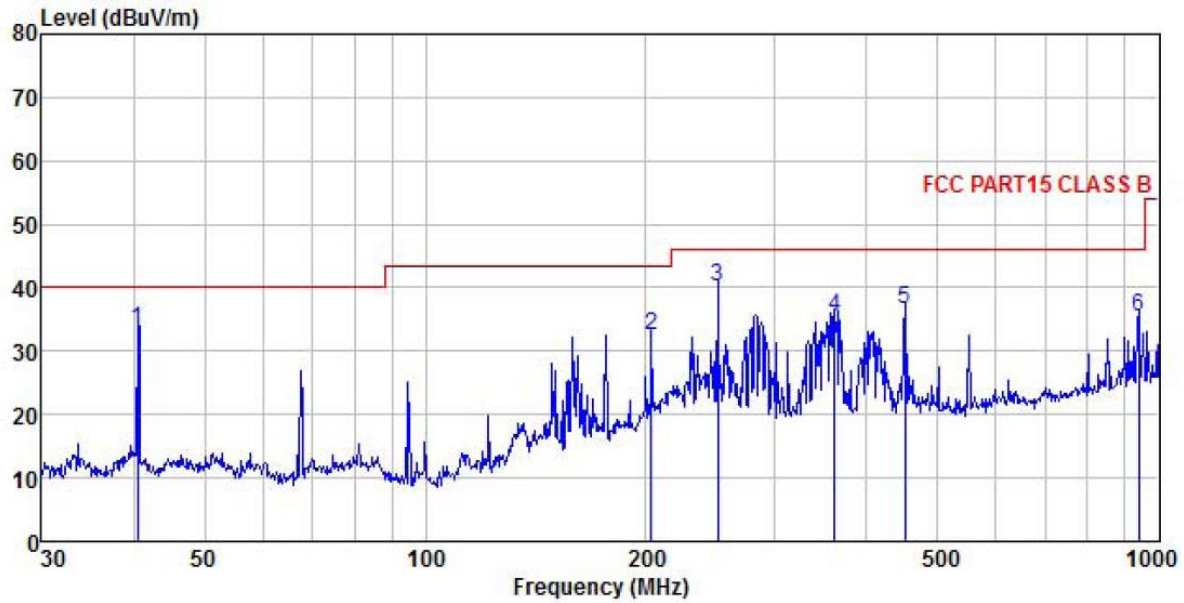

	ReadAntenna	Cable	Aux Preamp	Limit	Over					
Freq	Level	Factor	Loss	Factor	Factor	Level				
-----	-----	-----	-----	-----	-----	-----				
MHz	dBuV	dB/m	dB	dB	dB	dBuV/m				
-----	-----	-----	-----	-----	-----	-----				
1	40.559	49.96	12.81	0.35	0.00	29.90	33.22	40.00	-6.78	QP
2	203.523	42.29	18.32	0.72	0.00	28.81	32.52	43.50	-10.98	QP
3	250.301	49.27	18.50	0.78	0.00	28.54	40.01	46.00	-5.99	QP
4	361.714	44.29	18.87	0.94	0.00	28.61	35.49	46.00	-10.51	QP
5	451.135	45.32	19.21	1.05	0.00	28.87	36.71	46.00	-9.29	QP
6	938.833	38.80	22.76	1.54	0.00	27.76	35.34	46.00	-10.66	QP

Remark:

1. Final Level = Receiver Read level + Antenna Factor + Cable Loss – Pre-amplifier Factor.
2. The emission levels of other frequencies are very lower than the limit and not show in test report.
3. The Aux Factor is a notch filter switch box loss, this item is not used.

6.3 20dB Bandwidth

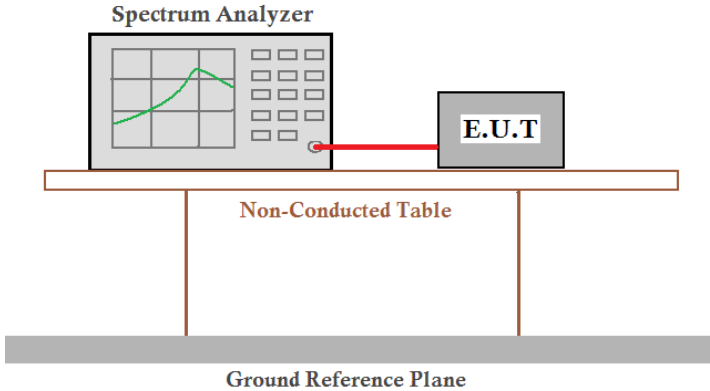
Test Requirement:	FCC Part15 C Section 15.215 (c)
Receiver setup:	RBW=200Hz, VBW=300Hz, detector: Peak
Limit:	The fundamental emission be kept within at least the central 80% of the permitted band
Test Procedure:	<ol style="list-style-type: none"> 1. According to the follow Test-setup, keep the relative position between the artificial antenna and the EUT. 2. Set the EUT to proper test channel. 3. Max hold the radiated emissions, mark the peak power frequency point and the -20dB upper and lower frequency points. 4. Read 20dB bandwidth.
Test setup:	 <p>The diagram illustrates the test setup. A Spectrum Analyzer is connected via a red cable to an E.U.T. (Equipment Under Test). Both are placed on a Non-Conducted Table. Below the table is a Ground Reference Plane.</p>
Test Instruments:	Refer to section 5.9 for details
Test mode:	Refer to section 5.3 for details
Test results:	Passed

Measurement Data

20dB bandwidth (kHz)	Limit (kHz)	Results
0.49	11.2	Passed
<i>Note: For 13.56MHz, permitted Band is 14 kHz, so the Limit is 11.2 kHz.</i>		

Test plot as follows:

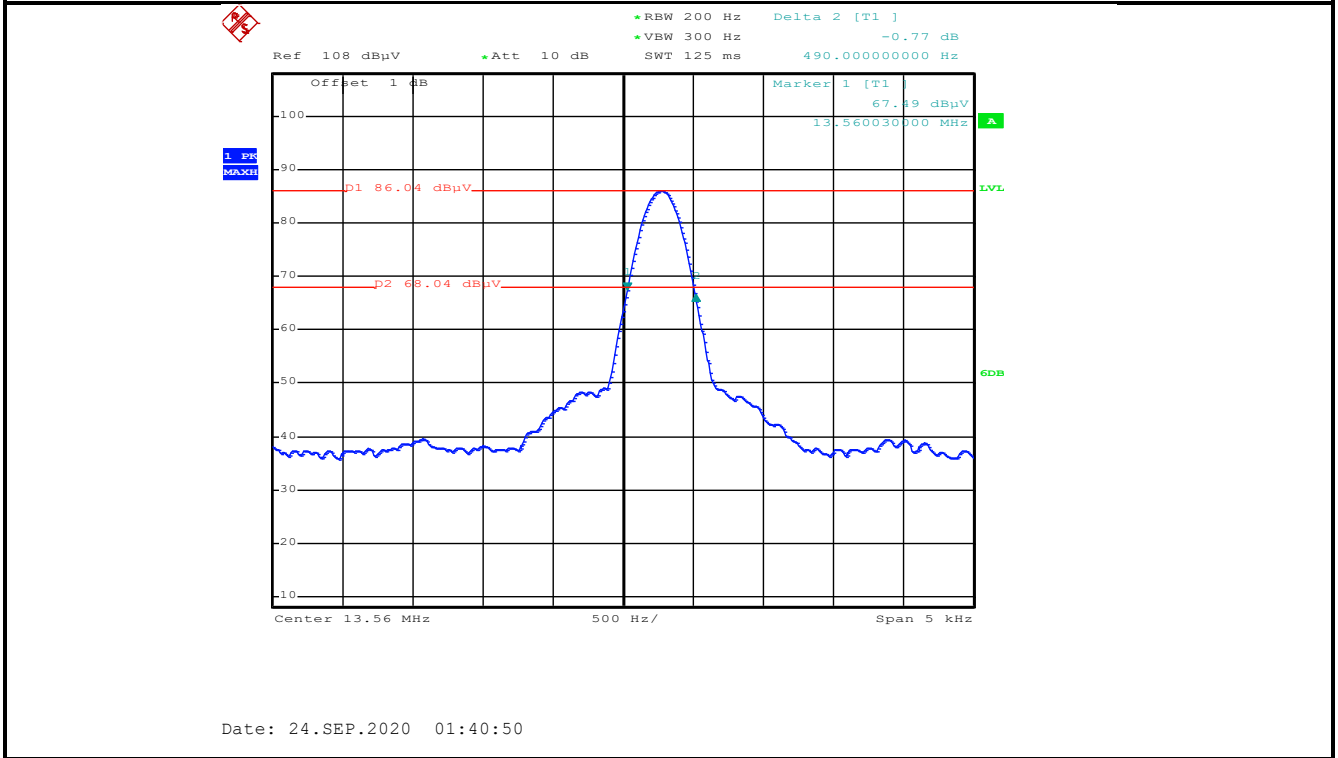

6.4 Frequency Tolerance

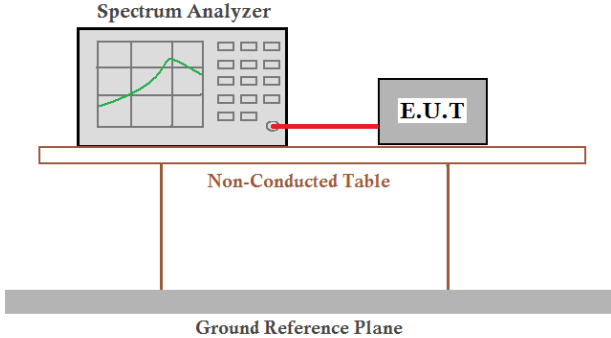
Test Requirement:	FCC Part15 C Section 15.225 (e)
Receiver setup:	RBW=200Hz, VBW=300Hz, span=14kHz, detector: Peak
Limit:	±0.01% of the operating frequency
Test mode:	Transmitting mode
Test Procedure:	<p>Frequency stability V.S. Temperature measurement</p> <ol style="list-style-type: none"> 1. The equipment under test was powered by a fresh battery. 2. RF output was connected to spectrum analyzer via feed through attenuators. 3. The EUT was placed inside the temperature chamber. 4. Set the spectrum analyzer RBW low enough to obtain the desired frequency resolution and measure EUT 20°C operating frequency as reference frequency. 5. Turn EUT off and set the chamber temperature to -20°C. After the temperature stabilized for approximately 30 minutes recorded the frequency. 6. Repeat step measure with 10°C increased per stage until the highest temperature of +50°C reached <p>Frequency stability V.S. Voltage measurement</p> <ol style="list-style-type: none"> 1. Set chamber temperature to 25°C. Use a variable DC power source to power the EUT and set the voltage to rated voltage. 2. Set the spectrum analyzer RBW low enough to obtain the desired frequency resolution and recorded the frequency. <p>Reduce the input voltage to specify extreme voltage variation (+/- 15%) and endpoint, record the maximum frequency change.</p>
Test setup:	 <p>The diagram illustrates the test setup. A Spectrum Analyzer is connected to an E.U.T. (Equipment Under Test) via a red cable. Both are placed on a Non-Conducted Table. Below the table is a Ground Reference Plane.</p>
Test Instruments:	Refer to section 5.9 for details
Test mode:	Refer to section 5.3 for details
Test results:	Passed

Measurement Data:

a) Frequency stability V.S. Temperature measurement

Voltage (Vdc)	Temperature (°C)	Frequency Tolerance (MHz)	Frequency Error (%)	Limit (%)	Results
5.0	-20	0.075	0.0054	±0.01	Pass
	-10	0.083	0.0061	±0.01	Pass
	0	-0.071	-0.0053	±0.01	Pass
	+10	0.081	0.0055	±0.01	Pass
	+20	-0.065	-0.0047	±0.01	Pass
	+30	0.082	0.0061	±0.01	Pass
	+40	0.065	0.0043	±0.01	Pass
	+50	-0.035	-0.0025	±0.01	Pass

b) Frequency stability V.S. Voltage measurement

Temperature (°C)	Voltage (Vdc)	Frequency Tolerance (MHz)	Frequency Error (%)	Limit (%)	Results
25.0	4.5	-0.081	-0.0061	±0.01	Pass
	5.0	0.069	0.0049	±0.01	Pass
	5.5	0.089	0.0062	±0.01	Pass

6.5 Conducted Emission

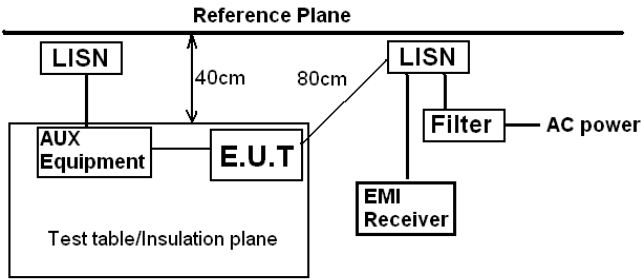
Test Requirement:	FCC Part15 B Section 15.207														
TestFrequencyRange:	150kHz to 30MHz														
Class / Severity:	Class B														
Receiver setup:	RBW=9kHz, VBW=30kHz														
Limit:	<table border="1"> <thead> <tr> <th rowspan="2">Frequency range (MHz)</th> <th colspan="2">Limit (dBμV)</th> </tr> <tr> <th>Quasi-peak</th> <th>Average</th> </tr> </thead> <tbody> <tr> <td>0.15-0.5</td> <td>66 to 56*</td> <td>56 to 46*</td> </tr> <tr> <td>0.5-5</td> <td>56</td> <td>46</td> </tr> <tr> <td>0.5-30</td> <td>60</td> <td>50</td> </tr> </tbody> </table>	Frequency range (MHz)	Limit (dB μ V)		Quasi-peak	Average	0.15-0.5	66 to 56*	56 to 46*	0.5-5	56	46	0.5-30	60	50
	Frequency range (MHz)		Limit (dB μ V)												
		Quasi-peak	Average												
	0.15-0.5	66 to 56*	56 to 46*												
	0.5-5	56	46												
0.5-30	60	50													
* Decreases with the logarithm of the frequency.															
Test setup:	 <p>Remark: E.U.T: Equipment Under Test LISN: Line Impedance Stabilization Network Test table height=0.8m</p>														
Test procedure	<ol style="list-style-type: none"> 1. The E.U.T and simulators are connected to the main power through a line impedance stabilization network (L.I.S.N.).It provide a 50ohm/50uH coupling impedance for the measuring equipment. 2. The peripheral devices are also connected to the main power through a LISN that provides a 50ohm/50uH coupling impedance with 50ohm termination. (Please refer to the block diagram of the test setup and photographs). 3. Both sides of A.C. line are checked for maximum conducted interference. In order to find the maximum emission, the relative positions of equipment and all of the interface cables must be changed according to ANSI C63.4: 2014 on conducted measurement. 														
Test Instruments:	Refer to section 5.9 for details														
Test mode:	Refer to section 5.3 for details														
Test results:	Pass														

Measurement Data:

Product name:	POS Terminal	Product model:	Q25
Test by:	YT	Test mode:	NFC Tx mode
Test frequency:	150 kHz ~ 30 MHz	Phase:	Line
Test voltage:	AC 120 V/60 Hz	Environment:	Temp: 22.5°C Humi: 55%

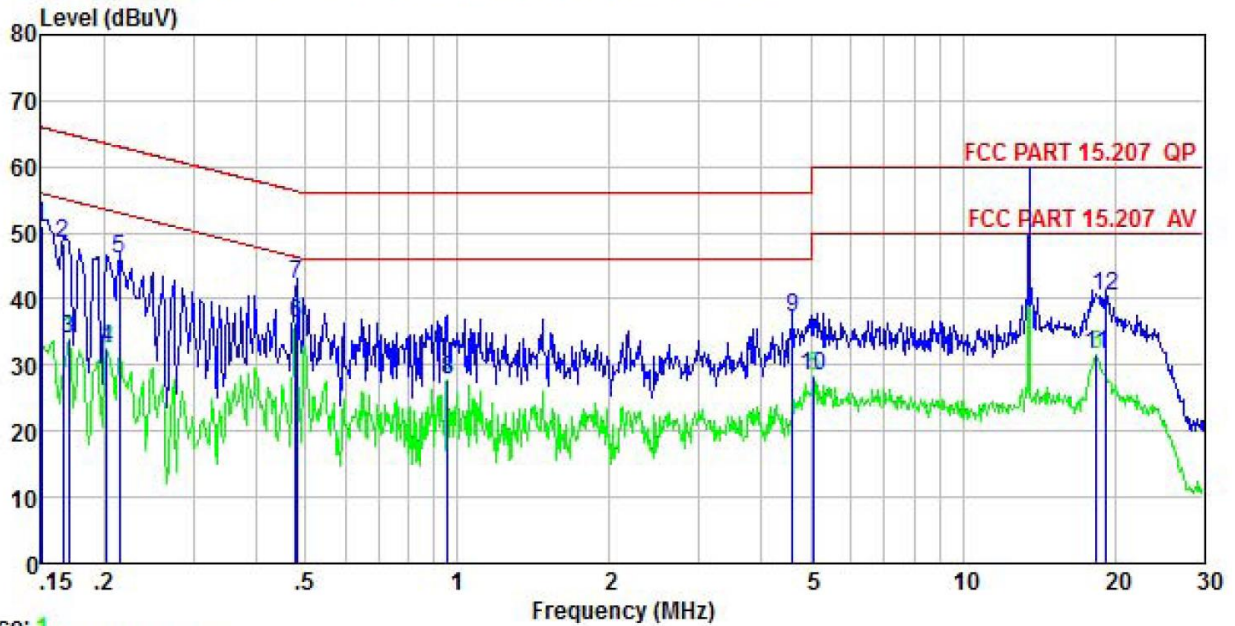

Trace: 1

	Freq	Read Level	LISN Factor	Aux Factor	Cable Loss	Level	Limit Line	Over Limit	Remark
	MHz	dBuV	dB	dB	dB	dBuV	dBuV	dB	
1	0.150	40.76	-0.57	-0.05	10.78	50.92	66.00	-15.08	QP
2	0.166	38.22	-0.58	-0.09	10.77	48.32	65.16	-16.84	QP
3	0.170	23.89	-0.58	-0.10	10.77	33.98	54.94	-20.96	Average
4	0.202	22.46	-0.59	-0.16	10.76	32.47	53.54	-21.07	Average
5	0.214	36.14	-0.58	-0.18	10.76	46.14	63.05	-16.91	QP
6	0.479	26.07	-0.44	-0.21	10.75	36.17	46.36	-10.19	Average
7	0.481	32.09	-0.44	-0.24	10.75	42.16	56.32	-14.16	QP
8	0.958	17.15	-0.61	0.34	10.86	27.74	46.00	-18.26	Average
9	4.598	26.82	-0.40	0.03	10.86	37.31	56.00	-18.69	QP
10	5.085	17.70	-0.40	0.14	10.85	28.29	50.00	-21.71	Average
11	18.426	19.79	-0.82	1.67	10.92	31.56	50.00	-18.44	Average
12	19.122	28.98	-0.84	1.36	10.92	40.42	60.00	-19.58	QP

Notes:

1. An initial pre-scan was performed on the line and neutral lines with peak detector.
2. Quasi-Peak and Average measurement were performed at the frequencies with maximized peak emission.
3. Final Level = Receiver Read level + LISN Factor + Cable Loss.

Product name:	POS Terminal	Product model:	Q25
Test by:	YT	Test mode:	NFC Tx mode
Test frequency:	150 kHz ~ 30 MHz	Phase:	Neutral
Test voltage:	AC 120 V/60 Hz	Environment:	Temp: 22.5°C Huni: 55%

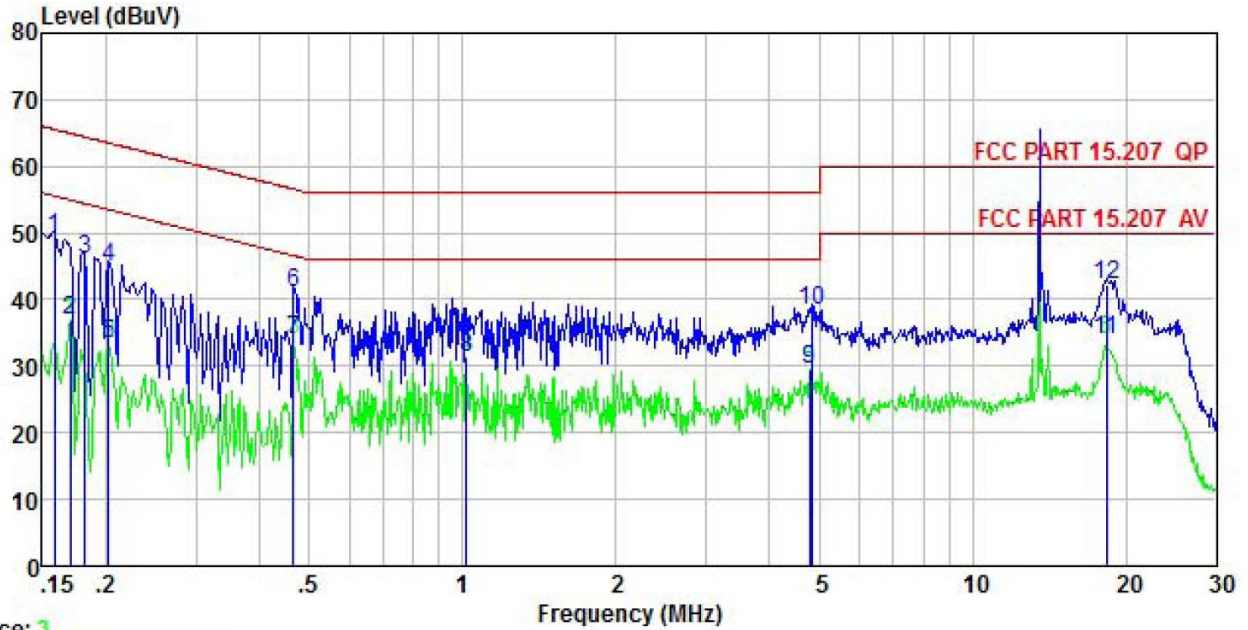

Trace: 3

	Read Freq	Read Level	LISN Factor	Aux Factor	Cable Loss	Level	Limit Line	Over Limit	Remark
	MHz	dBuV	dB	dB	dB	dBuV	dBuV	dB	
1	0.158	39.33	-0.69	0.01	10.77	49.42	65.56	-16.14	QP
2	0.170	26.85	-0.68	0.01	10.77	36.95	54.94	-17.99	Average
3	0.182	36.03	-0.68	0.00	10.77	46.12	64.42	-18.30	QP
4	0.202	34.72	-0.67	0.00	10.76	44.81	63.54	-18.73	QP
5	0.202	23.13	-0.67	0.00	10.76	33.22	53.54	-20.32	Average
6	0.466	31.04	-0.64	0.00	10.75	41.15	56.58	-15.43	QP
7	0.466	23.91	-0.64	0.00	10.75	34.02	46.58	-12.56	Average
8	1.016	20.94	-0.68	0.08	10.87	31.21	46.00	-14.79	Average
9	4.797	18.59	-0.64	0.64	10.86	29.45	46.00	-16.55	Average
10	4.822	27.51	-0.64	0.65	10.86	38.38	56.00	-17.62	QP
11	18.328	23.00	-1.13	1.14	10.92	33.93	50.00	-16.07	Average
12	18.426	31.40	-1.15	1.06	10.92	42.23	60.00	-17.77	QP

Notes:

1. An initial pre-scan was performed on the line and neutral lines with peak detector.
2. Quasi-Peak and Average measurement were performed at the frequencies with maximized peak emission.
3. Final Level = Receiver Read level + LISN Factor + Cable Loss.