

Product Description

1

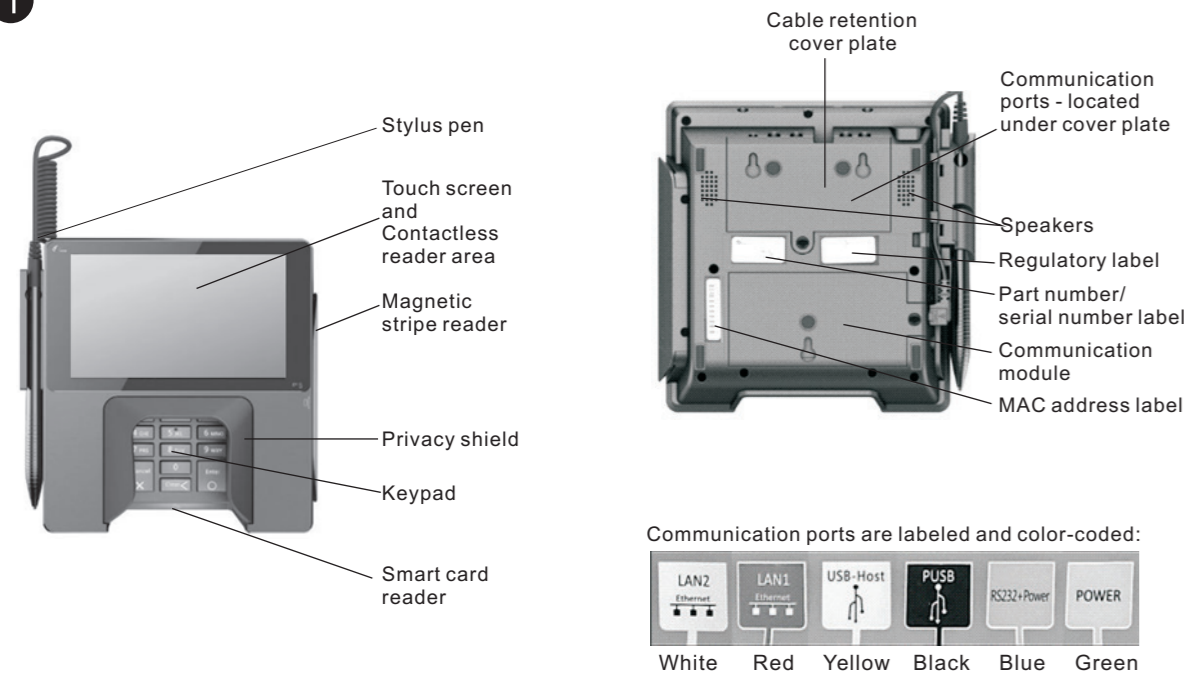

1

Communication Module

2

P* terminals that include a default communication module come standard with one Ethernet port and RS232, USB, and PUSB network capabilities. However, if the default communication module is replaced with an optional communication module, your choice of these additional network capabilities are available:

- A second Ethernet port
- Power over Ethernet
- An Ethernet hub
- Wi-Fi and Bluetooth LE
- Wi-Fi and Cellular GSM

The communication module is located on the underside of the terminal.

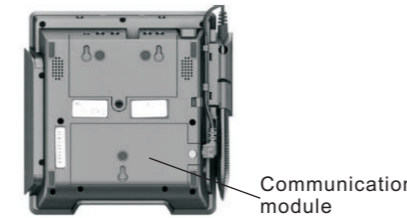

WARNING:

Power down and remove all power from the terminal before removing or installing a communication module. A communication module must be installed before power can be applied to the terminal.

2

Power Connections

3

Power can be supplied via the power port or a single data cable that carries power. This power can be provided via a "powered cable" where the connected POS terminal provides the power (i.e. PUSB or Power over Ethernet) or by connecting a P* power supply directly to the data cable (i.e. RS232 or USB).

1) Power Port

Insert the power connector into the green POWER port. Turn the power connector, locking the tab behind the short plastic wall. Dress the cable through the retention clips. A separate data cable is also required.

2) POS Cable

Insert the cable connector into the appropriate port on the terminal. Dress the cable through the retention clips opposite the port. Connect power supply to cable as required. The cash register could also supply power to terminal.

3) Power over Ethernet (PoE)

Power is available over the red LAN1 port when the optional PoE communication module is installed.

Cable Retention Cover Plate

After power and data cables are connected and dressed through retention clips, install the cable retention cover plate and secure with captive screw.



Working Environment: Temperature -10°C ~ 50°C (14°F ~ 122°F)
R.H.: 10% ~ 93% (non-condensing)
Storage Environment: Temperature -20°C ~ 60°C (-4°F ~ 140°F)
R.H.: 5% ~ 95% (non-condensing)

3

Stylus Holder and Pen

4

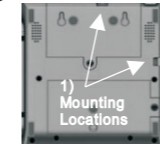

1) Align stylus holder over metal screw openings at left side or top of terminal. Insert tabs into indentations along edge. Attach with captive screws.

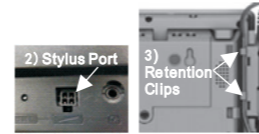

2) Insert connector end of stylus pen into stylus port on left side of terminal.
3) Use enclosed plastic card to press stylus cord into retention clips on left side of terminal.

Privacy Shield

5

Insert tabs and snap shield firmly in place to left and right of keypad. Not designed to be removable. Removing the shield breaks the retention tabs and the ability to remotely track the status of the shield is lost.

Decorative Plug - If a privacy shield is not installed, a non-removable decorative plug may be installed in its place. This plug does not provide any PIN entry privacy.



Privacy Shield



Decorative Plug

4

Plugs

6

1) Stylus Holder Plug

If required, to prevent stylus pen from being inserted vertically into stylus holder, firmly insert plug into opening in holder, aligning with curve of stylus holder.

2) Smart Card Reader Plug

If required, insert smart card reader plug into smart card receptacle slot. To remove, if required, gently pry out the plug using a small screwdriver in the slit along top of plug.

3) Ethernet Plug

An Ethernet plug is included in case you want to block an inactive LAN port. Align plug so that it matches the shape of the port and gently push into opening. To remove, if required, gently pry off using a small screwdriver in the slit along the top of the plug.

Note: LAN2 port is enabled only when Ethernet hub or PoE and Ethernet hub communication module is installed.



5

Reset Button and Audio Jack

7

If required, restart the terminal by pressing in and holding the reset button for 2-3 seconds

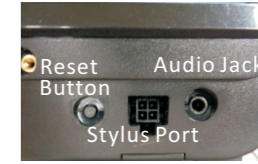

If required, a visually disabled person can connect a headphone to the terminal for audio prompting using the 3.5mm output audio jack.

Cable Lock

8

If required, insert customer-provided cable lock into K-Slot®. Loop cable around permanent object to secure in place.

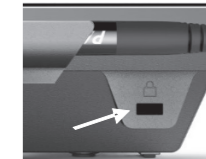

6

Stand Installation

9

If required, the P* terminal may be mounted to a stand. Instructions may vary depending on stand specifications.

Carefully route the required cables up through the stand pipe and out the top. Connect the cables to the P* terminal ports.

Insert the three mounting slots on the underside of the terminal into the three metal prongs on the stand base.

Slide the terminal firmly into position, locking the terminal in place on the stand. Secure with fastening screw or locking device as required.

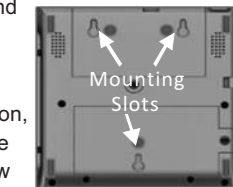
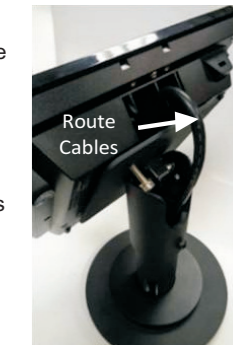

7



PAX Technology Inc.
 4901 Belfort Road, Suite 130
 Jacksonville, FL 32256, USA
 T: 877-859-0099
 W: www.pax.us
 E: sales@pax.us

This document is provided to you for informational purposes only. All features and specifications are subject to change without notice. PAX's name and PAX's logo are registered trademarks of PAX Technology Inc. All rights reserved.

Cleaning the Device

10

WARNING:

Do not use industrial strength or abrasive cleaner as it may damage or scratch the screen.

Do not immerse device in water (or liquid.)

Do not spray water or cleaner into the MSR slot, Smart Card Reader or ports.

To clean screen, apply distilled water or mild glass cleaner onto a soft, lint-free cloth and gently wipe terminal screen.

To clean terminal, apply distilled water or plastic-safe cleaner onto a soft, lint-free cloth and gently wipe terminal.

Available Accessories

11



RS232 Cable
 200204020000140
 Requires Power Supply



USB Cable
 200204020000141
 Requires Power Supply



Power Supply
 200310110000070
 Requires Power Cord



Stylus Pen
 200209090000929



Privacy Shield
 200209060000040



Power Cord
 200311020000023
 Requires Power Supply



Stylus Holder Plug
 200209090000930



Decorative Privacy Shield Plug
 2002090900001037

FCC Regulations:

This device complies with part 15 of the FCC Rules.

Operation is subject to the following two conditions: (1) This device may not cause harmful interference, and (2) this device must accept any interference received, including interference that may cause undesired operation.

This device has been tested and found to comply with the limits for a Class B digital device, pursuant to Part 15 of the FCC Rules. These limits are designed to provide reasonable protection against harmful interference in a residential installation. This equipment generates, uses and can radiated radio frequency energy and, if not installed and used in accordance with the instructions, may cause harmful interference to radio communications. However, there is no guarantee that interference will not occur in a particular installation. If this equipment does cause harmful interference to radio or television reception, which can be determined by turning the equipment off and on, the user is encouraged to try to correct the interference by one or more of the following measures:

- Reorient or relocate the receiving antenna.
- Increase the separation between the equipment and receiver.
- Connect the equipment into an outlet on a circuit different from that to which the receiver is connected.
- Consult the dealer or an experienced radio/TV technician for help.

Caution: Changes or modifications not expressly approved by the party responsible for compliance could void the user's authority to operate the equipment.

RF Exposure Information

This device meets the government's requirements for exposure to radio waves. This device is designed and manufactured not to exceed the emission limits for exposure to radio frequency (RF) energy set by the Federal Communications Commission of the U.S. Government.

This device complies with FCC radiation exposure limits set forth for an uncontrolled environment. In order to avoid the possibility of exceeding the FCC radio frequency exposure limits, human proximity to the antenna shall not be less than 20cm (8 inches) during normal operation.

PX5 Payment Terminal

