



# FCC RF Test Report

**APPLICANT** : PAX Technology Limited  
**EQUIPMENT** : Contactless Reader  
**BRAND NAME** : PAX  
**MODEL NAME** : IM700  
**MARKETING NAME** : IM700  
**FCC ID** : V5PIM700  
**STANDARD** : FCC Part 15 Subpart C §15.225  
**CLASSIFICATION** : (DXX) Low Power Communication Device Transmitter

The testing was completed on Oct. 30, 2017. We, Sporton International (Shenzhen) Inc., would like to declare that the tested sample has been evaluated in accordance with the test procedures and has been in compliance with the applicable technical standards.

The test results in this report apply exclusively to the tested model / sample. Without written approval of Sporton International (Shenzhen) Inc., the test report shall not be reproduced except in full.



Approved by: Eric Shih / Manager

**Sporton International (Shenzhen) Inc.**

**1/F, 2/F, Bldg 5, Shiling Industrial Zone, Xinwei Village, Xili, Nanshan Shenzhen City**

**Guangdong Province 518055 China**



# TABLE OF CONTENTS

**TABLE OF CONTENTS** .....2

**REVISION HISTORY**.....3

**SUMMARY OF THE TEST RESULT** .....4

**1. GENERAL INFORMATION**.....5

    1.1 Applicant..... 5

    1.2 Manufacturer ..... 5

    1.3 Product Feature of Equipment Under Test ..... 5

    1.4 Product Specification of Equipment Under Test ..... 5

    1.5 Modification of EUT ..... 5

    1.6 Testing Location ..... 6

    1.7 Applicable Standards..... 6

**2. TEST CONFIGURATION OF EQUIPMENT UNDER TEST** .....7

    2.1 Descriptions of Test Mode ..... 7

    2.2 Connection Diagram of Test System ..... 7

    2.3 Table for Supporting Units ..... 8

    2.4 EUT Operation Test Setup ..... 8

**3. TEST RESULTS**.....9

    3.1 AC Power Line Conducted Emissions Measurement ..... 9

    3.2 20dB and 99% OBW Spectrum Bandwidth Measurement..... 11

    3.3 Frequency Stability Measurement ..... 12

    3.4 Field Strength of Fundamental Emissions and Mask Measurement..... 13

    3.5 Radiated Emissions Measurement ..... 15

    3.6 Antenna Requirements..... 18

**4. LIST OF MEASURING EQUIPMENT** .....19

**APPENDIX A. TEST RESULTS OF CONDUCTED EMISSION TEST**

**APPENDIX B. TEST RESULTS OF CONDUCTED TEST ITEMS**

    B1. Test Result of 20dB Spectrum Bandwidth

    B2. Test Result of Frequency Stability

**APPENDIX C. TEST RESULTS OF RADIATED TEST ITEMS**

    C1. Test Result of Field Strength of Fundamental Emissions

    C2. Results of Radiated Emissions (9 kHz~30MHz)

    C3. Results of Radiated Emissions (30MHz~1GHz)

**APPENDIX D. SETUP PHOTOGRAPHS**





### SUMMARY OF THE TEST RESULT

Applied Standard: 47 CFR FCC Part 15 Subpart C				
Part	FCC Rule	Description of Test	Result	Remark
3.1	15.207	AC Power Line Conducted Emissions	Complies	Under limit 18.38 dB at 0.31MHz
3.2	15.215(c)	20dB Spectrum Bandwidth	Complies	-
	-	99% OBW Spectrum Bandwidth	Complies	-
3.3	15.225(e)	Frequency Stability	Complies	-
3.4	15.225(a)(b)(c)	Field Strength of Fundamental Emissions	Complies	Max level 71.59 dB $\mu$ V/m at 13.56 MHz
3.5	15.225(d) 15.209	Radiated Emissions	Complies	Under limit 3.16 dB at 40.67 MHz
3.6	15.203	Antenna Requirements	Complies	-

Test Items	Uncertainty	Remark
AC Power Line Conducted Emissions	$\pm 2.5$ dB	Confidence levels of 95%
Radiated Emissions (30MHz~1000MHz)	$\pm 5.1$ dB	Confidence levels of 95%



# 1. GENERAL INFORMATION

## 1.1 Applicant

PAX Technology Limited

Room 2416, 24/F., Sun Hung Kai Centre, 30 Harbour Road, Wanchai, Hong Kong

## 1.2 Manufacturer

PAX Computer Technology (Shenzhen) Co., Ltd.

4/F, No.3 Building, Software Park, Second Central Science-Tech Road, High-Tech industrial Park, Shenzhen, Guangdong, P.R.C.

## 1.3 Product Feature of Equipment Under Test

Product Feature	
Equipment	Contactless Reader
Brand Name	PAX
Model Name	IM700
Marketing Name	IM700
FCC ID	V5PIM700
EUT supports Radios application	NFC
HW Version	IM700-XXX-XXX
SW Version	PED4.0
EUT Stage	Production Unit

Remark: The above EUT's information was declared by manufacturer. Please refer to the specifications or user's manual for more detailed description.

## 1.4 Product Specification of Equipment Under Test

Standards-related Product Specification	
Tx/Rx Frequency Range	13.553 ~ 13.567MHz
Channel Number	1
20dBW	2.46 KHz
99%OBW	2.08 KHz
Antenna Type	PCB Antenna
Type of Modulation	ASK

Remark: The above EUT's information was declared by manufacturer. Please refer to the specifications or user's manual for more detailed description.

## 1.5 Modification of EUT

No modifications are made to the EUT during all test items.



### 1.6 Testing Location

Sporton International (Shenzhen) Inc. is accredited to ISO 17025 by National Voluntary Laboratory Accreditation Program (NVLAP code: 600156-0) and the FCC designation No. are CN5018 and CN5019.

<b>Test Site</b>	Sporton International (Shenzhen) Inc.		
<b>Test Site Location</b>	1/F, 2/F, Bldg 5, Shiling Industrial Zone, Xinwei Village, Xili, Nanshan Shenzhen City Guangdong Province 518055 China TEL: +86-755-8637-9589 FAX: +86-755-8637-9595		
<b>Test Site No.</b>	<b>Sporton Site No.</b>		<b>FCC Test Firm Registration No.</b>  251365
	TH01-SZ	CO01-SZ	
<b>Test Engineer</b>	Sam Zheng	Peng Wang	
<b>Temperature</b>	24~26°C	24~25°C	
<b>Relative Humidity</b>	50~53%	50~55%	

<b>Test Site</b>	SPORTON International (ShenZhen) INC.		
<b>Test Site Location</b>	No. 3 Bldg the third floor of south, Shahe River west, Fengzeyuan Warehouse, Nanshan District Shenzhen City Guangdong Province 518055 China TEL: +86-755-3320-2398		
<b>Test Site No.</b>	<b>Sporton Site No.</b>		<b>FCC Test Firm Registration No.</b>  577730
	03CH03-SZ		
<b>Test Engineer</b>	Liangliang Lu		
<b>Temperature</b>	23~25°C		
<b>Relative Humidity</b>	48~52%		

**Note:** The test site complies with ANSI C63.4 2014 requirement.

### 1.7 Applicable Standards

According to the specifications of the manufacturer, the EUT must comply with the requirements of the following standards:

- ♦ FCC Part 15 Subpart C §15.225
- ♦ ANSI C63.10-2013

## 2. TEST CONFIGURATION OF EQUIPMENT UNDER TEST

### 2.1 Descriptions of Test Mode

Investigation has been done on all the possible configurations for searching the worst cases.

The following table is a list of the test modes shown in this test report.

Test Items	
AC Power Line Conducted Emissions	Field Strength of Fundamental Emissions
20dB Spectrum Bandwidth	Frequency Stability
Radiated Emissions 9kHz~30MHz	Radiated Emissions 30MHz~1GHz

The EUT pre-scanned in three NFC type, A, B, F. The worst type (type A) was recorded in this report. Pre-scanned tests, X, Y, Z in three orthogonal panels to determine the final configuration (Y plane as worst plane) from all possible combinations.

### 2.2 Connection Diagram of Test System

#### <AC Conducted Emissions>

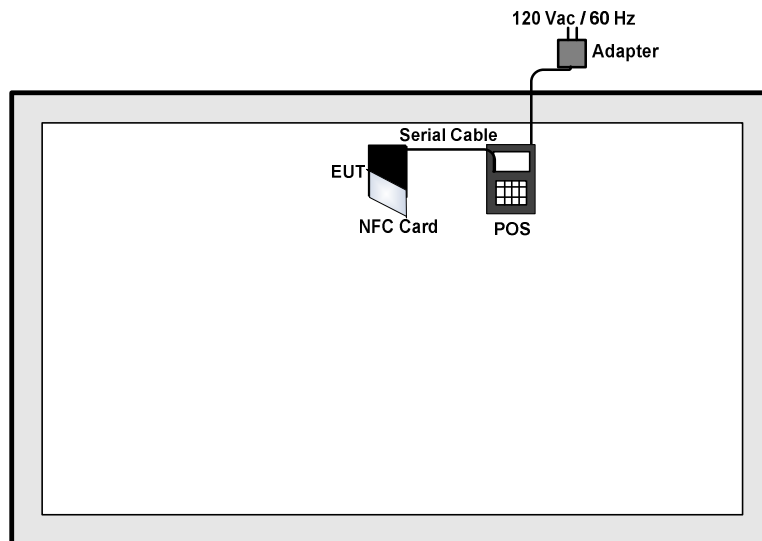

< For Fundamental Emissions and Mask and Radiated Emissions Measurement >

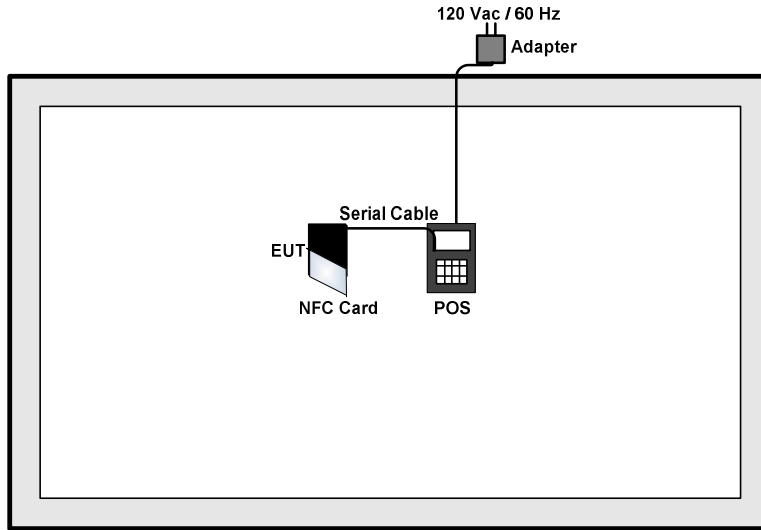

### 2.3 Table for Supporting Units

Support Unit	Manufacturer	Model	FCC ID
POS	PAX	S80	N/A
Adaptor	PAX	ADS-18FSG-09	N/A
NFC Card	PAX	A Card	N/A
Serial Cable (RJ45)	N/A	N/A	N/A

### 2.4 EUT Operation Test Setup

The EUT was programmed to be in continuously transmitting mode.

The ancillary equipment, NFC card, is used to make the EUT (NFC) continuously transmit at 13.56MHz and is placed around 3 cm gap to the EUT.



### 3. TEST RESULTS

#### 3.1 AC Power Line Conducted Emissions Measurement

##### 3.1.1 Limit of AC Conducted Emission

For equipment that is designed to be connected to the public utility (AC) power line, the radio frequency voltage that is conducted back onto the AC power line on any frequency or frequencies within the band 150 kHz to 30 MHz shall not exceed the limits in the following table.

Frequency of Emission (MHz)	Conducted Limit (dB $\mu$ V)	
	Quasi-Peak	Average
0.15-0.5	66 to 56*	56 to 46*
0.5-5	56	46
5-30	60	50

\*Decreases with the logarithm of the frequency.

##### 3.1.2 Measuring Instruments

See list of measuring instruments of this test report.

##### 3.1.3 Test Procedures

1. The EUT was placed 0.4 meter from the conducting wall of the shielding room, and it was kept at least 80 centimeters from any other grounded conducting surface.
2. Connect EUT to the power mains through a line impedance stabilization network (LISN).
3. All the support units are connecting to the other LISN.
4. The LISN provides 50 ohm coupling impedance for the measuring instrument.
5. The FCC states that a 50 ohm, 50 microhenry LISN should be used.
6. Both sides of AC line were checked for maximum conducted interference.
7. The frequency range from 150 kHz to 30 MHz was searched.
8. Set the test-receiver system to Peak Detect Function and specified bandwidth (IF Bandwidth = 9kHz) with Maximum Hold Mode. Then measurement is also conducted by Average Detector and Quasi-Peak Detector Function respectively.

### 3.1.4 Test setup

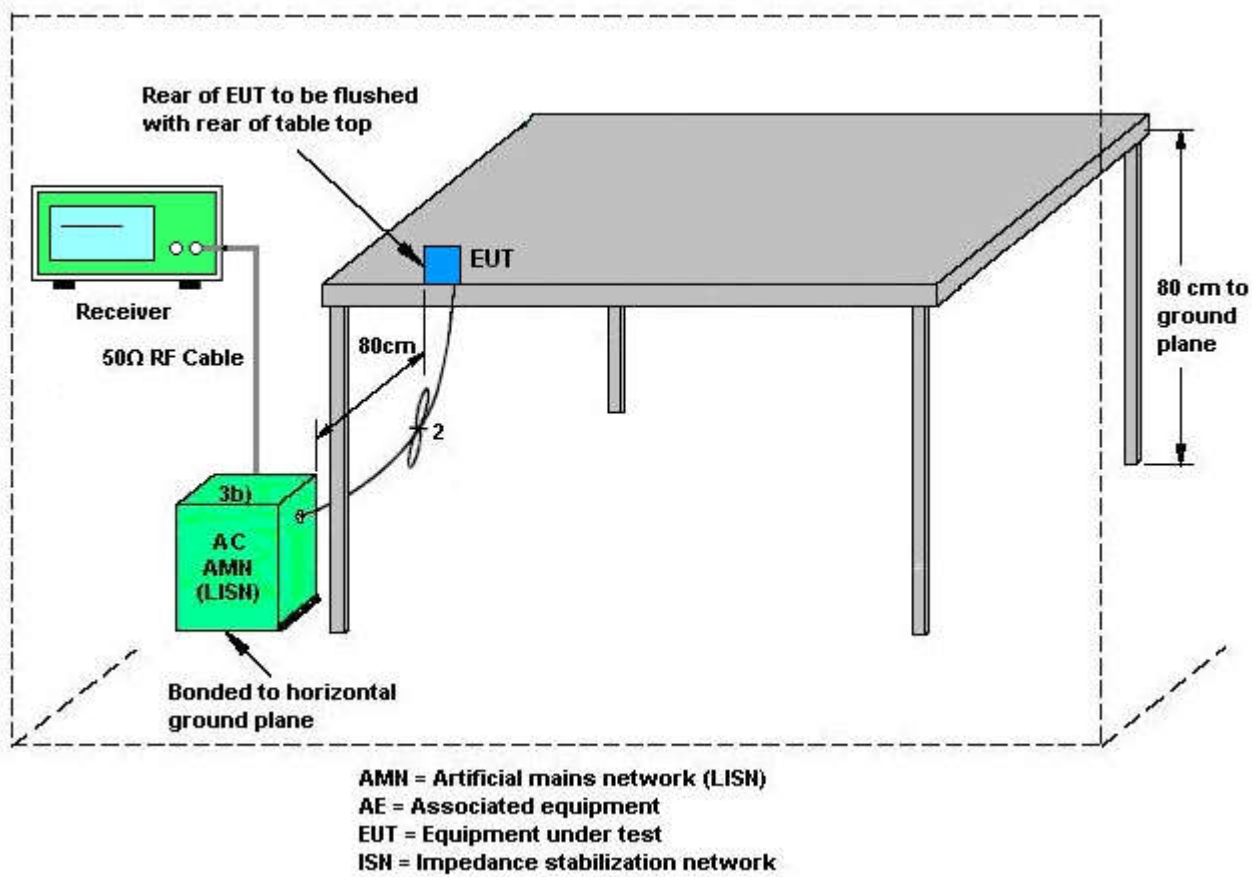

### 3.1.5 Test Result of AC Conducted Emission

Please refer to Appendix A.

## 3.2 20dB and 99% OBW Spectrum Bandwidth Measurement

### 3.2.1 Limit

Intentional radiators must be designed to ensure that the 20dB and 99% emission bandwidth in the specific band 13.553~13.567MHz.

### 3.2.2 Measuring Instruments

See list of measuring instruments of this test report.

### 3.2.3 Test Procedures

1. The spectrum analyzer connected via a receive antenna placed near the EUT in peak Max hold mode.
2. The resolution bandwidth of 1 kHz and the video bandwidth of 3 kHz were used.
3. Measured the spectrum width with power higher than 20dB below carrier.
4. Measured the 99% OBW.

### 3.2.4 Test Setup

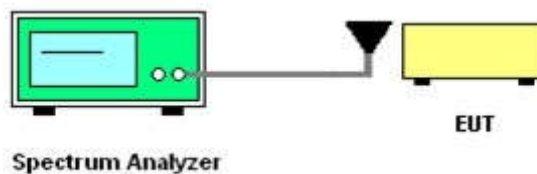

### 3.2.5 Test Result of Conducted Test Items

Please refer to Appendix B.

### 3.3 Frequency Stability Measurement

#### 3.3.1 Limit

The frequency tolerance of the carrier signal shall be maintained within +/- 0.01% (100ppm) of the operating frequency over a temperature variation of -20 degrees to +50 degrees C at normal supply voltage, and for a variation in the primary supply voltage from 85% to 115% of the rated supply voltage at a temperature of 20 degrees C. For battery operated equipment, the equipment tests shall be performed using a new battery.

#### 3.3.2 Measuring Instruments

See list of measuring instruments of this test report.

#### 3.3.3 Test Procedures

1. The spectrum analyzer connected via a receive antenna placed near the EUT.
2. EUT have transmitted signal and fixed channelize.
3. Set the spectrum analyzer span to view the entire emissions bandwidth.
4. Set RBW = 1 kHz, VBW = 3 kHz with peak detector and maxhold settings.
5. The  $f_c$  is declaring of channel frequency. Then the frequency error formula is  $(f_c - f) / f_c \times 10^6$  ppm and the limit is less than  $\pm 100$ ppm.
6. Extreme temperature rule is -20°C~50°C.

#### 3.3.4 Test Setup

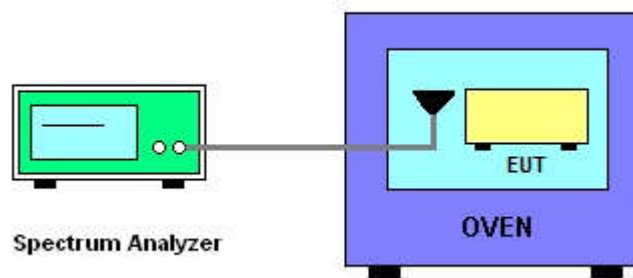

#### 3.3.5 Test Result of Conducted Test Items

Please refer to Appendix B.



### 3.4 Field Strength of Fundamental Emissions and Mask Measurement

#### 3.4.1 Limit

Rules and specifications	FCC CFR 47 Part 15 section 15.225			
Description	Compliance with the spectrum mask is tested with RBW set to 9kHz.			
Freq. of Emission (MHz)	Field Strength (μV/m) at 30m	Field Strength (dBμV/m) at 30m	Field Strength (dBμV/m) at 10m	Field Strength (dBμV/m) at 3m
1.705~13.110	30	29.5	48.58	69.5
13.110~13.410	106	40.5	59.58	80.5
13.410~13.553	334	50.5	69.58	90.5
13.553~13.567	15848	84.0	103.08	124.0
13.567~13.710	334	50.5	69.58	90.5
13.710~14.010	106	40.5	59.58	80.5
14.010~30.000	30	29.5	48.58	69.5

#### 3.4.2 Measuring Instruments

See list of measuring instruments of this test report.

#### 3.4.3 Test Procedures

1. Configure the EUT according to ANSI C63.10. The EUT was placed on the top of the turntable 0.8 meter above ground. The phase center of the loop receiving antenna mounted antenna tower was placed 3 meters far away from the turntable.
2. Power on the EUT and all the supporting units. The turntable was rotated by 360 degrees to determine the position of the highest radiation.
3. The height of the receiving antenna was fixed at one meter above ground to find the maximum emissions field strength.
4. For Fundamental emissions, use the receiver to measure QP reading.

5. When the radiated emissions limits are expressed in terms of the average value of the emissions, and pulsed operation is employed, the measurement field strength shall be determined by averaging over one complete pulse train, including blanking intervals, as long as the pulse train does not exceed 0.1 seconds. As an alternative (provided the transmitter operates for longer than 0.1 seconds) or in cases where the pulse train exceeds 0.1 seconds, the measured field strength shall be determined from the average absolute voltage during a 0.1 second interval during which the field strength is at its maximum value.
6. Compliance with the spectrum mask is tested with RBW set to 9kHz.  
Note: Emission level (dB $\mu$ V/m) = 20 log Emission level ( $\mu$ V/m).

### 3.4.4 Test Setup

For radiated emissions below 30MHz

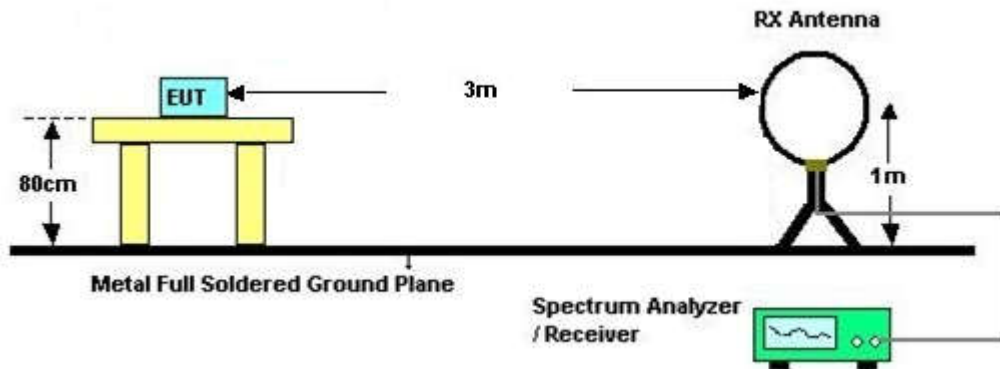

### 3.4.5 Test Result of Field Strength of Fundamental Emissions and Mask

Please refer to Appendix C.

## 3.5 Radiated Emissions Measurement

### 3.5.1 Limit

The field strength of any emissions which appear outside of 13.110 ~14.010MHz band shall not exceed the general radiated emissions limits.

Frequencies (MHz)	Field Strength ( $\mu\text{V/m}$ )	Measurement Distance (meters)
0.009~0.490	2400/F(kHz)	300
0.490~1.705	24000/F(kHz)	30
1.705~30.0	30	30
30~88	100	3
88~216	150	3
216~960	200	3
Above 960	500	3

### 3.5.2 Measuring Instruments

See list of measuring instruments of this test report.

### 3.5.3 Measuring Instrument Setting

The following table is the setting of receiver.

Receiver Parameter	Setting
Attenuation	Auto
Frequency Range: 9kHz~150kHz	RBW 200Hz for QP
Frequency Range: 150kHz~30MHz	RBW 9kHz for QP
Frequency Range: 30MHz~1000MHz	RBW 120kHz for Peak

**Note:** The emission limits shown in the above table are based on measurements employing a CISPR quasi-peak detector except for the frequency bands 9-90 kHz, 110-490 kHz. Radiated emission limits in these two bands are based on measurements employing an average detector.



### **3.5.4 Test Procedures**

1. Configure the EUT according to ANSI C63.10. The EUT was placed on the top of the turntable 0.8 meter above ground. The phase center of the receiving antenna mounted on the top of a height-variable antenna tower was placed 3 meters far away from the turntable.
2. Power on the EUT and all the supporting units. The turntable was rotated by 360 degrees to determine the position of the highest radiation.
3. The height of the broadband receiving antenna was varied between one meter and four meters above ground to find the maximum emissions field strength of both horizontal and vertical polarization.
4. For each suspected emissions, the antenna tower was scan (from 1 M to 4 M) and then the turntable was rotated (from 0 degree to 360 degrees) to find the maximum reading.
5. Set the test-receiver system to Peak or CISPR quasi-peak Detect Function with specified bandwidth under Maximum Hold Mode.
6. When the radiated emissions limits are expressed in terms of the average value of the emissions, and pulsed operation is employed, the measurement field strength shall be determined by averaging over one complete pulse train, including blanking intervals, as long as the pulse train does not exceed 0.1 seconds. As an alternative (provided the transmitter operates for longer than 0.1 seconds) or in cases where the pulse train exceeds 0.1 seconds, the measured field strength shall be determined from the average absolute voltage during a 0.1 second interval during which the field strength is at its maximum value.
7. In case the emission is lower than 30MHz, loop antenna has to be used for measurement and the recorded data should be QP measured by receiver. Antenna Requirements



### 3.5.5 Test Setup

For radiated emissions above 30MHz

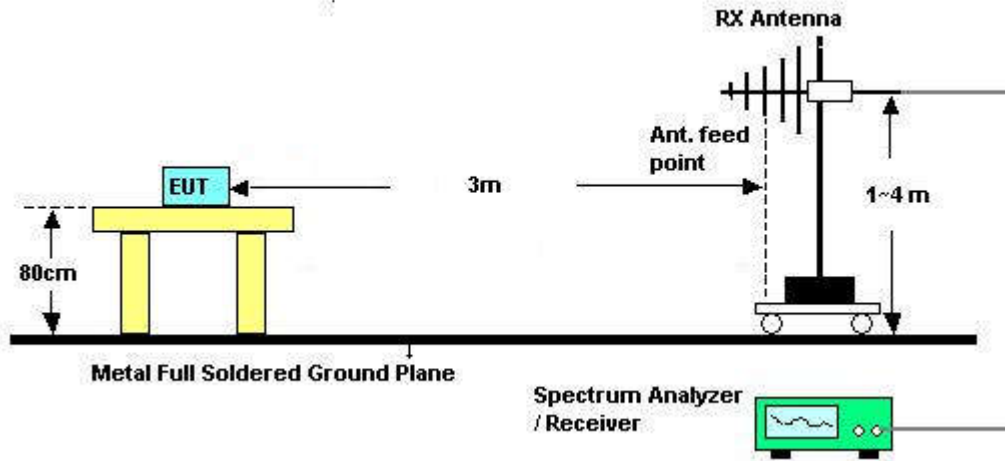

### 3.5.6 Test Result of Radiated Emissions Measurement

Please refer to Appendix C.



## **3.6 Antenna Requirements**

### **3.6.1 Standard Applicable**

Except for special regulations, the Low-power Radio-frequency Devices must not be equipped with any jacket for installing an antenna with extension cable. An intentional radiator shall be designed to ensure that no antenna other than that furnished by the responsible party shall be used with the device. The use of a permanently attached antenna or of an antenna that uses a unique coupling to the intentional radiator shall be considered sufficient to comply with the provisions of this Section. The manufacturer may design the unit so that the user can replace a broken antenna, but the use of a standard antenna jack or electrical connector is prohibited.

The use of a permanently attached antenna or of an antenna that uses a unique coupling to the intentional radiator shall be considered sufficient to comply with the FCC rule.

### **3.6.2 Antenna Anti-Replacement Construction**

An embedded-in antenna design is used.



### 4. LIST OF MEASURING EQUIPMENT

Instrument	Manufacturer	Model No.	Serial No.	Characteristics	Calibration Date	Test Date	Due Date	Remark
Spectrum Analyzer	R&S	FSV40	101078	9kHz~40GHz	Apr. 20, 2017	Oct. 18, 2017	Apr. 19, 2018	Conducted (TH01-SZ)
Thermal Chamber	Ten Billion Hongzhangroup	LP-150U	H2014081803	-40~+150°C	Jul. 20, 2017	Oct. 18, 2017	Jul. 19, 2018	Conducted (TH01-SZ)
AC Power Source	Chroma	61602	616020000891	100Vac~250Vac	Jul. 19, 2017	Oct. 18, 2017	Jul. 18, 2018	Conducted (TH01-SZ)
EMI Test Receiver&SA	KEYSIGHT	N9038A	MY54450083	20Hz~8.4GHz	Apr. 20, 2017	Oct. 26, 2017	Apr. 19, 2018	Radiation (03CH03-SZ)
EXA Spectrum Analyzer	KEYSIGHT	N9010A	MY55150246	10Hz~44GHz;	Apr. 20, 2017	Oct. 26, 2017	Apr. 19, 2018	Radiation (03CH03-SZ)
Loop Antenna	R&S	HFH2-Z2	100354	9kHz~30MHz	May 14, 2017	Oct. 26, 2017	May 13, 2018	Radiation (03CH03-SZ)
Bilog Antenna	TeseQ	CBL6112D	35408	30MHz-2GHz	May 14, 2017	Oct. 26, 2017	May 13, 2018	Radiation (03CH03-SZ)
Amplifier	Burgeon	BPA-530	102210	0.01Hz ~3000MHz	Oct. 19, 2017	Oct. 26, 2017	Oct. 18, 2018	Radiation (03CH03-SZ)
AC Power Source	Chroma	61601	616010001985	N/A	NCR	Oct. 26, 2017	NCR	Radiation (03CH03-SZ)
Turn Table	EM	EM1000	N/A	0~360 degree	NCR	Oct. 26, 2017	NCR	Radiation (03CH03-SZ)
Antenna Mast	EM	EM1000	N/A	1 m~4 m	NCR	Oct. 26, 2017	NCR	Radiation (03CH03-SZ)
EMI Receiver	R&S	ESR7	101630	9kHz~7GHz;	Jan. 06, 2017	Oct. 30, 2017	Jan. 05, 2018	Conduction (CO01-SZ)
AC LISN	EMCO	3816/2SH	00103912	9kHz~30MHz	Jan. 05, 2017	Oct. 30, 2017	Jan. 04, 2018	Conduction (CO01-SZ)
AC LISN (for auxiliary equipment)	MessTec	3816/2SH	00103892	9kHz~30MHz	Jan. 05, 2017	Oct. 30, 2017	Jan. 04, 2018	Conduction (CO01-SZ)
AC Power Source	Chroma	61602	616020000891	100Vac~250Vac	Jul. 19, 2017	Oct. 30, 2017	Jul. 18, 2018	Conduction (CO01-SZ)

NCR: No Calibration Required



## Appendix A. Test Results of Conducted Emission Test

Test Mode :	NFC Tx	Test Voltage :	120Vac / 60Hz
Function Type :	NFC Tx		
Remark	#13, #14 are NFC RF signal		

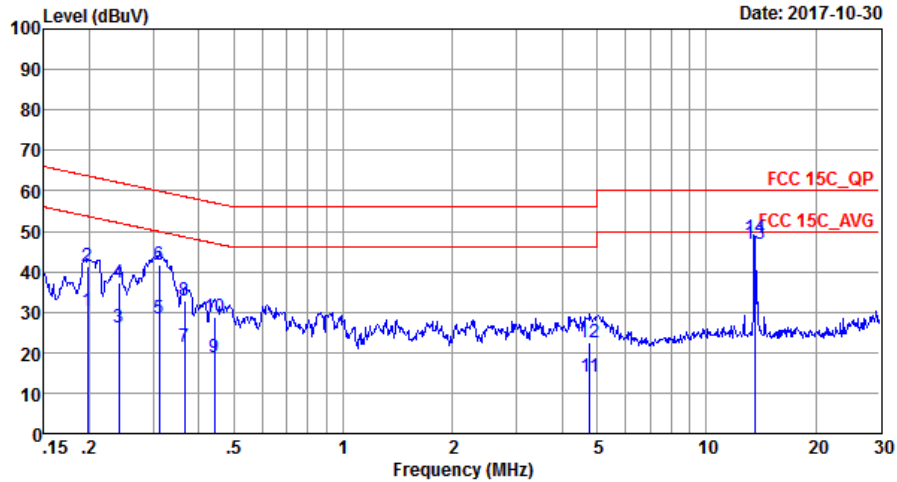

Site : CO01-SZ  
 Condition: FCC 15C\_QP LISN\_20170907\_L LINE

	Freq	Level	Over Limit	Limit Line	Read Level	LISN Factor	Cable Loss	Remark
	MHz	dBuV	dB	dBuV	dBuV	dB	dB	
1	0.20	30.36	-23.35	53.71	20.10	0.03	10.23	Average
2	0.20	41.16	-22.55	63.71	30.90	0.03	10.23	QP
3	0.24	26.25	-25.79	52.04	16.00	0.03	10.22	Average
4	0.24	37.45	-24.59	62.04	27.20	0.03	10.22	QP
5	0.31	28.55	-21.38	49.93	18.30	0.03	10.22	Average
6	0.31	41.55	-18.38	59.93	31.30	0.03	10.22	QP
7	0.37	21.53	-27.08	48.61	11.30	0.03	10.20	Average
8	0.37	32.93	-25.68	58.61	22.70	0.03	10.20	QP
9	0.44	18.81	-28.21	47.02	8.59	0.03	10.19	Average
10	0.44	28.91	-28.11	57.02	18.69	0.03	10.19	QP
11	4.77	13.86	-32.14	46.00	3.40	0.19	10.27	Average
12	4.77	22.46	-33.54	56.00	12.00	0.19	10.27	QP
13 *	13.56	47.00	-3.00	50.00	36.20	0.47	10.33	Average
14	13.56	48.30	-11.70	60.00	37.50	0.47	10.33	QP



Test Mode :	NFC Tx	Test Voltage :	120Vac / 60Hz
Function Type :	NFC Tx		
Remark	#13, #14 are NFC RF signal		

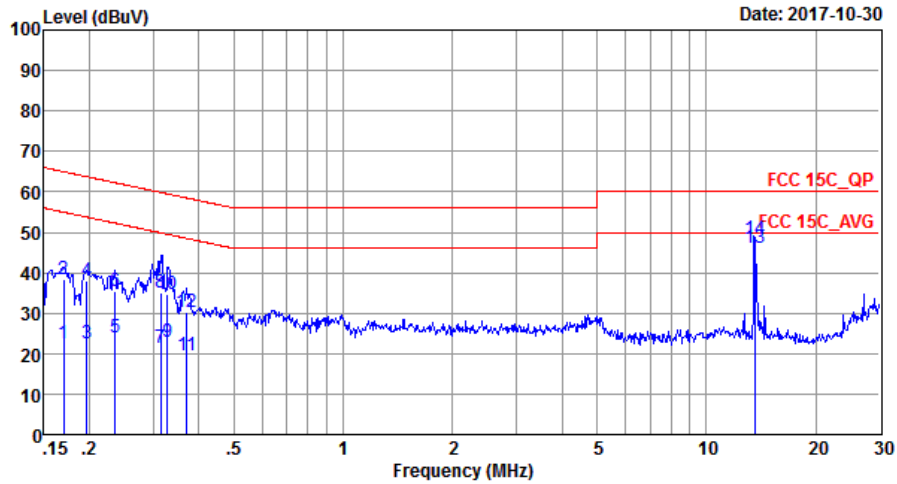

Site : CO01-SZ  
 Condition: FCC 15C\_QP LISN\_20170907\_N NEUTRAL

	Freq	Level	Over Limit	Limit Line	Read Level	LISN Factor	Cable Loss	Remark
	MHz	dBuV	dB	dBuV	dBuV	dB	dB	
1	0.17	22.60	-32.34	54.94	12.50	0.03	10.07	Average
2	0.17	38.19	-26.75	64.94	28.09	0.03	10.07	QP
3	0.20	22.50	-31.26	53.76	12.40	0.03	10.07	Average
4	0.20	38.10	-25.66	63.76	28.00	0.03	10.07	QP
5	0.24	24.00	-28.26	52.26	13.90	0.03	10.07	Average
6	0.24	35.40	-26.86	62.26	25.30	0.03	10.07	QP
7	0.31	21.41	-28.43	49.84	11.30	0.03	10.08	Average
8	0.31	34.91	-24.93	59.84	24.80	0.03	10.08	QP
9	0.33	23.01	-26.48	49.49	12.90	0.03	10.08	Average
10	0.33	34.71	-24.78	59.49	24.60	0.03	10.08	QP
11	0.37	19.50	-28.97	48.47	9.40	0.02	10.08	Average
12	0.37	30.20	-28.27	58.47	20.10	0.02	10.08	QP
13 *	13.56	46.28	-3.72	50.00	35.60	0.29	10.39	Average
14	13.56	48.48	-11.52	60.00	37.80	0.29	10.39	QP



## Appendix B. Test Results of Conducted Test Items

### B1. Test Result of 20dB Spectrum Bandwidth

Test mode	NFC Tx		Test Frequency (MHz)	13.56																																																																
<table border="1"> <thead> <tr> <th>Marker</th> <th>Type</th> <th>Ref</th> <th>Trc</th> <th>X-value</th> <th>Y-value</th> <th>Function</th> <th>Function Result</th> </tr> </thead> <tbody> <tr> <td>M1</td> <td></td> <td>1</td> <td></td> <td>13.56035 MHz</td> <td>-2.58 dBm</td> <td>ndB down</td> <td>2.458 kHz</td> </tr> <tr> <td>T1</td> <td></td> <td>1</td> <td></td> <td>13.559121 MHz</td> <td>-22.43 dBm</td> <td>ndB</td> <td>20.00 dB</td> </tr> <tr> <td>T2</td> <td></td> <td>1</td> <td></td> <td>13.561578 MHz</td> <td>-22.59 dBm</td> <td>Q factor</td> <td>5517.8</td> </tr> </tbody> </table>		Marker	Type	Ref	Trc	X-value	Y-value	Function	Function Result	M1		1		13.56035 MHz	-2.58 dBm	ndB down	2.458 kHz	T1		1		13.559121 MHz	-22.43 dBm	ndB	20.00 dB	T2		1		13.561578 MHz	-22.59 dBm	Q factor	5517.8	<table border="1"> <thead> <tr> <th>Marker</th> <th>Type</th> <th>Ref</th> <th>Trc</th> <th>X-value</th> <th>Y-value</th> <th>Function</th> <th>Function Result</th> </tr> </thead> <tbody> <tr> <td>M1</td> <td></td> <td>1</td> <td></td> <td>13.56035 MHz</td> <td>-2.11 dBm</td> <td>Occ Bw</td> <td>2.077922078 kHz</td> </tr> <tr> <td>T1</td> <td></td> <td>1</td> <td></td> <td>13.5593107 MHz</td> <td>-15.89 dBm</td> <td></td> <td></td> </tr> <tr> <td>T2</td> <td></td> <td>1</td> <td></td> <td>13.5613886 MHz</td> <td>-15.93 dBm</td> <td></td> <td></td> </tr> </tbody> </table>			Marker	Type	Ref	Trc	X-value	Y-value	Function	Function Result	M1		1		13.56035 MHz	-2.11 dBm	Occ Bw	2.077922078 kHz	T1		1		13.5593107 MHz	-15.89 dBm			T2		1		13.5613886 MHz	-15.93 dBm		
Marker	Type	Ref	Trc	X-value	Y-value	Function	Function Result																																																													
M1		1		13.56035 MHz	-2.58 dBm	ndB down	2.458 kHz																																																													
T1		1		13.559121 MHz	-22.43 dBm	ndB	20.00 dB																																																													
T2		1		13.561578 MHz	-22.59 dBm	Q factor	5517.8																																																													
Marker	Type	Ref	Trc	X-value	Y-value	Function	Function Result																																																													
M1		1		13.56035 MHz	-2.11 dBm	Occ Bw	2.077922078 kHz																																																													
T1		1		13.5593107 MHz	-15.89 dBm																																																															
T2		1		13.5613886 MHz	-15.93 dBm																																																															
<b>20dB Bandwidth (kHz)</b>	2.46		<b>99% OccupiedBW(kHz)</b>	2.08																																																																
<b>Frequency range (MHz)</b>	$f_L > 13.553$	13.559		<b>Test Result</b>																																																																
	$f_H < 13.567$	13.562		<b>Complies</b>																																																																

**Remark:** Because the measured signal is CW/CW-like adjusting the RBW per C63.10 would not be practical since measured bandwidth will always follow the RBW and the result will be approximately twice the RBW



B2. Test Result of Frequency Stability

B3. Voltage vs. Frequency Stability		Temperature vs. Frequency Stability	
Voltage (Vac)	Measurement Frequency (MHz)	Temperature (°C)	Measurement Frequency (MHz)
102	13.560415	-20	13.560420
120	13.560415	-10	13.560420
138	13.560415	0	13.560405
--	--	10	13.560375
--	--	20	13.560350
--	--	30	13.560410
--	--	40	13.560400
--	--	50	13.560410
Max.Deviation (MHz)	0.000414	Max.Deviation (MHz)	0.000419
Max.Deviation (ppm)	30.5678	Max.Deviation (ppm)	30.9366
Limit	FS < ±100 ppm	Limit	FS < ±100 ppm
Test Result	PASS	Test Result	PASS



# Appendix C. Test Results of Radiated Test Items

## C1. Test Result of Field Strength of Fundamental Emissions







**C2. Results of Radiated Spurious Emissions (9 kHz~30MHz)**

<b>Test Mode :</b>	NFC Tx	<b>Polarization :</b>	Horizontal
--------------------	--------	-----------------------	------------

Frequency ( MHz )	Level ( dBμV/m )	Over Limit ( dB )	Limit Line ( dBμV/m )	Read Level (dBμV)	Antenna Factor ( dB )	Cable Loss ( dB )	Ant Pos ( cm )	Table Pos ( deg )	Remark
0.00931	51.43	-76.8	128.23	30.38	21	0.05	-	-	Average
0.06492	49.23	-62.13	111.36	28.67	20.5	0.06	-	-	Average
0.0981	45.91	-61.86	107.77	25.14	20.7	0.07	-	-	QP
0.13248	41.4	-63.76	105.16	20.72	20.6	0.08	-	-	Average
0.19625	47.86	-53.89	101.75	27.44	20.31	0.11	-	-	Average
2.048	36.93	-33.07	70	16.2	20.55	0.18	-	-	QP
13.984	41.19	-28.81	70	21.29	19.45	0.45	-	-	QP
22.399	33.92	-36.08	70	14.13	19.23	0.56	-	-	QP
29.875	35.66	-34.34	70	15.33	19.65	0.68	-	-	QP

<b>Test Mode :</b>	NFC Tx	<b>Polarization :</b>	Vertical
--------------------	--------	-----------------------	----------

Frequency ( MHz )	Level ( dBμV/m )	Over Limit ( dB )	Limit Line ( dBμV/m )	Read Level (dBμV)	Antenna Factor ( dB )	Cable Loss ( dB )	Ant Pos ( cm )	Table Pos ( deg )	Remark
0.00915	52.1	-76.27	128.37	31.05	21	0.05	-	-	Average
0.06672	45.03	-66.09	111.12	24.47	20.5	0.06	-	-	Average
0.0996	40.98	-66.66	107.64	20.21	20.7	0.07	-	-	QP
0.12225	35.81	-70.05	105.86	15.13	20.6	0.08	-	-	Average
0.1537	47.04	-56.83	103.87	26.64	20.3	0.1	-	-	Average
2.342	37.13	-32.87	70	16.41	20.53	0.19	-	-	QP
14.12	35.89	-34.11	70	15.99	19.44	0.46	-	-	QP
24.496	33.99	-36.01	70	13.84	19.57	0.58	-	-	QP
29.44	35.12	-34.88	70	14.98	19.47	0.67	-	-	QP

**Note:**

1. The amplitude of spurious emissions which are attenuated by more than 20dB below the permissible value has no need to be reported.
2. Distance extrapolation factor = 40 log (specific distance / test distance) (dB);
3. Limit line = specific limits (dBμV) + distance extrapolation factor.



C3. Results of Radiated Spurious Emissions (30MHz~1GHz)

Test Mode :	NFC Tx	Polarization :	Horizontal
-------------	--------	----------------	------------

Frequency ( MHz )	Level ( dBμV/m )	Over Limit ( dB )	Limit Line ( dBμV/m )	Read Level ( dBμV )	Antenna Factor ( dB )	Cable Loss ( dB )	Preamp Factor ( dB )	Ant Pos ( cm )	Table Pos ( deg )	Remark
40.67	27.51	-12.49	40	36.9	21.94	0.66	31.99	-	-	Peak
134.76	28.34	-15.16	43.5	40.61	18.11	1.21	31.59	-	-	Peak
176.47	40.31	-3.19	43.5	53.74	16.64	1.35	31.42	120	60	Peak
433.52	37.05	-8.95	46	40.76	25.26	2.21	31.18	-	-	Peak
527.61	32.83	-13.17	46	37.56	23.96	2.47	31.16	-	-	Peak
888.45	32.85	-13.15	46	32.35	28.41	3.29	31.2	-	-	Peak

Test Mode :	NFC Tx	Polarization :	Vertical
-------------	--------	----------------	----------

Frequency ( MHz )	Level ( dBμV/m )	Over Limit ( dB )	Limit Line ( dBμV/m )	Read Level ( dBμV )	Antenna Factor ( dB )	Cable Loss ( dB )	Preamp Factor ( dB )	Ant Pos ( cm )	Table Pos ( deg )	Remark
40.67	36.84	-3.16	40	46.23	21.94	0.66	31.99	135	300	Peak
67.83	31.68	-8.32	40	49.33	13.38	0.84	31.87	-	-	Peak
176.47	29.62	-13.88	43.5	43.05	16.64	1.35	31.42	-	-	Peak
433.52	28.87	-17.13	46	32.58	25.26	2.21	31.18	-	-	Peak
624.61	32.06	-13.94	46	35.36	25.2	2.72	31.22	-	-	Peak
969.93	31.98	-22.02	54	29.96	29.8	3.43	31.21	-	-	Peak

Note:

1. The amplitude of spurious emissions which are attenuated by more than 20dB below the permissible value has no need to be reported.
2. Emission level (dBμV/m) = 20 log Emission level (μV/m).
3. Corrected Reading: Antenna Factor + Cable Loss + Read Level - Preamp Factor= Level.