



**FCC 47 CFR PART 15 SUBPART C  
ISED RSS-210 ISSUE 10**

**CERTIFICATION TEST REPORT**

*For*

**Integrated Smart Terminal**

**MODEL NUMBER: E700 Pro**

**REPORT NUMBER: 4790870870-1-RF-7**

**ISSUE DATE: July 14, 2023**

**FCC ID:V5PE700PRO**

**IC:11689A-E700PRO**

*Prepared for*

**PAX Technology Limited**

**Room 2416, 24/F., Sun Hung Kai Centre, 30 Harbour Road, Wanchai, Hong Kong**

*Prepared by*

**UL Verification Services (Guangzhou) Co., Ltd, Song Shan Lake Branch**

**Building 10, Innovation Technology Park, No. 1, Li Bin Road, Song Shan Lake Hi-Tech Development Zone Dongguan, 523808, People's Republic of China**

**Tel: +86 769 22038881**

**Fax: +86 769 33244054**

**Website: [www.ul.com](http://www.ul.com)**

Revision History

<u>Rev.</u>	<u>Issue Date</u>	<u>Revisions</u>	<u>Revised By</u>
V0	7/14/2023	Initial Issue	

Summary of Test Results			
Clause	Test Items	FCC Rules	Test Results
1	Transmitter 99% Emission Bandwidth / 20dB Bandwidth	RSS-Gen 6.7/ Part 15.215 (c)	PASS
2	Transmitter Frequency Stability (Temperature & Voltage Variation)	CFR 47 FCC §15.225(e) ISED RSS-Gen Clause 6.11 ISED RSS-210 Annex B.6	PASS
3	Fundamental Field Strength	CFR 47 FCC §5.225(a)(b)(c)(d) ISED RSS-Gen Clause 6.12 ISED RSS-210 Annex B.6	PASS
4	Radiated Emissions	CFR 47 FCC§15.209(a) CFR 47 FCC§15.225(d) ISED RSS-Gen Clause 6.13 ISED RSS-210 Annex B.6	PASS
5	Band Edge Radiated Emissions	CFR 47 FCC §15.209(a) CFR 47 FCC §15.225(c)(d) ISED RSS-Gen Clause 6.13 ISED RSS-210 Annex B.6	PASS
6	Conducted Emission Test for AC Power Port	CFR 47 FCC §15.207 ISED RSS-Gen Clause 8.8	PASS
7	Antenna Requirement	CFR 47 FCC §15.203 ISED RSS-Gen Clause 6.8	Pass
<p>Note 1: This test report is only published to and used by the applicant, and it is not for evidence purpose in China.</p> <p>Note 2: The measurement result for the sample received is &lt;Pass&gt; according to &lt; CFR 47 FCC PART 15 SUBPART C, ISED RSS-210 Issue 9 and ISED RSS-GEN Issue 5 &gt; when &lt;Accuracy Method&gt; decision rule is applied.</p>			

## TABLE OF CONTENTS

<b>1. ATTESTATION OF TEST RESULTS</b> .....	<b>5</b>
<b>2. TEST METHODOLOGY</b> .....	<b>6</b>
<b>3. FACILITIES AND ACCREDITATION</b> .....	<b>6</b>
<b>4. CALIBRATION AND UNCERTAINTY</b> .....	<b>7</b>
4.1. <i>MEASURING INSTRUMENT CALIBRATION</i> .....	7
4.2. <i>MEASUREMENT UNCERTAINTY</i> .....	7
<b>5. EQUIPMENT UNDER TEST</b> .....	<b>8</b>
5.1. <i>DESCRIPTION OF EUT</i> .....	8
5.2. <i>MAXIMUM FIELD STRENGTH</i> .....	8
5.3. <i>DESCRIPTION OF AVAILABLE ANTENNAS</i> .....	8
5.4. <i>TEST ENVIRONMENT</i> .....	9
5.5. <i>DESCRIPTION OF TEST SETUP</i> .....	10
5.6. <i>MEASURING INSTRUMENT AND SOFTWARE USED</i> .....	12
<b>6. ANTENNA PORT TEST RESULTS</b> .....	<b>13</b>
6.1. <i>99% &amp; 20dB BANDWIDTH</i> .....	13
6.2. <i>TRANSMITTER FREQUENCY STABILITY</i> .....	15
<b>7. RADIATED EMISSION TEST RESULTS</b> .....	<b>17</b>
7.1. <i>FIELD STRENGTH OF INTENTIONAL EMISSIONS</i> .....	24
7.2. <i>SPURIOUS EMISSIONS BELOW 1GHz AND ABOVE 30MHz</i> .....	25
7.3. <i>SPURIOUS EMISSIONS BELOW 30MHz</i> .....	27
<b>8. AC POWER LINE CONDUCTED EMISSIONS</b> .....	<b>30</b>
<b>9. ANTENNA REQUIREMENTS</b> .....	<b>36</b>

## 1. ATTESTATION OF TEST RESULTS

### Applicant Information

Company Name: PAX Technology Limited  
Address: Room 2416, 24/F., Sun Hung Kai Centre, 30 Harbour Road, Wanchai, Hong Kong

### Manufacturer Information

Company Name: PAX Computer Technology (Shenzhen) Co., Ltd.  
Address: 401 and 402, Building 3, Shenzhen Software Park, Nanshan District, Shenzhen City, Guangdong Province, P.R.C

### EUT Information

EUT Name: Integrated Smart Terminal  
Model: E700 Pro  
Sample Received Date: September 28, 2017  
Sample Status: Normal  
Sample ID: 6201632  
Date of Tested: June 29, 2023 ~ July 14, 2023

APPLICABLE STANDARDS	
STANDARD	TEST RESULTS
CFR 47 FCC PART 15 SUBPART C	PASS
ISED RSS-210 Issue 10	PASS
ISED RSS-GEN Issue 5	PASS

Prepared By:

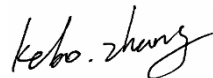

Kebo Zhang  
Senior Project Engineer

Checked By:

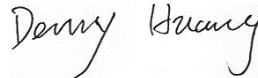

Denny Huang  
Senior Project Engineer

Approved By:



Stephen Guo  
Operations Manager

## 2. TEST METHODOLOGY

The tests documented in this report were performed in accordance with KDB 414788 D01 Radiated Test Site v01r01, FCC CFR 47 Part 2, FCC CFR 47 Part 15, ANSI C63.10-2013, ISED RSS-210 Issue 10 and RSS-GEN Issue 5.

## 3. FACILITIES AND ACCREDITATION

Accreditation Certificate	<p><b>A2LA (Certificate No.: 4102.01)</b>          UL Verification Services (Guangzhou) Co., Ltd. Song Shan Lake Branch. has been assessed and proved to be in compliance with A2LA.</p> <p><b>FCC (FCC Designation No.: CN1187)</b>          UL Verification Services (Guangzhou) Co., Ltd. Song Shan Lake Branch. Has been recognized to perform compliance testing on equipment subject to the Commission's Declaration of Conformity (DoC) and Certification rules</p> <p><b>ISED (Company No.: 21320)</b>          UL Verification Services (Guangzhou) Co., Ltd. Song Shan Lake Branch. has been registered and fully described in a report filed with ISED. The Company Number is 21320 and the test lab Conformity Assessment Body Identifier (CABID) is CN0046.</p> <p><b>VCCI (Registration No.: G-20019, R-20004, C-20012 and T-20011)</b>          UL Verification Services (Guangzhou) Co., Ltd. Song Shan Lake Branch. has been assessed and proved to be in compliance with VCCI, the Membership No. is 3793.          Facility Name:          Chamber D, the VCCI registration No. is G-20019 and R-20004          Shielding Room B, the VCCI registration No. is C-20012 and T-20011</p>
---------------------------	---

### Note:

1. All tests measurement facilities use to collect the measurement data are located at Building 10, Innovation Technology Park, Song Shan Lake Hi tech Development Zone, Dongguan, 523808, China
2. The test anechoic chamber in UL Verification Services (Guangzhou) Co., Ltd. Song Shan Lake Branch had been calibrated and compared to the open field sites and the test anechoic chamber is shown to be equivalent to or worst case from the open field site.
3. For below 30MHz, lab had performed measurements at test anechoic chamber and comparing to measurements obtained on an open field site. And these measurements below 30MHz had been correlated to measurements performed on an OFS.

## 4. CALIBRATION AND UNCERTAINTY

### 4.1. MEASURING INSTRUMENT CALIBRATION

The measuring equipment utilized to perform the tests documented in this report has been calibrated in accordance with the manufacturer's recommendations and is traceable to recognize national standards.

### 4.2. MEASUREMENT UNCERTAINTY

Where relevant, the following measurement uncertainty levels have been estimated for tests performed on the apparatus:

Test Item	Uncertainty
Conduction emission	3.62 dB
Radiation Emission test (include Fundamental emission) (9KHz-30MHz)	2.2 dB
Radiation Emission test (include Fundamental emission) (30MHz-1GHz)	4.00 dB
Radiation Emission test (1GHz to 26GHz) (include Fundamental emission)	5.78 dB (1 GHz-18 GHz)
	5.23 dB (18 GHz-26 GHz)
Note: This uncertainty represents an expanded uncertainty expressed at approximately the 95% confidence level using a coverage factor of k=2.	

## 5. EQUIPMENT UNDER TEST

### 5.1. DESCRIPTION OF EUT

EUT Name	Integrated Smart Terminal
Model	E700 Pro
Operation Frequency	13.56MHz
Modulation	ASK
Switching Adapter	Model: ADS-65HI-19A-3 24065E Input: 100-240V~ 50/60Hz 1.5A max Output: DC 24V, 2.7A 64.8W

### 5.2. MAXIMUM FIELD STRENGTH

Frequency (MHz)	Max Peak field strength (dB $\mu$ V/m)
13.56	18.19

### 5.3. DESCRIPTION OF AVAILABLE ANTENNAS

Frequency (MHz)	Antenna Type	Antenna Gain (dBi)
13.56	Coil antenna	0



#### 5.4. TEST ENVIRONMENT

Environment Parameter	Selected Values During Tests	
Relative Humidity	55 ~ 65%	
Atmospheric Pressure:	1025Pa	
Temperature	TN	23 ~ 28°C
Voltage:	VL	AC 108 V, 60 Hz
	VN	AC 120 V, 60 Hz
	VH	AC 132 V, 60 Hz

Note: VL= Lower Extreme Test Voltage  
VN= Nominal Voltage  
VH= Upper Extreme Test Voltage  
TN= Normal Temperature

## 5.5. DESCRIPTION OF TEST SETUP

### SUPPORT EQUIPMENT

Item	Equipment	Brand Name	Model Name	Remarks
1	Laptop	Lenovo	E14	/
2	Adapter	N/A	GLH50E2000HW	Input: 100-240V~, 50/60Hz, 0.40A Output: AC 120V, 60HZ2A, 10W

### I/O CABLES

Cable No	Port	Connector Type	Cable Type	Cable Length(m)	Remarks
1	Switching Adapter	HONOTO	ADS-65HI-19A-3 24065E	Input: 100-240V~ 50/60Hz 1.5A max Output: DC 24V, 2.7A 64.8W	Switching Adapter

### ACCESSORIES

Item	Accessory	Brand Name	Model Name	Description
/	/	/	/	/

### TEST SETUP

The EUT can transmit the NFC signal through Swiping card (NFC)  
NFC support both ISO /IEC 14443A and ISO /IEC 14443B. All lowest and highest data rates as per the standards are supported - 106 kbps, 212 kbps, 424 kbps and 848 kbps, all the modes had been tested, but only the worst data (ISO 14443A 106 kbps) was recorded in the report.

### SETUP DIAGRAM FOR TESTS

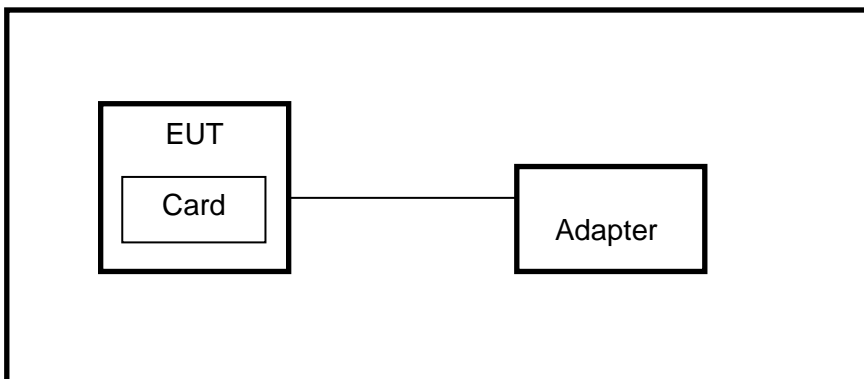

Note: Test was performed with tag and without tag, but only the worst-case data (with tag) was recorded in the report.

## 5.6. MEASURING INSTRUMENT AND SOFTWARE USED

Conducted Emissions					
Equipment	Manufacturer	Model No.	Serial No.	Last Cal.	Due Date
EMI Test Receiver	R&S	ESR3	101961	Oct. 17, 2022	Oct. 16, 2023
Two-Line V-Network	R&S	ENV216	101983	Oct. 17, 2022	Oct. 16, 2023
Software					
Description		Manufacturer	Name	Version	
Test Software for Conducted Emissions		Farad	EZ-EMC	Ver. UL-3A1	

R&S TS 8997 Test System					
Equipment	Manufacturer	Model No.	Serial No.	Last Cal.	Due Date
Power sensor, Power Meter	R&S	OSP120	100921	Mar.31,2023	Mar.30,2024
Signal Analyzer	R&S	FSV40	101118	Oct.17, 2022	Oct.16, 2023
Software					
Description		Manufacturer	Name	Version	
Tonsend SRD Test System		Tonsend	JS1120-3 RF Test System	V3.2.22	

Radiated Emissions					
Equipment	Manufacturer	Model No.	Serial No.	Last Cal.	Due Date
MXE EMI Receiver	KESIGHT	N9038A	MY56400036	Oct. 17, 2022	Oct. 16, 2023
Hybrid Log Periodic Antenna	TDK	HLP-3003C	130959	Aug.02, 2021	Aug.01, 2024
Preamplifier	HP	8447D	2944A09099	Oct. 17, 2022	Oct. 16, 2023
Loop antenna	Schwarzbeck	1519B	00008	Dec.14, 2021	Dec.13, 2024
Preamplifier	Agilent	8447F	2944a03683	Oct.17, 2022	Oct.16, 2023
Software					
Description		Manufacturer	Name	Version	
Test Software for Radiated Emissions		Farad	EZ-EMC	Ver. UL-3A1	

Other Instruments					
Equipment	Manufacturer	Model No.	Serial No.	Last Cal.	Next Cal.
PXA Signal Analyzer	Keysight	N9030A	MY55410512	Oct.17, 2022	Oct.16, 2023
Attenuator	Agilent	8495B	2814a12853	Oct.18, 2022	Oct.17, 2023

## 6. ANTENNA PORT TEST RESULTS

### 6.1. 99% & 20dB BANDWIDTH

#### LIMITS

FCC Part15 (15.247) Subpart C RSS-247 ISSUE 2		
Section	Test Item	Limit
ANSI C63.10 Section 6.9.2	20dB% Bandwidth	For reporting purposes only.
ISED RSS-Gen Clause 6.7 Issue 5	99 % Occupied Bandwidth	For reporting purposes only.

#### TEST PROCEDURE

The transmitter output is connected to the spectrum analyzer. The RBW is set to 1 kHz. The VBW is set to 3 times the RBW. The sweep time is coupled. The spectrum analyzer internal 99% bandwidth function is utilized.

Note: Because the measured signal is CW or CW-like adjusting the RBW per C63.10 would not be practical since measured bandwidth will always follow the RBW and the result will be approximately twice the RBW.

The type of band for the signal is narrowband.

#### TEST SETUP

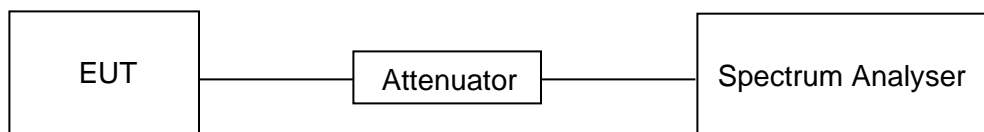

#### TEST ENVIRONMENT

Temperature	23.5°C	Relative Humidity	53%
Atmosphere Pressure	101kPa	Test Voltage	DC 7.2 V

**RESULTS**

Frequency (MHz)	99% Occupied Bandwidth (kHz)	20dB bandwidth (kHz)
13.56	2.418	2.850

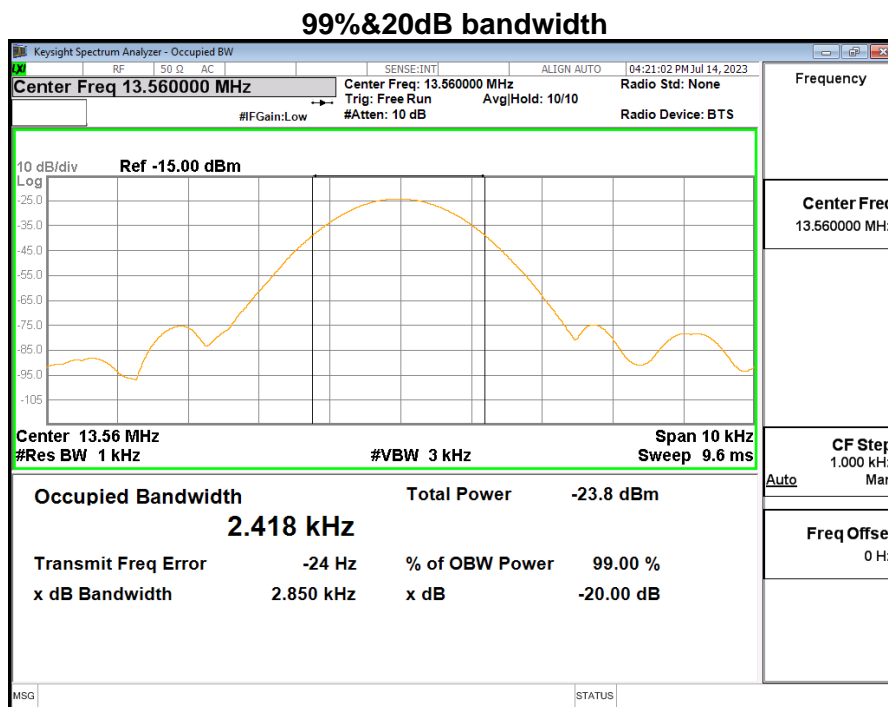

## 6.2. TRANSMITTER FREQUENCY STABILITY

### LIMITS

CFR 47 FCC §15.225(e)  
ISED RSS-210 Annex B B.6

The frequency tolerance of the carrier signal shall be maintained within  $\pm 0.01\%$  of the operating frequency over a temperature variation of  $-20$  degrees to  $+ 50$  degrees C at normal supply voltage, and for a variation in the primary supply voltage from 85% to 115% of the rated supply voltage at a temperature of 20 degrees C.

### TEST SETUP AND PROCEDURE

Connect the UUT to the spectrum analyser and use the following settings:

Center Frequency	The center frequency of the channel under test
Detector	PEAK
RBW	10KHz
VBW	$\geq 3 \times$ RBW
Span	Encompass the entire emissions bandwidth (EBW) of the signal
Trace	Max hold
Sweep time	Auto

Allow the trace to stabilize, find the peak value of the power envelope and record the frequency, then calculated the frequency drift.

### TEST SETUP

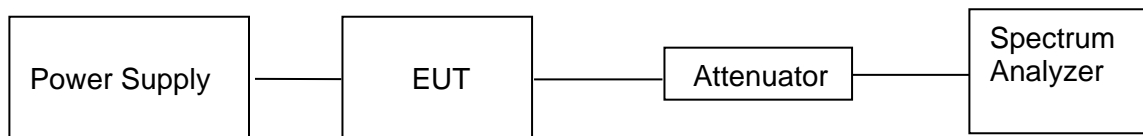

**TEST RESULTS**

Maximum frequency error of the EUT with variations in ambient temperature

Temperature (°C)	Time after Start-up			
	0 minutes	2 minutes	5 minutes	10 minutes
-10	13.5606	13.5605	13.5609	13.5609
0	13.5607	13.5608	13.5606	13.5606
10	13.5611	13.5609	13.5609	13.5604
20	13.5604	13.5606	13.5608	13.5608
30	13.5610	13.5606	13.5605	13.5604
45	13.5608	13.5612	13.5610	13.5607
Maximum frequency error	0.0081%	0.0088%	0.0081%	0.0066%
Limit	0.01%			
Result	Pass	Pass	Pass	Pass

Maximum frequency error of the EUT with variations in nominal operating voltage at an ambient 20 degrees C temperature.

Supply Voltage (V)	Time after Start-up			
	0 minutes	2 minutes	5 minutes	10 minutes
AC 108 V	13.5611	13.5606	13.5605	13.5608
AC 120 V	13.5608	13.5609	13.5608	13.5609
AC 132 V	13.5608	13.5610	13.5613	13.5608
Maximum frequency error	0.0081%	0.0074%	0.0096%	0.0081%
Limit	0.01%			
Result	Pass	Pass	Pass	Pass



## 7. RADIATED EMISSION TEST RESULTS

### LIMITS

Fundamental field strength

FCC Reference:	Part 15.225(a)(b)(c)(d) & 15.209(a)
ISED Canada Reference:	RSS-Gen 6.13 & RSS-210 B.6 & RSS-GEN Clause 8.9
Test Method Used:	ANSI C63.10 Sections 6.3, 6.4 and 6.5

Frequency (MHz)	Field Strength (uV/m)	Field Strength (dBuV/m)	Measured Distance (Meters)
13.553-13.567	15848	84	30
13.410-13.553/13.567-13.710	334	50.47	30
13.110-13.410/13.710-14.010	106	40.51	30

Note(s):

1. The field strength of any emissions appearing outside of the 13.110-14.010 MHz band shall not exceed the general radiated emission limits in §15.209.

2. The limit is specified at a test distance of 30 meters. However, as specified by FCC Section 15.31 (f)(2), measurements may be performed at a closer distance and the measured level corrected to the specified measurement distance by using the square of an inverse linear distance extrapolation factor (40dB/decade).

## Radiation Disturbance Test Limit for FCC (Class B) (9KHz-1GHz)

Frequency (MHz)	Field Strength (microvolts/meter)	Measurement Distance (meters)
0.009~0.490	2400/F(KHz)	300
0.490~1.705	24000/F(KHz)	30
1.705~30.0	30	30
30~88	100	3
88~216	150	3
216~960	200	3
960~1000	500	3

## ISED General field strength limits at frequencies below 30 MHz

Table 6 – General field strength limits at frequencies below 30 MHz		
Frequency	Magnetic field strength (H-Field) (μA/m)	Measurement distance (m)
9 - 490 kHz <sup>Note 1</sup>	6.37/F (F in kHz)	300
490 - 1705 kHz	63.7/F (F in kHz)	30
1.705 - 30 MHz	0.08	30

**Note 1:** The emission limits for the ranges 9-90 kHz and 110-490 kHz are based on measurements employing a linear average detector.

Note: 1) At frequencies at or above 30 MHz, measurements may be performed at a distance other than what is specified provided: measurements are not made in the near field except where it can be shown that near field measurements are appropriate due to the characteristics of the device; and it can be demonstrated that the signal levels needed to be measured at the distance employed can be detected by the measurement equipment. Measurements shall not be performed at a distance greater than 30 meters unless it can be further demonstrated that measurements at a distance of 30 meters or less are impractical. When performing measurements at a distance other than that specified, the results shall be extrapolated to the specified distance using an extrapolation factor of 20 dB/decade (inverse linear-distance for field strength measurements; inverse-linear-distance-squared for power density measurements).

(2) At frequencies below 30 MHz, measurements may be performed at a distance closer than that specified in the regulations; however, an attempt should be made to avoid making measurements in the near field. Pending the development of an appropriate measurement procedure for measurements performed below 30 MHz, when performing measurements at a closer distance than specified, the results shall be extrapolated to the specified distance by either making measurements at a minimum of two distances on at least one radial to determine the proper extrapolation factor or by using the square of an inverse linear distance extrapolation factor (40 dB/decade). This paragraph (f) shall not apply to Access BPL devices operating below 30MHz.

## Restricted bands of operation

MHz	MHz	MHz	GHz
0.090-0.110	16.42-16.423	399.9-410	4.5-5.15
<sup>1</sup> 0.495-0.505	16.69475-16.69525	608-614	5.35-5.46
2.1735-2.1905	16.80425-16.80475	960-1240	7.25-7.75
4.125-4.128	25.5-25.67	1300-1427	8.025-8.5
4.17725-4.17775	37.5-38.25	1435-1626.5	9.0-9.2
4.20725-4.20775	73-74.6	1645.5-1646.5	9.3-9.5
6.215-6.218	74.8-75.2	1660-1710	10.6-12.7
6.26775-6.26825	108-121.94	1718.8-1722.2	13.25-13.4
6.31175-6.31225	123-138	2200-2300	14.47-14.5
8.291-8.294	149.9-150.05	2310-2390	15.35-16.2
8.362-8.366	156.52475-156.52525	2483.5-2500	17.7-21.4
8.37625-8.38675	156.7-156.9	2690-2900	22.01-23.12
8.41425-8.41475	162.0125-167.17	3260-3267	23.6-24.0
12.29-12.293	167.72-173.2	3332-3339	31.2-31.8
12.51975-12.52025	240-285	3345.8-3358	36.43-36.5
12.57675-12.57725	322-335.4	3600-4400	( <sup>2</sup> )
13.36-13.41			

Note: <sup>1</sup>Until February 1, 1999, this restricted band shall be 0.490-0.510 MHz.

<sup>2</sup>Above 38.6c

Table 7 – Restricted frequency bands <sup>Note 1</sup>		
MHz	MHz	GHz
0.090 - 0.110	149.9 - 150.05	9.0 - 9.2
0.495 - 0.505	156.52475 - 156.52525	9.3 - 9.5
2.1735 - 2.1905	156.7 - 156.9	10.6 - 12.7
3.020 - 3.026	162.0125 - 167.17	13.25 - 13.4
4.125 - 4.128	167.72 - 173.2	14.47 - 14.5
4.17725 - 4.17775	240 - 285	15.35 - 16.2
4.20725 - 4.20775	322 - 335.4	17.7 - 21.4
5.677 - 5.683	399.9 - 410	22.01 - 23.12
6.215 - 6.218	608 - 614	23.6 - 24.0
6.26775 - 6.26825	960 - 1427	31.2 - 31.8
6.31175 - 6.31225	1435 - 1626.5	36.43 - 36.5
8.291 - 8.294	1645.5 - 1646.5	Above 38.6
8.362 - 8.366	1660 - 1710	
8.37625 - 8.38675	1718.8 - 1722.2	
8.41425 - 8.41475	2200 - 2300	
12.29 - 12.293	2310 - 2360	
12.51975 - 12.52025	2483.5 - 2500	
12.57675 - 12.57725	2655 - 2900	
13.36 - 13.41	3280 - 3267	
16.42 - 16.423	3332 - 3339	
16.69475 - 16.69525	3345.8 - 3358	
16.80425 - 16.80475	3500 - 4400	
25.5 - 25.67	4500 - 5150	
37.5 - 38.25	5350 - 5460	
73 - 74.6	7250 - 7750	
74.8 - 75.2	8025 - 8500	
108 - 138		

**Note 1:** Certain frequency bands listed in table 7 and in bands above 38.6 GHz are designated for licence-exempt applications. These frequency bands and the requirements that apply to related devices are set out in the 200 and 300 series of RSSs.

## TEST SETUP AND PROCEDURE

Below 30MHz

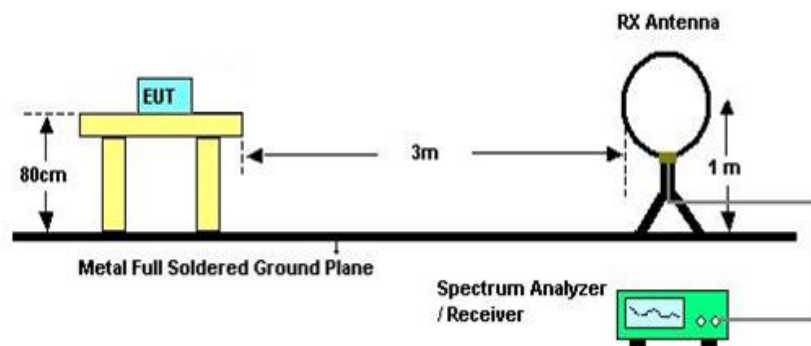

The setting of the spectrum analyser

RBW	200Hz (From 9kHz to 0.15MHz)/ 9KHz (From 0.15MHz to 30MHz)
VBW	200Hz (From 9kHz to 0.15MHz)/ 9KHz (From 0.15MHz to 30MHz)
Sweep	Auto
Detector	Peak/QP/ Average
Trace	Max hold

1. The testing follows the guidelines in ANSI C63.10-2013.
2. The EUT was arranged to its worst case and then turntable (from 0 degree to 360 degrees) to find the maximum reading. A pre-amp and a high pass filter are used for the test in order to get better signal level. Both Horizontal, Face-on and Face-off polarizations of the antenna are set to make the measurement.
3. The EUT was placed on a turntable with 80cm meter above ground.
4. The EUT was set 3 meters from the interference receiving antenna, which was mounted on the top of a 1m height antenna tower.
5. Interconnecting cables that hang closer than 40 cm to the ground plane shall be folded back and forth in the center forming a bundle 30 to 40 cm long.
6. I/O cables that are not connected to a peripheral shall be bundled in the center. The end of the cable may be terminated, if required, using the correct terminating impedance. The overall length shall not exceed 1 m.
7. The radiated emission limits are based on measurements employing a CISPR quasi-peak detector except for the frequency bands 9-90 kHz, 110-490 kHz and above 1000MHz. Radiated emission limits in these three bands are based on measurements employing an average detector.
8. Although these tests were performed other than open area test site, adequate comparison measurements were confirmed against 30m open field site. Therefore, the sufficient tests were made to demonstrate that the alternative site produces results that correlate with the ones of tests made in an open field based on KDB 414788.

Below 1G

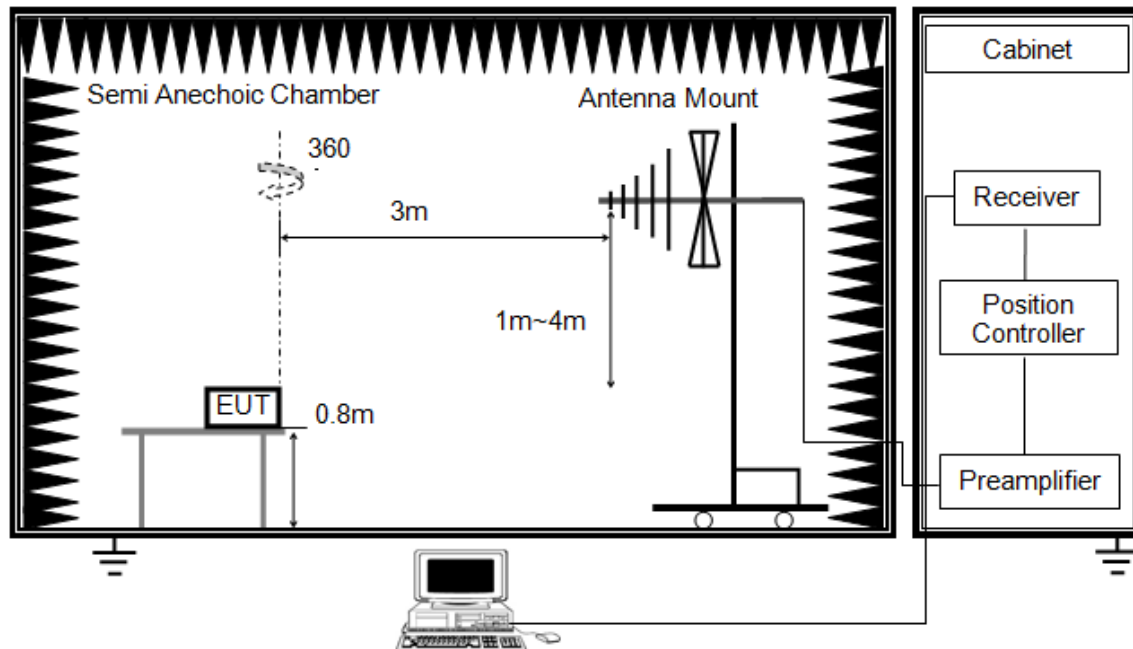

The setting of the spectrum analyser

RBW	120K
VBW	300K
Sweep	Auto
Detector	Peak/QP
Trace	Max hold

1. The testing follows the guidelines in ANSI C63.10-2013.
2. The EUT was arranged to its worst case and then tune the antenna tower (from 1 m to 4 m) and turntable (from 0 degree to 360 degrees) to find the maximum reading. A pre-amp and a high pass filter are used for the test in order to get better signal level. Both horizontal and vertical polarizations of the antenna are set to make the measurement.
3. The EUT was placed on a turntable with 80cm above ground.
4. Interconnecting cables that hang closer than 40 cm to the ground plane shall be folded back and forth in the center forming a bundle 30 to 40 cm long.
5. I/O cables that are not connected to a peripheral shall be bundled in the center. The end of the cable may be terminated, if required, using the correct terminating impedance. The overall length shall not exceed 1 m.
6. The EUT was set 3 meters from the interference receiving antenna, which was mounted on the top of a variable height antenna tower.
7. The initial step in collecting conducted emission data is a spectrum analyzer peak detector mode pre-scanning the measurement frequency range. Significant peaks are then marked and then Quasi Peak detector mode re-measured.

X axis, Y axis, Z axis positions:

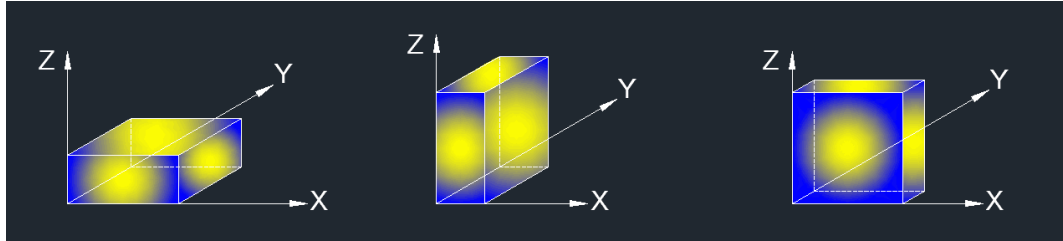

Note 1: For all radiated test, EUT in each of three orthogonal axis emissions had been tested, but only the worst case (X axis) data recorded in the report.

**TEST ENVIRONMENT**

Temperature	23.5 °C	Relative Humidity	57 %
Atmosphere Pressure	101kPa	Test Voltage	AC 120 V, 60 Hz

**RESULTS**

## 7.1. FIELD STRENGTH OF INTENTIONAL EMISSIONS

### FIELD STRENGTH OF INTENTIONAL EMISSIONS (LOOP ANTENNA FACE ON TO THE EUT)

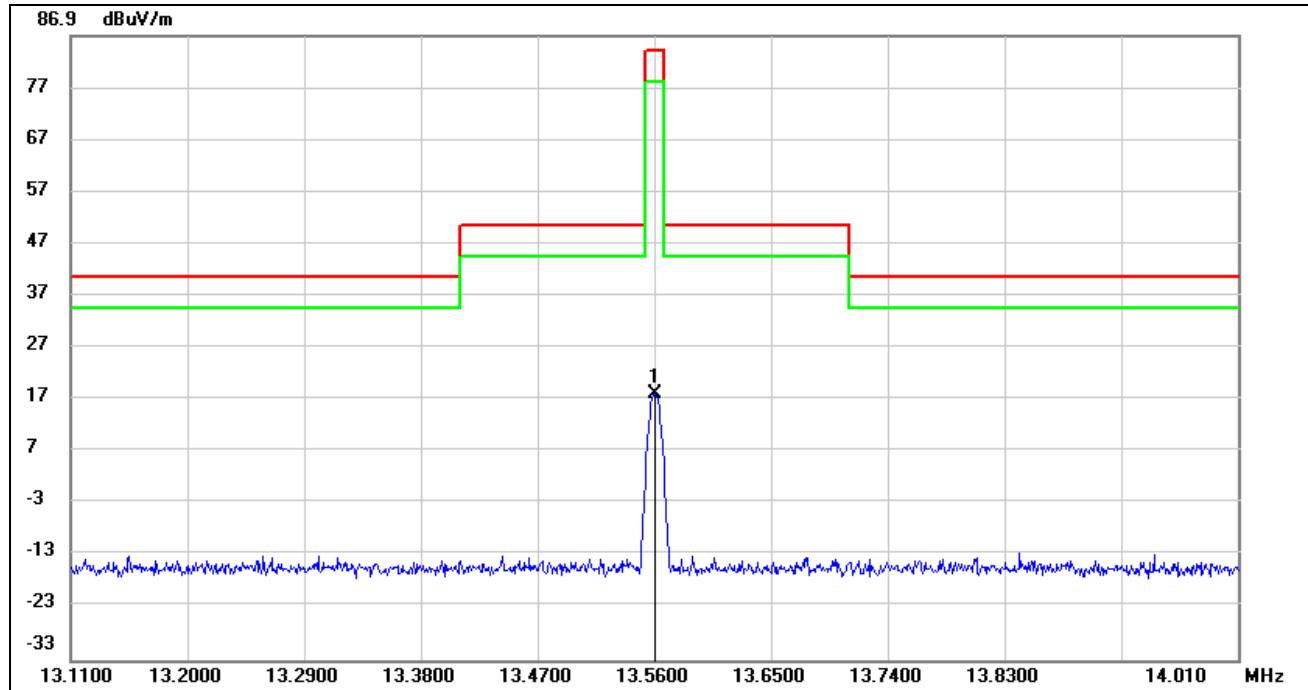

No.	Frequency (MHz)	Reading (dBuV)	Correct (dB/m)	Result (dBuV/m)	Limit (dBuV/m)	Margin (dB)	Remark
1	13.5600	65.62	-47.43	18.19	84.00	-65.81	peak

Note: 1. Result Level = Read Level + Correct Factor.

2. All 3 polarizations (Horizontal, Face-on and Face-off) of the loop antenna had been tested, but only the worst data recorded in the report.



## 7.2. SPURIOUS EMISSIONS BELOW 1GHz AND ABOVE 30MHz

### SPURIOUS EMISSIONS (HORIZONTAL)

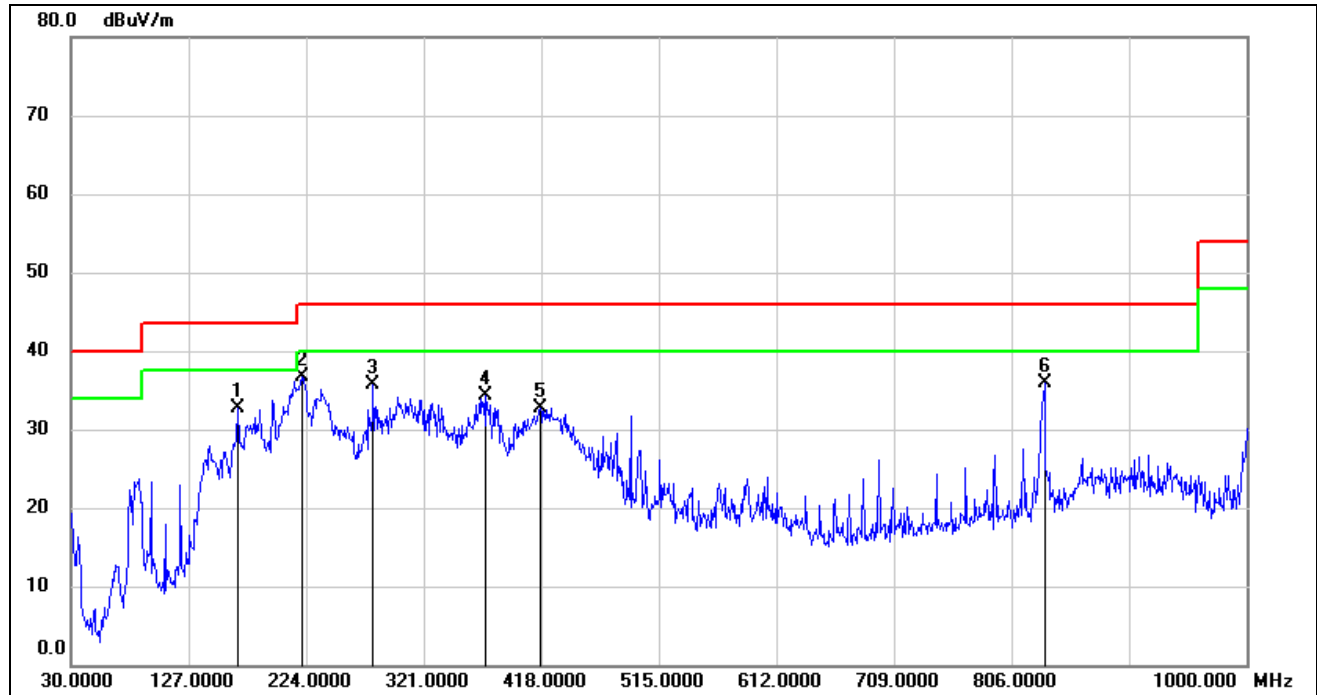

No.	Frequency (MHz)	Reading (dBuV)	Correct (dB/m)	Result (dBuV/m)	Limit (dBuV/m)	Margin (dB)	Remark
1	167.7400	49.75	-17.06	32.69	43.50	-10.81	QP
2	220.1200	54.15	-17.51	36.64	46.00	-9.36	QP
3	279.2900	52.33	-16.67	35.66	46.00	-10.34	QP
4	372.4100	47.23	-12.95	34.28	46.00	-11.72	QP
5	417.0300	45.34	-12.55	32.79	46.00	-13.21	QP
6	833.1599	42.35	-6.38	35.97	46.00	-10.03	QP

Note: 1. Result Level = Read Level + Correct Factor.

### HARMONICS AND SPURIOUS EMISSIONS (VERTICAL)

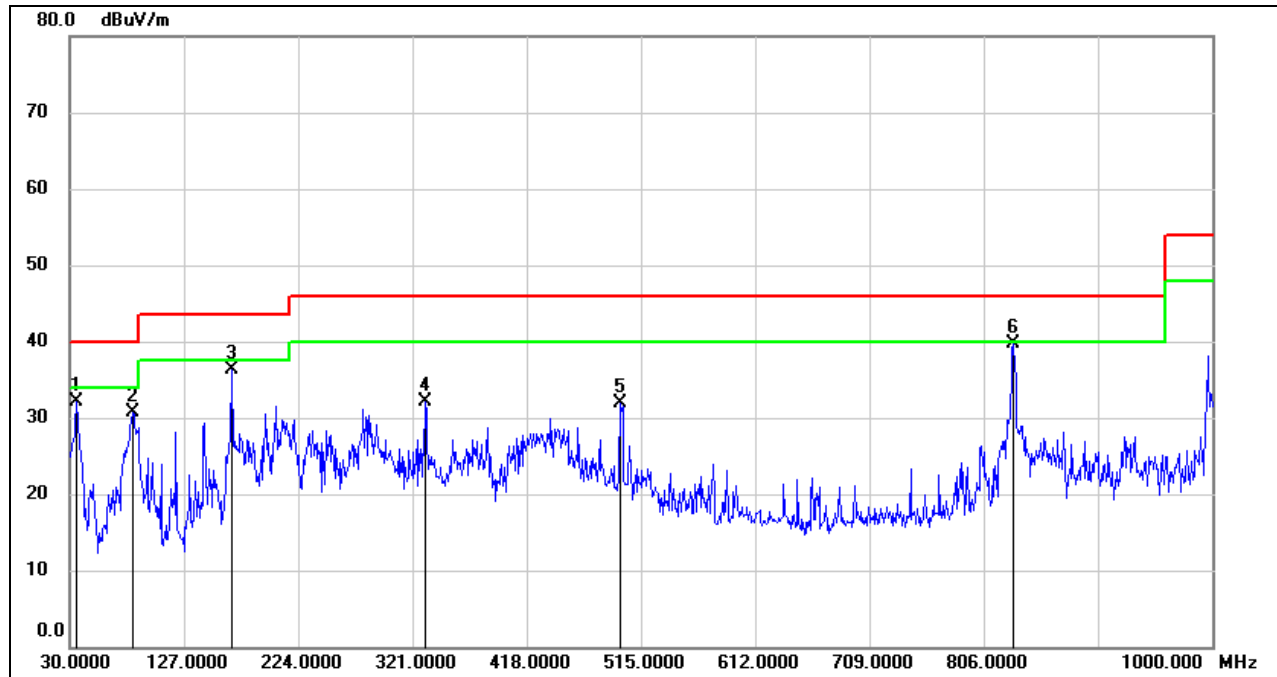

No.	Frequency (MHz)	Reading (dBuV)	Correct (dB/m)	Result (dBuV/m)	Limit (dBuV/m)	Margin (dB)	Remark
1	35.8200	51.20	-19.15	32.05	40.00	-7.95	QP
2	83.3500	52.40	-21.76	30.64	40.00	-9.36	QP
3	167.7400	53.45	-17.06	36.39	43.50	-7.11	QP
4	331.6700	45.82	-13.79	32.03	46.00	-13.97	QP
5	497.5400	42.72	-10.73	31.99	46.00	-14.01	QP
6	831.2199	46.19	-6.40	39.79	46.00	-6.21	QP

Note: 1. Result Level = Read Level + Correct Factor.

### 7.3. SPURIOUS EMISSIONS BELOW 30MHz

#### SPURIOUS EMISSIONS (LOOP ANTENNA FACE ON TO THE EUT)

#### 9 kHz~ 150 kHz

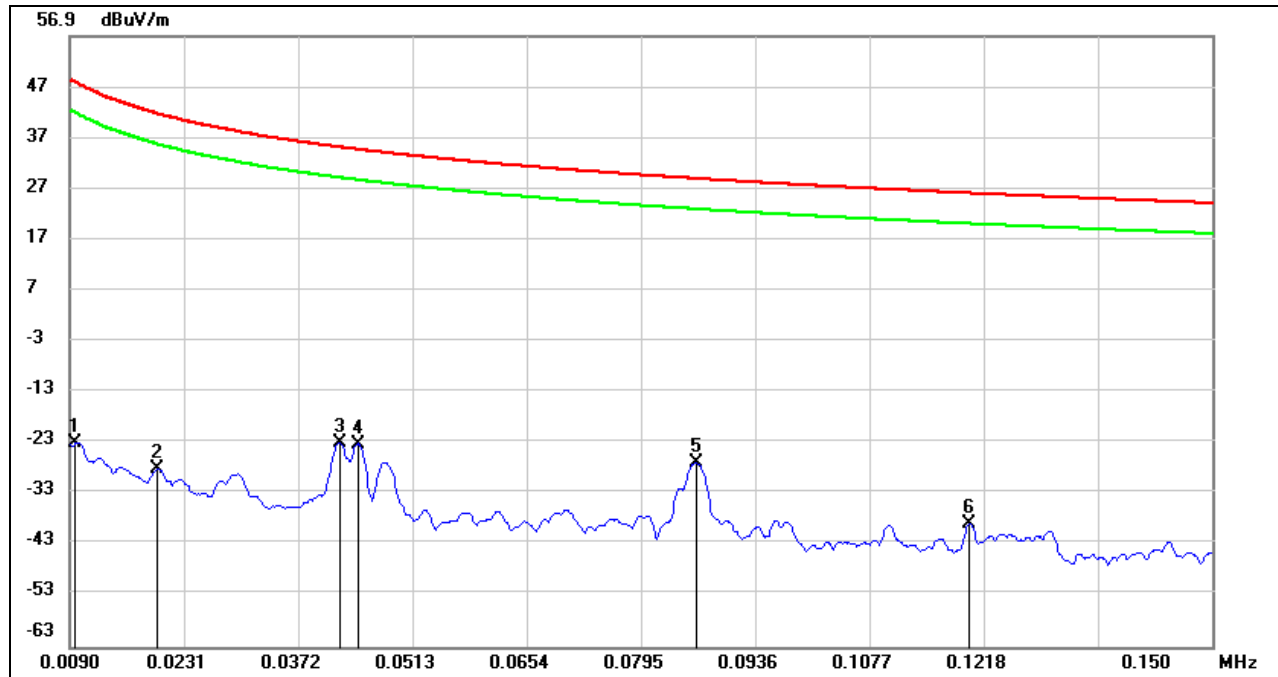

No.	Frequency (MHz)	Reading (dBuV)	Correct (dB/m)	FCC Result (dBuV/m)	FCC Limit (dBuV/m)	ISED Result (dBuA/m)	ISED Limit (dBuA/m)	Margin (dB)	Remark
1	0.0097	64.85	-87.76	-22.91	47.82	-74.41	-3.68	-70.73	peak
2	0.0198	59.47	-87.71	-28.24	41.67	-79.74	-9.83	-69.91	peak
3	0.0422	65.45	-88.46	-23.01	35.09	-74.51	-16.41	-58.1	peak
4	0.0444	65.3	-88.5	-23.2	34.65	-74.7	-16.85	-57.85	peak
5	0.086	61.22	-88.28	-27.06	28.91	-78.56	-22.59	-55.97	peak
6	0.12	49.72	-88.74	-39.02	26.02	-90.52	-25.48	-65.04	peak

Note: 1. Measurement = Reading Level + Correct Factor (dBuA/m= dBuV/m- 20Log10[120π] = dBuV/m- 51.5).

2. If Peak Result complies with AV and QP limit, AV and QP Result are deemed to comply with AV limit.

3. All 3 polarizations (Horizontal, Face-on and Face-off) of the loop antenna had been tested, but only the worst data recorded in the report.

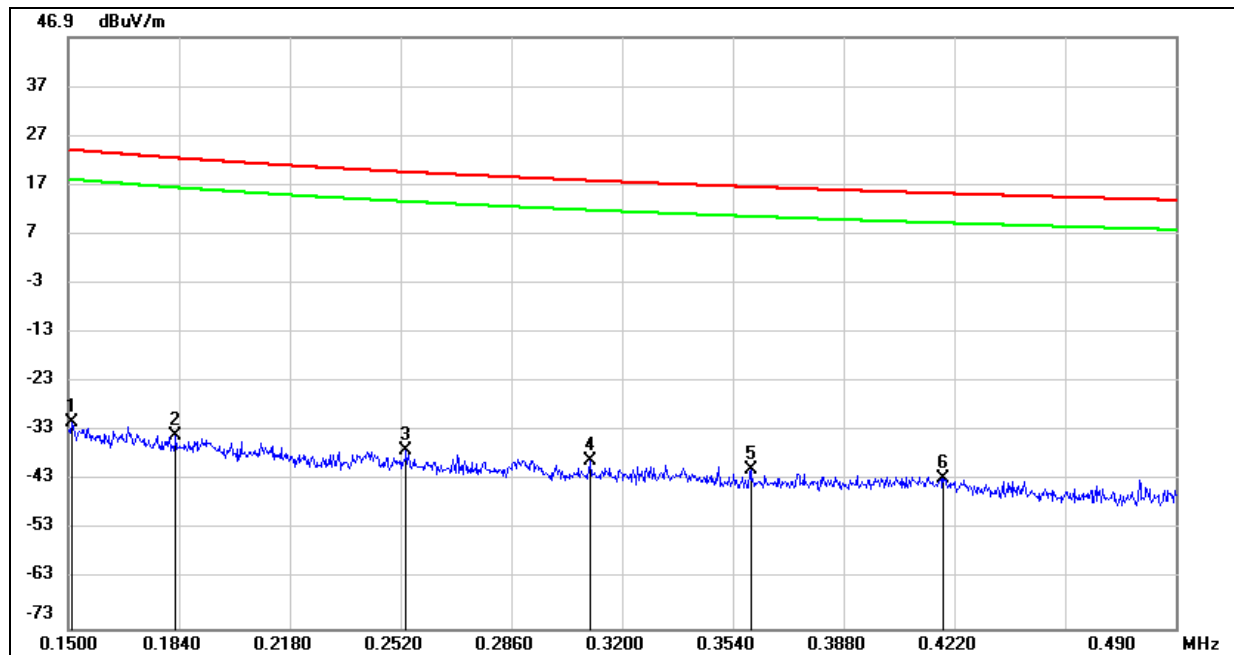
**150 kHz ~ 490 kHz**

No.	Frequency (MHz)	Reading (dBuV)	Correct (dB/m)	FCC Result (dBuV/m)	FCC Limit (dBuV/m)	ISED Result (dBuA/m)	ISED Limit (dBuA/m)	Margin (dB)	Remark
1	0.1508	57.73	-89.1	-31.37	24.03	-82.87	-27.47	-55.4	peak
2	0.1829	54.99	-89.07	-34.08	22.36	-85.58	-29.14	-56.44	peak
3	0.2535	52.08	-89	-36.92	19.52	-88.42	-31.98	-56.44	peak
4	0.31	50.01	-88.98	-38.97	17.77	-90.47	-33.73	-56.74	peak
5	0.3593	48.13	-88.96	-40.83	16.49	-92.33	-35.01	-57.32	peak
6	0.4186	46.18	-88.93	-42.75	15.17	-94.25	-36.33	-57.92	peak

Note: 1. Measurement = Reading Level + Correct Factor (dBuA/m= dBuV/m- 20Log10[120π] = dBuV/m- 51.5).

2. If Peak Result complies with AV and QP limit, AV and QP Result are deemed to comply with AV limit.

3. All 3 polarizations (Horizontal, Face-on and Face-off) of the loop antenna had been tested, but only the worst data recorded in the report.

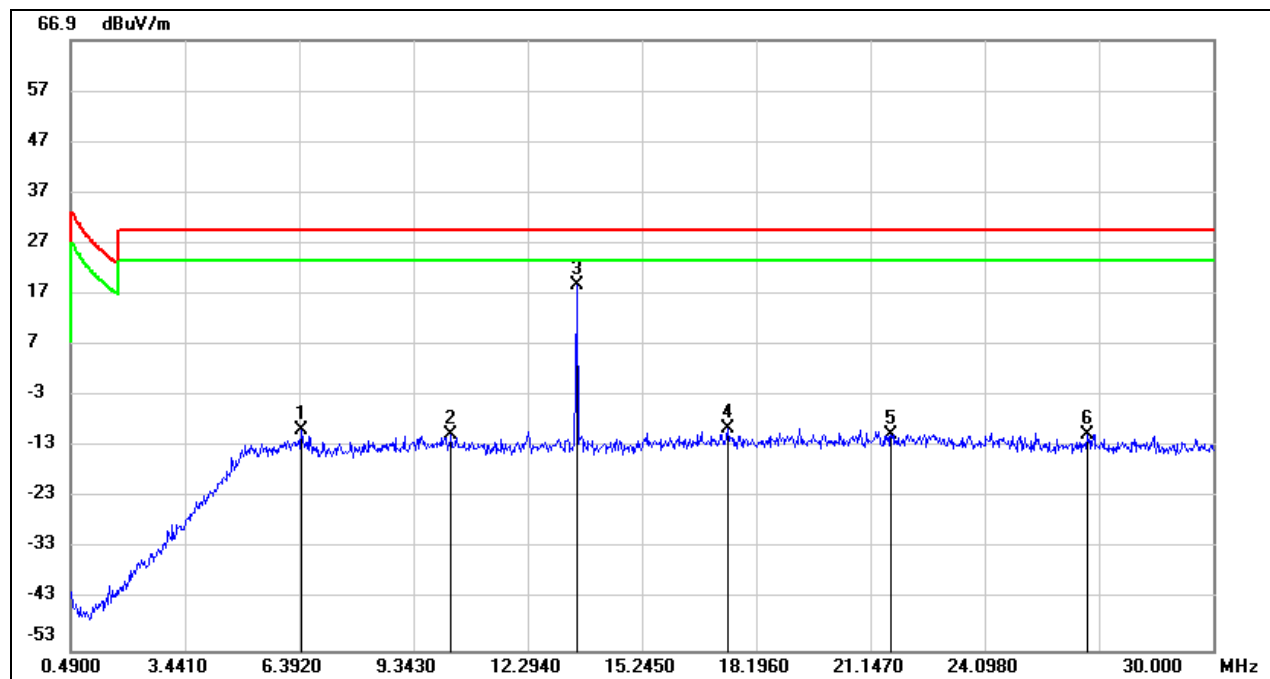
490kHz ~ 30MHz

No.	Frequency (MHz)	Reading (dBuV)	Correct (dB/m)	FCC Result (dBuV/m)	FCC Limit (dBuV/m)	ISED Result (dBuA/m)	ISED Limit (dBuA/m)	Margin (dB)	Remark
1	6.4508	38.55	-48.28	-9.73	29.54	-61.23	-21.96	-39.27	peak
2	10.3168	36.63	-47.41	-10.78	29.54	-62.28	-21.96	-40.32	peak
3	13.5629	65.11	-47.43	17.68	/	-33.82	/	/	fundamental
4	17.4582	37.6	-47.13	-9.53	29.54	-61.03	-21.96	-39.07	peak
5	21.6781	36.19	-46.75	-10.56	29.54	-62.06	-21.96	-40.1	peak
6	26.7539	36.01	-46.52	-10.51	29.54	-62.01	-21.96	-40.05	peak

Note: 1. Measurement = Reading Level + Correct Factor (dBuA/m= dBuV/m- 20Log10[120π] = dBuV/m- 51.5).

2. If Peak Result complies with AV and QP limit, AV and QP Result are deemed to comply with AV limit.

3. All 3 polarizations (Horizontal, Face-on and Face-off) of the loop antenna had been tested, but only the worst data recorded in the report.

4. About the Fundamental emission test result please refer to section 7.1.

## 8. AC POWER LINE CONDUCTED EMISSIONS

### LIMITS

Please refer to CFR 47 FCC §15.207 (a).

FREQUENCY (MHz)	Quasi-peak	Average
0.15 -0.5	66 - 56 *	56 - 46 *
0.50 -5.0	56.00	46.00
5.0 -30.0	60.00	50.00

Note:

- (1) The tighter limit applies at the band edges.
- (2) The limit of " \* " marked band means the limitation decreases linearly with the logarithm of the frequency in the range.

## TEST SETUP AND PROCEDURE

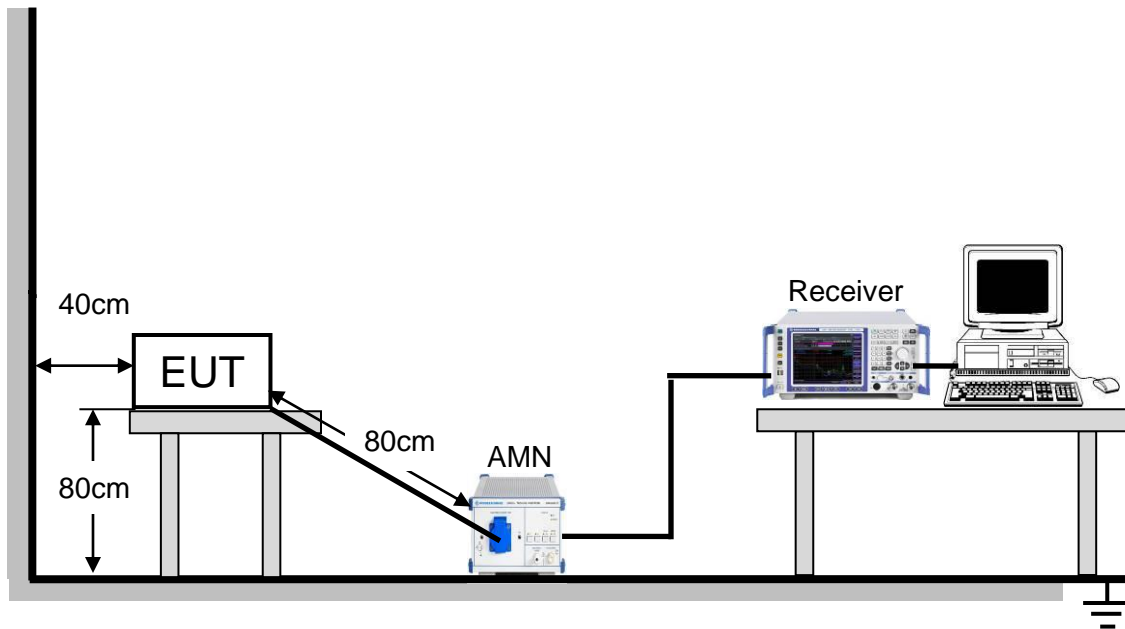

The following table is the setting of the receiver

Receiver Parameters	Setting
Attenuation	10 dB
Start Frequency	0.15 MHz
Stop Frequency	30 MHz
IF Bandwidth	9 kHz

1. The testing follows the guidelines in ANSI C63.10-2013.
2. The EUT was placed on the top of a rotating table 0.8 meters above the horizontal ground plane and being connected to the power mains through a line impedance stabilization network (LISN). All other support equipment powered from additional LISN(s). The LISN provide 50 ohm/ 50uH of coupling impedance for the measuring instrument.
3. Interconnecting cables that hang closer than 40 cm to the ground plane shall be folded back and forth in the center forming a bundle 30 to 40 cm long.
4. I/O cables that are not connected to a peripheral shall be bundled in the center. The end of the cable may be terminated, if required, using the correct terminating impedance. The overall length shall not exceed 1 m.
5. LISN at least 80 cm from nearest part of EUT chassis.
6. Conducted emissions from the EUT measured in the frequency range between 0.15 MHz and 30MHz using CISPR Quasi-Peak and average detector mode.
7. The arrangement of the equipment is installed to meet the standards and operating in a manner, which tends to maximize its emission characteristics in a normal application.

**TEST ENVIRONMENT**

Temperature	23.2°C	Relative Humidity	61%
Atmosphere Pressure	101kPa	Test Voltage	AC 120V_60Hz

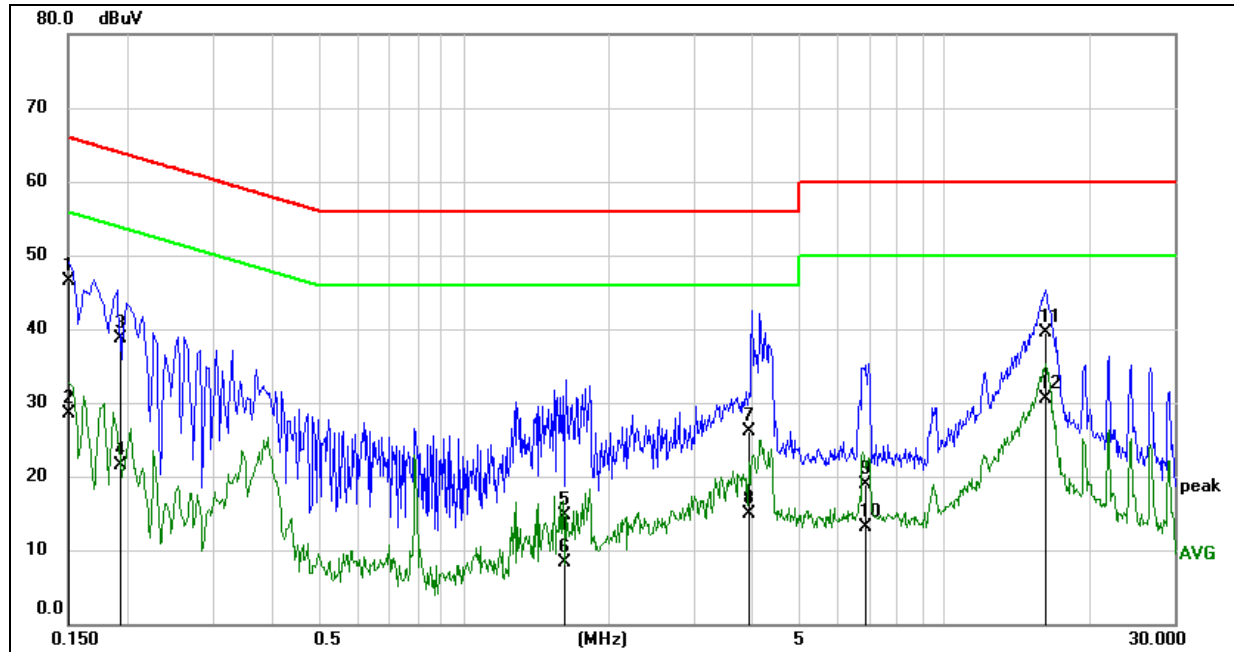
**LINE N RESULTS with modified sample (transmitter terminated into a dummy load)**

No.	Frequency (MHz)	Reading (dBuV)	Correct (dB)	Result (dBuV)	Limit (dBuV)	Margin (dB)	Remark
1	0.1512	36.91	9.59	46.50	65.93	-19.43	QP
2	0.1512	18.92	9.59	28.51	55.93	-27.42	AVG
3	0.1927	29.05	9.59	38.64	63.92	-25.28	QP
4	0.1927	11.94	9.59	21.53	53.92	-32.39	AVG
5	1.6183	5.02	9.62	14.64	56.00	-41.36	QP
6	1.6183	-1.33	9.62	8.29	46.00	-37.71	AVG
7	3.8895	16.49	9.69	26.18	56.00	-29.82	QP
8	3.8895	5.23	9.69	14.92	46.00	-31.08	AVG
9	6.9004	9.25	9.73	18.98	60.00	-41.02	QP
10	6.9004	3.42	9.73	13.15	50.00	-36.85	AVG
11	16.2354	29.80	9.75	39.55	60.00	-20.45	QP
12	16.2354	20.79	9.75	30.54	50.00	-19.46	AVG

Note: 1. Result = Reading +Correct Factor.

2. If QP Result complies with AV limit, AV Result is deemed to comply with AV limit.

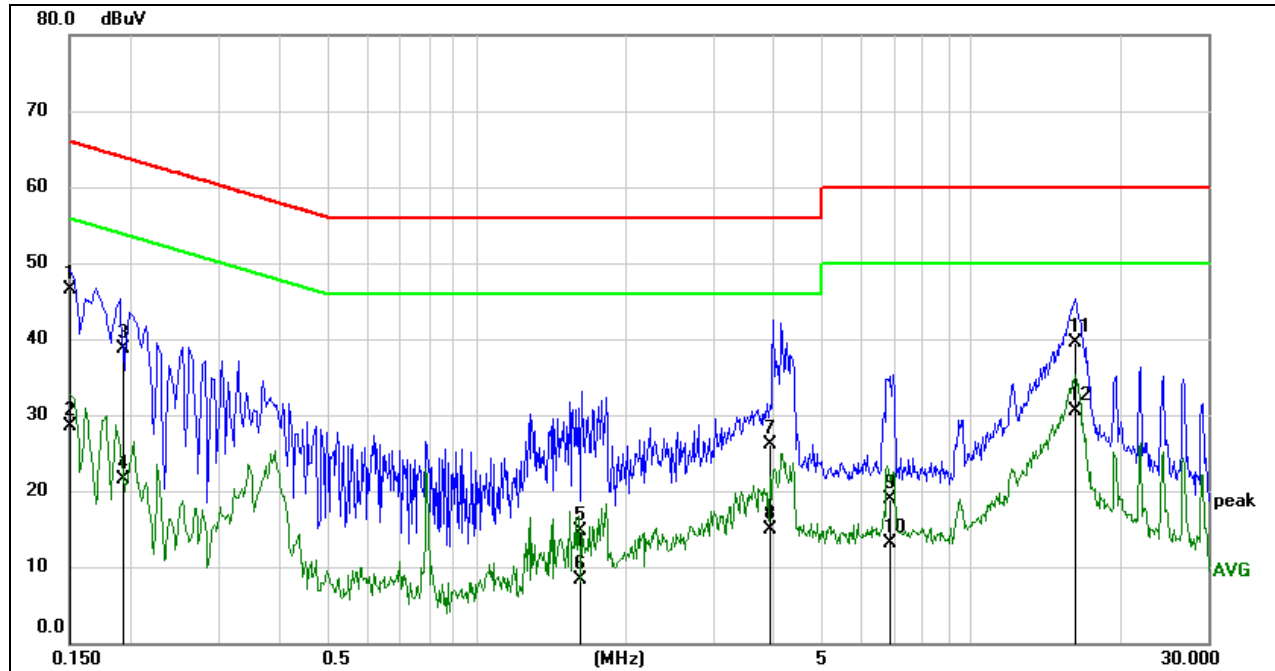

**LINE L RESULTS with modified sample (transmitter terminated into a dummy load)**

No.	Frequency (MHz)	Reading (dBuV)	Correct (dB)	Result (dBuV)	Limit (dBuV)	Margin (dB)	Remark
1	0.1512	36.91	9.59	46.50	65.93	-19.43	QP
2	0.1512	18.92	9.59	28.51	55.93	-27.42	AVG
3	0.1927	29.05	9.59	38.64	63.92	-25.28	QP
4	0.1927	11.94	9.59	21.53	53.92	-32.39	AVG
5	1.6183	5.02	9.62	14.64	56.00	-41.36	QP
6	1.6183	-1.33	9.62	8.29	46.00	-37.71	AVG
7	3.8895	16.49	9.69	26.18	56.00	-29.82	QP
8	3.8895	5.23	9.69	14.92	46.00	-31.08	AVG
9	6.9004	9.25	9.73	18.98	60.00	-41.02	QP
10	6.9004	3.42	9.73	13.15	50.00	-36.85	AVG
11	16.2354	29.80	9.75	39.55	60.00	-20.45	QP
12	16.2354	20.79	9.75	30.54	50.00	-19.46	AVG

Note: 1. Result = Reading +Correct Factor.

2. If QP Result complies with AV limit, AV Result is deemed to comply with AV limit.

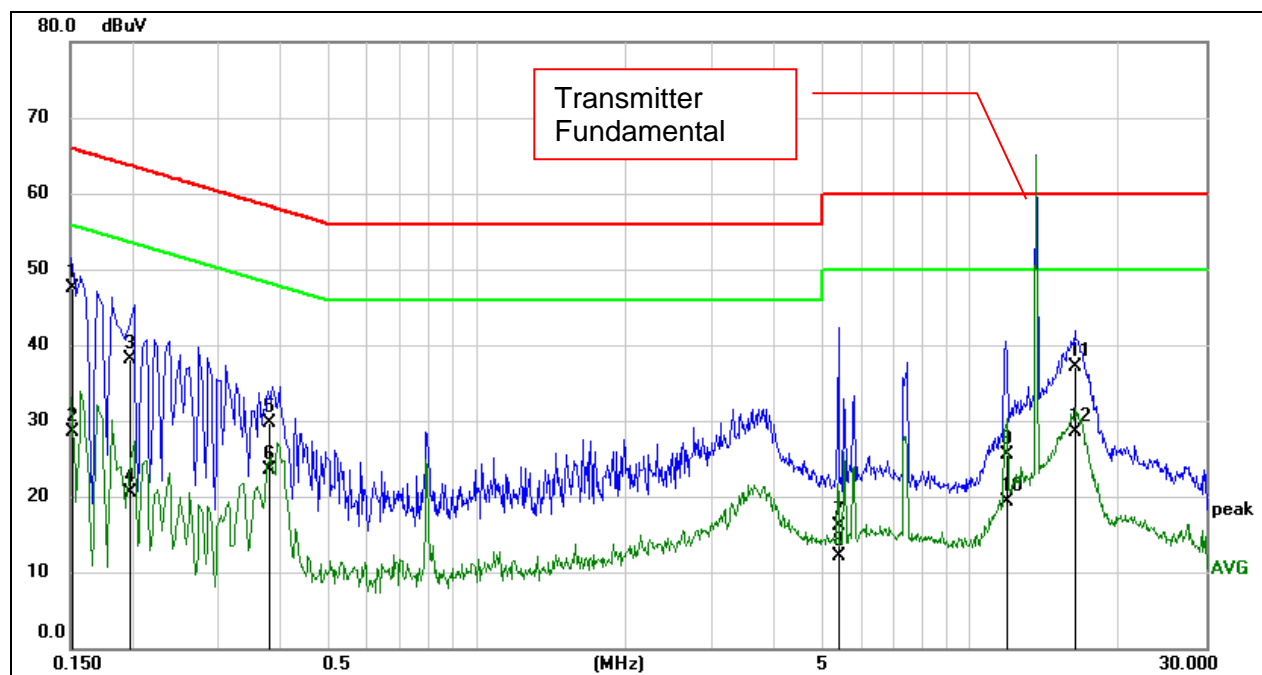
**LINE N RESULTS with unmodified sample (antenna present)**

No.	Frequency (MHz)	Reading (dBuV)	Correct (dB)	Result (dBuV)	Limit (dBuV)	Margin (dB)	Remark
1	0.1516	37.88	9.59	47.47	65.91	-18.44	QP
2	0.1516	18.83	9.59	28.42	55.91	-27.49	AVG
3	0.1972	28.58	9.59	38.17	63.73	-25.56	QP
4	0.1972	10.92	9.59	20.51	53.73	-33.22	AVG
5	0.3814	20.10	9.59	29.69	58.25	-28.56	QP
6	0.3814	13.92	9.59	23.51	48.25	-24.74	AVG
7	5.4141	6.38	9.73	16.11	60.00	-43.89	QP
8	5.4141	2.39	9.73	12.12	50.00	-37.88	AVG
9	11.8727	15.69	9.75	25.44	60.00	-34.56	QP
10	11.8727	9.50	9.75	19.25	50.00	-30.75	AVG
11	16.2928	27.37	9.75	37.12	60.00	-22.88	QP
12	16.2928	18.76	9.75	28.51	50.00	-21.49	AVG

Note: 1. Result = Reading +Correct Factor.

2. If QP Result complies with AV limit, AV Result is deemed to comply with AV limit.

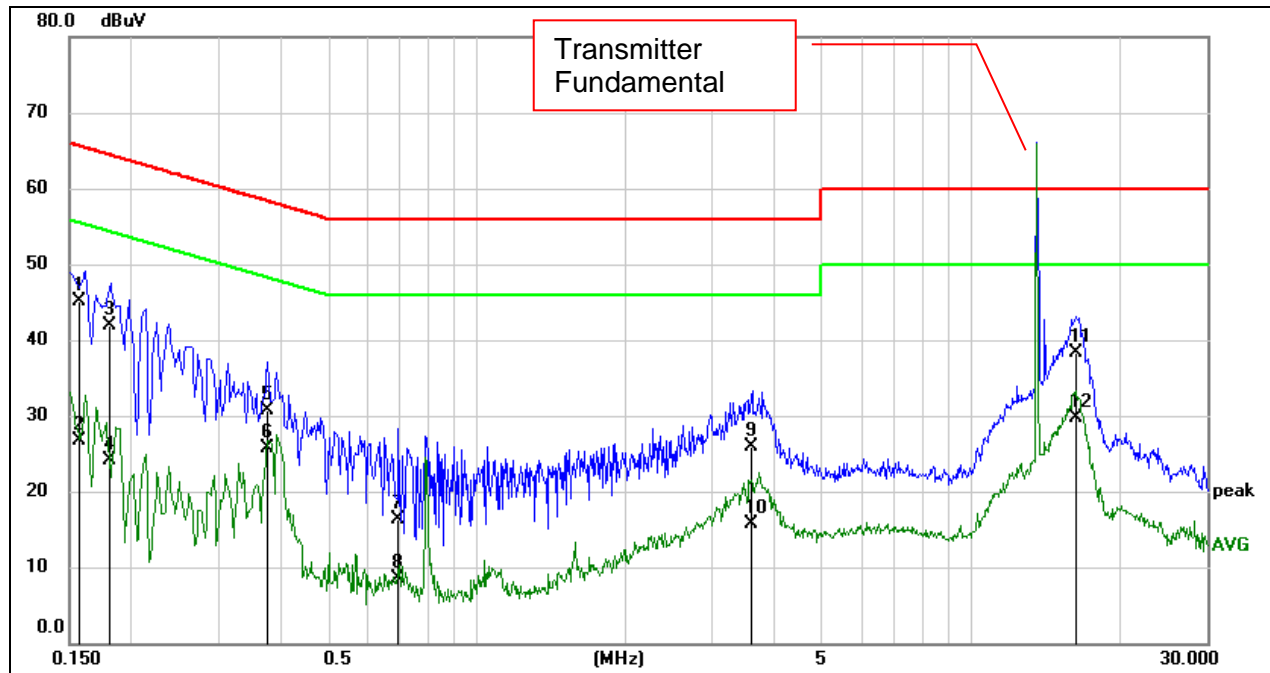
**LINE L RESULTS with unmodified sample (antenna present)**

No.	Frequency (MHz)	Reading (dBuV)	Correct (dB)	Result (dBuV)	Limit (dBuV)	Margin (dB)	Remark
1	0.1576	35.51	9.59	45.10	65.59	-20.49	QP
2	0.1576	17.10	9.59	26.69	55.59	-28.90	AVG
3	0.1802	32.35	9.59	41.94	64.48	-22.54	QP
4	0.1802	14.53	9.59	24.12	54.48	-30.36	AVG
5	0.3786	21.16	9.59	30.75	58.31	-27.56	QP
6	0.3786	16.10	9.59	25.69	48.31	-22.62	AVG
7	0.6968	6.67	9.60	16.27	56.00	-39.73	QP
8	0.6968	-1.04	9.60	8.56	46.00	-37.44	AVG
9	3.5950	16.26	9.69	25.95	56.00	-30.05	QP
10	3.5950	6.10	9.69	15.79	46.00	-30.21	AVG
11	16.2863	28.60	9.75	38.35	60.00	-21.65	QP
12	16.2863	19.95	9.75	29.70	50.00	-20.30	AVG

Note: 1. Result = Reading +Correct Factor.

2. If QP Result complies with AV limit, AV Result is deemed to comply with AV limit.

## 9. ANTENNA REQUIREMENTS

### APPLICABLE REQUIREMENTS

Please refer to FCC §15.203

An intentional radiator shall be designed to ensure that no antenna other than that furnished by the responsible party shall be used with the device. The use of a permanently attached antenna or of an antenna that uses a unique coupling to the intentional radiator shall be considered sufficient to comply with the provisions of this section. The manufacturer may design the unit so that a broken antenna can be replaced by the user, but the use of a standard antenna jack or electrical connector is prohibited.

### RESULTS

Complies

---

**END OF REPORT**