



Test Report No.: RF180521W014-3

FCC TEST REPORT (PART 27)



| | |
|------------|---|
| Applicant: | Gosuncn Technology Group Co., Ltd. |
| Address: | 6F, 2819 KaiChuang Blvd., Science Town, Huangpu District, Guangzhou City, Guangdong, China. |

| | |
|---------------------------|---|
| Manufacturer or Supplier: | Gosuncn Technology Group Co., Ltd. |
| Address: | 6F, 2819 KaiChuang Blvd., Science Town, Huangpu District, Guangzhou City, Guangdong, China. |
| Product: | LTE Module |
| Brand Name: | GOSUNCN |
| Model Name: | GM500_U1A |
| FCC ID: | 2APNR-GM500U1A |
| Date of tests: | Apr. 27, 2018 ~ May 29, 2017 |

The tests have been carried out according to the requirements of the following standard:

- FCC Part 27, Subpart C, L ANSI/TIA/EIA-603- D
- FCC Part 2 ANSI/TIA/EIA-603-E ANSI C63.26-2015

CONCLUSION: The submitted sample was found to COMPLY with the test requirement

| | |
|---|---|
| Prepared by Yuqiang Yin Engineer / Mobile Department | Approved by Sam Tung Manager / Mobile Department |
|  Date: May 30, 2017 |  Date: May 30, 2017 |

This report is governed by, and incorporates by reference, CPS Conditions of Service as posted at the date of issuance of this report at <http://www.bureauveritas.com/home/about-us/our-business/cps/about-us/terms-conditions> and is intended for your exclusive use. Any copying or replication of this report to or for any other person or entity, or use of our name or trademark, is permitted only with our prior written permission. This report sets forth our findings solely with respect to the test samples identified herein. The results set forth in this report are not indicative or representative of the quality or characteristics of the lot from which a test sample was taken or any similar or identical product unless specifically and expressly noted. Our report includes all of the tests requested by you and the results thereof based upon the information that you provided to us. Measurement uncertainty is only provided upon request for accredited tests. You have 60 days from date of issuance of this report to notify us of any material error or omission caused by our negligence or if you require measurement uncertainty; provided, however, that such notice shall be in writing and shall specifically address the issue you wish to raise. A failure to raise such issue within the prescribed time shall constitute your unqualified acceptance of the completeness of this report, the tests conducted and the correctness of the report contents.



TABLE OF CONTENTS

| | |
|--|-----------|
| RELEASE CONTROL RECORD | 4 |
| 1 SUMMARY OF TEST RESULTS | 5 |
| 1.1 MEASUREMENT UNCERTAINTY | 5 |
| 1.2 TEST SITE AND INSTRUMENTS | 6 |
| 2 GENERAL INFORMATION..... | 7 |
| 2.1 GENERAL DESCRIPTION OF EUT..... | 7 |
| 2.2 CONFIGURATION OF SYSTEM UNDER TEST | 9 |
| 2.3 DESCRIPTION OF SUPPORT UNITS | 10 |
| 2.4 DESCRIPTION OF TEST MODES..... | 10 |
| 2.5 GENERAL DESCRIPTION OF APPLIED STANDARDS..... | 14 |
| 3 TEST TYPES AND RESULTS | 15 |
| 3.1 OUTPUT POWER MEASUREMENT | 15 |
| 3.1.1 LIMITS OF OUTPUT POWER MEASUREMENT | 15 |
| 3.1.2 TEST PROCEDURES | 15 |
| 3.1.3 TEST SETUP..... | 16 |
| 3.1.4 TEST RESULTS | 17 |
| 3.2 FREQUENCY STABILITY MEASUREMENT | 29 |
| 3.2.1 LIMITS OF FREQUENCY STABILITY MEASUREMENT | 29 |
| 3.2.2 TEST PROCEDURE | 29 |
| 3.2.3 TEST SETUP..... | 29 |
| 3.2.4 TEST RESULTS | 30 |
| 3.3 OCCUPIED BANDWIDTH MEASUREMENT | 40 |
| 3.3.1 LIMITS OF OCCUPIED BANDWIDTH MEASUREMENT | 40 |
| 3.3.2 TEST SETUP..... | 40 |
| 3.3.3 TEST PROCEDURES | 40 |
| 3.3.4 TEST RESULTS | 41 |
| 3.4 PEAK TO AVERAGE RATIO | 46 |
| 3.4.1 LIMITS OF PEAK TO AVERAGE RATIO MEASUREMENT..... | 46 |
| 3.4.2 TEST SETUP..... | 46 |
| 3.4.3 TEST PROCEDURES | 46 |
| 3.4.4 TEST RESULTS | 47 |
| 3.5 BAND EDGE MEASUREMENT | 52 |
| 3.5.1 LIMITS OF BAND EDGE MEASUREMENT | 52 |
| 3.5.2 TEST SETUP..... | 52 |
| 3.5.3 TEST PROCEDURES | 53 |
| 3.5.4 TEST RESULTS | 54 |
| 3.6 CONDUCTED SPURIOUS EMISSIONS..... | 64 |
| 3.6.1 LIMITS OF CONDUCTED SPURIOUS EMISSIONS MEASUREMENT | 64 |
| 3.6.2 TEST PROCEDURE | 64 |
| 3.6.3 TEST SETUP..... | 64 |
| 3.6.4 TEST RESULTS | 65 |
| 3.7 RADIATED EMISSION MEASUREMENT..... | 75 |
| 3.7.1 LIMITS OF RADIATED EMISSION MEASUREMENT | 75 |
| 3.7.2 TEST PROCEDURES | 75 |
| 3.7.3 DEVIATION FROM TEST STANDARD | 75 |
| 3.7.4 TEST SETUP..... | 76 |
| 3.7.5 TEST RESULTS | 78 |



**BUREAU
VERITAS**

Test Report No.: RF180521W014-3

| | | |
|----------|---|------------|
| 4 | INFORMATION ON THE TESTING LABORATORIES | 108 |
| 5 | APPENDIX A – MODIFICATIONS RECORDERS FOR ENGINEERING CHANGES TO THE EUT BY THE LAB | 109 |



Test Report No.: RF180521W014-3

RELEASE CONTROL RECORD

| ISSUE NO. | REASON FOR CHANGE | DATE ISSUED |
|----------------|-------------------|--------------|
| RF180521W014-3 | Original release | May 30, 2017 |

1 SUMMARY OF TEST RESULTS

The EUT has been tested according to the following specifications:

| APPLIED STANDARD: FCC Part 27 & Part 2 | | | |
|--|------------------------------|--------|---|
| STANDARD SECTION | TEST TYPE AND LIMIT | RESULT | REMARK |
| 2.1046 27.50(d)(4) | Maximum Peak Output Power | PASS | Meet the requirement of limit. |
| 2.1055 27.54 | Frequency Stability | PASS | Meet the requirement of limit. |
| 2.1049 27.53(h) | Occupied Bandwidth | PASS | Meet the requirement of limit. |
| 27.50(d)(5) | Peak to average ratio | PASS | Meet the requirement of limit. |
| 27.53(h) | Band Edge Measurements | PASS | Meet the requirement of limit. |
| 2.1051 27.53(h) | Conducted Spurious Emissions | PASS | Meet the requirement of limit. |
| 2.1053 27.53(h) | Radiated Spurious Emissions | PASS | Meet the requirement of limit. Minimum passing margin is -10.48dB at 3470.000MHz. |

1.1 MEASUREMENT UNCERTAINTY

Where relevant, the following measurement uncertainty levels have been estimated for tests performed on the EUT as specified in CISPR 16-4-2:

| MEASUREMENT | FREQUENCY | UNCERTAINTY |
|---------------------|---------------|-------------|
| Conducted emissions | 9kHz~30MHz | 2.66dB |
| Radiated emissions | 9KHz ~ 30MHz | 2.68dB |
| | 30MHz ~ 1GMHz | 3.26dB |
| | 1GHz ~ 18GHz | 4.48dB |
| | 18GHz ~ 40GHz | 4.12dB |

This uncertainty represents an expanded uncertainty expressed at approximately the 95% confidence level using a coverage factor of k=2.



1.2 TEST SITE AND INSTRUMENTS

| Equipment | Manufacturer | Model No. | Serial No. | Last Cal. | Next Cal. |
|---------------------------------------|--------------|-----------------------------|-----------------------------|------------|------------|
| MXE EMI Receiver | KEYSIGHT | N9038A-544 | MY54450026 | Mar. 16,18 | Mar. 15,19 |
| EXA Signal Analyzer | KEYSIGHT | N9010A-544 | MY54510332 | Jun. 28,17 | Jun. 27,18 |
| Bilog Antenna 1 | ETS-LINDGREN | 3143B | 00161964 | Nov. 26,16 | Nov. 25,18 |
| Bilog Antenna 2 | ETS-LINDGREN | 3143B | 00161965 | Nov. 26,16 | Nov. 25,18 |
| Horn Antenna 1 | ETS-LINDGREN | 3117 | 00168728 | Nov. 26,16 | Nov. 25,18 |
| Horn Antenna 2 | ETS-LINDGREN | 3117 | 00168692 | Nov. 26,16 | Nov. 25,18 |
| Loop antenna | Daze | ZN30900A | 0708 | Nov. 20,17 | Nov. 19,18 |
| Horn Antenna (18GHz-40GHz) | N/A | QWH-SL-18-40-K-SG/QMS-00361 | 15433 | Dec. 16,16 | Dec. 15,18 |
| Radio Communication Analyzer | ANRITSU | MT8820C | 6201465426 | Mar. 02,18 | Mar. 01,19 |
| Signal Pre-Amplifier | EMSI | EMC 9135 | 980249 | Jul. 24,17 | Jul. 23,18 |
| Signal Pre-Amplifier | EMSI | EMC 012645B | 980257 | Jul. 24,17 | Jul. 23,18 |
| Signal Pre-Amplifier | EMSI | EMC 184045B | 980259 | Jul. 24,17 | Jul. 23,18 |
| 3m Semi-anechoic Chamber | ETS-LINDGREN | 9m*6m*6m | Euroshieldpn-CT0001143-1216 | Apr. 21,18 | Apr. 20,19 |
| Test Software | E3 | V 9.160323 | N/A | N/A | N/A |
| Test Software | ADT | ADT_Radiated_V7.6.15.9.2 | N/A | N/A | N/A |
| 10dB Attenuator | JFW/USA | 50HF-010-SMA | 1505 | Jul. 24,17 | Jul. 23,18 |
| Power Meter | Anritsu | ML2495A | 1506002 | Mar. 02,18 | Mar. 01,19 |
| Power Sensor | Anritsu | MA2411B | 1339352 | Mar. 16,18 | Mar. 15,19 |
| Humid & Temp Programmable Tester | Juyi | ITH-120-45-CP-AR | IAA1504-001 | Jul. 18,17 | Jul. 17,18 |
| MXG Analog Microwave Signal Generator | KEYSIGHT | N5183A | MY50143024 | Mar. 13,18 | Mar. 12,19 |

- NOTE:**
1. The calibration interval of the above test instruments is 12 months or 24 months and the calibrations are traceable to CEPREI/CHINA, GRGT/CHINA and NIM/CHINA.
 2. The test was performed in 3m Semi-anechoic Chamber and RF Oven Room.
 3. The horn antenna is used only for the measurement of emission frequency above 1GHz if tested.
 4. The FCC Site Registration No. is 525120.

2 GENERAL INFORMATION

2.1 GENERAL DESCRIPTION OF EUT

| | | | |
|--|--|---|---------------------------------|
| PRODUCT | LTE Module | | |
| MODEL NAME | GM500_U1A | | |
| POWER SUPPLY | DC 3.8V | | |
| MODULATION TECHNOLOGY | LTE | QPSK, 16QAM | |
| FREQUENCY RANGE | LTE Band 4 Channel Bandwidth: 1.4MHz | 1710.7MHz ~ 1754.3MHz | |
| | LTE Band 4 Channel Bandwidth: 3MHz | 1711.5MHz ~ 1753.5MHz | |
| | LTE Band 4 Channel Bandwidth: 5MHz | 1712.5MHz ~ 1752.5MHz | |
| | LTE Band 4 Channel Bandwidth: 10MHz | 1715.0MHz ~ 1750.0MHz | |
| | LTE Band 4 Channel Bandwidth: 15MHz | 1717.5MHz ~ 1747.5MHz | |
| | LTE Band 4 Channel Bandwidth: 20MHz | 1720.0MHz ~ 1745.0MHz | |
| | LTE Band 12 Channel Bandwidth: 1.4MHz | 699.7MHz ~ 715.3MHz | |
| | LTE Band 12 Channel Bandwidth: 3MHz | 700.5MHz ~ 714.5MHz | |
| | LTE Band 12 Channel Bandwidth: 5MHz | 701.5MHz ~ 713.5MHz | |
| | LTE Band 12 Channel Bandwidth: 10MHz | 704.0MHz ~ 711.0MHz | |
| | EMISSION DESIGNATOR | LTE Band 4 Channel Bandwidth: 1.4MHz | QPSK: 1M09G7D 16QAM: 1M08W7D |
| | | LTE Band 4 Channel Bandwidth: 3MHz | QPSK: 2M68G7D 16QAM: 2M69W7D |
| LTE Band 4 Channel Bandwidth: 5MHz | | QPSK: 4M48G7D 16QAM: 4M50W7D | |
| LTE Band 4 Channel Bandwidth: 10MHz | | QPSK: 8M92G7D 16QAM: 8M94W7D | |
| LTE Band 4 Channel Bandwidth: 15MHz | | QPSK: 13M4G7D 16QAM: 13M4W7D | |
| LTE Band 4 Channel Bandwidth: 20MHz | | QPSK: 17M8G7D 16QAM: 17M8W7D | |

| | | |
|----------------------------|--|-----------------------------------|
| EMISSION DESIGNATOR | LTE Band 12 Channel Bandwidth: 1.4MHz | QPSK: 1M09G7D 16QAM: 1M09W7D |
| | LTE Band 12 Channel Bandwidth: 3MHz | QPSK: 2M69G7D 16QAM: 2M69W7D |
| | LTE Band 12 Channel Bandwidth: 5MHz | QPSK: 4M49G7D 16QAM: 4M48W7D |
| | LTE Band 12 Channel Bandwidth: 10MHz | QPSK: 8M94G7D 16QAM: 8M94W7D |
| MAX. ERP/EIRP POWER | LTE Band 4 Channel Bandwidth: 1.4MHz | 490mW |
| | LTE Band 4 Channel Bandwidth: 3MHz | 483mW |
| | LTE Band 4 Channel Bandwidth: 5MHz | 489mW |
| | LTE Band 4 Channel Bandwidth: 10MHz | 495mW |
| | LTE Band 4 Channel Bandwidth: 15MHz | 488mW |
| | LTE Band 4 Channel Bandwidth: 20MHz | 439mW |
| | LTE Band 12 Channel Bandwidth: 1.4MHz | 195mW |
| | LTE Band 12 Channel Bandwidth: 3MHz | 198mW |
| | LTE Band 12 Channel Bandwidth: 5MHz | 195mW |
| | LTE Band 12 Channel Bandwidth: 10MHz | 175mW |
| ANTENNA TYPE | LTE Band 4 | External antenna with 4.8dBi gain |
| | LTE Band 12 | External antenna with 3.5dBi gain |
| HW VERSION | GM500-MB_A | |
| SW VERSION | GM500U1A1.0B01 | |
| ACCESSORY DEVICE | Refer to note as below | |
| DATA CABLE | N/A | |

NOTE:

1. For a more detailed features description, please refer to the manufacturer's specifications or the user's manual.
2. For the test results, the EUT had been tested with all conditions. But only the worst case was shown in test report.

2.2 CONFIGURATION OF SYSTEM UNDER TEST

FOR RADIATION EMISSION TEST

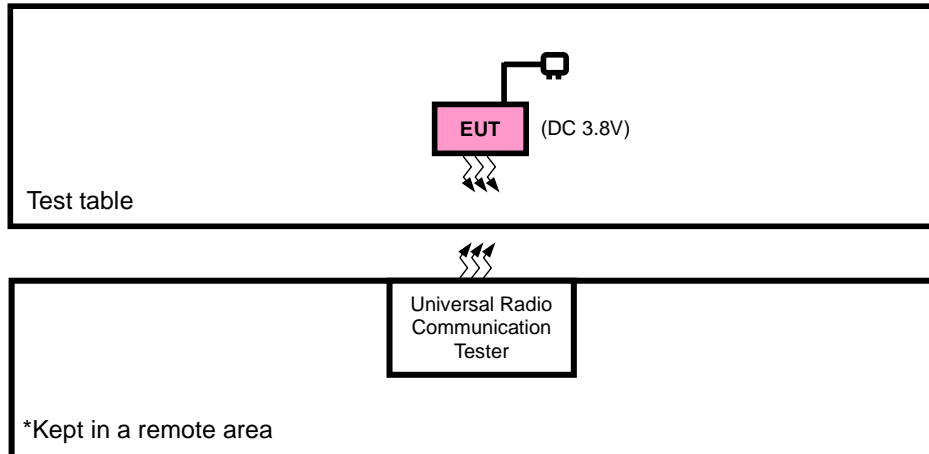

FOR CONDUCTED & E.R.P./E.I.R.P TEST

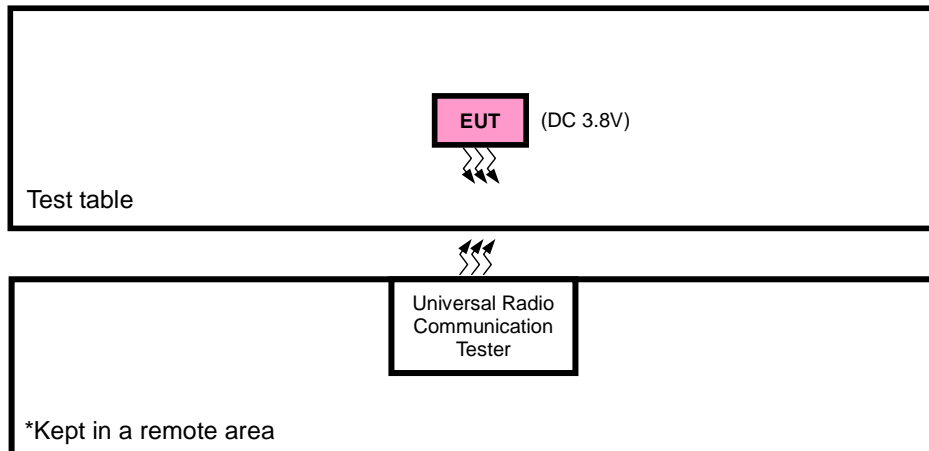



2.3 DESCRIPTION OF SUPPORT UNITS

The EUT has been tested as an independent unit together with other necessary accessories or support units. The following support units or accessories were used to form a representative test configuration during the tests.

| NO. | PRODUCT | BRAND | MODEL NO. | SERIAL NO. | FCC ID |
|-----|-----------|----------|-----------|------------|--------|
| 1 | DC source | LONG WEI | PS-6403D | 010934269 | N/A |
| 2 | PC | HP | A6608CN | 3CR83825X3 | N/A |

| NO. | SIGNAL CABLE DESCRIPTION OF THE ABOVE SUPPORT UNITS |
|-----|---|
| 1 | DC Line: Unshielded, Detachable 1.0m |
| 2 | AC Line: Unshielded, Detachable 1.5m |

NOTE:

- 1. All power cords of the above support units are non shielded (1.8m).

2.4 DESCRIPTION OF TEST MODES

Pre-Scan has been conducted to determine the worst-case mode from all possible combinations between available modulations, data rates, XYZ axis and antenna ports. The worst case in ERP/EIRP and radiated emission was found when positioned on X-plane for LTE. Following channel(s) was (were) selected for the final test as listed below:

| EUT CONFIGURE MODE | DESCRIPTION |
|--------------------|--------------|
| - | EUT LTE link |



Test Report No.: RF180521W014-3

LTE BAND 4

| EUT CONFIGURE MODE | TEST ITEM | AVAILABLE CHANNEL | TESTED CHANNEL | CHANNEL BANDWIDTH | MODULATION | MODE |
|--------------------|-----------------------|-------------------|---------------------|-------------------|-------------|--|
| - | EIRP | 19957 to 20393 | 19957, 20175, 20393 | 1.4MHz | QPSK, 16QAM | 1 RB / 0 RB Offset |
| | | 19965 to 20385 | 19965, 20175, 20385 | 3MHz | QPSK, 16QAM | 1 RB / 0 RB Offset |
| | | 19975 to 20375 | 19975, 20175, 20375 | 5MHz | QPSK, 16QAM | 1 RB / 0 RB Offset |
| | | 20000 to 20350 | 20000, 20175, 20350 | 10MHz | QPSK, 16QAM | 1 RB / 0 RB Offset |
| | | 20025 to 20325 | 20025, 20175, 20325 | 15MHz | QPSK, 16QAM | 1 RB / 0 RB Offset |
| | | 20050 to 20300 | 20050, 20175, 20300 | 20MHz | QPSK, 16QAM | 1 RB / 0 RB Offset |
| - | FREQUENCY STABILITY | 19957 to 20393 | 19957, 20393 | 1.4MHz | QPSK | 1 RB / 0 RB Offset |
| | | 19965 to 20385 | 19965, 20385 | 3MHz | QPSK | 1 RB / 0 RB Offset |
| | | 19975 to 20375 | 19975, 20375 | 5MHz | QPSK | 1 RB / 0 RB Offset |
| | | 20000 to 20350 | 20000, 20350 | 10MHz | QPSK | 1 RB / 0 RB Offset |
| | | 20025 to 20325 | 20025, 20325 | 15MHz | QPSK | 1 RB / 0 RB Offset |
| | | 20050 to 20300 | 20050, 20300 | 20MHz | QPSK | 1 RB / 0 RB Offset |
| - | OCCUPIED BANDWIDTH | 19957 to 20393 | 19957, 20175, 20393 | 1.4MHz | QPSK, 16QAM | 6 RB / 0 RB Offset |
| | | 19965 to 20385 | 19965, 20175, 20385 | 3MHz | QPSK, 16QAM | 15 RB / 0 RB Offset |
| | | 19975 to 20375 | 19975, 20175, 20375 | 5MHz | QPSK, 16QAM | 25 RB / 0 RB Offset |
| | | 20000 to 20350 | 20000, 20175, 20350 | 10MHz | QPSK, 16QAM | 50 RB / 0 RB Offset |
| | | 20025 to 20325 | 20025, 20175, 20325 | 15MHz | QPSK, 16QAM | 75 RB / 0 RB Offset |
| | | 20050 to 20300 | 20050, 20175, 20300 | 20MHz | QPSK, 16QAM | 100 RB / 0 RB Offset |
| - | PEAK TO AVERAGE RATIO | 19957 to 20393 | 19957, 20175, 20393 | 1.4MHz | QPSK, 16QAM | 1 RB / 0 RB Offset |
| | | 19965 to 20385 | 19965, 20175, 20385 | 3MHz | QPSK, 16QAM | 1 RB / 0 RB Offset |
| | | 19975 to 20375 | 19975, 20175, 20375 | 5MHz | QPSK, 16QAM | 1 RB / 0 RB Offset |
| | | 20000 to 20350 | 20000, 20175, 20350 | 10MHz | QPSK, 16QAM | 1 RB / 0 RB Offset |
| | | 20025 to 20325 | 20025, 20175, 20325 | 15MHz | QPSK, 16QAM | 1 RB / 0 RB Offset |
| | | 20050 to 20300 | 20050, 20175, 20300 | 20MHz | QPSK, 16QAM | 1 RB / 0 RB Offset |
| - | BAND EDGE | 19957 to 20393 | 19957 | 1.4MHz | QPSK | 1 RB / 0 RB Offset 6 RB / 0 RB Offset |
| | | | 20393 | 1.4MHz | QPSK | 1 RB / 5 RB Offset 6 RB / 0 RB Offset |
| | | 19965 to 20385 | 19965 | 3MHz | QPSK | 1 RB / 0 RB Offset 15 RB / 0 RB Offset |
| | | | 20385 | 3MHz | QPSK | 1 RB / 14 RB Offset 15 RB / 0 RB Offset |
| | | 19975 to 20375 | 19975 | 5MHz | QPSK | 1 RB / 0 RB Offset 25 RB / 0 RB Offset |
| | | | 20375 | 5MHz | QPSK | 1 RB / 24 RB Offset 25 RB / 0 RB Offset |
| | | 20000 to 20350 | 20000 | 10MHz | QPSK | 1 RB / 0 RB Offset 50 RB / 0 RB Offset |
| | | | 20350 | 10MHz | QPSK | 1 RB / 49 RB Offset 50 RB / 0 RB Offset |



Test Report No.: RF180521W014-3

| | | | | | | |
|---|---------------------|----------------|---------------------|---------------------|----------------------|----------------------|
| - | BAND EDGE | 20025 to 20325 | 20025 | 15MHz | QPSK | 1 RB / 0 RB Offset |
| | | | | | | 75 RB / 0 RB Offset |
| | | 20050 to 20300 | 20325 | 15MHz | QPSK | 1 RB / 74 RB Offset |
| | | | | | | 75 RB / 0 RB Offset |
| | | | 20050 | 20MHz | QPSK | 1 RB / 0 RB Offset |
| | | | | | | 100 RB / 0 RB Offset |
| | 20300 | 20MHz | QPSK | 1 RB / 99 RB Offset | | |
| | | | | | 100 RB / 0 RB Offset | |
| - | CONDCUETED EMISSION | 19957 to 20393 | 19957, 20175, 20393 | 1.4MHz | QPSK | 1 RB / 0 RB Offset |
| | | 19965 to 20385 | 19965, 20175, 20385 | 3MHz | QPSK | 1 RB / 0 RB Offset |
| | | 19975 to 20375 | 19975, 20175, 20375 | 5MHz | QPSK | 1 RB / 0 RB Offset |
| | | 20000 to 20350 | 20000, 20175, 20350 | 10MHz | QPSK | 1 RB / 0 RB Offset |
| | | 20025 to 20325 | 20025, 20175, 20325 | 15MHz | QPSK | 1 RB / 0 RB Offset |
| | | 20050 to 20300 | 20050, 20175, 20300 | 20MHz | QPSK | 1 RB / 0 RB Offset |
| - | RADIATED EMISSION | 19957 to 20393 | 19957, 20175, 20393 | 1.4MHz | QPSK | 1 RB / 0 RB Offset |
| | | 19965 to 20385 | 20175 | 3MHz | QPSK | 1 RB / 0 RB Offset |
| | | 19975 to 20375 | 20175 | 5MHz | QPSK | 1 RB / 0 RB Offset |
| | | 20000 to 20350 | 20175 | 10MHz | QPSK | 1 RB / 0 RB Offset |
| | | 20025 to 20325 | 20175 | 15MHz | QPSK | 1 RB / 0 RB Offset |
| | | 20050 to 20300 | 20175 | 20MHz | QPSK | 1 RB / 0 RB Offset |

Note: This device was tested under all bandwidths, RB configurations and modulations. The worst case was found in QPSK modulation.



Test Report No.: RF180521W014-3

LTE BAND 12

| EUT CONFIGURE MODE | TEST ITEM | AVAILABLE CHANNEL | TESTED CHANNEL | CHANNEL BANDWIDTH | MODULATION | MODE | | |
|--------------------|-----------------------|-------------------|----------------------|-------------------|----------------------|---------------------|------|--------------------|
| - | ERP | 23017 to 23173 | 23017, 23095 , 23173 | 1.4MHz | QPSK,16QAM | 1 RB / 0 RB Offset | | |
| | | 23025 to 23165 | 23025, 23095 ,23165 | 3MHz | QPSK,16QAM | 1 RB / 0 RB Offset | | |
| | | 23035 to 23155 | 23035, 23095 ,23155 | 5MHz | QPSK,16QAM | 1 RB / 0 RB Offset | | |
| | | 23060 to 23130 | 23060, 23095 ,23130 | 10MHz | QPSK,16QAM | 1 RB / 0 RB Offset | | |
| - | FREQUENCY STABILITY | 23017 to 23173 | 23017, 23173 | 1.4MHz | QPSK | 1 RB / 0 RB Offset | | |
| | | 23025 to 23165 | 23025, 23165 | 3MHz | QPSK | 1 RB / 0 RB Offset | | |
| | | 23035 to 23155 | 23035, 23155 | 5MHz | QPSK | 1 RB / 0 RB Offset | | |
| | | 23060 to 23130 | 23060, 23130 | 10MHz | QPSK | 1 RB / 0 RB Offset | | |
| - | OCCUPIED BANDWIDTH | 23017 to 23173 | 23017, 23095 , 23173 | 1.4MHz | QPSK,16QAM | 6 RB / 0 RB Offset | | |
| | | 23025 to 23165 | 23025, 23095 ,23165 | 3MHz | QPSK,16QAM | 15 RB / 0 RB Offset | | |
| | | 23035 to 23155 | 23035, 23095 ,23155 | 5MHz | QPSK,16QAM | 25 RB / 0 RB Offset | | |
| | | 23060 to 23130 | 23060, 23095 ,23130 | 10MHz | QPSK,16QAM | 50 RB / 0 RB Offset | | |
| - | PEAK TO AVERAGE RATIO | 23017 to 23173 | 23017, 23095 , 23173 | 1.4MHz | QPSK, 16QAM | 1 RB / 0 RB Offset | | |
| | | 23025 to 23165 | 23025, 23095 ,23165 | 3MHz | QPSK, 16QAM | 1 RB / 0 RB Offset | | |
| | | 23035 to 23155 | 23035, 23095 ,23155 | 5MHz | QPSK, 16QAM | 1 RB / 0 RB Offset | | |
| | | 23060 to 23130 | 23060, 23095 ,23130 | 10MHz | QPSK, 16QAM | 1 RB / 0 RB Offset | | |
| - | BAND EDGE | 23017 to 23173 | 23017 | 1.4MHz | QPSK | 1 RB / 0 RB Offset | | |
| | | | 23173 | 1.4MHz | QPSK | 6 RB / 0 RB Offset | | |
| | | 23025 to 23165 | 23025 | 3MHz | QPSK | 1 RB / 5 RB Offset | | |
| | | | 23165 | 3MHz | QPSK | 6 RB / 0 RB Offset | | |
| | | 23035 to 23155 | 23035 | 5MHz | QPSK | 1 RB / 0 RB Offset | | |
| | | | 23155 | 5MHz | QPSK | 15 RB / 0 RB Offset | | |
| | | 23060 to 23130 | 23060 | 10MHz | QPSK | 1 RB / 14 RB Offset | | |
| | | | 23130 | 10MHz | QPSK | 15 RB / 0 RB Offset | | |
| | | - | CONDCUETED EMISSION | 23017 to 23173 | 23017, 23095 , 23173 | 1.4MHz | QPSK | 1 RB / 0 RB Offset |
| | | | | 23025 to 23165 | 23025, 23095 ,23165 | 3MHz | QPSK | 1 RB / 0 RB Offset |
| | | | | 23035 to 23155 | 23035, 23095 ,23155 | 5MHz | QPSK | 1 RB / 0 RB Offset |
| | | | | 23060 to 23130 | 23060, 23095 ,23130 | 10MHz | QPSK | 1 RB / 0 RB Offset |
| - | RADIATED EMISSION | 23017 to 23173 | 23095 | 1.4MHz | QPSK | 1 RB / 0 RB Offset | | |
| | | 23025 to 23165 | 23095 | 3MHz | QPSK | 1 RB / 0 RB Offset | | |
| | | 23035 to 23155 | 23095 | 5MHz | QPSK | 1 RB / 0 RB Offset | | |
| | | 23060 to 23130 | 23060, 23095 ,23130 | 10MHz | QPSK | 1 RB / 0 RB Offset | | |

Note: This device was tested under all bandwidths, RB configurations and modulations. The worst case was found in QPSK modulation.



TEST CONDITION:

| TEST ITEM | ENVIRONMENTAL CONDITIONS | INPUT POWER | TESTED BY |
|-----------------------|--------------------------|-------------------|-------------|
| EIRP(ERP) | 24deg. C, 60%RH | DC 3.8V | Star Le |
| FREQUENCY STABILITY | 24deg. C, 61%RH | DC 3.4V/3.8V/4.2V | Wenliang Wu |
| OCCUPIED BANDWIDTH | 24deg. C, 61%RH | DC 3.8V | Wenliang Wu |
| PEAK TO AVERAGE RATIO | 24deg. C, 61%RH | DC 3.8V | Wenliang Wu |
| BAND EDGE | 24deg. C, 61%RH | DC 3.8V | Wenliang Wu |
| CONDCUDED EMISSION | 24deg. C, 61%RH | DC 3.8V | Wenliang Wu |
| RADIATED EMISSION | 24deg. C, 60%RH | DC 3.8V | Star Le |

2.5 GENERAL DESCRIPTION OF APPLIED STANDARDS

The EUT is a RF product. According to the specifications of the manufacturer, it must comply with the requirements of the following standards:

FCC 47 CFR Part 2

FCC 47 CFR Part 27

KDB 971168 D01 Power Meas License Digital Systems v03

ANSI/TIA/EIA-603-D

ANSI/TIA/EIA-603-E

ANSI C63.26-2015

NOTE: All test items have been performed and recorded as per the above standards.



3 TEST TYPES AND RESULTS

3.1 OUTPUT POWER MEASUREMENT

3.1.1 LIMITS OF OUTPUT POWER MEASUREMENT

Fixed, mobile, and portable (hand-held) stations operating in the 1710–1755 MHz band are limited to 1 watt EIRP.

Portable stations (hand-held devices) operating in the 699-716 MHz bands are limited to 3 watts ERP.

3.1.2 TEST PROCEDURES

EIRP / ERP MEASUREMENT:

- a. The EUT was set up for the maximum power with LTE link data modulation. The power was measured with R&S Spectrum Analyzer. All measurements were done at 3 channels (low, middle and high operational frequency range). RBW and VBW is 10MHz for LTE.
- b. E.I.R.P power measurement. In the semi-anechoic chamber, EUT placed on the 0.8m height of Turn Table, rotated the table around 360 degrees to search the maximum radiation power and receiver antenna shall be rotated vertical and horizontal polarization and moved height from 1m to 4m to find the maximum polar radiated power. The “Read Value” is the spectrum reading the maximum power value.
- c. The substitution horn antenna is substituted for EUT at the same position and signals generator export the CW signal to the substitution antenna via a TX cable. Rotated the Turn Table and moved receiving antenna to find the maximum radiation power. Adjust output power level of S.G to get a Value of spectrum reading equal to “Read Value” of step a. Record the power level of S.G
- d. $EIRP = \text{Output power level of S.G} - \text{TX cable loss} + \text{Antenna gain of substitution horn}$
- e. $E.R.P = E.I.R.P - 2.15 \text{ dB}$

CONDUCTED POWER MEASUREMENT:

- a. The EUT was set up for the maximum power with LTE link data modulation and link up with simulator.
- b. Set the EUT to transmit under low, middle and high channel and record the power level shown on simulator.

3.1.3 TEST SETUP

EIRP / ERP Measurement:

<Radiated Emission below or equal 1 GHz>

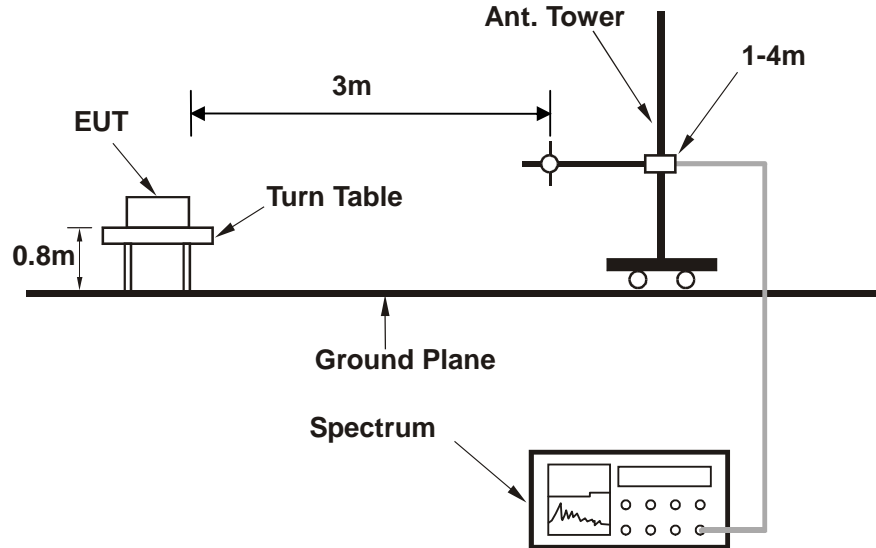

<Radiated Emission above 1 GHz>

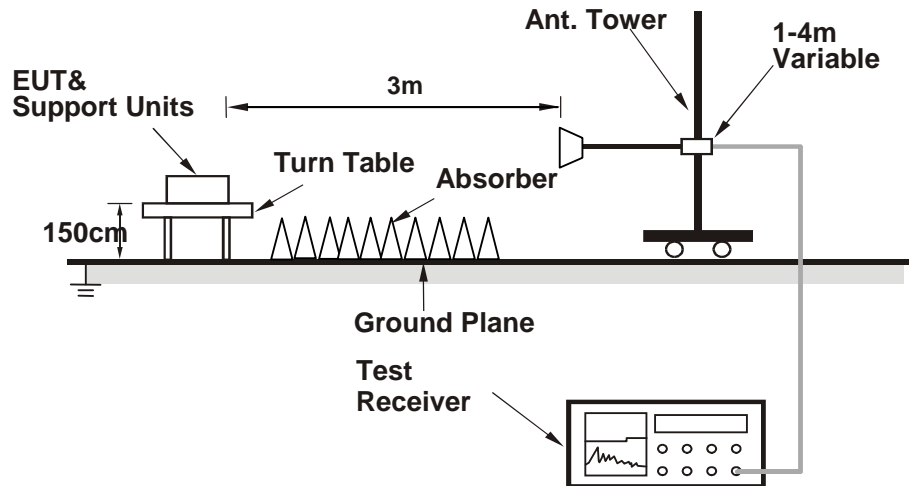

For the actual test configuration, please refer to the attached file (Test Setup Photo).

CONDUCTED POWER MEASUREMENT:

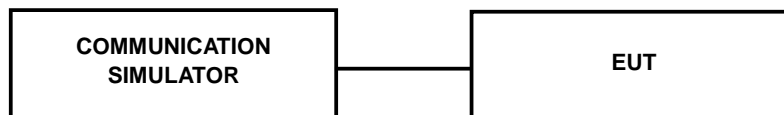

3.1.4 TEST RESULTS

AVERAGE CONDUCTED OUTPUT POWER (dBm)

| LTE Band 4 | | | | | | | |
|------------|------------|---------|-----------|-------------------------|-------------------------|-------------------------|-----|
| BW | Modulation | RB Size | RB Offset | Low CH 19957 | Mid CH 20175 | High CH 20393 | MPR |
| | | | | Frequency 1710.7 MHz | Frequency 1732.5 MHz | Frequency 1754.3 MHz | |
| 1.4MHz | QPSK | 1 | 0 | 21.85 | 22.13 | 22.42 | 0 |
| | | 1 | 2 | 21.83 | 22.11 | 22.40 | 0 |
| | | 1 | 5 | 21.80 | 22.08 | 22.37 | 0 |
| | | 3 | 0 | 21.83 | 22.11 | 22.40 | 0 |
| | | 3 | 1 | 21.81 | 22.09 | 22.38 | 0 |
| | | 3 | 3 | 21.78 | 22.06 | 22.35 | 0 |
| | | 6 | 0 | 20.68 | 20.96 | 21.25 | 1 |
| | 16QAM | 1 | 0 | 20.61 | 20.89 | 21.18 | 1 |
| | | 1 | 2 | 20.60 | 20.88 | 21.17 | 1 |
| | | 1 | 5 | 20.41 | 20.69 | 20.98 | 1 |
| | | 3 | 0 | 20.60 | 20.88 | 21.17 | 1 |
| | | 3 | 1 | 20.59 | 20.87 | 21.16 | 1 |
| | | 3 | 3 | 20.40 | 20.68 | 20.97 | 1 |
| | | 6 | 0 | 19.76 | 20.04 | 20.33 | 2 |
| BW | Modulation | RB Size | RB Offset | Low CH 19965 | Mid CH 20175 | High CH 20385 | MPR |
| | | | | Frequency 1711.5 MHz | Frequency 1732.5 MHz | Frequency 1753.5 MHz | |
| 3 MHz | QPSK | 1 | 0 | 21.86 | 22.14 | 22.43 | 0 |
| | | 1 | 7 | 21.84 | 22.12 | 22.41 | 0 |
| | | 1 | 14 | 21.81 | 22.09 | 22.38 | 0 |
| | | 8 | 0 | 20.88 | 21.16 | 21.45 | 1 |
| | | 8 | 3 | 20.79 | 21.07 | 21.36 | 1 |
| | | 8 | 7 | 20.77 | 21.05 | 21.34 | 1 |
| | | 15 | 0 | 20.69 | 20.97 | 21.26 | 1 |
| | 16QAM | 1 | 0 | 20.62 | 20.90 | 21.19 | 1 |
| | | 1 | 7 | 20.61 | 20.89 | 21.18 | 1 |
| | | 1 | 14 | 20.42 | 20.70 | 20.99 | 1 |
| | | 8 | 0 | 19.91 | 20.19 | 20.48 | 2 |
| | | 8 | 3 | 19.85 | 20.13 | 20.42 | 2 |
| | | 8 | 7 | 19.82 | 20.10 | 20.39 | 2 |
| | | 15 | 0 | 19.77 | 20.05 | 20.34 | 2 |



Test Report No.: RF180521W014-3

| LTE Band 4 | | | | | | | |
|------------|------------|---------|-----------|-------------------------|-------------------------|-------------------------|-----|
| BW | Modulation | RB Size | RB Offset | Low CH 19975 | Mid CH 20175 | High CH 20375 | MPR |
| | | | | Frequency 1712.5 MHz | Frequency 1732.5 MHz | Frequency 1752.5 MHz | |
| 5 MHz | QPSK | 1 | 0 | 21.89 | 22.17 | 22.46 | 0 |
| | | 1 | 12 | 21.87 | 22.15 | 22.44 | 0 |
| | | 1 | 24 | 21.84 | 22.12 | 22.41 | 0 |
| | | 12 | 0 | 20.91 | 21.19 | 21.48 | 1 |
| | | 12 | 6 | 20.82 | 21.10 | 21.39 | 1 |
| | | 12 | 13 | 20.80 | 21.08 | 21.37 | 1 |
| | | 25 | 0 | 20.72 | 21.00 | 21.29 | 1 |
| | 16QAM | 1 | 0 | 20.65 | 20.93 | 21.22 | 1 |
| | | 1 | 12 | 20.64 | 20.92 | 21.21 | 1 |
| | | 1 | 24 | 20.45 | 20.73 | 21.02 | 1 |
| | | 12 | 0 | 19.94 | 20.22 | 20.51 | 2 |
| | | 12 | 6 | 19.88 | 20.16 | 20.45 | 2 |
| | | 12 | 13 | 19.85 | 20.13 | 20.42 | 2 |
| | | 25 | 0 | 19.80 | 20.08 | 20.37 | 2 |
| BW | Modulation | RB Size | RB Offset | Low CH 20000 | Mid CH 20175 | High CH 20350 | MPR |
| | | | | Frequency 1715 MHz | Frequency 1732.5 MHz | Frequency 1750 MHz | |
| 10 MHz | QPSK | 1 | 0 | 21.93 | 22.21 | 22.50 | 0 |
| | | 1 | 24 | 21.91 | 22.19 | 22.48 | 0 |
| | | 1 | 49 | 21.88 | 22.16 | 22.45 | 0 |
| | | 25 | 0 | 20.95 | 21.23 | 21.52 | 1 |
| | | 25 | 12 | 20.86 | 21.14 | 21.43 | 1 |
| | | 25 | 25 | 20.84 | 21.12 | 21.41 | 1 |
| | | 50 | 0 | 20.76 | 21.04 | 21.33 | 1 |
| | 16QAM | 1 | 0 | 20.69 | 20.97 | 21.26 | 1 |
| | | 1 | 24 | 20.68 | 20.96 | 21.25 | 1 |
| | | 1 | 49 | 20.49 | 20.77 | 21.06 | 1 |
| | | 25 | 0 | 19.98 | 20.26 | 20.55 | 2 |
| | | 25 | 12 | 19.92 | 20.20 | 20.49 | 2 |
| | | 25 | 25 | 19.89 | 20.17 | 20.46 | 2 |
| | | 50 | 0 | 19.84 | 20.12 | 20.41 | 2 |



Test Report No.: RF180521W014-3

| LTE Band 4 | | | | | | | |
|------------|------------|---------|-----------|----------------------|----------------------|----------------------|-----|
| BW | Modulation | RB Size | RB Offset | Low CH 20025 | Mid CH 20175 | High CH 20325 | MPR |
| | | | | Frequency 1717.5 MHz | Frequency 1732.5 MHz | Frequency 1747.5 MHz | |
| 15 MHz | QPSK | 1 | 0 | 21.99 | 22.27 | 22.56 | 0 |
| | | 1 | 37 | 21.97 | 22.25 | 22.54 | 0 |
| | | 1 | 74 | 21.94 | 22.22 | 22.51 | 0 |
| | | 36 | 0 | 21.01 | 21.29 | 21.58 | 1 |
| | | 36 | 19 | 20.92 | 21.20 | 21.49 | 1 |
| | | 36 | 39 | 20.90 | 21.18 | 21.47 | 1 |
| | | 75 | 0 | 20.82 | 21.10 | 21.39 | 1 |
| | 16QAM | 1 | 0 | 20.75 | 21.03 | 21.32 | 1 |
| | | 1 | 37 | 20.74 | 21.02 | 21.31 | 1 |
| | | 1 | 74 | 20.55 | 20.83 | 21.12 | 1 |
| | | 36 | 0 | 20.04 | 20.32 | 20.61 | 2 |
| | | 36 | 19 | 19.98 | 20.26 | 20.55 | 2 |
| | | 36 | 39 | 19.95 | 20.23 | 20.52 | 2 |
| | | 75 | 0 | 19.90 | 20.18 | 20.47 | 2 |
| BW | Modulation | RB Size | RB Offset | Low CH 20050 | Mid CH 20175 | High CH 20300 | MPR |
| | | | | Frequency 1720 MHz | Frequency 1732.5 MHz | Frequency 1745 MHz | |
| 20MHz | QPSK | 1 | 0 | 22.02 | 22.30 | 22.59 | 0 |
| | | 1 | 50 | 22.00 | 22.28 | 22.57 | 0 |
| | | 1 | 99 | 21.97 | 22.25 | 22.54 | 0 |
| | | 50 | 0 | 21.04 | 21.32 | 21.61 | 1 |
| | | 50 | 25 | 20.95 | 21.23 | 21.52 | 1 |
| | | 50 | 50 | 20.93 | 21.21 | 21.50 | 1 |
| | | 100 | 0 | 20.85 | 21.13 | 21.42 | 1 |
| | 16QAM | 1 | 0 | 20.78 | 21.06 | 21.35 | 1 |
| | | 1 | 50 | 20.77 | 21.05 | 21.34 | 1 |
| | | 1 | 99 | 20.58 | 20.86 | 21.15 | 1 |
| | | 50 | 0 | 20.07 | 20.35 | 20.64 | 2 |
| | | 50 | 25 | 20.01 | 20.29 | 20.58 | 2 |
| | | 50 | 50 | 19.98 | 20.26 | 20.55 | 2 |
| | | 100 | 0 | 19.93 | 20.21 | 20.50 | 2 |



Test Report No.: RF180521W014-3

| LTE Band 12 | | | | | | | |
|-------------|------------|---------|-----------|---------------------|---------------------|---------------------|-----|
| BW | Modulation | RB Size | RB Offset | Low CH 23017 | Mid CH 23095 | High CH 23173 | MPR |
| | | | | Frequency 699.7 MHz | Frequency 707.5 MHz | Frequency 715.3 MHz | |
| 1.4 MHz | QPSK | 1 | 0 | 23.08 | 23.29 | 23.17 | 0 |
| | | 1 | 2 | 23.00 | 23.21 | 23.09 | 0 |
| | | 1 | 5 | 22.91 | 23.12 | 23.00 | 0 |
| | | 3 | 0 | 23.06 | 23.27 | 23.15 | 0 |
| | | 3 | 1 | 22.98 | 23.19 | 23.07 | 0 |
| | | 3 | 3 | 22.89 | 23.10 | 22.98 | 0 |
| | | 6 | 0 | 22.02 | 22.23 | 22.11 | 1 |
| | 16QAM | 1 | 0 | 21.70 | 21.91 | 21.79 | 1 |
| | | 1 | 2 | 21.68 | 21.89 | 21.77 | 1 |
| | | 1 | 5 | 21.28 | 21.49 | 21.37 | 1 |
| | | 3 | 0 | 21.69 | 21.90 | 21.78 | 1 |
| | | 3 | 1 | 21.67 | 21.88 | 21.76 | 1 |
| | | 3 | 3 | 21.27 | 21.48 | 21.36 | 1 |
| | | 6 | 0 | 21.03 | 21.24 | 21.12 | 2 |
| LTE Band 12 | | | | | | | |
| BW | Modulation | RB Size | RB Offset | Low CH 23025 | Mid CH 23095 | High CH 23165 | MPR |
| | | | | Frequency 700.5 MHz | Frequency 707.5 MHz | Frequency 714.5 MHz | |
| 3 MHz | QPSK | 1 | 0 | 23.12 | 23.33 | 23.21 | 0 |
| | | 1 | 7 | 23.04 | 23.25 | 23.13 | 0 |
| | | 1 | 14 | 22.95 | 23.16 | 23.04 | 0 |
| | | 8 | 0 | 22.16 | 22.37 | 22.25 | 1 |
| | | 8 | 3 | 22.13 | 22.34 | 22.22 | 1 |
| | | 8 | 7 | 22.10 | 22.31 | 22.19 | 1 |
| | | 15 | 0 | 22.06 | 22.27 | 22.15 | 1 |
| | 16QAM | 1 | 0 | 21.74 | 21.95 | 21.83 | 1 |
| | | 1 | 7 | 21.72 | 21.93 | 21.81 | 1 |
| | | 1 | 14 | 21.32 | 21.53 | 21.41 | 1 |
| | | 8 | 0 | 21.20 | 21.41 | 21.29 | 2 |
| | | 8 | 3 | 21.17 | 21.38 | 21.26 | 2 |
| | | 8 | 7 | 21.12 | 21.33 | 21.21 | 2 |
| | | 15 | 0 | 21.07 | 21.28 | 21.16 | 2 |



Test Report No.: RF180521W014-3

| LTE Band 12 | | | | | | | |
|-------------|------------|---------|-----------|---------------------|---------------------|---------------------|-----|
| BW | Modulation | RB Size | RB Offset | Low CH 23035 | Mid CH 23095 | High CH 23155 | MPR |
| | | | | Frequency 701.5 MHz | Frequency 707.5 MHz | Frequency 713.5 MHz | |
| 5 MHz | QPSK | 1 | 0 | 23.18 | 23.39 | 23.27 | 0 |
| | | 1 | 12 | 23.10 | 23.31 | 23.19 | 0 |
| | | 1 | 24 | 23.01 | 23.22 | 23.10 | 0 |
| | | 12 | 0 | 22.22 | 22.43 | 22.31 | 1 |
| | | 12 | 6 | 22.19 | 22.40 | 22.28 | 1 |
| | | 12 | 13 | 22.16 | 22.37 | 22.25 | 1 |
| | | 25 | 0 | 22.12 | 22.33 | 22.21 | 1 |
| | 16QAM | 1 | 0 | 21.80 | 22.01 | 21.89 | 1 |
| | | 1 | 12 | 21.78 | 21.99 | 21.87 | 1 |
| | | 1 | 24 | 21.38 | 21.59 | 21.47 | 1 |
| | | 12 | 0 | 21.26 | 21.47 | 21.35 | 2 |
| | | 12 | 6 | 21.23 | 21.44 | 21.32 | 2 |
| | | 12 | 13 | 21.18 | 21.39 | 21.27 | 2 |
| | | 25 | 0 | 21.13 | 21.34 | 21.22 | 2 |
| LTE Band 12 | | | | | | | |
| BW | Modulation | RB Size | RB Offset | Low CH 23060 | Mid CH 23095 | High CH 23130 | MPR |
| | | | | Frequency 704 MHz | Frequency 707.5 MHz | Frequency 711 MHz | |
| 10 MHz | QPSK | 1 | 0 | 23.21 | 23.42 | 23.30 | 0 |
| | | 1 | 24 | 23.13 | 23.34 | 23.22 | 0 |
| | | 1 | 49 | 23.04 | 23.25 | 23.13 | 0 |
| | | 25 | 0 | 22.25 | 22.46 | 22.34 | 1 |
| | | 25 | 12 | 22.22 | 22.43 | 22.31 | 1 |
| | | 25 | 25 | 22.19 | 22.40 | 22.28 | 1 |
| | | 50 | 0 | 22.15 | 22.36 | 22.24 | 1 |
| | 16QAM | 1 | 0 | 21.83 | 22.04 | 21.92 | 1 |
| | | 1 | 24 | 21.81 | 22.02 | 21.90 | 1 |
| | | 1 | 49 | 21.41 | 21.62 | 21.50 | 1 |
| | | 25 | 0 | 21.29 | 21.50 | 21.38 | 2 |
| | | 25 | 12 | 21.26 | 21.47 | 21.35 | 2 |
| | | 25 | 25 | 21.21 | 21.42 | 21.30 | 2 |
| | | 50 | 0 | 21.16 | 21.37 | 21.25 | 2 |



Test Report No.: RF180521W014-3

EIRP

LTE BAND 4

CHANNEL BANDWIDTH: 1.4MHz QPSK

| Channel | Frequency (MHz) | SPA LVL (dBm) | Correction Factor(dB) | EIRP(dBm) | EIRP(mW) | Polarization (H/V) | LIMIT (W) |
|---------|-----------------|---------------|-----------------------|-----------|---------------|--------------------|-----------|
| 19957 | 1710.7 | -22.00 | 41.29 | 19.29 | 85.00 | H | 1 |
| 20175 | 1732.5 | -21.09 | 41.36 | 20.27 | 106.41 | H | 1 |
| 20393 | 1754.3 | -21.96 | 42.74 | 20.78 | 119.62 | H | 1 |
| 19957 | 1710.7 | -18.08 | 44.25 | 26.17 | 413.52 | V | 1 |
| 20175 | 1732.5 | -17.30 | 44.20 | 26.90 | 489.78 | V | 1 |
| 20393 | 1754.3 | -17.71 | 44.09 | 26.38 | 434.01 | V | 1 |

CHANNEL BANDWIDTH: 1.4MHz 16QAM

| Channel | Frequency (MHz) | SPA LVL (dBm) | Correction Factor(dB) | EIRP(dBm) | EIRP(mW) | Polarization (H/V) | LIMIT (W) |
|---------|-----------------|---------------|-----------------------|-----------|----------|--------------------|-----------|
| 19957 | 1710.7 | -22.87 | 41.29 | 18.42 | 69.57 | H | 1 |
| 20175 | 1732.5 | -22.02 | 41.36 | 19.34 | 85.90 | H | 1 |
| 20393 | 1754.3 | -22.92 | 42.74 | 19.82 | 95.90 | H | 1 |
| 19957 | 1710.7 | -18.95 | 44.25 | 25.30 | 338.45 | V | 1 |
| 20175 | 1732.5 | -18.23 | 44.20 | 25.97 | 395.37 | V | 1 |
| 20393 | 1754.3 | -18.67 | 44.09 | 25.42 | 347.94 | V | 1 |

LTE BAND 4

CHANNEL BANDWIDTH: 3MHz QPSK

| Channel | Frequency (MHz) | SPA LVL (dBm) | Correction Factor(dB) | EIRP(dBm) | EIRP(mW) | Polarization (H/V) | LIMIT (W) |
|---------|-----------------|---------------|-----------------------|-----------|---------------|--------------------|-----------|
| 19965 | 1711.5 | -21.98 | 41.27 | 19.29 | 84.86 | H | 1 |
| 20175 | 1732.5 | -21.15 | 41.36 | 20.21 | 104.95 | H | 1 |
| 20385 | 1753.5 | -21.91 | 42.76 | 20.85 | 121.53 | H | 1 |
| 19965 | 1711.5 | -18.06 | 44.26 | 26.20 | 417.06 | V | 1 |
| 20175 | 1732.5 | -17.36 | 44.20 | 26.84 | 483.06 | V | 1 |
| 20385 | 1753.5 | -17.66 | 44.23 | 26.57 | 454.15 | V | 1 |



Test Report No.: RF180521W014-3

CHANNEL BANDWIDTH: 3MHz 16QAM

| Channel | Frequency (MHz) | SPA LVL (dBm) | Correction Factor(dB) | EIRP(dBm) | EIRP(mW) | Polarization (H/V) | LIMIT (W) |
|---------|-----------------|---------------|-----------------------|-----------|----------|--------------------|-----------|
| 19965 | 1711.5 | -23.05 | 41.27 | 18.22 | 66.33 | H | 1 |
| 20175 | 1732.5 | -22.04 | 41.36 | 19.32 | 85.51 | H | 1 |
| 20385 | 1753.5 | -22.90 | 42.76 | 19.86 | 96.76 | H | 1 |
| 19965 | 1711.5 | -19.13 | 44.26 | 25.13 | 325.99 | V | 1 |
| 20175 | 1732.5 | -18.25 | 44.20 | 25.95 | 393.55 | V | 1 |
| 20385 | 1753.5 | -18.65 | 44.23 | 25.58 | 361.58 | V | 1 |

LTE BAND 4

CHANNEL BANDWIDTH: 5MHz QPSK

| Channel | Frequency (MHz) | SPA LVL (dBm) | Correction Factor(dB) | EIRP(dBm) | EIRP(mW) | Polarization (H/V) | LIMIT (W) |
|---------|-----------------|---------------|-----------------------|-----------|---------------|--------------------|-----------|
| 19975 | 1712.5 | -22.04 | 41.39 | 19.35 | 86.08 | H | 1 |
| 20175 | 1732.5 | -21.10 | 41.36 | 20.26 | 106.17 | H | 1 |
| 20375 | 1752.5 | -21.86 | 42.63 | 20.77 | 119.37 | H | 1 |
| 19975 | 1712.5 | -18.12 | 44.17 | 26.05 | 402.35 | V | 1 |
| 20175 | 1732.5 | -17.31 | 44.20 | 26.89 | 488.65 | V | 1 |
| 20375 | 1752.5 | -17.61 | 44.35 | 26.74 | 471.52 | V | 1 |

CHANNEL BANDWIDTH: 5MHz 16QAM

| Channel | Frequency (MHz) | SPA LVL (dBm) | Correction Factor(dB) | EIRP(dBm) | EIRP(mW) | Polarization (H/V) | LIMIT (W) |
|---------|-----------------|---------------|-----------------------|-----------|----------|--------------------|-----------|
| 19975 | 1712.5 | -22.87 | 41.39 | 18.52 | 71.10 | H | 1 |
| 20175 | 1732.5 | -22.12 | 41.36 | 19.24 | 83.95 | H | 1 |
| 20375 | 1752.5 | -22.96 | 42.63 | 19.67 | 92.66 | H | 1 |
| 19975 | 1712.5 | -18.95 | 44.17 | 25.22 | 332.35 | V | 1 |
| 20175 | 1732.5 | -18.33 | 44.20 | 25.87 | 386.37 | V | 1 |
| 20375 | 1752.5 | -18.71 | 44.35 | 25.64 | 366.02 | V | 1 |



Test Report No.: RF180521W014-3

LTE BAND 4

CHANNEL BANDWIDTH: 10MHz QPSK

| Channel | Frequency (MHz) | SPA LVL (dBm) | Correction Factor(dB) | EIRP(dBm) | EIRP(mW) | Polarization (H/V) | LIMIT (W) |
|---------|-----------------|---------------|-----------------------|-----------|---------------|--------------------|-----------|
| 20000 | 1715.0 | -21.85 | 41.49 | 19.64 | 91.96 | H | 1 |
| 20175 | 1732.5 | -21.04 | 41.36 | 20.32 | 107.65 | H | 1 |
| 20350 | 1750.0 | -21.73 | 42.28 | 20.55 | 113.58 | H | 1 |
| 20000 | 1715.0 | -17.93 | 44.06 | 26.13 | 410.49 | V | 1 |
| 20175 | 1732.5 | -17.25 | 44.20 | 26.95 | 495.45 | V | 1 |
| 20350 | 1750.0 | -17.48 | 44.43 | 26.95 | 495.45 | V | 1 |

CHANNEL BANDWIDTH: 10MHz 16QAM

| Channel | Frequency (MHz) | SPA LVL (dBm) | Correction Factor(dB) | EIRP(dBm) | EIRP(mW) | Polarization (H/V) | LIMIT (W) |
|---------|-----------------|---------------|-----------------------|-----------|----------|--------------------|-----------|
| 20000 | 1715.0 | -23.00 | 41.49 | 18.49 | 70.57 | H | 1 |
| 20175 | 1732.5 | -22.14 | 41.36 | 19.22 | 83.56 | H | 1 |
| 20350 | 1750.0 | -22.89 | 42.28 | 19.39 | 86.96 | H | 1 |
| 20000 | 1715.0 | -19.08 | 44.06 | 24.98 | 314.99 | V | 1 |
| 20175 | 1732.5 | -18.35 | 44.20 | 25.85 | 384.59 | V | 1 |
| 20350 | 1750.0 | -18.64 | 44.43 | 25.79 | 379.31 | V | 1 |

LTE BAND 4

CHANNEL BANDWIDTH: 15MHz QPSK

| Channel | Frequency (MHz) | SPA LVL (dBm) | Correction Factor(dB) | EIRP(dBm) | EIRP(mW) | Polarization (H/V) | LIMIT (W) |
|---------|-----------------|---------------|-----------------------|-----------|---------------|--------------------|-----------|
| 20025 | 1717.5 | -21.86 | 41.34 | 19.48 | 88.67 | H | 1 |
| 20175 | 1732.5 | -21.11 | 41.36 | 20.25 | 105.93 | H | 1 |
| 20325 | 1747.5 | -21.80 | 42.09 | 20.29 | 106.81 | H | 1 |
| 20025 | 1717.5 | -17.94 | 44.04 | 26.10 | 407.76 | V | 1 |
| 20175 | 1732.5 | -17.32 | 44.20 | 26.88 | 487.53 | V | 1 |
| 20325 | 1747.5 | -17.55 | 44.22 | 26.67 | 463.98 | V | 1 |



Test Report No.: RF180521W014-3

CHANNEL BANDWIDTH: 15MHz 16QAM

| Channel | Frequency (MHz) | SPA LVL (dBm) | Correction Factor(dB) | EIRP(dBm) | EIRP(mW) | Polarization (H/V) | LIMIT (W) |
|---------|-----------------|---------------|-----------------------|-----------|----------|--------------------|-----------|
| 20025 | 1717.5 | -22.72 | 41.34 | 18.62 | 72.74 | H | 1 |
| 20175 | 1732.5 | -21.98 | 41.36 | 19.38 | 86.70 | H | 1 |
| 20325 | 1747.5 | -22.65 | 42.09 | 19.44 | 87.82 | H | 1 |
| 20025 | 1717.5 | -18.80 | 44.04 | 25.24 | 334.50 | V | 1 |
| 20175 | 1732.5 | -18.19 | 44.20 | 26.01 | 399.02 | V | 1 |
| 20325 | 1747.5 | -18.40 | 44.22 | 25.82 | 381.50 | V | 1 |

LTE BAND 4

CHANNEL BANDWIDTH: 20MHz QPSK

| Channel | Frequency (MHz) | SPA LVL (dBm) | Correction Factor(dB) | EIRP(dBm) | EIRP(mW) | Polarization (H/V) | LIMIT (W) |
|---------|-----------------|---------------|-----------------------|-----------|---------------|--------------------|-----------|
| 20050 | 1720.0 | -22.44 | 41.28 | 18.84 | 76.58 | H | 1 |
| 20175 | 1732.5 | -21.56 | 41.36 | 19.80 | 95.52 | H | 1 |
| 20300 | 1745.0 | -22.38 | 41.96 | 19.58 | 90.72 | H | 1 |
| 20050 | 1720.0 | -18.52 | 44.14 | 25.62 | 364.33 | V | 1 |
| 20175 | 1732.5 | -17.77 | 44.20 | 26.43 | 439.14 | V | 1 |
| 20300 | 1745.0 | -18.13 | 43.88 | 25.75 | 376.01 | V | 1 |

CHANNEL BANDWIDTH: 20MHz 16QAM

| Channel | Frequency (MHz) | SPA LVL (dBm) | Correction Factor(dB) | EIRP(dBm) | EIRP(mW) | Polarization (H/V) | LIMIT (W) |
|---------|-----------------|---------------|-----------------------|-----------|----------|--------------------|-----------|
| 20050 | 1720.0 | -23.37 | 41.28 | 17.91 | 61.82 | H | 1 |
| 20175 | 1732.5 | -22.63 | 41.36 | 18.73 | 74.66 | H | 1 |
| 20300 | 1745.0 | -23.21 | 41.96 | 18.75 | 74.94 | H | 1 |
| 20050 | 1720.0 | -19.45 | 44.14 | 24.69 | 294.10 | V | 1 |
| 20175 | 1732.5 | -18.84 | 44.20 | 25.36 | 343.24 | V | 1 |
| 20300 | 1745.0 | -18.96 | 43.88 | 24.92 | 310.60 | V | 1 |

REMARKS: 1. EIRP Output Power (dBm) = SPA LVL (dBm) + Correction Factor (dB).
 2. Correction factor (dB) = Free Space Loss + Antenna Factor + Cable Loss



Test Report No.: RF180521W014-3

LTE BAND 12

CHANNEL BANDWIDTH: 1.4MHz QPSK

| Channel | Frequency (MHz) | SPA LVL (dBm) | Correction Factor(dB) | ERP(dBm) | ERP(mW) | Polarization (H/V) | LIMIT (W) |
|---------|-----------------|---------------|-----------------------|----------|---------------|--------------------|-----------|
| 23017 | 699.7 | -15.46 | 32.77 | 15.16 | 32.81 | H | 3 |
| 23095 | 707.5 | -14.45 | 33.23 | 16.63 | 46.03 | H | 3 |
| 23173 | 715.3 | -13.46 | 33.14 | 17.53 | 56.60 | H | 3 |
| 23017 | 699.7 | -8.49 | 32.42 | 21.78 | 150.52 | V | 3 |
| 23095 | 707.5 | -7.55 | 32.60 | 22.90 | 194.98 | V | 3 |
| 23173 | 715.3 | -7.69 | 32.19 | 22.35 | 171.63 | V | 3 |

CHANNEL BANDWIDTH: 1.4MHz 16QAM

| Channel | Frequency (MHz) | SPA LVL (dBm) | Correction Factor(dB) | ERP(dBm) | ERP(mW) | Polarization (H/V) | LIMIT (W) |
|---------|-----------------|---------------|-----------------------|----------|---------|--------------------|-----------|
| 23017 | 699.7 | -16.29 | 32.77 | 14.33 | 27.10 | H | 3 |
| 23095 | 707.5 | -15.47 | 33.23 | 15.61 | 36.39 | H | 3 |
| 23173 | 715.3 | -14.56 | 33.14 | 16.43 | 43.93 | H | 3 |
| 23017 | 699.7 | -9.32 | 32.42 | 20.95 | 124.34 | V | 3 |
| 23095 | 707.5 | -8.57 | 32.60 | 21.88 | 154.17 | V | 3 |
| 23173 | 715.3 | -8.79 | 32.19 | 21.25 | 133.23 | V | 3 |

LTE BAND 12

CHANNEL BANDWIDTH: 3MHz QPSK

| Channel | Frequency (MHz) | SPA LVL (dBm) | Correction Factor(dB) | ERP(dBm) | ERP(mW) | Polarization (H/V) | LIMIT (W) |
|---------|-----------------|---------------|-----------------------|----------|---------------|--------------------|-----------|
| 23025 | 700.5 | -15.27 | 32.63 | 15.21 | 33.20 | H | 3 |
| 23095 | 707.5 | -14.39 | 33.23 | 16.69 | 46.67 | H | 3 |
| 23165 | 714.5 | -13.33 | 33.21 | 17.73 | 59.22 | H | 3 |
| 23025 | 700.5 | -8.30 | 32.33 | 21.88 | 154.06 | V | 3 |
| 23095 | 707.5 | -7.49 | 32.60 | 22.96 | 197.70 | V | 3 |
| 23165 | 714.5 | -7.56 | 32.30 | 22.59 | 181.59 | V | 3 |



Test Report No.: RF180521W014-3

CHANNEL BANDWIDTH: 3MHz 16QAM

| Channel | Frequency (MHz) | SPA LVL (dBm) | Correction Factor(dB) | ERP(dBm) | ERP(mW) | Polarization (H/V) | LIMIT (W) |
|---------|-----------------|---------------|-----------------------|----------|---------|--------------------|-----------|
| 23025 | 700.5 | -16.42 | 32.63 | 14.06 | 25.47 | H | 3 |
| 23095 | 707.5 | -15.49 | 33.23 | 15.59 | 36.22 | H | 3 |
| 23165 | 714.5 | -14.49 | 33.21 | 16.57 | 45.34 | H | 3 |
| 23025 | 700.5 | -9.45 | 32.33 | 20.73 | 118.22 | V | 3 |
| 23095 | 707.5 | -8.59 | 32.60 | 21.86 | 153.46 | V | 3 |
| 23165 | 714.5 | -8.72 | 32.30 | 21.43 | 139.03 | V | 3 |

LTE BAND 12

CHANNEL BANDWIDTH: 5MHz QPSK

| Channel | Frequency (MHz) | SPA LVL (dBm) | Correction Factor(dB) | ERP(dBm) | ERP(mW) | Polarization (H/V) | LIMIT (W) |
|---------|-----------------|---------------|-----------------------|----------|---------------|--------------------|-----------|
| 23035 | 701.5 | -15.28 | 32.53 | 15.10 | 32.32 | H | 3 |
| 23095 | 707.5 | -14.46 | 33.23 | 16.62 | 45.90 | H | 3 |
| 23155 | 713.5 | -13.40 | 33.29 | 17.74 | 59.39 | H | 3 |
| 23035 | 701.5 | -8.31 | 32.25 | 21.79 | 151.15 | V | 3 |
| 23095 | 707.5 | -7.56 | 32.60 | 22.89 | 194.54 | V | 3 |
| 23155 | 713.5 | -7.63 | 32.39 | 22.61 | 182.22 | V | 3 |

CHANNEL BANDWIDTH: 5MHz 16QAM

| Channel | Frequency (MHz) | SPA LVL (dBm) | Correction Factor(dB) | ERP(dBm) | ERP(mW) | Polarization (H/V) | LIMIT (W) |
|---------|-----------------|---------------|-----------------------|----------|---------|--------------------|-----------|
| 23035 | 701.5 | -16.14 | 32.53 | 14.24 | 26.52 | H | 3 |
| 23095 | 707.5 | -15.33 | 33.23 | 15.75 | 37.57 | H | 3 |
| 23155 | 713.5 | -14.25 | 33.29 | 16.89 | 48.83 | H | 3 |
| 23035 | 701.5 | -9.17 | 32.25 | 20.93 | 123.99 | V | 3 |
| 23095 | 707.5 | -8.43 | 32.60 | 22.02 | 159.22 | V | 3 |
| 23155 | 713.5 | -8.48 | 32.39 | 21.76 | 149.83 | V | 3 |



Test Report No.: RF180521W014-3

LTE BAND 12

CHANNEL BANDWIDTH: 10MHz QPSK

| Channel | Frequency (MHz) | SPA LVL (dBm) | Correction Factor(dB) | ERP(dBm) | ERP(mW) | Polarization (H/V) | LIMIT (W) |
|---------|-----------------|---------------|-----------------------|----------|---------------|--------------------|-----------|
| 23060 | 704.0 | -15.86 | 32.68 | 14.67 | 29.33 | H | 3 |
| 23095 | 707.5 | -14.91 | 33.23 | 16.17 | 41.40 | H | 3 |
| 23130 | 711.0 | -13.98 | 33.39 | 17.26 | 53.17 | H | 3 |
| 23060 | 704.0 | -8.89 | 32.37 | 21.33 | 135.77 | V | 3 |
| 23095 | 707.5 | -8.01 | 32.60 | 22.44 | 175.39 | V | 3 |
| 23130 | 711.0 | -8.21 | 32.56 | 22.20 | 165.77 | V | 3 |

CHANNEL BANDWIDTH: 10MHz 16QAM

| Channel | Frequency (MHz) | SPA LVL (dBm) | Correction Factor(dB) | ERP(dBm) | ERP(mW) | Polarization (H/V) | LIMIT (W) |
|---------|-----------------|---------------|-----------------------|----------|---------|--------------------|-----------|
| 23060 | 704.0 | -16.79 | 32.68 | 13.74 | 23.68 | H | 3 |
| 23095 | 707.5 | -15.98 | 33.23 | 15.10 | 32.36 | H | 3 |
| 23130 | 711.0 | -14.81 | 33.39 | 16.43 | 43.92 | H | 3 |
| 23060 | 704.0 | -9.82 | 32.37 | 20.40 | 109.60 | V | 3 |
| 23095 | 707.5 | -9.08 | 32.60 | 21.37 | 137.09 | V | 3 |
| 23130 | 711.0 | -9.04 | 32.56 | 21.37 | 136.93 | V | 3 |

REMARKS: 1. ERP Output Power (dBm) = SPA LVL (dBm) + Correction Factor (dB) -2.15(dB).

2. Correction factor (dB) = Free Space Loss + Antenna Factor + Cable Loss

3.2 FREQUENCY STABILITY MEASUREMENT

3.2.1 LIMITS OF FREQUENCY STABILITY MEASUREMENT

The frequency stability shall be sufficient to ensure that the fundamental emissions stay within the authorized bands of operation.

3.2.2 TEST PROCEDURE

- Device is placed at the oven room. The oven room could control the temperatures and humidity. Power warm up is at least 15 min and power applied should perform before recording frequency error.
- EUT is connected the external power supply to control the DC input power. The test voltage range is from minimum to maximum working voltage. Each step shall be record the frequency error rate.
- The temperature range step is 10 degrees in this test items. All temperature levels shall be hold the $\pm 0.5^{\circ}\text{C}$ during the measurement testing. The each temperature step shall be at least 0.5 hours, consider the EUT could be test under the stability condition.

NOTE: The frequency error was recorded frequency error from the communication simulator.

3.2.3 TEST SETUP

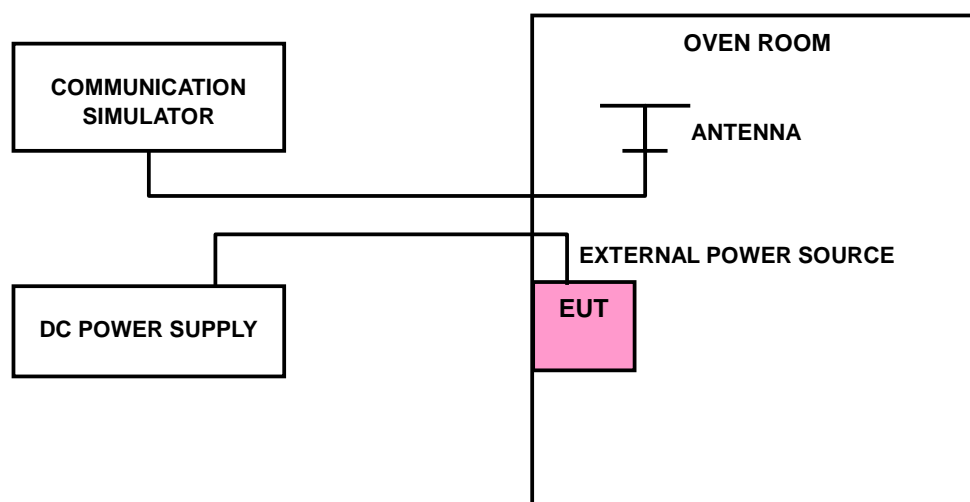



3.2.4 TEST RESULTS

LTE BAND 4

FREQUENCY ERROR VS. VOLTAGE

| VOLTAGE (Volts) | 1.4MHz | | LIMIT (ppm) |
|-----------------|-----------------------|--------------|-------------|
| | FREQUENCY ERROR (ppm) | | |
| | Low Channel | High Channel | |
| 3.8 | 0.0014 | 0.0016 | 2.5 |
| 3.4 | 0.0012 | 0.0014 | 2.5 |
| 4.2 | 0.0011 | 0.0013 | 2.5 |

NOTE: The applicant defined the normal working voltage of the battery is from 3.4Vdc to 4.2Vdc.

FREQUENCY ERROR vs. TEMPERATURE.

| TEMP. (°C) | 1.4MHz | | LIMIT (ppm) |
|------------|-----------------------|--------------|-------------|
| | FREQUENCY ERROR (ppm) | | |
| | Low Channel | High Channel | |
| -30 | -0.0060 | -0.0062 | 2.5 |
| -20 | -0.0056 | -0.0057 | 2.5 |
| -10 | -0.0047 | -0.0048 | 2.5 |
| 0 | -0.0040 | -0.0041 | 2.5 |
| 10 | -0.0034 | -0.0034 | 2.5 |
| 20 | -0.0026 | -0.0027 | 2.5 |
| 30 | -0.0023 | -0.0023 | 2.5 |
| 40 | -0.0018 | -0.0019 | 2.5 |
| 50 | -0.0014 | -0.0015 | 2.5 |



Test Report No.: RF180521W014-3

FREQUENCY ERROR VS. VOLTAGE

| VOLTAGE (Volts) | 3MHz | | LIMIT (ppm) |
|-----------------|-----------------------|--------------|-------------|
| | FREQUENCY ERROR (ppm) | | |
| | Low Channel | High Channel | |
| 3.8 | 0.0014 | 0.0015 | 2.5 |
| 3.4 | 0.0013 | 0.0013 | 2.5 |
| 4.2 | 0.0011 | 0.0012 | 2.5 |

NOTE: The applicant defined the normal working voltage of the battery is from 3.4Vdc to 4.2Vdc.

FREQUENCY ERROR vs. TEMPERATURE.

| TEMP. (°C) | 3MHz | | LIMIT (ppm) |
|------------|-----------------------|--------------|-------------|
| | FREQUENCY ERROR (ppm) | | |
| | Low Channel | High Channel | |
| -30 | -0.0065 | -0.0064 | 2.5 |
| -20 | -0.0059 | -0.0058 | 2.5 |
| -10 | -0.0056 | -0.0055 | 2.5 |
| 0 | -0.0048 | -0.0047 | 2.5 |
| 10 | -0.0041 | -0.0040 | 2.5 |
| 20 | -0.0033 | -0.0032 | 2.5 |
| 30 | -0.0026 | -0.0025 | 2.5 |
| 40 | -0.0023 | -0.0022 | 2.5 |
| 50 | -0.0018 | -0.0018 | 2.5 |



Test Report No.: RF180521W014-3

FREQUENCY ERROR VS. VOLTAGE

| VOLTAGE (Volts) | 5MHz | | LIMIT (ppm) |
|-----------------|-----------------------|--------------|-------------|
| | FREQUENCY ERROR (ppm) | | |
| | Low Channel | High Channel | |
| 3.8 | 0.0017 | 0.0017 | 2.5 |
| 3.4 | 0.0012 | 0.0015 | 2.5 |
| 4.2 | 0.0012 | 0.0012 | 2.5 |

NOTE: The applicant defined the normal working voltage of the battery is from 3.4Vdc to 4.2Vdc.

FREQUENCY ERROR vs. TEMPERATURE.

| TEMP. (°C) | 5MHz | | LIMIT (ppm) |
|------------|-----------------------|--------------|-------------|
| | FREQUENCY ERROR (ppm) | | |
| | Low Channel | High Channel | |
| -30 | -0.0066 | -0.0063 | 2.5 |
| -20 | -0.0061 | -0.0058 | 2.5 |
| -10 | -0.0055 | -0.0053 | 2.5 |
| 0 | -0.0051 | -0.0049 | 2.5 |
| 10 | -0.0041 | -0.0039 | 2.5 |
| 20 | -0.0036 | -0.0034 | 2.5 |
| 30 | -0.0030 | -0.0029 | 2.5 |
| 40 | -0.0022 | -0.0021 | 2.5 |
| 50 | -0.0019 | -0.0018 | 2.5 |



Test Report No.: RF180521W014-3

FREQUENCY ERROR VS. VOLTAGE

| VOLTAGE (Volts) | 10MHz | | LIMIT (ppm) |
|-----------------|-----------------------|--------------|-------------|
| | FREQUENCY ERROR (ppm) | | |
| | Low Channel | High Channel | |
| 3.8 | 0.0014 | 0.0015 | 2.5 |
| 3.4 | 0.0013 | 0.0011 | 2.5 |
| 4.2 | 0.0012 | 0.0008 | 2.5 |

NOTE: The applicant defined the normal working voltage of the battery is from 3.4Vdc to 4.2Vdc.

FREQUENCY ERROR vs. TEMPERATURE.

| TEMP. (°C) | 10MHz | | LIMIT (ppm) |
|------------|-----------------------|--------------|-------------|
| | FREQUENCY ERROR (ppm) | | |
| | Low Channel | High Channel | |
| -30 | -0.0061 | -0.0063 | 2.5 |
| -20 | -0.0058 | -0.0059 | 2.5 |
| -10 | -0.0050 | -0.0052 | 2.5 |
| 0 | -0.0046 | -0.0048 | 2.5 |
| 10 | -0.0039 | -0.0039 | 2.5 |
| 20 | -0.0031 | -0.0032 | 2.5 |
| 30 | -0.0029 | -0.0030 | 2.5 |
| 40 | -0.0022 | -0.0023 | 2.5 |
| 50 | -0.0014 | -0.0015 | 2.5 |



Test Report No.: RF180521W014-3

FREQUENCY ERROR VS. VOLTAGE

| VOLTAGE (Volts) | 15MHz | | LIMIT (ppm) |
|-----------------|-----------------------|--------------|-------------|
| | FREQUENCY ERROR (ppm) | | |
| | Low Channel | High Channel | |
| 3.8 | 0.0015 | 0.0016 | 2.5 |
| 3.4 | 0.0013 | 0.0013 | 2.5 |
| 4.2 | 0.0012 | 0.0011 | 2.5 |

NOTE: The applicant defined the normal working voltage of the battery is from 3.4Vdc to 4.2Vdc.

FREQUENCY ERROR vs. TEMPERATURE.

| TEMP. (°C) | 15MHz | | LIMIT (ppm) |
|------------|-----------------------|--------------|-------------|
| | FREQUENCY ERROR (ppm) | | |
| | Low Channel | High Channel | |
| -30 | -0.0061 | -0.0062 | 2.5 |
| -20 | -0.0056 | -0.0057 | 2.5 |
| -10 | -0.0049 | -0.0050 | 2.5 |
| 0 | -0.0043 | -0.0043 | 2.5 |
| 10 | -0.0036 | -0.0037 | 2.5 |
| 20 | -0.0033 | -0.0034 | 2.5 |
| 30 | -0.0029 | -0.0029 | 2.5 |
| 40 | -0.0024 | -0.0024 | 2.5 |
| 50 | -0.0018 | -0.0019 | 2.5 |



Test Report No.: RF180521W014-3

FREQUENCY ERROR VS. VOLTAGE

| VOLTAGE (Volts) | 20MHz | | LIMIT (ppm) |
|-----------------|-----------------------|--------------|-------------|
| | FREQUENCY ERROR (ppm) | | |
| | Low Channel | High Channel | |
| 3.8 | 0.0019 | 0.0013 | 2.5 |
| 3.4 | 0.0012 | 0.0013 | 2.5 |
| 4.2 | 0.0008 | 0.0011 | 2.5 |

NOTE: The applicant defined the normal working voltage of the battery is from 3.4Vdc to 4.2Vdc.

FREQUENCY ERROR vs. TEMPERATURE.

| TEMP. (°C) | 20MHz | | LIMIT (ppm) |
|------------|-----------------------|--------------|-------------|
| | FREQUENCY ERROR (ppm) | | |
| | Low Channel | High Channel | |
| -30 | -0.0064 | -0.0064 | 2.5 |
| -20 | -0.0059 | -0.0060 | 2.5 |
| -10 | -0.0052 | -0.0053 | 2.5 |
| 0 | -0.0044 | -0.0045 | 2.5 |
| 10 | -0.0038 | -0.0038 | 2.5 |
| 20 | -0.0031 | -0.0032 | 2.5 |
| 30 | -0.0029 | -0.0029 | 2.5 |
| 40 | -0.0022 | -0.0022 | 2.5 |
| 50 | -0.0018 | -0.0018 | 2.5 |



LTE BAND 12

FREQUENCY ERROR VS. VOLTAGE

| VOLTAGE (Volts) | 1.4MHz | | LIMIT (ppm) |
|-----------------|-----------------------|--------------|-------------|
| | FREQUENCY ERROR (ppm) | | |
| | Low Channel | High Channel | |
| 3.8 | 0.0018 | 0.0019 | 2.5 |
| 3.4 | 0.0016 | 0.0015 | 2.5 |
| 4.2 | 0.0010 | 0.0012 | 2.5 |

NOTE: The applicant defined the normal working voltage of the battery is from 3.4Vdc to 4.2Vdc.

FREQUENCY ERROR vs. TEMPERATURE.

| TEMP. (°C) | 1.4MHz | | LIMIT (ppm) |
|------------|-----------------------|--------------|-------------|
| | FREQUENCY ERROR (ppm) | | |
| | Low Channel | High Channel | |
| -30 | -0.0064 | -0.0065 | 2.5 |
| -20 | -0.0058 | -0.0059 | 2.5 |
| -10 | -0.0053 | -0.0054 | 2.5 |
| 0 | -0.0047 | -0.0048 | 2.5 |
| 10 | -0.0040 | -0.0041 | 2.5 |
| 20 | -0.0032 | -0.0033 | 2.5 |
| 30 | -0.0029 | -0.0030 | 2.5 |
| 40 | -0.0024 | -0.0024 | 2.5 |
| 50 | -0.0017 | -0.0017 | 2.5 |



Test Report No.: RF180521W014-3

FREQUENCY ERROR VS. VOLTAGE

| VOLTAGE (Volts) | 3MHz | | LIMIT (ppm) |
|-----------------|-----------------------|--------------|-------------|
| | FREQUENCY ERROR (ppm) | | |
| | Low Channel | High Channel | |
| 3.8 | 0.0018 | 0.0017 | 2.5 |
| 3.4 | 0.0012 | 0.0013 | 2.5 |
| 4.2 | 0.0010 | 0.0010 | 2.5 |

NOTE: The applicant defined the normal working voltage of the battery is from 3.4Vdc to 4.2Vdc.

FREQUENCY ERROR vs. TEMPERATURE.

| TEMP. (°C) | 3MHz | | LIMIT (ppm) |
|------------|-----------------------|--------------|-------------|
| | FREQUENCY ERROR (ppm) | | |
| | Low Channel | High Channel | |
| -30 | -0.0063 | -0.0062 | 2.5 |
| -20 | -0.0060 | -0.0060 | 2.5 |
| -10 | -0.0056 | -0.0055 | 2.5 |
| 0 | -0.0048 | -0.0047 | 2.5 |
| 10 | -0.0043 | -0.0042 | 2.5 |
| 20 | -0.0036 | -0.0035 | 2.5 |
| 30 | -0.0029 | -0.0028 | 2.5 |
| 40 | -0.0023 | -0.0023 | 2.5 |
| 50 | -0.0019 | -0.0018 | 2.5 |



Test Report No.: RF180521W014-3

FREQUENCY ERROR VS. VOLTAGE

| VOLTAGE (Volts) | 5MHz | | LIMIT (ppm) |
|-----------------|-----------------------|--------------|-------------|
| | FREQUENCY ERROR (ppm) | | |
| | Low Channel | High Channel | |
| 3.8 | 0.0018 | 0.0018 | 2.5 |
| 3.4 | 0.0014 | 0.0015 | 2.5 |
| 4.2 | 0.0012 | 0.0012 | 2.5 |

NOTE: The applicant defined the normal working voltage of the battery is from 3.4Vdc to 4.2Vdc.

FREQUENCY ERROR vs. TEMPERATURE.

| TEMP. (°C) | 5MHz | | LIMIT (ppm) |
|------------|-----------------------|--------------|-------------|
| | FREQUENCY ERROR (ppm) | | |
| | Low Channel | High Channel | |
| -30 | -0.0064 | -0.0061 | 2.5 |
| -20 | -0.0061 | -0.0058 | 2.5 |
| -10 | -0.0055 | -0.0053 | 2.5 |
| 0 | -0.0049 | -0.0047 | 2.5 |
| 10 | -0.0042 | -0.0040 | 2.5 |
| 20 | -0.0038 | -0.0036 | 2.5 |
| 30 | -0.0031 | -0.0029 | 2.5 |
| 40 | -0.0025 | -0.0024 | 2.5 |
| 50 | -0.0020 | -0.0019 | 2.5 |



Test Report No.: RF180521W014-3

FREQUENCY ERROR VS. VOLTAGE

| VOLTAGE (Volts) | 10MHz | | LIMIT (ppm) |
|-----------------|-----------------------|--------------|-------------|
| | FREQUENCY ERROR (ppm) | | |
| | Low Channel | High Channel | |
| 3.8 | 0.0017 | 0.0018 | 2.5 |
| 3.4 | 0.0013 | 0.0015 | 2.5 |
| 4.2 | 0.0012 | 0.0013 | 2.5 |

NOTE: The applicant defined the normal working voltage of the battery is from 3.4Vdc to 4.2Vdc.

FREQUENCY ERROR vs. TEMPERATURE.

| TEMP. (°C) | 10MHz | | LIMIT (ppm) |
|------------|-----------------------|--------------|-------------|
| | FREQUENCY ERROR (ppm) | | |
| | Low Channel | High Channel | |
| -30 | -0.0060 | -0.0061 | 2.5 |
| -20 | -0.0053 | -0.0055 | 2.5 |
| -10 | -0.0048 | -0.0049 | 2.5 |
| 0 | -0.0042 | -0.0043 | 2.5 |
| 10 | -0.0035 | -0.0036 | 2.5 |
| 20 | -0.0029 | -0.0030 | 2.5 |
| 30 | -0.0024 | -0.0025 | 2.5 |
| 40 | -0.0019 | -0.0019 | 2.5 |
| 50 | -0.0017 | -0.0018 | 2.5 |

3.3 OCCUPIED BANDWIDTH MEASUREMENT

3.3.1 LIMITS OF OCCUPIED BANDWIDTH MEASUREMENT

The width of a frequency band such that, below the lower and above the upper frequency limits, the mean powers emitted are each equal to a specified percentage 0.5 %of the total mean power of a given emission.

3.3.2 TEST SETUP

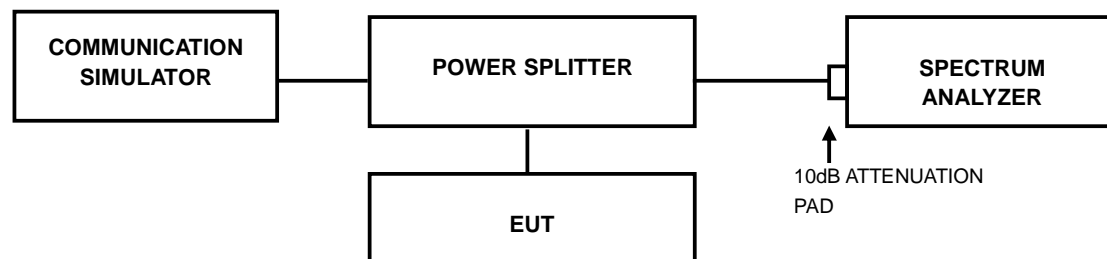

3.3.3 TEST PROCEDURES

- The conducted occupied bandwidth used the power splitter via EUT RF power connector between simulation base station and spectrum analyzer.
- Use OBW measurement function of Spectrum analyzer to measure 99 % occupied bandwidth.

3.3.4 TEST RESULTS

LTE BAND 4

| CHANNEL BANDWIDTH: 1.4MHz | | | | CHANNEL BANDWIDTH: 3MHz | | | |
|---------------------------|-----------------|------------------------------|-------|-------------------------|-----------------|------------------------------|-------|
| CHANNEL | Frequency (MHz) | 99% OCCUPIED Bandwidth (MHz) | | CHANNEL | Frequency (MHz) | 99% OCCUPIED Bandwidth (MHz) | |
| | | QPSK | 16QAM | | | QPSK | 16QAM |
| 19957 | 1710.7 | 1.08 | 1.08 | 19965 | 1711.5 | 2.68 | 2.69 |
| 20175 | 1732.5 | 1.09 | 1.08 | 20175 | 1732.5 | 2.68 | 2.68 |
| 20393 | 1754.3 | 1.09 | 1.08 | 20385 | 1753.5 | 2.68 | 2.68 |

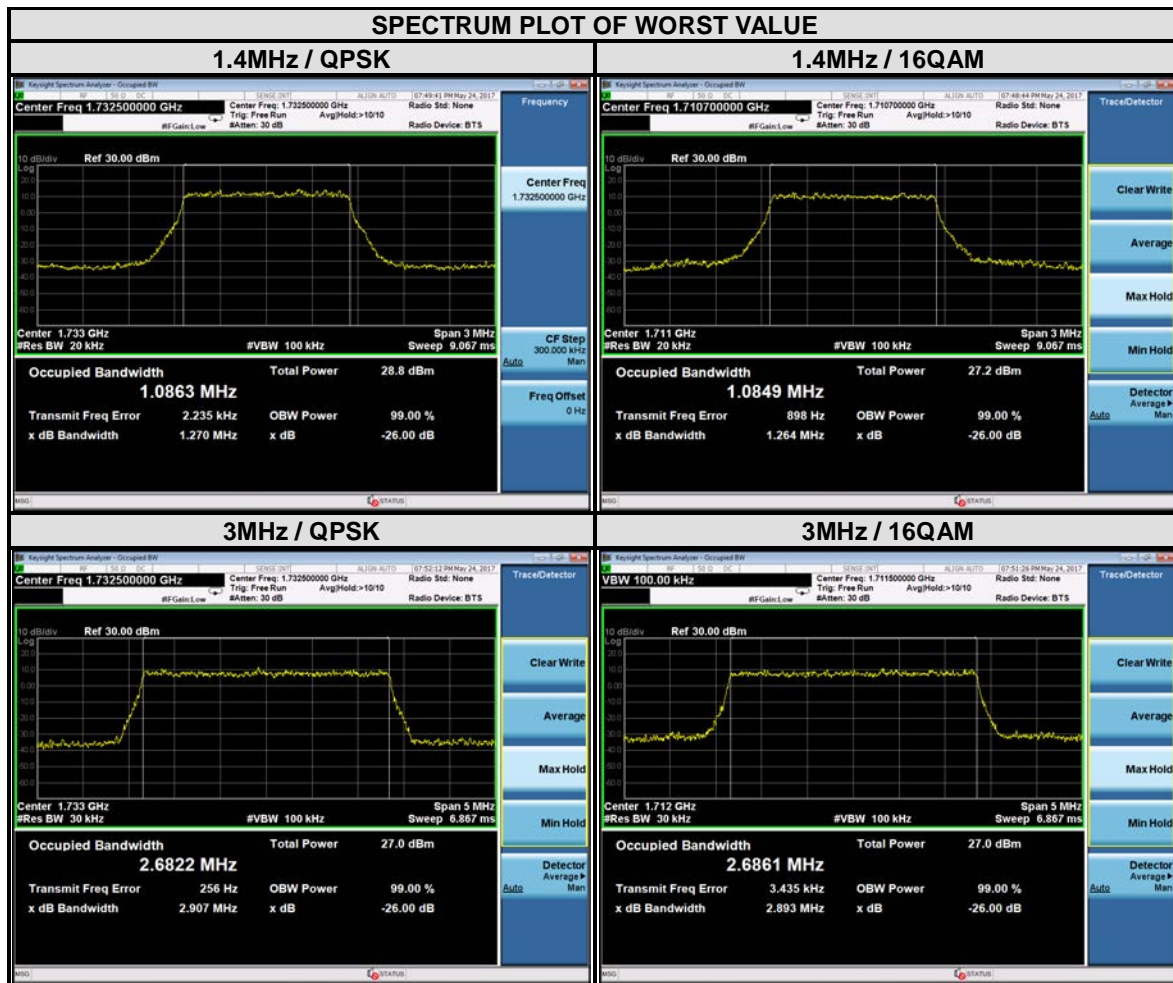



LTE BAND 4

| CHANNEL BANDWIDTH: 5MHz | | | | CHANNEL BANDWIDTH: 10MHz | | | |
|-------------------------|-----------------|------------------------------|-------|--------------------------|-----------------|------------------------------|-------|
| CHANNEL | Frequency (MHz) | 99% OCCUPIED Bandwidth (MHz) | | CHANNEL | Frequency (MHz) | 99% OCCUPIED Bandwidth (MHz) | |
| | | QPSK | 16QAM | | | QPSK | 16QAM |
| 19975 | 1712.5 | 4.48 | 4.50 | 20000 | 1715 | 8.92 | 8.92 |
| 20175 | 1732.5 | 4.47 | 4.47 | 20175 | 1732.5 | 8.89 | 8.94 |
| 20375 | 1752.5 | 4.48 | 4.47 | 20350 | 1750 | 8.90 | 8.92 |



LTE BAND 4

| CHANNEL BANDWIDTH: 15MHz | | | | CHANNEL BANDWIDTH: 20MHz | | | |
|--------------------------|-----------------|------------------------------|-------|--------------------------|-----------------|------------------------------|-------|
| CHANNEL | FREQUENCY (MHz) | 99% OCCUPIED BANDWIDTH (MHz) | | CHANNEL | FREQUENCY (MHz) | 99% OCCUPIED BANDWIDTH (MHz) | |
| | | QPSK | 16QAM | | | QPSK | 16QAM |
| 20025 | 1717.5 | 13.34 | 13.35 | 20050 | 1720 | 17.80 | 17.75 |
| 20175 | 1732.5 | 13.37 | 13.39 | 20175 | 1732.5 | 17.83 | 17.85 |
| 20325 | 1747.5 | 13.33 | 13.32 | 20300 | 1745 | 17.82 | 17.77 |





Test Report No.: RF180521W014-3

LTE BAND 12

| CHANNEL BANDWIDTH: 1.4MHz | | | | CHANNEL BANDWIDTH: 3MHz | | | |
|---------------------------|-----------------|------------------------------|-------|-------------------------|-----------------|------------------------------|-------|
| CHANNEL | FREQUENCY (MHz) | 99% OCCUPIED BANDWIDTH (MHz) | | CHANNEL | FREQUENCY (MHz) | 99% OCCUPIED BANDWIDTH (MHz) | |
| | | QPSK | 16QAM | | | QPSK | 16QAM |
| 23017 | 699.7 | 1.09 | 1.09 | 23025 | 700.5 | 2.69 | 2.68 |
| 23095 | 707.5 | 1.09 | 1.08 | 23095 | 707.5 | 2.69 | 2.69 |
| 23173 | 715.3 | 1.09 | 1.08 | 23165 | 714.5 | 2.68 | 2.68 |

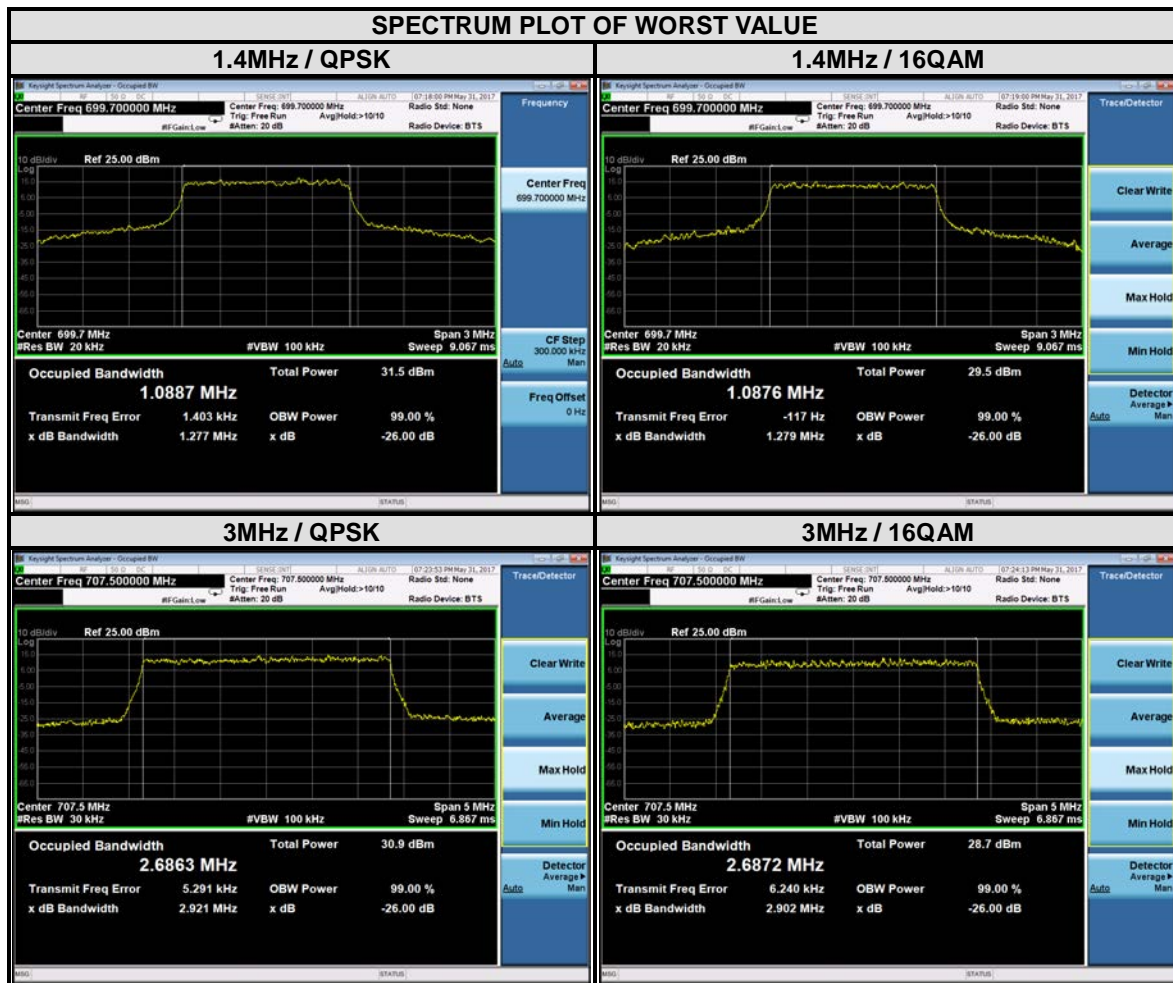



LTE BAND 12

| CHANNEL BANDWIDTH: 5MHz | | | | CHANNEL BANDWIDTH: 10MHz | | | |
|-------------------------|-----------------|------------------------------|-------|--------------------------|-----------------|------------------------------|-------|
| CHANNEL | Frequency (MHz) | 99% OCCUPIED Bandwidth (MHz) | | CHANNEL | Frequency (MHz) | 99% OCCUPIED Bandwidth (MHz) | |
| | | QPSK | 16QAM | | | QPSK | 16QAM |
| 23035 | 701.5 | 4.49 | 4.47 | 23060 | 704 | 8.94 | 8.94 |
| 23095 | 707.5 | 4.47 | 4.47 | 23095 | 707.5 | 8.93 | 8.92 |
| 23155 | 713.5 | 4.49 | 4.48 | 23130 | 711 | 8.82 | 8.87 |



3.4 PEAK TO AVERAGE RATIO

3.4.1 LIMITS OF PEAK TO AVERAGE RATIO MEASUREMENT

In measuring transmissions in this band using an average power technique, the peak to-average ratio (PAR) of the transmission may not exceed 13 dB

3.4.2 TEST SETUP

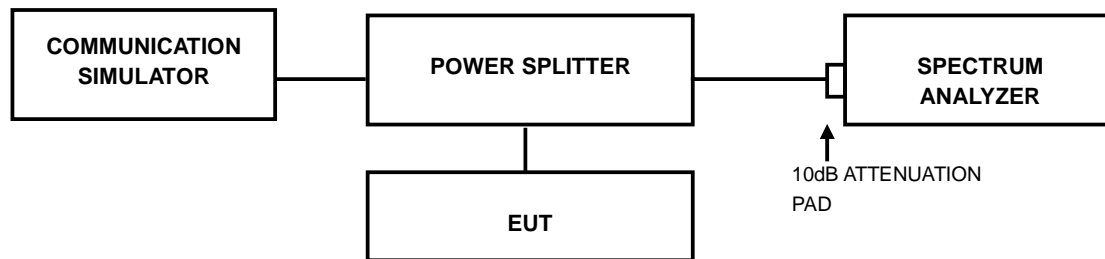

3.4.3 TEST PROCEDURES

1. Set resolution/measurement bandwidth \geq signal's occupied bandwidth;
2. Set the number of counts to a value that stabilizes the measured CCDF curve;
3. Record the maximum PAPR level associated with a probability of 0.1%.

3.4.4 TEST RESULTS

LTE BAND 4

| CHANNEL BANDWIDTH: 1.4MHz | | | | CHANNEL BANDWIDTH: 3MHz | | | |
|---------------------------|-----------------|----------------------------|-------|-------------------------|-----------------|----------------------------|-------|
| CHANNEL | FREQUENCY (MHz) | PEAK TO AVERAGE RATIO (dB) | | CHANNEL | FREQUENCY (MHz) | PEAK TO AVERAGE RATIO (dB) | |
| | | QPSK | 16QAM | | | QPSK | 16QAM |
| 19957 | 1710.7 | 4.77 | 5.61 | 19965 | 1711.5 | 4.83 | 5.69 |
| 20175 | 1732.5 | 5.29 | 6.17 | 20175 | 1732.5 | 5.38 | 6.15 |
| 20393 | 1754.3 | 4.24 | 5.13 | 20385 | 1753.5 | 4.36 | 5.23 |

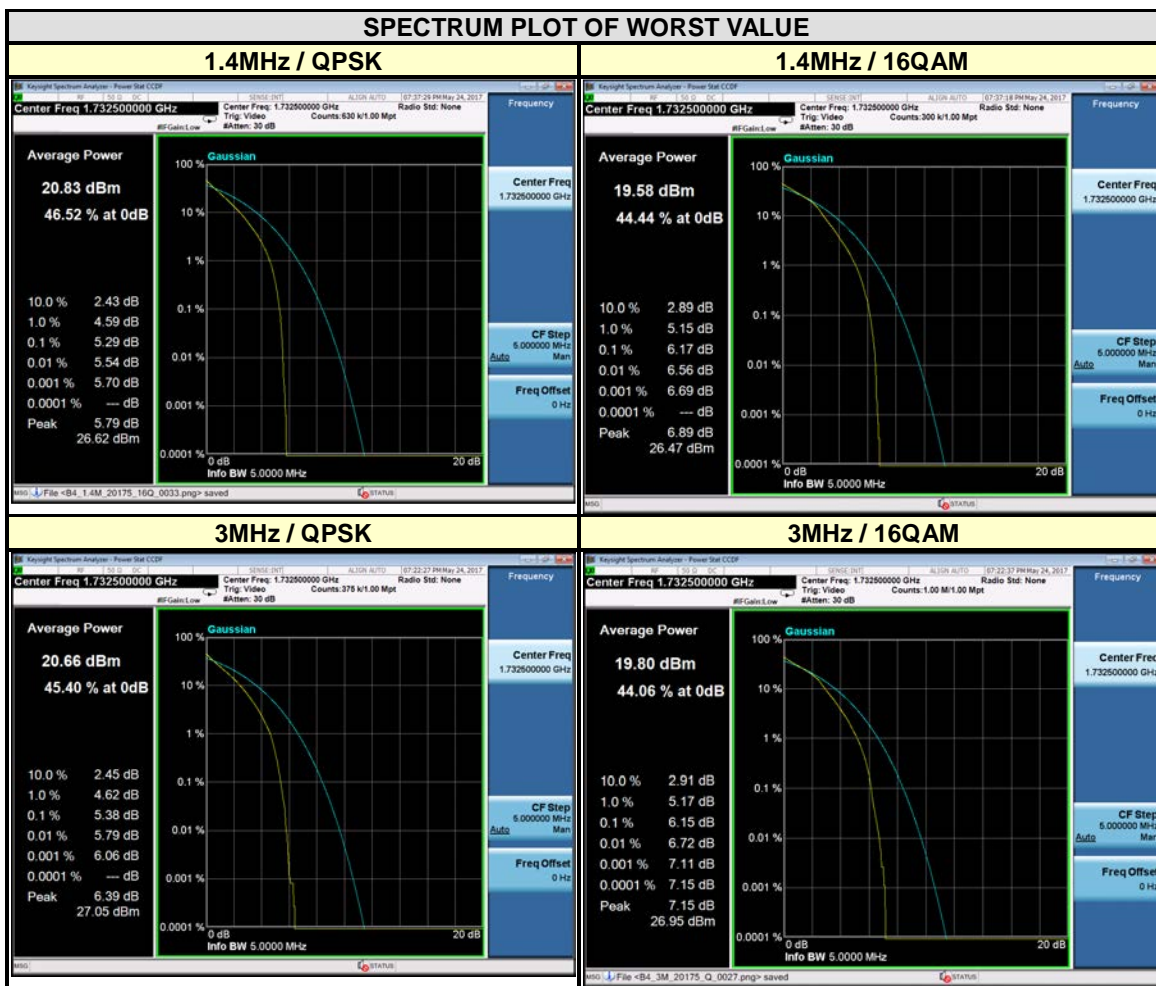



Test Report No.: RF180521W014-3

| CHANNEL BANDWIDTH: 5MHz | | | | CHANNEL BANDWIDTH: 10MHz | | | |
|-------------------------|-----------------|----------------------------|-------|--------------------------|-----------------|----------------------------|-------|
| CHANNEL | FREQUENCY (MHz) | PEAK TO AVERAGE RATIO (dB) | | CHANNEL | FREQUENCY (MHz) | PEAK TO AVERAGE RATIO (dB) | |
| | | QPSK | 16QAM | | | QPSK | 16QAM |
| 19975 | 1712.5 | 4.92 | 5.67 | 20000 | 1715 | 4.62 | 5.47 |
| 20175 | 1732.5 | 5.34 | 6.05 | 20175 | 1732.5 | 5.44 | 6.10 |
| 20375 | 1752.5 | 4.66 | 5.41 | 20350 | 1750 | 4.43 | 5.18 |

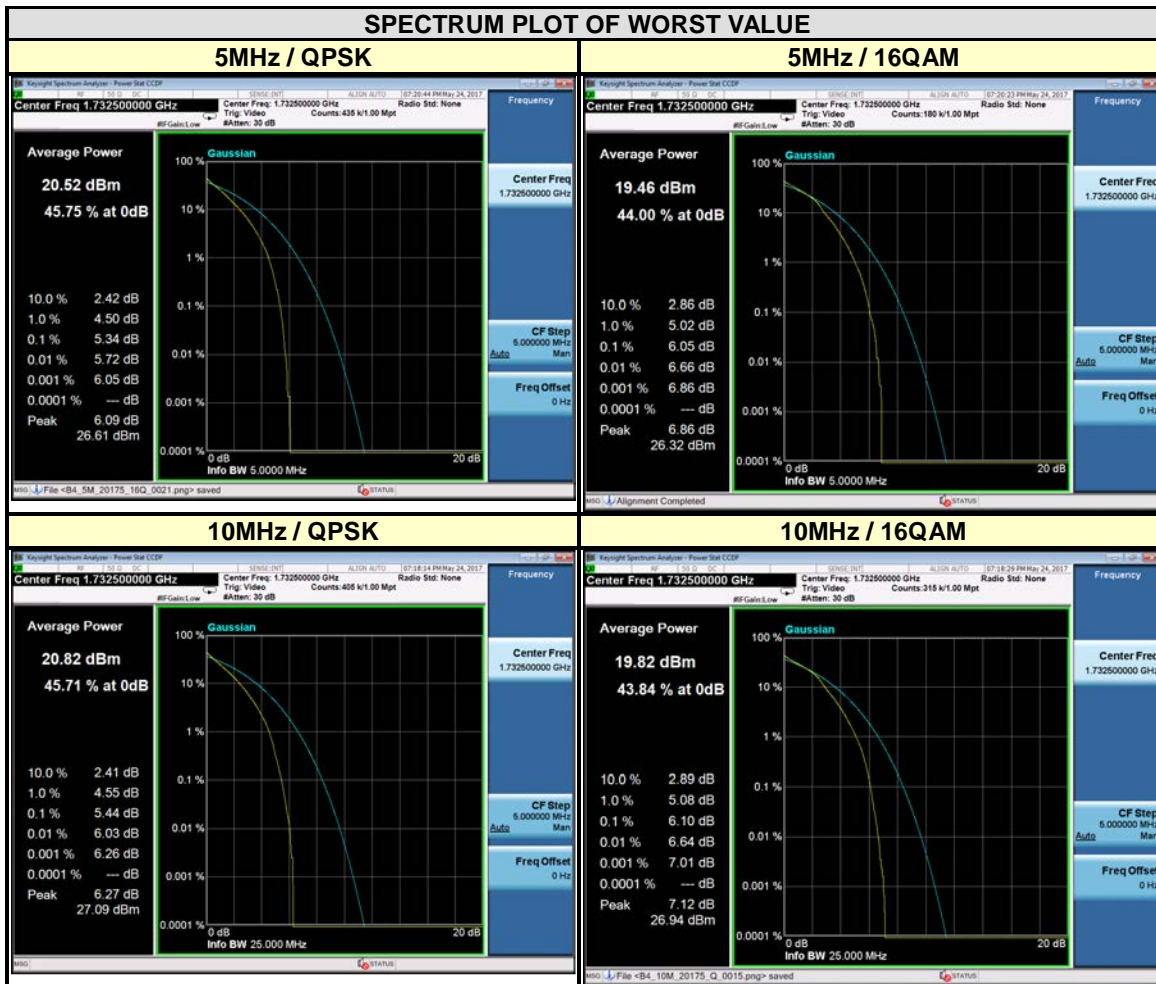



Test Report No.: RF180521W014-3

| CHANNEL BANDWIDTH: 15MHz | | | | CHANNEL BANDWIDTH: 20MHz | | | |
|--------------------------|-----------------|----------------------------|-------|--------------------------|-----------------|----------------------------|-------|
| CHANNEL | FREQUENCY (MHz) | PEAK TO AVERAGE RATIO (dB) | | CHANNEL | FREQUENCY (MHz) | PEAK TO AVERAGE RATIO (dB) | |
| | | QPSK | 16QAM | | | QPSK | 16QAM |
| 20025 | 1717.5 | 4.80 | 5.59 | 20050 | 1720 | 4.90 | 5.68 |
| 20175 | 1732.5 | 5.30 | 6.07 | 20175 | 1732.5 | 5.33 | 6.08 |
| 20325 | 1747.5 | 4.67 | 5.47 | 20300 | 1745 | 4.81 | 5.64 |

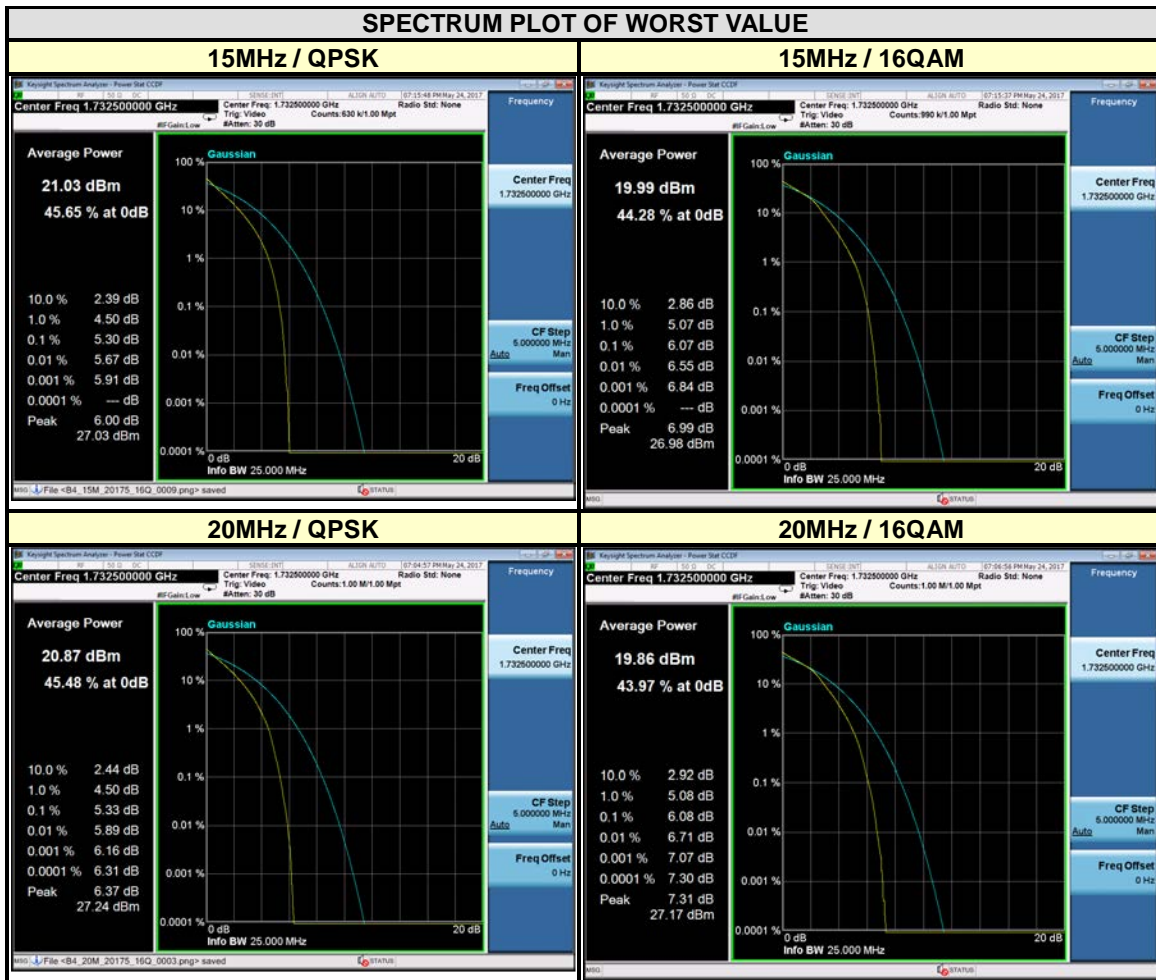



LTE BAND 12

| CHANNEL BANDWIDTH: 1.4MHz | | | | CHANNEL BANDWIDTH: 3MHz | | | |
|---------------------------|-----------------|----------------------------|-------|-------------------------|-----------------|----------------------------|-------|
| CHANNEL | FREQUENCY (MHz) | PEAK TO AVERAGE RATIO (dB) | | CHANNEL | FREQUENCY (MHz) | PEAK TO AVERAGE RATIO (dB) | |
| | | QPSK | 16QAM | | | QPSK | 16QAM |
| 23017 | 699.7 | 3.35 | 4.19 | 23025 | 700.5 | 3.68 | 4.44 |
| 23095 | 707.5 | 5.52 | 6.39 | 23095 | 707.5 | 5.54 | 6.34 |
| 23173 | 715.3 | 4.68 | 5.51 | 23165 | 714.5 | 4.29 | 5.04 |

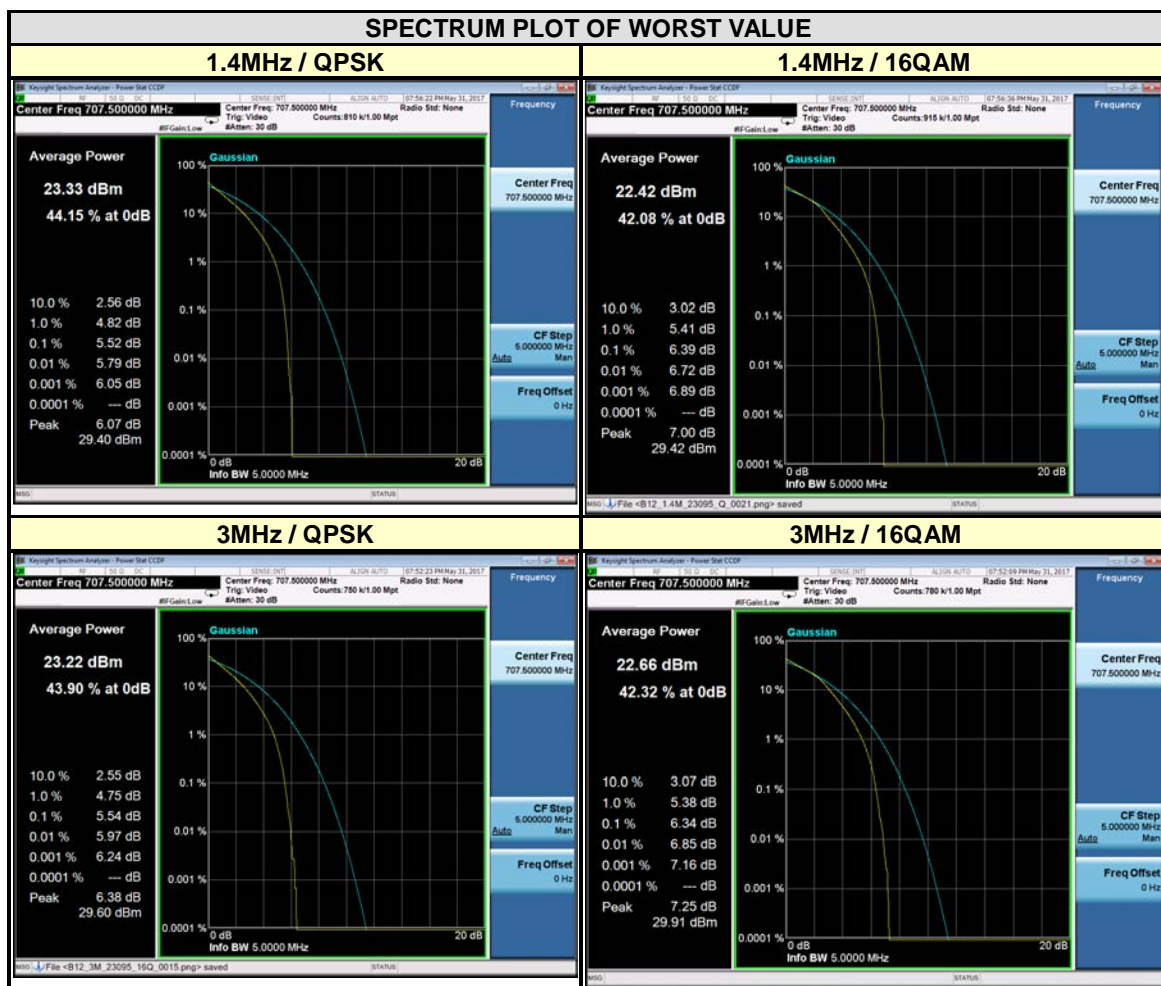



Test Report No.: RF180521W014-3

| CHANNEL BANDWIDTH: 5MHz | | | | CHANNEL BANDWIDTH: 10MHz | | | |
|-------------------------|-----------------|----------------------------|-------|--------------------------|-----------------|----------------------------|-------|
| CHANNEL | FREQUENCY (MHz) | PEAK TO AVERAGE RATIO (dB) | | CHANNEL | FREQUENCY (MHz) | PEAK TO AVERAGE RATIO (dB) | |
| | | QPSK | 16QAM | | | QPSK | 16QAM |
| 23035 | 701.5 | 3.79 | 4.51 | 23060 | 704 | 4.91 | 5.69 |
| 23095 | 707.5 | 5.30 | 6.20 | 23095 | 707.5 | 4.74 | 5.72 |
| 23155 | 713.5 | 4.09 | 4.82 | 23130 | 711 | 4.58 | 5.38 |

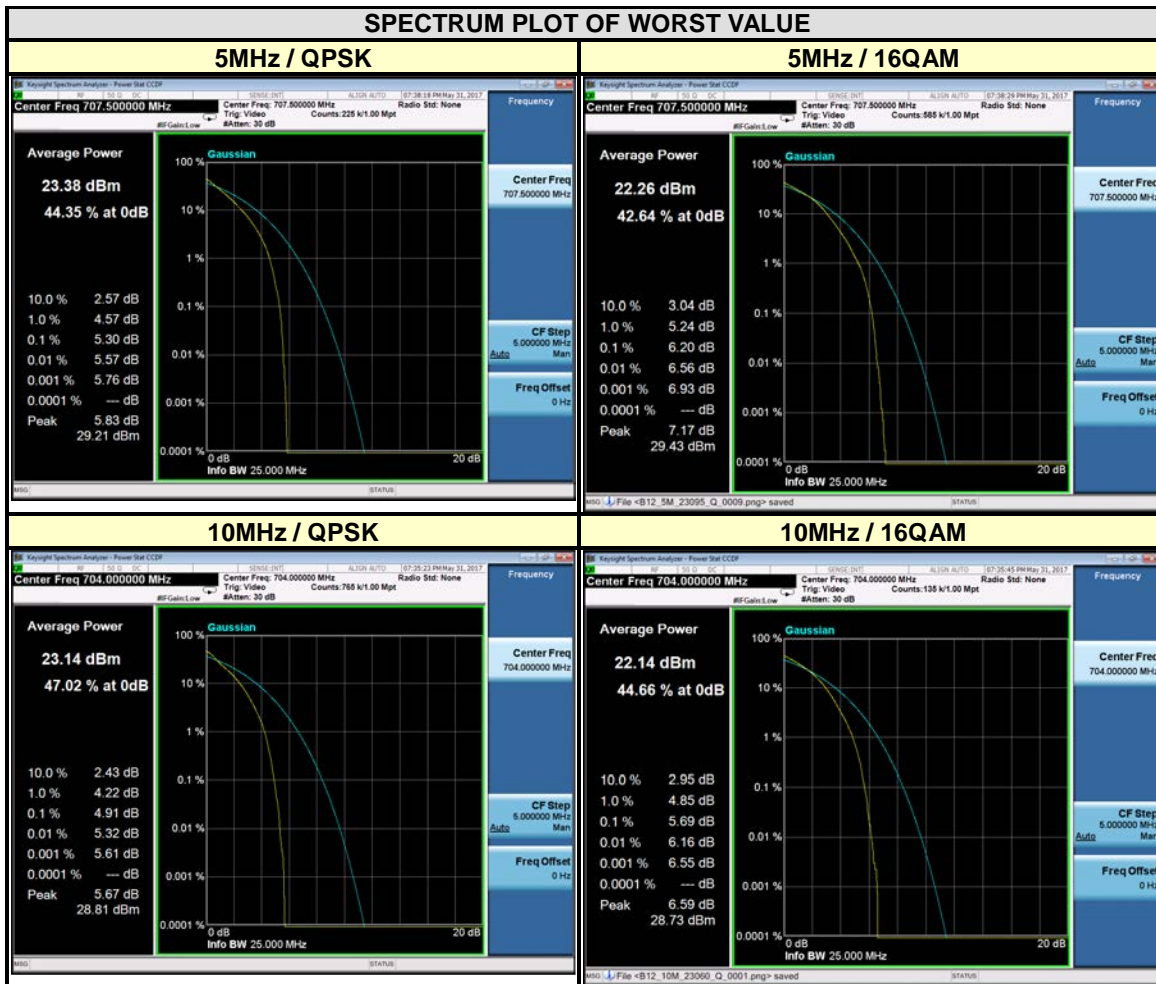

3.5 BAND EDGE MEASUREMENT

3.5.1 LIMITS OF BAND EDGE MEASUREMENT

The power of any emission outside a licensee's frequency band(s) of operation shall be attenuated below the transmitter power (P) within the licensed band(s) of operation, measured in watts, by at least $43 + 10 \log(P)$ dB. Compliance with this provision is based on the use of measurement instrumentation employing a resolution bandwidth of 100 kilohertz or greater.

However, in the 100 kilohertz bands immediately outside and adjacent to a licensee's frequency block, a resolution bandwidth of at least 30 kHz may be employed.

3.5.2 TEST SETUP

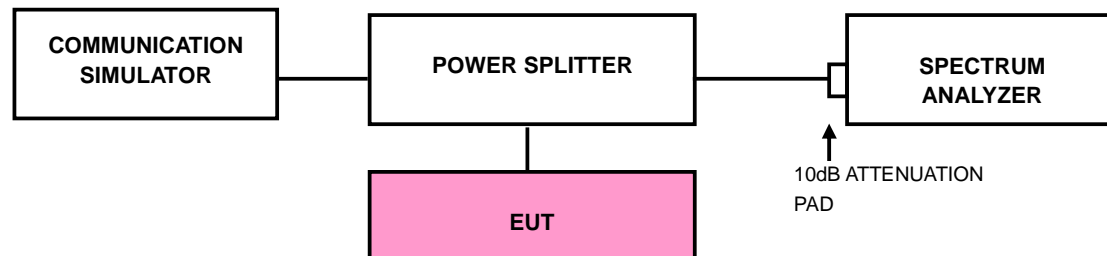



3.5.3 TEST PROCEDURES

- a. The EUT was set up for the maximum peak power with LTE link data modulation. The power was measured with R&S Spectrum Analyzer. All measurements were done at 2 channels (low and high operational frequency range.).
- b. The band edge measurement used the power splitter via EUT RF power connector between simulation base station and spectrum analyzer.
- c. The center frequency of spectrum is the band edge frequency and span is 1~5 MHz. RBW of the spectrum is 20kHz and VBW of the spectrum is 100 kHz. (LTE bandwidth 1.4MHz)
- d. The center frequency of spectrum is the band edge frequency and span is 1~5 MHz. RBW of the spectrum is 30kHz and VBW of the spectrum is 100kHz. (LTE bandwidth 3MHz)
- e. The center frequency of spectrum is the band edge frequency and span is 1~5 MHz. RBW of the spectrum is 50kHz and VBW of the spectrum is 200kHz. (LTE bandwidth 5MHz)
- f. The center frequency of spectrum is the band edge frequency and span is 1~5 MHz. RBW of the spectrum is 100kHz and VBW of the spectrum is 300kHz. (LTE bandwidth 10MHz)
- g. The center frequency of spectrum is the band edge frequency and span is 1~5 MHz. RBW of the spectrum is 200kHz and VBW of the spectrum is 1MHz. (LTE bandwidth 15MHz)
- h. The center frequency of spectrum is the band edge frequency and span is 1~5 MHz. RBW of the spectrum is 200kHz and VBW of the spectrum is 1MHz. (LTE bandwidth 20MHz)
- i. Record the max trace plot into the test report.



Test Report No.: RF180521W014-3

3.5.4 TEST RESULTS

LTE BAND 4

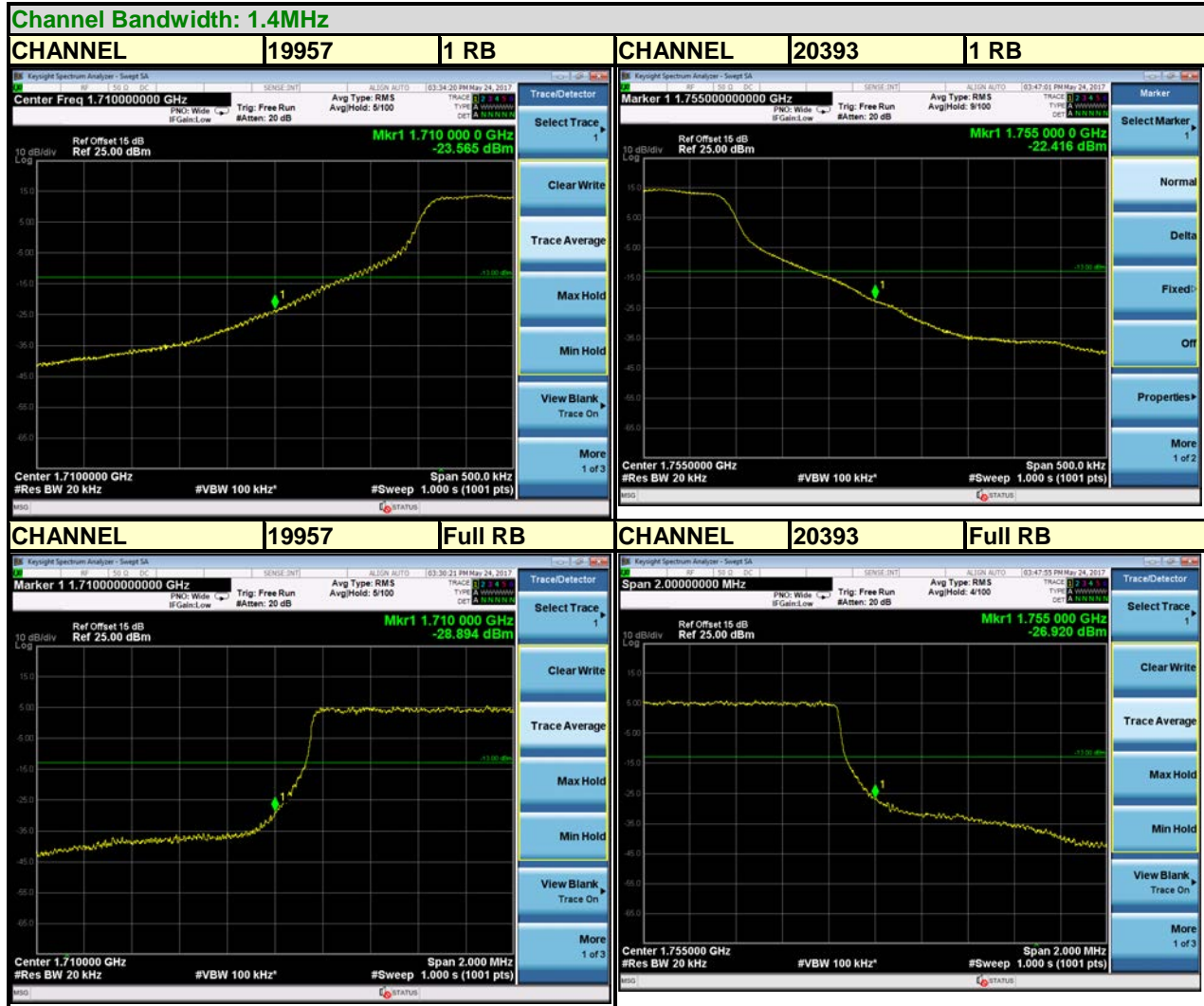



Test Report No.: RF180521W014-3

LTE BAND 4

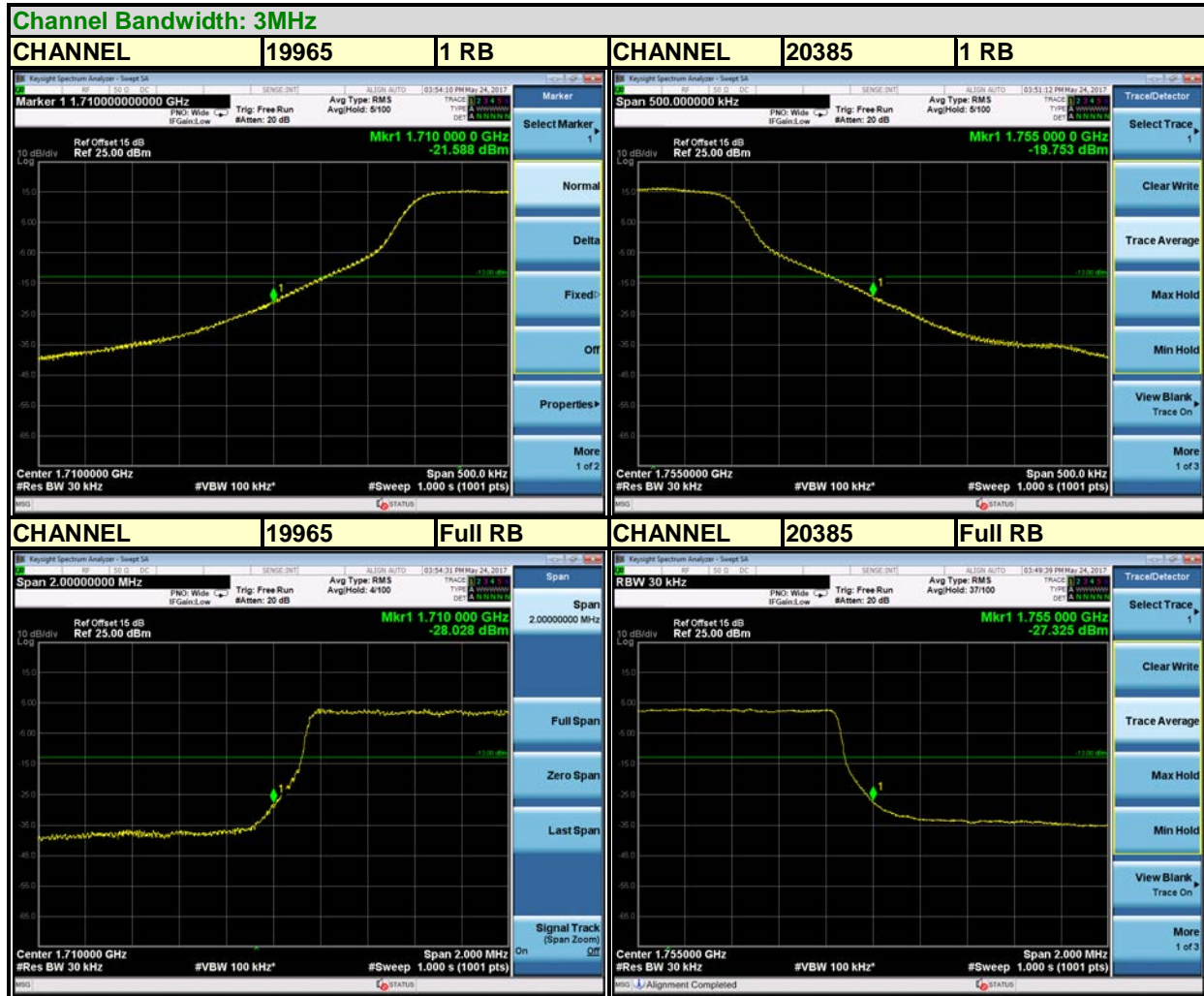



Test Report No.: RF180521W014-3

LTE BAND 4

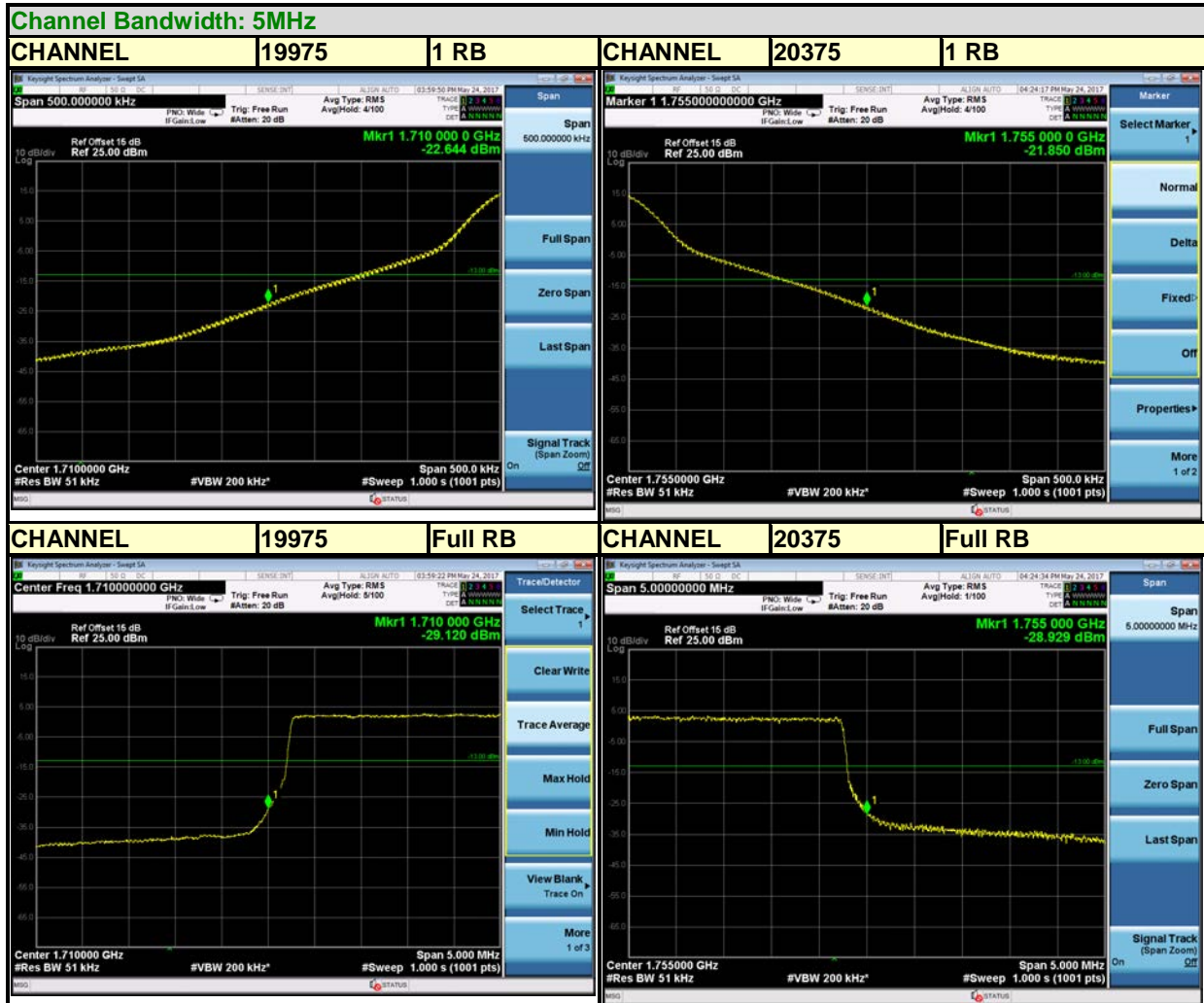



Test Report No.: RF180521W014-3

LTE BAND 4

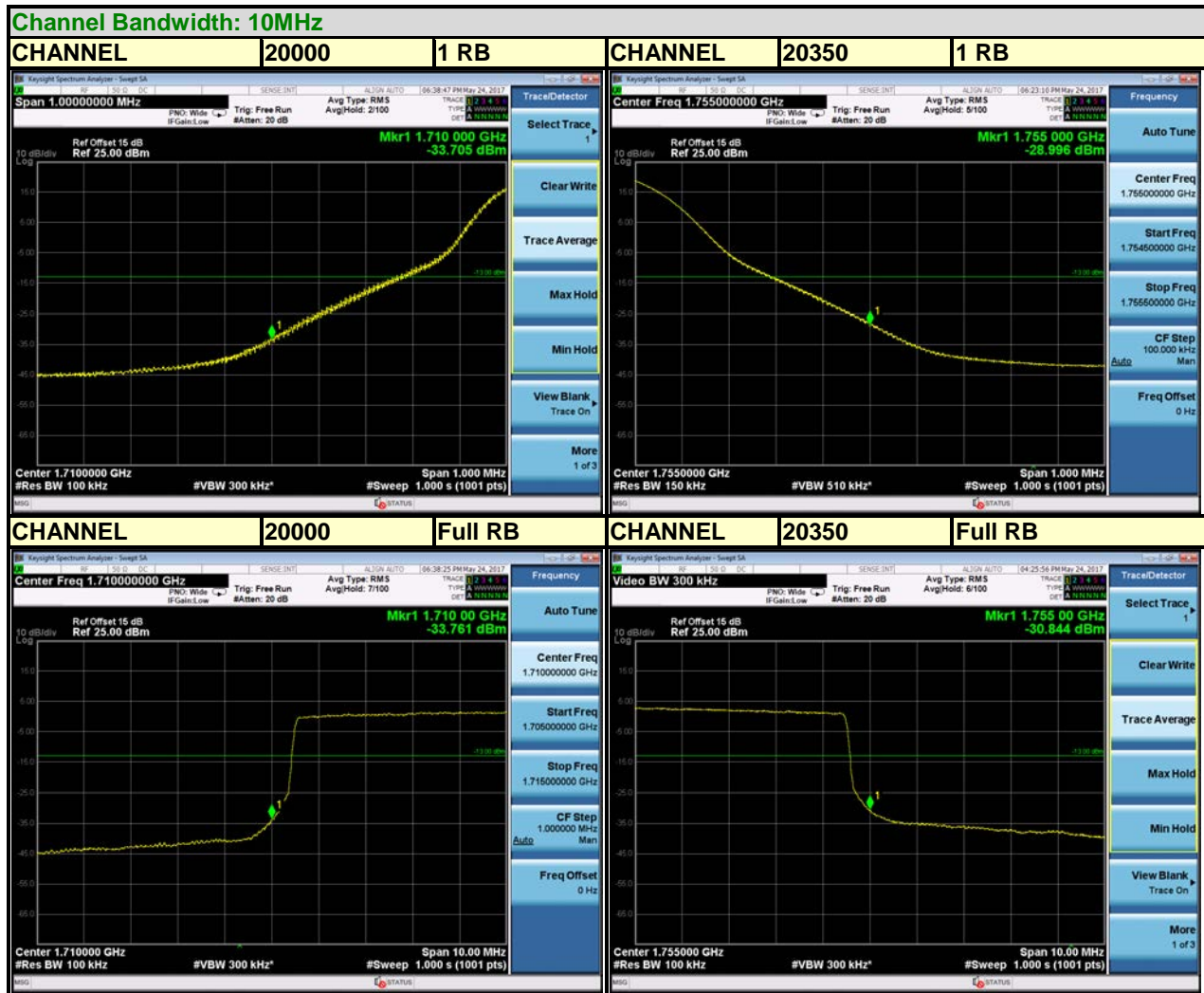



Test Report No.: RF180521W014-3

LTE BAND 4

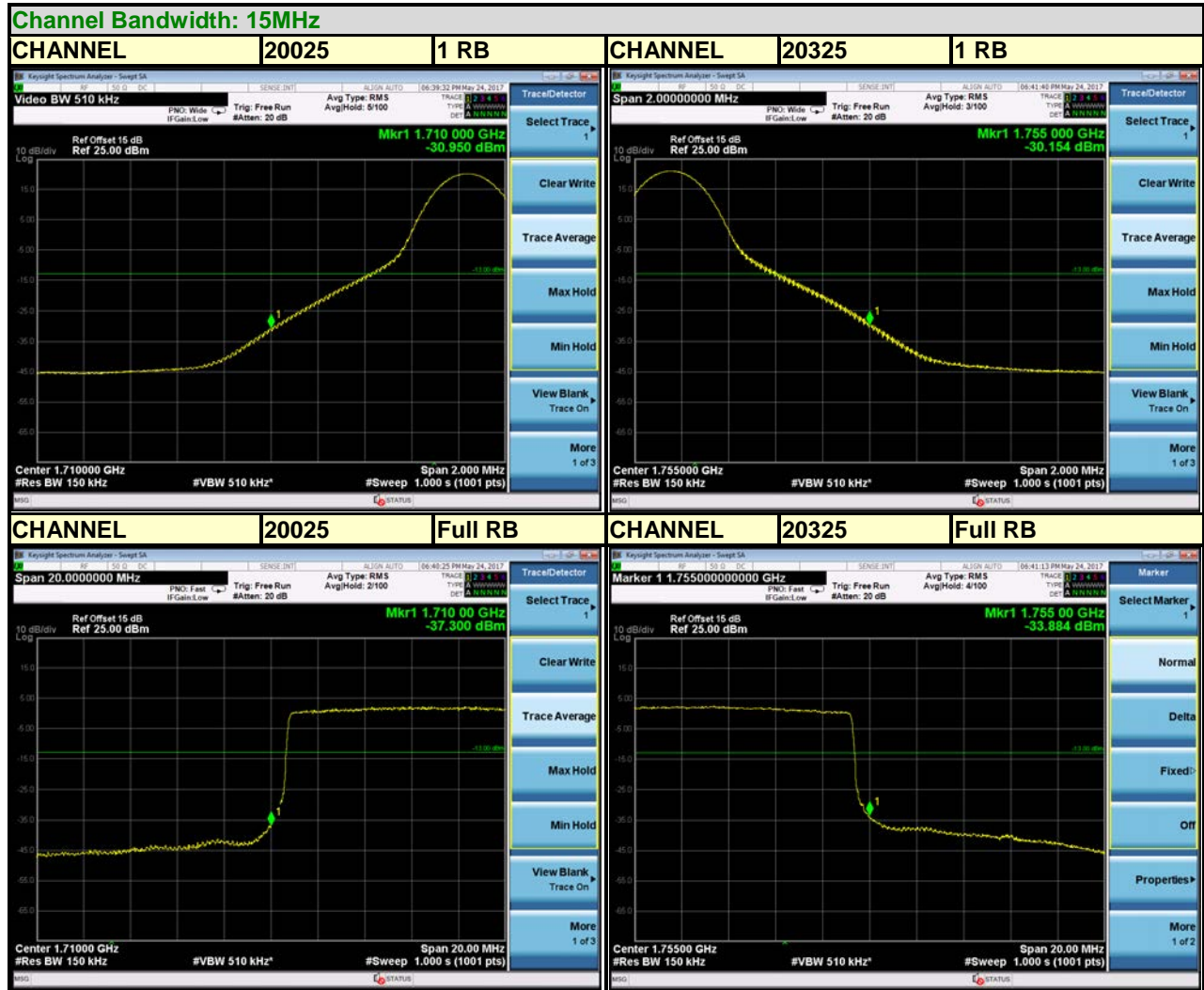



Test Report No.: RF180521W014-3

LTE BAND 4

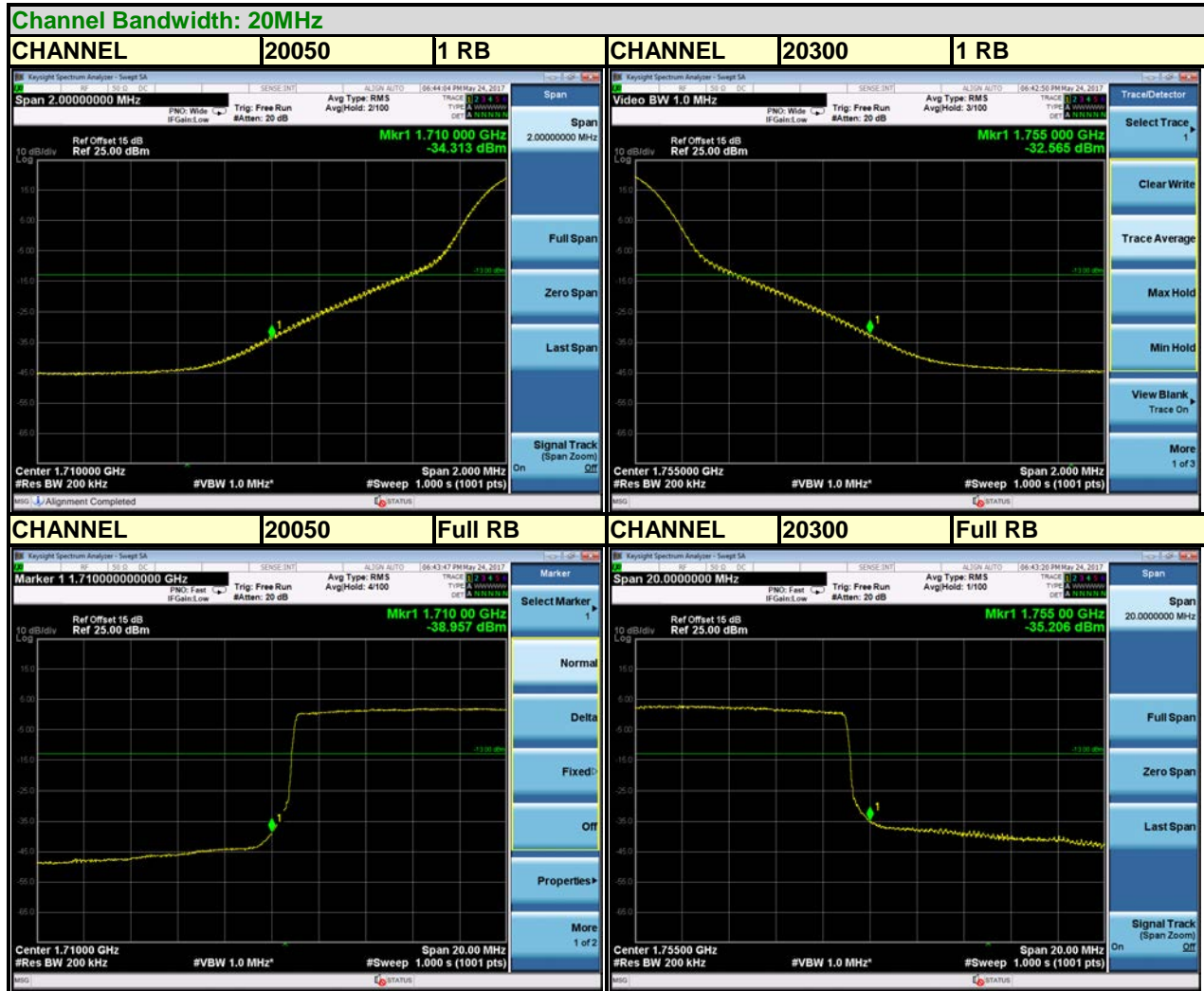



Test Report No.: RF180521W014-3

LTE BAND 12





Test Report No.: RF180521W014-3

LTE BAND 12

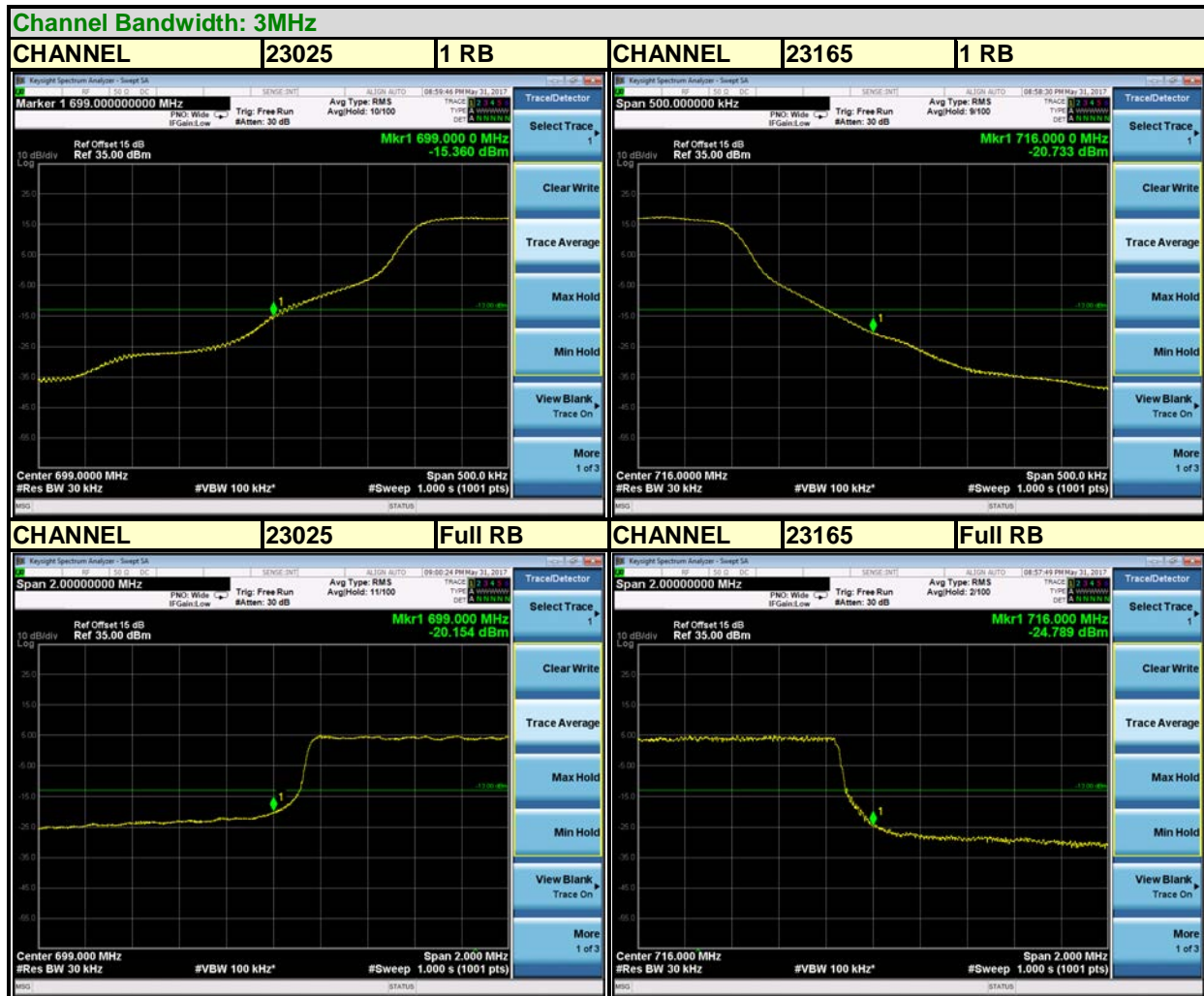



Test Report No.: RF180521W014-3

LTE BAND 12

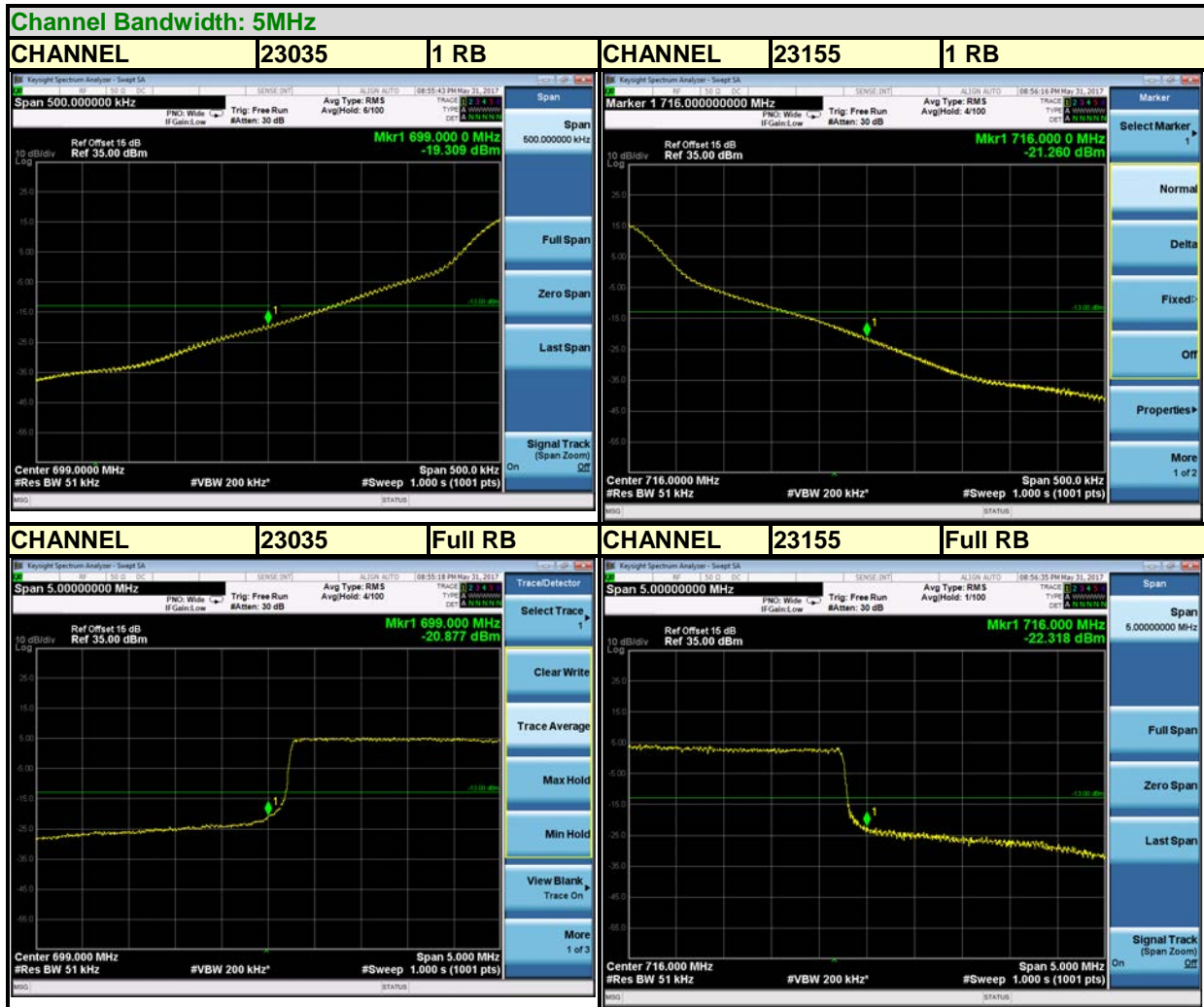



Test Report No.: RF180521W014-3

LTE BAND 12

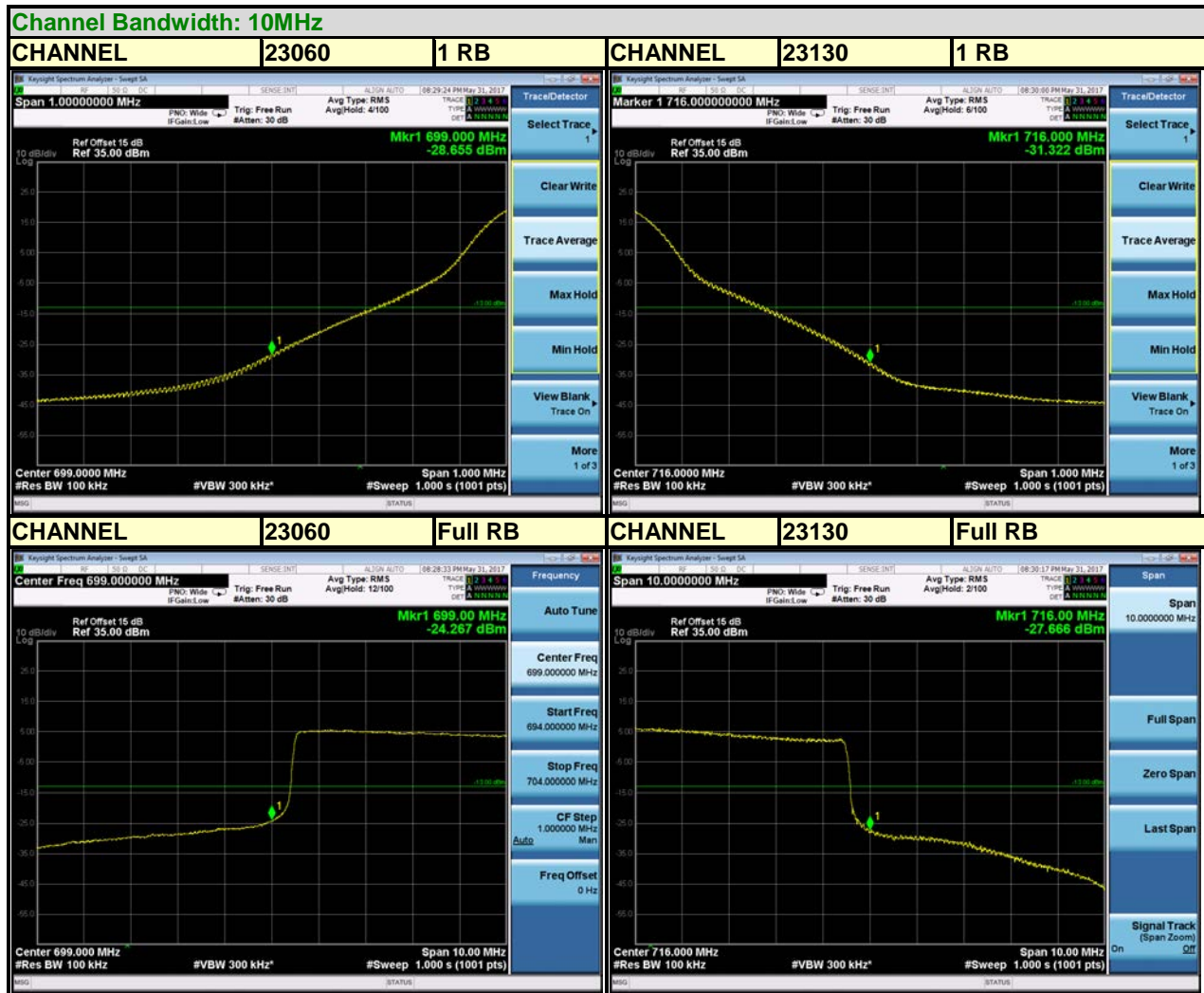

3.6 CONDUCTED SPURIOUS EMISSIONS

3.6.1 LIMITS OF CONDUCTED SPURIOUS EMISSIONS MEASUREMENT

The power of any emission outside a licensee's frequency block shall be attenuated below the transmitter power (P) by at least $43 + 10 \log_{10}(P)$ dB. The limit of emission equal to -13dBm

3.6.2 TEST PROCEDURE

- a. The EUT makes a phone call to the communication simulator. All measurements were done at middle operational frequency range.
- b. Measuring frequency range is from 30 MHz to 19.1GHz for LTE Band 4 and 30 MHz to 9GHz for LTE Band 12. 10dB attenuation pad is connected with spectrum. RBW=1MHz and VBW=3MHz are used for conducted emission measurement.

3.6.3 TEST SETUP

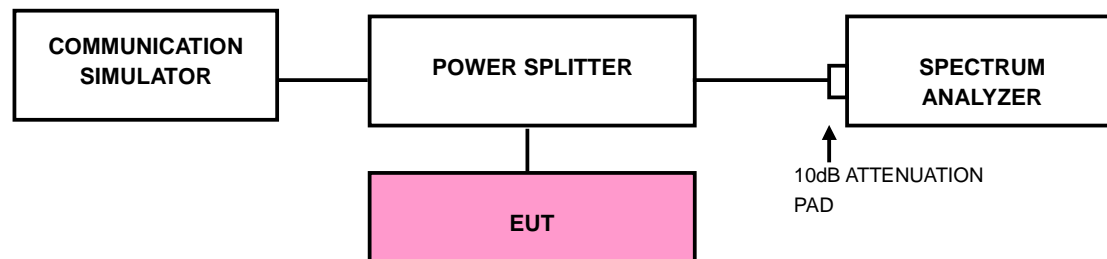



3.6.4 TEST RESULTS

LTE BAND 4

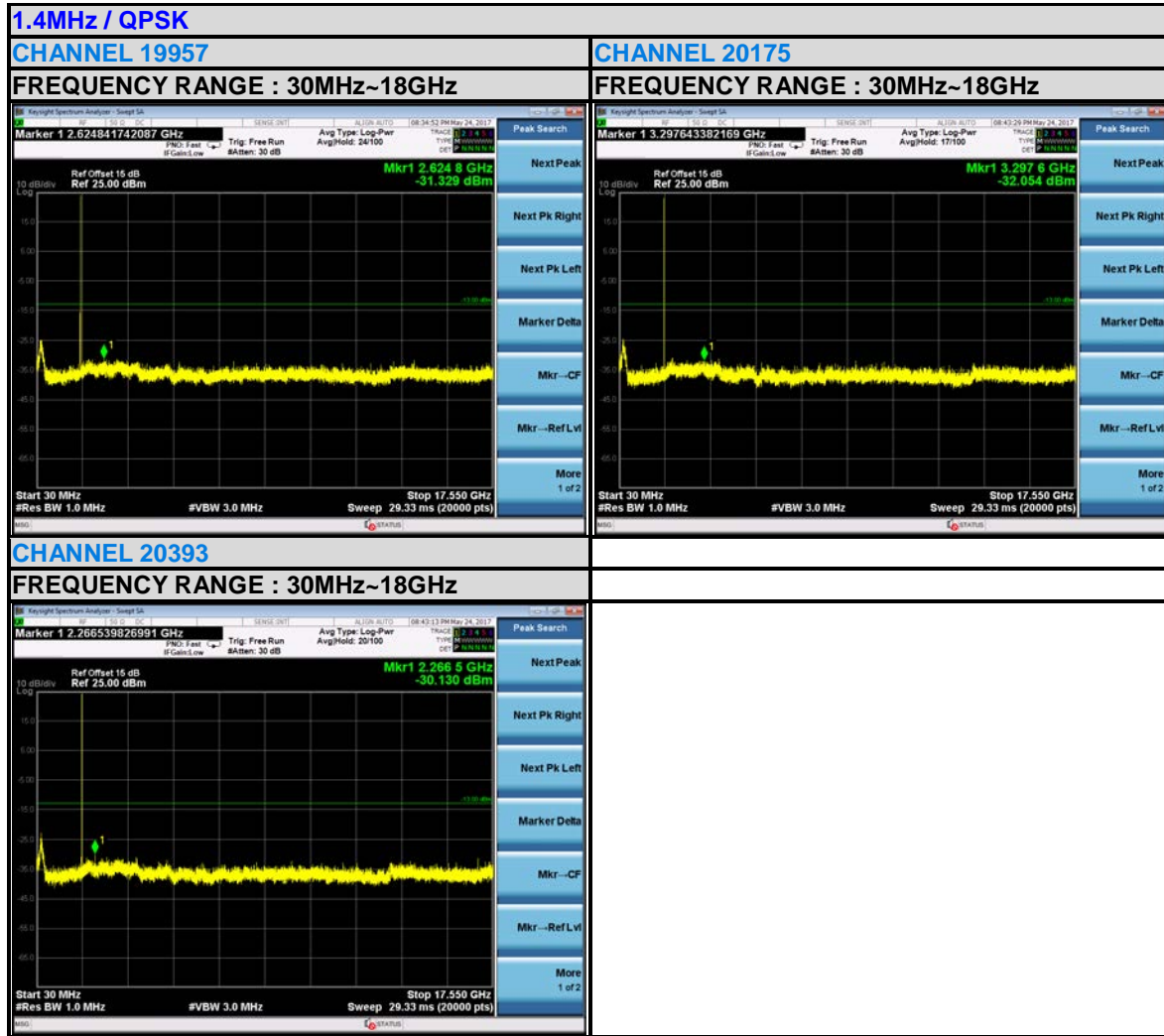



Test Report No.: RF180521W014-3

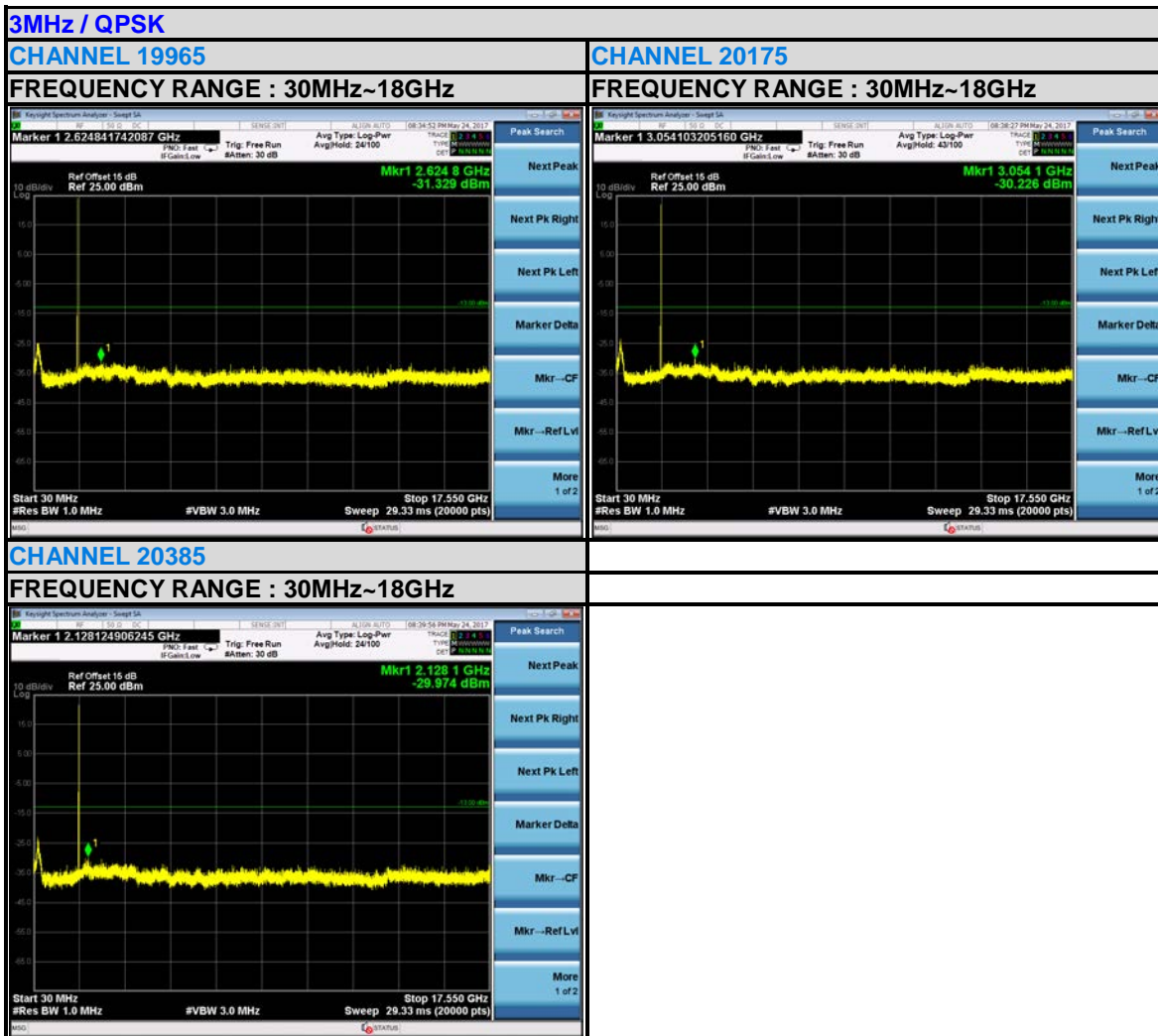



Test Report No.: RF180521W014-3

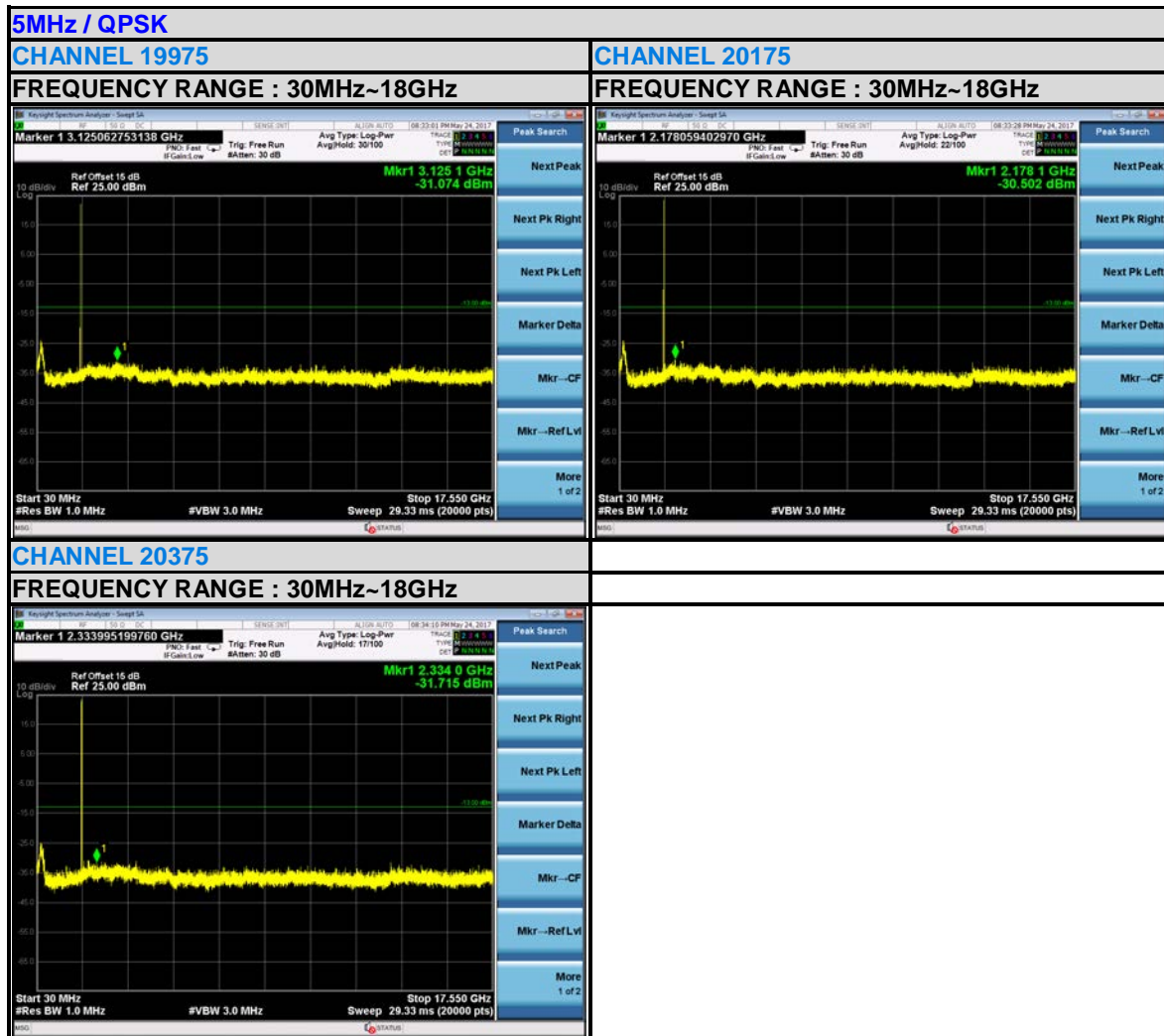



Test Report No.: RF180521W014-3

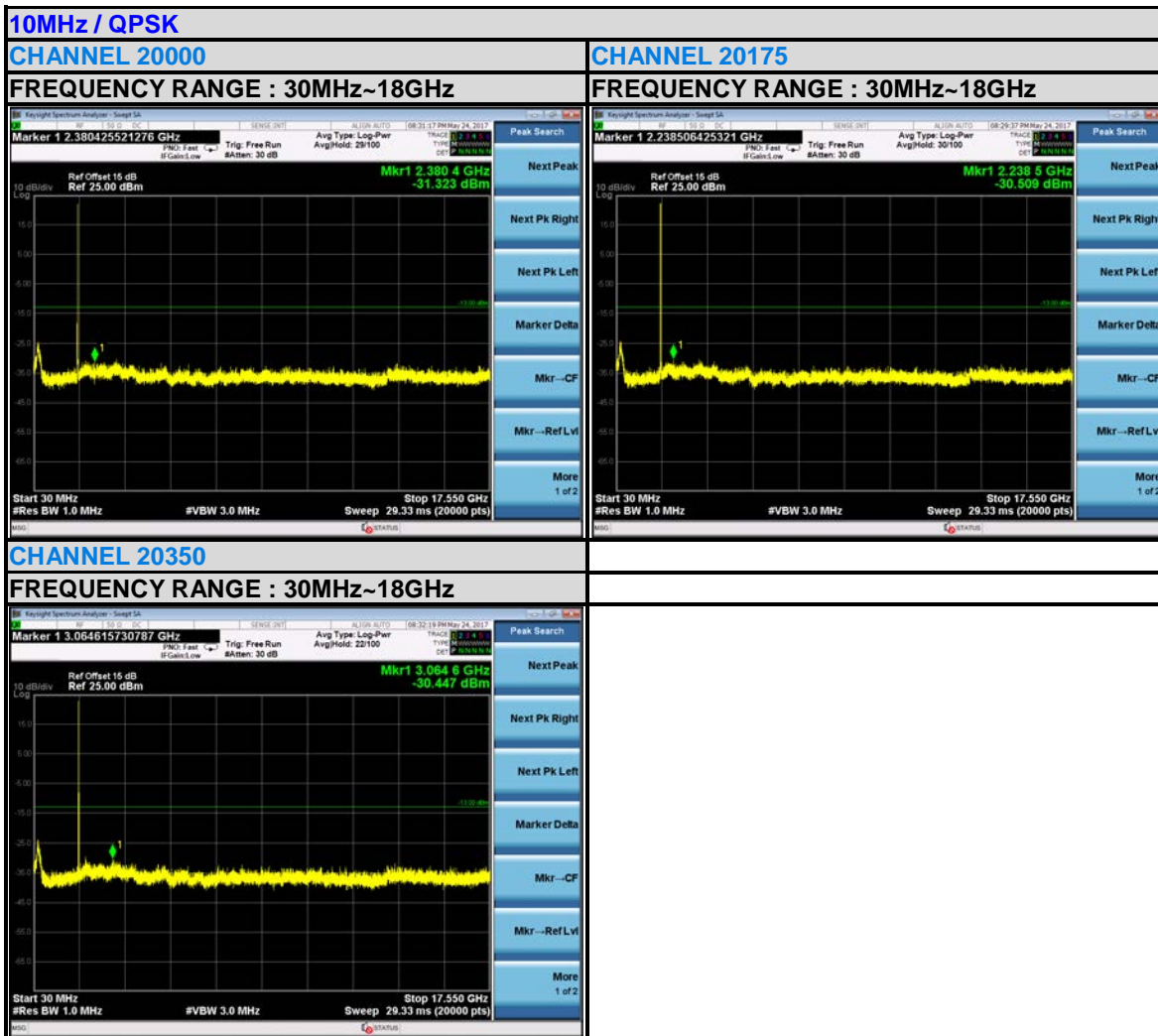



Test Report No.: RF180521W014-3

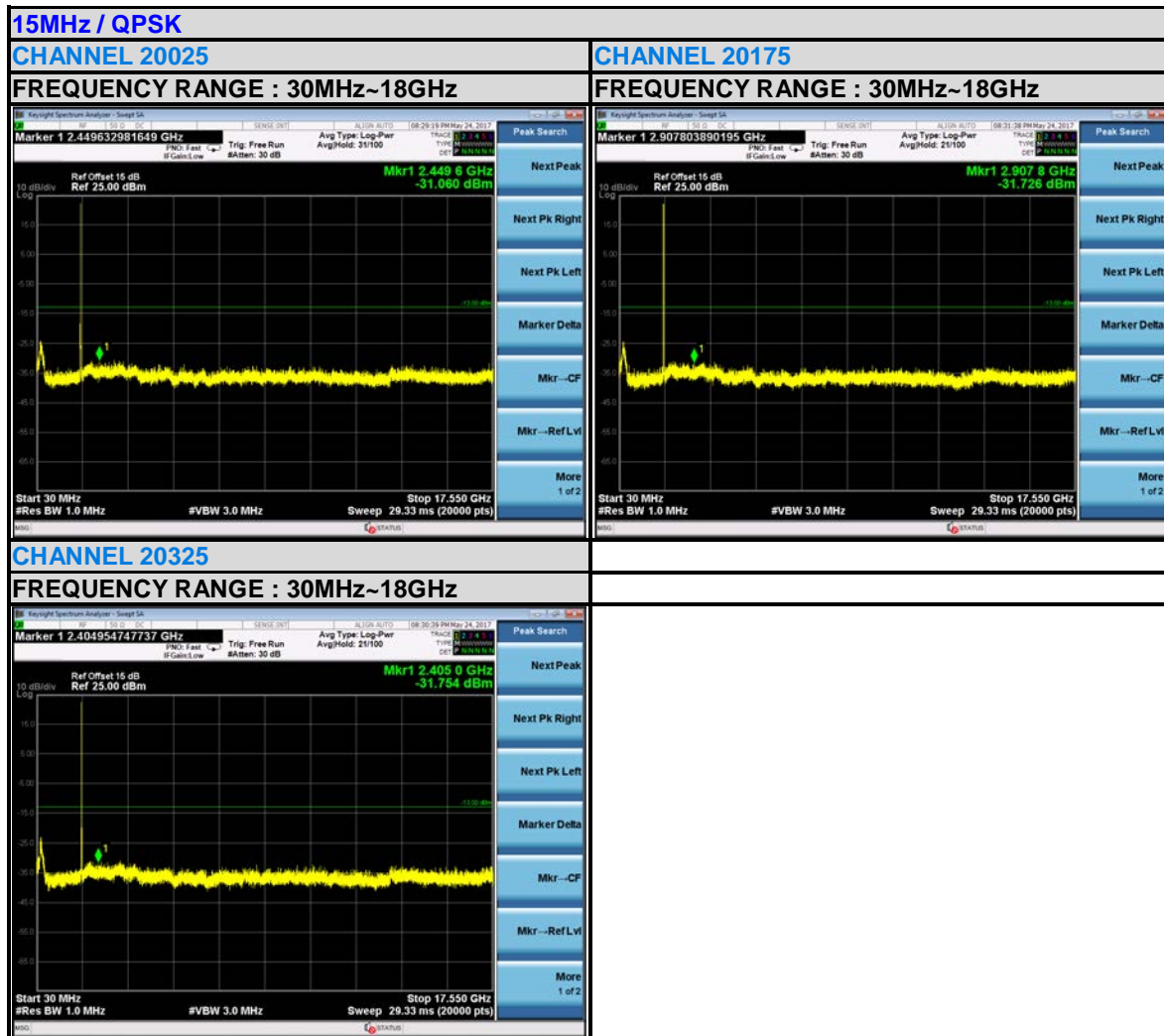



Test Report No.: RF180521W014-3

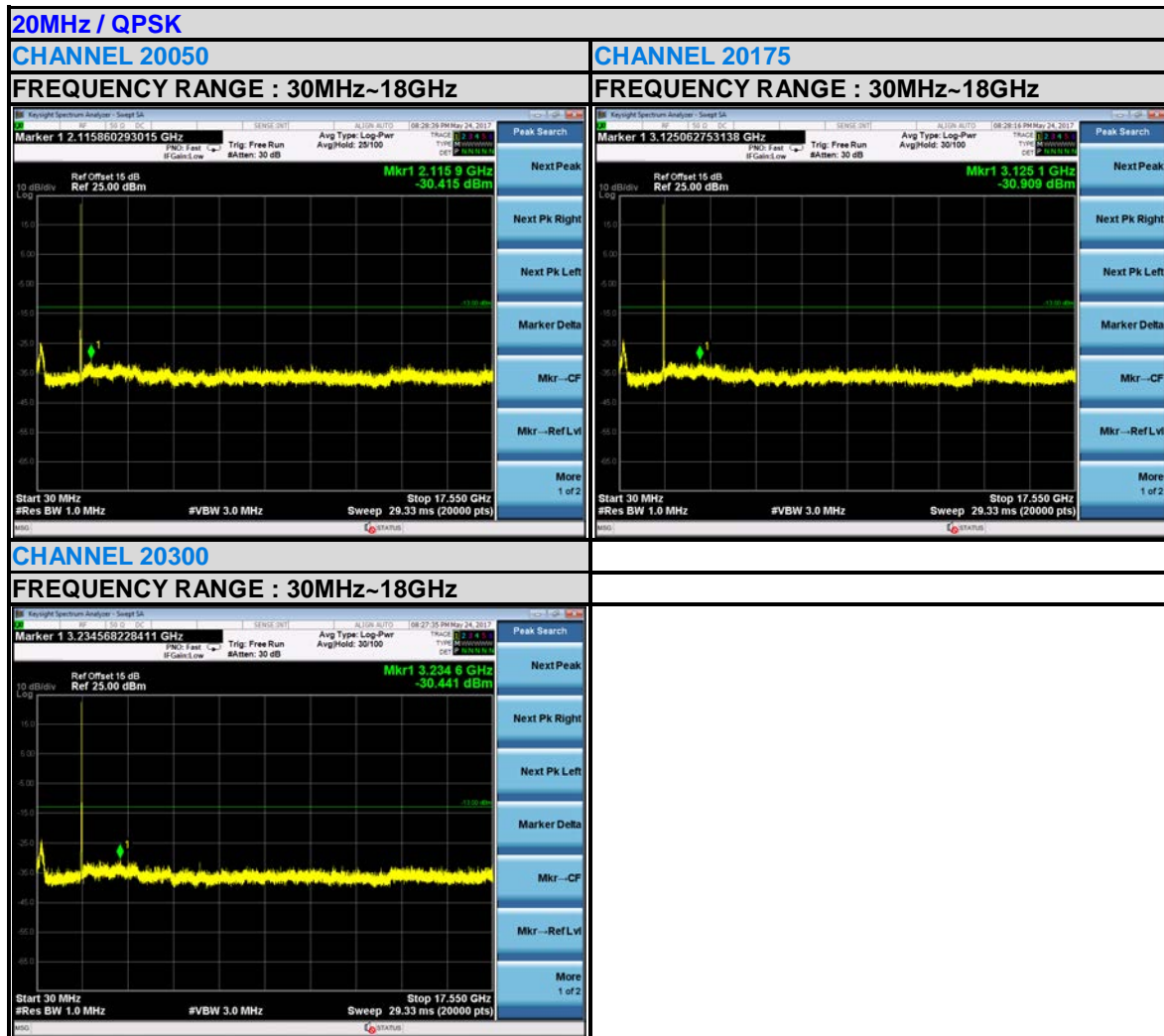



LTE BAND 12

1.4MHz / QPSK

CHANNEL 23017

FREQUENCY RANGE : 30MHz~8GHz

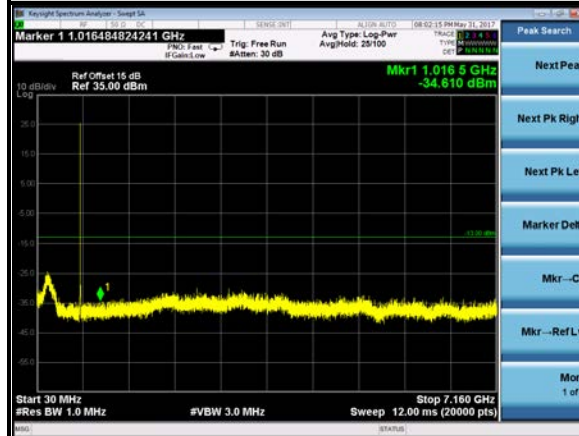

CHANNEL 23095

FREQUENCY RANGE : 30MHz~8GHz

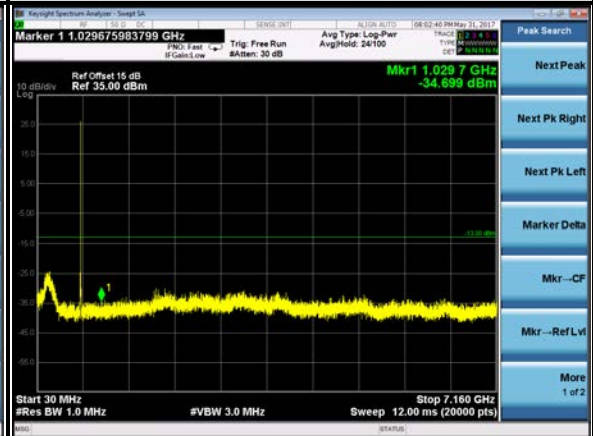

CHANNEL 23173

FREQUENCY RANGE : 30MHz~8GHz

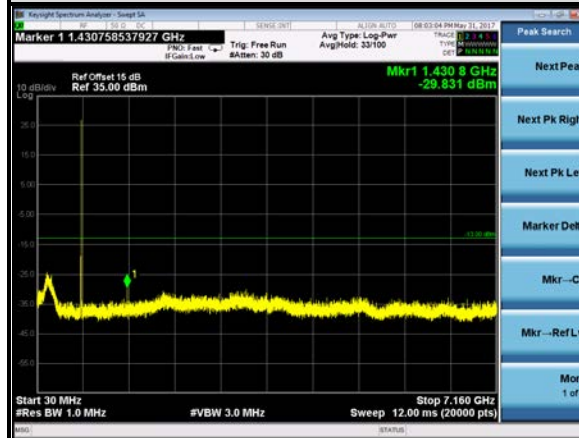



Test Report No.: RF180521W014-3

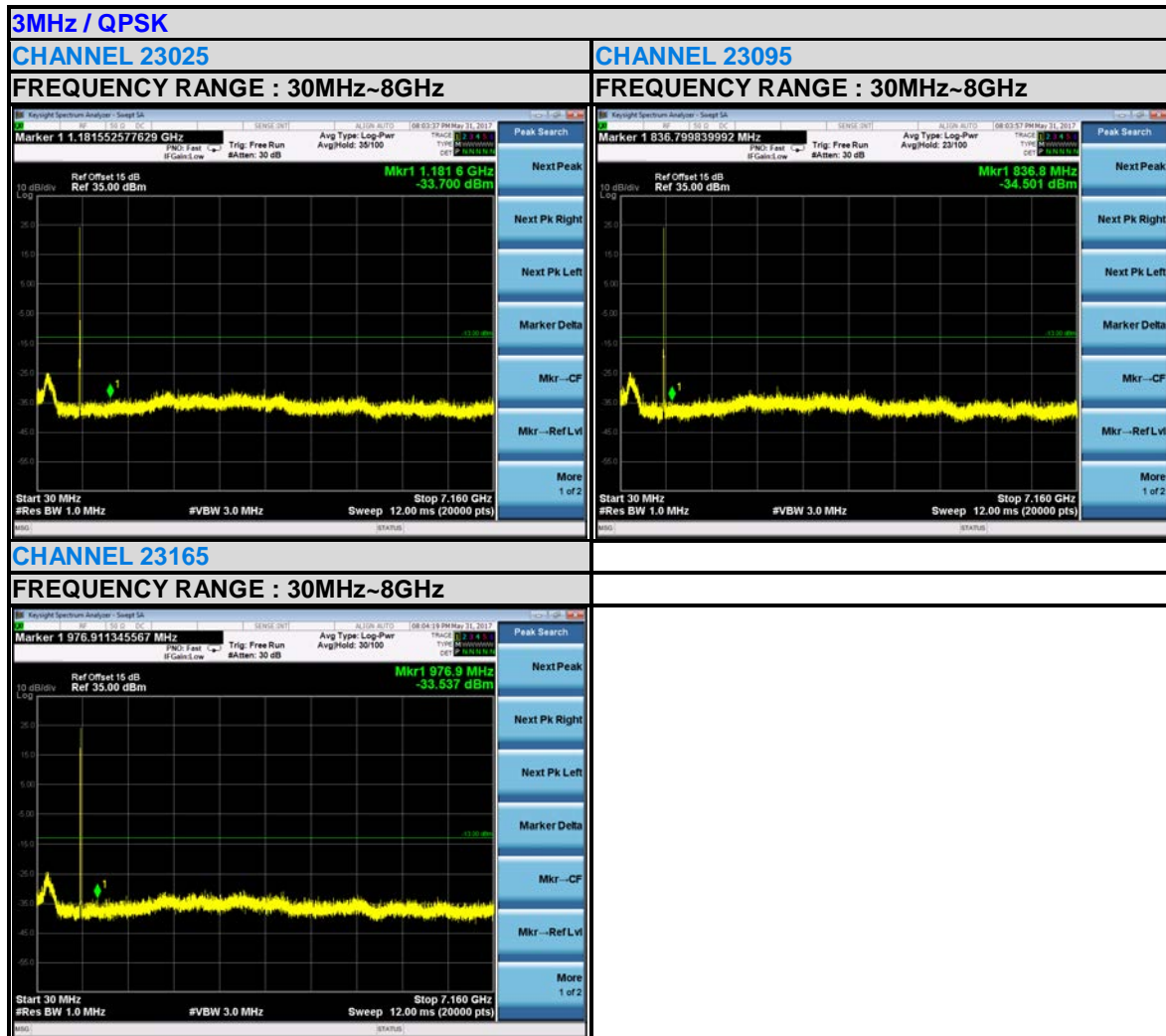



Test Report No.: RF180521W014-3

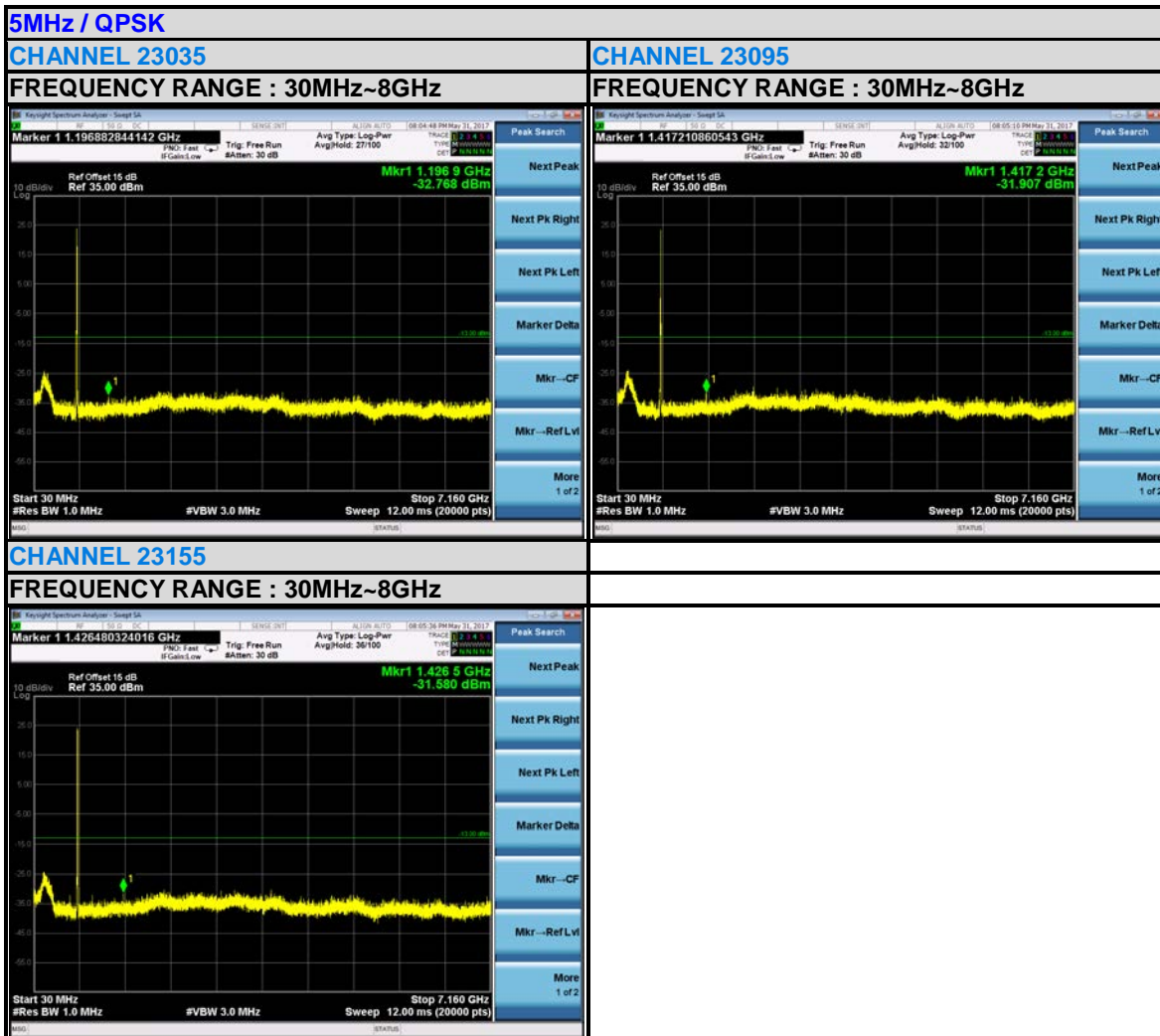



Test Report No.: RF180521W014-3





3.7 RADIATED EMISSION MEASUREMENT

3.7.1 LIMITS OF RADIATED EMISSION MEASUREMENT

The power of any emission outside a licensee's frequency block shall be attenuated below the transmitter power (P) by at least $43 + 10 \log_{10}(P)$ dB. The limit of emission equal to -13dBm

3.7.2 TEST PROCEDURES

- a. Substitution method is used for E.I.R.P measurement. In the semi-anechoic chamber, EUT placed on the 0.8m height of Turn Table, rotated the table around 360 degrees to search the maximum radiation power and receiver antenna shall be rotated vertical and horizontal polarization and moved height from 1m to 4m to find the maximum polar radiated power. The "Read Value" is the spectrum reading the maximum power value.
- b. The substitution horn antenna is substituted for EUT at the same position and signals generator export the CW signal to the substitution antenna via a TX cable. Rotated the Turn Table and moved receiving antenna to find the maximum radiation power. Adjust output power level of S.G to get a Value of spectrum reading equal to "Read Value" of step a. Record the power level of S.G
- c. $\text{EIRP} = \text{Output power level of S.G} - \text{TX cable loss} + \text{Antenna gain of substitution horn.}$
- d. E.R.P power can be calculated form E.I.R.P power by subtracting the gain of dipole, $\text{E.R.P power} = \text{E.I.P.R power} - 2.15\text{dBi.}$

NOTE: The resolution bandwidth of spectrum analyzer is 1 MHz and the video bandwidth is 3 MHz.

3.7.3 DEVIATION FROM TEST STANDARD

No deviation

3.7.4 TEST SETUP

<Below 30MHz>

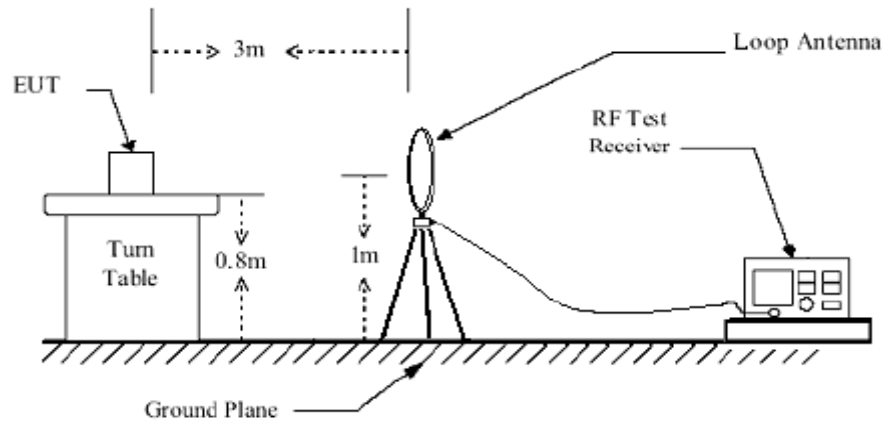

< Frequency Range 30MHz~1GHz >

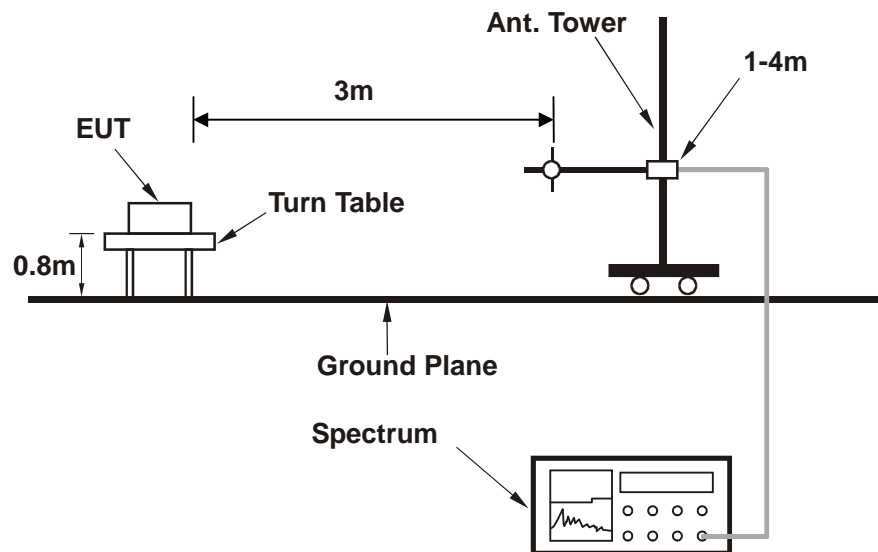

< Frequency Range above 1GHz >

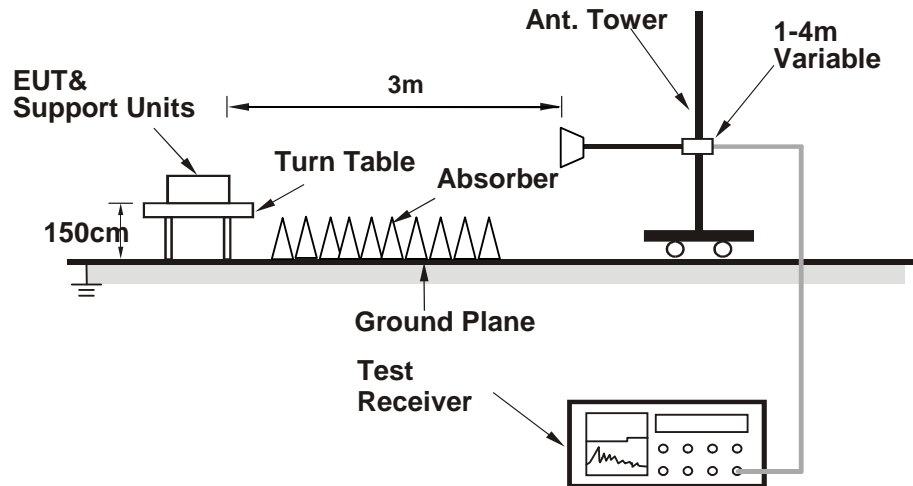

For the actual test configuration, please refer to the attached file (Test Setup Photo).



Test Report No.: RF180521W014-3

3.7.5 TEST RESULTS

BELOW 1GHz WORST-CASE DATA

9 KHz – 30 KHz data: the amplitude of spurious emissions attenuated more than 20 dB below the permissible value is not required in the report.

30 MHz – 1GHz data:

LTE Band 4:

| | | | |
|--|------------------|------------------------|---------------|
| MODE | TX channel 20175 | FREQUENCY RANGE | Below 1000MHz |
| ENVIRONMENTAL CONDITIONS | 23deg. C, 70%RH | INPUT POWER | DC 3.8V |
| TESTED BY | Star Le | | |
| ANTENNA POLARITY & TEST DISTANCE: HORIZONTAL AT 3 M | | | |

| | Freq | Level | Read Level | Limit Line | Over Limit | Factor | Remark | Pol/Phase |
|---|---------|--------|------------|------------|------------|--------|--------|------------|
| | MHz | dBm/m | dBm | dBm/m | dB | dB/m | | |
| 1 | 46.490 | -30.29 | -36.63 | -13.00 | -17.29 | 6.34 | Peak | Horizontal |
| 2 | 76.560 | -53.53 | -44.27 | -13.00 | -40.53 | -9.26 | Peak | Horizontal |
| 3 | 115.360 | -67.24 | -52.88 | -13.00 | -54.24 | -14.36 | Peak | Horizontal |
| 4 | 133.790 | -61.11 | -43.70 | -13.00 | -48.11 | -17.41 | Peak | Horizontal |
| 5 | 164.830 | -62.74 | -44.44 | -13.00 | -49.74 | -18.30 | Peak | Horizontal |
| 6 | 197.810 | -73.76 | -56.47 | -13.00 | -60.76 | -17.29 | Peak | Horizontal |

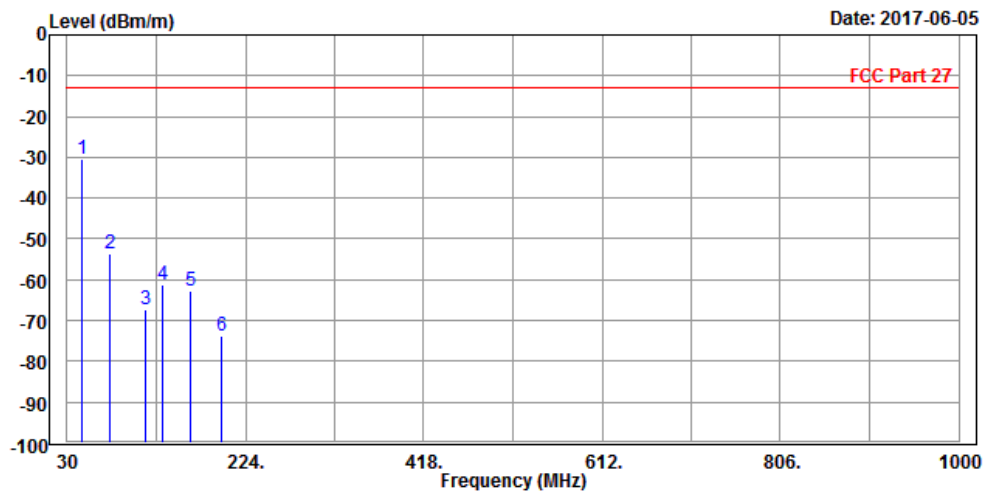



Test Report No.: RF180521W014-3

| | | | |
|--|------------------|------------------------|---------------|
| MODE | TX channel 20175 | FREQUENCY RANGE | Below 1000MHz |
| ENVIRONMENTAL CONDITIONS | 23deg. C, 70%RH | INPUT POWER | DC 3.8V |
| TESTED BY | Star Le | | |
| ANTENNA POLARITY & TEST DISTANCE: VERTICAL AT 3 M | | | |

| | Freq | Level | Read Level | Limit Line | Over Limit | Factor | Remark | Pol/Phase |
|---|------|---------|------------|------------|------------|--------|-------------|-----------|
| | MHz | dBm/m | dBm | dBm/m | dB | dB/m | | |
| 1 | PP | 42.610 | -43.35 | -41.08 | -13.00 | -30.35 | -2.27 Peak | Vertical |
| 2 | | 75.590 | -56.59 | -43.99 | -13.00 | -43.59 | -12.60 Peak | Vertical |
| 3 | | 131.850 | -53.58 | -41.56 | -13.00 | -40.58 | -12.02 Peak | Vertical |
| 4 | | 152.220 | -56.88 | -41.05 | -13.00 | -43.88 | -15.83 Peak | Vertical |
| 5 | | 198.780 | -69.43 | -58.64 | -13.00 | -56.43 | -10.79 Peak | Vertical |
| 6 | | 228.850 | -75.64 | -64.49 | -13.00 | -62.64 | -11.15 Peak | Vertical |

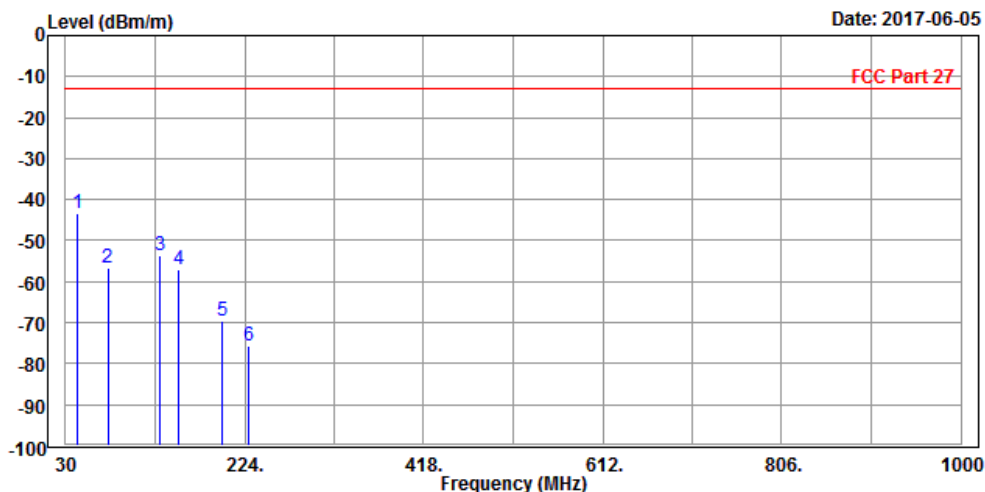



Test Report No.: RF180521W014-3

ABOVE 1GHz

Note: For higher frequency, the emission is too low to be detected.

LTE BAND 4

CHANNEL BANDWIDTH: 1.4MHz / QPSK

CH 19957

| | | | |
|--|------------------|------------------------|---------------|
| MODE | TX channel 19957 | FREQUENCY RANGE | Above 1000MHz |
| ENVIRONMENTAL CONDITIONS | 23deg. C, 60%RH | INPUT POWER | DC 3.8V |
| TESTED BY | Tony Zou | | |
| ANTENNA POLARITY & TEST DISTANCE: HORIZONTAL AT 3 M | | | |

| | Freq | Level | Read Level | Limit Line | Over Limit | Factor | Remark | Pol/Phase |
|---|-------------|--------|------------|------------|------------|--------|--------|------------|
| | MHz | dBm/m | dBm | dBm/m | dB | dB/m | | |
| 1 | 3421.000 | -52.41 | -54.27 | -13.00 | -39.41 | 1.86 | Peak | Horizontal |
| 2 | PP 5132.000 | -46.70 | -55.23 | -13.00 | -33.70 | 8.53 | Peak | Horizontal |

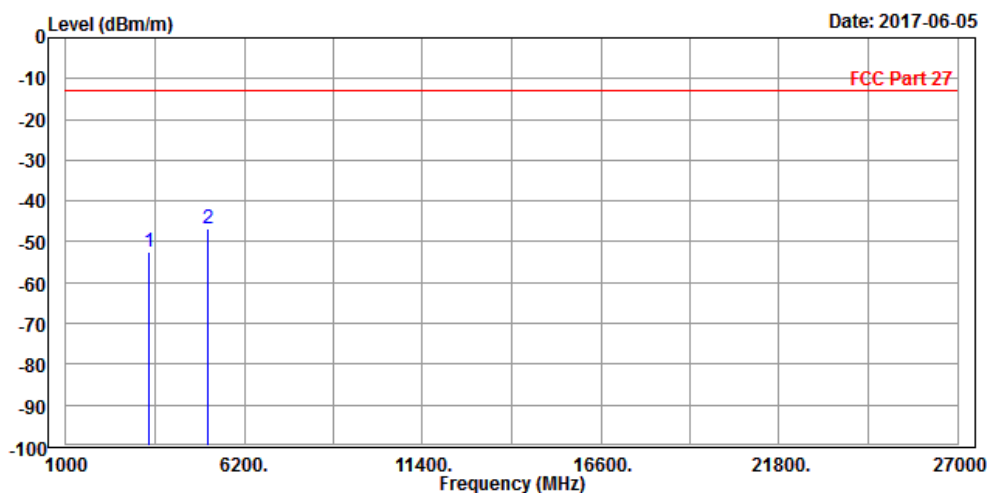



Test Report No.: RF180521W014-3

| | | | |
|--|------------------|------------------------|---------------|
| MODE | TX channel 19957 | FREQUENCY RANGE | Above 1000MHz |
| ENVIRONMENTAL CONDITIONS | 23deg. C, 60%RH | INPUT POWER | DC 3.8V |
| TESTED BY | Tony Zou | | |
| ANTENNA POLARITY & TEST DISTANCE: VERTICAL AT 3 M | | | |

| | Freq | Level | Read Level | Limit Line | Over Limit | Factor | Remark | Pol/Phase |
|---|-------------|--------|------------|------------|------------|--------|--------|-----------|
| | MHz | dBm/m | dBm | dBm/m | dB | dB/m | | |
| 1 | 3421.000 | -50.63 | -53.10 | -13.00 | -37.63 | 2.47 | Peak | Vertical |
| 2 | PP 5132.000 | -47.81 | -55.80 | -13.00 | -34.81 | 7.99 | Peak | Vertical |

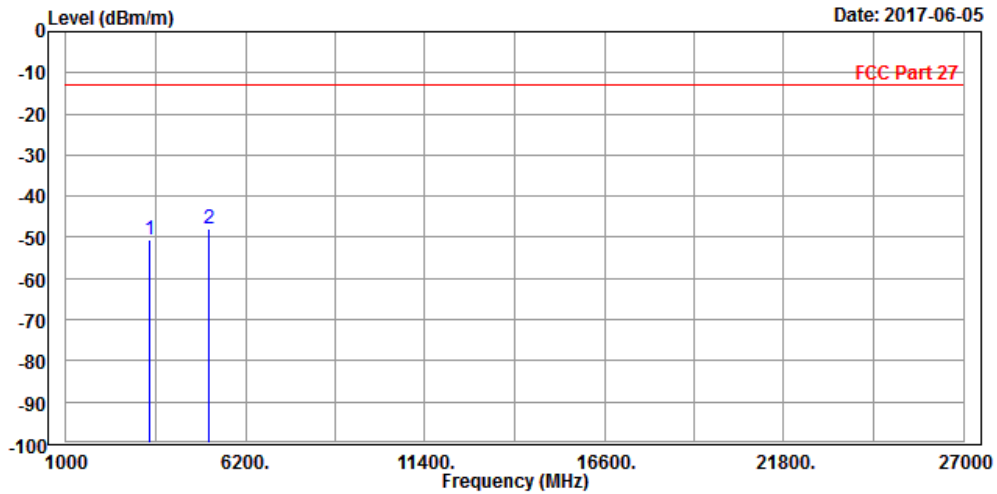



Test Report No.: RF180521W014-3

CH 20175

| | | | |
|--|------------------|-----------------|---------------|
| MODE | TX channel 20175 | FREQUENCY RANGE | Above 1000MHz |
| ENVIRONMENTAL CONDITIONS | 23deg. C, 70%RH | INPUT POWER | DC 3.8V |
| TESTED BY | Star Le | | |
| ANTENNA POLARITY & TEST DISTANCE: HORIZONTAL AT 3 M | | | |

| | Freq | Level | Read Level | Limit Line | Over Limit | Factor | Remark | Pol/Phase |
|---|-------------|--------|------------|------------|------------|--------|--------|------------|
| | MHz | dBm/m | dBm | dBm/m | dB | dB/m | | |
| 1 | PP 3470.000 | -26.33 | -28.38 | -13.00 | -13.33 | 2.05 | Peak | Horizontal |
| 2 | 5197.000 | -40.14 | -48.75 | -13.00 | -27.14 | 8.61 | Peak | Horizontal |

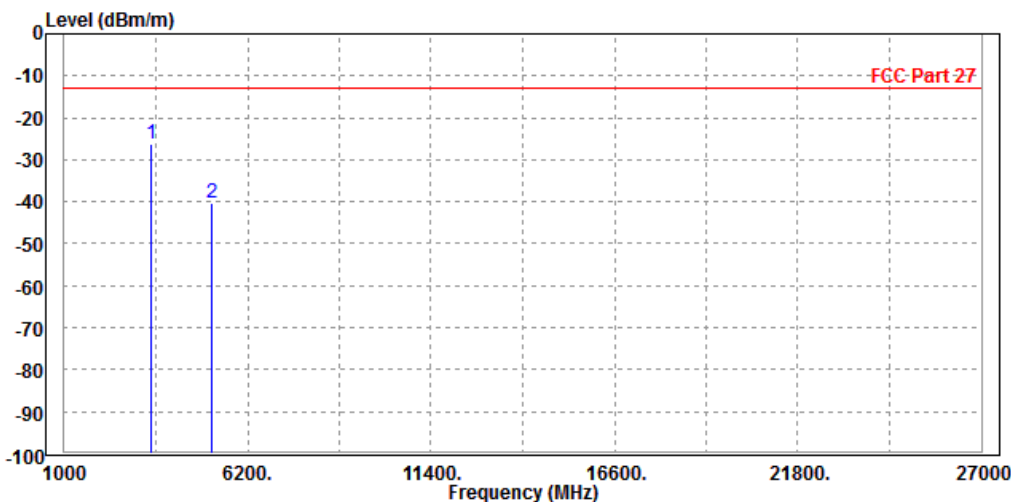



Test Report No.: RF180521W014-3

| | | | |
|--|------------------|------------------------|---------------|
| MODE | TX channel 20175 | FREQUENCY RANGE | Above 1000MHz |
| ENVIRONMENTAL CONDITIONS | 23deg. C, 70%RH | INPUT POWER | DC 3.8V |
| TESTED BY | Star Le | | |
| ANTENNA POLARITY & TEST DISTANCE: VERTICAL AT 3 M | | | |

| | Freq | Level | Read Level | Limit Line | Over Limit | Factor | Remark | Pol/Phase |
|---|-------------|--------|------------|------------|------------|--------|--------|-----------|
| | MHz | dBm/m | dBm | dBm/m | dB | dB/m | | |
| 1 | PP 3470.000 | -23.48 | -26.01 | -13.00 | -10.48 | 2.53 | Peak | Vertical |
| 2 | 5197.000 | -35.70 | -43.68 | -13.00 | -22.70 | 7.98 | Peak | Vertical |

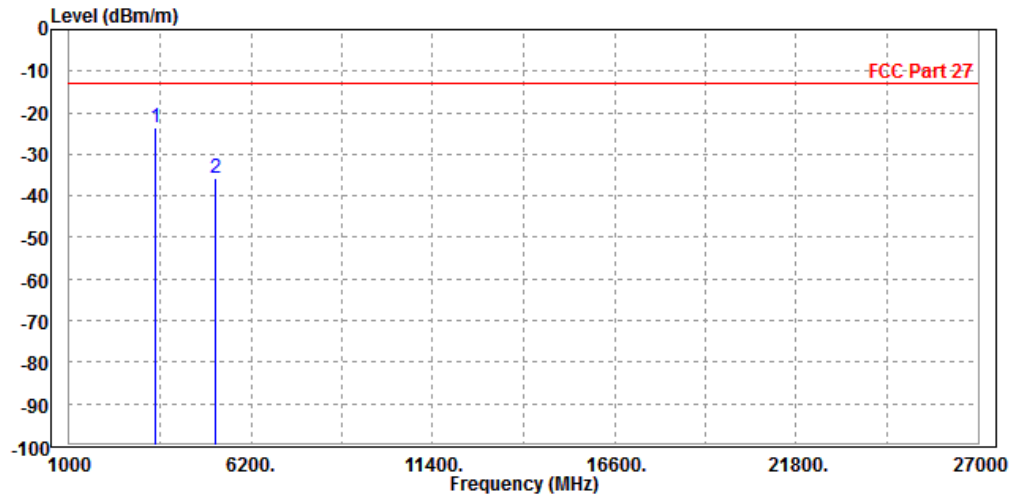



Test Report No.: RF180521W014-3

CH 20393

| | | | |
|--|------------------|------------------------|---------------|
| MODE | TX channel 20393 | FREQUENCY RANGE | Above 1000MHz |
| ENVIRONMENTAL CONDITIONS | 23deg. C, 60%RH | INPUT POWER | DC 3.8V |
| TESTED BY | Tony Zou | | |
| ANTENNA POLARITY & TEST DISTANCE: HORIZONTAL AT 3 M | | | |

| | Freq | Level | Read Level | Limit Line | Over Limit | Factor | Remark | Pol/Phase |
|---|-------------|--------|------------|------------|------------|--------|--------|------------|
| | MHz | dBm/m | dBm | dBm/m | dB | dB/m | | |
| 1 | 3509.000 | -50.31 | -52.52 | -13.00 | -37.31 | 2.21 | Peak | Horizontal |
| 2 | PP 5263.000 | -46.79 | -55.47 | -13.00 | -33.79 | 8.68 | Peak | Horizontal |

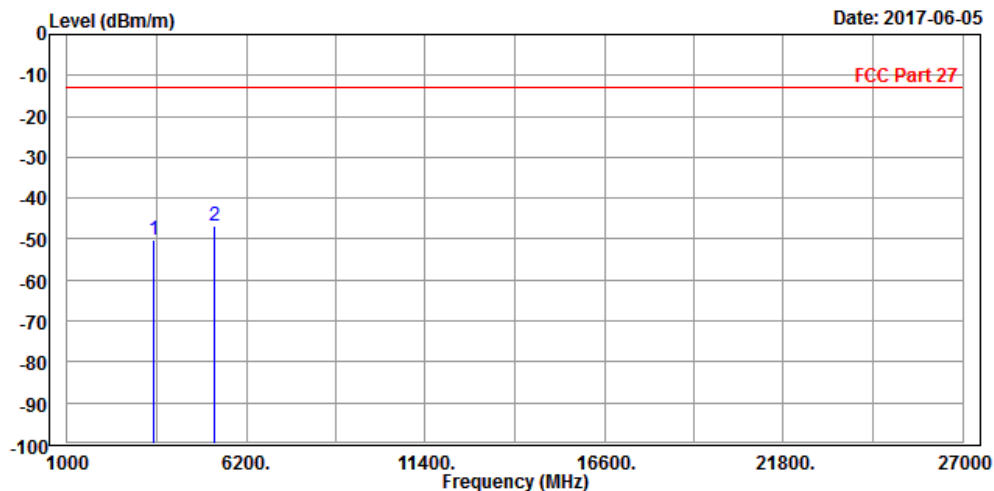



Test Report No.: RF180521W014-3

| | | | |
|--|------------------|------------------------|---------------|
| MODE | TX channel 20393 | FREQUENCY RANGE | Above 1000MHz |
| ENVIRONMENTAL CONDITIONS | 23deg. C, 60%RH | INPUT POWER | DC 3.8V |
| TESTED BY | Tony Zou | | |
| ANTENNA POLARITY & TEST DISTANCE: VERTICAL AT 3 M | | | |

| | Freq | Level | Read Level | Limit Line | Over Limit | Factor | Remark | Pol/Phase |
|---|-------------|--------|------------|------------|------------|--------|--------|-----------|
| | MHz | dBm/m | dBm | dBm/m | dB | dB/m | | |
| 1 | PP 3509.000 | -45.96 | -48.58 | -13.00 | -32.96 | 2.62 | Peak | Vertical |
| 2 | 5263.000 | -47.32 | -55.30 | -13.00 | -34.32 | 7.98 | Peak | Vertical |

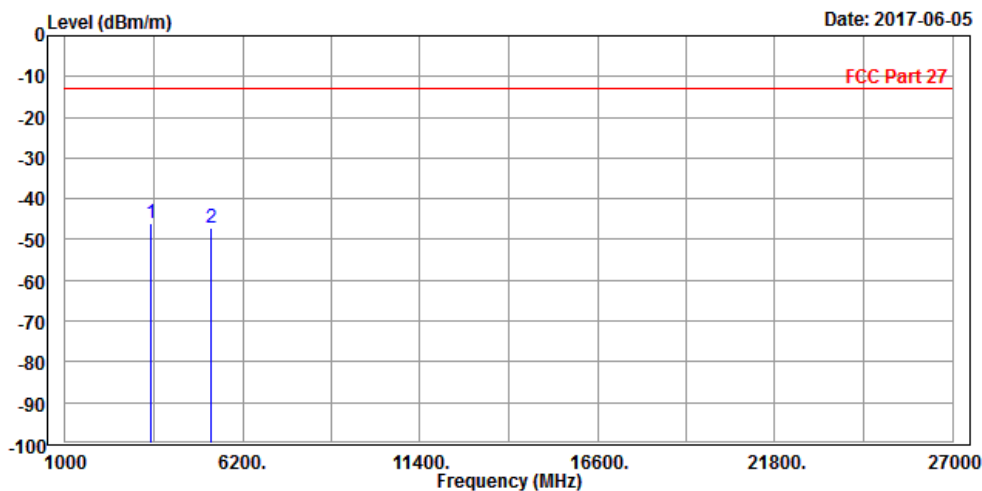



Test Report No.: RF180521W014-3

CHANNEL BANDWIDTH: 3MHz / QPSK

| | | | |
|--|------------------|------------------------|---------------|
| MODE | TX channel 20175 | FREQUENCY RANGE | Above 1000MHz |
| ENVIRONMENTAL CONDITIONS | 23deg. C, 70%RH | INPUT POWER | DC 3.8V |
| TESTED BY | Star Le | | |
| ANTENNA POLARITY & TEST DISTANCE: HORIZONTAL AT 3 M | | | |

| | Freq | Level | Read Level | Limit | Over Limit | Factor | Remark | Pol/Phase |
|---|-------------|--------|------------|--------|------------|--------|--------|------------|
| | MHz | dBm/m | dBm | dBm/m | dB | dB/m | | |
| 1 | 3470.000 | -50.29 | -52.34 | -13.00 | -37.29 | 2.05 | Peak | Horizontal |
| 2 | PP 5197.000 | -46.61 | -55.22 | -13.00 | -33.61 | 8.61 | Peak | Horizontal |

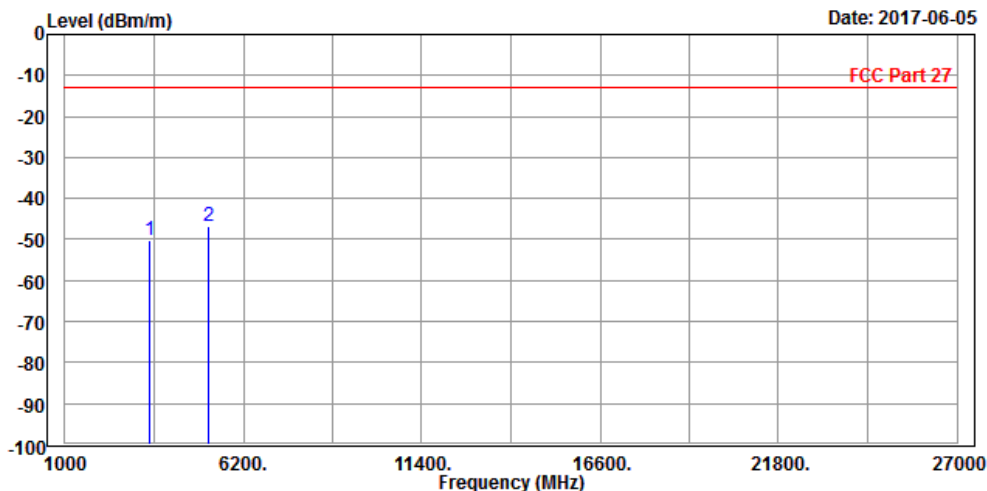



Test Report No.: RF180521W014-3

| | | | |
|--|------------------|------------------------|---------------|
| MODE | TX channel 20175 | FREQUENCY RANGE | Above 1000MHz |
| ENVIRONMENTAL CONDITIONS | 23deg. C, 70%RH | INPUT POWER | DC 3.8V |
| TESTED BY | Star Le | | |
| ANTENNA POLARITY & TEST DISTANCE: VERTICAL AT 3 M | | | |

| | Freq | Level | Read Level | Limit Line | Over Limit | Factor | Remark | Pol/Phase |
|---|-------------|--------|------------|------------|------------|--------|--------|-----------|
| | MHz | dBm/m | dBm | dBm/m | dB | dB/m | | |
| 1 | PP 3470.000 | -45.76 | -48.29 | -13.00 | -32.76 | 2.53 | Peak | Vertical |
| 2 | 5197.000 | -47.55 | -55.53 | -13.00 | -34.55 | 7.98 | Peak | Vertical |

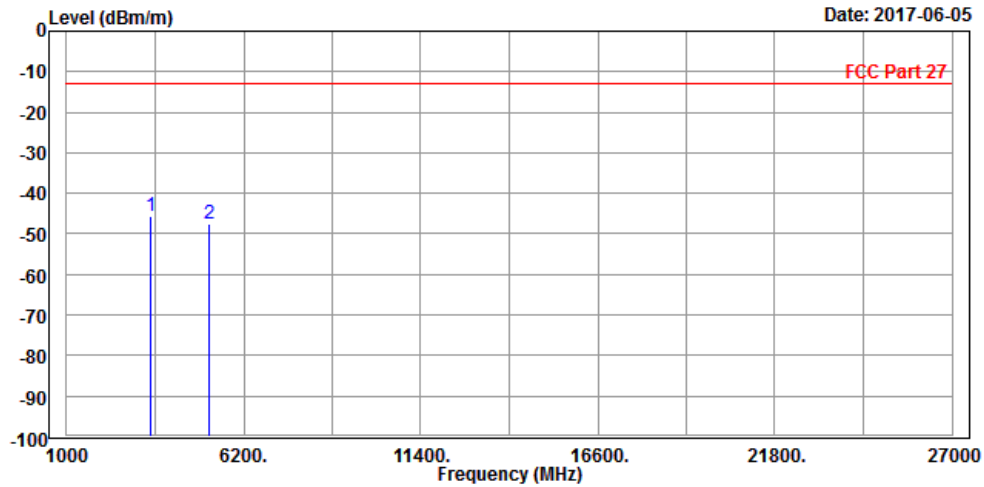



Test Report No.: RF180521W014-3

CHANNEL BANDWIDTH: 5MHz / QPSK

| | | | |
|--|------------------|------------------------|---------------|
| MODE | TX channel 20175 | FREQUENCY RANGE | Above 1000MHz |
| ENVIRONMENTAL CONDITIONS | 23deg. C, 70%RH | INPUT POWER | DC 3.8V |
| TESTED BY | Star Le | | |
| ANTENNA POLARITY & TEST DISTANCE: HORIZONTAL AT 3 M | | | |

| | Freq | Level | Read Level | Limit Line | Over Limit | Factor | Remark | Pol/Phase |
|------|----------|--------|------------|------------|------------|--------|--------|------------|
| | MHz | dBm/m | dBm | dBm/m | dB | dB/m | | |
| 1 | 3470.000 | -52.38 | -54.43 | -13.00 | -39.38 | 2.05 | Peak | Horizontal |
| 2 PP | 5197.000 | -47.35 | -55.96 | -13.00 | -34.35 | 8.61 | Peak | Horizontal |

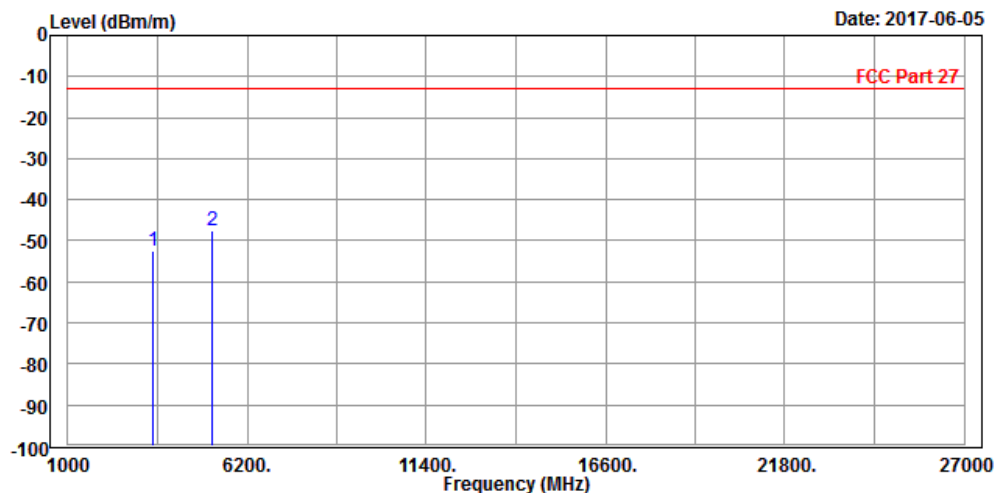



Test Report No.: RF180521W014-3

| | | | |
|--|------------------|------------------------|---------------|
| MODE | TX channel 20175 | FREQUENCY RANGE | Above 1000MHz |
| ENVIRONMENTAL CONDITIONS | 23deg. C, 70%RH | INPUT POWER | DC 3.8V |
| TESTED BY | Star Le | | |
| ANTENNA POLARITY & TEST DISTANCE: VERTICAL AT 3 M | | | |

| | Freq | Level | Read Level | Limit Line | Over Limit | Factor | Remark | Pol/Phase |
|------|----------|--------|------------|------------|------------|--------|--------|-----------|
| | MHz | dBm/m | dBm | dBm/m | dB | dB/m | | |
| 1 | 3470.000 | -50.04 | -52.57 | -13.00 | -37.04 | 2.53 | Peak | Vertical |
| 2 PP | 5197.000 | -47.72 | -55.70 | -13.00 | -34.72 | 7.98 | Peak | Vertical |

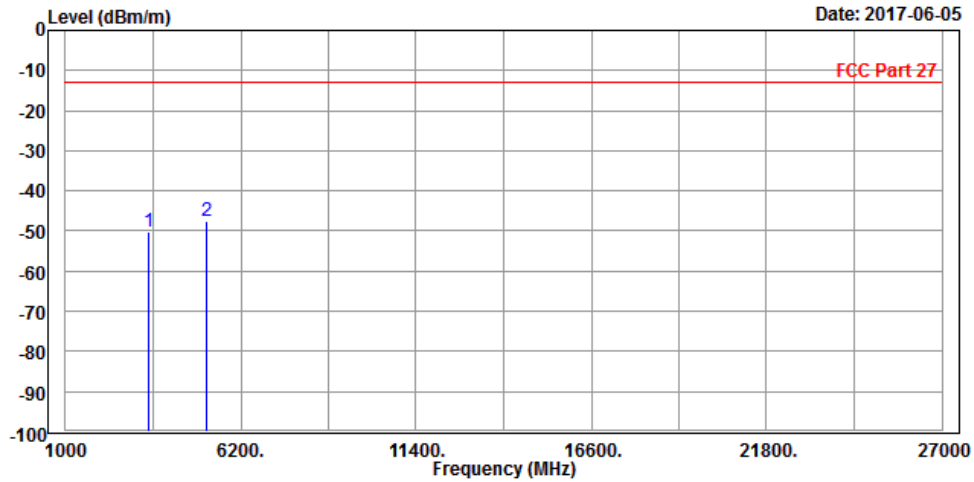



Test Report No.: RF180521W014-3

CHANNEL BANDWIDTH: 10MHz / QPSK

| | | | |
|--|------------------|------------------------|---------------|
| MODE | TX channel 20175 | FREQUENCY RANGE | Above 1000MHz |
| ENVIRONMENTAL CONDITIONS | 23deg. C, 70%RH | INPUT POWER | DC 3.8V |
| TESTED BY | Star Le | | |
| ANTENNA POLARITY & TEST DISTANCE: HORIZONTAL AT 3 M | | | |

| | Freq | Level | Read Level | Limit Line | Over Limit | Factor | Remark | Pol/Phase |
|------|----------|--------|------------|------------|------------|--------|--------|------------|
| | MHz | dBm/m | dBm | dBm/m | dB | dB/m | | |
| 1 | 3470.000 | -52.77 | -54.82 | -13.00 | -39.77 | 2.05 | Peak | Horizontal |
| 2 PP | 5197.000 | -44.52 | -53.13 | -13.00 | -31.52 | 8.61 | Peak | Horizontal |

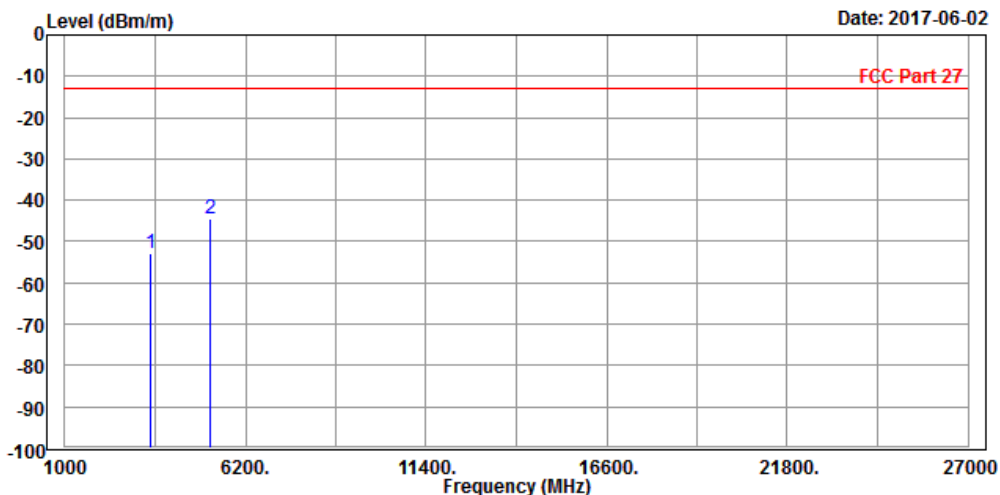



Test Report No.: RF180521W014-3

| | | | |
|--|------------------|------------------------|---------------|
| MODE | TX channel 20175 | FREQUENCY RANGE | Above 1000MHz |
| ENVIRONMENTAL CONDITIONS | 23deg. C, 70%RH | INPUT POWER | DC 3.8V |
| TESTED BY | Star Le | | |
| ANTENNA POLARITY & TEST DISTANCE: VERTICAL AT 3 M | | | |

| | Freq | Level | Read Level | Limit Line | Over Limit | Factor | Remark | Pol/Phase |
|------|----------|--------|------------|------------|------------|--------|--------|-----------|
| | MHz | dBm/m | dBm | dBm/m | dB | dB/m | | |
| 1 | 3470.000 | -51.52 | -54.05 | -13.00 | -38.52 | 2.53 | Peak | Vertical |
| 2 PP | 5197.000 | -45.58 | -53.56 | -13.00 | -32.58 | 7.98 | Peak | Vertical |

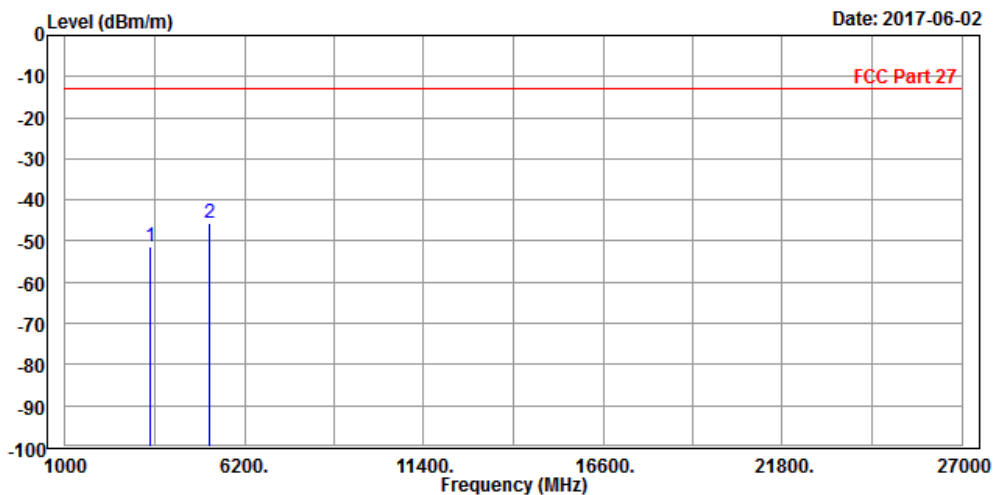



Test Report No.: RF180521W014-3

CHANNEL BANDWIDTH: 15MHz / QPSK

| | | | |
|--|------------------|------------------------|---------------|
| MODE | TX channel 20175 | FREQUENCY RANGE | Above 1000MHz |
| ENVIRONMENTAL CONDITIONS | 23deg. C, 70%RH | INPUT POWER | DC 3.8V |
| TESTED BY | Star Le | | |
| ANTENNA POLARITY & TEST DISTANCE: HORIZONTAL AT 3 M | | | |

| | Freq | Level | Read Level | Limit Line | Over Limit | Factor | Remark | Pol/Phase |
|---|-------------|--------|------------|------------|------------|--------|--------|------------|
| | MHz | dBm/m | dBm | dBm/m | dB | dB/m | | |
| 1 | 3470.000 | -52.88 | -54.93 | -13.00 | -39.88 | 2.05 | Peak | Horizontal |
| 2 | PP 5197.000 | -47.56 | -56.17 | -13.00 | -34.56 | 8.61 | Peak | Horizontal |

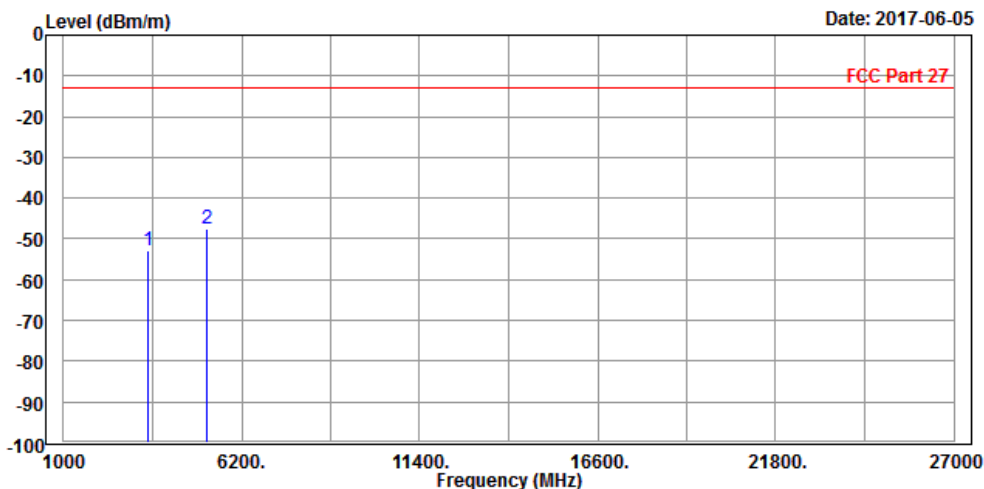



Test Report No.: RF180521W014-3

| | | | |
|--|------------------|------------------------|---------------|
| MODE | TX channel 20175 | FREQUENCY RANGE | Above 1000MHz |
| ENVIRONMENTAL CONDITIONS | 23deg. C, 70%RH | INPUT POWER | DC 3.8V |
| TESTED BY | Star Le | | |
| ANTENNA POLARITY & TEST DISTANCE: VERTICAL AT 3 M | | | |

| | Freq | Level | Read Level | Limit Line | Over Limit | Factor | Remark | Pol/Phase |
|------|----------|--------|------------|------------|------------|--------|--------|-----------|
| | MHz | dBm/m | dBm | dBm/m | dB | dB/m | | |
| 1 | 3470.000 | -52.63 | -55.16 | -13.00 | -39.63 | 2.53 | Peak | Vertical |
| 2 PP | 5197.000 | -48.38 | -56.36 | -13.00 | -35.38 | 7.98 | Peak | Vertical |

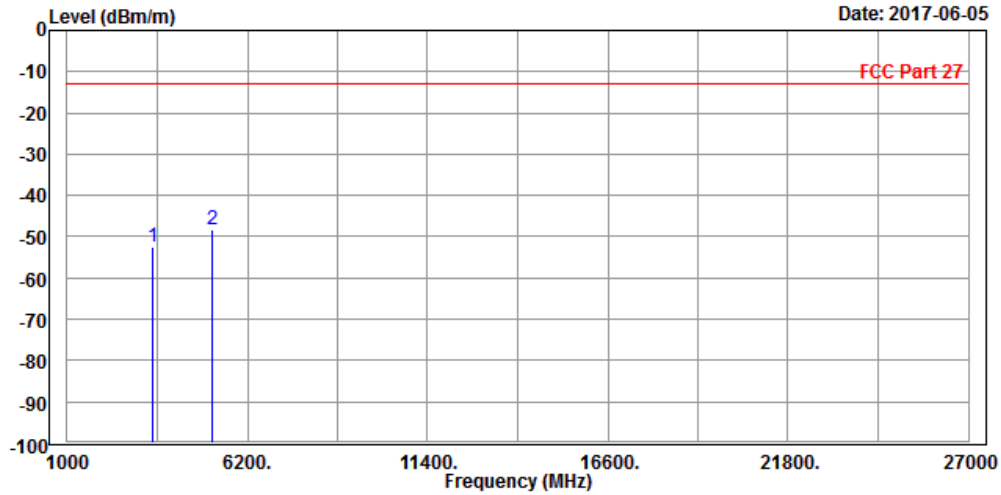



Test Report No.: RF180521W014-3

CHANNEL BANDWIDTH: 20MHz / QPSK

| | | | |
|--|------------------|------------------------|---------------|
| MODE | TX channel 20175 | FREQUENCY RANGE | Above 1000MHz |
| ENVIRONMENTAL CONDITIONS | 23deg. C, 70%RH | INPUT POWER | DC 3.8V |
| TESTED BY | Star Le | | |
| ANTENNA POLARITY & TEST DISTANCE: HORIZONTAL AT 3 M | | | |

| | Freq | Level | Read Level | Limit Line | Over Limit | Factor | Remark | Pol/Phase |
|------|----------|--------|------------|------------|------------|--------|--------|------------|
| | MHz | dBm/m | dBm | dBm/m | dB | dB/m | | |
| 1 | 3470.000 | -53.77 | -55.82 | -13.00 | -40.77 | 2.05 | Peak | Horizontal |
| 2 PP | 5197.000 | -47.54 | -56.15 | -13.00 | -34.54 | 8.61 | Peak | Horizontal |

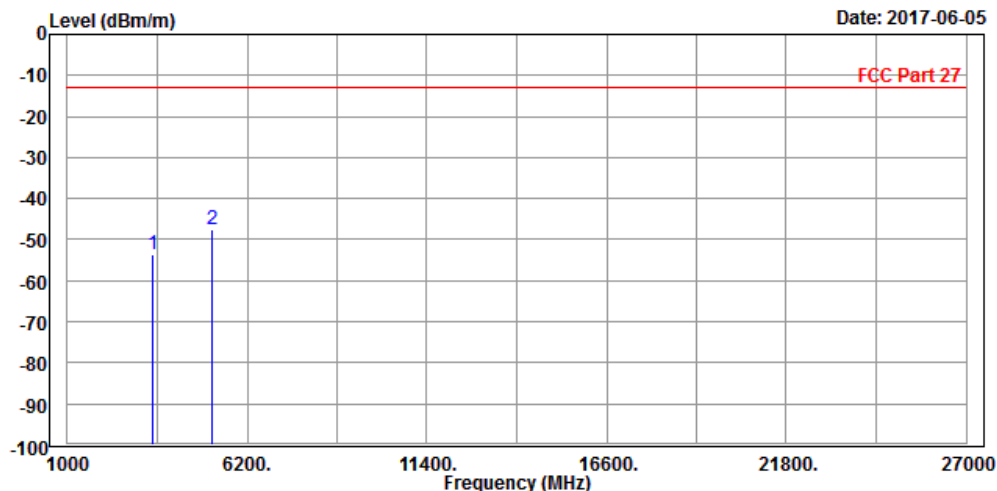



Test Report No.: RF180521W014-3

| | | | |
|--|------------------|------------------------|---------------|
| MODE | TX channel 20175 | FREQUENCY RANGE | Above 1000MHz |
| ENVIRONMENTAL CONDITIONS | 23deg. C, 70%RH | INPUT POWER | DC 3.8V |
| TESTED BY | Star Le | | |
| ANTENNA POLARITY & TEST DISTANCE: VERTICAL AT 3 M | | | |

| | Freq | Level | Read Level | Limit Line | Over Limit | Factor | Remark | Pol/Phase |
|---|-------------|--------|------------|------------|------------|--------|--------|-----------|
| | MHz | dBm/m | dBm | dBm/m | dB | dB/m | | |
| 1 | 3470.000 | -52.70 | -55.23 | -13.00 | -39.70 | 2.53 | Peak | Vertical |
| 2 | PP 5197.000 | -48.61 | -56.59 | -13.00 | -35.61 | 7.98 | Peak | Vertical |

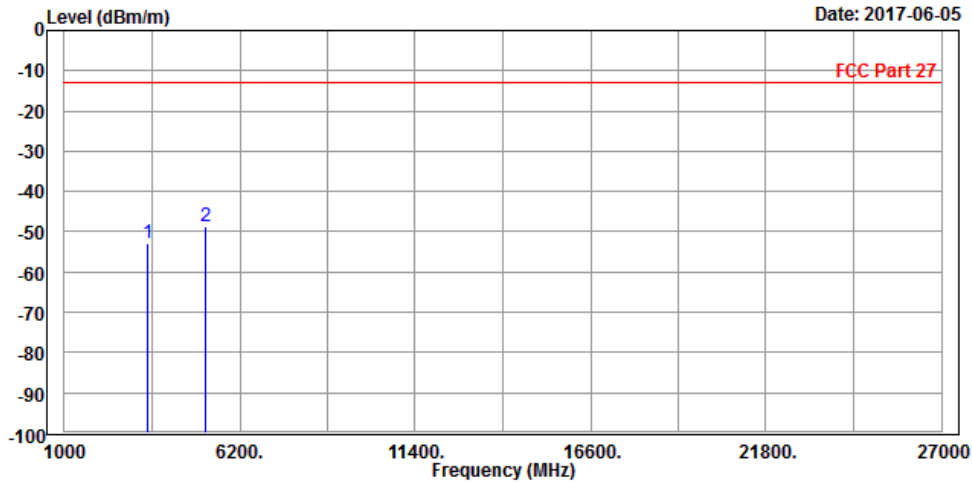



Test Report No.: RF180521W014-3

LTE BAND 12

CHANNEL BANDWIDTH: 1.4MHz / QPSK

| | | | |
|--|------------------|------------------------|---------------|
| MODE | TX channel 23095 | FREQUENCY RANGE | Above 1000MHz |
| ENVIRONMENTAL CONDITIONS | 23deg. C, 70%RH | INPUT POWER | DC 3.8V |
| TESTED BY | Star Le | | |
| ANTENNA POLARITY & TEST DISTANCE: HORIZONTAL AT 3 M | | | |

| | Freq | Level | Read Level | Limit Line | Over Limit | Factor | Remark | Pol/Phase |
|------|----------|--------|------------|------------|------------|--------|--------|------------|
| | MHz | dBm/m | dBm | dBm/m | dB | dB/m | | |
| 1 | 1414.000 | -59.78 | -53.05 | -13.00 | -46.78 | -6.73 | Peak | Horizontal |
| 2 PP | 2122.000 | -56.06 | -54.12 | -13.00 | -43.06 | -1.94 | Peak | Horizontal |

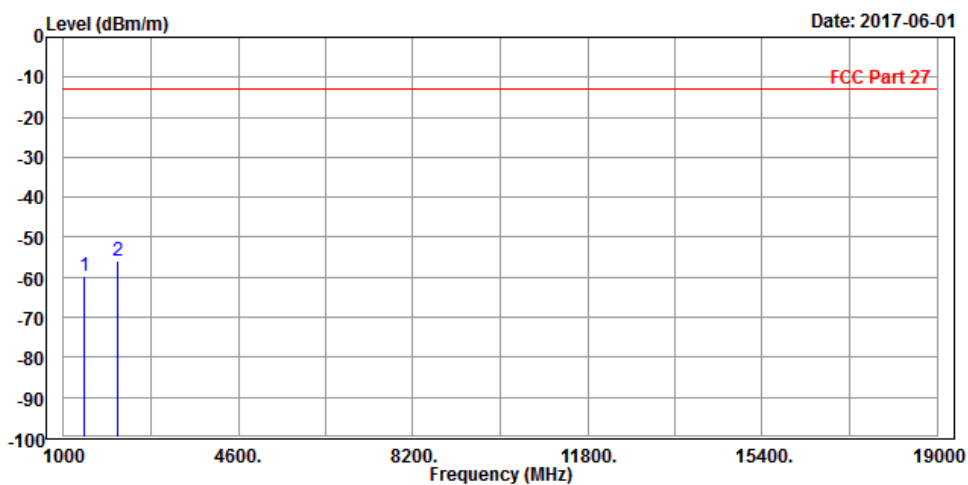



Test Report No.: RF180521W014-3

| | | | |
|--|------------------|------------------------|---------------|
| MODE | TX channel 23095 | FREQUENCY RANGE | Above 1000MHz |
| ENVIRONMENTAL CONDITIONS | 23deg. C, 70%RH | INPUT POWER | DC 3.8V |
| TESTED BY | Star Le | | |
| ANTENNA POLARITY & TEST DISTANCE: VERTICAL AT 3 M | | | |

| | Freq | Level | Read Level | Limit Line | Over Limit | Factor | Remark | Pol/Phase |
|---|-------------|--------|------------|------------|------------|--------|--------|-----------|
| | MHz | dBm/m | dBm | dBm/m | dB | dB/m | | |
| 1 | PP 1414.000 | -50.49 | -45.04 | -13.00 | -37.49 | -5.45 | Peak | Vertical |
| 2 | 2122.000 | -54.86 | -54.62 | -13.00 | -41.86 | -0.24 | Peak | Vertical |

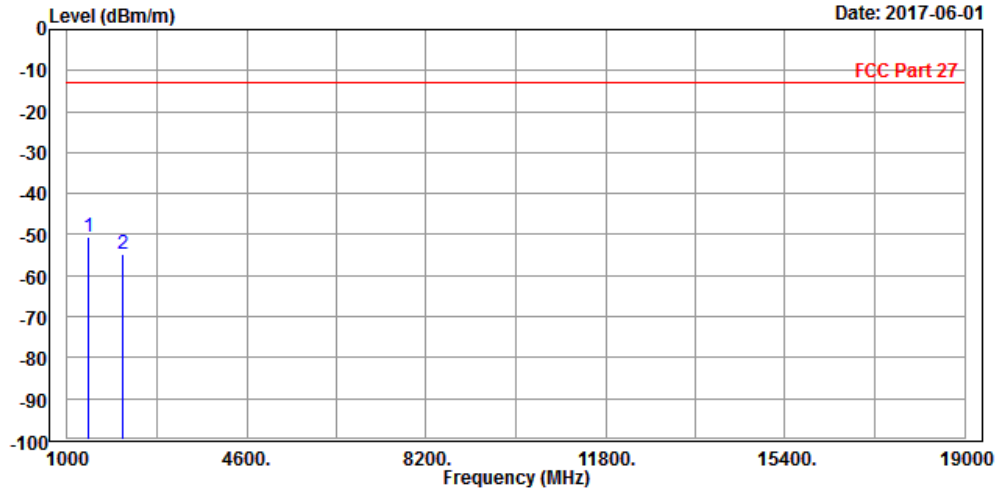



Test Report No.: RF180521W014-3

CHANNEL BANDWIDTH: 3MHz / QPSK

| | | | |
|--|------------------|------------------------|---------------|
| MODE | TX channel 23095 | FREQUENCY RANGE | Above 1000MHz |
| ENVIRONMENTAL CONDITIONS | 23deg. C, 70%RH | INPUT POWER | DC 3.8V |
| TESTED BY | Star Le | | |
| ANTENNA POLARITY & TEST DISTANCE: HORIZONTAL AT 3 M | | | |

| | Freq | Level | Read Level | Limit Line | Over Limit | Factor | Remark | Pol/Phase |
|---|-------------|--------|------------|------------|------------|--------|--------|------------|
| | MHz | dBm/m | dBm | dBm/m | dB | dB/m | | |
| 1 | PP 1414.000 | -53.90 | -47.17 | -13.00 | -40.90 | -6.73 | Peak | Horizontal |
| 2 | 2122.000 | -56.34 | -54.40 | -13.00 | -43.34 | -1.94 | Peak | Horizontal |

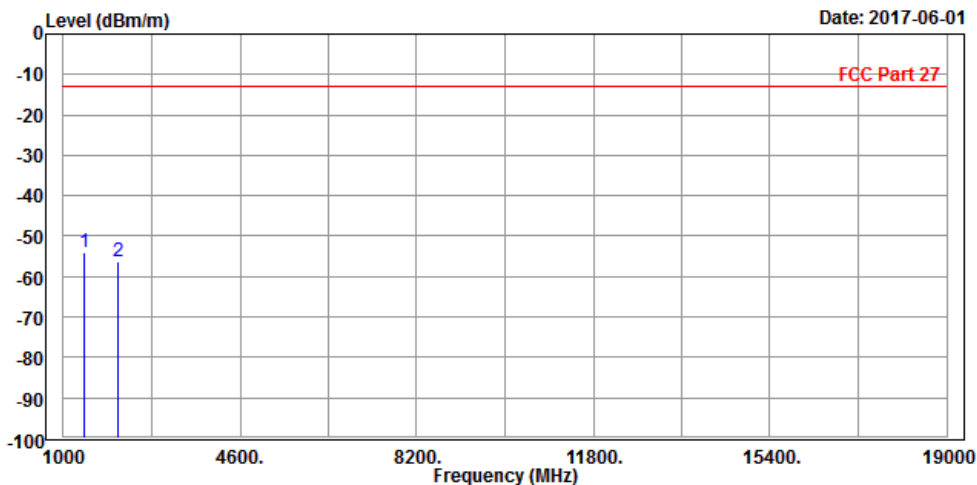



Test Report No.: RF180521W014-3

| | | | |
|--|------------------|------------------------|---------------|
| MODE | TX channel 23095 | FREQUENCY RANGE | Above 1000MHz |
| ENVIRONMENTAL CONDITIONS | 23deg. C, 70%RH | INPUT POWER | DC 3.8V |
| TESTED BY | Star Le | | |
| ANTENNA POLARITY & TEST DISTANCE: VERTICAL AT 3 M | | | |

| | Freq | Level | Read Level | Limit Line | Over Limit | Factor | Remark | Pol/Phase |
|---|-------------|--------|------------|------------|------------|--------|--------|-----------|
| | MHz | dBm/m | dBm | dBm/m | dB | dB/m | | |
| 1 | PP 1414.000 | -51.39 | -45.94 | -13.00 | -38.39 | -5.45 | Peak | Vertical |
| 2 | 2122.000 | -52.52 | -52.28 | -13.00 | -39.52 | -0.24 | Peak | Vertical |

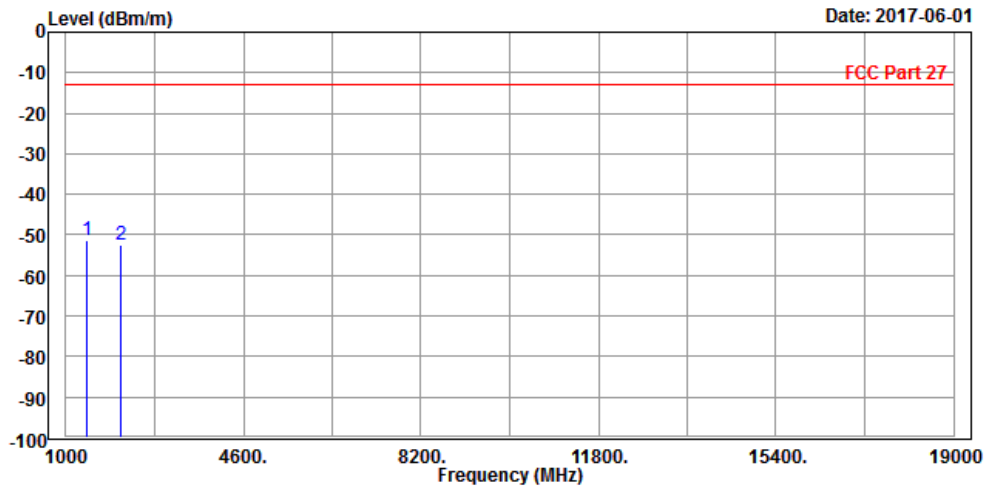



Test Report No.: RF180521W014-3

CHANNEL BANDWIDTH: 5MHz / QPSK

| | | | |
|--|------------------|------------------------|---------------|
| MODE | TX channel 23095 | FREQUENCY RANGE | Above 1000MHz |
| ENVIRONMENTAL CONDITIONS | 23deg. C, 70%RH | INPUT POWER | DC 3.8V |
| TESTED BY | Star Le | | |
| ANTENNA POLARITY & TEST DISTANCE: HORIZONTAL AT 3 M | | | |

| | Freq | Level | Read Level | Limit Line | Over Limit | Factor | Remark | Pol/Phase |
|---|-------------|--------|------------|------------|------------|--------|--------|------------|
| | MHz | dBm/m | dBm | dBm/m | dB | dB/m | | |
| 1 | PP 1414.000 | -52.33 | -45.60 | -13.00 | -39.33 | -6.73 | Peak | Horizontal |
| 2 | 2122.000 | -55.42 | -53.48 | -13.00 | -42.42 | -1.94 | Peak | Horizontal |

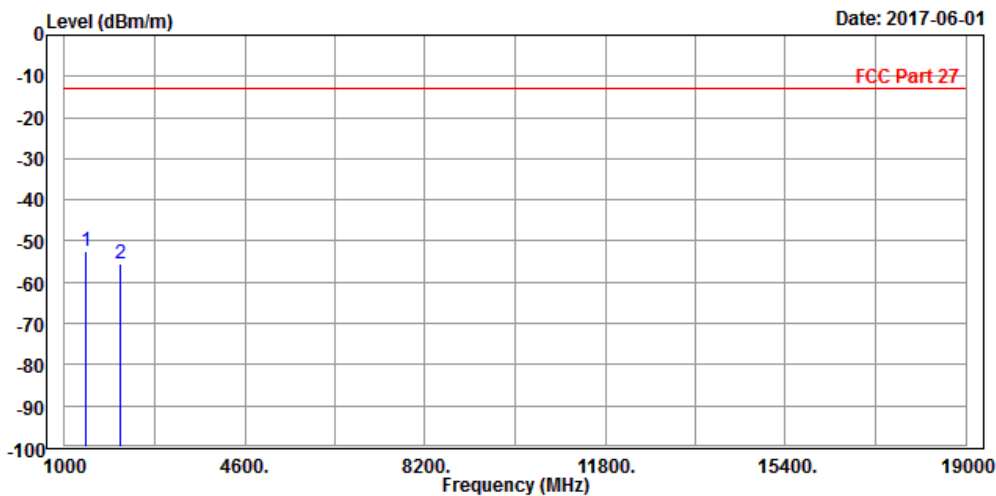



Test Report No.: RF180521W014-3

| | | | |
|--|------------------|------------------------|---------------|
| MODE | TX channel 23095 | FREQUENCY RANGE | Above 1000MHz |
| ENVIRONMENTAL CONDITIONS | 23deg. C, 70%RH | INPUT POWER | DC 3.8V |
| TESTED BY | Star Le | | |
| ANTENNA POLARITY & TEST DISTANCE: VERTICAL AT 3 M | | | |

| | Freq | Level | Read Level | Limit | Over Limit | Factor | Remark | Pol/Phase |
|------|----------|--------|------------|--------|------------|--------|--------|-----------|
| | MHz | dBm/m | dBm | dBm/m | dB | dB/m | | |
| 1 | 1414.000 | -50.97 | -45.52 | -13.00 | -37.97 | -5.45 | Peak | Vertical |
| 2 PP | 2122.000 | -50.26 | -50.02 | -13.00 | -37.26 | -0.24 | Peak | Vertical |

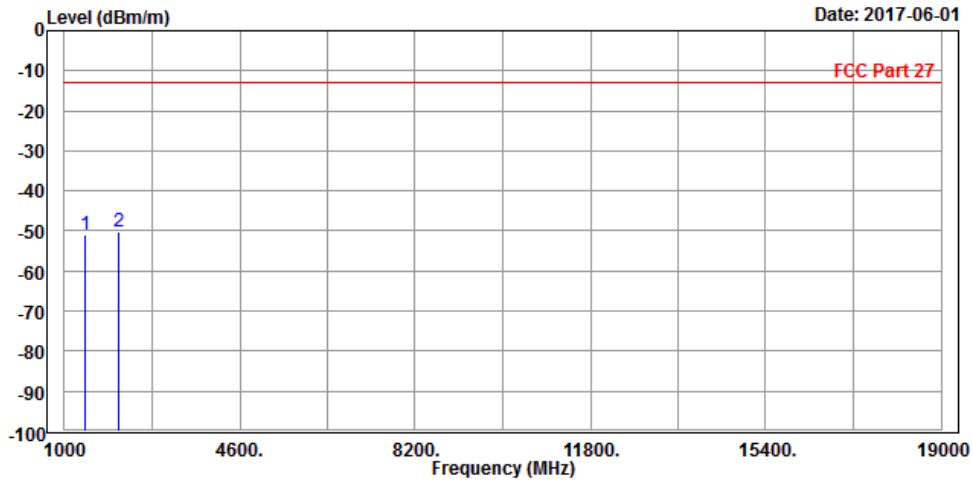



Test Report No.: RF180521W014-3

CHANNEL BANDWIDTH: 10MHz / QPSK

CH 23060

| | | | |
|--|------------------|------------------------|---------------|
| MODE | TX channel 23060 | FREQUENCY RANGE | Above 1000MHz |
| ENVIRONMENTAL CONDITIONS | 23deg. C, 60%RH | INPUT POWER | DC 3.8V |
| TESTED BY | Tony Zou | | |
| ANTENNA POLARITY & TEST DISTANCE: HORIZONTAL AT 3 M | | | |

| | Freq | Level | Read Level | Limit Line | Over Limit | Factor | Remark | Pol/Phase |
|------|----------|--------|------------|------------|------------|--------|--------|------------|
| | MHz | dBm/m | dBm | dBm/m | dB | dB/m | | |
| 1 | 1414.000 | -60.76 | -54.03 | -13.00 | -47.76 | -6.73 | Peak | Horizontal |
| 2 PP | 2118.000 | -55.67 | -53.73 | -13.00 | -42.67 | -1.94 | Peak | Horizontal |

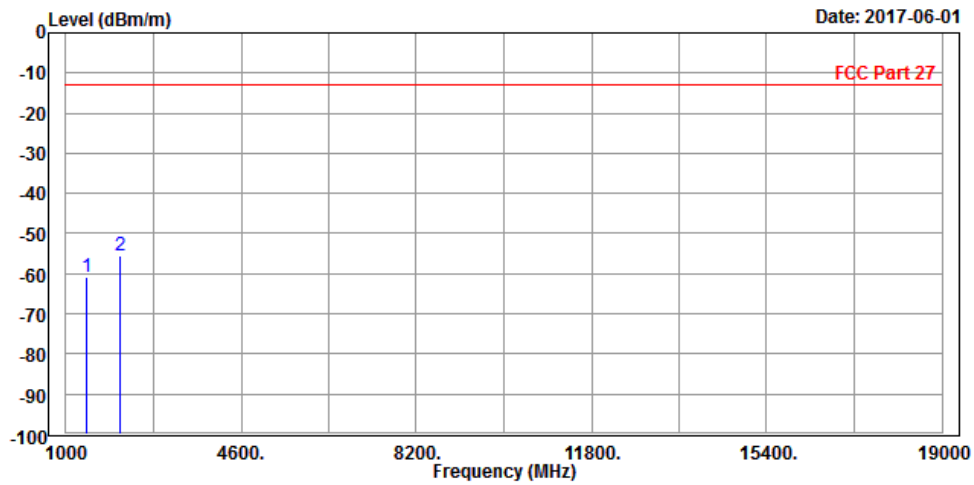



Test Report No.: RF180521W014-3

| | | | |
|--|------------------|------------------------|---------------|
| MODE | TX channel 23060 | FREQUENCY RANGE | Above 1000MHz |
| ENVIRONMENTAL CONDITIONS | 23deg. C, 60%RH | INPUT POWER | DC 3.8V |
| TESTED BY | Tony Zou | | |
| ANTENNA POLARITY & TEST DISTANCE: VERTICAL AT 3 M | | | |

| | Freq | Level | Read Level | Limit Line | Over Limit | Factor | Remark | Pol/Phase |
|------|----------|--------|------------|------------|------------|--------|--------|-----------|
| | MHz | dBm/m | dBm | dBm/m | dB | dB/m | | |
| 1 | 1414.000 | -59.38 | -53.93 | -13.00 | -46.38 | -5.45 | Peak | Vertical |
| 2 PP | 2118.000 | -53.49 | -53.25 | -13.00 | -40.49 | -0.24 | Peak | Vertical |

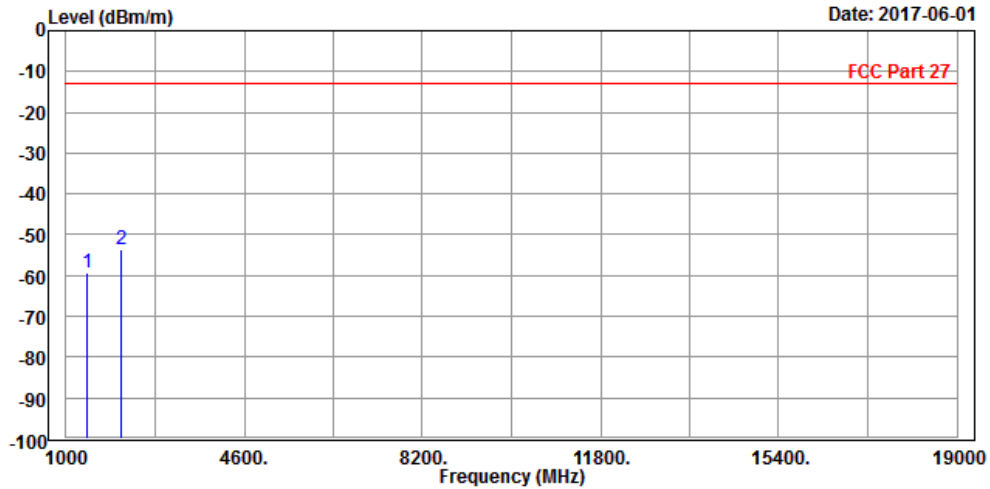



Test Report No.: RF180521W014-3

CH23095

| | | | |
|--|------------------|-----------------|---------------|
| MODE | TX channel 23095 | FREQUENCY RANGE | Above 1000MHz |
| ENVIRONMENTAL CONDITIONS | 23deg. C, 70%RH | INPUT POWER | DC 3.8V |
| TESTED BY | Star Le | | |
| ANTENNA POLARITY & TEST DISTANCE: HORIZONTAL AT 3 M | | | |

| | Freq | Level | Read Level | Limit Line | Over Limit | Factor | Remark | Pol/Phase |
|---|-------------|--------|------------|------------|------------|--------|--------|------------|
| | MHz | dBm/m | dBm | dBm/m | dB | dB/m | | |
| 1 | PP 1416.000 | -40.12 | -33.40 | -13.00 | -27.12 | -6.72 | Peak | Horizontal |
| 2 | 2122.000 | -50.41 | -48.47 | -13.00 | -37.41 | -1.94 | Peak | Horizontal |

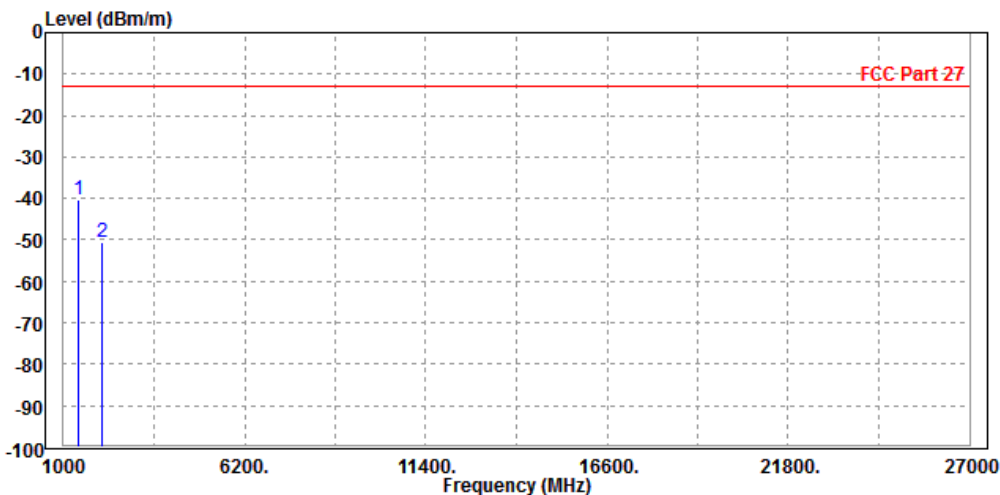



Test Report No.: RF180521W014-3

| | | | |
|--|------------------|-----------------|---------------|
| MODE | TX channel 23095 | FREQUENCY RANGE | Above 1000MHz |
| ENVIRONMENTAL CONDITIONS | 23deg. C, 70%RH | INPUT POWER | DC 3.8V |
| TESTED BY | Star Le | | |
| ANTENNA POLARITY & TEST DISTANCE: VERTICAL AT 3 M | | | |

| | Freq | Level | Read Level | Limit Line | Over Limit | Factor | Remark | Pol/Phase |
|---|-------------|--------|------------|------------|------------|--------|--------|-----------|
| | MHz | dBm/m | dBm | dBm/m | dB | dB/m | | |
| 1 | PP 1416.000 | -42.00 | -36.56 | -13.00 | -29.00 | -5.44 | Peak | Vertical |
| 2 | 2122.000 | -48.95 | -48.71 | -13.00 | -35.95 | -0.24 | Peak | Vertical |

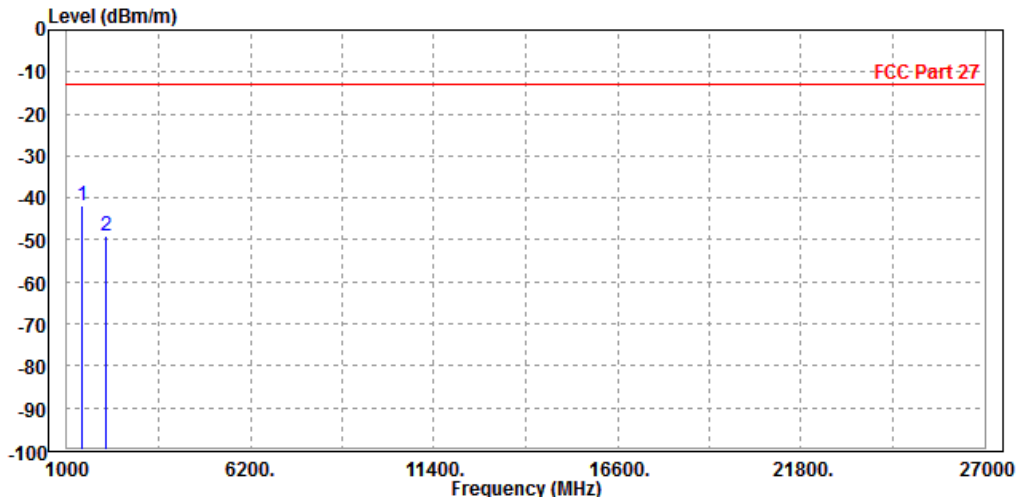



Test Report No.: RF180521W014-3

CH 23130

| | | | |
|--|------------------|------------------------|---------------|
| MODE | TX channel 23130 | FREQUENCY RANGE | Above 1000MHz |
| ENVIRONMENTAL CONDITIONS | 23deg. C, 60%RH | INPUT POWER | DC 3.8V |
| TESTED BY | Tony Zou | | |
| ANTENNA POLARITY & TEST DISTANCE: HORIZONTAL AT 3 M | | | |

| | Freq | Level | Read Level | Limit Line | Over Limit | Factor | Remark | Pol/Phase |
|---|-------------|--------|------------|------------|------------|--------|--------|------------|
| | MHz | dBm/m | dBm | dBm/m | dB | dB/m | | |
| 1 | PP 1414.000 | -52.06 | -45.33 | -13.00 | -39.06 | -6.73 | Peak | Horizontal |
| 2 | 2130.000 | -54.28 | -52.35 | -13.00 | -41.28 | -1.93 | Peak | Horizontal |

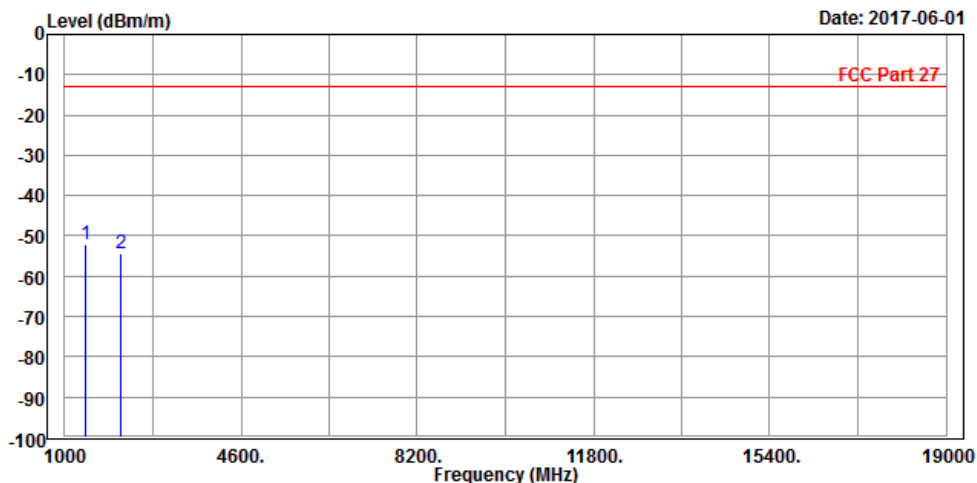



Test Report No.: RF180521W014-3

| | | | |
|--|------------------|------------------------|---------------|
| MODE | TX channel 23130 | FREQUENCY RANGE | Above 1000MHz |
| ENVIRONMENTAL CONDITIONS | 23deg. C, 60%RH | INPUT POWER | DC 3.8V |
| TESTED BY | Tony Zou | | |
| ANTENNA POLARITY & TEST DISTANCE: VERTICAL AT 3 M | | | |

| | Freq | Level | Read Level | Limit Line | Over Limit | Factor | Remark | Pol/Phase |
|---|-------------|--------|------------|------------|------------|--------|--------|-----------|
| | MHz | dBm/m | dBm | dBm/m | dB | dB/m | | |
| 1 | PP 1414.000 | -50.84 | -45.39 | -13.00 | -37.84 | -5.45 | Peak | Vertical |
| 2 | 2130.000 | -54.31 | -54.07 | -13.00 | -41.31 | -0.24 | Peak | Vertical |

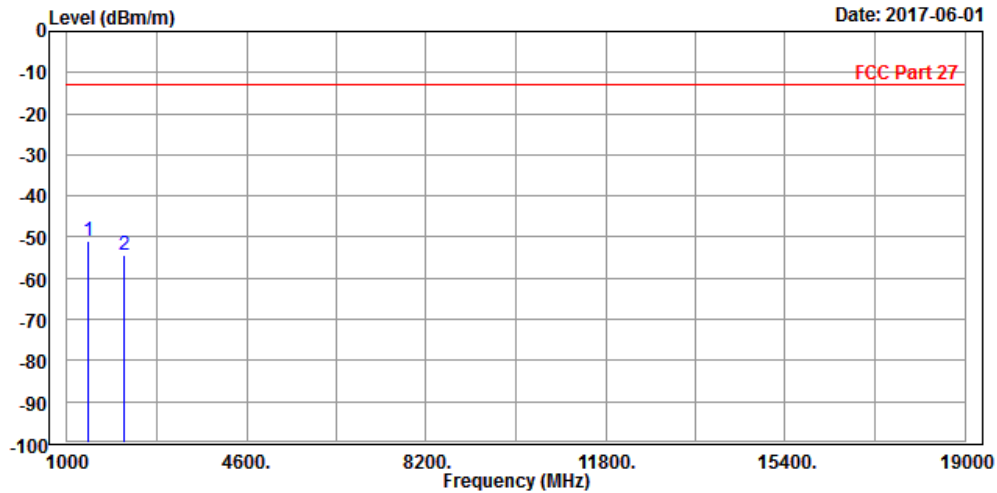



Test Report No.: RF180521W014-3

4 INFORMATION ON THE TESTING LABORATORIES

We, BV 7LAYERS COMMUNICATIONS TECHNOLOGY (SHENZHEN) CO. LTD., were founded in 2015 to provide our best service in EMC, Radio, Telecom and Safety consultation. Our laboratories are accredited and approved according to ISO/IEC 17025.

If you have any comments, please feel free to contact us at the following:

Shenzhen EMC/RF Lab:

Tel: +86-755-88696566

Fax: +86-755-88696577

Email: customerservice.dg@cn.bureauveritas.com

Web Site: www.adt.com.tw

The address and road map of all our labs can be found in our web site also.



Test Report No.: RF180521W014-3

5 APPENDIX A – MODIFICATIONS RECORDERS FOR ENGINEERING CHANGES TO THE EUT BY THE LAB

No modifications were made to the EUT by the lab during the test.

---END---