

RADIO TEST REPORT

(FCC Part 15 Subpart C / IC RSS-210)



Applicant:	PAX Technology Limited
Address:	Room 2416, 24/F., Sun Hung Kai Centre, 30 Harbour Hong Kong China

Manufacturer:	PAX Computer Technology (Shenzhen) Co., Ltd.
Address:	4/F, No.3 Building, Software Park, Second Central Science-Tech Road, High-Tech industrial Park, Shenzhen, Guangdong, P.R.C.
Product:	Integrated Smart Terminal
Brand Name:	PAX
Model Name:	E700
FCC ID:	V5PE700GM
Date of tests:	Sep. 01, 2021 ~ Sep. 26, 2021

The tests have been carried out according to the requirements of the following standard:

- Part 15 Subpart C §15. 225 / IC RSS-210 issue 10(December 2019)**
- RSS-Gen Issue 5 Amendment 1 (March 2019)**
- ANSI C63.10-2013**

CONCLUSION: The submitted sample was found to COMPLY with the test requirement

Prepared by Simon Wang Engineer / Mobile Department	Approved by Luke Lu Manager / Mobile Department
 Date: Sep. 27, 2021	 Date: Sep. 27, 2021

This report is governed by, and incorporates by reference, CPS Conditions of Service as posted at the date of issuance of this report at <http://www.bureauveritas.com/home/about-us/our-business/cps/about-us/terms-conditions> and is intended for your exclusive use. Any copying or replication of this report to or for any other person or entity, or use of our name or trademark, is permitted only with our prior written permission. This report sets forth our findings solely with respect to the test samples identified herein. The results set forth in this report are not indicative or representative of the quality or characteristics of the lot from which a test sample was taken or any similar or identical product unless specifically and expressly noted. Our report includes all of the tests requested by you and the results thereof based upon the information that you provided to us. Measurement uncertainty is only provided upon request for accredited tests. You have 60 days from date of issuance of this report to notify us of any material error or omission caused by our negligence or if you require measurement uncertainty; provided, however, that such notice shall be in writing and shall specifically address the issue you wish to raise. A failure to raise such issue within the prescribed time shall constitute your unqualified acceptance of the completeness of this report, the tests conducted and the correctness of the report contents.



**BUREAU
VERITAS**

Test Report No.: W7L-P21090005RF07

Report Revise Record

ISSUE NO.	REASON FOR CHANGE	DATE ISSUED
W7L-P21090006RF07	Original release	Sep. 27, 2021

TABLE OF CONTENTS

1. GENERAL DESCRIPTION.....	5
1.1 Applicant.....	5
1.2 Manufacturer.....	5
1.3 General Description Of EUT.....	5
1.4 Modification of EUT.....	5
1.5 Applicable Standards.....	5
2. TEST CONFIGURATION OF EQUIPMENT UNDER TEST.....	6
2.1 Descriptions of Test Mode.....	6
2.2 Test Configurations.....	7
2.3 Support Equipment.....	8
2.4 Test Setup.....	8
2.5 Measurement Results Explanation Example.....	10
3. TEST RESULT	11
3.1 20dB and 99% Bandwidth Measurement.....	11
3.2 Frequency Stability Measurement.....	12
3.3 Field Strength of Fundamental Emissions and Mask Measurement.....	14
3.4 Radiated Emissions Measurement.....	17
3.5 AC Conducted Emission Measurement.....	23
3.6 Antenna Requirements.....	26
4 LIST OF MEASURING EQUIPMENT.....	27
5 UNCERTAINTY OF EVALUATION.....	28

Summary of Test RESULT

FCC Rule	IC Rule	Description	Limit	Result	Remark
-	RSS-Gen 6.7	99% Bandwidth	-	Pass	-
15.225(a)(b)(c)	RSS-210 Annex B.6	Field Strength of Fundamental Emissions	15.225(a)(b)(c) RSS-210 Annex B.6	Pass	-
2.1049	-	20dB Spectrum Bandwidth	2.1049	Pass	-
15.225(d) 15.209	RSS-210 Annex B.6	Radiated Emission	15.225(d) & 15.209 RSS-210 Annex B.6	Pass	-
15.207	RSS-GEN 8.8	AC Conducted Emission	15.207(a)	Pass	-
15.225(e)	Annex B.6	Frequency Stability	< ±100 ppm	Pass	
15.203	RSS-Gen 6.8	Antenna Requirement	N/A	Pass	-

1. General Description

1.1 Applicant

PAX Technology Limited

Room 2416, 24/F., Sun Hung Kai Centre, 30 Harbour Road, Wanchai, Hong Kong

1.2 Manufacturer

PAX Computer Technology (Shenzhen) Co., Ltd.

4/F, No.3 Building, Software Park, Second Central Science-Tech Road, High-Tech industrial Park, Shenzhen, Guangdong, P.R.C.

1.3 General Description Of EUT

Items	Description
Tx/Rx Frequency Range	13.553 ~ 13.567MHz
Channel Number	1
20dBW	2.864 kHz
99%OBW	2.436 kHz
Antenna Type	Loop Antenna
Type of Modulation	ASK

Remark: The above EUT's information was declared by manufacturer. Please refer to the specifications or user's manual for more detailed description.

1.4 Modification of EUT

No modifications are made to the EUT during all test items.

1.5 Applicable Standards

According to the specifications of the manufacturer, the EUT must comply with the requirements of the following standards:

- ♦ FCC Part 15 Subpart C §15.225
- ♦ ANSI C63.10-2013
- ♦ RSS-210 Issue 10
- ♦ RSS-Gen Issue 5

2. Test Configuration of Equipment Under Test

2.1 Descriptions of Test Mode

Investigation has been done on all the possible configurations for searching the worst cases. The following table is a list of the test modes shown in this test report.

Test Items	
AC Power Line Conducted Emissions	Field Strength of Fundamental Emissions
20dB Spectrum Bandwidth	Frequency Stability
Radiated Emissions 9kHz~30MHz	Radiated Emissions 30MHz~1GHz
<p>Note:</p> <ol style="list-style-type: none"> The EUT was programmed to be in continuously transmitting mode. The ancillary equipment, NFC card, is used to make the EUT (NFC) continuously transmit at 13.56MHz and is placed around 3 cm gap to the EUT. Pre-Scan has been conducted to determine the worst-case mode from all possible combinations between available modulations, work in modes and data rates. Selected for the final test as listed below. 	

Frequency	Work in Modes	Type	Data Rate (Kbps)
13.56 MHz	<input type="checkbox"/> Card Emulation <input checked="" type="checkbox"/> Reader/Writer <input type="checkbox"/> Peer-to-Peer	<input type="checkbox"/> A <input type="checkbox"/> B <input checked="" type="checkbox"/> F <input type="checkbox"/> V	<input type="checkbox"/> 106 <input checked="" type="checkbox"/> 212 <input type="checkbox"/> 424 <input type="checkbox"/> 848
<p>Remark:</p> <p>The mark "<input checked="" type="checkbox"/>" means is chosen for testing; The mark "<input type="checkbox"/>" means is not chosen for testing.</p>			

2.2 Test Configurations

<AC Conducted Emissions>

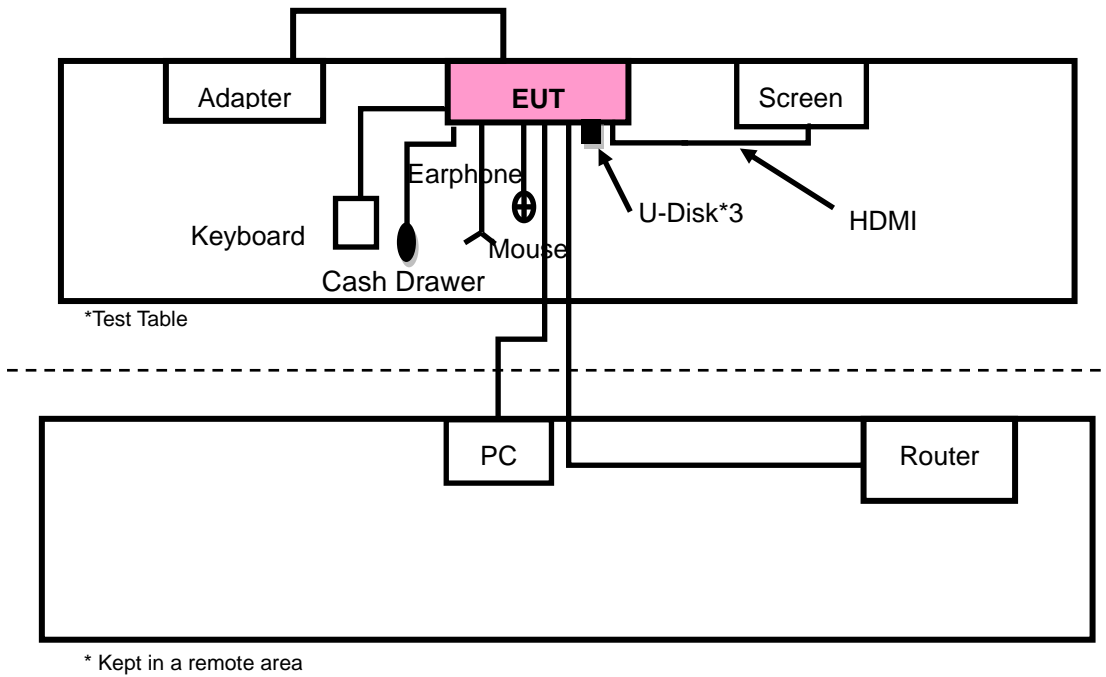

< For Fundamental Emissions and Mask and Radiated Emissions Measurement >

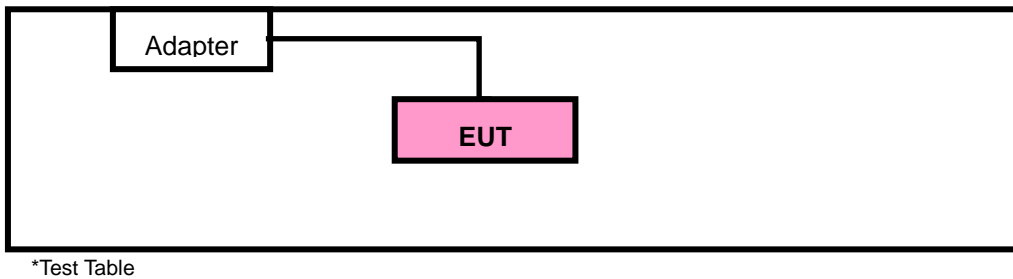

2.3 Support Equipment

NO.	PRODUCT	BRAND	MODEL NO.	SERIAL NO.	FCC ID
1	Laptop	Lenovo	Thnikpad L440	R90FTFKP	N/A
2	Printer	HP	Hp LaserJet 1300	CNSJF75989	N/A
3	SD	San Disk	Ultra	N/A	N/A
4	Earphone	Nokia	WH-108	RTF	N/A
5	Wireless AP	ABOCOM	WR224GR	060500749P	N/A
6	U-Disk	HP	N/A	N/A	N/A
7	Mouse	Lenovo	N/A	N/A	N/A
8	Keyboard	PAX	N/A	N/A	N/A
9	Screen	Dell	N/A	N/A	N/A

2.4 Test Setup

The EUT is continuously communicating during the tests.

EUT was set in the Hidden menu mode to enable NFC communications.

Setup diagram for Conducted Test

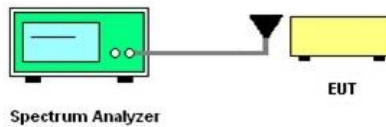

Setup diagram for Radiation(9KHz~30MHz) Test

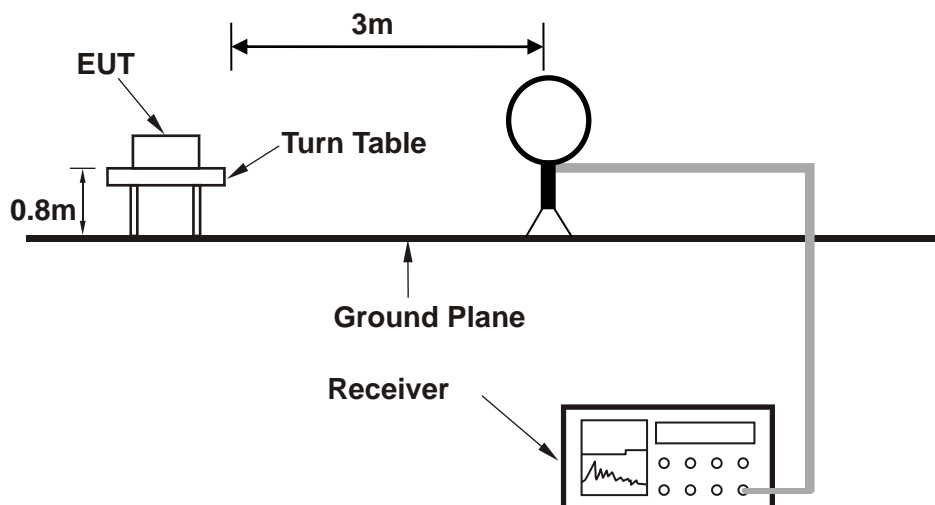

Setup diagram for Radiation(Below 1G) Test

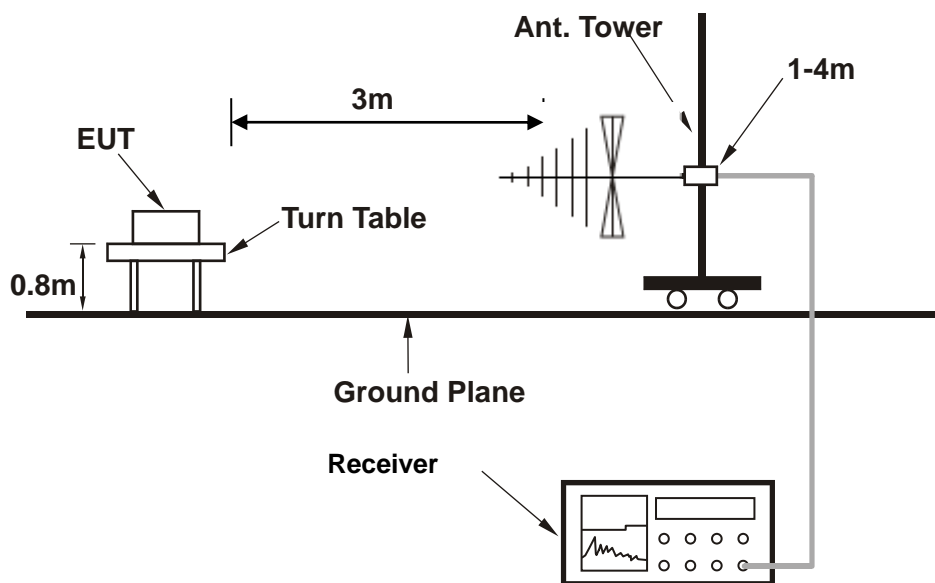

Setup diagram for AC Conducted Emission Test

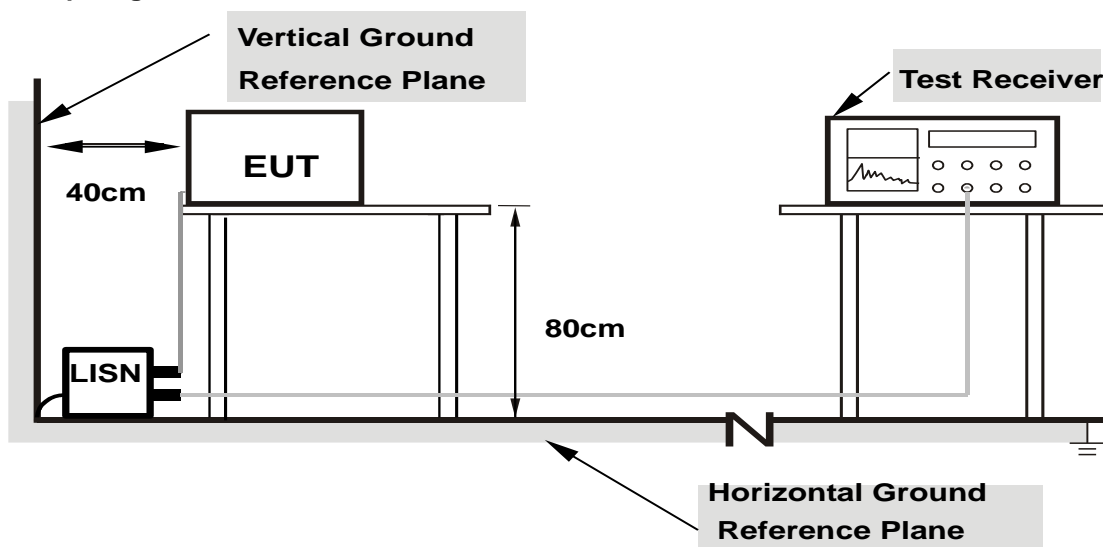

Note: 1.Support units were connected to second LISN.

2.Both of LISNs (AMN) are 80 cm from EUT and at least 80 from other units and other metal planes



2.5 Measurement Results Explanation Example

For all conducted test items:

The offset level is set in the spectrum analyzer to compensate the RF cable loss and attenuator factor between EUT conducted output port and spectrum analyzer. With the offset compensation, the spectrum analyzer reading level is exactly the EUT RF output level.

Example:

The spectrum analyzer offset is derived from RF cable loss and attenuator factor.

Offset = RF cable loss + attenuator factor.

Following shows an offset computation example with cable loss 5 dB and 10dB attenuator.

$$\begin{aligned} \text{Offset(dB)} &= \text{RF cable loss(dB)} + \text{attenuator factor(dB)}. \\ &= 5 + 10 = 15 \text{ (dB)} \end{aligned}$$

3. Test Result

3.1 20dB and 99% Bandwidth Measurement

3.1.1 Limit of 20dB and 99% Bandwidth

Intentional radiators must be designed to ensure that the 20dB and 99% emission bandwidth in the specific band 13.553~13.567MHz.

3.1.2 Test Procedures

1. The spectrum analyzer connected via a receive antenna placed near the EUT in peak Max hold mode.
2. The resolution bandwidth of 1 kHz and the video bandwidth of 3 kHz were used.
3. Measured the spectrum width with power higher than 20dB below carrier.
4. Measured the 99% OBW.

3.1.3 Test Result of 20dB and 99% Bandwidth

Test Mode :	NFC	Temperature :	23~25°C		
Test Engineer :	Jace hu	Relative Humidity :	60~63%		
Mode	Frequency	20dB Bandwidth [kHz]	99% OBW[kHz]	Verdict	
NFC Type F_212 Kbps	13.56MHz	2.864	2.436	PASS	

20dB Bandwidth & 99% Bandwidth Plot

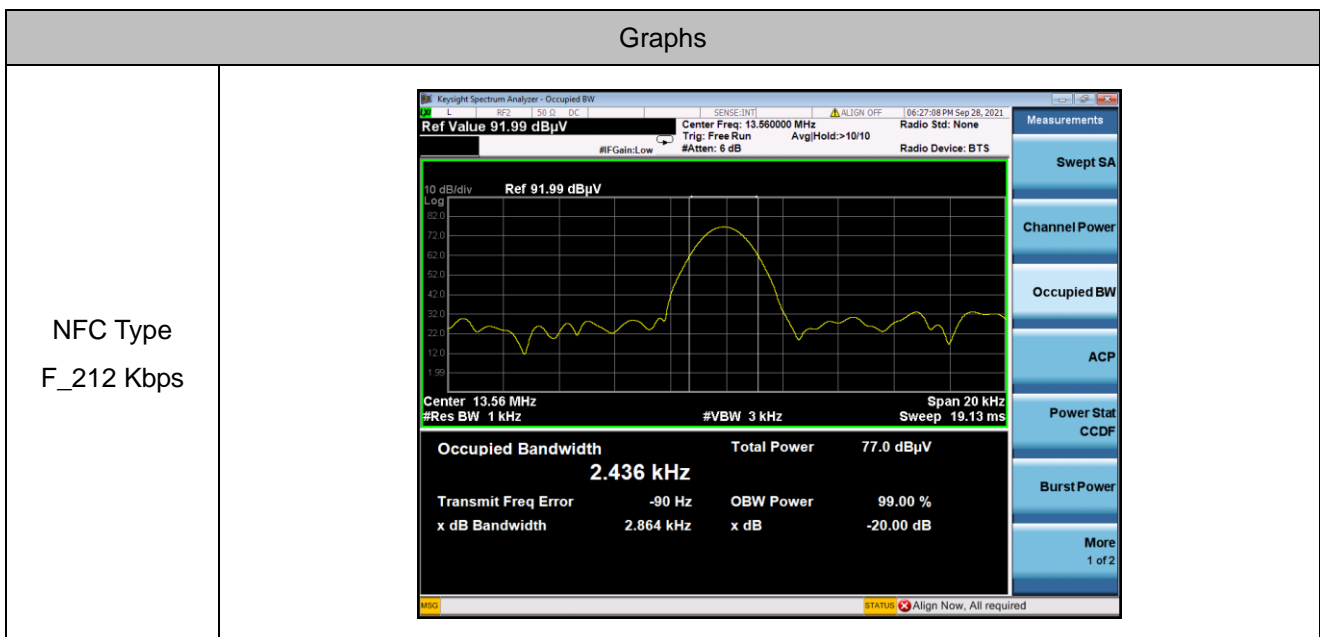

3.2 Frequency Stability Measurement

3.2.1 Limit of Frequency Stability

The frequency tolerance of the carrier signal shall be maintained within +/- 0.01% (100ppm) of the operating frequency over a temperature variation of -20 degrees to +50 degrees C at normal supply voltage, and for a variation in the primary supply voltage from 85% to 115% of the rated supply voltage at a temperature of 20 degrees C. For battery operated equipment, the equipment tests shall be performed using a new battery.

3.2.2 Test Procedures

1. The spectrum analyzer connected via a receive antenna placed near the EUT.
2. EUT have transmitted signal and fixed channelize.
3. Set the spectrum analyzer span to view the entire emissions bandwidth.
4. Set RBW = 1 kHz, VBW = 3 kHz with peak detector and maxhold settings.
5. The f_c is declaring of channel frequency. Then the frequency error formula is $(f_c - f) / f_c \times 10^6$ ppm and the limit is less than ± 100 ppm.
6. Extreme temperature rule is -20°C~50°C.

3.2.3 Test Result of Frequency Stability

The NFC Type F_212 Kbps is the worst case, Only report worst mode data



NFC Type F_212 Kbps

Voltage (Vdc)	Temperature (°C)	Measurement Frequency (MHz)	Frequency Tolerance(ppm)	Limit(ppm)	Result
22.8	20	13.55989	-8.11	±100	Pass
25.2		13.55992	-5.90		Pass
24	-20	13.55991	-6.64		Pass
	-10	13.5599	-7.37		Pass
	0	13.55993	-5.16		Pass
	10	13.55992	-5.90		Pass
	20	13.55992	-5.90		Pass
	30	13.55993	-5.16		Pass
	40	13.5599	-7.37		Pass
	50	13.55994	-4.42		Pass

3.3 Field Strength of Fundamental Emissions and Mask Measurement

3.3.1 Limit of Field Strength of Fundamental Emissions and Mask

Rules and specifications	FCC CFR 47 Part 15 section 15.225 IC RSS-210 B.6			
	Description	Compliance with the spectrum mask is tested with RBW set to 9kHz.		
Freq. of Emission (MHz)	Field Strength ($\mu\text{V/m}$) at 30m	Field Strength ($\text{dB}\mu\text{V/m}$) at 30m	Field Strength ($\text{dB}\mu\text{V/m}$) at 10m	Field Strength ($\text{dB}\mu\text{V/m}$) at 3m
1.705~13.110	30	29.5	48.58	69.5
13.110~13.410	106	40.5	59.58	80.5
13.410~13.553	334	50.5	69.58	90.5
13.553~13.567	15848	84.0	103.08	124.0
13.567~13.710	334	50.5	69.58	90.5
13.710~14.010	106	40.5	59.58	80.5
14.010~30.000	30	29.5	48.58	69.5

3.3.2 Test Procedures

1. Configure the EUT according to ANSI C63.10. The EUT was placed on the top of the turntable 0.8 meter above ground. The phase center of the loop receiving antenna mounted antenna tower was placed 3 meters far away from the turntable.
2. Power on the EUT and all the supporting units. The turntable was rotated by 360 degrees to determine the position of the highest radiation.
3. The height of the receiving antenna was fixed at one meter above ground to find the maximum emissions field strength.
4. For Fundamental emissions, use the receiver to measure QP reading.
5. When the radiated emissions limits are expressed in terms of the average value of the emissions, and pulsed operation is employed, the measurement field strength shall be determined by averaging over one complete pulse train, including blanking intervals, as long as the pulse train does not exceed 0.1 seconds. As an alternative (provided the transmitter operates for longer than 0.1 seconds) or in cases where the pulse train exceeds 0.1 seconds, the measured field strength shall be determined from the average absolute voltage during a 0.1 second interval during which the field strength is at its maximum value.
6. Compliance with the spectrum mask is tested with RBW set to 9kHz.

Note: Emission level ($\text{dB}\mu\text{V/m}$) = 20 log Emission level ($\mu\text{V/m}$).

3.3.3 Test Results of Field Strength of Fundamental Emissions and Mask (1.705 MHz ~ 30 MHz)

Test Mode :	NFC (13.56 MHz)	Temperature :	23°C
Test Engineer :	Jace hu	Relative Humidity :	70%
Frequency Range	13.11Hz~14.01MHz	Polarization :	Horizontal

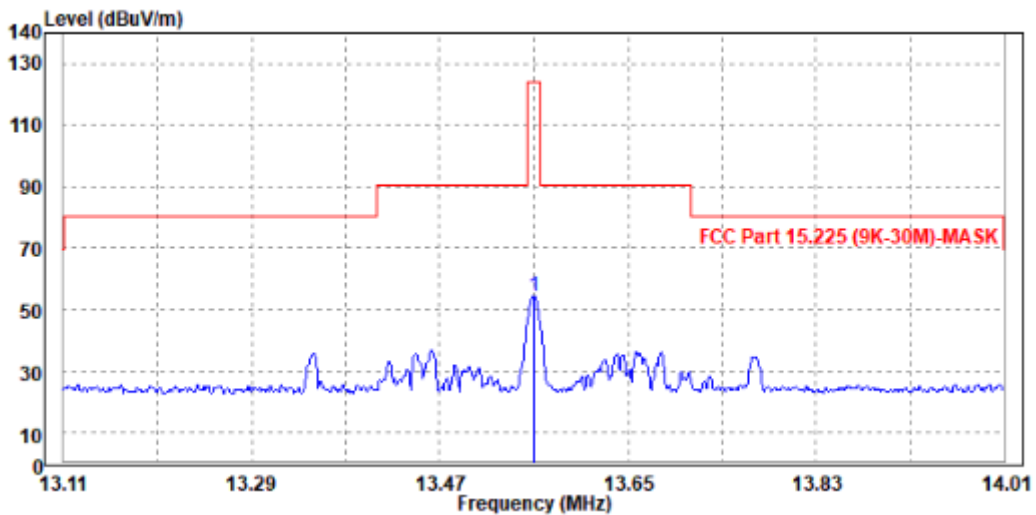

A

	Read	Limit	Over				
Freq	Level	Level	Line	Limit	Factor	Remark	Pol/Phase
MHz	dBuV/m	dBuV	dBuV/m	dB	dB/m		
1 PP	13.560	54.27	72.21	124.00	-69.73	-17.94	Peak Horizontal



BUREAU
VERITAS

Test Report No.: W7L-P21090005RF07

Test Mode :	NFC (13.56 MHz)	Temperature :	23°C
Test Engineer :	Jace hu	Relative Humidity :	70%
Frequency Range	13.11Hz~14.01MHz	Polarization :	Vertical

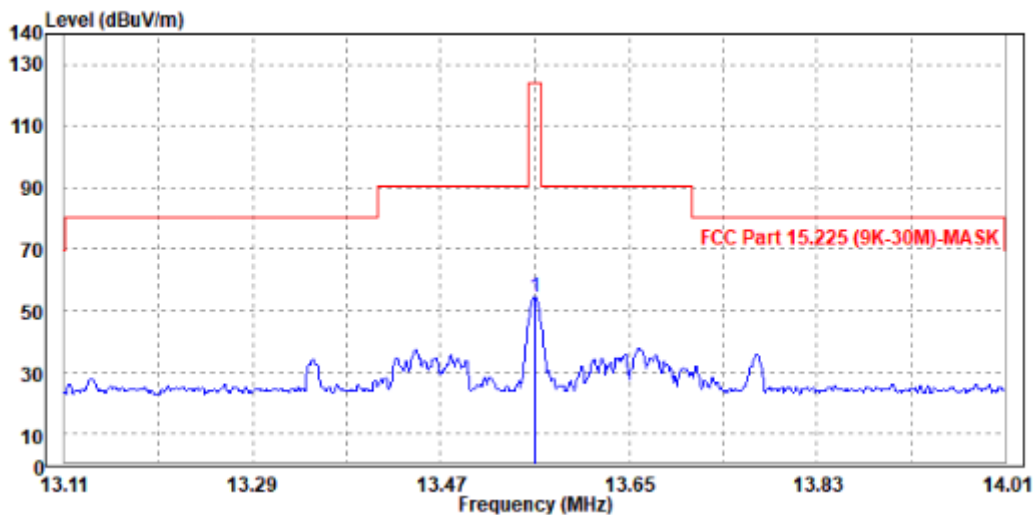

	Read	Limit	Over				
Freq	Level	Level	Line	Limit	Factor	Remark	Pol/Phase
MHz	dBuV/m	dBuV	dBuV/m	dB	dB/m		
1 PP	13.560	54.30	72.24	124.00	-69.70	-17.94 Peak	Vertical

3.4 Radiated Emissions Measurement

3.4.1 Limit

The field strength of any emissions which appear outside of 13.110 ~14.010MHz band shall not exceed the general radiated emissions limits.

Frequencies (MHz)	Field Strength ($\mu\text{V/m}$)	Measurement Distance (meters)
0.009~0.490	2400/F(kHz)	300
0.490~1.705	24000/F(kHz)	30
1.705~30.0	30	30
30~88	100	3
88~216	150	3
216~960	200	3
Above 960	500	3

3.4.2 Measuring Instrument Setting

The following table is the setting of receiver.

Receiver Parameter	Setting
Attenuation	Auto
Frequency Range: 9kHz~150kHz	RBW 200Hz for QP
Frequency Range: 150kHz~30MHz	RBW 9kHz for QP
Frequency Range: 30MHz~1000MHz	RBW 120kHz for Peak

Note: The emission limits shown in the above table are based on measurements employing a CISPR quasi-peak detector except for the frequency bands 9-90 kHz, 110-490 kHz. Radiated emission limits in these two bands are based on measurements employing an average detector.

3.4.3 Test Procedures

1. Configure the EUT according to ANSI C63.10. The EUT was placed on the top of the turntable 0.8 meter above ground. The phase center of the receiving antenna mounted on the top of a height-variable antenna tower was placed 3 meters far away from the turntable.
2. Power on the EUT and all the supporting units. The turntable was rotated by 360 degrees to determine the position of the highest radiation.
3. The height of the broadband receiving antenna was varied between one meter and four meters above ground to find the maximum emissions field strength of both horizontal and vertical polarization.
4. For each suspected emissions, the antenna tower was scan (from 1 M to 4 M) and then the

turntable was rotated (from 0 degree to 360 degrees) to find the maximum reading.

5. Set the test-receiver system to Peak or CISPR quasi-peak Detect Function with specified bandwidth under Maximum Hold Mode.
6. When the radiated emissions limits are expressed in terms of the average value of the emissions, and pulsed operation is employed, the measurement field strength shall be determined by averaging over one complete pulse train, including blanking intervals, as long as the pulse train does not exceed 0.1 seconds. As an alternative (provided the transmitter operates for longer than 0.1 seconds) or in cases where the pulse train exceeds 0.1 seconds, the measured field strength shall be determined from the average absolute voltage during a 0.1 second interval during which the field strength is at its maximum value.
7. In case the emission is lower than 30MHz, loop antenna has to be used for measurement and the recorded data should be QP measured by receiver.

3.4.4 Test Results of Radiated Emissions (9 KHz ~ 30 MHz)

Test Mode :	NFC (13.56 MHz)	Temperature :	23°C
Test Engineer :	Jace hu	Relative Humidity :	70%
Frequency Range	9 KHz ~ 30 MHz	Polarization :	Horizontal

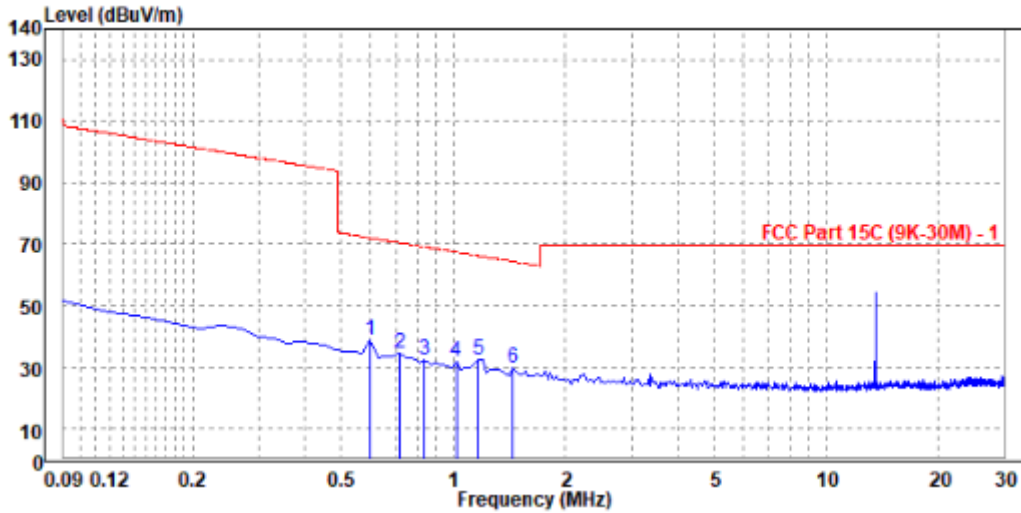

	Freq	Level	Read Level	Limit Line	Over Limit	Factor	Remark	Pol/Phase	
	MHz	dBuV/m	dBuV	dBuV/m	dB	dB/m			
1	PP	0.598	38.71	57.57	72.06	-33.35	-18.86	Peak	Horizontal
2		0.718	34.54	53.31	70.48	-35.94	-18.77	Peak	Horizontal
3		0.838	32.71	51.39	69.14	-36.43	-18.68	Peak	Horizontal
4		1.017	31.80	50.39	67.46	-35.66	-18.59	Peak	Horizontal
5		1.167	32.37	50.96	66.26	-33.89	-18.59	Peak	Horizontal
6		1.436	29.64	48.23	64.46	-34.82	-18.59	Peak	Horizontal



**BUREAU
VERITAS**

Test Report No.: W7L-P21090005RF07

Test Mode :	NFC (13.56 MHz)	Temperature :	23°C
Test Engineer :	Jace hu	Relative Humidity :	70%
Frequency Range	9 KHz ~ 30 MHz	Polarization :	Vertical

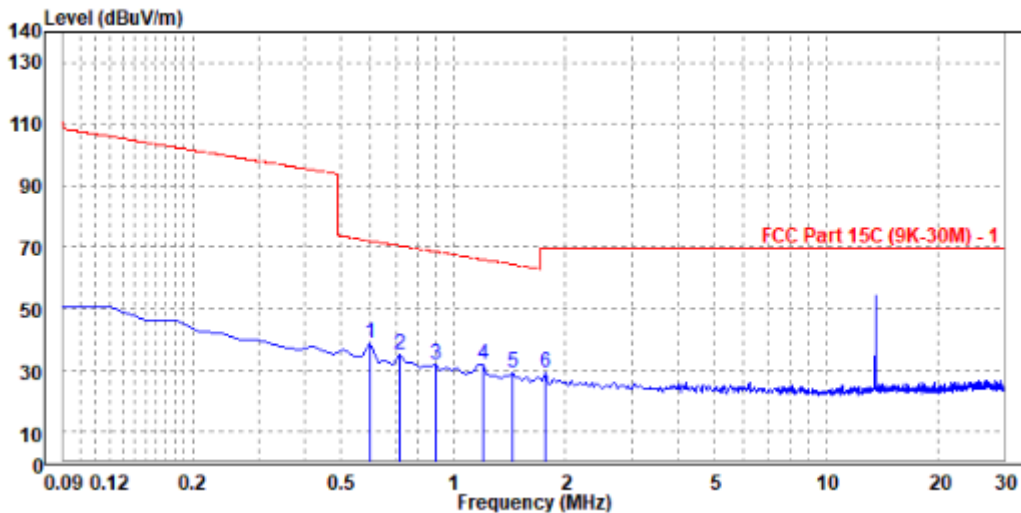

	Freq	Level	Read Level	Limit Line	Over Limit	Factor	Remark	Pol/Phase
	MHz	dBuV/m	dBuV	dBuV/m	dB	dB/m		
1 PP	0.598	38.72	57.58	72.06	-33.34	-18.86	Peak	Vertical
2	0.718	35.04	53.81	70.48	-35.44	-18.77	Peak	Vertical
3	0.898	31.77	50.42	68.54	-36.77	-18.65	Peak	Vertical
4	1.197	31.84	50.43	66.04	-34.20	-18.59	Peak	Vertical
5	1.436	29.13	47.72	64.46	-35.33	-18.59	Peak	Vertical
6	1.765	29.37	47.97	69.54	-40.17	-18.60	Peak	Vertical

3.4.5 Test Result of Radiated Spurious Emission (30MHz ~ 1GHz)

Test Mode :	NFC (13.56MHz)	Temperature :	23°C
Test Engineer :	Jace hu	Relative Humidity :	70%
Frequency Range	30MHz~1GHz	Polarization :	Horizontal

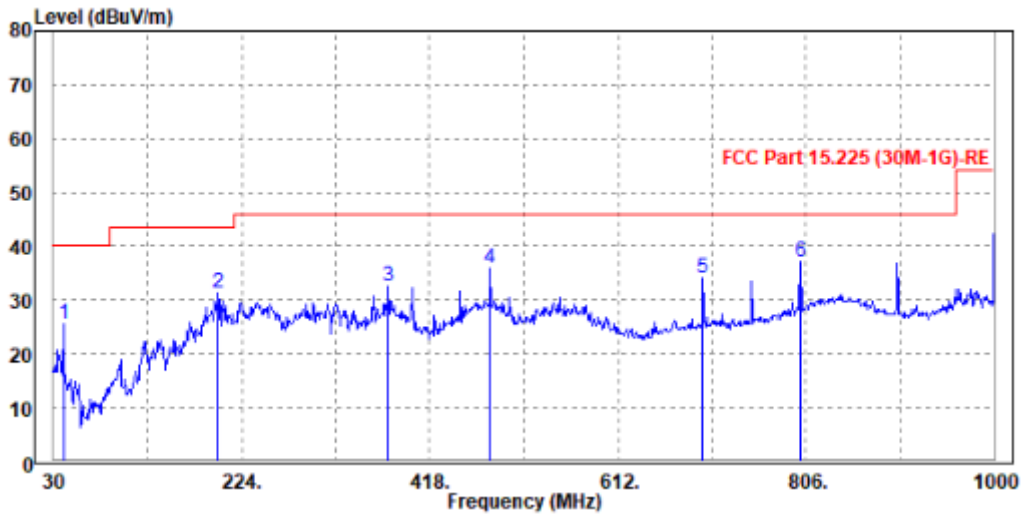

	Freq	Level	Read Level	Limit Line	Over Limit	Factor	Remark	Pol/Phase
	MHz	dBuV/m	dBuV	dBuV/m	dB	dB/m		
1	40.670	25.45	49.09	40.00	-14.55	-23.64	Peak	Horizontal
2	199.750	31.24	55.00	43.50	-12.26	-23.76	Peak	Horizontal
3	375.320	32.43	50.59	46.00	-13.57	-18.16	Peak	Horizontal
4	480.080	35.77	51.55	46.00	-10.23	-15.78	Peak	Horizontal
5	699.300	34.07	45.36	46.00	-11.93	-11.29	Peak	Horizontal
6 PP	800.180	37.26	47.76	46.00	-8.74	-10.50	Peak	Horizontal



**BUREAU
VERITAS**

Test Report No.: W7L-P21090005RF07

Test Mode :	NFC (13.56MHz)	Temperature :	23°C
Test Engineer :	Jace hu	Relative Humidity :	70%
Frequency Range	30MHz~1GHz	Polarization :	Vertical

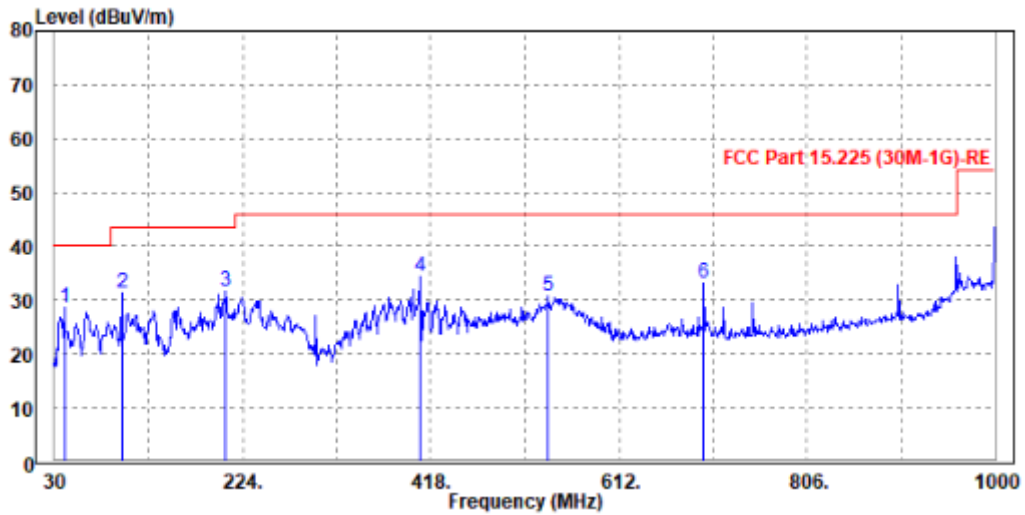

	Freq	Level	Read Level	Limit Line	Over Limit	Factor	Remark	Pol/Phase	
	MHz	dBuV/m	dBuV	dBuV/m	dB	dB/m			
1	PP	40.670	28.66	53.34	40.00	-11.34	-24.68	Peak	Vertical
2		99.840	31.23	58.71	43.50	-12.27	-27.48	Peak	Vertical
3		206.540	31.49	54.43	43.50	-12.01	-22.94	Peak	Vertical
4		406.360	34.36	51.30	46.00	-11.64	-16.94	Peak	Vertical
5		539.250	30.62	44.92	46.00	-15.38	-14.30	Peak	Vertical
6		699.300	33.15	44.84	46.00	-12.85	-11.69	Peak	Vertical

3.5 AC Conducted Emission Measurement

3.5.1 Limit of AC Conducted Emission

For equipment that is designed to be connected to the public utility (AC) power line, the radio frequency voltage that is conducted back onto the AC power line on any frequency or frequencies within the band 150 kHz to 30 MHz shall not exceed the limits in the following table.

Frequency of Emission (MHz)	Conducted Limit (dB μ V)	
	Quasi-Peak	Average
0.15-0.5	66 to 56*	56 to 46*
0.5-5	56	46
5-30	60	50

*Decreases with the logarithm of the frequency.

3.5.2 Test Procedures

1. The EUT was placed 0.4 meter from the conducting wall of the shielding room, and it was kept at least 80 centimeters from any other grounded conducting surface.
2. Connect EUT to the power mains through a line impedance stabilization network (LISN).
3. All the support units are connecting to the other LISN.
4. The LISN provides 50 ohm coupling impedance for the measuring instrument.
5. The FCC states that a 50 ohm, 50 microhenry LISN should be used.
6. Both sides of AC line were checked for maximum conducted interference.
7. The frequency range from 150 kHz to 30 MHz was searched.
8. Set the test-receiver system to Peak Detect Function and specified bandwidth (IF Bandwidth = 9kHz) with Maximum Hold Mode. Then measurement is also conducted by Average Detector and Quasi-Peak Detector Function respectively.



3.5.3 Test Result of AC Conducted Emission

Test Mode :	NFC	Temperature :	25°C
Test Engineer :	Carl Xie	Relative Humidity :	55%
Test Voltage :	120Vac / 60Hz	Phase :	Line
Function Type :	NFC		

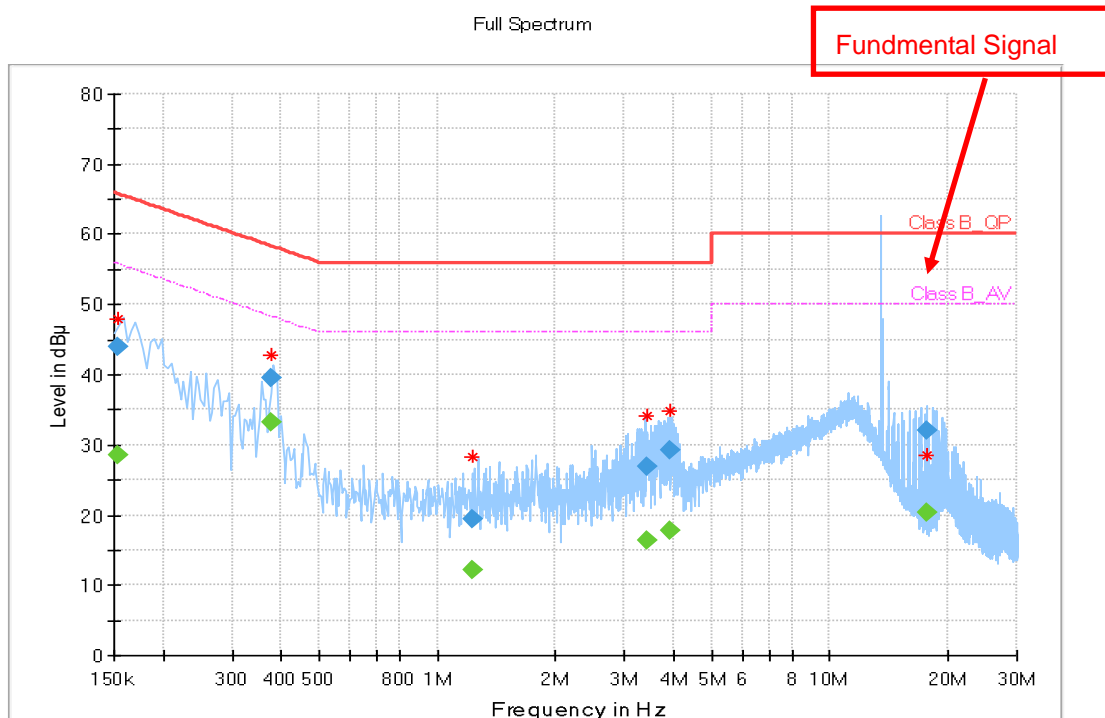

Frequency (MHz)	QuasiPeak (dBµV)	CAverage (dBµV)	Limit (dBµV)	Margin (dB)	Line	Filter	Corr. (dB)
0.158000	---	32.08	55.57	23.49	L1	ON	9.7
0.158000	48.59	---	65.57	16.98	L1	ON	9.7
0.284000	---	21.45	50.70	29.25	L1	ON	9.7
0.284000	35.70	---	60.70	25.00	L1	ON	9.7
0.364000	---	21.10	48.64	27.54	L1	ON	9.7
0.364000	34.29	---	58.64	24.35	L1	ON	9.7
3.412000	---	16.54	46.00	29.46	L1	ON	9.7
3.412000	31.08	---	56.00	24.92	L1	ON	9.7
14.408000	---	23.93	50.00	26.07	L1	ON	9.8
14.408000	47.52	---	60.00	12.48	L1	ON	9.8
15.784000	---	18.86	50.00	31.14	L1	ON	9.8
15.784000	38.71	---	60.00	21.29	L1	ON	9.8



BUREAU VERITAS

Test Report No.: W7L-P21090005RF07

Test Mode :	NFC	Temperature :	25°C
Test Engineer :	Carl Xie	Relative Humidity :	55%
Test Voltage :	AC 120V/60Hz	Phase :	Neutral
Function Type :	NFC		

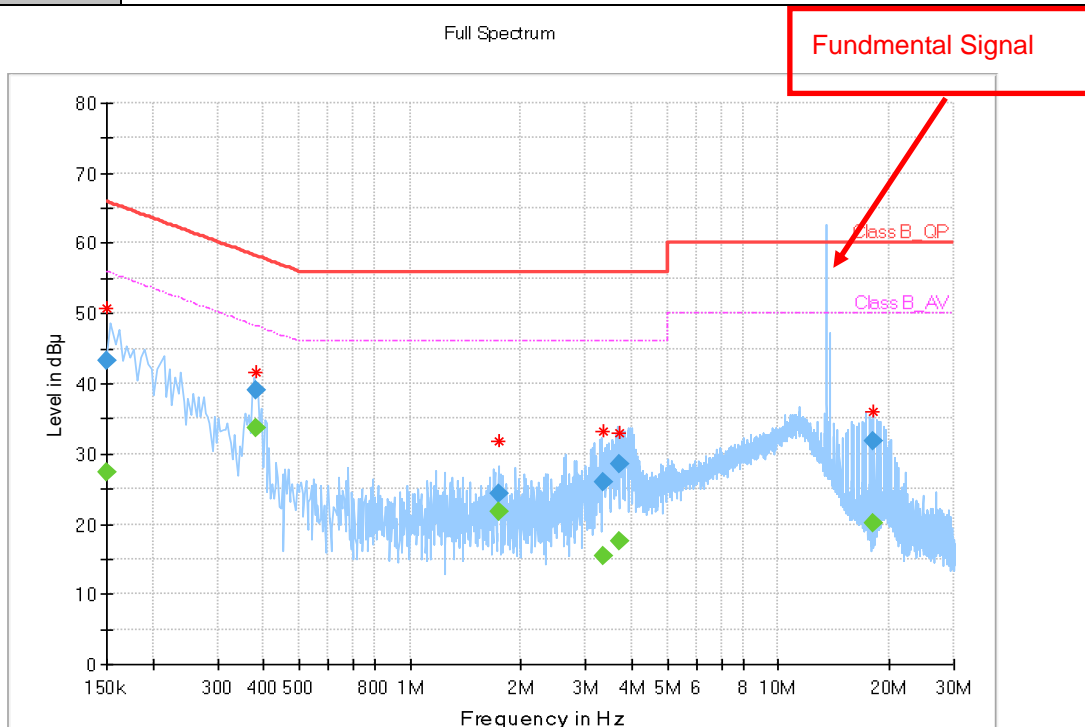

Frequency (MHz)	QuasiPeak (dB μ V)	CAverage (dB μ V)	Limit (dB μ V)	Margin (dB)	Line	Filter	Corr. (dB)
0.150000	---	27.34	56.00	28.66	N	ON	9.7
0.150000	43.17	---	66.00	22.83	N	ON	9.7
0.380000	---	33.79	48.28	14.49	N	ON	9.7
0.380000	39.00	---	58.28	19.28	N	ON	9.7
1.740000	---	21.84	46.00	24.16	N	ON	9.8
1.740000	24.44	---	56.00	31.56	N	ON	9.8
3.352000	---	15.45	46.00	30.55	N	ON	9.8
3.352000	25.98	---	56.00	30.02	N	ON	9.8
3.684000	---	17.62	46.00	28.38	N	ON	9.8
3.684000	28.60	---	56.00	27.40	N	ON	9.8
18.160000	---	20.10	50.00	29.90	N	ON	9.9
18.160000	31.91	---	60.00	28.09	N	ON	9.9

3.6 Antenna Requirements

3.6.1 Standard Applicable

Except for special regulations, the Low-power Radio-frequency Devices must not be equipped with any jacket for installing an antenna with extension cable. An intentional radiator shall be designed to ensure that no antenna other than that furnished by the responsible party shall be used with the device. The use of a permanently attached antenna or of an antenna that uses a unique coupling to the intentional radiator shall be considered sufficient to comply with the provisions of this Section. The manufacturer may design the unit so that the user can replace a broken antenna, but the use of a standard antenna jack or electrical connector is prohibited.

3.6.2 Antenna Connected Construction

An Loop Antenna design is used.

3.6.3 Antenna Gain

The antenna peak gain of EUT is less than 6 dBi.



4 List of Measuring Equipment

Equipment	Manufacturer	Model No.	Serial No.	Last Cal.	Next Cal.
3m Semi-anechoic Chamber	ETS-LINDGREN	9m*6m*6m	Euroshieldpn-CT0001143-1216	May. 19,20	May. 18,23
Bilog Antenna	ETS-LINDGREN	3143B	00161965	Mar. 05,21	Mar. 04,22
Test Software	E3	V 9.160323	N/A	N/A	N/A
10dB Attenuator	JFW/USA	50HF-010-SMA	1505	Jun. 03,21	Jun. 02,22
MXE EMI Receiver	KEYSIGHT	N9038A-544	MY54450026	Apr. 22,21	Apr. 21,22
Signal Pre-Amplifier	EMSI	EMC 9135	980249	Jun. 02,21	Jun. 01,22
Loop Antenna	SCHWARZBEC K	FMZB1519B	00173	Sep. 04,21	Sep. 05,22

- NOTE:**
1. The calibration interval of the above test instruments is 12 months or 36 months and the calibrations are traceable to CEPREI/CHINA, GRGT/CHINA and NIM/CHINA.
 2. The test was performed in 3m Chamber.
 3. The FCC Site Registration No. is 525120; The Designation No. is CN1171.

5 Uncertainty of Evaluation

Where relevant, the following measurement uncertainty levels have been estimated for tests performed on the EUT as specified in CISPR 16-4-2:

MEASUREMENT	FREQUENCY	UNCERTAINTY
Conducted emissions	9kHz~30MHz	2.42dB
Radiated emission	30MHz ~ 1GMHz	2.50dB
	1GHz ~ 18GHz	3.51dB
	18GHz ~ 40GHz	3.96dB

MEASUREMENT	UNCERTAINTY
Occupied Channel Bandwidth	±196.4Hz
RF output power, conducted	±2.31dB
Power density, conducted	±2.31dB

This uncertainty represents an expanded uncertainty expressed at approximately the 95% confidence level using a coverage factor of k=2.