



FCC RF Test Report

APPLICANT : MeiG Smart Technology Co., Ltd
EQUIPMENT : SLM757
BRAND NAME : MeiG Smart Technology Co., Ltd
MODEL NAME : SLM757A
FCC ID : 2APJ4-SLM757A
STANDARD : 47 CFR Part 2, 22(H), 24(E), 27(L), 27(H), 27(F)
CLASSIFICATION : PCS Licensed Transmitter (PCB)

The product was received on Sep. 12, 2018 and completely tested on Nov. 01, 2018. We, Sporton International (Kunshan) Inc., would like to declare that the tested sample has been evaluated in accordance with the procedures given in ANSI C63.26-2015 and shown compliance with the applicable technical standards.

The test results in this report apply exclusively to the tested model / sample. Without written approval of Sporton International (Kunshan) Inc., the test report shall not be reproduced except in full.



Approved by: James Huang / Manager

Sporton International (Kunshan) Inc.
No. 1098, Pengxi North Road, Kunshan Economic Development Zone,
Jiangsu Province 215335, China



TABLE OF CONTENTS

REVISION HISTORY3
SUMMARY OF TEST RESULT4
1 GENERAL DESCRIPTION.....5
1.1 Applicant5
1.2 Manufacturer5
1.3 Product Feature of Equipment Under Test5
1.4 Product Specification of Equipment Under Test.....6
1.5 Modification of EUT6
1.6 Maximum ERP/EIRP Power, Frequency Tolerance, and Emission Designator7
1.7 Testing Location9
1.8 Applicable Standards9
2 TEST CONFIGURATION OF EQUIPMENT UNDER TEST 10
2.1 Test Mode 10
2.2 Connection Diagram of Test System 12
2.3 Support Unit used in test configuration and system 12
2.4 Measurement Results Explanation Example 12
2.5 Frequency List of Low/Middle/High Channels 13
3 CONDUCTED TEST ITEMS 15
3.1 Measuring Instruments 15
3.2 Test Setup..... 15
3.3 Test Result of Conducted Test 15
3.4 Conducted Output Power and ERP/EIRP 16
3.5 Peak-to-Average Ratio 17
3.6 Occupied Bandwidth 18
3.7 Conducted Band Edge 19
3.8 Conducted Spurious Emission 21
3.9 Frequency Stability..... 22
4 RADIATED TEST ITEMS 23
4.1 Measuring Instruments 23
4.2 Test Setup..... 23
4.3 Test Result of Radiated Test..... 23
4.4 Radiated Spurious Emission 24
5 LIST OF MEASURING EQUIPMENT 25
6 UNCERTAINTY OF EVALUATION..... 26
APPENDIX A. TEST RESULTS OF CONDUCTED TEST
APPENDIX B. TEST RESULTS OF RADIATED TEST
APPENDIX C. TEST SETUP PHOTOGRAPHS



REVISION HISTORY

REPORT NO.	VERSION	DESCRIPTION	ISSUED DATE
FG891203B	Rev. 01	Initial issue of report	Nov. 29, 2018



SUMMARY OF TEST RESULT

Report Section	FCC Rule	Description	Limit	Result	Remark
3.4	§2.1046	Conducted Output Power	Reporting Only	PASS	-
	§22.913(a)(5)	Effective Radiated Power (Band 5)	ERP < 7 Watt	PASS	-
	§27.50(b)(10) §27.50(c)(10)	Effective Radiated Power (Band 12) (Band 13) (Band 17)	ERP < 3 Watt	PASS	-
	§24.232(c)	Equivalent Isotropic Radiated Power (Band 2)	EIRP < 2Watt	PASS	-
	§27.50(d)(4)	Equivalent Isotropic Radiated Power (Band 4)	EIRP < 1Watt	PASS	-
3.5	§24.232(d)	Peak-to-Average Ratio	<13 dB	PASS	-
3.6	§2.1049	Occupied Bandwidth	Reporting Only	PASS	-
3.7	§2.1051 §22.917(a) §24.238(a) §27.53(c)(2)(4) §27.53(g) §27.53(h)	Conducted Band Edge Measurement (Band 2) (Band 4) (Band 5) (Band 12) (Band 13) (Band 17)	< 43+10log ₁₀ (P[Watts])	PASS	-
3.8	§2.1051 §22.917(a) §24.238(a) §27.53(c)(2) §27.53(g) §27.53(h)	Conducted Spurious Emission (Band 2) (Band 4) (Band 5) (Band 12) (Band 13) (Band 17)	< 43+10log ₁₀ (P[Watts])	PASS	-
3.9	§2.1055 §22.355	Frequency Stability Temperature & Voltage	< 2.5 ppm for Part 22	PASS	-
	§2.1055 §24.235 §27.54		Within Authorized Band		
4.4	§2.1053 §22.917(a) §24.238(a) §27.53(c)(2) §27.53(f) §27.53(g) §27.53(h)	Radiated Spurious Emission (Band 2) (Band 4) (Band 5) (Band 12) (Band 13) (Band 17)	< 43+10log ₁₀ (P[Watts])	PASS	Under limit 20.92 dB at 1560.00 MHz



1 General Description

1.1 Applicant

MeiG Smart Technology Co., Ltd
3/F, No.88, Qinjiang Road, Xuhui District, Shanghai, China.

1.2 Manufacturer

MeiG Smart Technology Co., Ltd
3/F, No.88, Qinjiang Road, Xuhui District, Shanghai, China.

1.3 Product Feature of Equipment Under Test

Product Feature	
Equipment	SLM757
Brand Name	MeiG Smart Technology Co., Ltd
Model Name	SLM757A
FCC ID	2APJ4-SLM757A
EUT supports Radios application	WCDMA/HSPA/DC-HSDPA/HSPA+(16QAM uplink is not supported)/LTE
IMEI Code	Conducted: 868621028935553/868621028935561 Radiation: 868621028936312 for Band 4/5/12/13 868621028936577 for Band 2
HW Version	SLM757PA_MB_V1.01_PCB
SW Version	SLM757PQA_EQ000_2EE0.1F7D165.5C3175F_180924_100_V01_T07
EUT Stage	Production Unit



1.4 Product Specification of Equipment Under Test

Standards-related Product Specification	
Tx Frequency	LTE Band 2 : 1850.7 MHz ~ 1909.3 MHz LTE Band 4 : 1710.7 MHz ~ 1754.3 MHz LTE Band 5 : 824.7 MHz ~ 848.3 MHz LTE Band 12 : 699.7 MHz ~ 715.3 MHz LTE Band 13 : 779.5 MHz ~ 784.5 MHz LTE Band 17 : 706.5 MHz ~ 713.5 MHz
Rx Frequency	LTE Band 2 : 1930.7 MHz ~ 1989.3 MHz LTE Band 4 : 2110.7 MHz ~ 2154.3 MHz LTE Band 5 : 869.7 MHz ~ 893.3 MHz LTE Band 12 : 729.7 MHz ~ 745.3 MHz LTE Band 13 : 748.5 MHz ~ 753.5 MHz LTE Band 17 : 736.5 MHz ~ 743.5 MHz
Bandwidth	LTE Band 2 : 1.4MHz / 3MHz / 5MHz / 10MHz / 15MHz / 20MHz LTE Band 4 : 1.4MHz / 3MHz / 5MHz / 10MHz / 15MHz / 20MHz LTE Band 5 : 1.4MHz / 3MHz / 5MHz / 10MHz LTE Band 12 : 1.4MHz / 3MHz / 5MHz / 10MHz LTE Band 13 : 5MHz / 10MHz LTE Band 17 : 5MHz / 10MHz
Maximum Output Power to Antenna	LTE Band 2 : 22.67 dBm LTE Band 4 : 23.55 dBm LTE Band 5 : 22.34 dBm LTE Band 12 : 23.31 dBm LTE Band 13 : 22.83 dBm LTE Band 17 : 22.84 dBm
Antenna Gain	LTE Band 2 : -2.00 dBi LTE Band 4 : -2.00 dBi LTE Band 5 : -3.00 dBi LTE Band 12 : -3.00 dBi LTE Band 13 : -3.00 dBi LTE Band 17 : -3.00 dBi
Type of Modulation	QPSK / 16QAM

1.5 Modification of EUT

No modifications are made to the EUT during all test items.



1.6 Maximum ERP/EIRP Power, Frequency Tolerance, and Emission Designator

LTE Band 2		QPSK			16QAM		
BW (MHz)	Frequency Range (MHz)	Emission Designator (99%OBW)	Frequency Tolerance (ppm)	Maximum EIRP(W)	Emission Designator (99%OBW)	Frequency Tolerance (ppm)	Maximum EIRP(W)
1.4	1850.7 ~ 1909.3	1M10G7D	-	0.1122	1M10W7D	-	0.0908
3	1851.5 ~ 1908.5	2M73G7D	-	0.1104	2M72W7D	-	0.0881
5	1852.5 ~ 1907.5	4M50G7D	-	0.1091	4M50W7D	-	0.0889
10	1855.0 ~ 1905.0	9M07G7D	0.0034	0.1167	8M99W7D	-	0.0885
15	1857.5 ~ 1902.5	13M4G7D	-	0.1079	13M5W7D	-	0.0871
20	1860.0 ~ 1900.0	18M5G7D	-	0.1117	18M4W7D	-	0.0881
LTE Band 4		QPSK			16QAM		
BW (MHz)	Frequency Range (MHz)	Emission Designator (99%OBW)	Frequency Tolerance (ppm)	Maximum EIRP(W)	Emission Designator (99%OBW)	Frequency Tolerance (ppm)	Maximum EIRP(W)
1.4	1710.7 ~ 1754.3	1M10G7D	-	0.1422	1M10W7D	-	0.1191
3	1711.5 ~ 1753.5	2M73G7D	-	0.1416	2M73W7D	-	0.1107
5	1712.5 ~ 1752.5	4M50G7D	-	0.1406	4M51W7D	-	0.1156
10	1715.0 ~ 1750.0	9M01G7D	0.0033	0.1429	9M03W7D	-	0.1153
15	1717.5 ~ 1747.5	13M5G7D	-	0.1346	13M4W7D	-	0.1146
20	1720.0 ~ 1745.0	18M3G7D	-	0.1371	18M4W7D	-	0.1143
LTE Band 5		QPSK			16QAM		
BW (MHz)	Frequency Range (MHz)	Emission Designator (99%OBW)	Frequency Tolerance (ppm)	Maximum ERP(W)	Emission Designator (99%OBW)	Frequency Tolerance (ppm)	Maximum ERP(W)
1.4	824.7 ~ 848.3	1M10G7D	-	0.0520	1M09W7D	-	0.0423
3	825.5 ~ 847.5	2M70G7D	-	0.0519	2M73W7D	-	0.0411
5	826.5 ~ 846.5	4M50G7D	-	0.0520	4M51W7D	-	0.0395
10	829.0 ~ 844.0	9M07G7D	0.0062	0.0524	8M99W7D	-	0.0407



LTE Band 12 (Band 17)		QPSK			16QAM		
BW (MHz)	Frequency Range (MHz)	Emission Designator (99%OBW)	Frequency Tolerance (ppm)	Maximum ERP(W)	Emission Designator (99%OBW)	Frequency Tolerance (ppm)	Maximum ERP(W)
1.4	699.7 ~ 715.3	1M09G7D	-	0.0647	1M10W7D	-	0.0547
3	700.5 ~ 714.5	2M73G7D	-	0.0655	2M75W7D	-	0.0513
5	701.5 ~ 713.5	4M49G7D	-	0.0649	4M49W7D	-	0.0518
10	704.0 ~ 711.0	9M07G7D	0.0076	0.0637	9M05W7D	-	0.0513
LTE Band 13		QPSK			16QAM		
BW (MHz)	Frequency Range (MHz)	Emission Designator (99%OBW)	Frequency Tolerance (ppm)	Maximum ERP(W)	Emission Designator (99%OBW)	Frequency Tolerance (ppm)	Maximum ERP(W)
5	779.5 ~ 784.5	4M50G7D	-	0.0586	4M49W7D	-	0.0481
10	782.0	9M05G7D	0.0079	0.0585	8M99W7D	-	0.0501

Note: LTE Band 12 overlaps the entire frequency range of LTE Band 17. Therefore, the test results provided in this report covers Band 12 as well as Band 17.



1.7 Testing Location

Sporton Lab is accredited to ISO 17025 by National Voluntary Laboratory Accreditation Program (NVLAP code: 600155-0).

Test Site	Sporton International (Kunshan) Inc.		
Test Site Location	No. 1098, Pengxi North Road, Kunshan Economic Development Zone, Jiangsu Province 215335, China TEL : 86-512-57900158 FAX : 86-512-57900958		
Test Site No.	Sporton Site No.	FCC designation No.	FCC Test Firm Registration No.
	TH01-KS 03CH06-KS	CN5013	630927

1.8 Applicable Standards

According to the specifications of the manufacturer, the EUT must comply with the requirements of the following standards:

- ♦ 47 CFR Part 2, 22(H), 24(E), 27(L), 27(H), 27(F)
- ♦ ANSI C63.26-2015
- ♦ FCC KDB 971168 D01 Power Meas License Digital Systems v03r01
- ♦ FCC KDB 412172 D01 Determining ERP and EIRP v01r01

Remark:

1. All test items were verified and recorded according to the standards and without any deviation during the test.
2. This EUT has also been tested and complied with the requirements of FCC Part 15, Subpart B, recorded in a separate test report.



2 Test Configuration of Equipment Under Test

2.1 Test Mode

Antenna port conducted and radiated test items listed below are performed according to KDB 971168 D01 Power Meas License Digital Systems v03r01 with maximum output power.

Radiated measurements are performed by rotating the EUT in three different orthogonal test planes to find the maximum emission.

Test Items	Band	Bandwidth (MHz)						Modulation			RB #			Test Channel		
		1.4	3	5	10	15	20	QPSK	16QAM	64QAM	1	Half	Full	L	M	H
Max. Output Power	2	v	v	v	v	v	v	v	v	-	v	v	v	v	v	v
	4	v	v	v	v	v	v	v	v	-	v	v	v	v	v	v
	5	v	v	v	v	-	-	v	v	-	v	v	v	v	v	v
	12	v	v	v	v	-	-	v	v	-	v	v	v	v	v	v
	13	-	-	v		-	-	v	v	-	v	v	v	v	v	v
					v			v	v	-	v	v	v		v	
Peak-to-Average Ratio	2						v	v	v	-	v		v	v	v	v
	4						v	v	v	-	v		v	v	v	v
	5				v	-	-	v	v	-	v		v	v	v	v
	12				v	-	-	v	v	-	v		v	v	v	v
	13	-	-		v	-	-	v	v	-	v		v		v	
26dB and 99% Bandwidth	2	v	v	v	v	v	v	v	v	-			v	v	v	v
	4	v	v	v	v	v	v	v	v	-			v	v	v	v
	5	v	v	v	v	-	-	v	v	-			v	v	v	v
	12	v	v	v	v	-	-	v	v	-			v	v	v	v
	13	-	-	v		-	-	v	v	-			v	v	v	v
-		-		v	-	-	v	v	-			v		v		
Conducted Band Edge	2	v	v	v	v	v	v	v	v	-	v		v	v		v
	4	v	v	v	v	v	v	v	v	-	v		v	v		v
	5	v	v	v	v	-	-	v	v	-	v		v	v		v
	12	v	v	v	v	-	-	v	v	-	v		v	v		v
	13	-	-	v		-	-	v	v	-	v		v	v		v
-		-		v	-	-	v	v	-	v		v		v		
Conducted Spurious Emission	2	v	v	v	v	v	v	v	v	-	v			v	v	v
	4	v	v	v	v	v	v	v	v	-	v			v	v	v



	5	v	v	v	v	-	-	v	v	-	v			v	v	v	
	12	v	v	v	v	-	-	v	v	-	v			v	v	v	
	13	-	-	v		-	-	v	v	-	v			v	v	v	
		-	-		v	-	-	v	v	-	v				v		
Frequency Stability	2				v			v		-				v		v	
	4				v			v		-				v		v	
	5				v	-	-	v		-				v		v	
	12				v	-	-	v		-				v		v	
	13	-	-		v	-	-	v		-				v		v	
ER.P/EI.R.P	2	v	v	v	v	v	v	v	v	-	v			v	v	v	
	4	v	v	v	v	v	v	v	v	-	v			v	v	v	
	5	v	v	v	v	-	-	v	v	-	v			v	v	v	
	12	v	v	v	v	-	-	v	v	-	v			v	v	v	
	13	-	-	v		-	-	v	v	-	v				v	v	v
		-	-		v	-	-	v	v	-	v					v	
Radiated Spurious Emission	2	Worst Case											v	v	v		
	4	Worst Case											v	v	v		
	5	Worst Case											v	v	v		
	12	Worst Case											v	v	v		
	13	Worst Case											v	v	v		
Note	<p>1. The mark "v" means that this configuration is chosen for testing</p> <p>2. The mark "-" means that this bandwidth is not supported.</p> <p>3. The device is investigated from 30MHz to 10 times of fundamental signal for radiated spurious emission test under different RB size/offset and modulations in exploratory test. Subsequently, only the worst case emissions are reported.</p> <p>4. LTE Band 12 overlaps the entire frequency range of LTE Band 17. Therefore, the test results provided in this report covers Band 12 as well as Band 17.</p>																

2.2 Connection Diagram of Test System

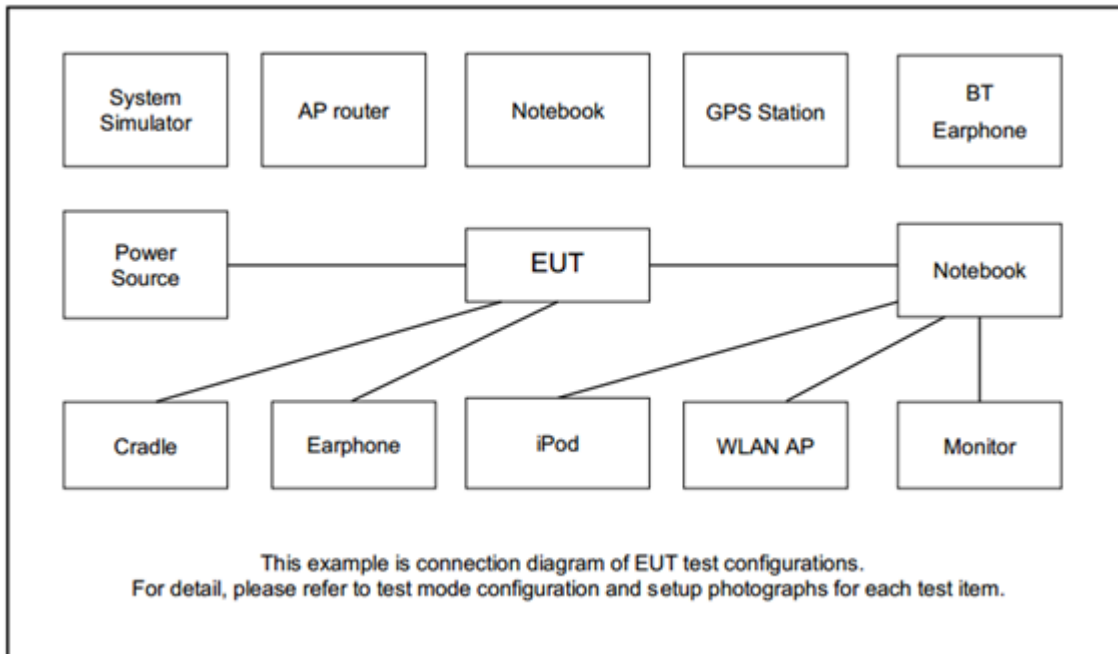

2.3 Support Unit used in test configuration and system

Item	Equipment	Trade Name	Model No.	FCC ID	Data Cable	Power Cord
1.	LTE Base Station	Anritsu	MT8820C	N/A	Unshielded, 1.8m	LTE Base Station
2.	DC Power Supply	GW INSTEK	GPS-3030D	N/A	N/A	Unshielded, 1.8m
3.	WWAN Antenna	N/A	N/A	N/A	N/A	N/A
4.	Adapter	N/A	N/A	N/A	Unshielded, 1.2m	N/A
5.	Test Jig	N/A	N/A	N/A	N/A	N/A

2.4 Measurement Results Explanation Example

For all conducted test items:

The offset level is set in the spectrum analyzer to compensate the RF cable loss between EUT conducted output port and spectrum analyzer. With the offset compensation, the spectrum analyzer reading level is exactly the EUT RF output level.

The spectrum analyzer offset is derived from RF cable loss.

$Offset = RF\ cable\ loss.$

Following shows an offset computation example with cable loss 5.3 dB.

Example :

$Offset(dB) = RF\ cable\ loss(dB).$
= 5.3 (dB)



2.5 Frequency List of Low/Middle/High Channels

LTE Band 2 Channel and Frequency List				
BW [MHz]	Channel/Frequency(MHz)	Lowest	Middle	Highest
20	Channel	18700	18900	19100
	Frequency	1860	1880	1900
15	Channel	18675	18900	19125
	Frequency	1857.5	1880	1902.5
10	Channel	18650	18900	19150
	Frequency	1855	1880	1905
5	Channel	18625	18900	19175
	Frequency	1852.5	1880	1907.5
3	Channel	18615	18900	19185
	Frequency	1851.5	1880	1908.5
1.4	Channel	18607	18900	19193
	Frequency	1850.7	1880	1909.3

LTE Band 4 Channel and Frequency List				
BW [MHz]	Channel/Frequency(MHz)	Lowest	Middle	Highest
20	Channel	20050	20175	20300
	Frequency	1720	1732.5	1745
15	Channel	20025	20175	20325
	Frequency	1717.5	1732.5	1747.5
10	Channel	20000	20175	20350
	Frequency	1715	1732.5	1750
5	Channel	19975	20175	20375
	Frequency	1712.5	1732.5	1752.5
3	Channel	19965	20175	20385
	Frequency	1711.5	1732.5	1753.5
1.4	Channel	19957	20175	20393
	Frequency	1710.7	1732.5	1754.3



LTE Band 5 Channel and Frequency List				
BW [MHz]	Channel/Frequency(MHz)	Lowest	Middle	Highest
10	Channel	20450	20525	20600
	Frequency	829	836.5	844
5	Channel	20425	20525	20625
	Frequency	826.5	836.5	846.5
3	Channel	20415	20525	20635
	Frequency	825.5	836.5	847.5
1.4	Channel	20407	20525	20643
	Frequency	824.7	836.5	848.3

LTE Band 12 Channel and Frequency List				
BW [MHz]	Channel/Frequency(MHz)	Lowest	Middle	Highest
10	Channel	23060	23095	23130
	Frequency	704	707.5	711
5	Channel	23035	23095	23155
	Frequency	701.5	707.5	713.5
3	Channel	23025	23095	23165
	Frequency	700.5	707.5	714.5
1.4	Channel	23017	23095	23173
	Frequency	699.7	707.5	715.3

LTE Band 13 Channel and Frequency List				
BW [MHz]	Channel/Frequency(MHz)	Lowest	Middle	Highest
10	Channel	-	23230	-
	Frequency	-	782	-
5	Channel	23205	23230	23255
	Frequency	779.5	782	784.5

LTE Band 17 Channel and Frequency List				
BW [MHz]	Channel/Frequency(MHz)	Lowest	Middle	Highest
10	Channel	23780	23790	23800
	Frequency	709	710	711
5	Channel	23755	23790	23825
	Frequency	706.5	710	713.5

3 Conducted Test Items

3.1 Measuring Instruments

See list of measuring instruments of this test report.

3.2 Test Setup

3.2.1 Conducted Output Power

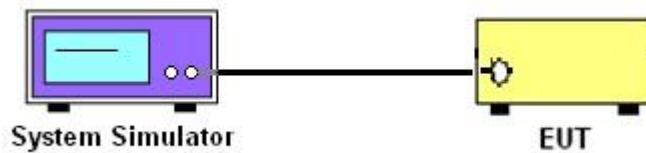

3.2.2 Peak-to-Average Ratio, Occupied Bandwidth ,Conducted Band-Edge and Conducted Spurious Emission



3.2.3 Frequency Stability

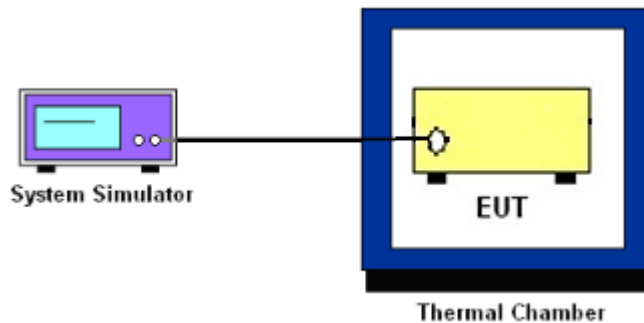

3.3 Test Result of Conducted Test

Please refer to Appendix A.



3.4 Conducted Output Power and ERP/EIRP

3.4.1 Description of the Conducted Output Power Measurement and ERP/EIRP Measurement

A system simulator was used to establish communication with the EUT. Its parameters were set to force the EUT transmitting at maximum output power. The measured power in the radio frequency on the transmitter output terminals shall be reported.

The ERP of mobile transmitters must not exceed 7 Watts for LTE Band 5.

The ERP of mobile transmitters must not exceed 3 Watts for LTE Band 12, Band 13 and Band 17

The EIRP of mobile transmitters must not exceed 2 Watts for LTE Band 2.

The EIRP of mobile transmitters must not exceed 1 Watts for LTE Band 4.

According to KDB 412172 D01 Power Approach,

$EIRP = P_T + G_T - L_C$, $ERP = EIRP - 2.15$, where

P_T = transmitter output power in dBm

G_T = gain of the transmitting antenna in dBi

L_C = signal attenuation in the connecting cable between the transmitter and antenna in dB

3.4.2 Test Procedures

1. The testing follows ANSI C63.26 Section 5.2
2. The transmitter output port was connected to the system simulator.
3. Set EUT at maximum power through the system simulator.
4. Select lowest, middle, and highest channels for each band and different modulation.
5. Measure and record the power level from the system simulator.



3.5 Peak-to-Average Ratio

3.5.1 Description of the PAR Measurement

Power Complementary Cumulative Distribution Function (CCDF) curves provide a means for characterizing the power peaks of a digitally modulated signal on a statistical basis. A CCDF curve depicts the probability of the peak signal amplitude exceeding the average power level. Most contemporary measurement instrumentation include the capability to produce CCDF curves for an input signal provided that the instrument's resolution bandwidth can be set wide enough to accommodate the entire input signal bandwidth. In measuring transmissions in this band using an average power technique, the peak-to-average ratio (PAR) of the transmission may not exceed 13 dB.

3.5.2 Test Procedures

1. The testing follows ANSI C63.26 Section 5.2.3.4 (CCDF).
2. The EUT was connected to spectrum and system simulator via a power divider.
3. Set the CCDF (Complementary Cumulative Distribution Function) option in spectrum analyzer.
4. The highest RF powers were measured and recorded the maximum PAPR level associated with a probability of 0.1 %.
5. Record the deviation as Peak to Average Ratio.



3.6 Occupied Bandwidth

3.6.1 Description of Occupied Bandwidth Measurement

The occupied bandwidth is the width of a frequency band such that, below the lower and above the upper frequency limits, the mean powers emitted are each equal to a specified percentage 0.5% of the total mean transmitted power.

The 26 dB emission bandwidth is defined as the frequency range between two points, one above and one below the carrier frequency, at which the spectral density of the emission is attenuated 26 dB below the maximum in-band spectral density of the modulated signal. Spectral density (power per unit bandwidth) is to be measured with a detector of resolution bandwidth equal to approximately 1.0% of the emission bandwidth.

3.6.2 Test Procedures

1. The testing follows ANSI C63.26 Section 5.4
2. The EUT was connected to spectrum analyzer and system simulator via a power divider.
3. The spectrum analyzer center frequency is set to the nominal EUT channel center frequency. The span range for the spectrum analyzer shall be between two and five times the anticipated OBW.
4. The nominal resolution bandwidth (RBW) shall be in the range of 1 to 5 % of the anticipated OBW, and the VBW shall be at least 3 times the RBW.
5. Set the detection mode to peak, and the trace mode to max hold.
6. Determine the reference value: Set the EUT to transmit a modulated signal. Allow the trace to stabilize. Set the spectrum analyzer marker to the highest level of the displayed trace.
(this is the reference value)
7. Determine the “-26 dB down amplitude” as equal to (Reference Value – X).
8. Place two markers, one at the lowest and the other at the highest frequency of the envelope of the spectral display such that each marker is at or slightly below the “-X dB down amplitude” determined in step 6. If a marker is below this “-X dB down amplitude” value it shall be placed as close as possible to this value. The OBW is the positive frequency difference between the two markers.
9. Use the 99 % power bandwidth function of the spectrum analyzer and report the measured bandwidth.



3.7 Conducted Band Edge

3.7.1 Description of Conducted Band Edge Measurement

22.917(a)

For operations in the 824 – 849 MHz band, the FCC limit is $43 + 10\log_{10}(P[\text{Watts}])$ dB below the transmitter power $P(\text{Watts})$ in a 100kHz bandwidth. However, in the 1MHz bands immediately outside and adjacent to the licensee's frequency block, a resolution bandwidth of at least one percent of the emission bandwidth of the fundamental emission of the transmitter may be employed.

24.238 (a)

For operations in the 1850-1910 and 1930-1990 MHz band, the FCC limit is $43 + 10\log_{10}(P[\text{Watts}])$ dB below the transmitter power $P(\text{Watts})$ in a 1MHz bandwidth. However, in the 1 MHz bands immediately outside and adjacent to the frequency block a resolution bandwidth of at least one percent of the emission bandwidth of the fundamental emission of the transmitter may be employed.

27.53 (c)

For operations in the 776-788 MHz band, the FCC limit is $43 + 10\log_{10}(P[\text{Watts}])$ dB below the transmitter power $P(\text{Watts})$ in a 100 kHz bandwidth. However, in the 100 kHz bands immediately outside and adjacent to the frequency block, a resolution bandwidth of at least 30 kHz may be employed. In addition, the power of any unwanted emissions in any 6.25 kHz bandwidth for all frequencies between 763-775 MHz and 793-806 MHz shall be attenuated below the transmitter power, P (dBW), by at least $65 + 10 \log_{10} p(\text{watts})$, dB, for mobile and portable equipment.

27.53 (g)

For operations in the 600MHz band and 698 -746 MHz band, the FCC limit is $43 + 10\log_{10}(P[\text{Watts}])$ dB below the transmitter power $P(\text{Watts})$ in a 100 kHz bandwidth. However, in the 100 kilohertz bands immediately outside and adjacent to a licensee's frequency block, a resolution bandwidth of at least 30 kHz may be employed.

27.53 (h)

For operations in the 1710 – 1755 MHz band, the FCC limit is $43 + 10\log_{10}(P[\text{Watts}])$ dB below the transmitter power $P(\text{Watts})$ in a 1 MHz bandwidth. However, in the 1MHz bands immediately outside and adjacent to the licensee's frequency block, a resolution bandwidth of at least one percent of the emission bandwidth of the fundamental emission of the transmitter may be employed.



3.7.2 Test Procedures

1. The testing follows ANSI C63.26 section 5.7
2. The EUT was connected to spectrum analyzer and system simulator via a power divider.
3. The band edges of low and high channels for the highest RF powers were measured.
4. Set RBW \geq 1% EBW in the 1MHz band immediately outside and adjacent to the band edge.
5. Beyond the 1 MHz band from the band edge, RBW=1MHz was used or a narrower RBW was used and the measured power was integrated over the full required measurement bandwidth of 1 MHz.
6. Set spectrum analyzer with RMS detector.
7. The RF fundamental frequency should be excluded against the limit line in the operating frequency band.
8. Checked that all the results comply with the emission limit line.

Example:

The limit line is derived from $43 + 10\log(P)$ dB below the transmitter power P(Watts)

$$= P(W) - [43 + 10\log(P)] \text{ (dB)}$$

$$= [30 + 10\log(P)] \text{ (dBm)} - [43 + 10\log(P)] \text{ (dB)} = -13\text{dBm.}$$



3.8 Conducted Spurious Emission

3.8.1 Description of Conducted Spurious Emission Measurement

The power of any emission outside of the authorized operating frequency ranges must be lower than the transmitter power (P) by a factor of at least $43 + 10 \log (P)$ dB.

It is measured by means of a calibrated spectrum analyzer and scanned from 30 MHz up to a frequency including its 10th harmonic.

3.8.2 Test Procedures

1. The testing follows ANSI C63.26 section 5.7
2. The EUT was connected to spectrum analyzer and system simulator via a power divider.
3. The RF output of EUT was connected to the spectrum analyzer by RF cable and attenuator. The path loss was compensated to the results for each measurement.
4. The middle channel for the highest RF power within the transmitting frequency was measured.
5. The conducted spurious emission for the whole frequency range was taken.
6. Make the measurement with the spectrum analyzer's RBW = 1MHz, VBW = 3MHz.
7. Set spectrum analyzer with RMS detector.
8. Taking the record of maximum spurious emission.
9. The RF fundamental frequency should be excluded against the limit line in the operating frequency band.
10. The limit line is derived from $43 + 10\log(P)$ dB below the transmitter power P(Watts)
= $P(W) - [43 + 10\log(P)]$ (dB)
= $[30 + 10\log(P)]$ (dBm) - $[43 + 10\log(P)]$ (dB)
= -13dBm.



3.9 Frequency Stability

3.9.1 Description of Frequency Stability Measurement

The frequency stability shall be measured by variation of ambient temperature and variation of primary supply voltage to ensure that the fundamental emission stays within the authorized frequency block. The frequency stability of the transmitter shall be maintained within $\pm 0.00025\%$ ($\pm 2.5\text{ppm}$) of the center frequency.

3.9.2 Test Procedures for Temperature Variation

1. The testing follows ANSI C63.26 section 5.6.4
2. The EUT was set up in the thermal chamber and connected with the system simulator.
3. With power OFF, the temperature was decreased to -30°C and the EUT was stabilized before testing. Power was applied and the maximum change in frequency was recorded within one minute.
4. With power OFF, the temperature was raised in 10°C step up to 50°C . The EUT was stabilized at each step for at least half an hour. Power was applied and the maximum frequency change was recorded within one minute.

3.9.3 Test Procedures for Voltage Variation

1. The testing follows ANSI C63.26 section 5.6.5
2. The EUT was placed in a temperature chamber at $20\pm 5^{\circ}\text{C}$ and connected with the system simulator.
3. The power supply voltage to the EUT was varied from 85% to 115% of the nominal value for other than hand carried battery equipment.
4. For hand carried, battery powered equipment, reduce the primary ac or dc supply voltage to the battery operating end point, which shall be specified by the manufacturer.
5. The variation in frequency was measured for the worst case.

4 Radiated Test Items

4.1 Measuring Instruments

See list of measuring instruments of this test report.

4.2 Test Setup

4.2.1 For radiated test from 30MHz to 1GHz

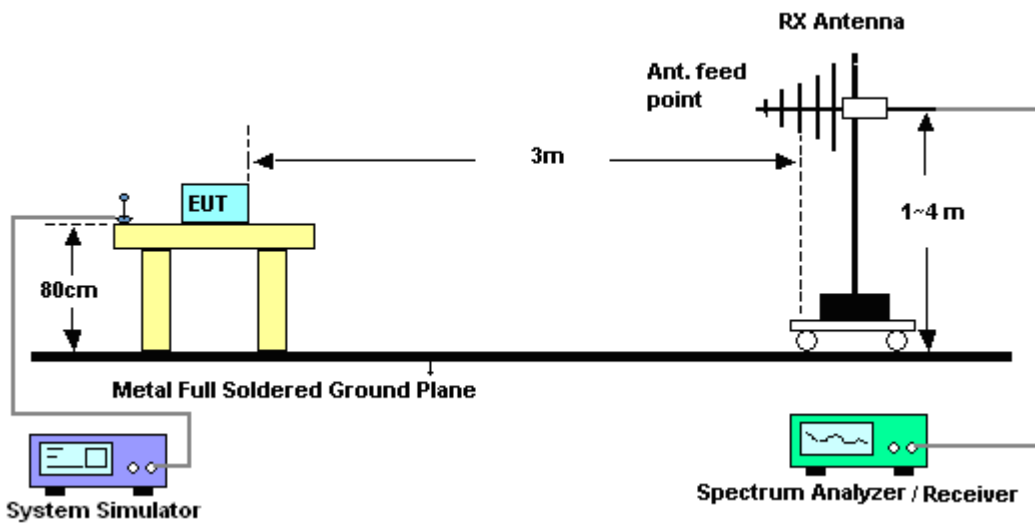

4.2.2 For radiated test above 1GHz

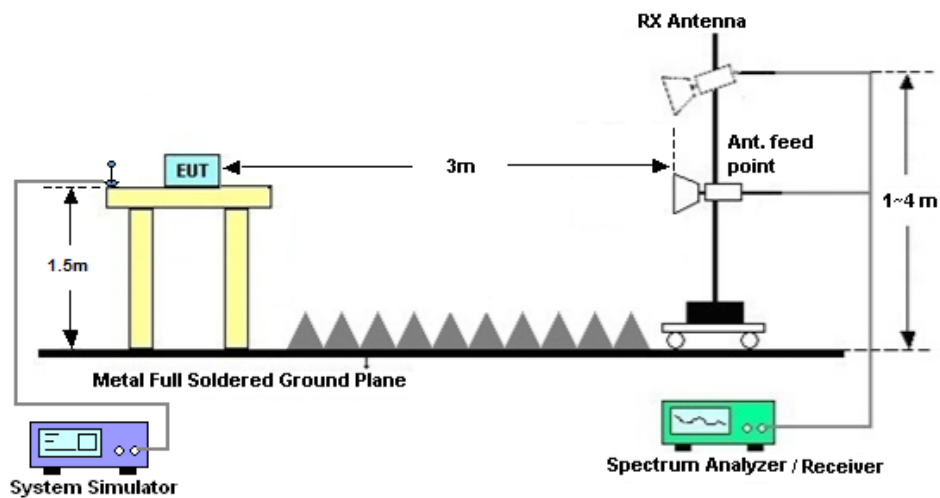

4.3 Test Result of Radiated Test

Please refer to Appendix B.



4.4 Radiated Spurious Emission

4.4.1 Description of Radiated Spurious Emission

The radiated spurious emission was measured by substitution method according to ANSI C63.26. The power of any emission outside of the authorized operating frequency ranges must be attenuated below the transmitter power (P) by a factor of at least $43 + 10 \log (P)$ dB.

For LTE Band 13

For operations in the 746-758 MHz, 775-788 MHz, and 805-806 MHz bands, emissions in the band 1559-1610 MHz shall be limited to -70 dBW/MHz equivalent isotropically radiated power (EIRP) for wideband signals, and -80 dBW EIRP for discrete emissions of less than 700 Hz bandwidth.

The spectrum is scanned from 30 MHz up to a frequency including its 10th harmonic.

4.4.2 Test Procedures

1. The testing follows ANSI C63.26 Section 5.5
2. The EUT was placed on a turntable with 0.8 meter height for frequency below 1GHz and 1.5 meter height for frequency above 1GHz respectively above ground.
3. The EUT was set 3 meters from the receiving antenna mounted on the antenna tower.
4. The table was rotated 360 degrees to determine the position of the highest spurious emission.
5. The height of the receiving antenna is varied between 1m to 4m to search the maximum spurious emission for both horizontal and vertical polarizations.
6. During the measurement, the system simulator parameters were set to force the EUT transmitting at maximum output power.
7. Make the measurement with the spectrum analyzer's RBW = 1MHz, VBW = 3MHz, taking the record of maximum spurious emission.
8. A horn antenna was substituted in place of the EUT and was driven by a signal generator.
9. Tune the output power of signal generator to the same emission level with EUT maximum spurious emission.
10. $EIRP \text{ (dBm)} = S.G. \text{ Power} - Tx \text{ Cable Loss} + Tx \text{ Antenna Gain}$
11. $ERP \text{ (dBm)} = EIRP - 2.15$
12. The RF fundamental frequency should be excluded against the limit line in the operating frequency band.

The limit line is derived from $43 + 10\log(P)$ dB below the transmitter power P(Watts)
 $= P(W) - [43 + 10\log(P)] \text{ (dB)}$
 $= [30 + 10\log(P)] \text{ (dBm)} - [43 + 10\log(P)] \text{ (dB)}$
 $= -13\text{dBm}.$



5 List of Measuring Equipment

Instrument	Manufacturer	Model No.	Serial No.	Characteristics	Calibration Date	Test Date	Due Date	Remark
Spectrum Analyzer	R&S	FSV40	101040	10Hz~40GHz	Aug. 07, 2018	Oct. 29, 2018~Nov. 01, 2018	Aug. 06, 2019	Conducted (TH01-KS)
Temperature & humidity chamber	Hongzhan	LP-150U	H2014011440	-40~+150°C 20%~95%RH	Jun. 27, 2018	Oct. 29, 2018~Nov. 01, 2018	Jun. 26, 2019	Conducted (TH01-KS)
EXA Spectrum Analyzer	Keysight	N9010B	MY57471084	10Hz-44GHz	Jun. 25, 2018	Oct. 31, 2018	Jun. 24, 2019	Radiation (03CH06-KS)
Bilog Antenna	TeseQ	CBL6111D	44483	30MHz-1GHz	Jan. 29, 2018	Oct. 31, 2018	Jan. 28, 2019	Radiation (03CH06-KS)
Double Ridge Horn Antenna	ETS-Lindgren	3117	75957	1GHz~18GHz	Oct. 20, 2018	Oct. 31, 2018	Oct. 19, 2019	Radiation (03CH06-KS)
SHF- EHF Horn	Schw arzbeck	BBHA 9170	BBHA 170249	15GHz~40GHz	Feb. 07, 2018	Oct. 31, 2018	Feb. 06, 2019	Radiation (03CH06-KS)
Amplifier	SONOMA	310N	187289	9KHz ~1GHZ	Aug. 06, 2018	Oct. 31, 2018	Aug. 05, 2019	Radiation (03CH06-KS)
Amplifier	MITEQ	TTA 1840-35-HG	2014749	18~40GHz	Feb. 08, 2018	Oct. 31, 2018	Feb. 07, 2019	Radiation (03CH06-KS)
high gain Amplifier	MITEQ	AMF-7D-00 101800-30-1 0P	2025788	1Ghz-18Ghz	Apr. 17, 2018	Oct. 31, 2018	Apr. 16, 2019	Radiation (03CH06-KS)
Amplifier	Keysight	83017A	MY53270203	500MHz~26.5GHz	Dec. 16, 2017	Oct. 31, 2018	Dec. 15, 2018	Radiation (03CH06-KS)
AC Power Source	Chroma	61601	F104090004	N/A	NCR	Oct. 31, 2018	NCR	Radiation (03CH06-KS)
Turn Table	ChamPro	EM 1000-T	060762-T	0~360 degree	NCR	Oct. 31, 2018	NCR	Radiation (03CH06-KS)
Antenna Mast	ChamPro	EM 1000-A	060762-A	1 m-4 m	NCR	Oct. 31, 2018	NCR	Radiation (03CH06-KS)

NCR: No Calibration Required



6 Uncertainty of Evaluation

Uncertainty of Radiated Emission Measurement (30 MHz ~ 1000 MHz)

Measuring Uncertainty for a Level of Confidence of 95% (U = 2Uc(y))	2.5dB
---	-------

Uncertainty of Radiated Emission Measurement (1 GHz ~ 18 GHz)

Measuring Uncertainty for a Level of Confidence of 95% (U = 2Uc(y))	2.0dB
---	-------

Uncertainty of Radiated Emission Measurement (18 GHz ~ 40 GHz)

Measuring Uncertainty for a Level of Confidence of 95% (U = 2Uc(y))	2.0dB
---	-------



Appendix A. Test Results of Conducted Test

Conducted Output Power(Average power)

LTE Band 2 Maximum Average Power [dBm]						
BW [MHz]	RB Size	RB Offset	Mod	Lowest	Middle	Highest
20	1	0	QPSK	22.03	22.02	21.97
20	1	49		22.48	22.39	22.28
20	1	99		21.86	22.10	22.19
20	50	0		21.16	21.25	21.26
20	50	24		21.15	21.23	21.30
20	50	50		21.11	21.21	21.20
20	100	0		21.20	21.27	21.17
20	1	0	16-QAM	20.80	20.47	20.78
20	1	49		21.45	20.89	21.07
20	1	99		21.12	20.74	20.89
20	50	0		20.23	20.42	20.30
20	50	24		20.21	20.48	20.21
20	50	50		20.18	20.41	20.29
20	100	0		20.25	20.18	20.24
15	1	0	QPSK	22.31	22.04	22.20
15	1	37		22.33	22.33	22.29
15	1	74		22.12	22.33	21.96
15	36	0		21.16	21.29	21.28
15	36	20		21.21	21.31	21.28
15	36	39		21.16	21.26	21.19
15	75	0		21.19	21.27	21.27
15	1	0	16-QAM	20.93	20.44	21.32
15	1	37		21.07	20.99	21.40
15	1	74		20.69	20.87	20.33
15	36	0		20.23	20.17	20.25
15	36	20		20.27	20.31	20.35
15	36	39		20.13	20.26	20.28
15	75	0		20.35	20.24	20.16



LTE Band 2 Maximum Average Power [dBm]						
BW [MHz]	RB Size	RB Offset	Mod	Lowest	Middle	Highest
10	1	0	QPSK	22.16	22.00	22.09
10	1	25		22.48	22.67	22.22
10	1	49		21.98	22.05	21.96
10	25	0		21.27	21.28	21.31
10	25	12		21.25	21.30	21.40
10	25	25		21.15	21.22	21.23
10	50	0		21.16	21.29	21.31
10	1	0	16-QAM	20.98	20.53	20.91
10	1	25		21.44	20.80	21.47
10	1	49		20.85	20.94	20.72
10	25	0		20.25	20.09	20.39
10	25	12		20.27	20.31	20.13
10	25	25		20.42	20.29	20.25
10	50	0		20.14	20.27	20.40
5	1	0	QPSK	22.24	21.98	22.05
5	1	12		22.38	22.19	22.11
5	1	24		22.16	22.19	21.94
5	12	0		21.28	21.24	21.25
5	12	7		21.30	21.32	21.20
5	12	13		21.27	21.25	21.18
5	25	0		21.26	21.28	21.21
5	1	0	16-QAM	21.39	21.21	21.48
5	1	12		21.49	20.92	21.45
5	1	24		21.10	20.70	20.91
5	12	0		20.39	20.24	20.09
5	12	7		20.28	20.32	20.24
5	12	13		20.33	20.24	20.29
5	25	0		20.33	20.36	20.23



LTE Band 2 Maximum Average Power [dBm]						
BW [MHz]	RB Size	RB Offset	Mod	Lowest	Middle	Highest
3	1	0	QPSK	22.28	22.42	22.18
3	1	8		22.24	22.43	22.07
3	1	14		22.43	22.36	22.00
3	8	0		21.29	21.33	21.28
3	8	4		21.31	21.33	21.23
3	8	7		21.28	21.27	21.25
3	15	0		21.29	21.30	21.21
3	1	0	16-QAM	20.73	20.74	21.45
3	1	8		21.06	20.72	20.99
3	1	14		21.37	21.16	20.88
3	8	0		20.35	20.37	20.25
3	8	4		20.44	20.47	20.12
3	8	7		20.22	20.40	20.15
3	15	0		20.45	20.41	20.26
1.4	1	0	QPSK	22.38	22.41	22.27
1.4	1	3		22.34	22.43	22.29
1.4	1	5		22.36	22.34	22.20
1.4	3	0		22.47	22.41	22.38
1.4	3	1		22.50	22.47	22.41
1.4	3	3		22.47	22.38	22.39
1.4	6	0		21.27	21.29	21.20
1.4	1	0	16-QAM	20.80	21.55	20.80
1.4	1	3		21.19	21.05	21.08
1.4	1	5		21.58	21.13	20.71
1.4	3	0		21.28	21.26	20.92
1.4	3	1		21.53	21.46	20.96
1.4	3	3		21.55	21.31	21.19
1.4	6	0		20.33	20.34	20.26



LTE Band 4 Maximum Average Power [dBm]						
BW [MHz]	RB Size	RB Offset	Mod	Lowest	Middle	Highest
20	1	0	QPSK	23.18	23.13	23.31
20	1	49		23.00	23.37	23.16
20	1	99		22.87	23.13	23.02
20	50	0		22.41	22.35	22.48
20	50	24		22.25	22.40	22.14
20	50	50		22.23	22.32	22.21
20	100	0		22.39	22.36	22.33
20	1	0	16-QAM	22.58	21.99	22.52
20	1	49		22.14	22.02	22.49
20	1	99		21.85	21.69	21.91
20	50	0		21.28	21.23	21.56
20	50	24		21.24	21.19	21.24
20	50	50		21.21	21.39	21.31
20	100	0		21.25	21.42	21.23
15	1	0	QPSK	23.27	23.03	23.09
15	1	37		22.98	23.29	23.11
15	1	74		23.22	22.97	23.12
15	36	0		22.30	22.25	22.33
15	36	20		22.25	22.37	22.28
15	36	39		22.24	22.38	22.25
15	75	0		22.29	22.35	22.30
15	1	0	16-QAM	22.00	21.93	21.93
15	1	37		22.10	22.59	21.99
15	1	74		21.60	22.30	21.93
15	36	0		21.26	21.21	21.25
15	36	20		21.32	21.25	21.29
15	36	39		21.20	21.35	21.25
15	75	0		21.18	21.31	21.29



LTE Band 4 Maximum Average Power [dBm]						
BW [MHz]	RB Size	RB Offset	Mod	Lowest	Middle	Highest
10	1	0	QPSK	23.32	23.17	23.16
10	1	25		23.10	23.55	23.06
10	1	49		22.99	23.39	23.17
10	25	0		22.36	22.32	22.31
10	25	12		22.40	22.37	22.38
10	25	25		22.19	22.38	22.32
10	50	0		22.26	22.36	22.32
10	1	0	16-QAM	22.62	21.67	21.73
10	1	25		22.52	22.01	21.82
10	1	49		21.73	22.38	22.02
10	25	0		21.32	21.30	21.32
10	25	12		21.30	21.35	21.32
10	25	25		21.16	21.33	21.41
10	50	0		21.34	21.32	21.34
5	1	0	QPSK	23.36	23.35	23.24
5	1	12		23.15	23.33	23.16
5	1	24		23.12	23.35	23.48
5	12	0		22.36	22.36	22.27
5	12	7		22.28	22.28	22.22
5	12	13		22.35	22.31	22.34
5	25	0		22.34	22.33	22.33
5	1	0	16-QAM	22.49	21.86	21.92
5	1	12		22.16	22.49	22.01
5	1	24		22.23	22.41	22.63
5	12	0		21.52	21.43	21.18
5	12	7		21.46	21.07	21.14
5	12	13		21.22	21.09	21.43
5	25	0		21.31	21.30	21.19



LTE Band 4 Maximum Average Power [dBm]						
BW [MHz]	RB Size	RB Offset	Mod	Lowest	Middle	Highest
3	1	0	QPSK	23.33	23.51	23.03
3	1	8		23.12	23.31	23.01
3	1	14		23.23	23.30	23.18
3	8	0		22.36	22.39	22.36
3	8	4		22.39	22.30	22.37
3	8	7		22.35	22.38	22.34
3	15	0		22.35	22.35	22.25
3	1	0	16-QAM	22.07	22.10	22.17
3	1	8		22.43	21.80	22.06
3	1	14		22.44	21.85	22.15
3	8	0		21.35	21.44	21.15
3	8	4		21.39	21.42	21.33
3	8	7		21.36	21.40	21.29
3	15	0		21.25	21.36	21.35
1.4	1	0	QPSK	23.28	23.35	23.22
1.4	1	3		23.33	23.42	23.41
1.4	1	5		23.27	23.36	23.24
1.4	3	0		23.47	23.53	23.25
1.4	3	1		23.50	23.51	23.30
1.4	3	3		23.45	23.38	23.36
1.4	6	0		22.36	22.36	22.33
1.4	1	0	16-QAM	22.56	22.00	22.46
1.4	1	3		22.65	22.24	22.61
1.4	1	5		22.48	22.14	22.56
1.4	3	0		22.76	22.39	22.45
1.4	3	1		22.57	22.43	22.65
1.4	3	3		22.56	22.21	22.46
1.4	6	0		21.49	21.12	21.46



LTE Band 5 Maximum Average Power [dBm]						
BW [MHz]	RB Size	RB Offset	Mod	Lowest	Middle	Highest
10	1	0	QPSK	22.06	21.84	21.93
10	1	25		21.77	22.34	21.97
10	1	49		21.88	22.16	21.93
10	25	0		21.08	21.09	21.16
10	25	12		21.06	21.26	21.06
10	25	25		20.99	21.19	21.11
10	50	0		21.02	21.23	21.04
10	1	0	16-QAM	20.51	20.58	21.22
10	1	25		20.50	20.82	20.93
10	1	49		20.61	21.25	20.69
10	25	0		20.10	20.13	20.28
10	25	12		20.00	20.29	20.17
10	25	25		20.09	20.22	20.14
10	50	0		19.94	20.27	20.07
5	1	0	QPSK	22.27	22.02	22.11
5	1	12		22.25	22.31	21.96
5	1	24		21.85	22.02	22.09
5	12	0		21.22	21.16	21.13
5	12	7		21.16	21.24	21.11
5	12	13		21.05	21.19	21.14
5	25	0		21.24	21.20	21.14
5	1	0	16-QAM	20.48	21.12	20.64
5	1	12		20.84	20.86	20.88
5	1	24		20.65	20.46	20.58
5	12	0		20.16	20.22	20.08
5	12	7		20.11	20.30	20.15
5	12	13		20.08	20.35	20.20
5	25	0		20.16	20.36	20.12



LTE Band 5 Maximum Average Power [dBm]						
BW [MHz]	RB Size	RB Offset	Mod	Lowest	Middle	Highest
3	1	0	QPSK	22.07	22.24	22.23
3	1	8		22.05	22.17	22.04
3	1	14		22.08	22.30	22.12
3	8	0		21.26	21.28	21.09
3	8	4		21.21	21.27	21.17
3	8	7		21.09	21.31	21.17
3	15	0		21.25	21.26	21.25
3	1	0	16-QAM	20.53	21.25	21.21
3	1	8		20.59	21.29	20.83
3	1	14		21.20	21.20	21.20
3	8	0		20.01	20.28	19.97
3	8	4		20.11	20.46	20.19
3	8	7		20.17	20.47	20.19
3	15	0		20.29	20.33	20.22
1.4	1	0	QPSK	22.12	22.19	22.03
1.4	1	3		22.18	22.28	22.12
1.4	1	5		22.02	22.16	21.93
1.4	3	0		22.11	22.29	22.18
1.4	3	1		22.18	22.28	22.30
1.4	3	3		22.11	22.31	22.24
1.4	6	0		21.07	21.14	21.11
1.4	1	0	16-QAM	21.34	20.88	20.71
1.4	1	3		21.41	20.79	20.92
1.4	1	5		21.24	20.66	20.72
1.4	3	0		21.14	21.25	20.90
1.4	3	1		21.18	21.36	21.09
1.4	3	3		21.14	21.16	20.75
1.4	6	0		19.97	20.27	19.95



LTE Band 12 Maximum Average Power [dBm]						
BW [MHz]	RB Size	RB Offset	Mod	Lowest	Middle	Highest
10	1	0	QPSK	22.90	22.87	22.72
10	1	25		22.69	22.92	23.19
10	1	49		22.87	22.84	22.82
10	25	0		21.88	21.90	22.05
10	25	12		21.90	22.02	22.11
10	25	25		21.97	22.11	22.01
10	50	0		21.93	22.06	22.04
10	1	0	16-QAM	22.25	21.57	21.86
10	1	25		21.78	21.83	22.23
10	1	49		21.80	21.51	21.73
10	25	0		20.89	20.83	21.00
10	25	12		20.92	20.90	21.16
10	25	25		21.00	21.16	21.05
10	50	0		20.85	21.12	21.09
5	1	0	QPSK	23.15	22.94	22.76
5	1	12		22.82	23.27	23.12
5	1	24		22.72	22.90	22.72
5	12	0		22.12	21.98	22.00
5	12	7		21.96	22.17	22.03
5	12	13		21.90	22.15	21.97
5	25	0		22.01	22.08	22.01
5	1	0	16-QAM	22.29	21.80	21.41
5	1	12		21.66	21.82	21.51
5	1	24		21.47	21.68	21.67
5	12	0		21.07	20.85	21.06
5	12	7		21.00	20.86	20.87
5	12	13		20.77	20.95	20.87
5	25	0		20.87	21.07	20.98



LTE Band 12 Maximum Average Power [dBm]						
BW [MHz]	RB Size	RB Offset	Mod	Lowest	Middle	Highest
3	1	0	QPSK	23.31	23.25	22.87
3	1	8		23.11	23.14	22.77
3	1	14		22.67	23.07	22.97
3	8	0		22.14	21.98	22.32
3	8	4		22.11	22.06	22.11
3	8	7		21.93	22.20	22.03
3	15	0		22.08	22.13	22.13
3	1	0	16-QAM	22.25	22.12	21.51
3	1	8		21.52	22.08	21.49
3	1	14		21.47	22.23	21.74
3	8	0		21.04	20.82	21.10
3	8	4		21.00	20.85	21.16
3	8	7		21.02	20.74	21.08
3	15	0		21.14	21.13	21.14
1.4	1	0	QPSK	23.12	22.93	22.83
1.4	1	3		23.12	23.09	23.03
1.4	1	5		23.08	22.64	23.01
1.4	3	0		23.26	23.15	22.94
1.4	3	1		23.10	23.18	23.16
1.4	3	3		23.15	23.15	23.13
1.4	6	0		22.12	22.05	22.05
1.4	1	0	16-QAM	22.53	21.55	21.87
1.4	1	3		21.83	21.79	22.32
1.4	1	5		22.08	21.54	21.99
1.4	3	0		22.36	21.94	21.94
1.4	3	1		22.38	21.85	22.01
1.4	3	3		22.07	21.85	22.05
1.4	6	0		21.04	20.88	21.09



LTE Band 13 Maximum Average Power [dBm]						
BW [MHz]	RB Size	RB Offset	Mod	Lowest	Middle	Highest
10	1	0	QPSK		22.81	
10	1	25			22.47	
10	1	49			22.82	
10	25	0			21.57	
10	25	12			21.63	
10	25	25			21.76	
10	50	0			21.55	
10	1	0	16-QAM		22.15	
10	1	25			21.21	
10	1	49			21.16	
10	25	0			20.75	
10	25	12			20.75	
10	25	25			20.90	
10	50	0			20.79	
5	1	0	QPSK	22.62	22.54	22.53
5	1	12		22.52	22.58	22.78
5	1	24		22.65	22.73	22.83
5	12	0		21.75	21.59	21.76
5	12	7		21.66	21.72	21.86
5	12	13		21.62	21.73	21.77
5	25	0		21.64	21.72	21.72
5	1	0	16-QAM	21.28	21.25	21.50
5	1	12		21.37	21.37	21.44
5	1	24		21.38	21.97	21.75
5	12	0		20.60	20.51	20.56
5	12	7		20.68	20.62	20.63
5	12	13		20.54	20.77	20.88
5	25	0		20.84	20.63	20.78



LTE Band 17 Maximum Average Power [dBm]						
BW [MHz]	RB Size	RB Offset	Mod	Lowest	Middle	Highest
10	1	0	QPSK	22.49	22.30	22.35
10	1	25		22.82	22.63	22.84
10	1	49		22.54	22.30	22.38
10	25	0		21.60	21.62	21.59
10	25	12		21.66	21.70	21.76
10	25	25		21.72	21.68	21.57
10	50	0		21.64	21.62	21.57
10	1	0	16-QAM	21.01	21.18	21.17
10	1	25		21.13	21.87	21.61
10	1	49		21.43	21.28	21.06
10	25	0		20.70	20.59	20.61
10	25	12		20.72	20.76	20.72
10	25	25		20.77	20.63	20.61
10	50	0		20.60	20.57	20.62
5	1	0	QPSK	22.43	22.52	22.59
5	1	12		22.61	22.69	22.45
5	1	24		22.48	22.46	22.32
5	12	0		21.52	21.61	21.69
5	12	7		21.54	21.75	21.48
5	12	13		21.54	21.74	21.58
5	25	0		21.58	21.68	21.52
5	1	0	16-QAM	21.03	21.29	21.06
5	1	12		21.50	21.22	21.37
5	1	24		21.50	21.65	21.20
5	12	0		20.48	20.47	20.65
5	12	7		20.44	20.72	20.49
5	12	13		20.61	20.78	20.49
5	25	0		20.56	20.55	20.48



ERP/EIRP

LTE Band 2 (GT - LC ==-2.00 dB) QPSK									
Bandwidth	1.4M			3M			5M		
Channel	18607	18900	19193	18615	18900	19185	18625	18900	19175
	(Low)	(Mid)	(High)	(Low)	(Mid)	(High)	(Low)	(Mid)	(High)
Frequency	1850.7	1880	1909.3	1851.5	1880	1908.5	1852.5	1880	1907.5
(MHz)									
Conducted Power (dBm)	22.50	22.47	22.41	22.24	22.43	22.07	22.38	22.19	22.11
Conducted Power (Watts)	0.1778	0.1766	0.1742	0.1675	0.1750	0.1611	0.1730	0.1656	0.1626
EIRP(dBm)	20.50	20.47	20.41	20.24	20.43	20.07	20.38	20.19	20.11
EIRP(Watts)	0.1122	0.1114	0.1099	0.1057	0.1104	0.1016	0.1091	0.1045	0.1026

LTE Band 2 (GT - LC ==-2.00 dB) QPSK									
Bandwidth	10M			15M			20M		
Channel	18650	18900	19150	18675	18900	19125	18650	18900	19100
	(Low)	(Mid)	(High)	(Low)	(Mid)	(High)	(Low)	(Mid)	(High)
Frequency	1855	1880	1905	1857.5	1880	1902.5	1860	1880	1900
(MHz)									
Conducted Power (dBm)	22.48	22.67	22.22	22.33	22.33	22.29	22.48	22.39	22.28
Conducted Power (Watts)	0.1770	0.1849	0.1667	0.1710	0.1710	0.1694	0.1770	0.1734	0.1690
EIRP(dBm)	20.48	20.67	20.22	20.33	20.33	20.29	20.48	20.39	20.28
EIRP(Watts)	0.1117	0.1167	0.1052	0.1079	0.1079	0.1069	0.1117	0.1094	0.1067



LTE Band 2 (GT - LC = -2.00 dB) 16QAM									
Bandwidth	1.4M			3M			5M		
Channel	18607	18900	19193	18615	18900	19185	18625	18900	19175
	(Low)	(Mid)	(High)	(Low)	(Mid)	(High)	(Low)	(Mid)	(High)
Frequency	1850.7	1880	1909.3	1851.5	1880	1908.5	1852.5	1880	1907.5
(MHz)									
Conducted Power (dBm)	21.58	21.13	20.71	20.73	20.74	21.45	21.49	20.92	21.45
Conducted Power (Watts)	0.1439	0.1297	0.1178	0.1183	0.1186	0.1396	0.1409	0.1236	0.1396
EIRP(dBm)	19.58	19.13	18.71	18.73	18.74	19.45	19.49	18.92	19.45
EIRP(Watts)	0.0908	0.0818	0.0743	0.0746	0.0748	0.0881	0.0889	0.0780	0.0881

LTE Band 2 (GT - LC = -2.00 dB) 16QAM									
Bandwidth	10M			15M			20M		
Channel	18650	18900	19150	18675	18900	19125	18650	18900	19100
	(Low)	(Mid)	(High)	(Low)	(Mid)	(High)	(Low)	(Mid)	(High)
Frequency	1855	1880	1905	1857.5	1880	1902.5	1860	1880	1900
(MHz)									
Conducted Power (dBm)	21.44	20.80	21.47	21.07	20.99	21.40	21.45	20.89	21.07
Conducted Power (Watts)	0.1393	0.1202	0.1403	0.1279	0.1256	0.1380	0.1396	0.1227	0.1279
EIRP(dBm)	19.44	18.80	19.47	19.07	18.99	19.40	19.45	18.89	19.07
EIRP(Watts)	0.0879	0.0759	0.0885	0.0807	0.0793	0.0871	0.0881	0.0774	0.0807



LTE Band 4 (GT - LC = -2.00 dB) QPSK									
Bandwidth	1.4M			3M			5M		
Channel	19957	20175	20393	19965	20175	20385	19975	20175	20375
	(Low)	(Mid)	(High)	(Low)	(Mid)	(High)	(Low)	(Mid)	(High)
Frequency	1710.7	1732.5	1754.3	1711.5	1732.5	1753.5	1712.5	1732.5	1752.5
(MHz)									
Conducted Power (dBm)	23.47	23.53	23.25	23.33	23.51	23.03	23.12	23.35	23.48
Conducted Power (Watts)	0.2223	0.2254	0.2113	0.2153	0.2244	0.2009	0.2051	0.2163	0.2228
EIRP(dBm)	21.47	21.53	21.25	21.33	21.51	21.03	21.12	21.35	21.48
EIRP(Watts)	0.1403	0.1422	0.1334	0.1358	0.1416	0.1268	0.1294	0.1365	0.1406

LTE Band 4 (GT - LC = -2.00 dB) QPSK									
Bandwidth	10M			15M			20M		
Channel	20000	20175	20350	20025	20175	20325	20050	20175	20300
	(Low)	(Mid)	(High)	(Low)	(Mid)	(High)	(Low)	(Mid)	(High)
Frequency	1715	1732.5	1750	1717.5	1732.5	1747.5	1720	1732.5	1745
(MHz)									
Conducted Power (dBm)	23.10	23.55	23.06	22.98	23.29	23.11	23.00	23.37	23.16
Conducted Power (Watts)	0.2042	0.2265	0.2023	0.1986	0.2133	0.2046	0.1995	0.2173	0.2070
EIRP(dBm)	21.10	21.55	21.06	20.98	21.29	21.11	21.00	21.37	21.16
EIRP(Watts)	0.1288	0.1429	0.1276	0.1253	0.1346	0.1291	0.1259	0.1371	0.1306



LTE Band 4 (GT - LC = -2.00 dB) 16QAM									
Bandwidth	1.4M			3M			5M		
Channel	19957	20175	20393	19965	20175	20385	19975	20175	20375
	(Low)	(Mid)	(High)	(Low)	(Mid)	(High)	(Low)	(Mid)	(High)
Frequency	1710.7	1732.5	1754.3	1711.5	1732.5	1753.5	1712.5	1732.5	1752.5
(MHz)									
Conducted Power (dBm)	22.76	22.39	22.45	22.44	21.85	22.15	22.23	22.41	22.63
Conducted Power (Watts)	0.1888	0.1734	0.1758	0.1754	0.1531	0.1641	0.1671	0.1742	0.1832
EIRP(dBm)	20.76	20.39	20.45	20.44	19.85	20.15	20.23	20.41	20.63
EIRP(Watts)	0.1191	0.1094	0.1109	0.1107	0.0966	0.1035	0.1054	0.1099	0.1156

LTE Band 4 (GT - LC = -2.00 dB) 16QAM									
Bandwidth	10M			15M			20M		
Channel	20000	20175	20350	20025	20175	20325	20050	20175	20300
	(Low)	(Mid)	(High)	(Low)	(Mid)	(High)	(Low)	(Mid)	(High)
Frequency	1715	1732.5	1750	1717.5	1732.5	1747.5	1720	1732.5	1745
(MHz)									
Conducted Power (dBm)	22.62	21.67	21.73	22.10	22.59	21.99	22.58	21.99	22.52
Conducted Power (Watts)	0.1828	0.1469	0.1489	0.1622	0.1816	0.1581	0.1811	0.1581	0.1786
EIRP(dBm)	20.62	19.67	19.73	20.10	20.59	19.99	20.58	19.99	20.52
EIRP(Watts)	0.1153	0.0927	0.0940	0.1023	0.1146	0.0998	0.1143	0.0998	0.1127



LTE Band 5 (GT - LC = -3.00 dB) QPSK									
Bandwidth	1.4M			3M			5M		
Channel	20407	20525	20643	20415	20525	20635	20425	20525	20625
	(Low)	(Mid)	(High)	(Low)	(Mid)	(High)	(Low)	(Mid)	(High)
Frequency	824.7	836.5	848.3	825.5	836.5	847.5	826.5	836.5	846.5
(MHz)									
Conducted Power (dBm)	22.11	22.31	22.24	22.08	22.30	22.12	22.25	22.31	21.96
Conducted Power (Watts)	0.1626	0.1702	0.1675	0.1614	0.1698	0.1629	0.1679	0.1702	0.1570
ERP(dBm)	16.96	17.16	17.09	16.93	17.15	16.97	17.10	17.16	16.81
ERP(Watts)	0.0497	0.0520	0.0512	0.0493	0.0519	0.0498	0.0513	0.0520	0.0480

LTE Band 5 (GT - LC = -3.00 dB) QPSK			
Bandwidth	10M		
Channel	20450	20525	20600
	(Low)	(Mid)	(High)
Frequency	829	836.5	844
(MHz)			
Conducted Power (dBm)	21.77	22.34	21.97
Conducted Power (Watts)	0.1503	0.1714	0.1574
ERP(dBm)	16.62	17.19	16.82
ERP(Watts)	0.0459	0.0524	0.0481



LTE Band 5 (GT - LC = -3.00 dB) 16QAM									
Bandwidth	1.4M			3M			5M		
Channel	20407	20525	20643	20415	20525	20635	20425	20525	20625
	(Low)	(Mid)	(High)	(Low)	(Mid)	(High)	(Low)	(Mid)	(High)
Frequency	824.7	836.5	848.3	825.5	836.5	847.5	826.5	836.5	846.5
(MHz)									
Conducted Power (dBm)	21.41	20.79	20.92	20.59	21.29	20.83	20.48	21.12	20.64
Conducted Power (Watts)	0.1384	0.1199	0.1236	0.1146	0.1346	0.1211	0.1117	0.1294	0.1159
ERP(dBm)	16.26	15.64	15.77	15.44	16.14	15.68	15.33	15.97	15.49
ERP(Watts)	0.0423	0.0366	0.0378	0.0350	0.0411	0.0370	0.0341	0.0395	0.0354

LTE Band 5 (GT - LC = -3.00 dB) 16QAM			
Bandwidth	10M		
Channel	20450	20525	20600
	(Low)	(Mid)	(High)
Frequency	829	836.5	844
(MHz)			
Conducted Power (dBm)	20.61	21.25	20.69
Conducted Power (Watts)	0.1151	0.1334	0.1172
ERP(dBm)	15.46	16.10	15.54
ERP(Watts)	0.0352	0.0407	0.0358



LTE Band 12 (GT - LC = -3.00 dB) QPSK									
Bandwidth	1.4M			3M			5M		
Channel	23017	23095	23173	23025	23095	23165	23035	23095	23155
	(Low)	(Mid)	(High)	(Low)	(Mid)	(High)	(Low)	(Mid)	(High)
Frequency (MHz)	699.7	707.5	715.3	700.5	707.5	714.5	701.5	707.5	713.5
Conducted Power (dBm)	23.26	23.15	22.94	23.31	23.25	22.87	22.82	23.27	23.12
Conducted Power (Watts)	0.2118	0.2065	0.1968	0.2143	0.2113	0.1936	0.1914	0.2123	0.2051
ERP(dBm)	18.11	18.00	17.79	18.16	18.10	17.72	17.67	18.12	17.97
ERP(Watts)	0.0647	0.0631	0.0601	0.0655	0.0646	0.0592	0.0585	0.0649	0.0627

LTE Band 12 (GT - LC = -3.00 dB) QPSK			
Bandwidth	10M		
Channel	23060	23095	23130
	(Low)	(Mid)	(High)
Frequency (MHz)	704	707.5	711
Conducted Power (dBm)	22.69	22.92	23.19
Conducted Power (Watts)	0.1858	0.1959	0.2084
ERP(dBm)	17.54	17.77	18.04
ERP(Watts)	0.0568	0.0598	0.0637



LTE Band 12 (GT - LC = -3.00 dB) 16QAM									
Bandwidth	1.4M			3M			5M		
Channel	23017	23095	23173	23025	23095	23165	23035	23095	23155
	(Low)	(Mid)	(High)	(Low)	(Mid)	(High)	(Low)	(Mid)	(High)
Frequency (MHz)	699.7	707.5	715.3	700.5	707.5	714.5	701.5	707.5	713.5
Conducted Power (dBm)	22.53	21.55	21.87	22.25	22.12	21.51	22.29	21.80	21.41
Conducted Power (Watts)	0.1791	0.1429	0.1538	0.1679	0.1629	0.1416	0.1694	0.1514	0.1384
ERP(dBm)	17.38	16.40	16.72	17.10	16.97	16.36	17.14	16.65	16.26
ERP(Watts)	0.0547	0.0437	0.0470	0.0513	0.0498	0.0433	0.0518	0.0462	0.0423

LTE Band 12 (GT - LC = -3.00 dB) 16QAM			
Bandwidth	10M		
Channel	23060	23095	23130
	(Low)	(Mid)	(High)
Frequency (MHz)	704	707.5	711
Conducted Power (dBm)	22.25	21.57	21.86
Conducted Power (Watts)	0.1679	0.1435	0.1535
ERP(dBm)	17.10	16.42	16.71
ERP(Watts)	0.0513	0.0439	0.0469



LTE Band 13 (GT - LC = -3.00 dB) QPSK						
Bandwidth	5M			10M		
Channel	23205	23230	23255	23230		
	(Low)	(Mid)	(High)	-	(Mid)	-
Frequency	779.5	782	784.5	-	782	-
(MHz)						
Conducted Power (dBm)	22.65	22.73	22.83		22.82	-
Conducted Power (Watts)	0.1841	0.1875	0.1919		0.1914	-
ERP(dBm)	17.50	17.58	17.68		17.67	-
ERP(Watts)	0.0562	0.0573	0.0586		0.0585	-

LTE Band 13 (GT - LC = -3.00 dB) 16QAM						
Bandwidth	5M			10M		
Channel	23205	23230	23255	23230		
	(Low)	(Mid)	(High)	-	(Mid)	-
Frequency	779.5	782	784.5	-	782	-
(MHz)						
Conducted Power (dBm)	21.38	21.97	21.75		22.15	-
Conducted Power (Watts)	0.1374	0.1574	0.1496		0.1641	-
ERP(dBm)	16.23	16.82	16.60		17.00	-
ERP(Watts)	0.0420	0.0481	0.0457		0.0501	-



Peak-to-Average Ratio

Mode	LTE Band 2 / 20MHz				
Mod.	QPSK		16QAM		Limit: 13dB
RB Size	1RB	Full RB	1RB	Full RB	Result
Lowest CH	4.58	4.87	5.59	5.86	PASS
Middle CH	4.72	4.96	5.74	5.97	
Highest CH	4.7	4.96	5.71	6	

Mode	LTE Band 4 / 20MHz				
Mod.	QPSK		16QAM		Limit: 13dB
RB Size	1RB	Full RB	1RB	Full RB	Result
Lowest CH	4.38	4.64	5.36	5.74	PASS
Middle CH	4.32	4.7	5.19	5.68	
Highest CH	4.2	4.46	5.07	5.54	

Mode	LTE Band 5 / 10MHz				
Mod.	QPSK		16QAM		Limit: 13dB
RB Size	1RB	Full RB	1RB	Full RB	Result
Lowest CH	4.49	4.81	5.19	5.74	PASS
Middle CH	4.43	4.99	5.48	5.77	
Highest CH	4.7	4.81	5.65	5.86	

Mode	LTE Band 12 / 10MHz				
Mod.	QPSK		16QAM		Limit: 13dB
RB Size	1RB	Full RB	1RB	Full RB	Result
Lowest CH	4.43	4.93	5.1	5.83	PASS
Middle CH	4.29	4.96	5.33	5.77	
Highest CH	4.55	4.75	5.33	5.74	

Mode	LTE Band 13 / 10MHz				
Mod.	QPSK		16QAM		Limit: 13dB
RB Size	1RB	Full RB	1RB	Full RB	Result
Lowest CH	-	-	-	-	PASS
Middle CH	4.43	4.9	5.3	5.74	
Highest CH	-	-	-	-	



LTE Band 2 / 20MHz / QPSK

Lowest Channel / 1RB

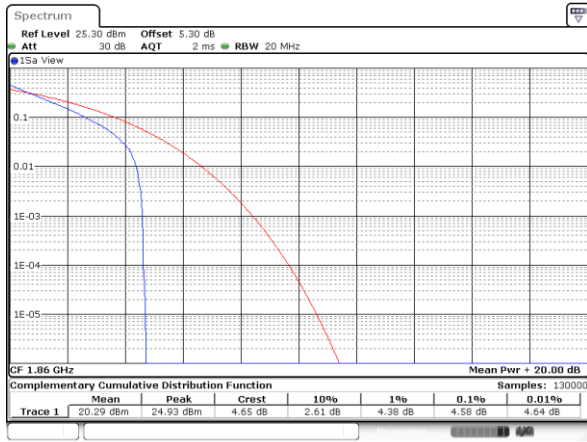

Date: 29.OCT.2018 19:28:26

Lowest Channel / Full RB

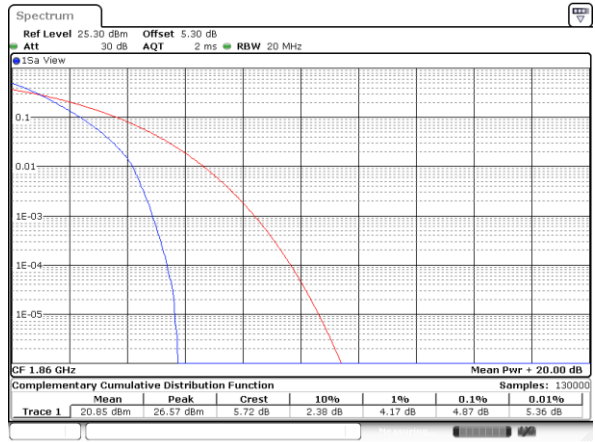

Date: 29.OCT.2018 19:28:38

Middle Channel / 1RB



Date: 29.OCT.2018 19:28:58

Middle Channel / Full RB

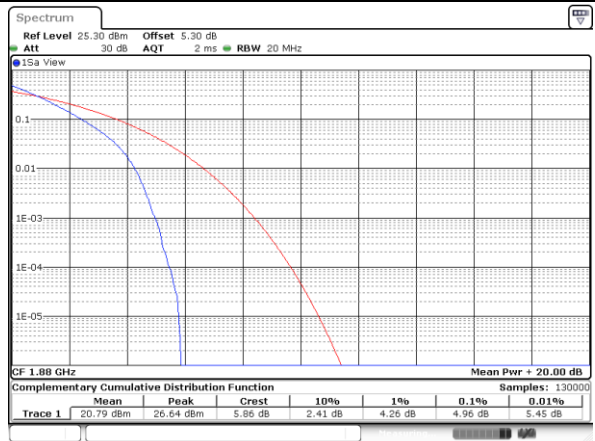

Date: 29.OCT.2018 19:28:48

Highest Channel / 1RB



Date: 29.OCT.2018 19:29:10

Highest Channel / Full RB

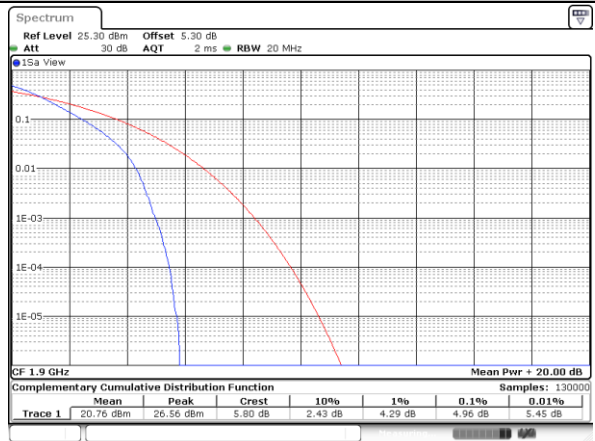

Date: 29.OCT.2018 19:29:21



LTE Band 2 / 20MHz / 16QAM

Lowest Channel / 1RB

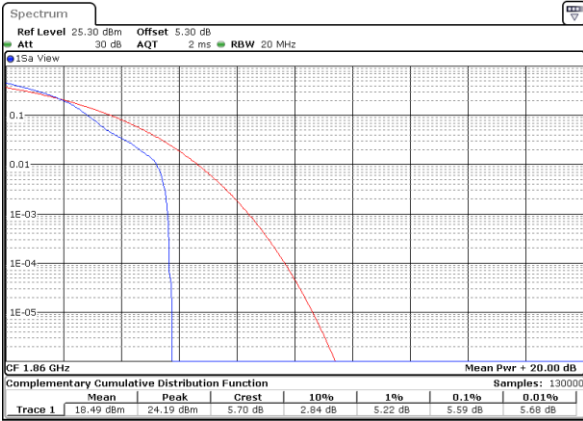

Date: 29 OCT 2018 18:17:50

Lowest Channel / Full RB

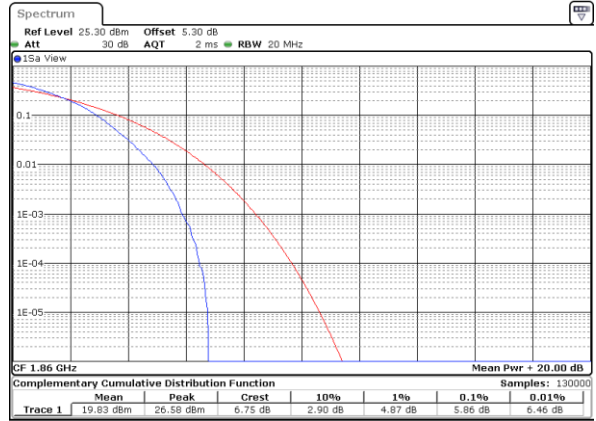

Date: 29 OCT 2018 18:17:59

Middle Channel / 1RB



Date: 29 OCT 2018 18:18:08

Middle Channel / Full RB

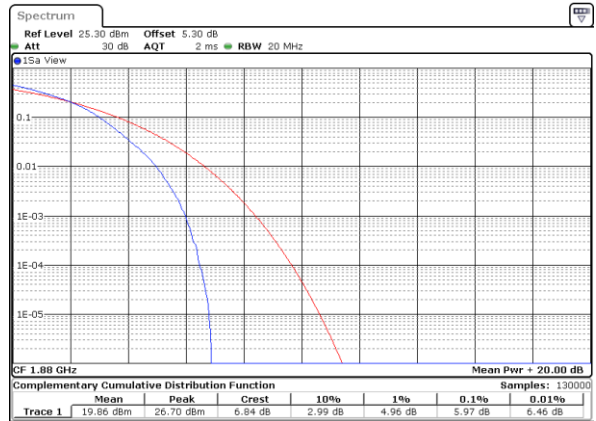

Date: 29 OCT 2018 18:18:17

Highest Channel / 1RB



Date: 29 OCT 2018 18:18:26

Highest Channel / Full RB

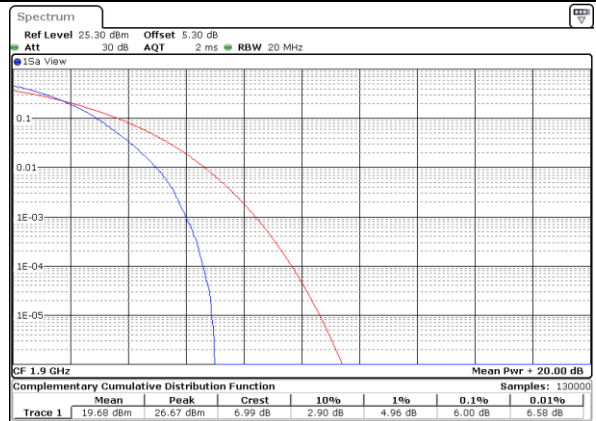

Date: 29 OCT 2018 18:18:36



LTE Band 4 / 20MHz / QPSK

Lowest Channel / 1RB

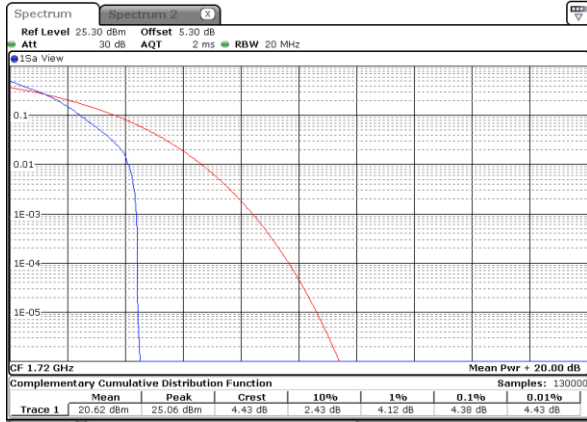

Date: 30.OCT.2018 13:19:14

Lowest Channel / Full RB

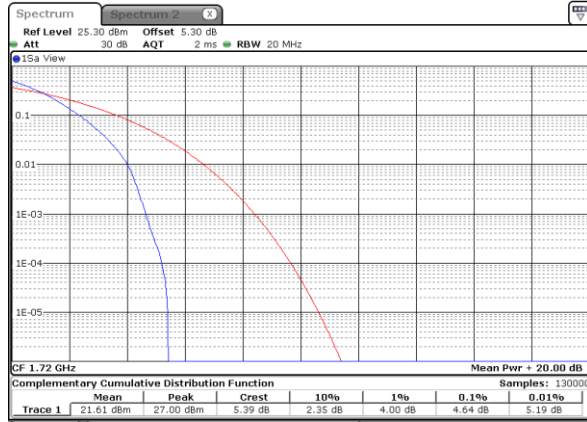

Date: 30.OCT.2018 13:19:02

Middle Channel / 1RB

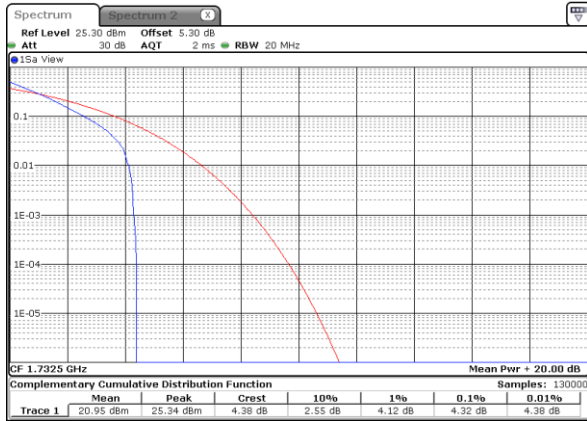

Date: 30.OCT.2018 13:19:48

Middle Channel / Full RB

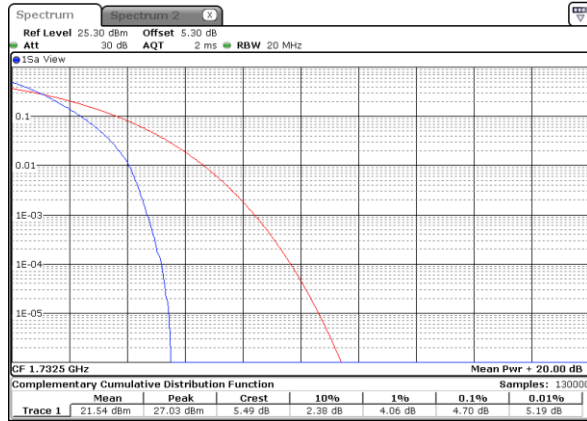

Date: 30.OCT.2018 13:20:01

Highest Channel / 1RB

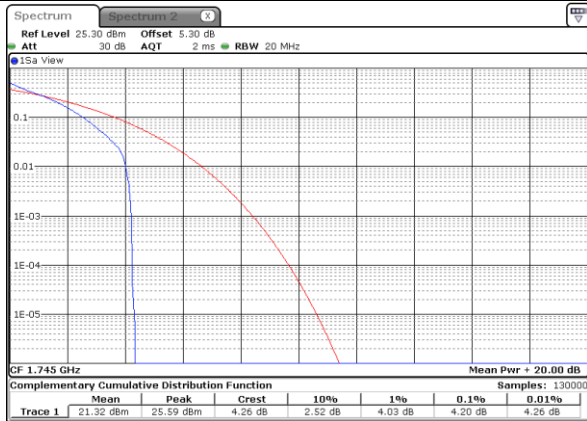

Date: 30.OCT.2018 13:20:29

Highest Channel / Full RB

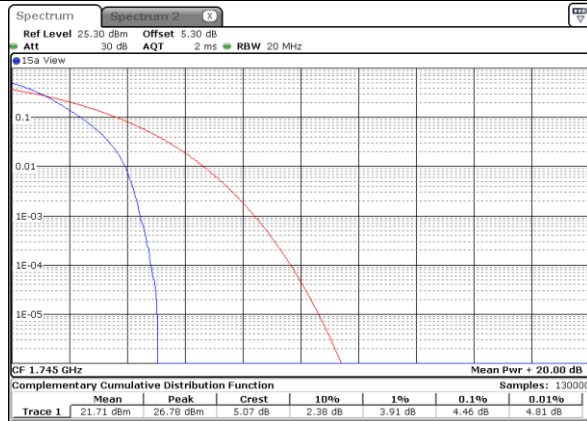

Date: 30.OCT.2018 13:20:17



LTE Band 4 / 20MHz / 16QAM

Lowest Channel / 1RB

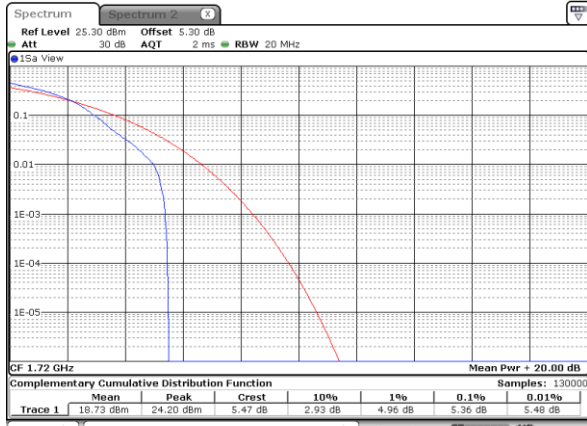

Date: 30.OCT.2018 13:17:47

Lowest Channel / Full RB

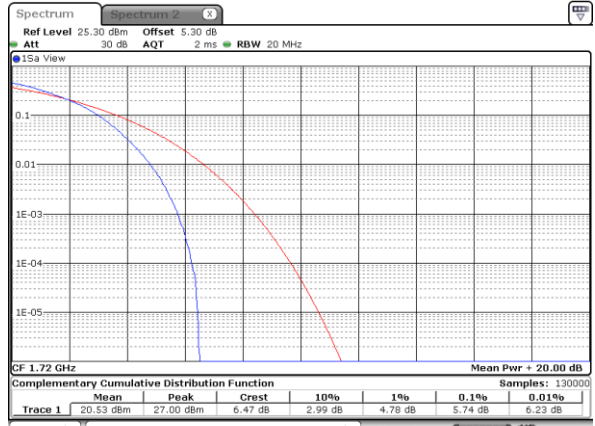

Date: 30.OCT.2018 13:17:56

Middle Channel / 1RB

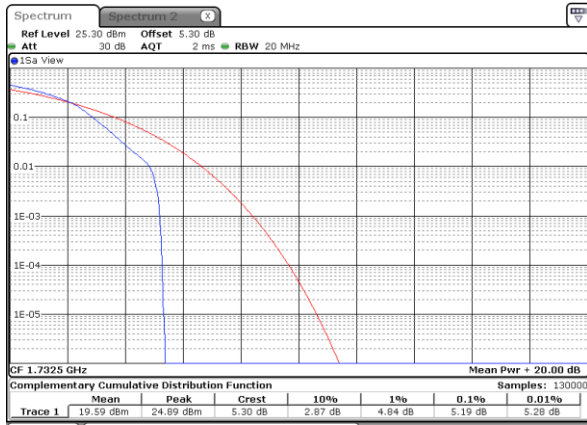

Date: 30.OCT.2018 13:18:04

Middle Channel / Full RB

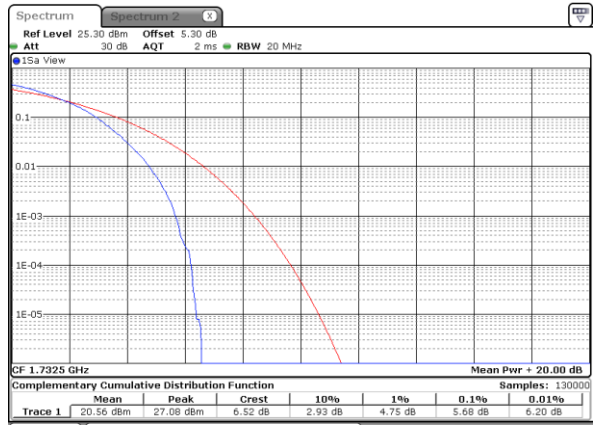

Date: 30.OCT.2018 13:18:13

Highest Channel / 1RB

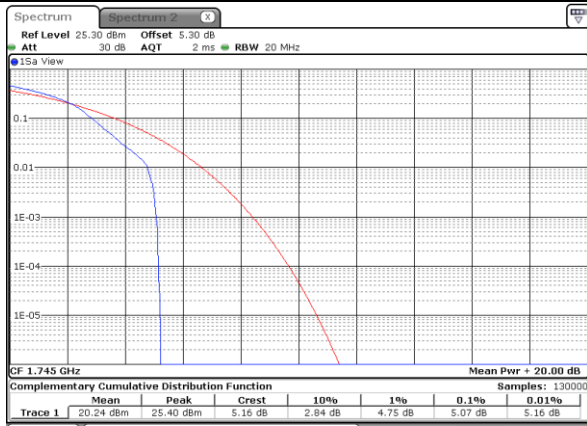

Date: 30.OCT.2018 13:18:22

Highest Channel / Full RB

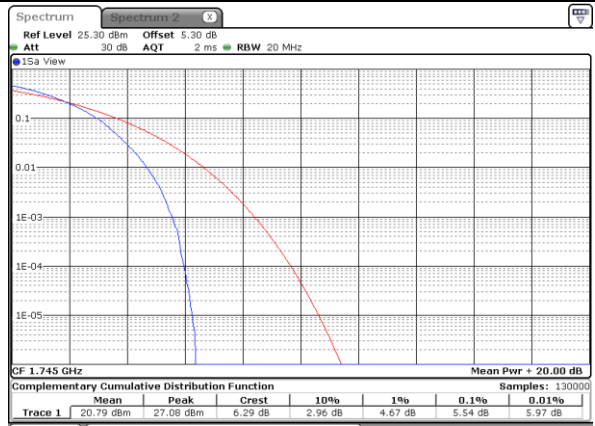

Date: 30.OCT.2018 13:18:31



LTE Band 5 / 10MHz / QPSK

Lowest Channel / 1RB

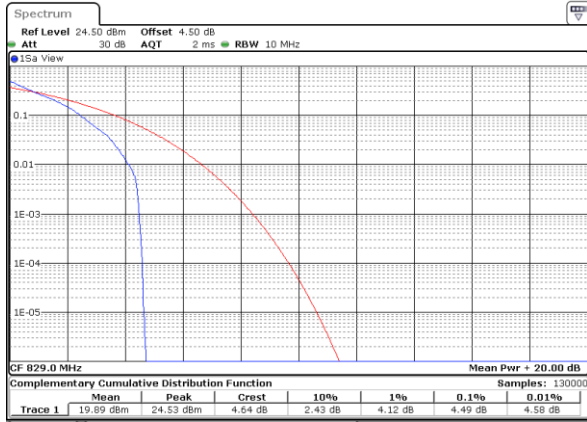

Date: 29 OCT 2018 23:05:55

Lowest Channel / Full RB

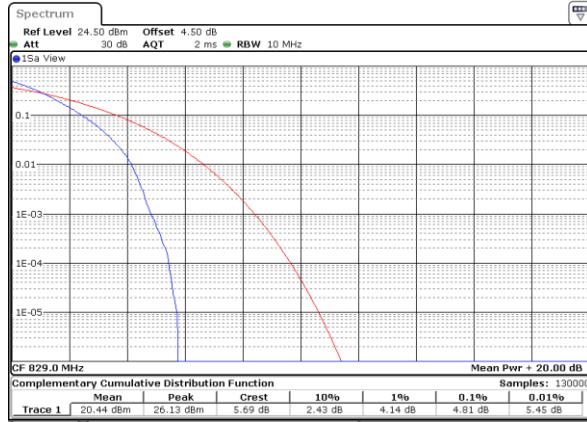

Date: 29 OCT 2018 23:06:04

Middle Channel / 1RB

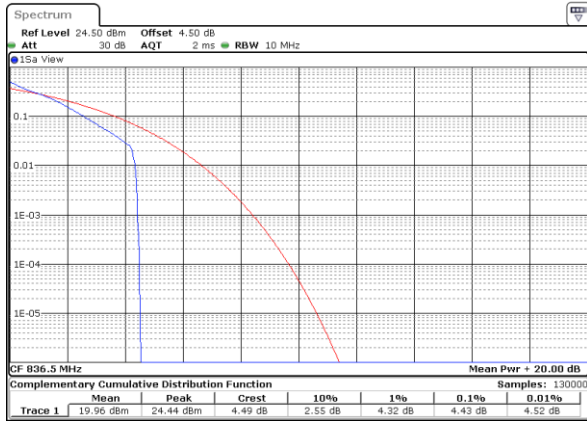

Date: 29 OCT 2018 23:06:22

Middle Channel / Full RB

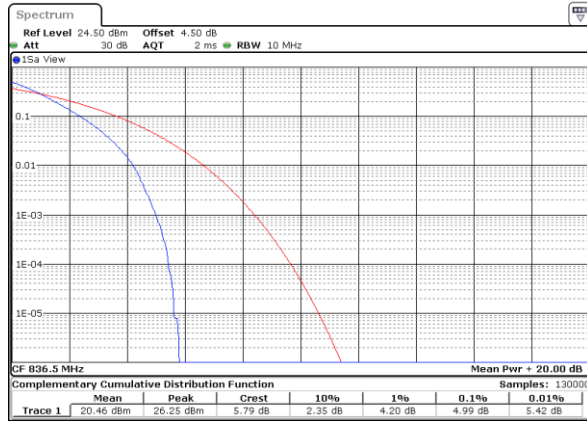

Date: 29 OCT 2018 23:06:13

Highest Channel / 1RB

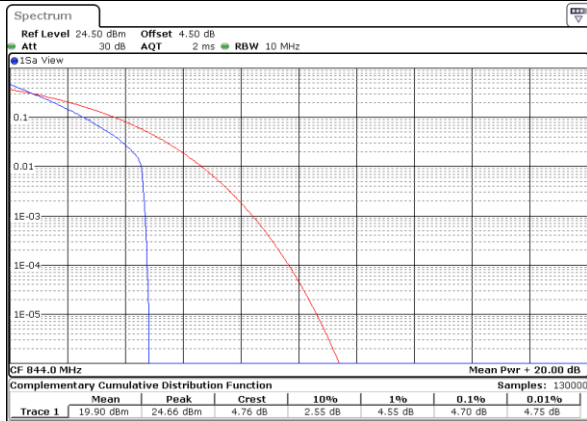

Date: 29 OCT 2018 23:06:31

Highest Channel / Full RB

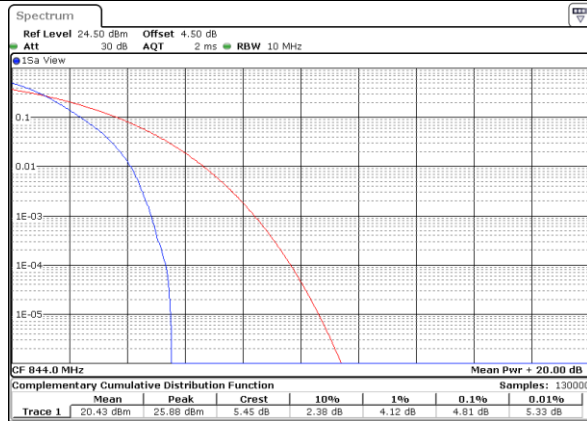

Date: 29 OCT 2018 23:06:40



LTE Band 5 / 10MHz / 16QAM

Lowest Channel / 1RB

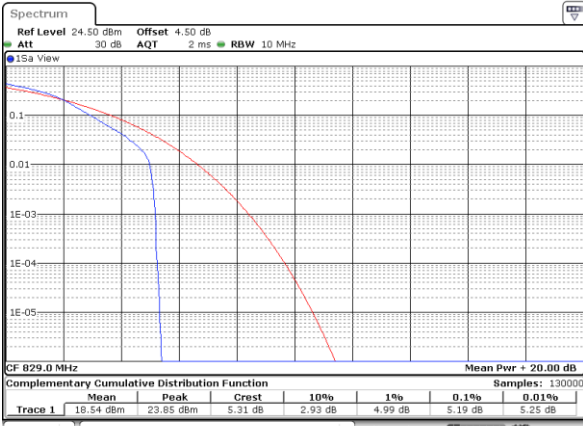

Date: 29 OCT 2018 23:04:57

Lowest Channel / Full RB

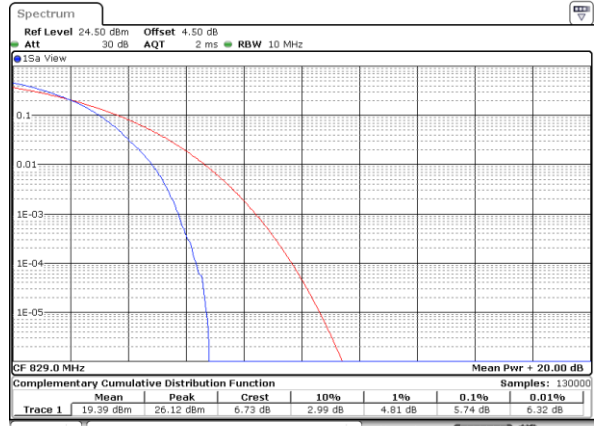

Date: 29 OCT 2018 23:05:09

Middle Channel / 1RB

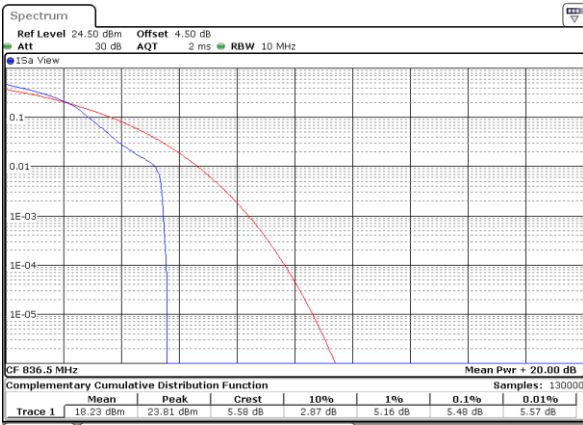

Date: 29 OCT 2018 23:05:19

Middle Channel / Full RB

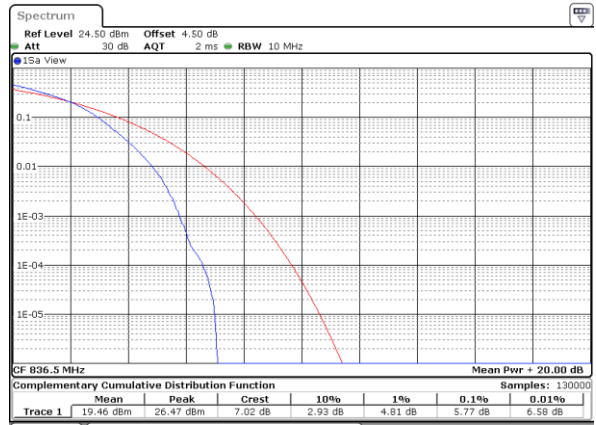

Date: 29 OCT 2018 23:05:28

Highest Channel / 1RB

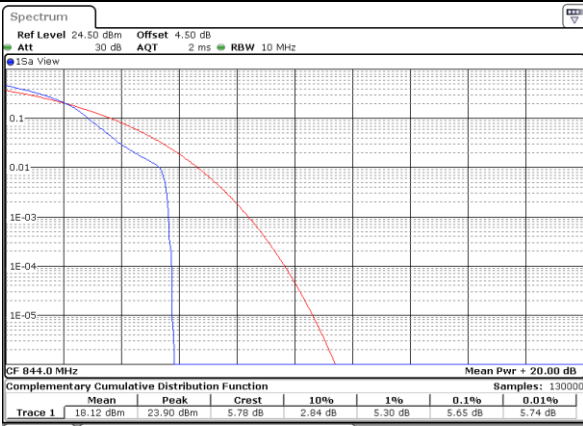

Date: 29 OCT 2018 23:05:38

Highest Channel / Full RB



Date: 29 OCT 2018 23:05:46



LTE Band 12 / 10MHz / QPSK

Lowest Channel / 1RB

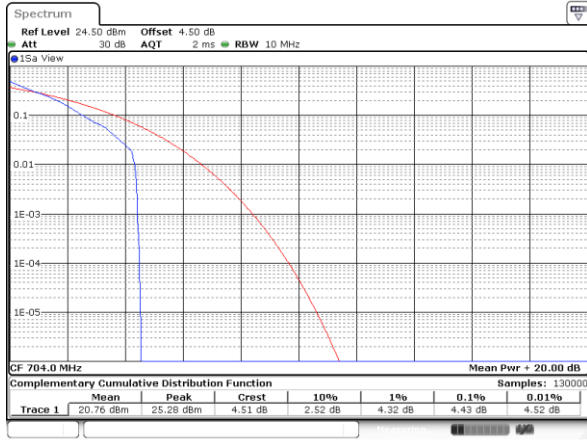

Date: 1 NOV 2018 00:25:16

Lowest Channel / Full RB

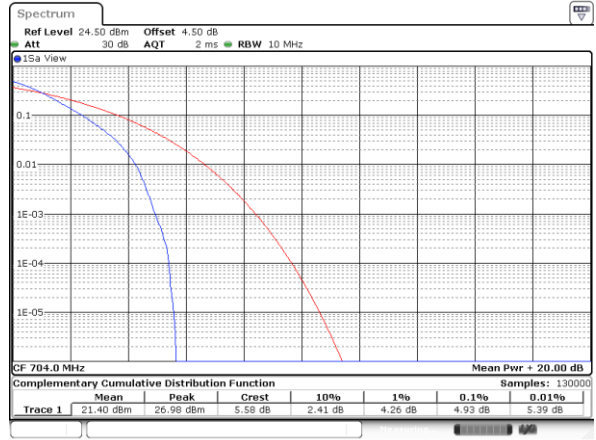

Date: 1 NOV 2018 00:25:27

Middle Channel / 1RB

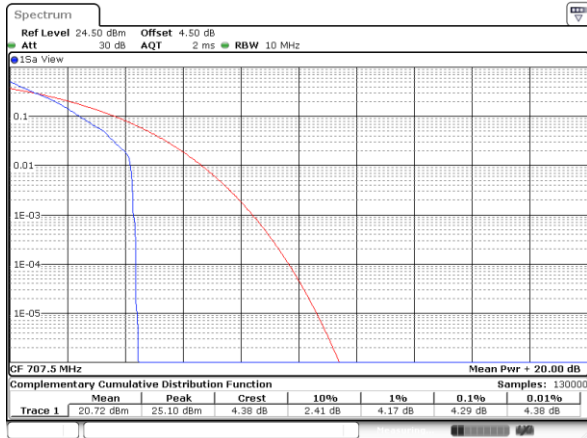

Date: 1 NOV 2018 00:26:11

Middle Channel / Full RB

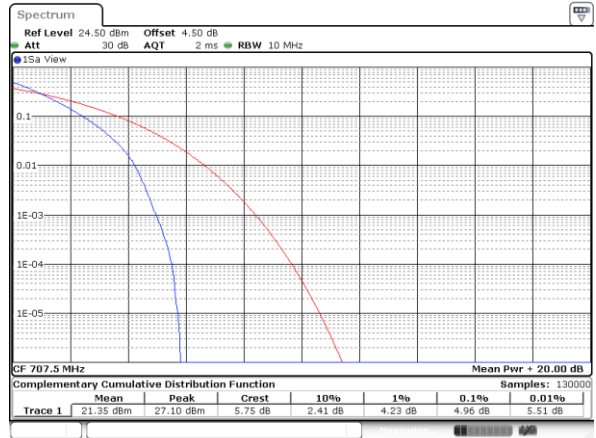

Date: 1 NOV 2018 00:25:56

Highest Channel / 1RB

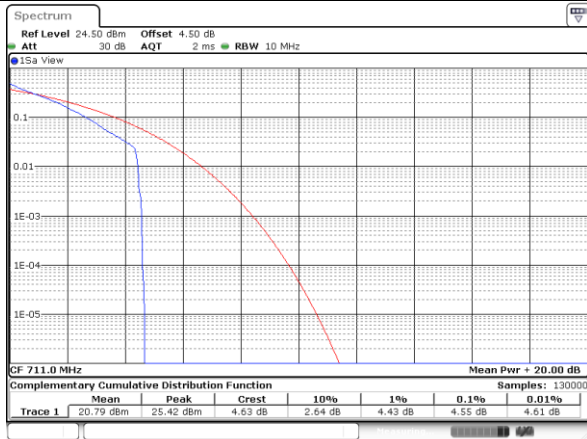

Date: 1 NOV 2018 00:26:39

Highest Channel / Full RB

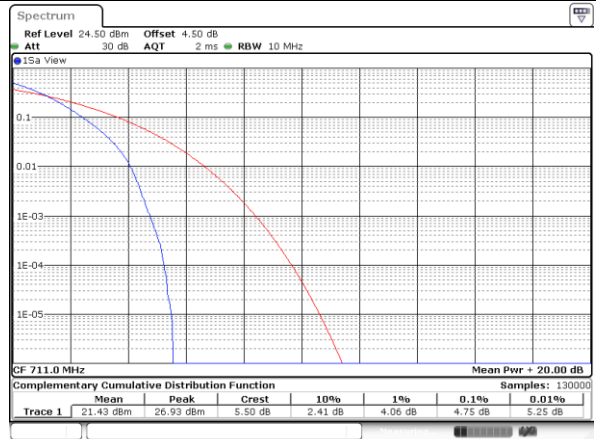

Date: 1 NOV 2018 00:26:49



LTE Band 12 / 10MHz / 16QAM

Lowest Channel / 1RB

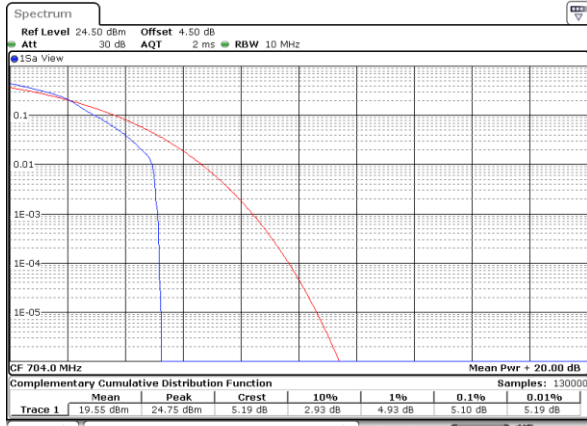

Date: 1 NOV 2018 00:25:07

Lowest Channel / Full RB

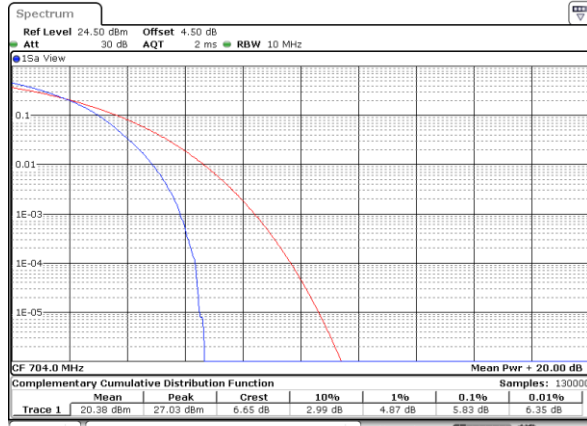

Date: 1 NOV 2018 00:25:36

Middle Channel / 1RB

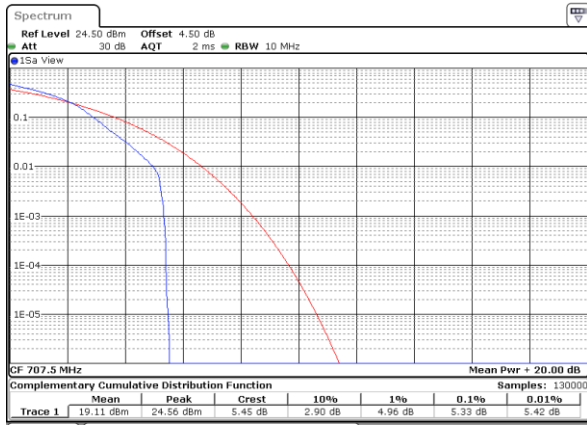

Date: 1 NOV 2018 00:26:20

Middle Channel / Full RB

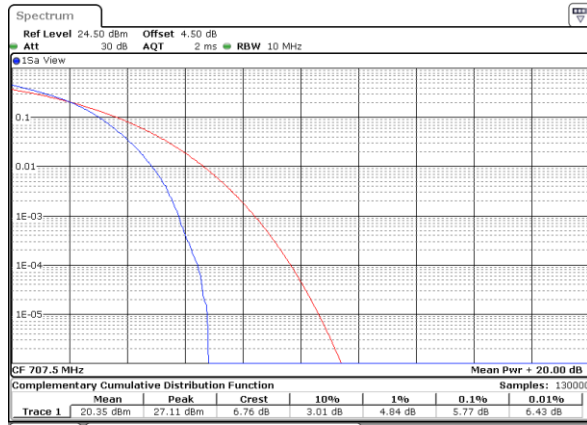

Date: 1 NOV 2018 00:25:46

Highest Channel / 1RB

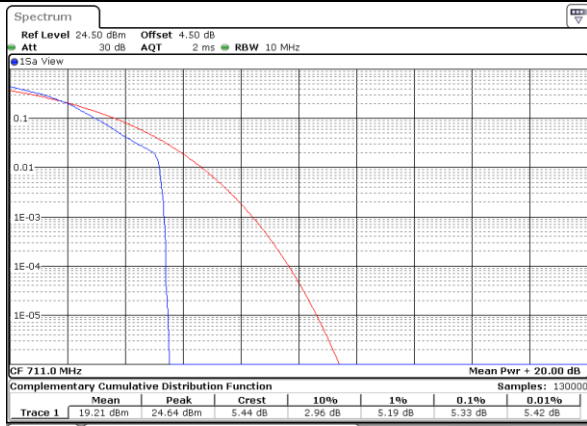

Date: 1 NOV 2018 00:26:30

Highest Channel / Full RB

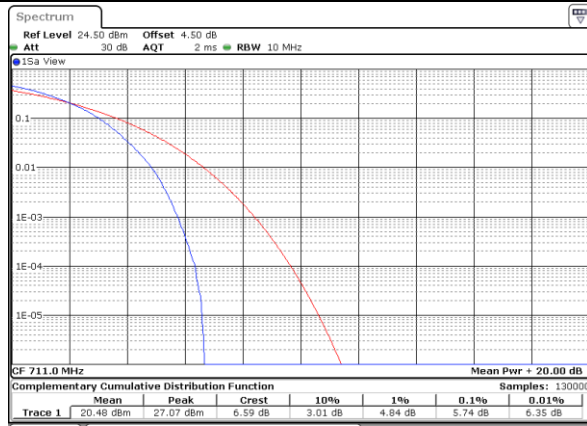

Date: 1 NOV 2018 00:26:59



LTE Band 13 / 10MHz / QPSK

Middle Channel/ 1RB

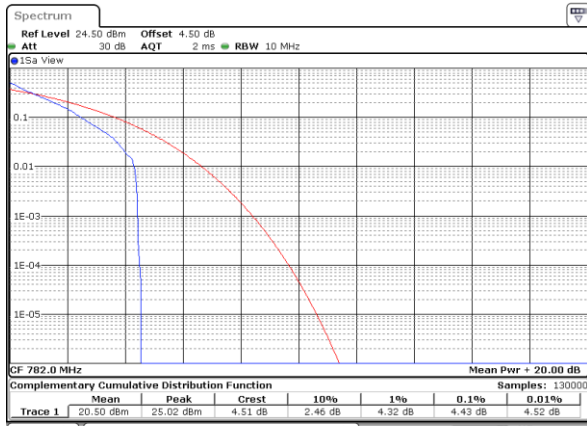

Date: 31.OCT.2018 22:31:40

Middle Channel / Full RB

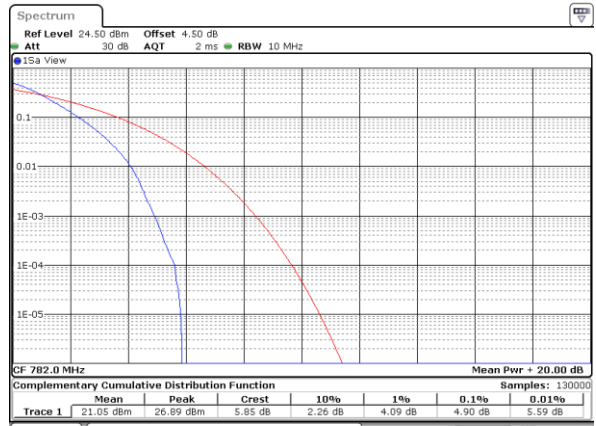

Date: 31.OCT.2018 22:32:15

LTE Band 13 / 10MHz / 16QAM

Middle Channel/ 1RB

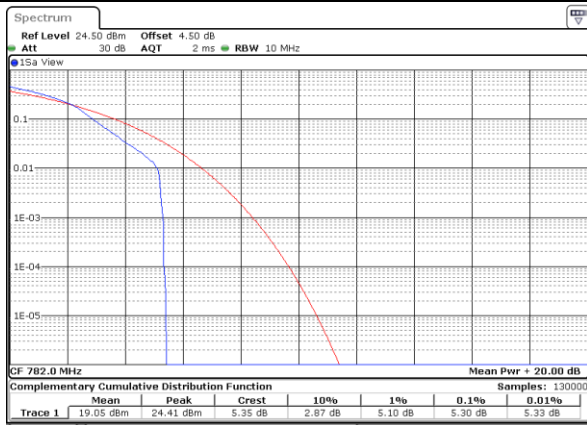

Date: 31.OCT.2018 22:31:57

Middle Channel / Full RB

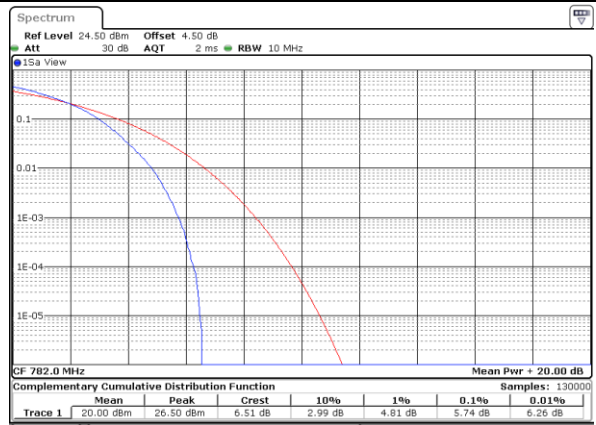

Date: 31.OCT.2018 22:32:06



26dB Bandwidth

Mode	LTE Band 2 : 26dB BW(MHz)											
	1.4MHz		3MHz		5MHz		10MHz		15MHz		20MHz	
Mod.	QPSK	16QAM	QPSK	16QAM	QPSK	16QAM	QPSK	16QAM	QPSK	16QAM	QPSK	16QAM
Lowest CH	1.276	1.287	3.033	3.027	4.995	4.925	9.91	9.75	14.326	14.386	20.1	20.26
Middle CH	1.267	1.27	2.961	3.021	5.005	4.845	9.75	9.81	14.266	14.356	20.18	20.14
Highest CH	1.267	1.264	2.997	3.009	4.955	4.775	9.65	9.93	14.176	14.356	20.14	20.1

Mode	LTE Band 4 : 26dB BW(MHz)											
	1.4MHz		3MHz		5MHz		10MHz		15MHz		20MHz	
Mod.	QPSK	16QAM	QPSK	16QAM	QPSK	16QAM	QPSK	16QAM	QPSK	16QAM	QPSK	16QAM
Lowest CH	1.278	1.292	2.985	3.009	5.035	4.925	9.79	9.75	14.386	14.505	20.02	20.14
Middle CH	1.304	1.262	2.967	2.985	4.995	4.945	9.71	9.81	14.625	14.296	20.34	20.1
Highest CH	1.281	1.27	3.015	3.069	4.965	4.965	9.81	9.69	14.386	14.446	20.02	20.18

Mode	LTE Band 5 : 26dB BW(MHz)											
	1.4MHz		3MHz		5MHz		10MHz		15MHz		20MHz	
Mod.	QPSK	16QAM	QPSK	16QAM	QPSK	16QAM	QPSK	16QAM	QPSK	16QAM	QPSK	16QAM
Lowest CH	1.287	1.298	2.997	3.009	4.845	4.955	9.71	9.71	-	-	-	-
Middle CH	1.262	1.248	3.051	2.979	4.945	4.855	9.81	9.77	-	-	-	-
Highest CH	1.267	1.304	2.991	3.051	5.005	4.975	9.81	9.91	-	-	-	-

Mode	LTE Band 12 : 26dB BW(MHz)											
	1.4MHz		3MHz		5MHz		10MHz		15MHz		20MHz	
Mod.	QPSK	16QAM	QPSK	16QAM	QPSK	16QAM	QPSK	16QAM	QPSK	16QAM	QPSK	16QAM
Lowest CH	1.264	1.25	3.027	2.997	4.945	4.855	9.77	9.91	-	-	-	-
Middle CH	1.273	1.273	3.009	2.973	4.895	4.895	9.93	10.01	-	-	-	-
Highest CH	1.256	1.262	3.009	2.967	4.925	4.925	9.99	9.83	-	-	-	-

Mode	LTE Band 13 : 26dB BW(MHz)											
	1.4MHz		3MHz		5MHz		10MHz		15MHz		20MHz	
Mod.	QPSK	16QAM	QPSK	16QAM	QPSK	16QAM	QPSK	16QAM	QPSK	16QAM	QPSK	16QAM
Lowest CH	-	-	-	-	4.925	4.885	-	-	-	-	-	-
Middle CH	-	-	-	-	4.995	4.875	9.81	9.85	-	-	-	-
Highest CH	-	-	-	-	4.975	4.855	-	-	-	-	-	-



LTE Band 2

Lowest Channel / 1.4MHz / QPSK

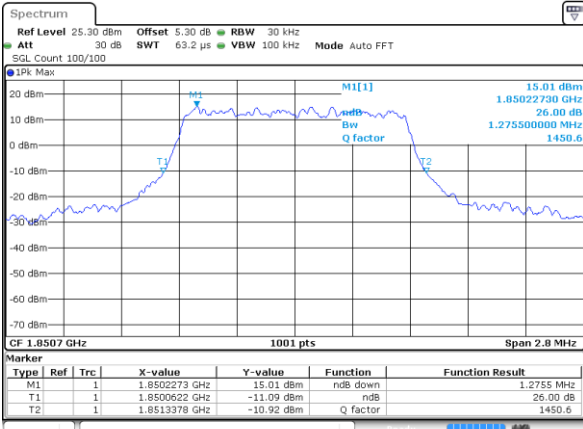

Date: 29 OCT 2018 16:09:05

Lowest Channel / 1.4MHz / 16QAM

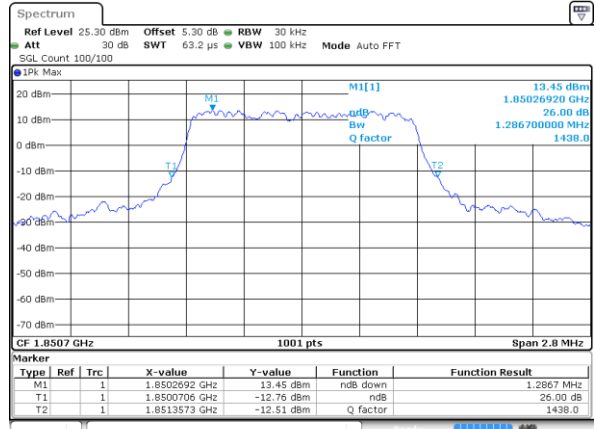

Date: 29 OCT 2018 16:09:14

Middle Channel / 1.4MHz / QPSK

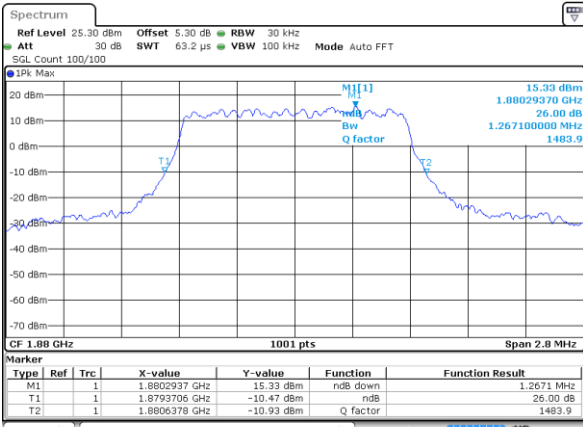

Date: 29 OCT 2018 16:16:04

Middle Channel / 1.4MHz / 16QAM

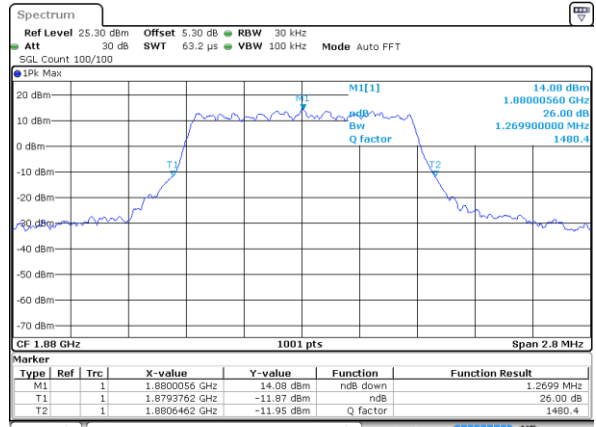

Date: 29 OCT 2018 16:16:14

Highest Channel / 1.4MHz / QPSK

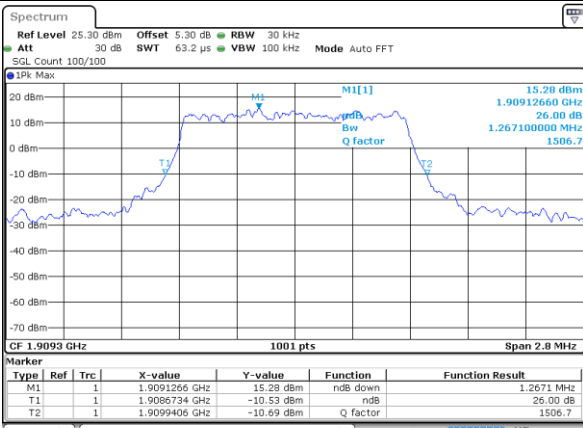

Date: 29 OCT 2018 16:22:37

Highest Channel / 1.4MHz / 16QAM

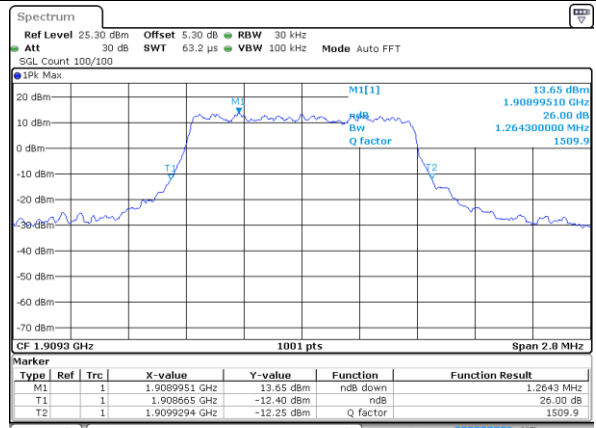

Date: 29 OCT 2018 16:22:47



LTE Band 2

Lowest Channel / 3MHz / QPSK

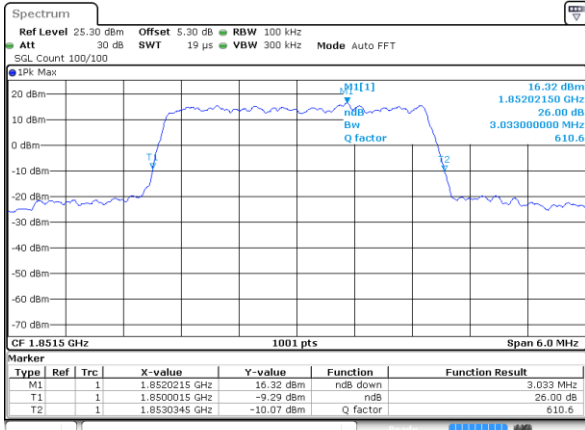

Date: 29 OCT 2018 16:29:37

Lowest Channel / 3MHz / 16QAM

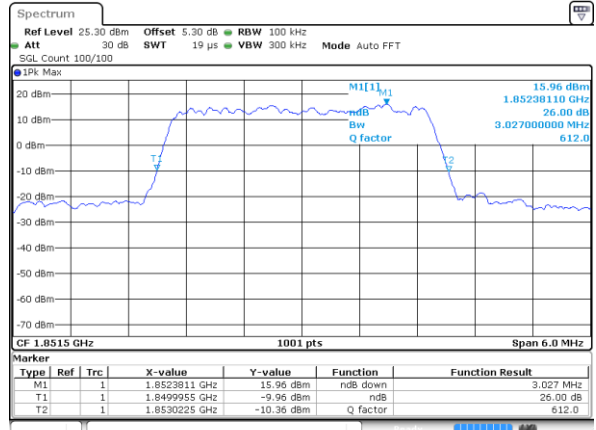

Date: 29 OCT 2018 16:29:47

Middle Channel / 3MHz / QPSK

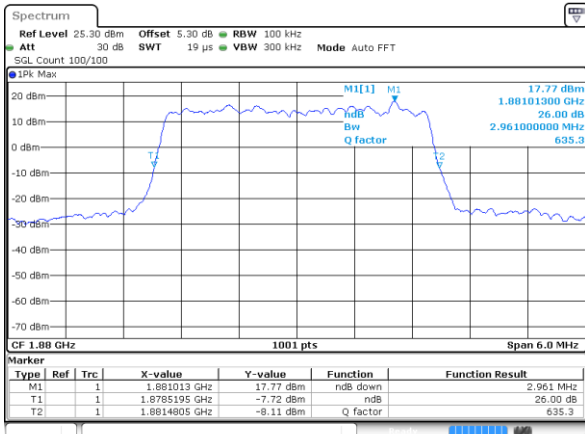

Date: 29 OCT 2018 16:44:56

Middle Channel / 3MHz / 16QAM

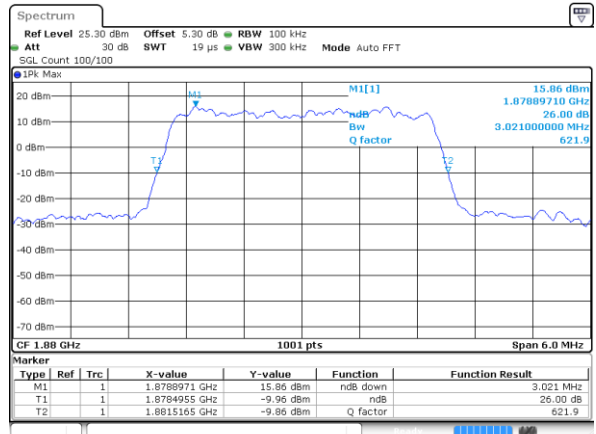

Date: 29 OCT 2018 16:45:06

Highest Channel / 3MHz / QPSK

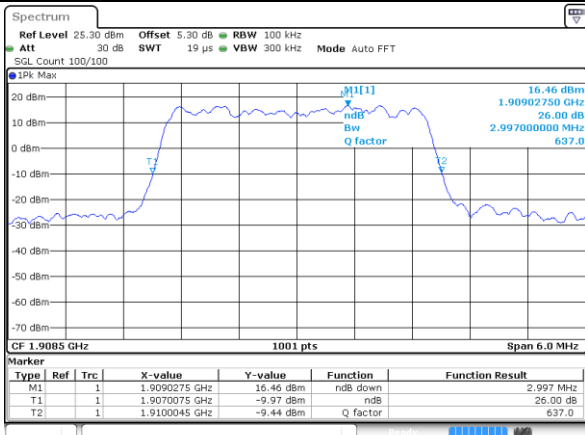

Date: 29 OCT 2018 16:47:26

Highest Channel / 3MHz / 16QAM

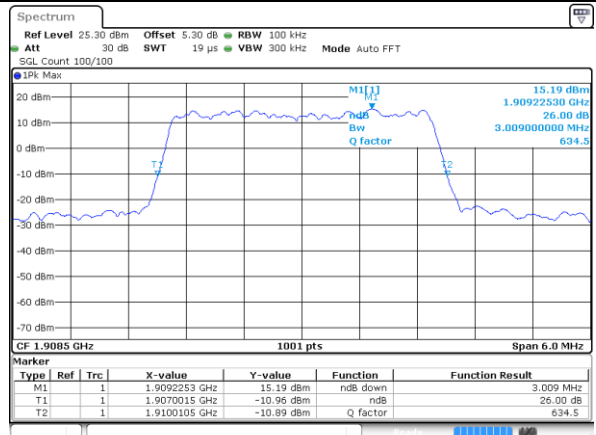

Date: 29 OCT 2018 16:47:36



LTE Band 2

Lowest Channel / 5MHz / QPSK

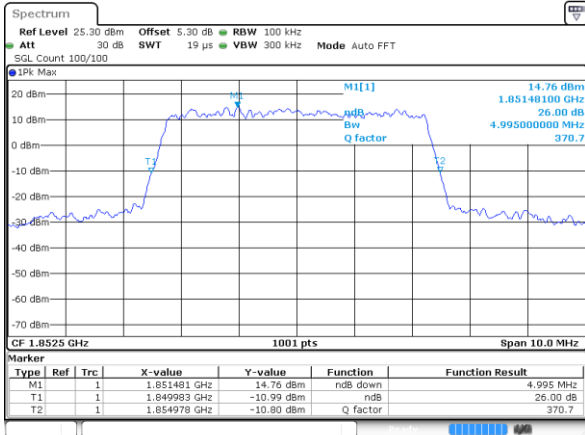

Date: 29 OCT 2018 16:54:25

Lowest Channel / 5MHz / 16QAM

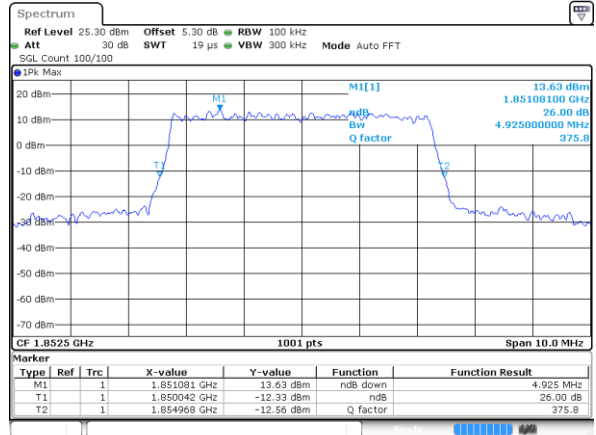

Date: 29 OCT 2018 16:54:35

Middle Channel / 5MHz / QPSK

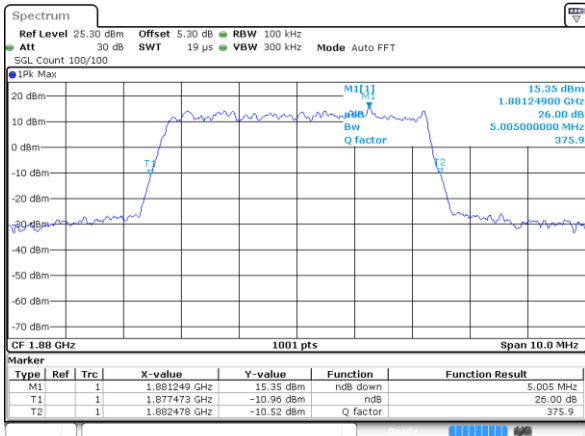

Date: 29 OCT 2018 17:01:24

Middle Channel / 5MHz / 16QAM

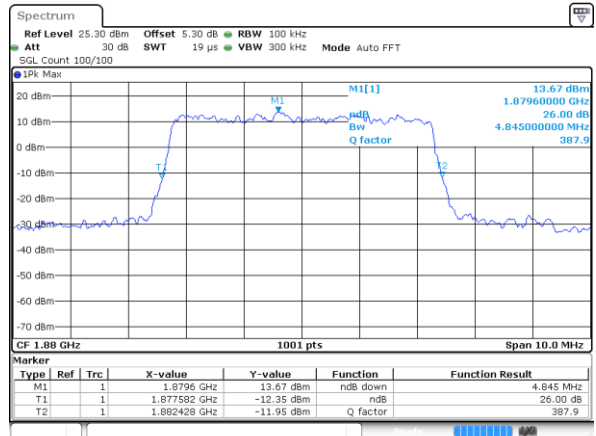

Date: 29 OCT 2018 17:01:34

Highest Channel / 5MHz / QPSK

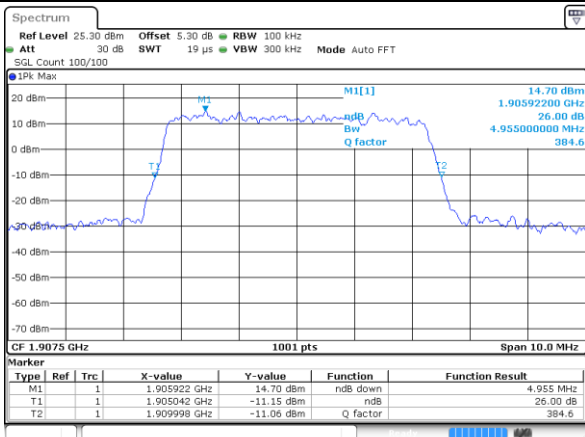

Date: 29 OCT 2018 17:03:53

Highest Channel / 5MHz / 16QAM

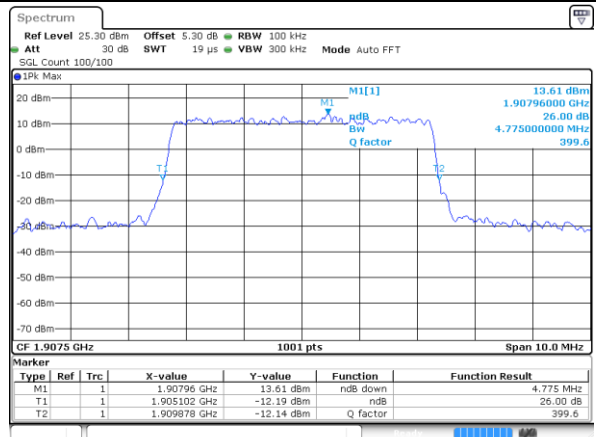

Date: 29 OCT 2018 17:04:03



LTE Band 2

Lowest Channel / 10MHz / QPSK

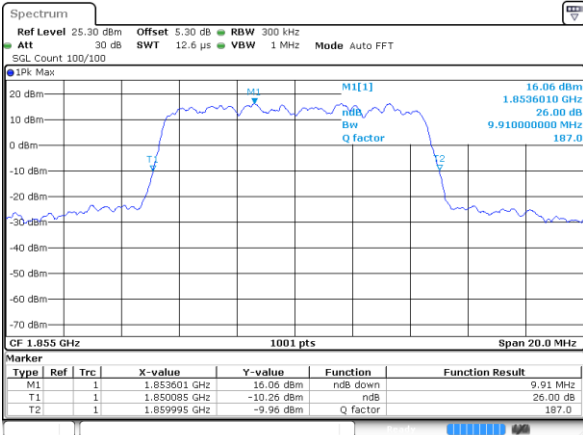

Date: 29 OCT 2018 17:10:52

Lowest Channel / 10MHz / 16QAM

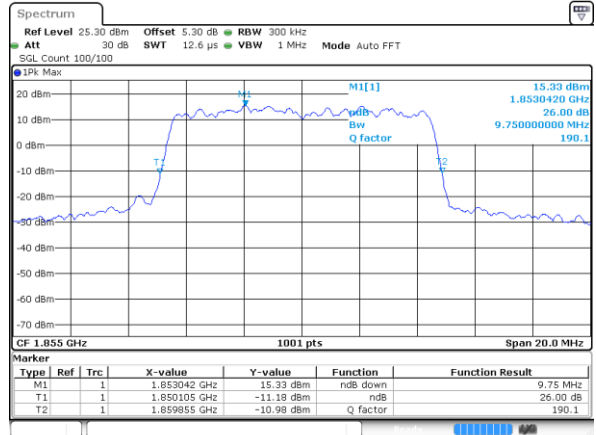

Date: 29 OCT 2018 17:11:02

Middle Channel / 10MHz / QPSK

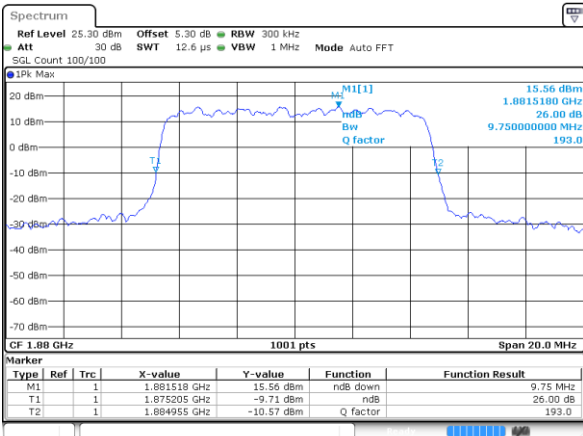

Date: 29 OCT 2018 17:17:51

Middle Channel / 10MHz / 16QAM

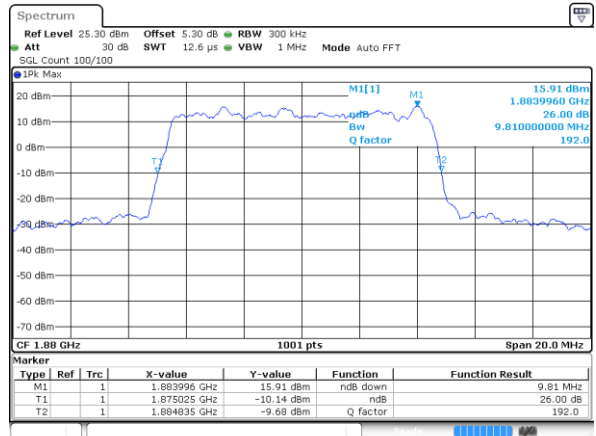

Date: 29 OCT 2018 17:18:01

Highest Channel / 10MHz / QPSK

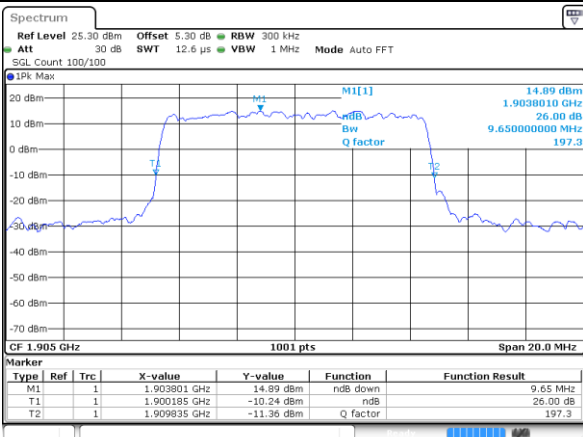

Date: 29 OCT 2018 17:20:20

Highest Channel / 10MHz / 16QAM

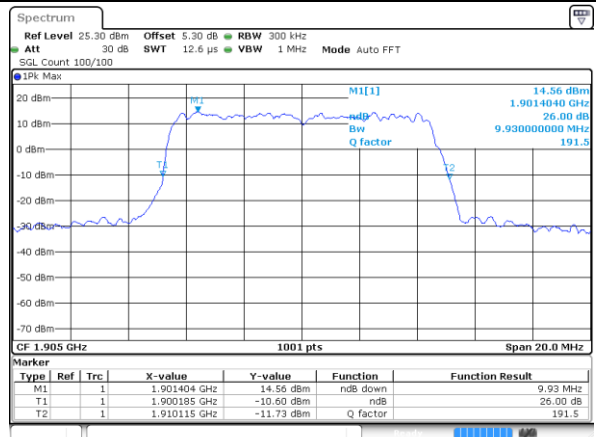

Date: 29 OCT 2018 17:20:30



LTE Band 2

Lowest Channel / 15MHz / QPSK

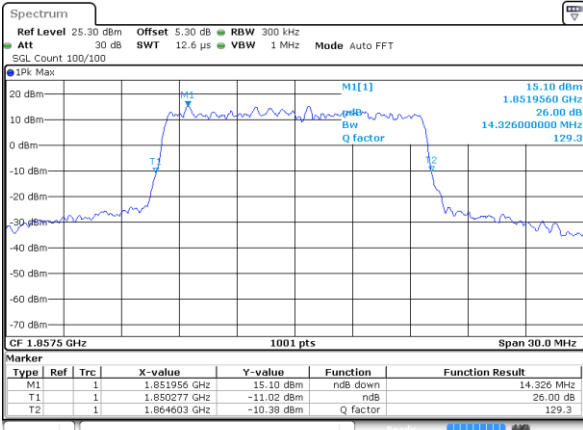

Date: 29 OCT 2018 17:27:19

Lowest Channel / 15MHz / 16QAM

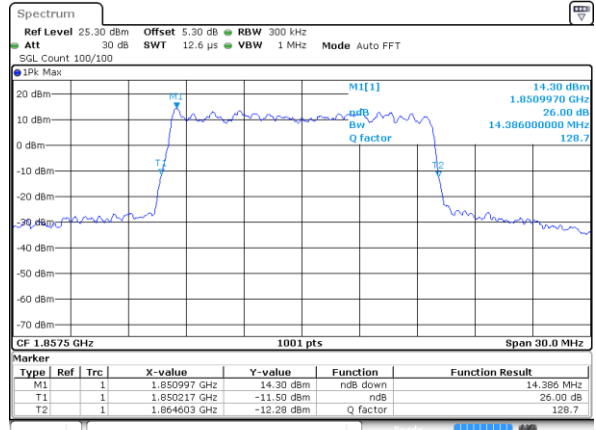

Date: 29 OCT 2018 17:27:29

Middle Channel / 15MHz / QPSK

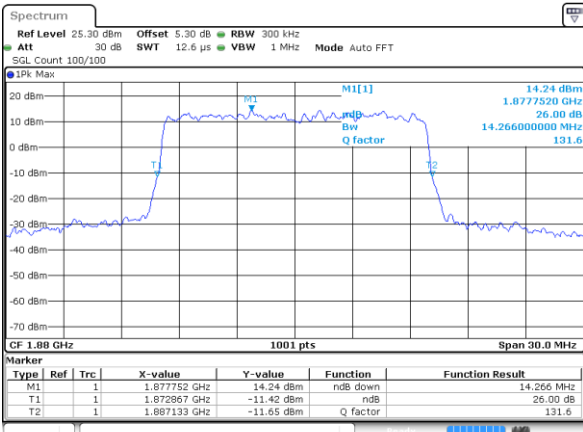

Date: 29 OCT 2018 17:34:19

Middle Channel / 15MHz / 16QAM

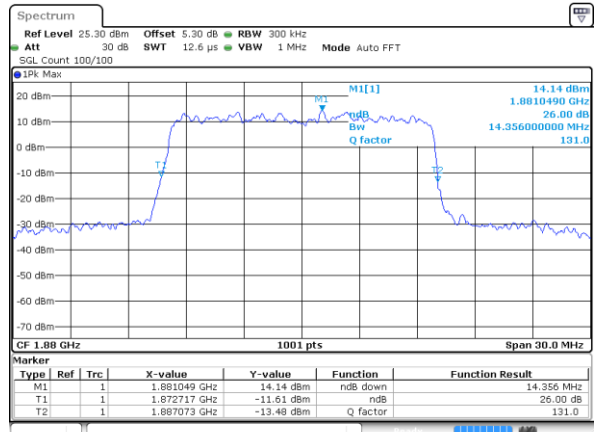

Date: 29 OCT 2018 17:34:29

Highest Channel / 15MHz / QPSK

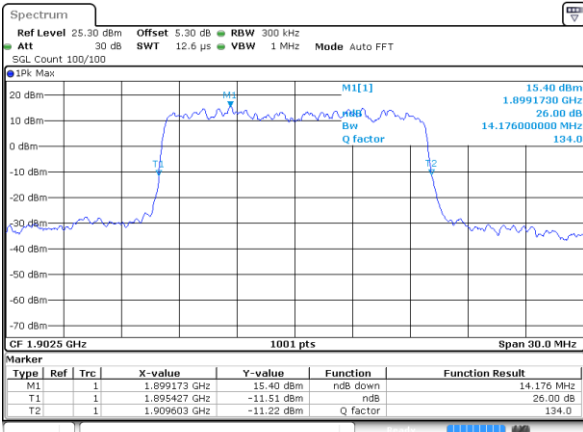

Date: 29 OCT 2018 17:36:48

Highest Channel / 15MHz / 16QAM

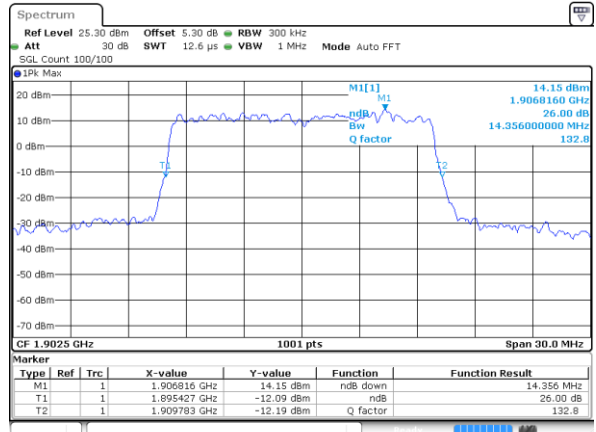

Date: 29 OCT 2018 17:36:58



LTE Band 2

Lowest Channel / 20MHz / QPSK

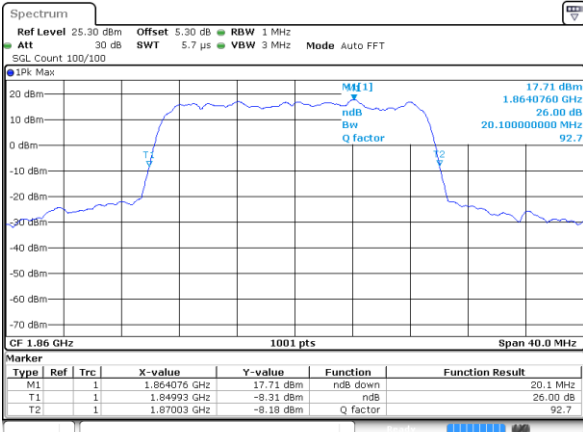

Date: 29 OCT 2018 17:43:47

Lowest Channel / 20MHz / 16QAM

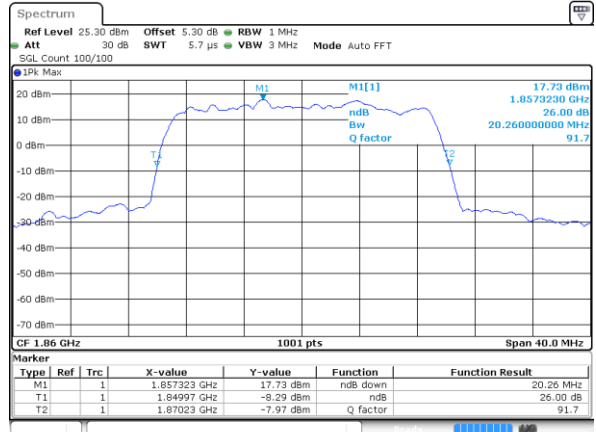

Date: 29 OCT 2018 17:43:57

Middle Channel / 20MHz / QPSK

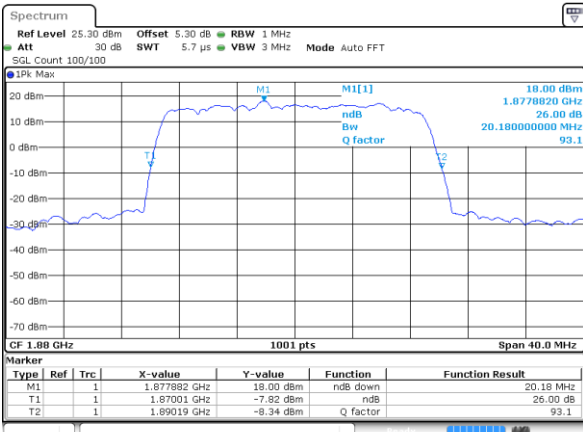

Date: 29 OCT 2018 17:50:47

Middle Channel / 20MHz / 16QAM

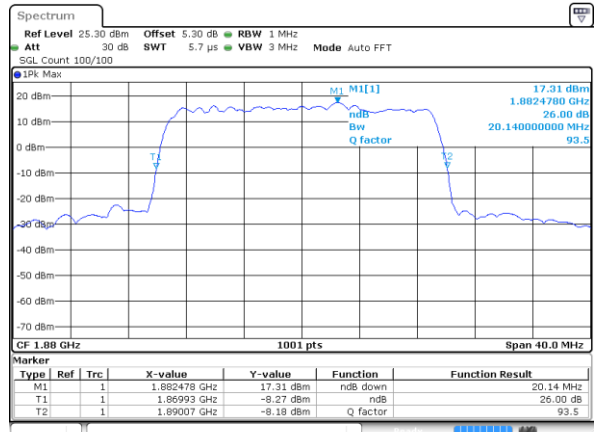

Date: 29 OCT 2018 17:50:57

Highest Channel / 20MHz / QPSK

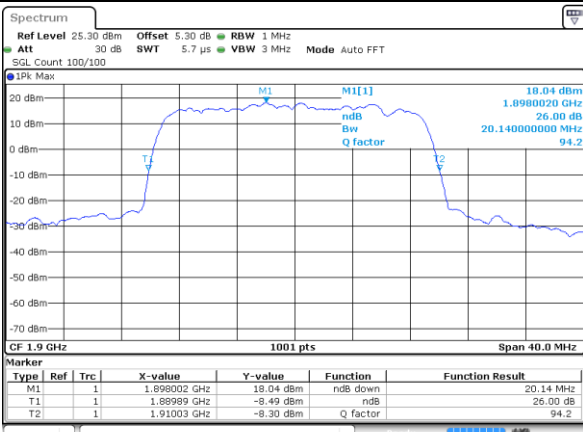

Date: 29 OCT 2018 17:53:16

Highest Channel / 20MHz / 16QAM

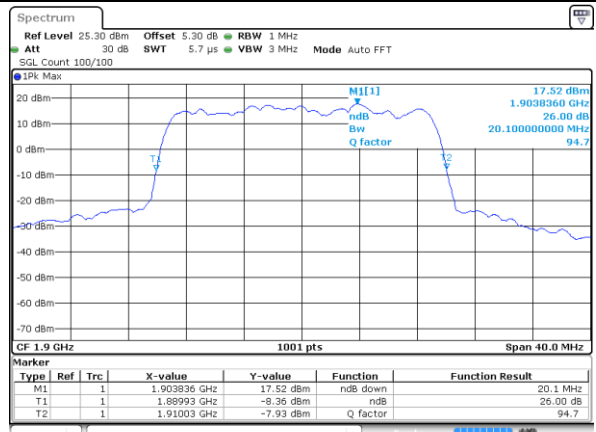

Date: 29 OCT 2018 17:53:26



LTE Band 4

Lowest Channel / 1.4MHz / QPSK

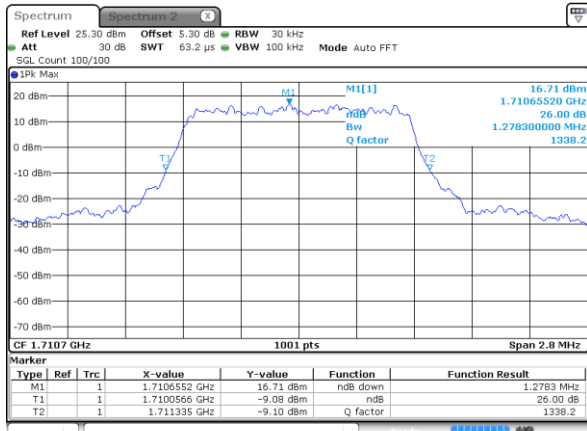

Date: 30.OCT.2018 10:49:44

Lowest Channel / 1.4MHz / 16QAM

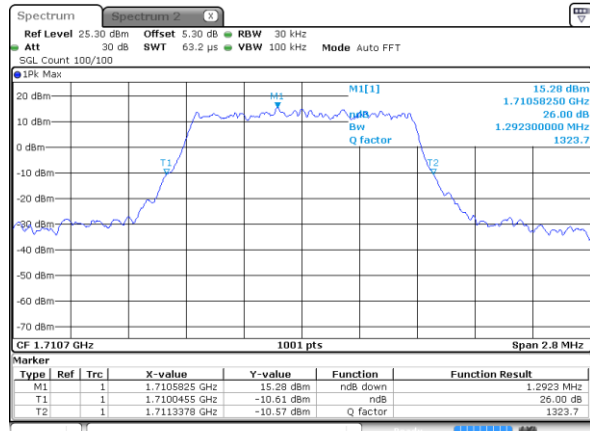

Date: 30.OCT.2018 10:49:54

Middle Channel / 1.4MHz / QPSK

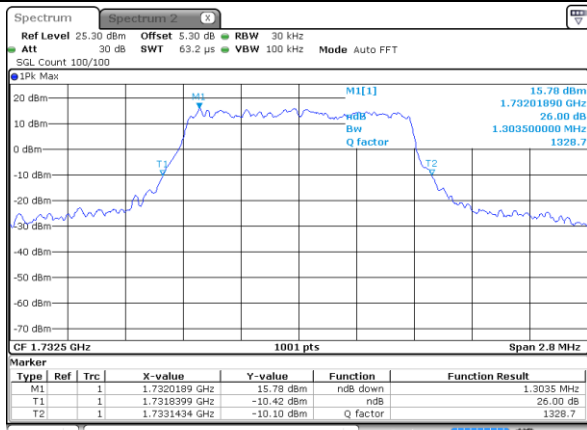

Date: 30.OCT.2018 11:09:04

Middle Channel / 1.4MHz / 16QAM

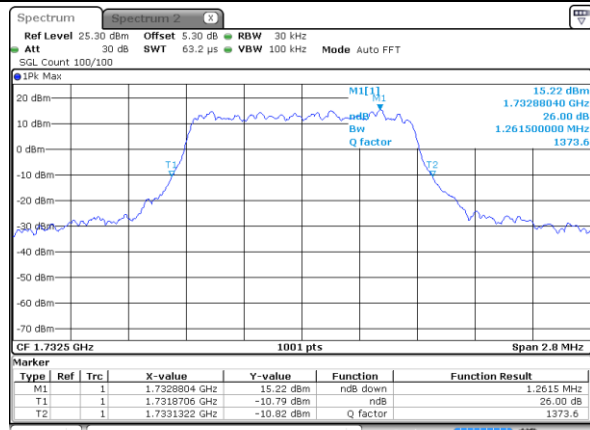

Date: 30.OCT.2018 11:09:14

Highest Channel / 1.4MHz / QPSK

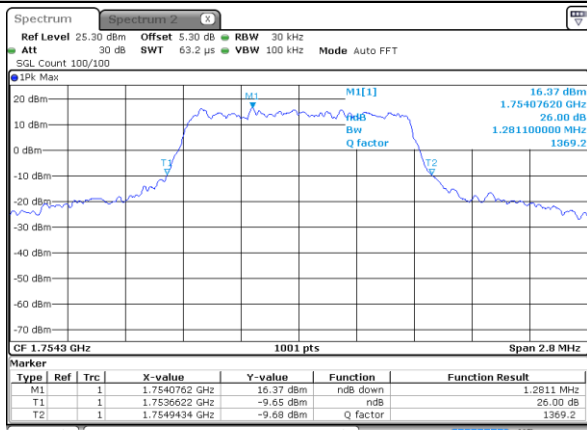

Date: 30.OCT.2018 11:11:34

Highest Channel / 1.4MHz / 16QAM

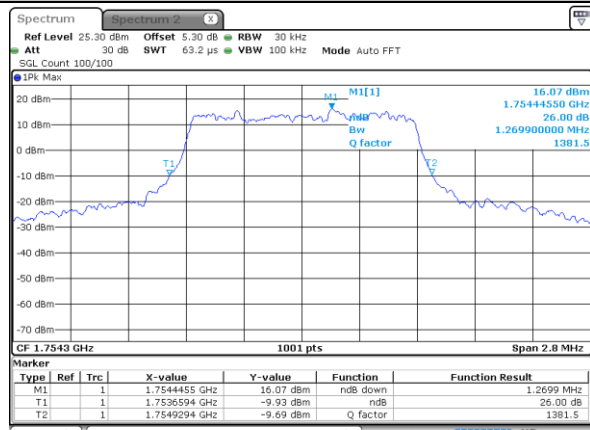

Date: 30.OCT.2018 11:11:44



LTE Band 4

Lowest Channel / 3MHz / QPSK

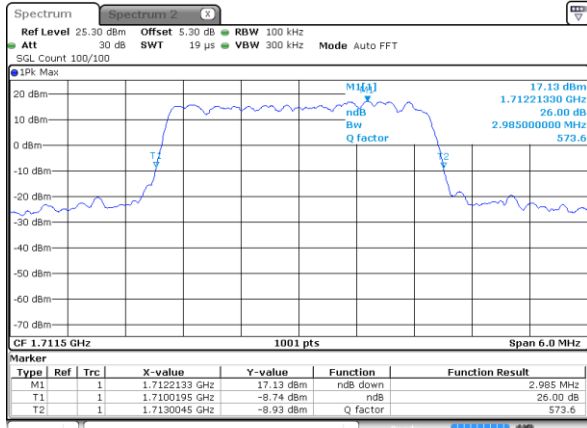

Date: 30.OCT.2018 11:18:34

Lowest Channel / 3MHz / 16QAM

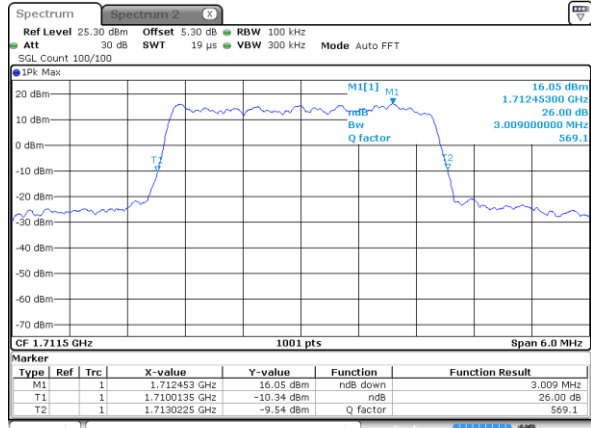

Date: 30.OCT.2018 11:18:44

Middle Channel / 3MHz / QPSK

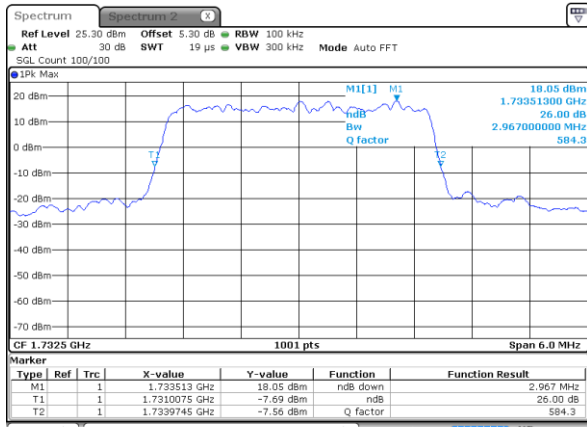

Date: 30.OCT.2018 11:25:34

Middle Channel / 3MHz / 16QAM

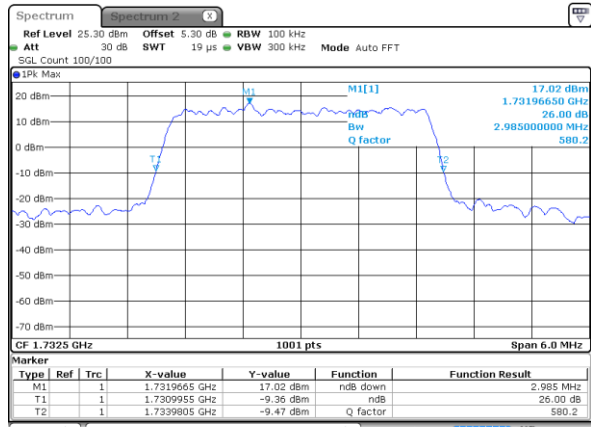

Date: 30.OCT.2018 11:25:44

Highest Channel / 3MHz / QPSK

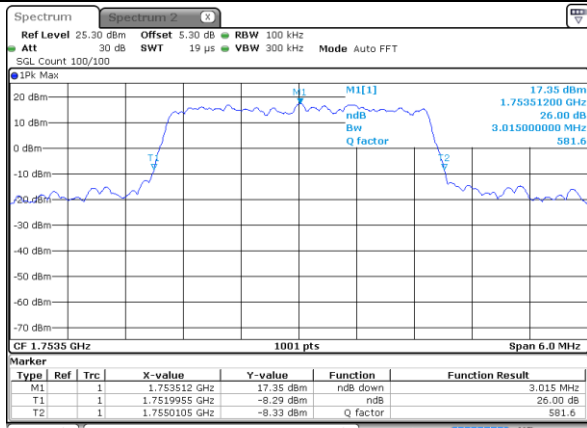

Date: 30.OCT.2018 11:28:04

Highest Channel / 3MHz / 16QAM

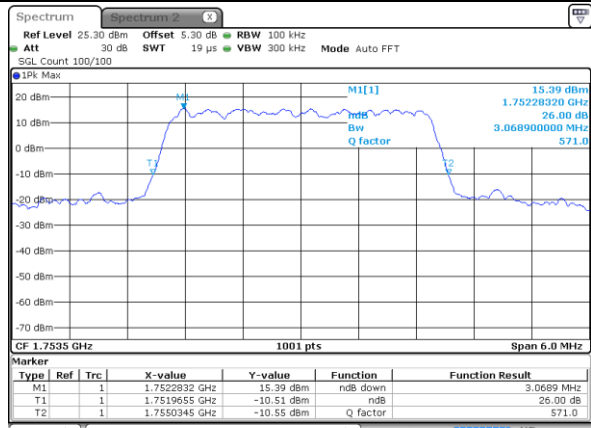

Date: 30.OCT.2018 11:28:14



LTE Band 4

Lowest Channel / 5MHz / QPSK

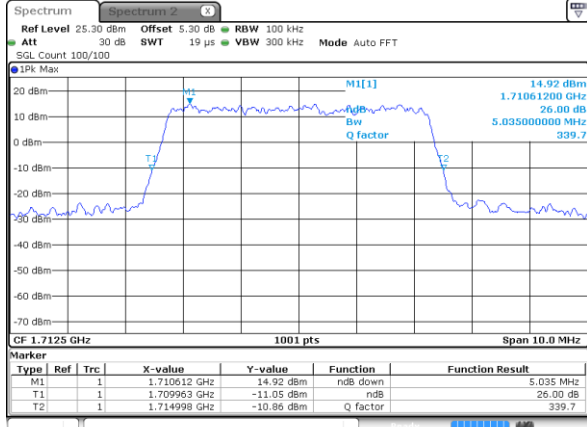

Date: 30.OCT.2018 11:35:04

Lowest Channel / 5MHz / 16QAM

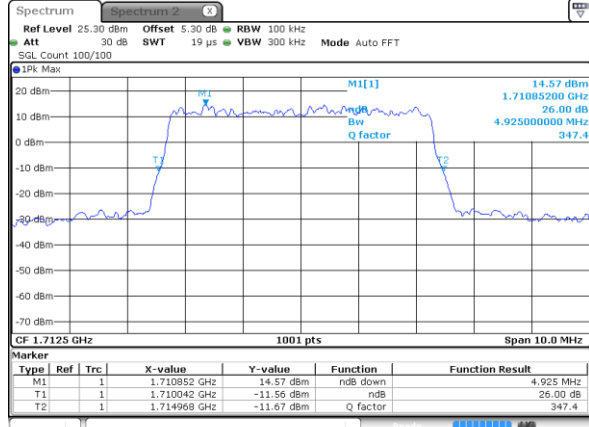

Date: 30.OCT.2018 11:35:14

Middle Channel / 5MHz / QPSK

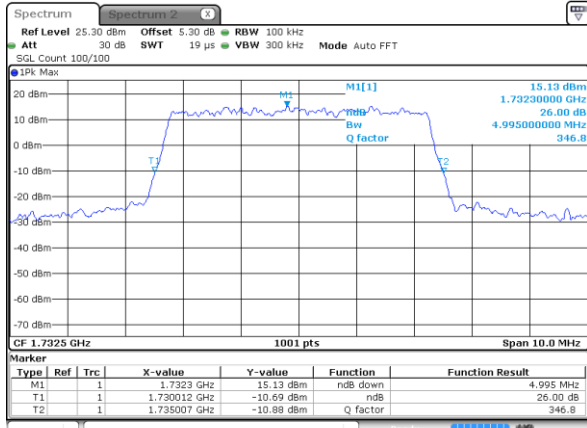

Date: 30.OCT.2018 11:42:04

Middle Channel / 5MHz / 16QAM

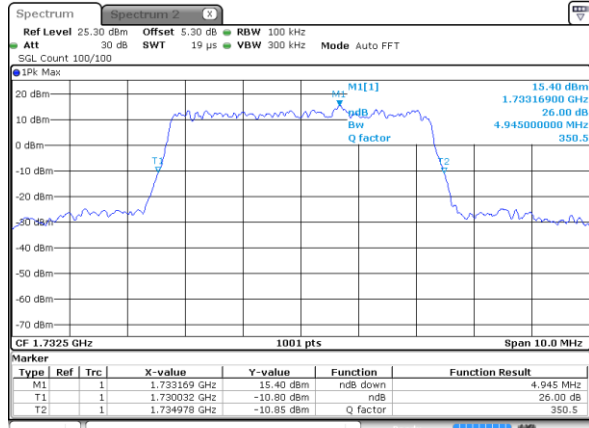

Date: 30.OCT.2018 11:42:14

Highest Channel / 5MHz / QPSK

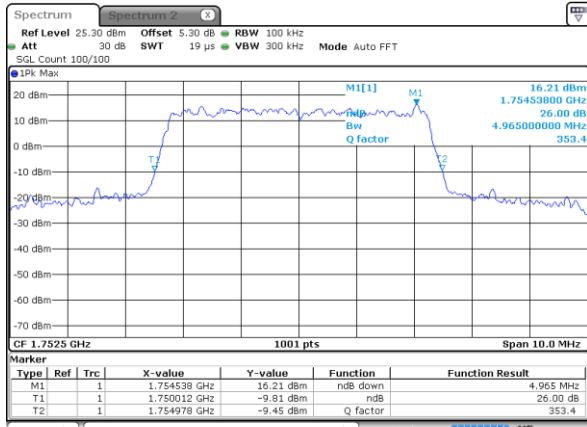

Date: 30.OCT.2018 11:44:34

Highest Channel / 5MHz / 16QAM

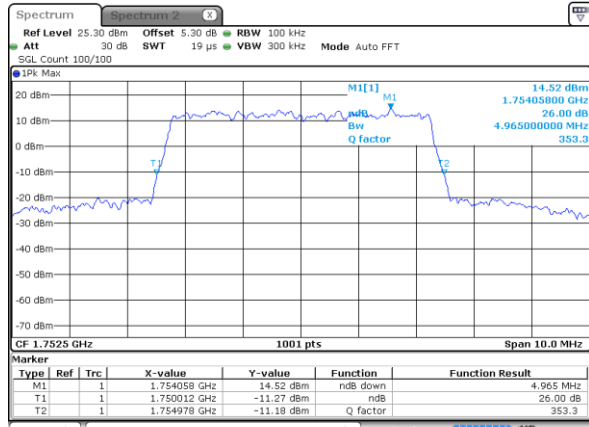

Date: 30.OCT.2018 11:44:44