



Test Report No.: RF170906W001-5



FCC TEST REPORT (PART 27)

Product: Integrated Smart Terminal
Model Name: E500
FCC ID: V5PE500FDD-LTE
Applicant: PAX Technology Limited
Address: Room 2416, 24/F., Sun Hung Kai Centre, 30 Harbour Road, Wanchai, Hong Kong
Manufacturer: PAX Computer Technology (Shenzhen) Co., Ltd.
Address: 4/F, No.3 Building, Software Park, Second Central Science-Tech Road, High-Tech industrial Park, Shenzhen, Guangdong, P.R.C.
Prepared by: BV 7Layers Communications Technology (Shenzhen) Co. Ltd
Lab Location: No.B102, Dazu Chuangxin Mansion, North of Beihuan Avenue, North Area, Hi-Tech Industrial Park, Nanshan District, Shenzhen, Guangdong, China
TEL: +86 755 8869 6566
FAX: +86 755 8869 6577
E-MAIL: customerservice.dg@cn.bureauveritas.com
Report No.: RF170906W001-5
Received Date: Sep. 06, 2017
Test Date: Sep. 07, 2017 ~ Sep. 22, 2017
Issued Date: Sep. 25, 2017

This report should not be used by the client to claim product certification, approval, or endorsement by A2LA or any government agencies.

This report is for your exclusive use. Any copying or replication of this report to or for any other person or entity, or use of our name or trademark, is permitted only with our prior written permission. This report sets forth our findings solely with respect to the test samples identified herein. The results set forth in this report are not indicative or representative of the quality or characteristics of the lot from which a test sample was taken or any similar or identical product unless specifically and expressly noted. Our report includes all of the tests requested by you and the results thereof based upon the information that you provided to us. You have 60 days from date of issuance of this report to notify us of any material error or omission caused by our negligence, provided, however, that such notice shall be in writing and shall specifically address the issue you wish to raise. A failure to raise such issue within the prescribed time shall constitute your unqualified acceptance of the completeness of this report, the tests conducted and the correctness of the report contents. Unless specific mention, the uncertainty of measurement has been explicitly taken into account to declare the compliance or non-compliance to the specification



TABLE OF CONTENTS

RELEASE CONTROL RECORD	4
1 CERTIFICATION.....	5
2 SUMMARY OF TEST RESULTS	6
2.1 MEASUREMENT UNCERTAINTY	6
2.2 TEST SITE AND INSTRUMENTS	7
3 GENERAL INFORMATION.....	8
3.1 GENERAL DESCRIPTION OF EUT.....	8
3.2 CONFIGURATION OF SYSTEM UNDER TEST	11
3.3 DESCRIPTION OF SUPPORT UNITS.....	12
3.4 DESCRIPTION OF TEST MODES.....	12
3.5 GENERAL DESCRIPTION OF APPLIED STANDARDS.....	17
4 TEST TYPES AND RESULTS	18
4.1 OUTPUT POWER MEASUREMENT	18
4.1.1 LIMITS OF OUTPUT POWER MEASUREMENT	18
4.1.2 TEST PROCEDURES	18
4.1.3 TEST SETUP.....	19
4.1.4 TEST RESULTS	20
4.2 FREQUENCY STABILITY MEASUREMENT	34
4.2.1 LIMITS OF FREQUENCY STABILITY MEASUREMENT.....	34
4.2.2 TEST PROCEDURE	34
4.2.3 TEST SETUP.....	34
4.2.4 TEST RESULTS	35
4.3 OCCUPIED BANDWIDTH MEASUREMENT	47
4.3.1 LIMITS OF OCCUPIED BANDWIDTH MEASUREMENT	47
4.3.2 TEST SETUP.....	47
4.3.3 TEST PROCEDURES	47
4.3.4 TEST RESULTS	48
4.4 PEAK TO AVERAGE RATIO	54
4.4.1 LIMITS OF PEAK TO AVERAGE RATIO MEASUREMENT.....	54
4.4.2 TEST SETUP.....	54
4.4.3 TEST PROCEDURES	54
4.4.4 TEST RESULTS	55
4.5 BAND EDGE MEASUREMENT	61
4.5.1 LIMITS OF BAND EDGE MEASUREMENT	61
4.5.2 TEST SETUP.....	61
4.5.3 TEST PROCEDURES	62
4.5.4 TEST RESULTS	63
4.6 CONDUCTED SPURIOUS EMISSIONS.....	75
4.6.1 LIMITS OF CONDUCTED SPURIOUS EMISSIONS MEASUREMENT	75
4.6.2 TEST PROCEDURE.....	75
4.6.3 TEST SETUP.....	75
4.6.4 TEST RESULTS	76
4.7 RADIATED EMISSION MEASUREMENT.....	88
4.7.1 LIMITS OF RADIATED EMISSION MEASUREMENT	88
4.7.2 TEST PROCEDURES	88
4.7.3 DEVIATION FROM TEST STANDARD	88



**BUREAU
VERITAS**

Test Report No.: RF170906W001-5

4.7.4	TEST SETUP	89
4.7.5	TEST RESULTS	90
5	INFORMATION ON THE TESTING LABORATORIES	128
6	APPENDIX A – MODIFICATIONS RECORDERS FOR ENGINEERING CHANGES TO THE EUT BY THE LAB	129



Test Report No.: RF170906W001-5

RELEASE CONTROL RECORD

ISSUE NO.	REASON FOR CHANGE	DATE ISSUED
RF170906W001-5	Original release	Sep. 25, 2017



Test Report No.: RF170906W001-5

1 CERTIFICATION

PRODUCT: Integrated Smart Terminal
BRAND NAME: PAX
MODEL NAME: E500
APPLICANT: PAX Technology Limited
TESTED: Sep. 07, 2017 ~ Sep. 22, 2017
TEST SAMPLE: Production Unit
TEST STANDARDS: **FCC Part 27, Subpart C, L**
FCC Part 2
ANSI/TIE/EIA-603-D
ANSI/TIA/EIA-603-E

The above equipment has been tested by **BV 7Layers Communications Technology (Shenzhen) Co. Ltd** and found compliance with the requirement of the above standards. The test record, data evaluation & Equipment Under Test (EUT) configurations represented herein are true and accurate accounts of the measurements of the sample's EMC characteristics under the conditions specified in this report.

PREPARED BY : Yuqiang Yin , **DATE:** Sep. 25, 2017
(Yuqiang Yin/ Engineer)

APPROVED BY : Bill Yao , **DATE:** Sep. 25, 2017
(Bill Yao / Manager)



2 SUMMARY OF TEST RESULTS

The EUT has been tested according to the following specifications:

APPLIED STANDARD: FCC Part 27 & Part 2			
STANDARD SECTION	TEST TYPE AND LIMIT	RESULT	REMARK
2.1046 27.50(d)(4)	Maximum Peak Output Power	PASS	Meet the requirement of limit.
2.1055 27.54	Frequency Stability	PASS	Meet the requirement of limit.
2.1049 27.53(h)	Occupied Bandwidth	PASS	Meet the requirement of limit.
27.50(d)(5)	Peak to average ratio	PASS	Meet the requirement of limit.
27.53(h)	Band Edge Measurements	PASS	Meet the requirement of limit.
2.1051 27.53(h)	Conducted Spurious Emissions	PASS	Meet the requirement of limit.
2.1053 27.53(h)	Radiated Spurious Emissions	PASS	Meet the requirement of limit. Minimum passing margin is -5.78dB at 76.560MHz.

2.1 MEASUREMENT UNCERTAINTY

Where relevant, the following measurement uncertainty levels have been estimated for tests performed on the EUT as specified in CISPR 16-4-2:

MEASUREMENT	FREQUENCY	UNCERTAINTY
Conducted emissions	9kHz~30MHz	2.66dB
Radiated emissions	9KHz ~ 30MHz	2.68dB
	30MHz ~ 1GMHz	3.26dB
	1GHz ~ 18GHz	4.48dB
	18GHz ~ 40GHz	4.12dB

This uncertainty represents an expanded uncertainty expressed at approximately the 95% confidence level using a coverage factor of k=2.



2.2 TEST SITE AND INSTRUMENTS

Equipment	Manufacturer	Model No.	Serial No.	Last Cal.	Next Cal.
MXE EMI Receiver	KEYSIGHT	N9038A-544	MY54450026	Mar. 01,17	Feb. 28,18
EXA Signal Analyzer	KEYSIGHT	N9010A-544	MY54510332	Mar. 01,17	Feb. 28,18
Bilog Antenna 1	ETS-LINDGREN	3143B	00161964	Nov. 26,16	Nov. 25,18
Bilog Antenna 2	ETS-LINDGREN	3143B	00161965	Nov. 26,16	Nov. 25,18
Horn Antenna 1	ETS-LINDGREN	3117	00168728	Nov. 26,16	Nov. 25,18
Horn Antenna 2	ETS-LINDGREN	3117	00168692	Nov. 26,16	Nov. 25,18
Loop antenna	Daze	ZN30900A	0708	Nov. 28,16	Nov. 27,17
Horn Antenna (18GHz-40GHz)	N/A	QWH-SL-18-40-K-SG/QMS-00361	15433	Dec. 16,16	Dec. 15,17
Radio Communication Analyzer	ANRITSU	MT8820C	6201465426	Mar. 01,17	Feb. 28,18
Signal Pre-Amplifier	EMSI	EMC 9135	980249	Jul. 24,17	Jul. 23,18
Signal Pre-Amplifier	EMSI	EMC 012645B	980257	Jul. 24,17	Jul. 23,18
Signal Pre-Amplifier	EMSI	EMC 184045B	980259	Jul. 24,17	Jul. 23,18
3m Semi-anechoic Chamber	ETS-LINDGREN	9m*6m*6m	Euroshieldpn-CT0001143-1216	May 06,17	May 05,18
Test Software	E3	V 9.160323	N/A	N/A	N/A
Test Software	ADT	ADT_Radiated_V7.6.15.9.2	N/A	N/A	N/A
10dB Attenuator	JFW/USA	50HF-010-SM A	1505	Jul. 24,17	Jul. 23,18
Power Meter	Anritsu	ML2495A	1506002	Mar. 01,17	Feb. 28,18
Power Sensor	Anritsu	MA2411B	1339352	Mar. 01,17	Feb. 28,18
Humid & Temp Programmable Tester	Juyi	ITH-120-45-CP-AR	IAA1504-001	Jul. 18,17	Jul. 17,18
MXG Analog Microwave Signal Generator	KEYSIGHT	N5183A	MY50143024	Mar. 01,17	Feb. 28,18

- NOTE:**
1. The calibration interval of the above test instruments is 12 months or 24 months and the calibrations are traceable to CEPREI/CHINA, GRGT/CHINA and NIM/CHINA.
 2. The test was performed in 3m Semi-anechoic Chamber and RF Oven Room.
 3. The horn antenna is used only for the measurement of emission frequency above 1GHz if tested.
 4. The FCC Site Registration No. is 525120.



3 GENERAL INFORMATION

3.1 GENERAL DESCRIPTION OF EUT

PRODUCT	Integrated Smart Terminal		
MODEL NAME	E500		
POWER SUPPLY	24Vdc (adapter or host equipment) 3.7Vdc (Li-ion, battery)		
MODULATION TECHNOLOGY	LTE	QPSK, 16QAM	
FREQUENCY RANGE	LTE Band 4 Channel Bandwidth: 1.4MHz	1710.7MHz ~ 1754.3MHz	
	LTE Band 4 Channel Bandwidth: 3MHz	1711.5MHz ~ 1753.5MHz	
	LTE Band 4 Channel Bandwidth: 5MHz	1712.5MHz ~ 1752.5MHz	
	LTE Band 4 Channel Bandwidth: 10MHz	1715.0MHz ~ 1750.0MHz	
	LTE Band 4 Channel Bandwidth: 15MHz	1717.5MHz ~ 1747.5MHz	
	LTE Band 4 Channel Bandwidth: 20MHz	1720.0MHz ~ 1745.0MHz	
	LTE Band 12 Channel Bandwidth: 1.4MHz	699.7MHz ~ 715.3MHz	
	LTE Band 12 Channel Bandwidth: 3MHz	700.5MHz ~ 714.5MHz	
	LTE Band 12 Channel Bandwidth: 5MHz	701.5MHz ~ 713.5MHz	
	LTE Band 12 Channel Bandwidth: 10MHz	704.0MHz ~ 711.0MHz	
	LTE Band 17 Channel Bandwidth: 5MHz	706.5MHz ~ 713.5MHz	
	LTE Band 17 Channel Bandwidth: 10MHz	709.0MHz ~ 711.0MHz	
	EMISSION DESIGNATOR	LTE Band 4 Channel Bandwidth: 1.4MHz	QPSK: 1M09G7D
			16QAM: 1M08W7D
LTE Band 4 Channel Bandwidth: 3MHz		QPSK: 2M69G7D	
		16QAM: 2M68W7D	
LTE Band 4 Channel Bandwidth: 5MHz		QPSK: 4M49G7D	
		16QAM: 4M47W7D	
LTE Band 4 Channel Bandwidth: 10MHz		QPSK: 8M93G7D	
		16QAM: 8M92W7D	



Test Report No.: RF170906W001-5

EMISSION DESIGNATOR	LTE Band 4 Channel Bandwidth: 15MHz	QPSK: 13M4G7D 16QAM: 13M4W7D
	LTE Band 4 Channel Bandwidth: 20MHz	QPSK: 17M9G7D 16QAM: 17M8W7D
	LTE Band 12 Channel Bandwidth: 1.4MHz	QPSK: 1M09G7D 16QAM: 1M08W7D
	LTE Band 12 Channel Bandwidth: 3MHz	QPSK: 2M69G7D 16QAM: 2M68W7D
	LTE Band 12 Channel Bandwidth: 5MHz	QPSK: 4M47G7D 16QAM: 4M46W7D
	LTE Band 12 Channel Bandwidth: 10MHz	QPSK: 8M92G7D 16QAM: 8M92W7D
	LTE Band 17 Channel Bandwidth: 5MHz	QPSK: 4M47G7D 16QAM: 4M48W7D
	LTE Band 17 Channel Bandwidth: 10MHz	QPSK: 8M91G7D 16QAM: 8M91W7D
	MAX. ERP/EIRP POWER	LTE Band 4 Channel Bandwidth: 1.4MHz
LTE Band 4 Channel Bandwidth: 3MHz		345mW
LTE Band 4 Channel Bandwidth: 5MHz		338mW
LTE Band 4 Channel Bandwidth: 10MHz		322mW
LTE Band 4 Channel Bandwidth: 15MHz		303mW
LTE Band 4 Channel Bandwidth: 20MHz		257mW
LTE Band 12 Channel Bandwidth: 1.4MHz		834mW
LTE Band 12 Channel Bandwidth: 3MHz		873mW
LTE Band 12 Channel Bandwidth: 5MHz		875mW
LTE Band 12 Channel Bandwidth: 10MHz		783mW
LTE Band 17 Channel Bandwidth: 5MHz		768mW
LTE Band 17 Channel Bandwidth: 10MHz		687mW



BUREAU
VERITAS

Test Report No.: RF170906W001-5

ANTENNA TYPE	LTE Band 4	Fixed Internal antenna with 4.6dBi
	LTE Band 12	Fixed Internal antenna with 2.9dBi
	LTE Band 17	Fixed Internal antenna with 2.9dBi
HW VERSION	E500-XXXXX-XXXX-XXX-XX	
SW VERSION	E500_PayDroid_6.0.1_Taurus_V05.1.00_20170913	
ACCESSORY DEVICE	Refer to note as below	
DATA CABLE	N/A	

NOTE:

- For a more detailed features description, please refer to the manufacturer's specifications or the user's manual.
- The EUT was powered by the following adapter:

ADAPTER	
BRAND:	HONOR
MODEL:	ADS-65HI-19A-3
INPUT:	AC 100-240V, 1500mA
OUTPUT:	DC 24V, 2700mA

- For the test results, the EUT had been tested with all conditions. But only the worst case was shown in test report.

3.2 CONFIGURATION OF SYSTEM UNDER TEST

FOR RADIATION EMISSION TEST

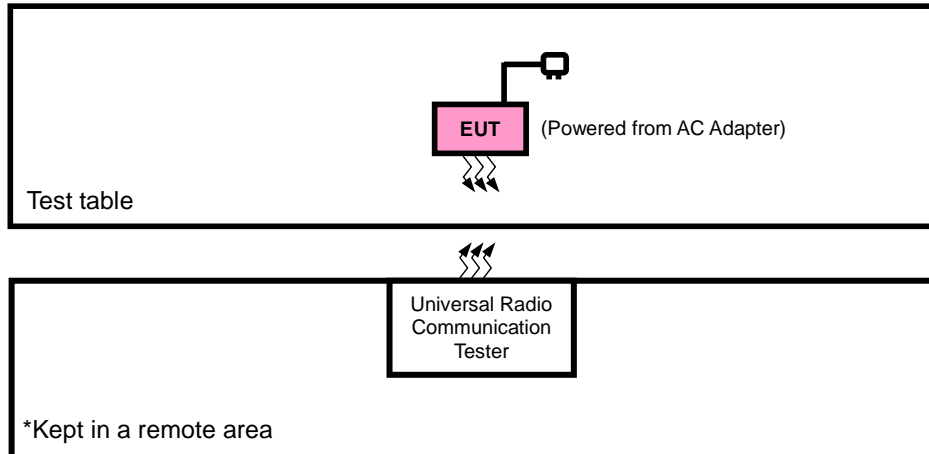

FOR CONDUCTED & E.R.P./E.I.R.P TEST

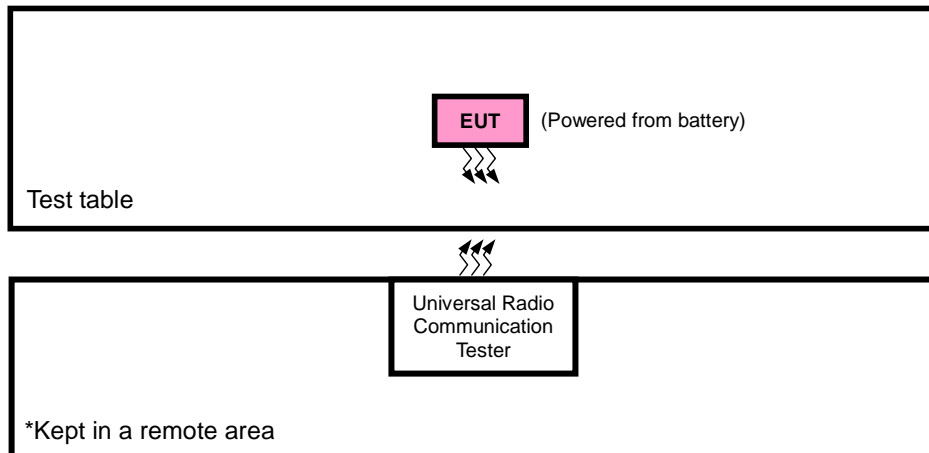



3.3 DESCRIPTION OF SUPPORT UNITS

The EUT has been tested as an independent unit together with other necessary accessories or support units. The following support units or accessories were used to form a representative test configuration during the tests.

NO.	PRODUCT	BRAND	MODEL NO.	SERIAL NO.	FCC ID
1	DC source	LONG WEI	PS-6403D	010934269	N/A
2	PC	HP	A6608CN	3CR83825X3	N/A

NO.	SIGNAL CABLE DESCRIPTION OF THE ABOVE SUPPORT UNITS
1	DC Line: Unshielded, Detachable 1.0m
2	AC Line: Unshielded, Detachable 1.5m

NOTE:

- 1. All power cords of the above support units are non shielded (1.8m).

3.4 DESCRIPTION OF TEST MODES

Pre-Scan has been conducted to determine the worst-case mode from all possible combinations between available modulations, data rates, XYZ axis and antenna ports. The worst case in ERP/EIRP and radiated emission was found when positioned on X-plane for LTE. Following channel(s) was (were) selected for the final test as listed below:

EUT CONFIGURE MODE	DESCRIPTION
A	EUT + Adapter with LTE link
B	EUT + Battery with LTE link



LTE BAND 4

EUT CONFIGURE MODE	TEST ITEM	AVAILABLE CHANNEL	TESTED CHANNEL	CHANNEL BANDWIDTH	MODULATION	MODE
B	EIRP	19957 to 20393	19957, 20175, 20393	1.4MHz	QPSK, 16QAM	1 RB / 0 RB Offset
		19965 to 20385	19965, 20175, 20385	3MHz	QPSK, 16QAM	1 RB / 0 RB Offset
		19975 to 20375	19975, 20175, 20375	5MHz	QPSK, 16QAM	1 RB / 0 RB Offset
		20000 to 20350	20000, 20175, 20350	10MHz	QPSK, 16QAM	1 RB / 0 RB Offset
		20025 to 20325	20025, 20175, 20325	15MHz	QPSK, 16QAM	1 RB / 0 RB Offset
		20050 to 20300	20050, 20175, 20300	20MHz	QPSK, 16QAM	1 RB / 0 RB Offset
B	FREQUENCY STABILITY	19957 to 20393	19957, 20393	1.4MHz	QPSK	1 RB / 0 RB Offset
		19965 to 20385	19965, 20385	3MHz	QPSK	1 RB / 0 RB Offset
		19975 to 20375	19975, 20375	5MHz	QPSK	1 RB / 0 RB Offset
		20000 to 20350	20000, 20350	10MHz	QPSK	1 RB / 0 RB Offset
		20025 to 20325	20025, 20325	15MHz	QPSK	1 RB / 0 RB Offset
		20050 to 20300	20050, 20300	20MHz	QPSK	1 RB / 0 RB Offset
B	OCCUPIED BANDWIDTH	19957 to 20393	19957, 20175, 20393	1.4MHz	QPSK, 16QAM	6 RB / 0 RB Offset
		19965 to 20385	19965, 20175, 20385	3MHz	QPSK, 16QAM	15 RB / 0 RB Offset
		19975 to 20375	19975, 20175, 20375	5MHz	QPSK, 16QAM	25 RB / 0 RB Offset
		20000 to 20350	20000, 20175, 20350	10MHz	QPSK, 16QAM	50 RB / 0 RB Offset
		20025 to 20325	20025, 20175, 20325	15MHz	QPSK, 16QAM	75 RB / 0 RB Offset
		20050 to 20300	20050, 20175, 20300	20MHz	QPSK, 16QAM	100 RB / 0 RB Offset
B	PEAK TO AVERAGE RATIO	19957 to 20393	19957, 20175, 20393	1.4MHz	QPSK, 16QAM	1 RB / 0 RB Offset
		19965 to 20385	19965, 20175, 20385	3MHz	QPSK, 16QAM	1 RB / 0 RB Offset
		19975 to 20375	19975, 20175, 20375	5MHz	QPSK, 16QAM	1 RB / 0 RB Offset
		20000 to 20350	20000, 20175, 20350	10MHz	QPSK, 16QAM	1 RB / 0 RB Offset
		20025 to 20325	20025, 20175, 20325	15MHz	QPSK, 16QAM	1 RB / 0 RB Offset
		20050 to 20300	20050, 20175, 20300	20MHz	QPSK, 16QAM	1 RB / 0 RB Offset
B	BAND EDGE	19957 to 20393	19957	1.4MHz	QPSK	1 RB / 0 RB Offset 6 RB / 0 RB Offset
			20393	1.4MHz	QPSK	1 RB / 5 RB Offset 6 RB / 0 RB Offset
		19965 to 20385	19965	3MHz	QPSK	1 RB / 0 RB Offset 15 RB / 0 RB Offset
			20385	3MHz	QPSK	1 RB / 14 RB Offset 15 RB / 0 RB Offset
		19975 to 20375	19975	5MHz	QPSK	1 RB / 0 RB Offset 25 RB / 0 RB Offset
			20375	5MHz	QPSK	1 RB / 24 RB Offset 25 RB / 0 RB Offset
		20000 to 20350	20000	10MHz	QPSK	1 RB / 0 RB Offset 50 RB / 0 RB Offset
			20350	10MHz	QPSK	1 RB / 49 RB Offset 50 RB / 0 RB Offset



Test Report No.: RF170906W001-5

B	BAND EDGE	20025 to 20325	20025	15MHz	QPSK	1 RB / 0 RB Offset
			20325	15MHz	QPSK	75 RB / 0 RB Offset
		20050 to 20300	20050	20MHz	QPSK	1 RB / 74 RB Offset
			20300	20MHz	QPSK	75 RB / 0 RB Offset
			20050	20MHz	QPSK	1 RB / 0 RB Offset
			20300	20MHz	QPSK	100 RB / 0 RB Offset
B	CONDCUDED EMISSION	19957 to 20393	19957, 20175, 20393	1.4MHz	QPSK	1 RB / 0 RB Offset
		19965 to 20385	19965, 20175, 20385	3MHz	QPSK	1 RB / 0 RB Offset
		19975 to 20375	19975, 20175, 20375	5MHz	QPSK	1 RB / 0 RB Offset
		20000 to 20350	20000, 20175, 20350	10MHz	QPSK	1 RB / 0 RB Offset
		20025 to 20325	20025, 20175, 20325	15MHz	QPSK	1 RB / 0 RB Offset
		20050 to 20300	20050, 20175, 20300	20MHz	QPSK	1 RB / 0 RB Offset
A	RADIATED EMISSION	19957 to 20393	20175	1.4MHz	QPSK	1 RB / 0 RB Offset
		19965 to 20385	20175	3MHz	QPSK	1 RB / 0 RB Offset
		19975 to 20375	19975, 20175, 20375	5MHz	QPSK	1 RB / 0 RB Offset
		20000 to 20350	20175	10MHz	QPSK	1 RB / 0 RB Offset
		20025 to 20325	20175	15MHz	QPSK	1 RB / 0 RB Offset
		20050 to 20300	20175	20MHz	QPSK	1 RB / 0 RB Offset

Note: This device was tested under all bandwidths, RB configurations and modulations. The worst case was found in QPSK modulation.



Test Report No.: RF170906W001-5

LTE BAND 12

EUT CONFIGURE MODE	TEST ITEM	AVAILABLE CHANNEL	TESTED CHANNEL	CHANNEL BANDWIDTH	MODULATION	MODE		
B	ERP	23017 to 23173	23017, 23095 , 23173	1.4MHz	QPSK,16QAM	1 RB / 0 RB Offset		
		23025 to 23165	23025, 23095 ,23165	3MHz	QPSK,16QAM	1 RB / 0 RB Offset		
		23035 to 23155	23035, 23095 ,23155	5MHz	QPSK,16QAM	1 RB / 0 RB Offset		
		23060 to 23130	23060, 23095 ,23130	10MHz	QPSK,16QAM	1 RB / 0 RB Offset		
B	FREQUENCY STABILITY	23017 to 23173	23017, 23173	1.4MHz	QPSK	1 RB / 0 RB Offset		
		23025 to 23165	23025, 23165	3MHz	QPSK	1 RB / 0 RB Offset		
		23035 to 23155	23035, 23155	5MHz	QPSK	1 RB / 0 RB Offset		
		23060 to 23130	23060, 23130	10MHz	QPSK	1 RB / 0 RB Offset		
B	OCCUPIED BANDWIDTH	23017 to 23173	23017, 23095 , 23173	1.4MHz	QPSK,16QAM	6 RB / 0 RB Offset		
		23025 to 23165	23025, 23095 ,23165	3MHz	QPSK,16QAM	15 RB / 0 RB Offset		
		23035 to 23155	23035, 23095 ,23155	5MHz	QPSK,16QAM	25 RB / 0 RB Offset		
		23060 to 23130	23060, 23095 ,23130	10MHz	QPSK,16QAM	50 RB / 0 RB Offset		
B	PEAK TO AVERAGE RATIO	23017 to 23173	23017, 23095 , 23173	1.4MHz	QPSK, 16QAM	1 RB / 0 RB Offset		
		23025 to 23165	23025, 23095 ,23165	3MHz	QPSK, 16QAM	1 RB / 0 RB Offset		
		23035 to 23155	23035, 23095 ,23155	5MHz	QPSK, 16QAM	1 RB / 0 RB Offset		
		23060 to 23130	23060, 23095 ,23130	10MHz	QPSK, 16QAM	1 RB / 0 RB Offset		
B	BAND EDGE	23017 to 23173	23017	1.4MHz	QPSK	1 RB / 0 RB Offset 6 RB / 0 RB Offset		
			23173	1.4MHz	QPSK	1 RB / 5 RB Offset 6 RB / 0 RB Offset		
		23025 to 23165	23025	3MHz	QPSK	1 RB / 0 RB Offset 15 RB / 0 RB Offset		
			23165	3MHz	QPSK	1 RB / 14 RB Offset 15 RB / 0 RB Offset		
		23035 to 23155	23035	5MHz	QPSK	1 RB / 0 RB Offset 25 RB / 0 RB Offset		
			23155	5MHz	QPSK	1 RB / 24 RB Offset 25 RB / 0 RB Offset		
		23060 to 23130	23060	10MHz	QPSK	1 RB / 0 RB Offset 50 RB / 0 RB Offset		
			23130	10MHz	QPSK	1 RB / 49 RB Offset 50 RB / 0 RB Offset		
		B	CONDCUDED EMISSION	23017 to 23173	23017, 23095 , 23173	1.4MHz	QPSK	1 RB / 0 RB Offset
				23025 to 23165	23025, 23095 ,23165	3MHz	QPSK	1 RB / 0 RB Offset
				23035 to 23155	23035, 23095 ,23155	5MHz	QPSK	1 RB / 0 RB Offset
				23060 to 23130	23060, 23095 ,23130	10MHz	QPSK	1 RB / 0 RB Offset
A	RADIATED EMISSION	23017 to 23173	23095	1.4MHz	QPSK	1 RB / 0 RB Offset		
		23025 to 23165	23025, 23095 ,23165	3MHz	QPSK	1 RB / 0 RB Offset		
		23035 to 23155	23095	5MHz	QPSK	1 RB / 0 RB Offset		
		23060 to 23130	23095	10MHz	QPSK	1 RB / 0 RB Offset		



Test Report No.: RF170906W001-5

LTE BAND 17

EUT CONFIGURE MODE	TEST ITEM	AVAILABLE CHANNEL	TESTED CHANNEL	CHANNEL BANDWIDTH	MODULATION	MODE
B	ERP	23755 to 23825	23755, 23790, 23825	5MHz	QPSK, 16QAM	1 RB / 0 RB Offset
		23780 to 23800	23780, 23790, 23800	10MHz	QPSK, 16QAM	1 RB / 0 RB Offset
B	FREQUENCY STABILITY	23755 to 23825	23790	5MHz	QPSK	1 RB / 0 RB Offset
		23780 to 23800	23790	10MHz	QPSK	1 RB / 0 RB Offset
B	OCCUPIED BANDWIDTH	23755 to 23825	23755, 23790, 23825	5MHz	QPSK, 16QAM	25 RB / 0 RB Offset
		23780 to 23800	23780, 23790, 23800	10MHz	QPSK, 16QAM	50 RB / 0 RB Offset
B	PEAK TO AVERAGE RATIO	23755 to 23825	23755, 23790, 23825	5MHz	QPSK, 16QAM	1 RB / 0 RB Offset
		23780 to 23800	23780, 23790, 23800	10MHz	QPSK, 16QAM	1 RB / 0 RB Offset
B	BAND EDGE	23755 to 23825	23755	5MHz	QPSK	1 RB / 0 RB Offset 25 RB / 0 RB Offset
			23825	5MHz	QPSK	1 RB / 24 RB Offset 25 RB / 0 RB Offset
		23780 to 23800	23780	10MHz	QPSK	1 RB / 0 RB Offset 50 RB / 0 RB Offset
			23800	10MHz	QPSK	1 RB / 49 RB Offset 50 RB / 0 RB Offset
B	CONDCUDED EMISSION	23755 to 23825	23755, 23790, 23825	5MHz	QPSK	1 RB / 0 RB Offset
		23780 to 23800	23780, 23790, 23800	10MHz	QPSK	1 RB / 0 RB Offset
A	RADIATED EMISSION	23755 to 23825	23790	5MHz	QPSK	1 RB / 0 RB Offset
		23780 to 23800	23780, 23790, 23800	10MHz	QPSK	1 RB / 0 RB Offset

Note: This device was tested under all bandwidths, RB configurations and modulations. The worst case was found in QPSK modulation.

TEST CONDITION:

TEST ITEM	ENVIRONMENTAL CONDITIONS	INPUT POWER	TESTED BY
EIRP(ERP)	24deg. C, 60%RH	3.7Vdc from Battery	Simon Yang
FREQUENCY STABILITY	24deg. C, 61%RH	DC 22V/24V/26V	Wenliang Wu
OCCUPIED BANDWIDTH	24deg. C, 61%RH	3.7Vdc from Battery	Wenliang Wu
PEAK TO AVERAGE RATIO	24deg. C, 61%RH	3.7dc from Battery	Wenliang Wu
BAND EDGE	24deg. C, 61%RH	3.7Vdc from Battery	Wenliang Wu
CONDCUDED EMISSION	24deg. C, 61%RH	24Vdc from adapter	Wenliang Wu
RADIATED EMISSION	24deg. C, 60%RH	24Vdc from adapter	Simon Yang



Test Report No.: RF170906W001-5

3.5 GENERAL DESCRIPTION OF APPLIED STANDARDS

The EUT is a RF product. According to the specifications of the manufacturer, it must comply with the requirements of the following standards:

FCC 47 CFR Part 2

FCC 47 CFR Part 27

KDB 971168 D01 Power Meas License Digital Systems v02r02

ANSI/TIA/EIA-603-D

ANSI/TIA/EIA-603-E

NOTE: All test items have been performed and recorded as per the above standards.



4 TEST TYPES AND RESULTS

4.1 OUTPUT POWER MEASUREMENT

4.1.1 LIMITS OF OUTPUT POWER MEASUREMENT

Fixed, mobile, and portable (hand-held) stations operating in the 1710–1755 MHz band are limited to 1 watt EIRP.

Portable stations (hand-held devices) operating in the 699-716 MHz bands are limited to 3 watts ERP.

4.1.2 TEST PROCEDURES

EIRP / ERP MEASUREMENT:

- a. The EUT was set up for the maximum power with LTE link data modulation. The power was measured with R&S Spectrum Analyzer. All measurements were done at 3 channels (low, middle and high operational frequency range). RBW and VBW is 10MHz for LTE.
- b. E.I.R.P power measurement. In the semi-anechoic chamber, EUT placed on the 0.8m height of Turn Table, rotated the table around 360 degrees to search the maximum radiation power and receiver antenna shall be rotated vertical and horizontal polarization and moved height from 1m to 4m to find the maximum polar radiated power. The “Read Value” is the spectrum reading the maximum power value.
- c. The substitution horn antenna is substituted for EUT at the same position and signals generator export the CW signal to the substitution antenna via a TX cable. Rotated the Turn Table and moved receiving antenna to find the maximum radiation power. Adjust output power level of S.G to get a Value of spectrum reading equal to “Read Value” of step a. Record the power level of S.G
- d. $EIRP = \text{Output power level of S.G} - \text{TX cable loss} + \text{Antenna gain of substitution horn}$
- e. $E.R.P = E.I.R.P - 2.15 \text{ dB}$

CONDUCTED POWER MEASUREMENT:

- a. The EUT was set up for the maximum power with LTE link data modulation and link up with simulator.
- b. Set the EUT to transmit under low, middle and high channel and record the power level shown on simulator.

4.1.3 TEST SETUP

EIRP / ERP MEASUREMENT:

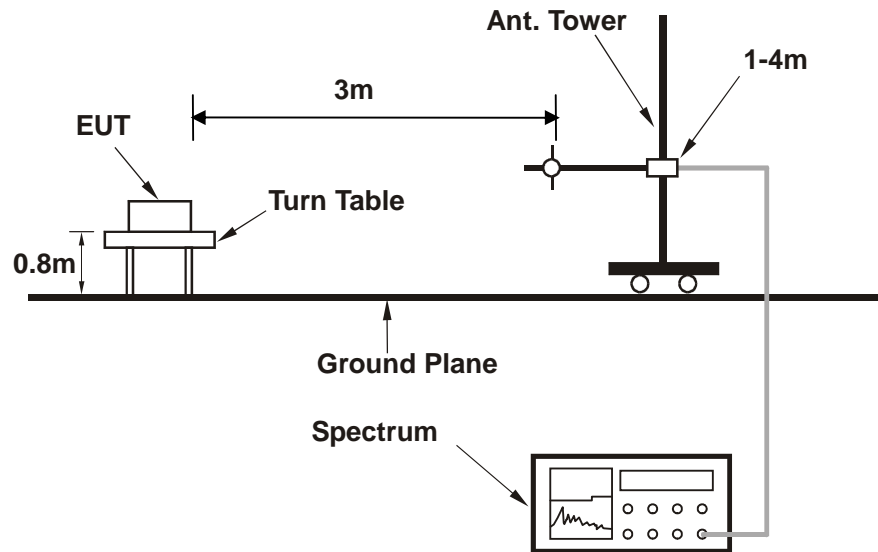

For the actual test configuration, please refer to the attached file (Test Setup Photo).

CONDUCTED POWER MEASUREMENT:

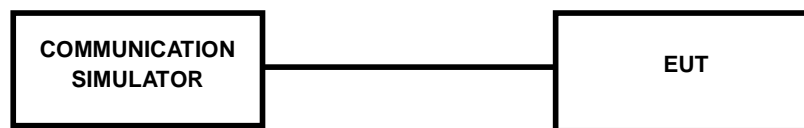

For the actual test configuration, please refer to the attached file (Test Setup Photo).



4.1.4 TEST RESULTS

AVERAGE CONDUCTED OUTPUT POWER (dBm)

LTE Band 4							
BW	Modulation	RB Size	RB Offset	Low CH 19957	Mid CH 20175	High CH 20393	MPR
				Frequency 1710.7 MHz	Frequency 1732.5 MHz	Frequency 1754.3 MHz	
1.4MHz	QPSK	1	0	21.44	21.65	21.73	0
		1	2	21.33	21.54	21.62	0
		1	5	21.32	21.53	21.61	0
		3	0	21.42	21.63	21.71	0
		3	1	21.31	21.52	21.60	0
		3	3	21.30	21.51	21.59	0
		6	0	20.41	20.62	20.70	1
	16QAM	1	0	20.39	20.60	20.68	1
		1	2	20.28	20.49	20.57	1
		1	5	20.27	20.48	20.56	1
		3	0	20.38	20.59	20.67	1
		3	1	20.27	20.48	20.56	1
		3	3	20.26	20.47	20.55	1
		6	0	19.36	19.57	19.65	2
BW	Modulation	RB Size	RB Offset	Low CH 19965	Mid CH 20175	High CH 20385	MPR
				Frequency 1711.5 MHz	Frequency 1732.5 MHz	Frequency 1753.5 MHz	
3 MHz	QPSK	1	0	21.45	21.66	21.74	0
		1	7	21.34	21.55	21.63	0
		1	14	21.33	21.54	21.62	0
		8	0	20.41	20.62	20.70	1
		8	3	20.32	20.53	20.61	1
		8	7	20.35	20.56	20.64	1
		15	0	20.42	20.63	20.71	1
	16QAM	1	0	20.40	20.61	20.69	1
		1	7	20.29	20.50	20.58	1
		1	14	20.28	20.49	20.57	1
		8	0	19.36	19.57	19.65	2
		8	3	19.27	19.48	19.56	2
		8	7	19.30	19.51	19.59	2
		15	0	19.37	19.58	19.66	2



Test Report No.: RF170906W001-5

LTE Band 4							
BW	Modulation	RB Size	RB Offset	Low CH 19975	Mid CH 20175	High CH 20375	MPR
				Frequency 1712.5 MHz	Frequency 1732.5 MHz	Frequency 1752.5 MHz	
5 MHz	QPSK	1	0	21.48	21.69	21.77	0
		1	12	21.37	21.58	21.66	0
		1	24	21.36	21.57	21.65	0
		12	0	20.44	20.65	20.73	1
		12	6	20.35	20.56	20.64	1
		12	13	20.38	20.59	20.67	1
		25	0	20.45	20.66	20.74	1
	16QAM	1	0	20.43	20.64	20.72	1
		1	12	20.32	20.53	20.61	1
		1	24	20.31	20.52	20.60	1
		12	0	19.39	19.60	19.68	2
		12	6	19.30	19.51	19.59	2
		12	13	19.33	19.54	19.62	2
		25	0	19.40	19.61	19.69	2
BW	Modulation	RB Size	RB Offset	Low CH 20000	Mid CH 20175	High CH 20350	MPR
				Frequency 1715 MHz	Frequency 1732.5 MHz	Frequency 1750 MHz	
10 MHz	QPSK	1	0	21.52	21.73	21.81	0
		1	24	21.41	21.62	21.70	0
		1	49	21.40	21.61	21.69	0
		25	0	20.48	20.69	20.77	1
		25	12	20.39	20.60	20.68	1
		25	25	20.42	20.63	20.71	1
		50	0	20.49	20.70	20.78	1
	16QAM	1	0	20.47	20.68	20.76	1
		1	24	20.36	20.57	20.65	1
		1	49	20.35	20.56	20.64	1
		25	0	19.43	19.64	19.72	2
		25	12	19.34	19.55	19.63	2
		25	25	19.37	19.58	19.66	2
		50	0	19.44	19.65	19.73	2



Test Report No.: RF170906W001-5

LTE Band 4							
BW	Modulation	RB Size	RB Offset	Low CH 20025	Mid CH 20175	High CH 20325	MPR
				Frequency 1717.5 MHz	Frequency 1732.5 MHz	Frequency 1747.5 MHz	
15 MHz	QPSK	1	0	21.58	21.79	21.87	0
		1	37	21.47	21.68	21.76	0
		1	74	21.46	21.67	21.75	0
		36	0	20.54	20.75	20.83	1
		36	19	20.45	20.66	20.74	1
		36	39	20.48	20.69	20.77	1
		75	0	20.55	20.76	20.84	1
	16QAM	1	0	20.53	20.74	20.82	1
		1	37	20.42	20.63	20.71	1
		1	74	20.41	20.62	20.70	1
		36	0	19.49	19.70	19.78	2
		36	19	19.40	19.61	19.69	2
		36	39	19.43	19.64	19.72	2
		75	0	19.50	19.71	19.79	2
BW	Modulation	RB Size	RB Offset	Low CH 20050	Mid CH 20175	High CH 20300	MPR
				Frequency 1720 MHz	Frequency 1732.5 MHz	Frequency 1745 MHz	
20MHz	QPSK	1	0	21.61	21.82	21.90	0
		1	50	21.50	21.71	21.79	0
		1	99	21.49	21.70	21.78	0
		50	0	20.57	20.78	20.86	1
		50	25	20.48	20.69	20.77	1
		50	50	20.51	20.72	20.80	1
		100	0	20.58	20.79	20.87	1
	16QAM	1	0	20.56	20.77	20.85	1
		1	50	20.45	20.66	20.74	1
		1	99	20.44	20.65	20.73	1
		50	0	19.52	19.73	19.81	2
		50	25	19.43	19.64	19.72	2
		50	50	19.46	19.67	19.75	2
		100	0	19.53	19.74	19.82	2



Test Report No.: RF170906W001-5

LTE Band 12							
BW	Modulation	RB Size	RB Offset	Low CH 23017	Mid CH 23095	High CH 23173	MPR
				Frequency 699.7 MHz	Frequency 707.5 MHz	Frequency 715.3 MHz	
1.4 MHz	QPSK	1	0	22.81	22.87	22.82	0
		1	2	22.79	22.81	22.77	0
		1	5	22.69	22.72	22.61	0
		3	0	22.79	22.85	22.80	0
		3	1	22.77	22.79	22.75	0
		3	3	22.67	22.70	22.59	0
	16QAM	6	0	21.78	21.84	21.79	1
		1	0	21.62	21.65	21.61	1
		1	2	21.59	21.62	21.51	1
		1	5	21.54	21.60	21.55	1
		3	0	21.61	21.64	21.60	1
		3	1	21.58	21.61	21.50	1
		3	3	21.53	21.59	21.54	1
		6	0	20.87	20.90	20.86	2
BW	Modulation	RB Size	RB Offset	Low CH 23025	Mid CH 23095	High CH 23165	MPR
				Frequency 700.5 MHz	Frequency 707.5 MHz	Frequency 714.5 MHz	
3 MHz	QPSK	1	0	22.85	22.91	22.86	0
		1	7	22.83	22.85	22.81	0
		1	14	22.73	22.76	22.65	0
		8	0	21.97	22.03	21.98	1
		8	3	21.96	21.99	21.95	1
		8	7	21.95	21.98	21.87	1
		15	0	21.82	21.88	21.83	1
	16QAM	1	0	21.66	21.69	21.65	1
		1	7	21.63	21.66	21.55	1
		1	14	21.58	21.64	21.59	1
		8	0	20.81	20.84	20.80	2
		8	3	20.96	20.99	20.88	2
		8	7	20.95	21.01	20.96	2
		15	0	20.91	20.94	20.90	2



Test Report No.: RF170906W001-5

LTE Band 12							
BW	Modulation	RB Size	RB Offset	Low CH 23035	Mid CH 23095	High CH 23155	MPR
				Frequency 701.5 MHz	Frequency 707.5 MHz	Frequency 713.5 MHz	
5 MHz	QPSK	1	0	22.91	22.97	22.92	0
		1	12	22.89	22.91	22.87	0
		1	24	22.79	22.82	22.71	0
		12	0	22.03	22.09	22.04	1
		12	6	22.02	22.05	22.01	1
		12	13	22.01	22.04	21.93	1
		25	0	21.88	21.94	21.89	1
	16QAM	1	0	21.72	21.75	21.71	1
		1	12	21.69	21.72	21.61	1
		1	24	21.64	21.70	21.65	1
		12	0	20.87	20.90	20.86	2
		12	6	21.02	21.05	20.94	2
		12	13	21.01	21.07	21.02	2
		25	0	20.97	21.00	20.96	2
BW	Modulation	RB Size	RB Offset	Low CH 23060	Mid CH 23095	High CH 23130	MPR
				Frequency 704 MHz	Frequency 707.5 MHz	Frequency 711 MHz	
10 MHz	QPSK	1	0	22.94	23.00	22.95	0
		1	24	22.92	22.94	22.90	0
		1	49	22.82	22.85	22.74	0
		25	0	22.06	22.12	22.07	1
		25	12	22.05	22.08	22.04	1
		25	25	22.04	22.07	21.96	1
		50	0	21.91	21.97	21.92	1
	16QAM	1	0	21.75	21.78	21.74	1
		1	24	21.72	21.75	21.64	1
		1	49	21.67	21.73	21.68	1
		25	0	20.90	20.93	20.89	2
		25	12	21.05	21.08	20.97	2
		25	25	21.04	21.10	21.05	2
		50	0	21.00	21.03	20.99	2



Test Report No.: RF170906W001-5

LTE Band 17							
BW	Modulation	RB Size	RB Offset	Low CH 23755	Mid CH 23790	High CH 23825	MPR
				Frequency 706.5 MHz	Frequency 710 MHz	Frequency 713.5 MHz	
5 MHz	QPSK	1	0	22.42	22.46	22.37	0
		1	12	22.37	22.23	22.21	0
		1	24	22.33	22.14	22.12	0
		12	0	21.37	21.41	21.34	1
		12	6	21.35	21.40	21.32	1
		12	13	21.34	21.30	21.27	1
		25	0	21.30	21.33	21.25	1
	16QAM	1	0	21.23	21.25	21.22	1
		1	12	21.18	21.20	21.17	1
		1	24	20.96	21.18	21.14	1
		12	0	20.22	20.26	20.20	2
		12	6	20.64	20.66	20.60	2
		12	13	20.30	20.34	20.31	2
		25	0	20.33	20.35	20.31	2
BW	Modulation	RB Size	RB Offset	Low CH 23780	Mid CH 23790	High CH 23800	MPR
				Frequency 709 MHz	Frequency 710 MHz	Frequency 711 MHz	
10 MHz	QPSK	1	0	22.46	22.50	22.41	0
		1	24	22.41	22.27	22.25	0
		1	49	22.37	22.18	22.16	0
		25	0	21.41	21.45	21.38	1
		25	12	21.39	21.44	21.36	1
		25	25	21.38	21.34	21.31	1
		50	0	21.34	21.37	21.29	1
	16QAM	1	0	21.27	21.29	21.26	1
		1	24	21.22	21.24	21.21	1
		1	49	21.00	21.22	21.18	1
		25	0	20.26	20.30	20.24	2
		25	12	20.68	20.70	20.64	2
		25	25	20.34	20.38	20.35	2
		50	0	20.37	20.39	20.35	2



Test Report No.: RF170906W001-5

EIRP

LTE BAND 4

CHANNEL BANDWIDTH: 1.4MHz QPSK

Channel	Frequency (MHz)	SPA LVL (dBm)	Correction Factor(dB)	EIRP(dBm)	EIRP(mW)	Polarization (H/V)	LIMIT (W)
19957	1710.7	-17.45	41.29	23.84	242.10	H	1
20175	1732.5	-17.95	41.36	23.41	219.18	H	1
20393	1754.3	-17.43	42.74	25.30	339.16	H	1
19957	1710.7	-23.63	44.25	20.62	115.32	V	1
20175	1732.5	-23.45	44.20	20.75	118.80	V	1
20393	1754.3	-23.49	44.09	20.59	114.66	V	1

CHANNEL BANDWIDTH: 1.4MHz 16QAM

Channel	Frequency (MHz)	SPA LVL (dBm)	Correction Factor(dB)	EIRP(dBm)	EIRP(mW)	Polarization (H/V)	LIMIT (W)
19957	1710.7	-18.32	41.29	22.97	198.15	H	1
20175	1732.5	-18.88	41.36	22.48	176.93	H	1
20393	1754.3	-18.39	42.74	24.34	271.89	H	1
19957	1710.7	-24.50	44.25	19.75	94.38	V	1
20175	1732.5	-24.38	44.20	19.82	95.90	V	1
20393	1754.3	-24.45	44.09	19.63	91.92	V	1

LTE BAND 4

CHANNEL BANDWIDTH: 3MHz QPSK

Channel	Frequency (MHz)	SPA LVL (dBm)	Correction Factor(dB)	EIRP(dBm)	EIRP(mW)	Polarization (H/V)	LIMIT (W)
19965	1711.5	-17.43	41.27	23.83	241.71	H	1
20175	1732.5	-18.01	41.36	23.35	216.17	H	1
20385	1753.5	-17.38	42.76	25.37	344.59	H	1
19965	1711.5	-23.61	44.26	20.66	116.31	V	1
20175	1732.5	-23.51	44.20	20.69	117.17	V	1
20385	1753.5	-23.44	44.23	20.79	119.98	V	1



Test Report No.: RF170906W001-5

CHANNEL BANDWIDTH: 3MHz 16QAM

Channel	Frequency (MHz)	SPA LVL (dBm)	Correction Factor(dB)	EIRP(dBm)	EIRP(mW)	Polarization (H/V)	LIMIT (W)
19965	1711.5	-18.50	41.27	22.76	188.93	H	1
20175	1732.5	-18.90	41.36	22.46	176.12	H	1
20385	1753.5	-18.37	42.76	24.38	274.35	H	1
19965	1711.5	-24.68	44.26	19.59	90.91	V	1
20175	1732.5	-24.40	44.20	19.80	95.46	V	1
20385	1753.5	-24.43	44.23	19.80	95.52	V	1

LTE BAND 4

CHANNEL BANDWIDTH: 5MHz QPSK

Channel	Frequency (MHz)	SPA LVL (dBm)	Correction Factor(dB)	EIRP(dBm)	EIRP(mW)	Polarization (H/V)	LIMIT (W)
19975	1712.5	-17.49	41.39	23.90	245.19	H	1
20175	1732.5	-17.96	41.36	23.40	218.68	H	1
20375	1752.5	-17.33	42.63	25.30	338.45	H	1
19975	1712.5	-23.67	44.17	20.50	112.20	V	1
20175	1732.5	-23.46	44.20	20.74	118.52	V	1
20375	1752.5	-23.39	44.35	20.95	124.57	V	1

CHANNEL BANDWIDTH: 5MHz 16QAM

Channel	Frequency (MHz)	SPA LVL (dBm)	Correction Factor(dB)	EIRP(dBm)	EIRP(mW)	Polarization (H/V)	LIMIT (W)
19975	1712.5	-18.32	41.39	23.07	202.53	H	1
20175	1732.5	-18.98	41.36	22.38	172.90	H	1
20375	1752.5	-18.43	42.63	24.20	262.72	H	1
19975	1712.5	-24.50	44.17	19.67	92.68	V	1
20175	1732.5	-24.48	44.20	19.72	93.71	V	1
20375	1752.5	-24.49	44.35	19.85	96.69	V	1



Test Report No.: RF170906W001-5

LTE BAND 4

CHANNEL BANDWIDTH: 10MHz QPSK

Channel	Frequency (MHz)	SPA LVL (dBm)	Correction Factor(dB)	EIRP(dBm)	EIRP(mW)	Polarization (H/V)	LIMIT (W)
20000	1715.0	-17.30	41.49	24.18	261.94	H	1
20175	1732.5	-17.90	41.36	23.46	221.72	H	1
20350	1750.0	-17.20	42.28	25.08	322.03	H	1
20000	1715.0	-23.48	44.06	20.59	114.47	V	1
20175	1732.5	-23.40	44.20	20.80	120.17	V	1
20350	1750.0	-23.26	44.43	21.17	130.89	V	1

CHANNEL BANDWIDTH: 10MHz 16QAM

Channel	Frequency (MHz)	SPA LVL (dBm)	Correction Factor(dB)	EIRP(dBm)	EIRP(mW)	Polarization (H/V)	LIMIT (W)
20000	1715.0	-18.45	41.49	23.03	201.00	H	1
20175	1732.5	-19.00	41.36	22.36	172.11	H	1
20350	1750.0	-18.36	42.28	23.92	246.55	H	1
20000	1715.0	-24.63	44.06	19.44	87.84	V	1
20175	1732.5	-24.50	44.20	19.70	93.28	V	1
20350	1750.0	-24.42	44.43	20.01	100.21	V	1

LTE BAND 4

CHANNEL BANDWIDTH: 15MHz QPSK

Channel	Frequency (MHz)	SPA LVL (dBm)	Correction Factor(dB)	EIRP(dBm)	EIRP(mW)	Polarization (H/V)	LIMIT (W)
20025	1717.5	-17.31	41.34	24.02	252.58	H	1
20175	1732.5	-17.97	41.36	23.39	218.17	H	1
20325	1747.5	-17.27	42.09	24.81	302.83	H	1
20025	1717.5	-23.49	44.04	20.56	113.71	V	1
20175	1732.5	-23.47	44.20	20.73	118.25	V	1
20325	1747.5	-23.33	44.22	20.88	122.57	V	1



Test Report No.: RF170906W001-5

CHANNEL BANDWIDTH: 15MHz 16QAM

Channel	Frequency (MHz)	SPA LVL (dBm)	Correction Factor(dB)	EIRP(dBm)	EIRP(mW)	Polarization (H/V)	LIMIT (W)
20025	1717.5	-18.17	41.34	23.16	207.20	H	1
20175	1732.5	-18.84	41.36	22.52	178.57	H	1
20325	1747.5	-18.12	42.09	23.96	249.00	H	1
20025	1717.5	-24.35	44.04	19.70	93.28	V	1
20175	1732.5	-24.34	44.20	19.86	96.78	V	1
20325	1747.5	-24.18	44.22	20.03	100.79	V	1

LTE BAND 4

CHANNEL BANDWIDTH: 20MHz QPSK

Channel	Frequency (MHz)	SPA LVL (dBm)	Correction Factor(dB)	EIRP(dBm)	EIRP(mW)	Polarization (H/V)	LIMIT (W)
20050	1720.0	-17.89	41.28	23.39	218.12	H	1
20175	1732.5	-18.42	41.36	22.94	196.74	H	1
20300	1745.0	-17.85	41.96	24.10	257.22	H	1
20050	1720.0	-24.07	44.14	20.07	101.60	V	1
20175	1732.5	-23.92	44.20	20.27	106.51	V	1
20300	1745.0	-23.91	43.88	19.97	99.33	V	1

CHANNEL BANDWIDTH: 20MHz 16QAM

Channel	Frequency (MHz)	SPA LVL (dBm)	Correction Factor(dB)	EIRP(dBm)	EIRP(mW)	Polarization (H/V)	LIMIT (W)
20050	1720.0	-18.82	41.28	22.46	176.08	H	1
20175	1732.5	-19.49	41.36	21.87	153.78	H	1
20300	1745.0	-18.68	41.96	23.27	212.47	H	1
20050	1720.0	-25.00	44.14	19.14	82.02	V	1
20175	1732.5	-24.99	44.20	19.20	83.25	V	1
20300	1745.0	-24.74	43.88	19.14	82.05	V	1

REMARKS: 1. EIRP Output Power (dBm) = SPA LVL (dBm) + Correction Factor (dB).
 2. Correction factor (dB) = Free Space Loss + Antenna Factor + Cable Loss



Test Report No.: RF170906W001-5

LTE BAND 12

CHANNEL BANDWIDTH: 1.4MHz QPSK

Channel	Frequency (MHz)	SPA LVL (dBm)	Correction Factor(dB)	ERP(dBm)	ERP(mW)	Polarization (H/V)	LIMIT (W)
23017	699.7	-3.57	32.77	27.05	507.46	H	3
23095	707.5	-3.31	33.23	27.77	598.14	H	3
23173	715.3	-1.78	33.14	29.21	833.87	H	3
23017	699.7	-12.99	32.42	17.28	53.46	V	3
23095	707.5	-12.91	32.60	17.54	56.79	V	3
23173	715.3	-12.50	32.19	17.54	56.69	V	3

CHANNEL BANDWIDTH: 1.4MHz 16QAM

Channel	Frequency (MHz)	SPA LVL (dBm)	Correction Factor(dB)	ERP(dBm)	ERP(mW)	Polarization (H/V)	LIMIT (W)
23017	699.7	-4.40	32.77	26.22	419.18	H	3
23095	707.5	-4.33	33.23	26.75	472.93	H	3
23173	715.3	-2.88	33.14	28.11	647.29	H	3
23017	699.7	-13.82	32.42	16.45	44.16	V	3
23095	707.5	-13.93	32.60	16.52	44.91	V	3
23173	715.3	-13.60	32.19	16.44	44.00	V	3

LTE BAND 12

CHANNEL BANDWIDTH: 3MHz QPSK

Channel	Frequency (MHz)	SPA LVL (dBm)	Correction Factor(dB)	ERP(dBm)	ERP(mW)	Polarization (H/V)	LIMIT (W)
23025	700.5	-3.38	32.63	27.11	513.45	H	3
23095	707.5	-3.25	33.23	27.83	606.46	H	3
23165	714.5	-1.65	33.21	29.41	872.57	H	3
23025	700.5	-12.80	32.33	17.38	54.71	V	3
23095	707.5	-12.85	32.60	17.60	57.58	V	3
23165	714.5	-12.37	32.30	17.78	59.98	V	3



Test Report No.: RF170906W001-5

CHANNEL BANDWIDTH: 3MHz 16QAM

Channel	Frequency (MHz)	SPA LVL (dBm)	Correction Factor(dB)	ERP(dBm)	ERP(mW)	Polarization (H/V)	LIMIT (W)
23025	700.5	-4.53	32.63	25.96	394.00	H	3
23095	707.5	-4.35	33.23	26.73	470.76	H	3
23165	714.5	-2.81	33.21	28.25	668.04	H	3
23025	700.5	-13.95	32.33	16.23	41.99	V	3
23095	707.5	-13.95	32.60	16.50	44.70	V	3
23165	714.5	-13.53	32.30	16.62	45.92	V	3

LTE BAND 12

CHANNEL BANDWIDTH: 5MHz QPSK

Channel	Frequency (MHz)	SPA LVL (dBm)	Correction Factor(dB)	ERP(dBm)	ERP(mW)	Polarization (H/V)	LIMIT (W)
23035	701.5	-3.39	32.53	26.99	499.92	H	3
23095	707.5	-3.32	33.23	27.76	596.49	H	3
23155	713.5	-1.72	33.29	29.42	874.98	H	3
23035	701.5	-12.81	32.25	17.30	53.68	V	3
23095	707.5	-12.92	32.60	17.53	56.66	V	3
23155	713.5	-12.44	32.39	17.80	60.19	V	3

CHANNEL BANDWIDTH: 5MHz 16QAM

Channel	Frequency (MHz)	SPA LVL (dBm)	Correction Factor(dB)	ERP(dBm)	ERP(mW)	Polarization (H/V)	LIMIT (W)
23035	701.5	-4.25	32.53	26.13	410.11	H	3
23095	707.5	-4.19	33.23	26.89	488.20	H	3
23155	713.5	-2.57	33.29	28.57	719.45	H	3
23035	701.5	-13.67	32.25	16.44	44.04	V	3
23095	707.5	-13.79	32.60	16.66	46.38	V	3
23155	713.5	-13.29	32.39	16.95	49.49	V	3



Test Report No.: RF170906W001-5

LTE BAND 12

CHANNEL BANDWIDTH: 10MHz QPSK

Channel	Frequency (MHz)	SPA LVL (dBm)	Correction Factor(dB)	ERP(dBm)	ERP(mW)	Polarization (H/V)	LIMIT (W)
23060	704.0	-3.97	32.68	26.57	453.63	H	3
23095	707.5	-3.77	33.23	27.31	538.02	H	3
23130	711.0	-2.30	33.39	28.94	783.43	H	3
23060	704.0	-13.39	32.37	16.83	48.22	V	3
23095	707.5	-13.37	32.60	17.08	51.09	V	3
23130	711.0	-13.02	32.56	17.38	54.75	V	3

CHANNEL BANDWIDTH: 10MHz 16QAM

Channel	Frequency (MHz)	SPA LVL (dBm)	Correction Factor(dB)	ERP(dBm)	ERP(mW)	Polarization (H/V)	LIMIT (W)
23060	704.0	-4.90	32.68	25.64	366.18	H	3
23095	707.5	-4.84	33.23	26.24	420.53	H	3
23130	711.0	-3.13	33.39	28.11	647.14	H	3
23060	704.0	-14.32	32.37	15.90	38.92	V	3
23095	707.5	-14.44	32.60	16.01	39.93	V	3
23130	711.0	-13.85	32.56	16.55	45.23	V	3

REMARKS: 1. ERP Output Power (dBm) = SPA LVL (dBm) + Correction Factor (dB) -2.15(dB).
 2. Correction factor (dB) = Free Space Loss + Antenna Factor + Cable Loss

LTE BAND 17

CHANNEL BANDWIDTH: 5MHz QPSK

Channel	Frequency (MHz)	SPA LVL (dBm)	Correction Factor(dB)	ERP(dBm)	ERP(mW)	Polarization (H/V)	LIMIT (W)
23755	706.5	-2.04	32.64	28.45	699.04	H	3
23790	710.0	-2.48	32.92	28.29	674.84	H	3
23825	713.5	-1.82	32.83	28.85	768.07	H	3
23755	706.5	-12.85	32.14	17.14	51.77	V	3
23790	710.0	-12.70	32.18	17.33	54.05	V	3
23825	713.5	-12.32	31.95	17.48	55.98	V	3



Test Report No.: RF170906W001-5

CHANNEL BANDWIDTH: 5MHz 16QAM

Channel	Frequency (MHz)	SPA LVL (dBm)	Correction Factor(dB)	ERP(dBm)	ERP(mW)	Polarization (H/V)	LIMIT (W)
23755	706.5	-2.90	32.64	27.59	573.46	H	3
23790	710.0	-3.35	32.92	27.42	552.33	H	3
23825	713.5	-2.67	32.83	28.00	631.54	H	3
23755	706.5	-13.71	32.14	16.28	42.47	V	3
23790	710.0	-13.57	32.18	16.46	44.24	V	3
23825	713.5	-13.17	31.95	16.63	46.03	V	3

LTE BAND 17

CHANNEL BANDWIDTH: 10MHz QPSK

Channel	Frequency (MHz)	SPA LVL (dBm)	Correction Factor(dB)	ERP(dBm)	ERP(mW)	Polarization (H/V)	LIMIT (W)
23780	709.0	-2.62	32.90	28.13	649.38	H	3
23790	710.0	-2.93	32.92	27.84	608.14	H	3
23800	711.0	-2.40	32.92	28.37	686.91	H	3
23780	709.0	-13.43	32.20	16.62	45.92	V	3
23790	710.0	-13.15	32.18	16.88	48.75	V	3
23800	711.0	-12.90	32.13	17.08	51.02	V	3

CHANNEL BANDWIDTH: 10MHz 16QAM

Channel	Frequency (MHz)	SPA LVL (dBm)	Correction Factor(dB)	ERP(dBm)	ERP(mW)	Polarization (H/V)	LIMIT (W)
23780	709.0	-3.55	32.90	27.20	524.20	H	3
23790	710.0	-4.00	32.92	26.77	475.34	H	3
23800	711.0	-3.23	32.92	27.54	567.41	H	3
23780	709.0	-14.36	32.20	15.69	37.07	V	3
23790	710.0	-14.22	32.18	15.81	38.11	V	3
23800	711.0	-13.73	32.13	16.25	42.14	V	3

REMARKS: 1. ERP Output Power (dBm) = SPA LVL (dBm) + Correction Factor (dB) -2.15(dB).

2. Correction factor (dB) = Free Space Loss + Antenna Factor + Cable Loss

4.2 FREQUENCY STABILITY MEASUREMENT

4.2.1 LIMITS OF FREQUENCY STABILITY MEASUREMENT

The frequency stability shall be sufficient to ensure that the fundamental emissions stay within the authorized bands of operation.

4.2.2 TEST PROCEDURE

- a. Device is placed at the oven room. The oven room could control the temperatures and humidity. Power warm up is at least 15 min and power applied should perform before recording frequency error.
- b. EUT is connected the external power supply to control the DC input power. The test voltage range is from minimum to maximum working voltage. Each step shall be record the frequency error rate.
- c. The temperature range step is 10 degrees in this test items. All temperature levels shall be hold the $\pm 0.5^{\circ}\text{C}$ during the measurement testing. The each temperature step shall be at least 0.5 hours, consider the EUT could be test under the stability condition.

NOTE: The frequency error was recorded frequency error from the communication simulator.

4.2.3 TEST SETUP

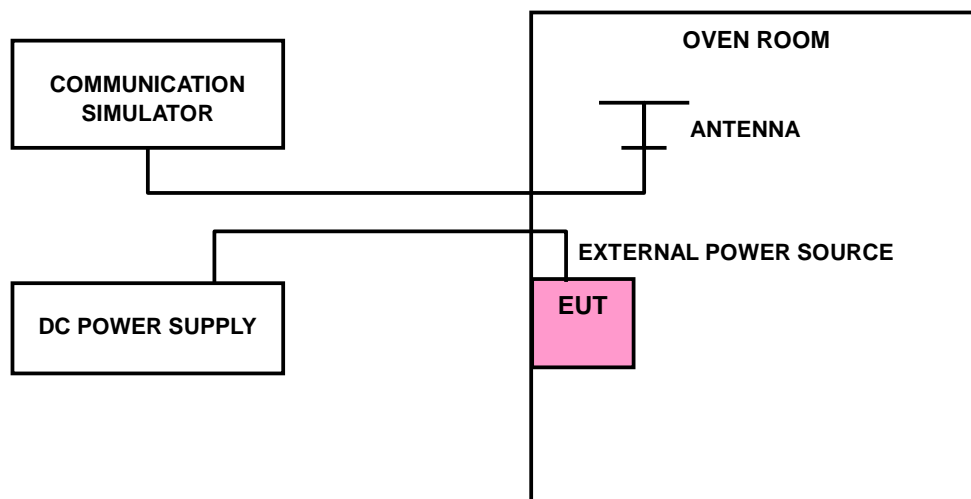



4.2.4 TEST RESULTS

LTE BAND 4

FREQUENCY ERROR VS. VOLTAGE

VOLTAGE (Volts)	1.4MHz		LIMIT (ppm)
	FREQUENCY ERROR (ppm)		
	Low Channel	High Channel	
24	0.0012	0.0015	2.5
22	-0.0017	-0.0020	2.5
26	-0.0016	-0.0018	2.5

NOTE: The applicant defined the normal working voltage of the DC source is from 22Vdc to 26Vdc.

FREQUENCY ERROR vs. TEMPERATURE.

TEMP. (°C)	1.4MHz		LIMIT (ppm)
	FREQUENCY ERROR (ppm)		
	Low Channel	High Channel	
-30	-0.0057	-0.0057	2.5
-20	-0.0050	-0.0050	2.5
-10	-0.0042	-0.0042	2.5
0	-0.0034	-0.0034	2.5
10	-0.0027	-0.0026	2.5
20	-0.0021	-0.0019	2.5
30	-0.0014	-0.0012	2.5
40	-0.0005	-0.0003	2.5
50	0.0002	0.0004	2.5



FREQUENCY ERROR VS. VOLTAGE

VOLTAGE (Volts)	3MHz		LIMIT (ppm)
	FREQUENCY ERROR (ppm)		
	Low Channel	High Channel	
24	0.0014	0.0017	2.5
22	-0.0016	-0.0022	2.5
26	-0.0014	-0.0018	2.5

NOTE: The applicant defined the normal working voltage of the DC source is from 22Vdc to 26Vdc.

FREQUENCY ERROR vs. TEMPERATURE.

TEMP. (°C)	3MHz		LIMIT (ppm)
	FREQUENCY ERROR (ppm)		
	Low Channel	High Channel	
-30	-0.0053	-0.0053	2.5
-20	-0.0045	-0.0044	2.5
-10	-0.0038	-0.0038	2.5
0	-0.0029	-0.0028	2.5
10	-0.0022	-0.0021	2.5
20	-0.0015	-0.0013	2.5
30	-0.0008	-0.0006	2.5
40	-0.0001	0.0002	2.5
50	0.0005	0.0008	2.5



FREQUENCY ERROR VS. VOLTAGE

VOLTAGE (Volts)	5MHz		LIMIT (ppm)
	FREQUENCY ERROR (ppm)		
	Low Channel	High Channel	
24	0.0013	0.0016	2.5
22	-0.0021	-0.0023	2.5
26	-0.0018	-0.0022	2.5

NOTE: The applicant defined the normal working voltage of the DC source is from 22Vdc to 26Vdc.

FREQUENCY ERROR vs. TEMPERATURE.

TEMP. (°C)	5MHz		LIMIT (ppm)
	FREQUENCY ERROR (ppm)		
	Low Channel	High Channel	
-30	-0.0053	-0.0053	2.5
-20	-0.0046	-0.0045	2.5
-10	-0.0038	-0.0038	2.5
0	-0.0031	-0.0030	2.5
10	-0.0024	-0.0022	2.5
20	-0.0017	-0.0016	2.5
30	-0.0010	-0.0008	2.5
40	-0.0003	0.0000	2.5
50	0.0005	0.0008	2.5



Test Report No.: RF170906W001-5

FREQUENCY ERROR VS. VOLTAGE

VOLTAGE (Volts)	10MHz		LIMIT (ppm)
	FREQUENCY ERROR (ppm)		
	Low Channel	High Channel	
24	0.0013	0.0017	2.5
22	-0.0018	-0.0022	2.5
26	-0.0014	-0.0017	2.5

NOTE: The applicant defined the normal working voltage of the DC source is from 22Vdc to 26Vdc.

FREQUENCY ERROR vs. TEMPERATURE.

TEMP. (°C)	10MHz		LIMIT (ppm)
	FREQUENCY ERROR (ppm)		
	Low Channel	High Channel	
-30	-0.0054	-0.0054	2.5
-20	-0.0046	-0.0046	2.5
-10	-0.0039	-0.0039	2.5
0	-0.0031	-0.0031	2.5
10	-0.0024	-0.0023	2.5
20	-0.0017	-0.0015	2.5
30	-0.0009	-0.0007	2.5
40	-0.0002	0.0000	2.5
50	0.0005	0.0008	2.5



FREQUENCY ERROR VS. VOLTAGE

VOLTAGE (Volts)	15MHz		LIMIT (ppm)
	FREQUENCY ERROR (ppm)		
	Low Channel	High Channel	
24	0.0012	0.0013	2.5
22	-0.0014	-0.0016	2.5
26	-0.0012	-0.0015	2.5

NOTE: The applicant defined the normal working voltage of the DC source is from 22Vdc to 26Vdc.

FREQUENCY ERROR vs. TEMPERATURE.

TEMP. (°C)	15MHz		LIMIT (ppm)
	FREQUENCY ERROR (ppm)		
	Low Channel	High Channel	
-30	-0.0058	-0.0059	2.5
-20	-0.0051	-0.0051	2.5
-10	-0.0044	-0.0044	2.5
0	-0.0036	-0.0035	2.5
10	-0.0029	-0.0028	2.5
20	-0.0022	-0.0021	2.5
30	-0.0015	-0.0013	2.5
40	-0.0007	-0.0005	2.5
50	0.0001	0.0004	2.5



FREQUENCY ERROR VS. VOLTAGE

VOLTAGE (Volts)	20MHz		LIMIT (ppm)
	FREQUENCY ERROR (ppm)		
	Low Channel	High Channel	
24	0.0013	0.0015	2.5
22	-0.0017	-0.0018	2.5
26	-0.0016	-0.0016	2.5

NOTE: The applicant defined the normal working voltage of the DC source is from 22Vdc to 26Vdc.

FREQUENCY ERROR vs. TEMPERATURE.

TEMP. (°C)	20MHz		LIMIT (ppm)
	FREQUENCY ERROR (ppm)		
	Low Channel	High Channel	
-30	-0.0058	-0.0059	2.5
-20	-0.0052	-0.0053	2.5
-10	-0.0044	-0.0044	2.5
0	-0.0035	-0.0035	2.5
10	-0.0028	-0.0027	2.5
20	-0.0021	-0.0019	2.5
30	-0.0014	-0.0012	2.5
40	-0.0007	-0.0004	2.5
50	0.0002	0.0005	2.5



LTE BAND 12

FREQUENCY ERROR VS. VOLTAGE

VOLTAGE (Volts)	1.4MHz		LIMIT (ppm)
	FREQUENCY ERROR (ppm)		
	Low Channel	High Channel	
24	0.0039	0.0042	2.5
22	-0.0055	-0.0058	2.5
26	-0.0046	-0.0051	2.5

NOTE: The applicant defined the normal working voltage of the DC source is from 22Vdc to 26Vdc.

FREQUENCY ERROR vs. TEMPERATURE.

TEMP. (°C)	1.4MHz		LIMIT (ppm)
	FREQUENCY ERROR (ppm)		
	Low Channel	High Channel	
-30	-0.0131	-0.0138	2.5
-20	-0.0114	-0.0120	2.5
-10	-0.0096	-0.0102	2.5
0	-0.0079	-0.0083	2.5
10	-0.0060	-0.0064	2.5
20	-0.0044	-0.0046	2.5
30	-0.0026	-0.0028	2.5
40	-0.0009	-0.0010	2.5
50	0.0008	0.0008	2.5



FREQUENCY ERROR VS. VOLTAGE

VOLTAGE (Volts)	3MHz		LIMIT (ppm)
	FREQUENCY ERROR (ppm)		
	Low Channel	High Channel	
24	0.0030	0.0030	2.5
22	-0.0035	-0.0039	2.5
26	-0.0033	-0.0035	2.5

NOTE: The applicant defined the normal working voltage of the DC source is from 22Vdc to 26Vdc.

FREQUENCY ERROR vs. TEMPERATURE.

TEMP. (°C)	3MHz		LIMIT (ppm)
	FREQUENCY ERROR (ppm)		
	Low Channel	High Channel	
-30	-0.0131	-0.0138	2.5
-20	-0.0113	-0.0120	2.5
-10	-0.0099	-0.0104	2.5
0	-0.0082	-0.0087	2.5
10	-0.0065	-0.0069	2.5
20	-0.0047	-0.0049	2.5
30	-0.0031	-0.0033	2.5
40	-0.0016	-0.0017	2.5
50	-0.0004	-0.0004	2.5



Test Report No.: RF170906W001-5

FREQUENCY ERROR VS. VOLTAGE

VOLTAGE (Volts)	5MHz		LIMIT (ppm)
	FREQUENCY ERROR (ppm)		
	Low Channel	High Channel	
24	0.0036	0.0035	2.5
22	-0.0045	-0.0043	2.5
26	-0.0043	-0.0040	2.5

NOTE: The applicant defined the normal working voltage of the DC source is from 22Vdc to 26Vdc.

FREQUENCY ERROR vs. TEMPERATURE.

TEMP. (°C)	5MHz		LIMIT (ppm)
	FREQUENCY ERROR (ppm)		
	Low Channel	High Channel	
-30	-0.0127	-0.0134	2.5
-20	-0.0121	-0.0128	2.5
-10	-0.0105	-0.0111	2.5
0	-0.0088	-0.0093	2.5
10	-0.0071	-0.0075	2.5
20	-0.0051	-0.0054	2.5
30	-0.0034	-0.0036	2.5
40	-0.0018	-0.0019	2.5
50	-0.0003	-0.0003	2.5



FREQUENCY ERROR VS. VOLTAGE

VOLTAGE (Volts)	10MHz		LIMIT (ppm)
	FREQUENCY ERROR (ppm)		
	Low Channel	High Channel	
24	0.0037	0.0037	2.5
22	-0.0046	-0.0046	2.5
26	-0.0040	-0.0040	2.5

NOTE: The applicant defined the normal working voltage of the DC source is from 22Vdc to 26Vdc.

FREQUENCY ERROR vs. TEMPERATURE.

TEMP. (°C)	10MHz		LIMIT (ppm)
	FREQUENCY ERROR (ppm)		
	Low Channel	High Channel	
-30	-0.0134	-0.0143	2.5
-20	-0.0117	-0.0125	2.5
-10	-0.0101	-0.0107	2.5
0	-0.0085	-0.0090	2.5
10	-0.0068	-0.0072	2.5
20	-0.0050	-0.0054	2.5
30	-0.0034	-0.0036	2.5
40	-0.0018	-0.0020	2.5
50	0.0000	0.0000	2.5



LTE BAND 17

FREQUENCY ERROR VS. VOLTAGE

VOLTAGE (Volts)	5MHz		LIMIT (ppm)
	FREQUENCY ERROR (ppm)		
	Low Channel	High Channel	
24	0.0037	0.0035	2.5
22	-0.0045	-0.0044	2.5
26	-0.0039	-0.0038	2.5

NOTE: The applicant defined the normal working voltage of the DC source is from 22Vdc to 26Vdc.

FREQUENCY ERROR vs. TEMPERATURE.

TEMP. (°C)	5MHz		LIMIT (ppm)
	FREQUENCY ERROR (ppm)		
	Low Channel	High Channel	
-30	-0.0142	-0.0146	2.5
-20	-0.0125	-0.0128	2.5
-10	-0.0106	-0.0109	2.5
0	-0.0088	-0.0090	2.5
10	-0.0069	-0.0071	2.5
20	-0.0050	-0.0051	2.5
30	-0.0030	-0.0032	2.5
40	-0.0014	-0.0015	2.5
50	0.0004	0.0004	2.5



FREQUENCY ERROR VS. VOLTAGE

VOLTAGE (Volts)	10MHz		LIMIT (ppm)
	FREQUENCY ERROR (ppm)		
	Low Channel	High Channel	
24	0.0044	0.0043	2.5
22	-0.0052	-0.0051	2.5
26	-0.0047	-0.0047	2.5

NOTE: The applicant defined the normal working voltage of the DC source is from 22Vdc to 26Vdc.

FREQUENCY ERROR vs. TEMPERATURE.

TEMP. (°C)	10MHz		LIMIT (ppm)
	FREQUENCY ERROR (ppm)		
	Low Channel	High Channel	
-30	-0.0144	-0.0149	2.5
-20	-0.0124	-0.0128	2.5
-10	-0.0102	-0.0105	2.5
0	-0.0081	-0.0084	2.5
10	-0.0062	-0.0064	2.5
20	-0.0044	-0.0046	2.5
30	-0.0028	-0.0030	2.5
40	-0.0011	-0.0011	2.5
50	0.0007	0.0007	2.5

4.3 OCCUPIED BANDWIDTH MEASUREMENT

4.3.1 LIMITS OF OCCUPIED BANDWIDTH MEASUREMENT

The width of a frequency band such that, below the lower and above the upper frequency limits, the mean powers emitted are each equal to a specified percentage 0.5 %of the total mean power of a given emission.

4.3.2 TEST SETUP

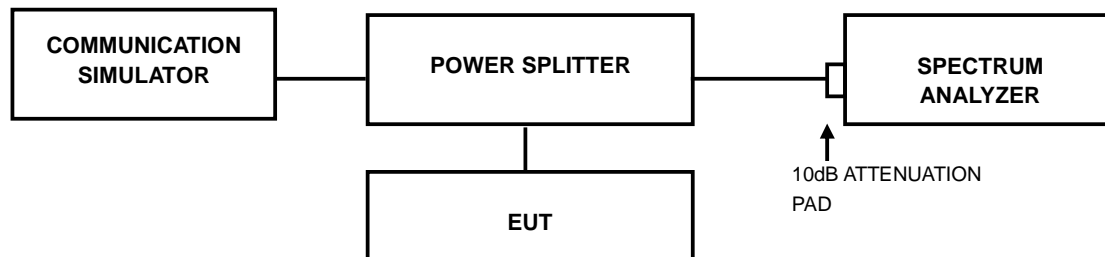

4.3.3 TEST PROCEDURES

- a. The conducted occupied bandwidth used the power splitter via EUT RF power connector between simulation base station and spectrum analyzer.
- b. Use OBW measurement function of Spectrum analyzer to measure 99 % occupied bandwidth.



4.3.4 TEST RESULTS

LTE BAND 4

CHANNEL BANDWIDTH: 1.4MHz				CHANNEL BANDWIDTH: 3MHz			
CHANNEL	Frequency (MHz)	99% OCCUPIED Bandwidth (MHz)		CHANNEL	Frequency (MHz)	99% OCCUPIED Bandwidth (MHz)	
		QPSK	16QAM			QPSK	16QAM
19957	1710.7	1.09	1.08	19965	1711.5	2.69	2.68
20175	1732.5	1.08	1.08	20175	1732.5	2.68	2.68
20393	1754.3	1.09	1.08	20385	1753.5	2.68	2.68

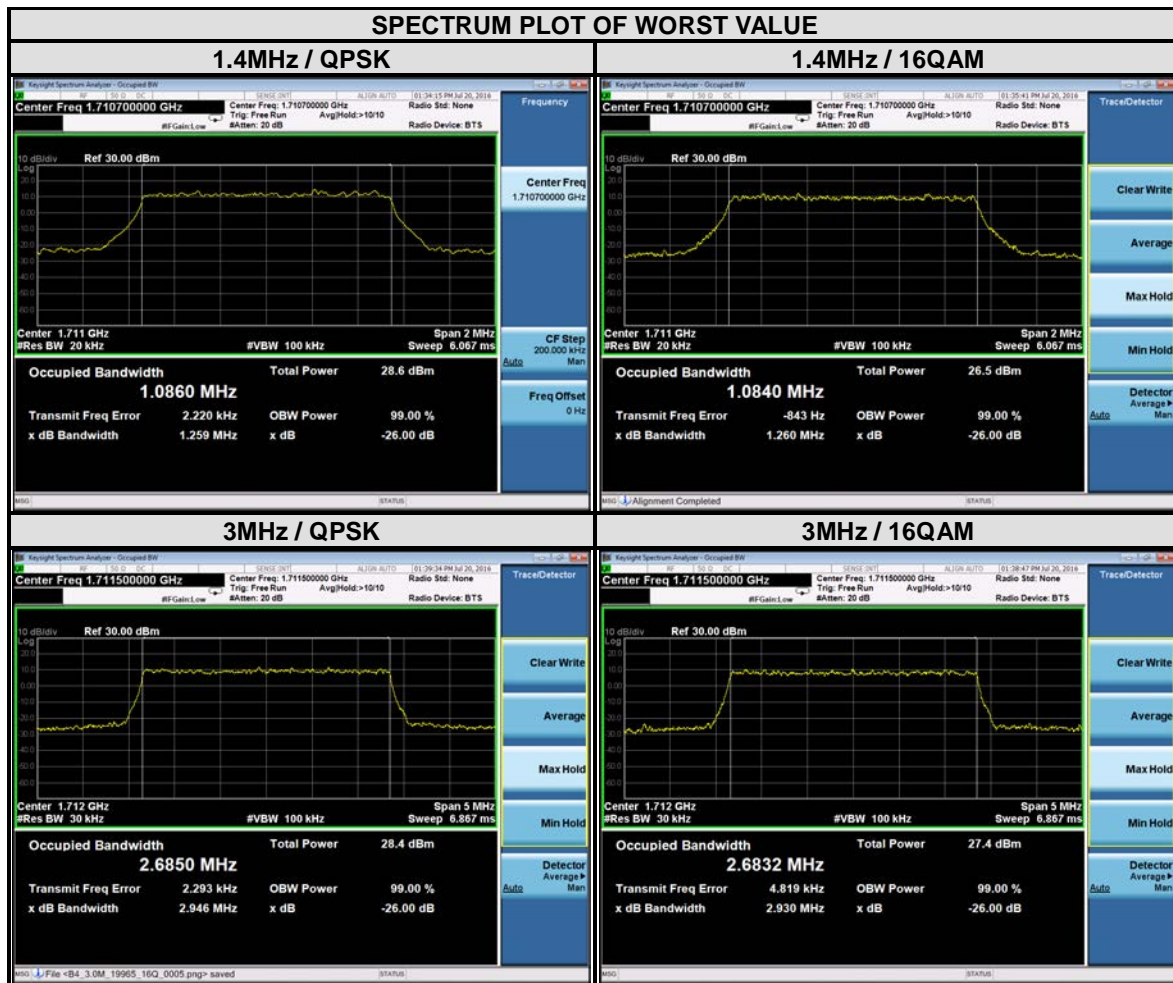



Test Report No.: RF170906W001-5

LTE BAND 4

CHANNEL BANDWIDTH: 5MHz				CHANNEL BANDWIDTH: 10MHz			
CHANNEL	Frequency (MHz)	99% OCCUPIED Bandwidth (MHz)		CHANNEL	Frequency (MHz)	99% OCCUPIED Bandwidth (MHz)	
		QPSK	16QAM			QPSK	16QAM
19975	1712.5	4.49	4.47	20000	1715	8.93	8.91
20175	1732.5	4.48	4.46	20175	1732.5	8.91	8.92
20375	1752.5	4.47	4.46	20350	1750	8.93	8.92

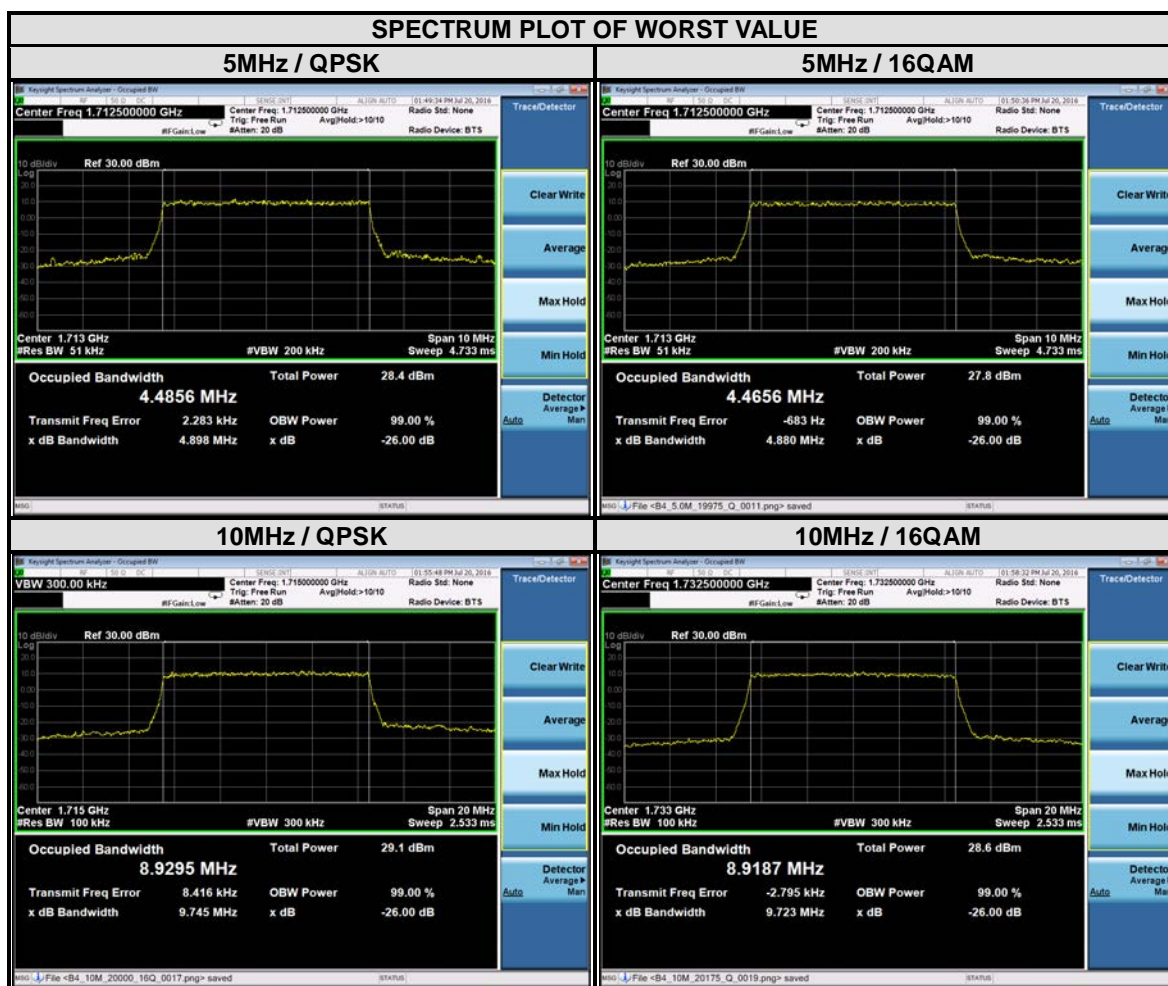



Test Report No.: RF170906W001-5

LTE BAND 4

CHANNEL BANDWIDTH: 15MHz				CHANNEL BANDWIDTH: 20MHz			
CHANNEL	FREQUENCY (MHz)	99% OCCUPIED BANDWIDTH (MHz)		CHANNEL	FREQUENCY (MHz)	99% OCCUPIED BANDWIDTH (MHz)	
		QPSK	16QAM			QPSK	16QAM
20025	1717.5	13.40	13.36	20050	1720	17.86	17.82
20175	1732.5	13.35	13.34	20175	1732.5	17.84	17.77
20325	1747.5	13.38	13.37	20300	1745	17.87	17.82





Test Report No.: RF170906W001-5

LTE BAND 12

CHANNEL BANDWIDTH: 1.4MHz				CHANNEL BANDWIDTH: 3MHz			
CHANNEL	FREQUENCY (MHz)	99% OCCUPIED BANDWIDTH (MHz)		CHANNEL	FREQUENCY (MHz)	99% OCCUPIED BANDWIDTH (MHz)	
		QPSK	16QAM			QPSK	16QAM
23017	699.7	1.08	1.08	23025	700.5	2.68	2.68
23095	707.5	1.09	1.08	23095	707.5	2.68	2.68
23173	715.3	1.08	1.08	23165	714.5	2.68	2.68





Test Report No.: RF170906W001-5

LTE BAND 12

CHANNEL BANDWIDTH: 5MHz				CHANNEL BANDWIDTH: 10MHz			
CHANNEL	Frequency (MHz)	99% OCCUPIED Bandwidth (MHz)		CHANNEL	Frequency (MHz)	99% OCCUPIED Bandwidth (MHz)	
		QPSK	16QAM			QPSK	16QAM
23035	701.5	4.47	4.46	23060	704	8.91	8.91
23095	707.5	4.47	4.46	23095	707.5	8.92	8.92
23155	713.5	4.47	4.46	23130	711	8.89	8.91





Test Report No.: RF170906W001-5

LTE BAND 17

CHANNEL BANDWIDTH: 5MHz				CHANNEL BANDWIDTH: 10MHz			
CHANNEL	Frequency (MHz)	99% OCCUPIED Bandwidth (MHz)		CHANNEL	Frequency (MHz)	99% OCCUPIED Bandwidth (MHz)	
		QPSK	16QAM			QPSK	16QAM
23755	706.5	4.47	4.46	23780	709	8.91	8.91
23790	710	4.47	4.48	23790	710	8.90	8.91
23825	713.5	4.47	4.46	23800	711	8.90	8.91

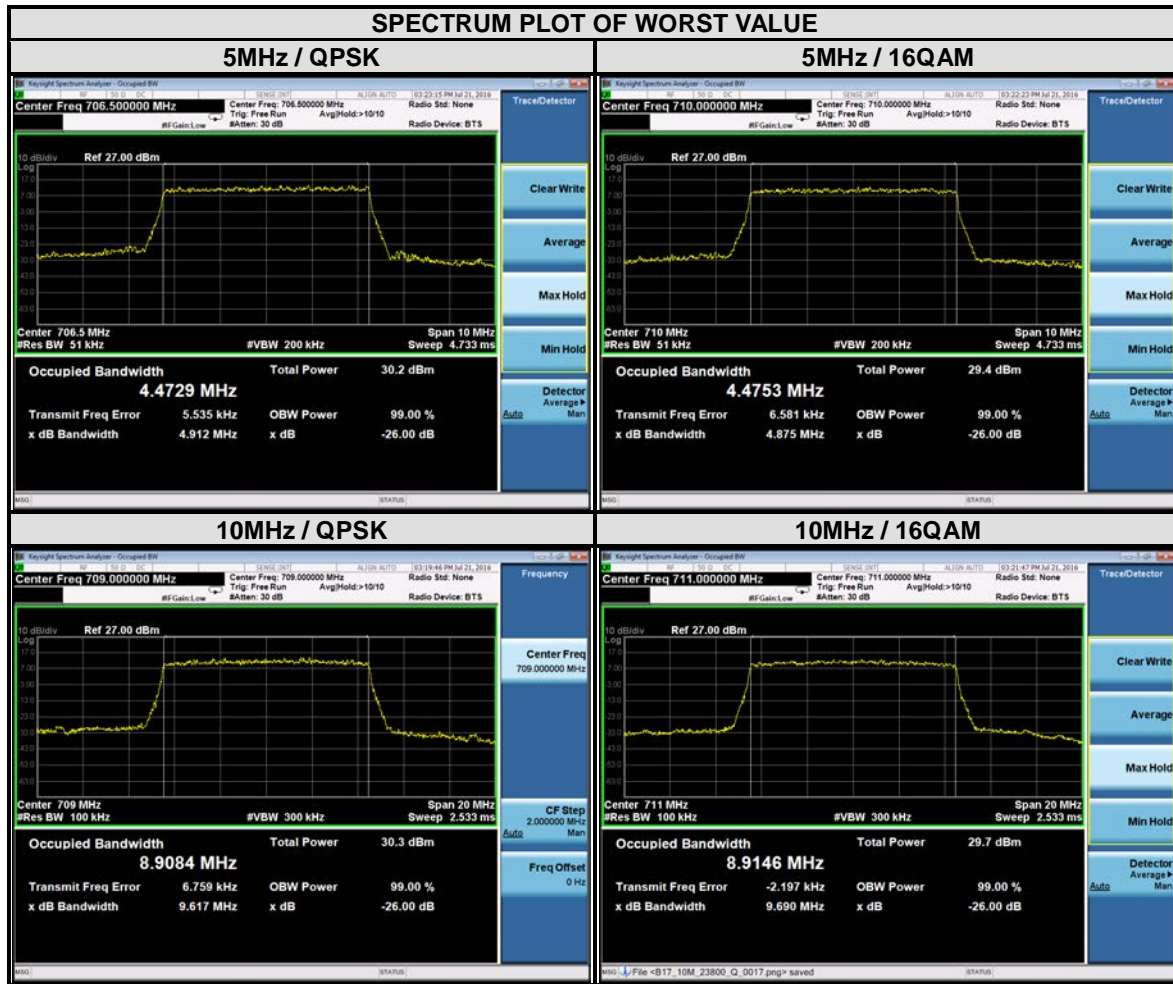

4.4 PEAK TO AVERAGE RATIO

4.4.1 LIMITS OF PEAK TO AVERAGE RATIO MEASUREMENT

In measuring transmissions in this band using an average power technique, the peak to-average ratio (PAR) of the transmission may not exceed 13 dB

4.4.2 TEST SETUP

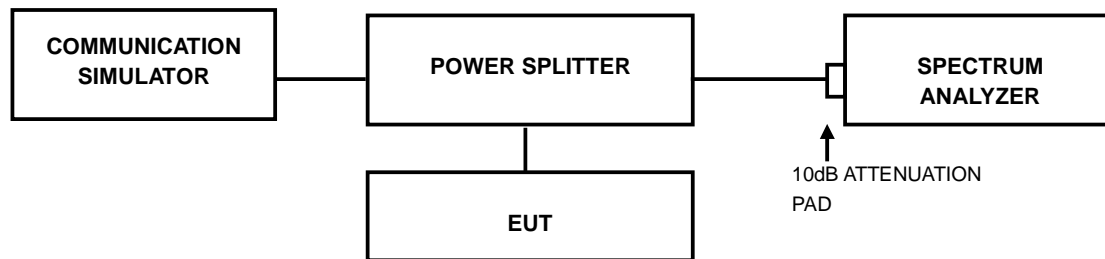

4.4.3 TEST PROCEDURES

1. Set resolution/measurement bandwidth \geq signal's occupied bandwidth;
2. Set the number of counts to a value that stabilizes the measured CCDF curve;
3. Record the maximum PAPR level associated with a probability of 0.1%.



4.4.4 TEST RESULTS

LTE BAND 4

CHANNEL BANDWIDTH: 1.4MHz				CHANNEL BANDWIDTH: 3MHz			
CHANNEL	FREQUENCY (MHz)	PEAK TO AVERAGE RATIO (dB)		CHANNEL	FREQUENCY (MHz)	PEAK TO AVERAGE RATIO (dB)	
		QPSK	16QAM			QPSK	16QAM
19957	1710.7	5.85	6.69	19965	1711.5	5.94	6.73
20175	1732.5	4.91	5.73	20175	1732.5	5.09	5.88
20393	1754.3	4.69	5.67	20385	1753.5	5.06	5.94

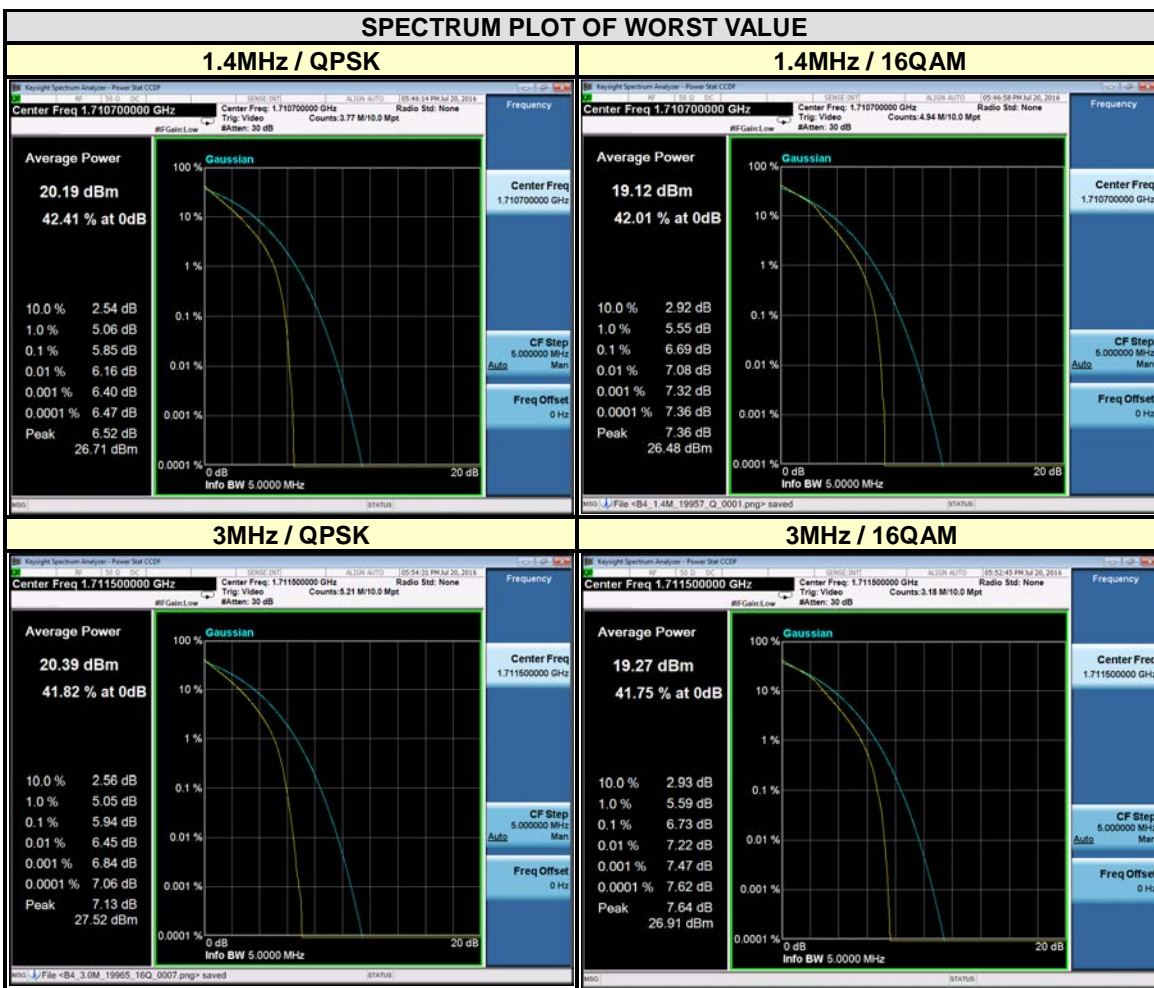



Test Report No.: RF170906W001-5

CHANNEL BANDWIDTH: 5MHz				CHANNEL BANDWIDTH: 10MHz			
CHANNEL	FREQUENCY (MHz)	PEAK TO AVERAGE RATIO (dB)		CHANNEL	FREQUENCY (MHz)	PEAK TO AVERAGE RATIO (dB)	
		QPSK	16QAM			QPSK	16QAM
19975	1712.5	5.76	6.54	20000	1715	5.97	6.72
20175	1732.5	5.12	5.91	20175	1732.5	5.12	5.91
20375	1752.5	5.20	6.04	20350	1750	5.48	6.31

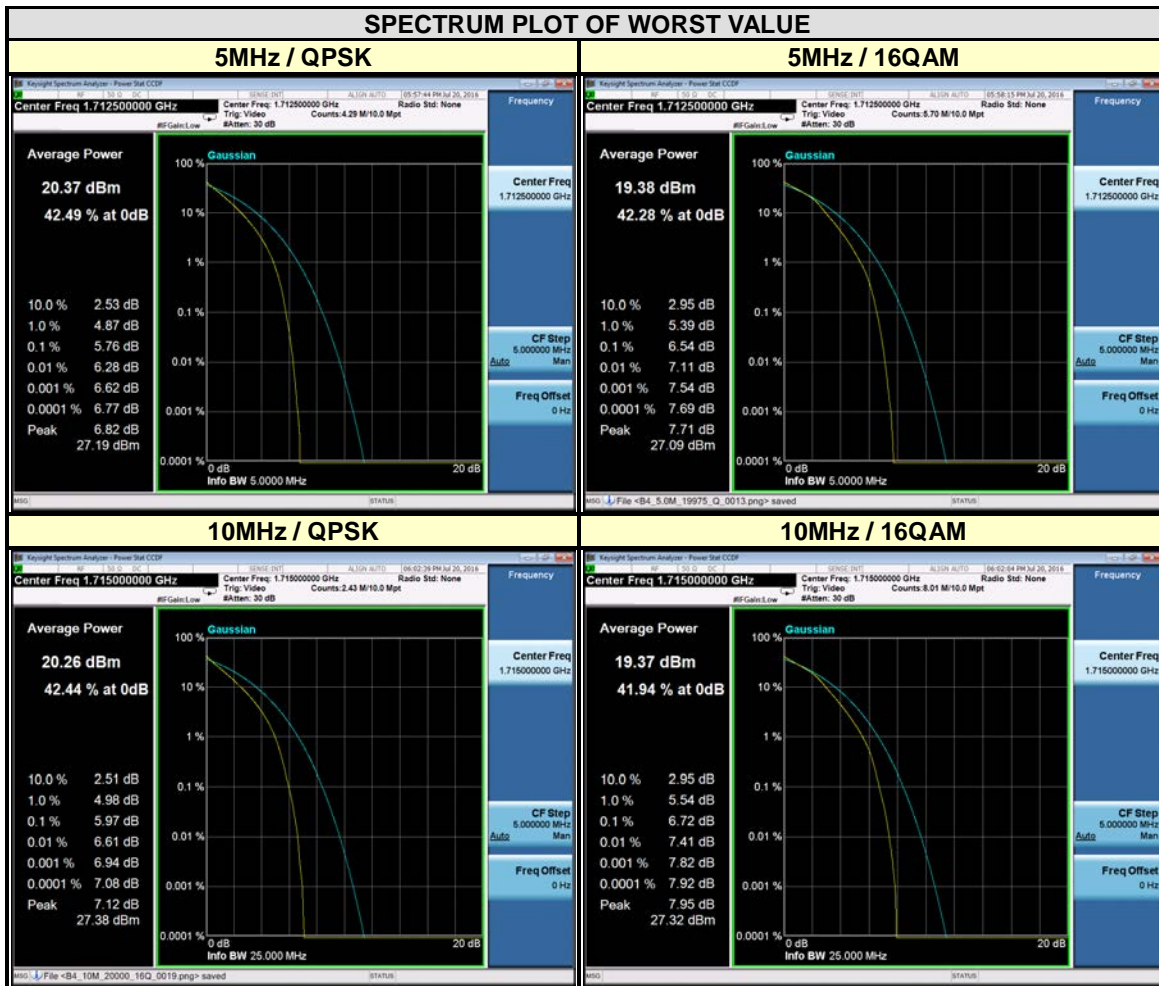



CHANNEL BANDWIDTH: 15MHz				CHANNEL BANDWIDTH: 20MHz			
CHANNEL	FREQUENCY (MHz)	PEAK TO AVERAGE RATIO (dB)		CHANNEL	FREQUENCY (MHz)	PEAK TO AVERAGE RATIO (dB)	
		QPSK	16QAM			QPSK	16QAM
20025	1717.5	5.64	6.48	20050	1720	5.44	6.26
20175	1732.5	5.17	5.99	20175	1732.5	5.20	6.03
20325	1747.5	5.50	6.38	20300	1745	5.49	6.31

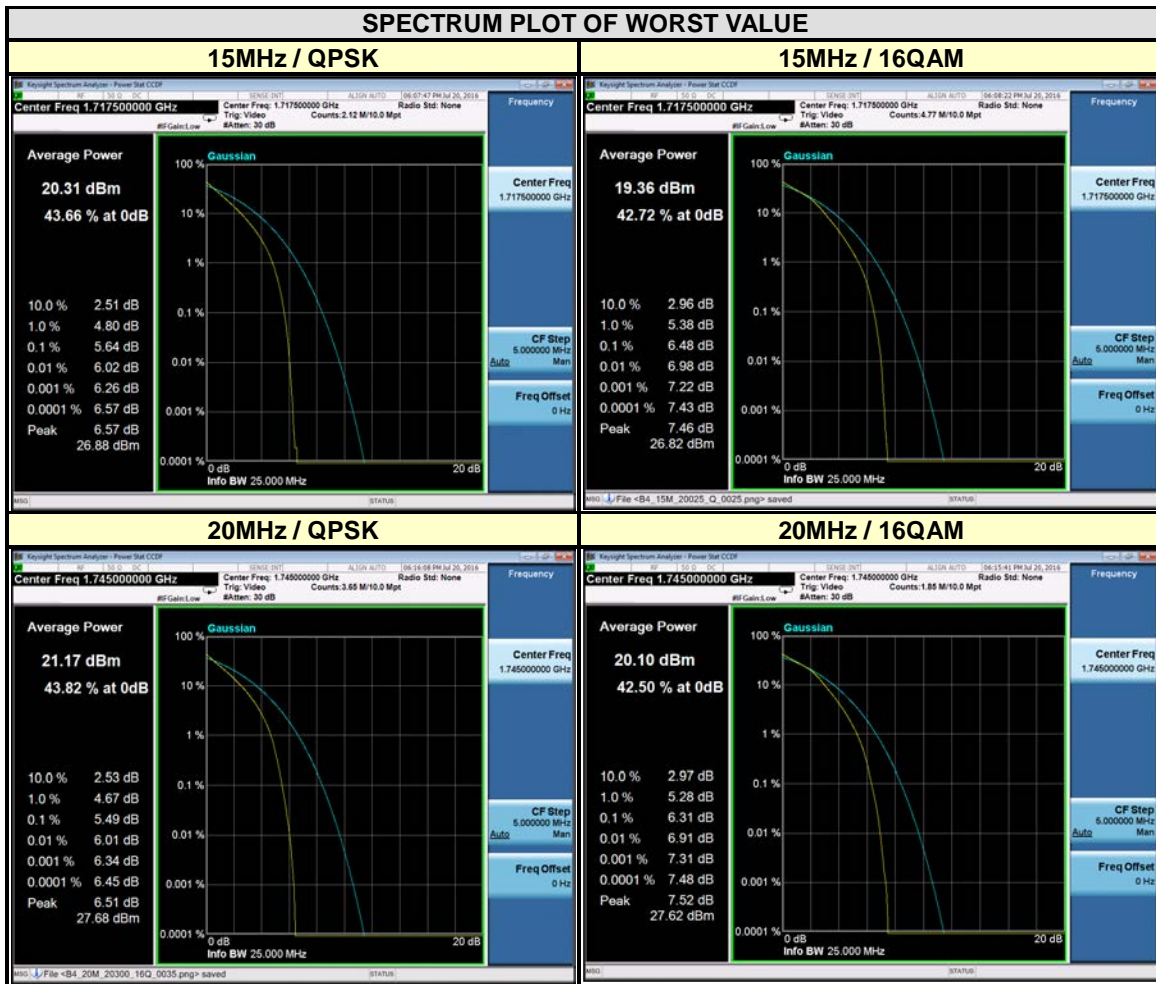



Test Report No.: RF170906W001-5

LTE BAND 12

CHANNEL BANDWIDTH: 1.4MHz				CHANNEL BANDWIDTH: 3MHz			
CHANNEL	FREQUENCY (MHz)	PEAK TO AVERAGE RATIO (dB)		CHANNEL	FREQUENCY (MHz)	PEAK TO AVERAGE RATIO (dB)	
		QPSK	16QAM			QPSK	16QAM
23017	699.7	4.77	5.53	23025	700.5	4.93	5.73
23095	707.5	5.38	6.24	23095	707.5	5.42	6.23
23173	715.3	4.97	5.89	23165	714.5	5.01	5.85

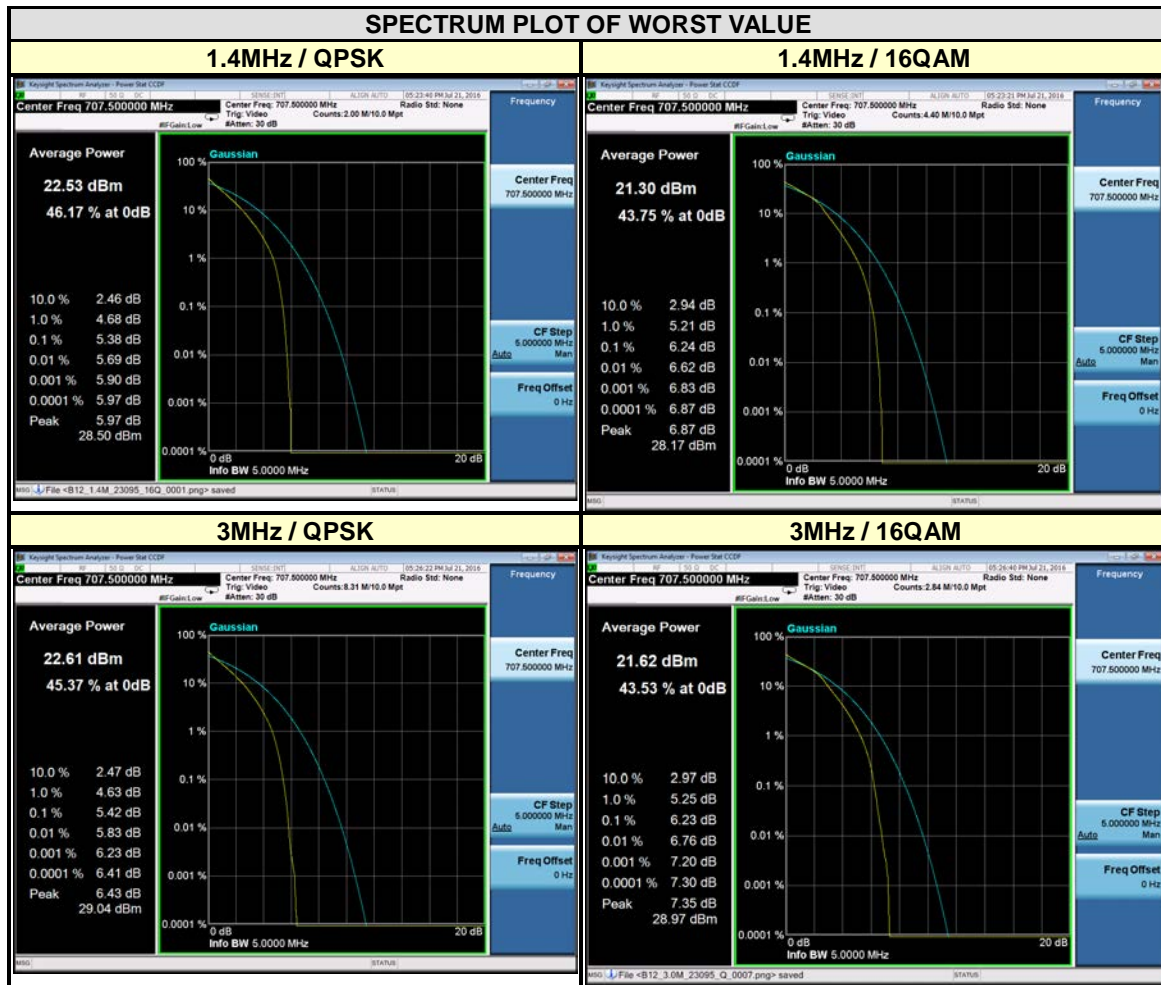



Test Report No.: RF170906W001-5

CHANNEL BANDWIDTH: 5MHz				CHANNEL BANDWIDTH: 10MHz			
CHANNEL	FREQUENCY (MHz)	PEAK TO AVERAGE RATIO (dB)		CHANNEL	FREQUENCY (MHz)	PEAK TO AVERAGE RATIO (dB)	
		QPSK	16QAM			QPSK	16QAM
23035	701.5	5.04	5.86	23060	704	5.30	6.05
23095	707.5	5.27	6.13	23095	707.5	5.17	6.02
23155	713.5	5.05	5.83	23130	711	4.13	5.92

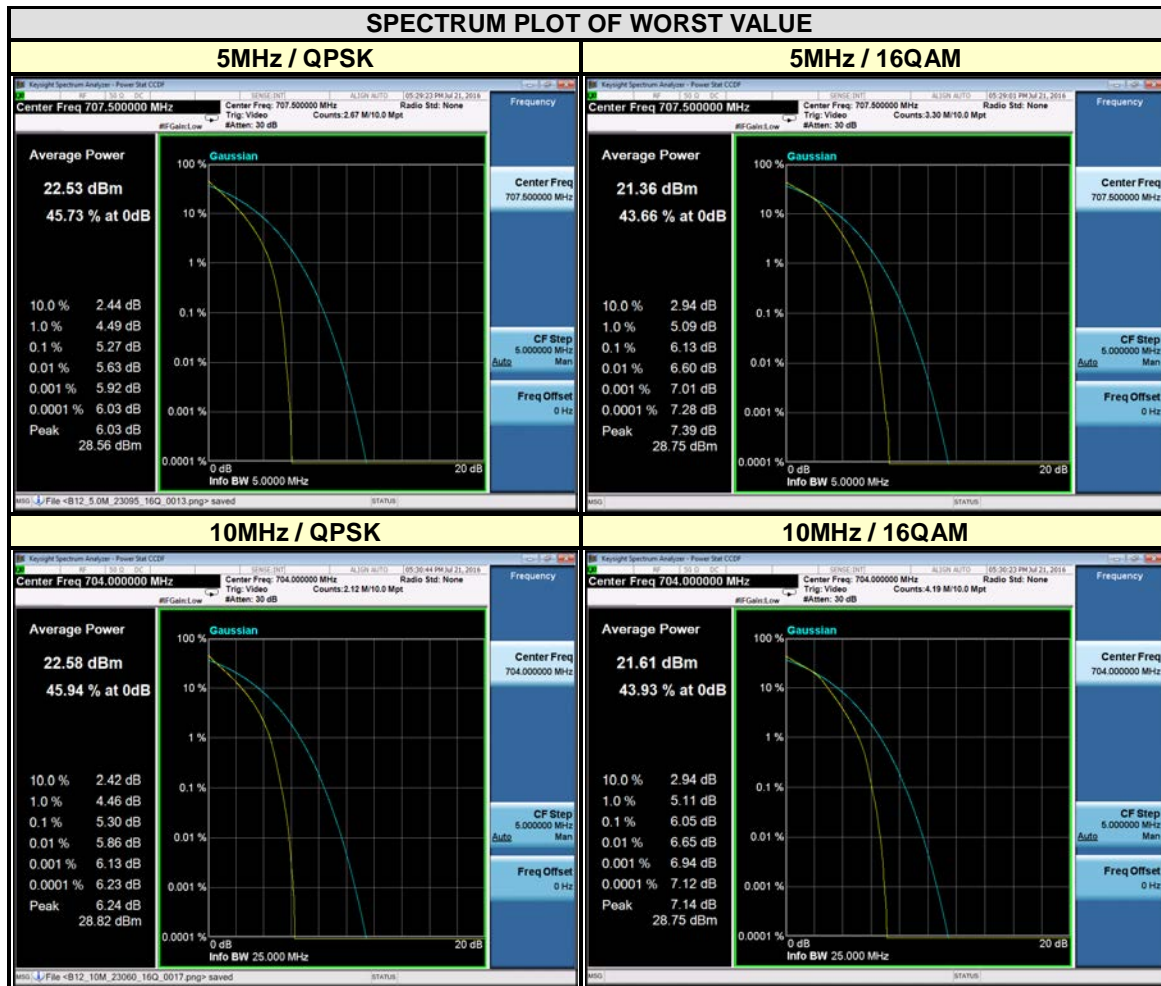



Test Report No.: RF170906W001-5

LTE BAND 17

CHANNEL BANDWIDTH: 5MHz				CHANNEL BANDWIDTH: 10MHz			
CHANNEL	FREQUENCY (MHz)	PEAK TO AVERAGE RATIO (dB)		CHANNEL	FREQUENCY (MHz)	PEAK TO AVERAGE RATIO (dB)	
		QPSK	16QAM			QPSK	16QAM
23755	706.5	5.36	6.16	23780	709	5.17	6.01
23790	710	5.16	6.00	23790	710	5.14	5.99
23825	713.5	5.10	5.88	23800	711	5.17	5.97

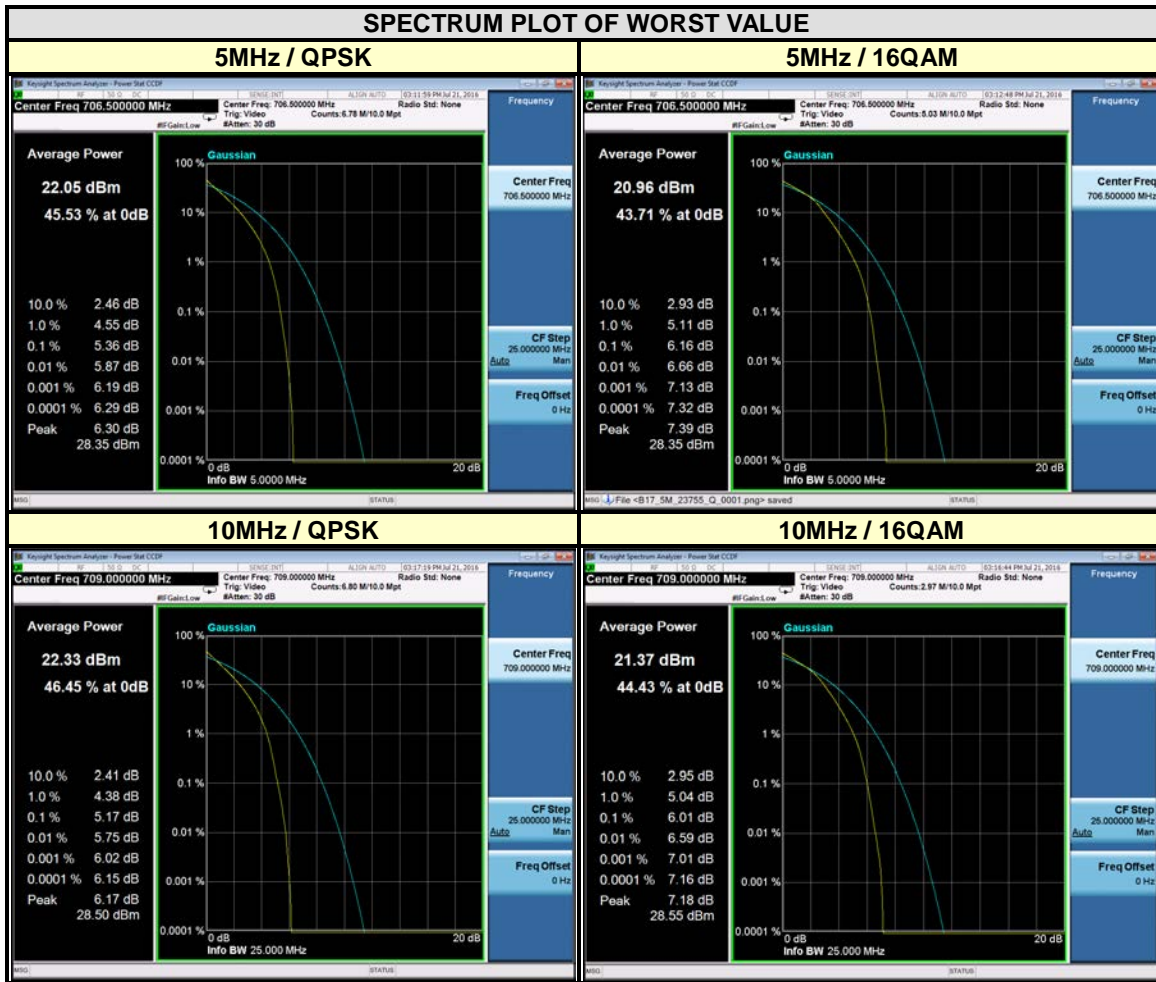

4.5 BAND EDGE MEASUREMENT

4.5.1 LIMITS OF BAND EDGE MEASUREMENT

The power of any emission outside a licensee's frequency band(s) of operation shall be attenuated below the transmitter power (P) within the licensed band(s) of operation, measured in watts, by at least $43 + 10 \log (P)$ dB. Compliance with this provision is based on the use of measurement instrumentation employing a resolution bandwidth of 100 kilohertz or greater.

However, in the 100 kilohertz bands immediately outside and adjacent to a licensee's frequency block, a resolution bandwidth of at least 30 kHz may be employed.

4.5.2 TEST SETUP

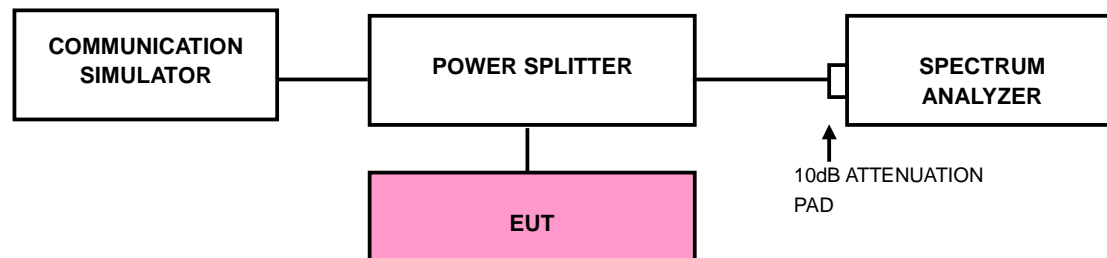



4.5.3 TEST PROCEDURES

- a. The EUT was set up for the maximum peak power with LTE link data modulation. The power was measured with R&S Spectrum Analyzer. All measurements were done at 2 channels (low and high operational frequency range.).
- b. The band edge measurement used the power splitter via EUT RF power connector between simulation base station and spectrum analyzer.
- c. The center frequency of spectrum is the band edge frequency and span is 1~5 MHz. RBW of the spectrum is 20kHz and VBW of the spectrum is 100 kHz. (LTE bandwidth 1.4MHz)
- d. The center frequency of spectrum is the band edge frequency and span is 1~5 MHz. RBW of the spectrum is 30kHz and VBW of the spectrum is 100kHz. (LTE bandwidth 3MHz)
- e. The center frequency of spectrum is the band edge frequency and span is 1~5 MHz. RBW of the spectrum is 50kHz and VBW of the spectrum is 200kHz. (LTE bandwidth 5MHz)
- f. The center frequency of spectrum is the band edge frequency and span is 1~5 MHz. RBW of the spectrum is 100kHz and VBW of the spectrum is 300kHz. (LTE bandwidth 10MHz)
- g. The center frequency of spectrum is the band edge frequency and span is 1~5 MHz. RBW of the spectrum is 200kHz and VBW of the spectrum is 1MHz. (LTE bandwidth 15MHz)
- h. The center frequency of spectrum is the band edge frequency and span is 1~5 MHz. RBW of the spectrum is 200kHz and VBW of the spectrum is 1MHz. (LTE bandwidth 20MHz)
- i. Record the max trace plot into the test report.



Test Report No.: RF170906W001-5

4.5.4 TEST RESULTS

LTE BAND 4

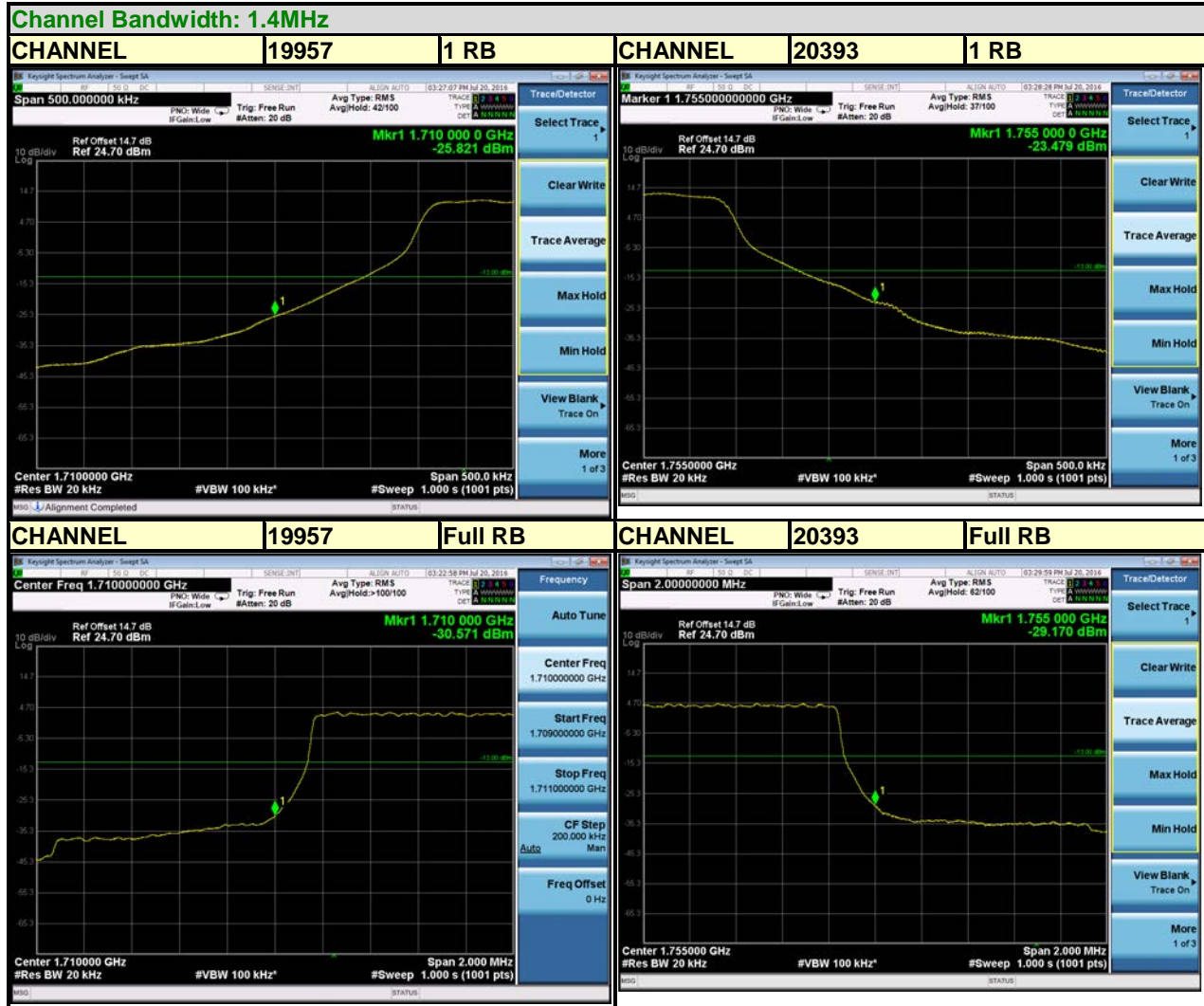



Test Report No.: RF170906W001-5

LTE BAND 4





Test Report No.: RF170906W001-5

LTE BAND 4

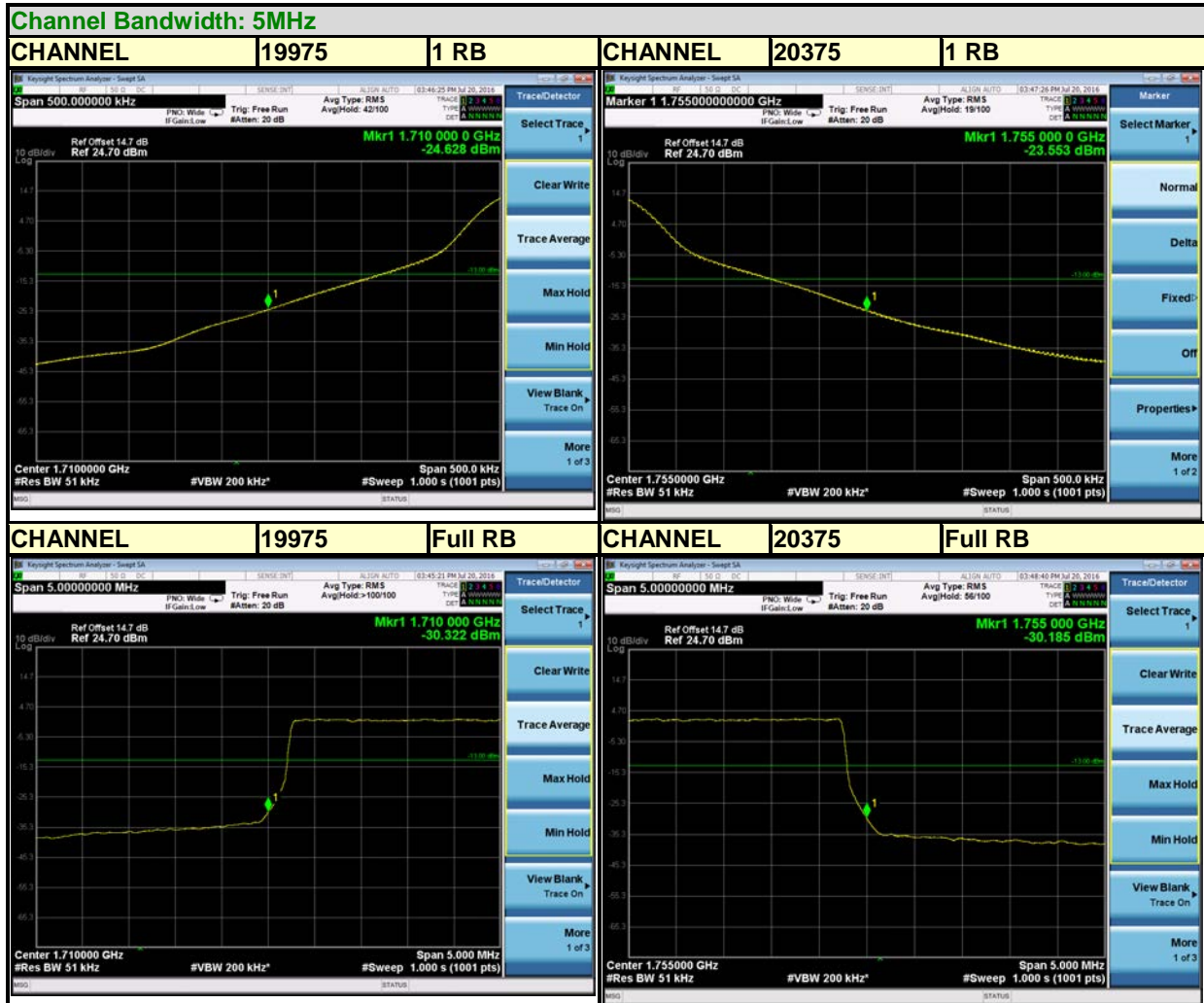



Test Report No.: RF170906W001-5

LTE BAND 4

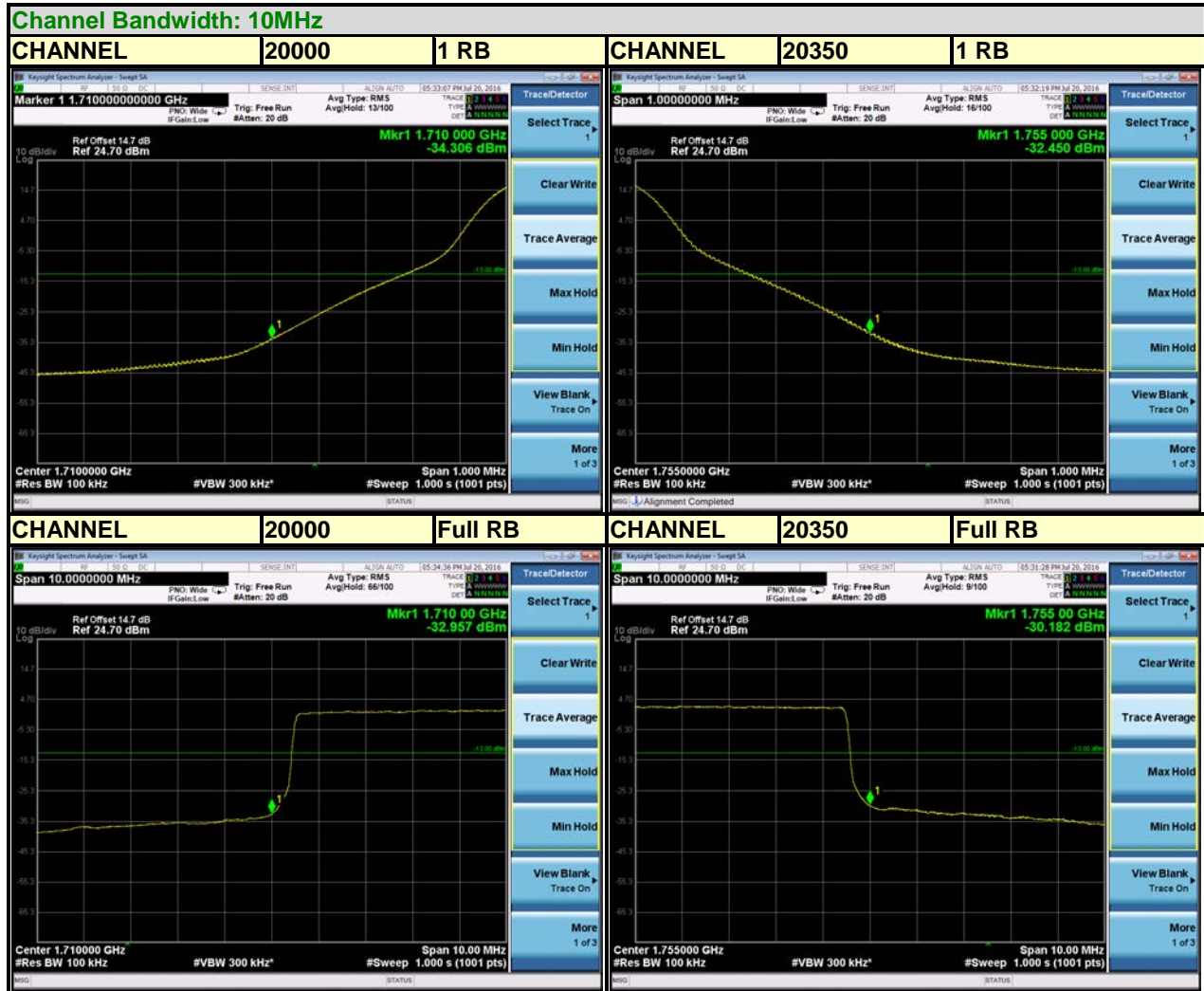



Test Report No.: RF170906W001-5

LTE BAND 4

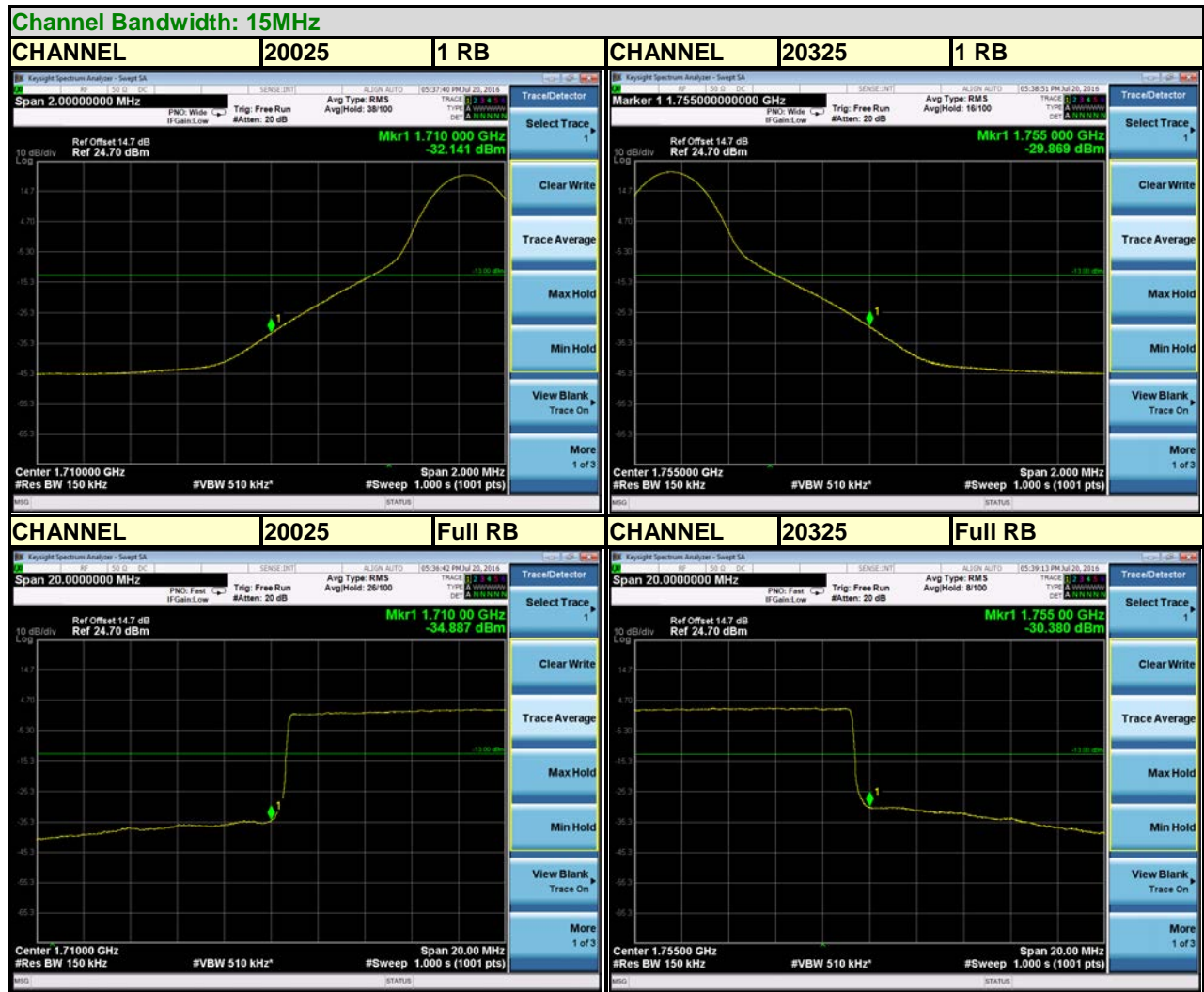



Test Report No.: RF170906W001-5

LTE BAND 4

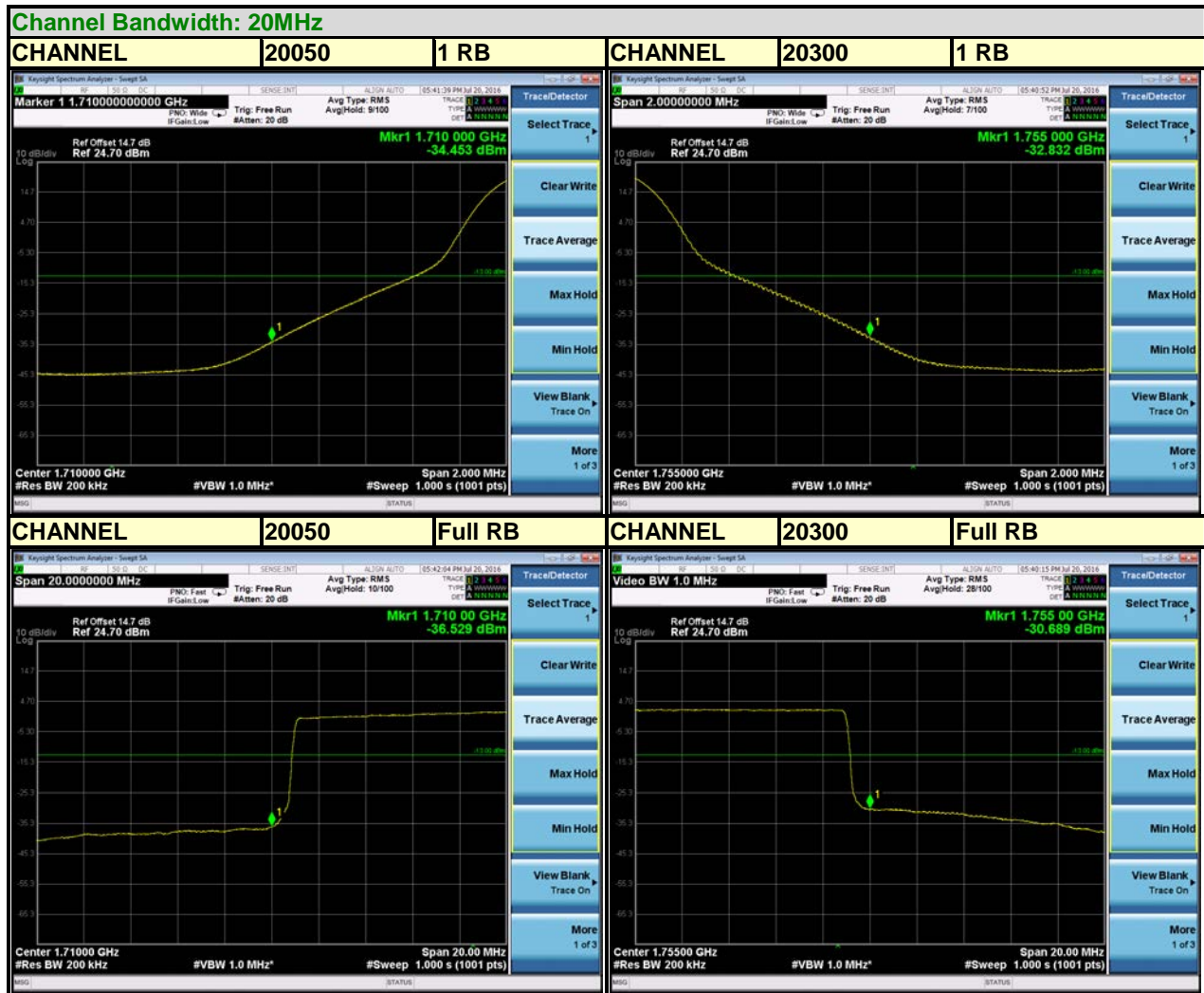

BV 7Layers Communications Technology (Shenzhen) Co. Ltd

No.B102, Dazu Chuangxin Mansion, North of BeiHuan Avenue, North Area, Hi-Tech Industrial Park, Nanshan District, Shenzhen, Guangdong, China

Tel: +86 755 8869 6566
 Fax: +86 755 8869 6577
 Email: customerservice.dq@cn.bureauveritas.com



Test Report No.: RF170906W001-5

LTE BAND 12

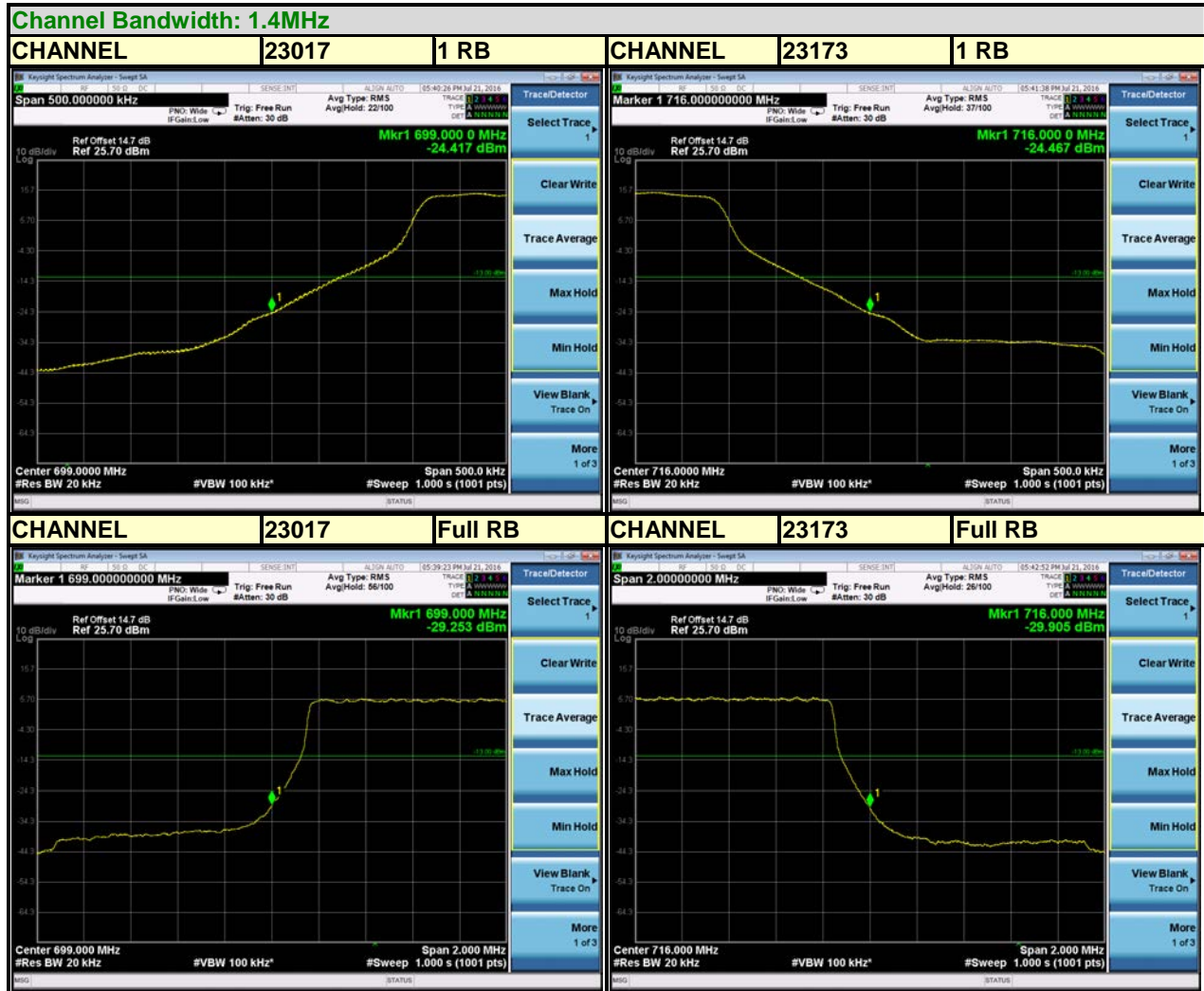



Test Report No.: RF170906W001-5

LTE BAND 12

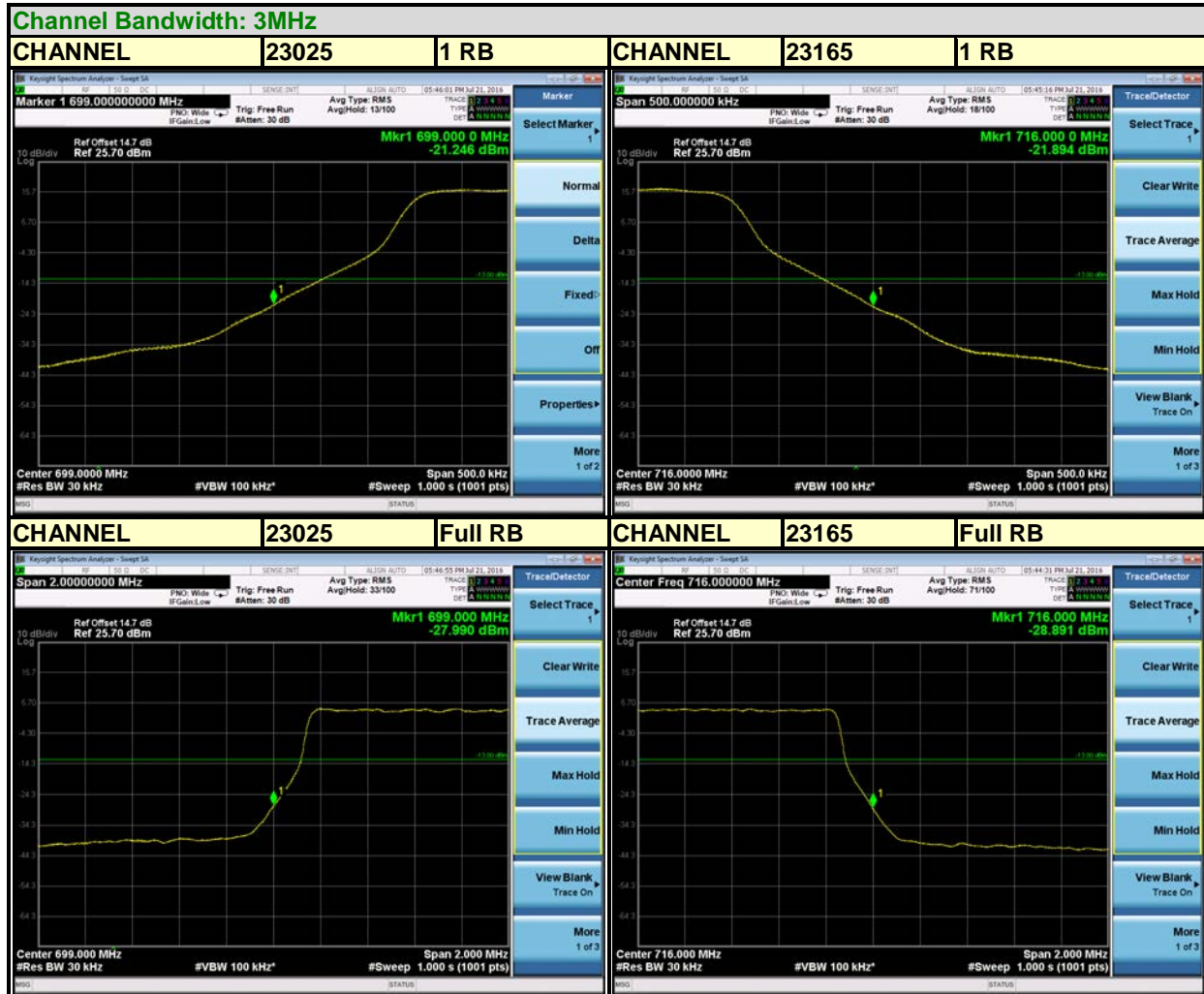



Test Report No.: RF170906W001-5

LTE BAND 12

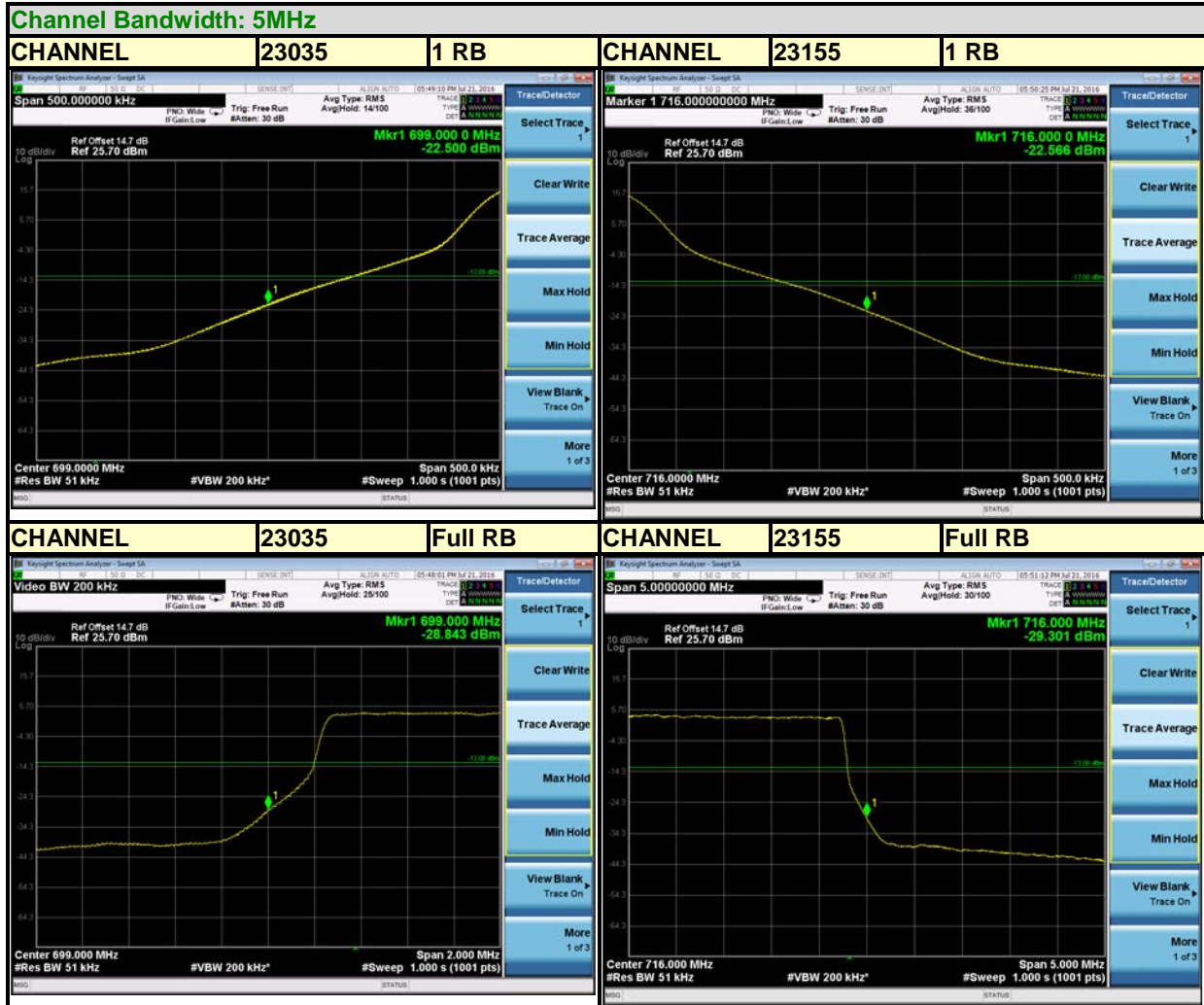



Test Report No.: RF170906W001-5

LTE BAND 12

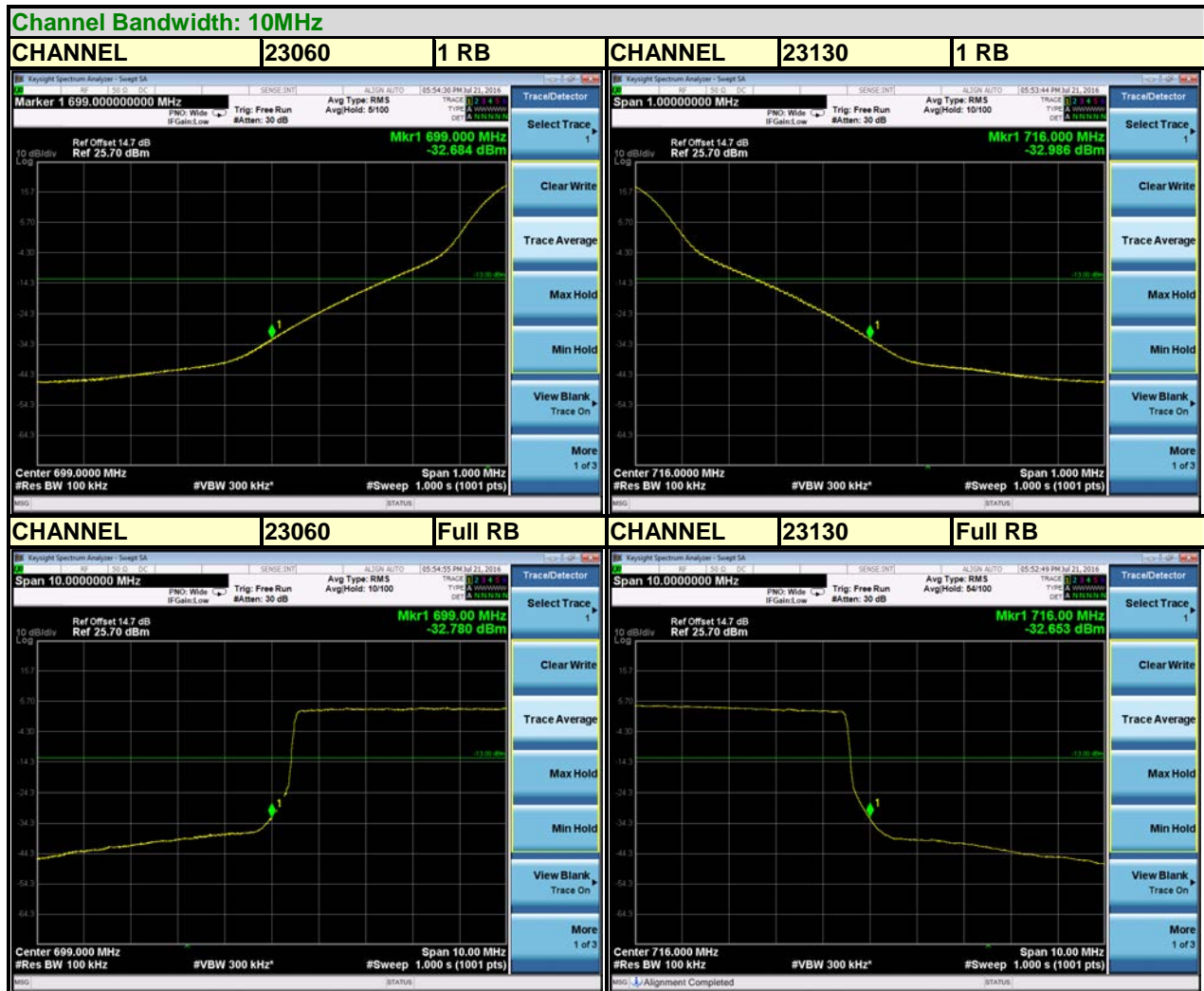



Test Report No.: RF170906W001-5

LTE BAND 17

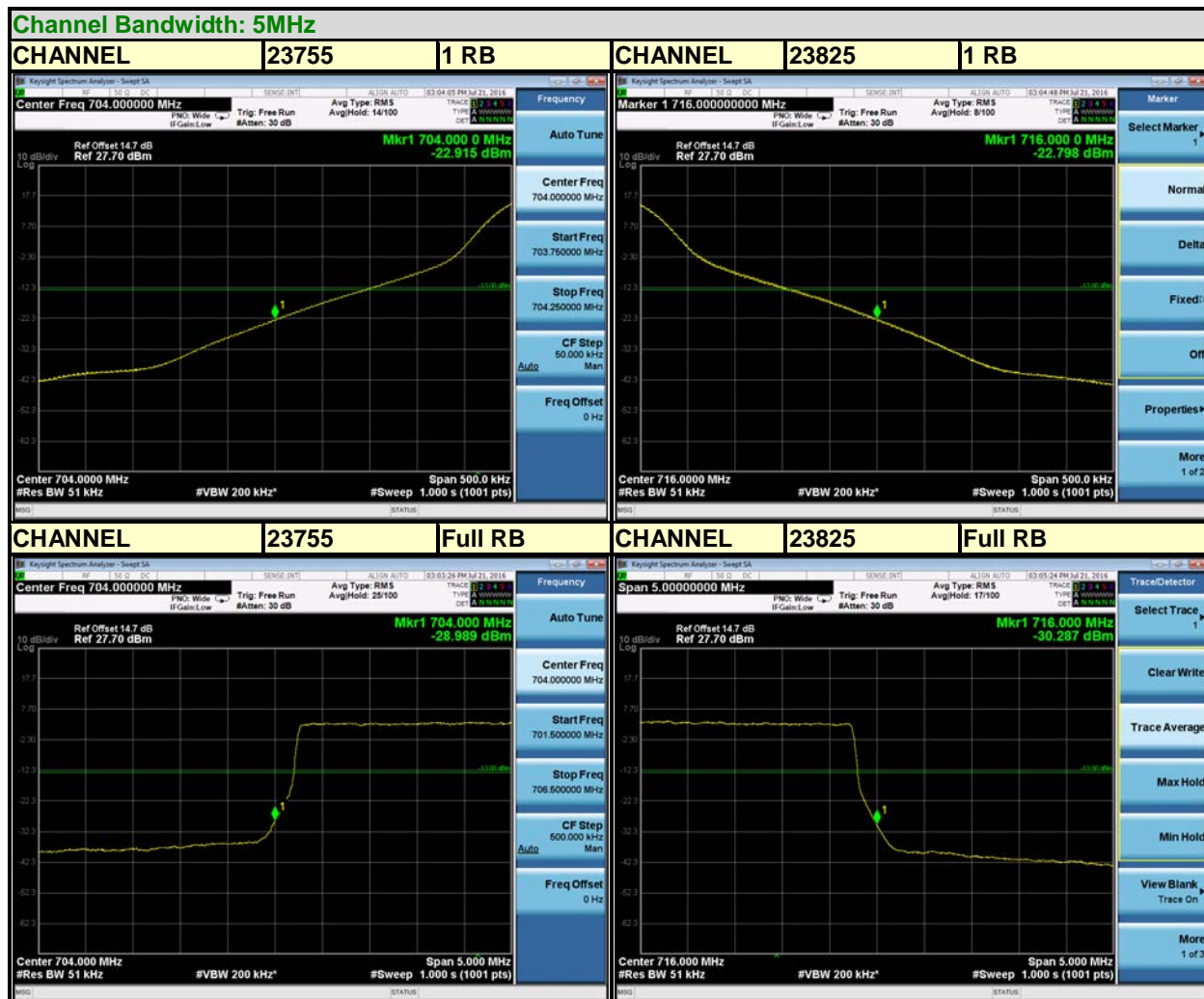



Test Report No.: RF170906W001-5

LTE BAND 17

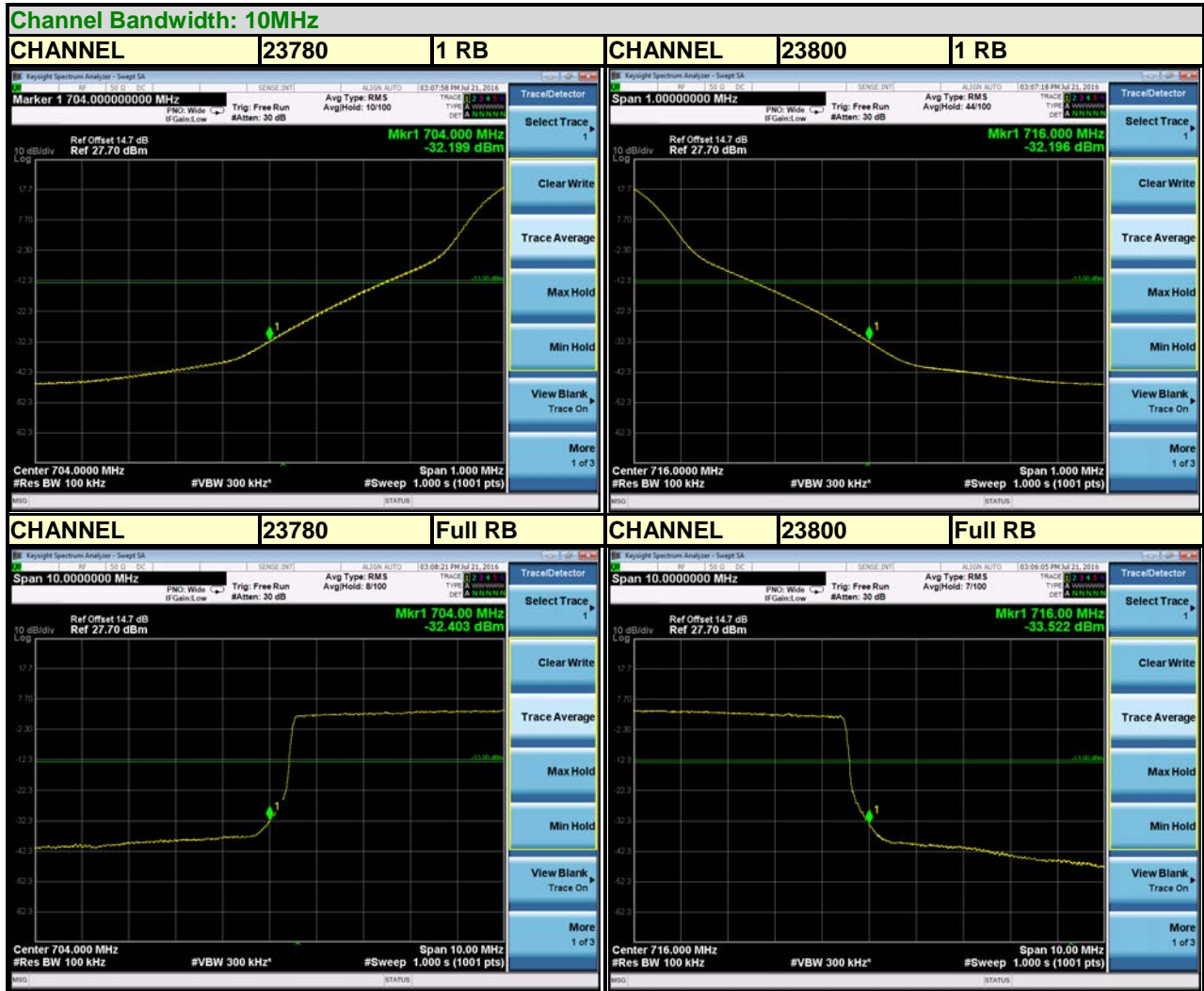

4.6 CONDUCTED SPURIOUS EMISSIONS

4.6.1 LIMITS OF CONDUCTED SPURIOUS EMISSIONS MEASUREMENT

The power of any emission outside a licensee's frequency block shall be attenuated below the transmitter power (P) by at least $43 + 10 \log_{10}(P)$ dB. The limit of emission equal to -13dBm

4.6.2 TEST PROCEDURE

- a. The EUT makes a phone call to the communication simulator. All measurements were done at middle operational frequency range.
- b. Measuring frequency range is from 30 MHz to 17.55GHz for LTE Band 4 and 30 MHz to 7.16GHz for LTE Band 12 & LTE Band 17. 10dB attenuation pad is connected with spectrum. RBW=1MHz and VBW=3MHz are used for conducted emission measurement.

4.6.3 TEST SETUP

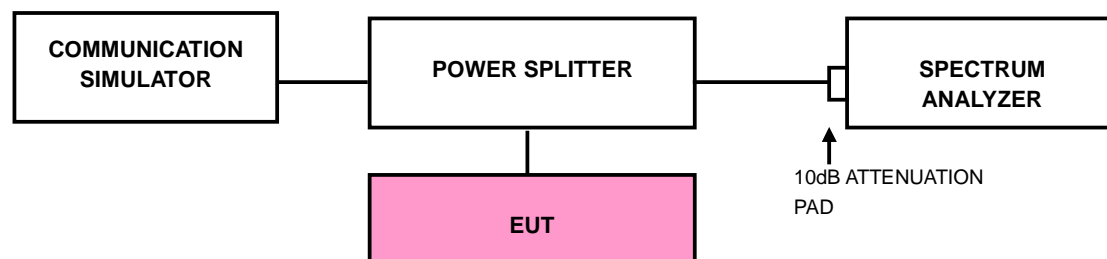



4.6.4 TEST RESULTS

LTE BAND 4

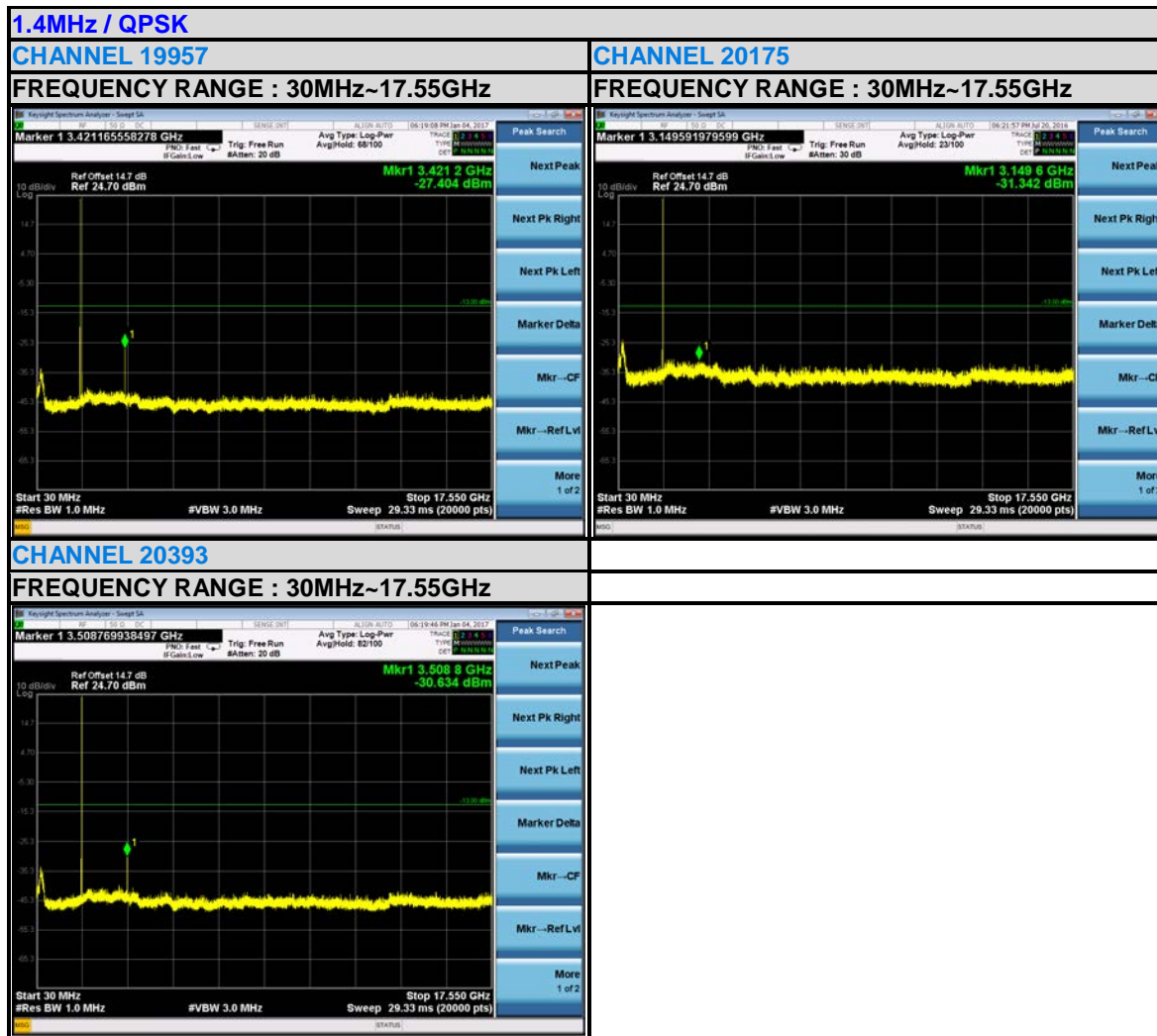



Test Report No.: RF170906W001-5

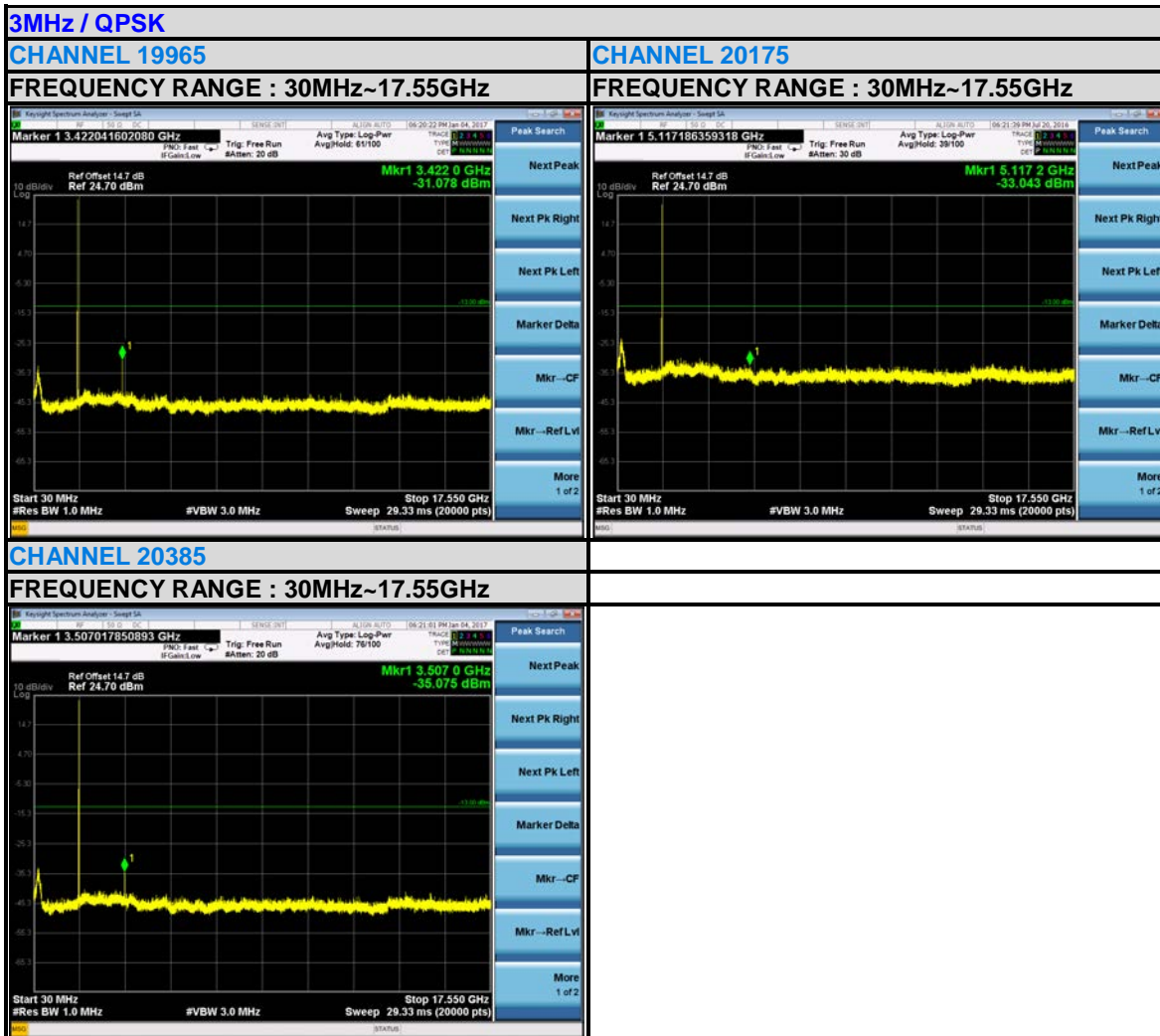



Test Report No.: RF170906W001-5

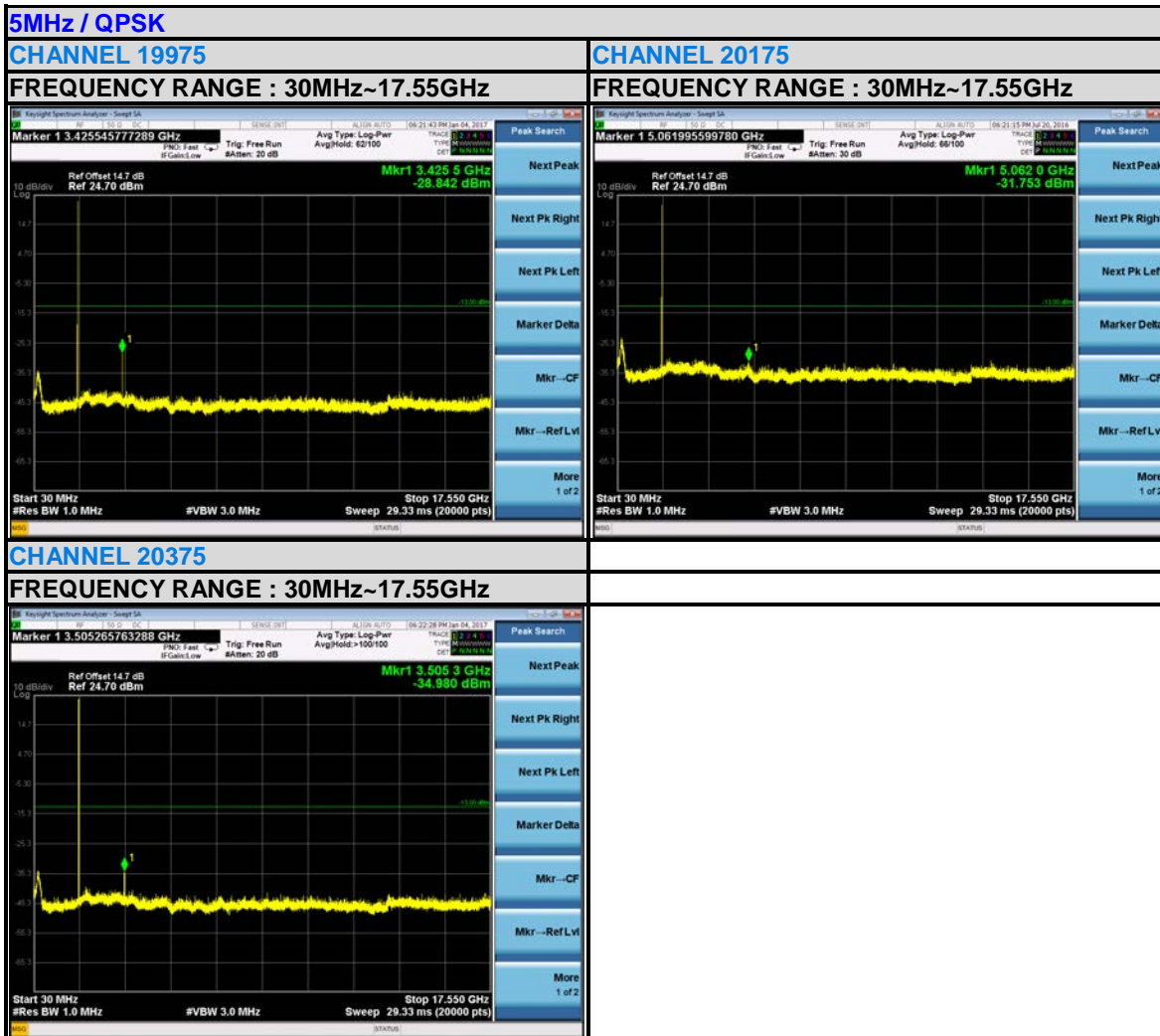



Test Report No.: RF170906W001-5

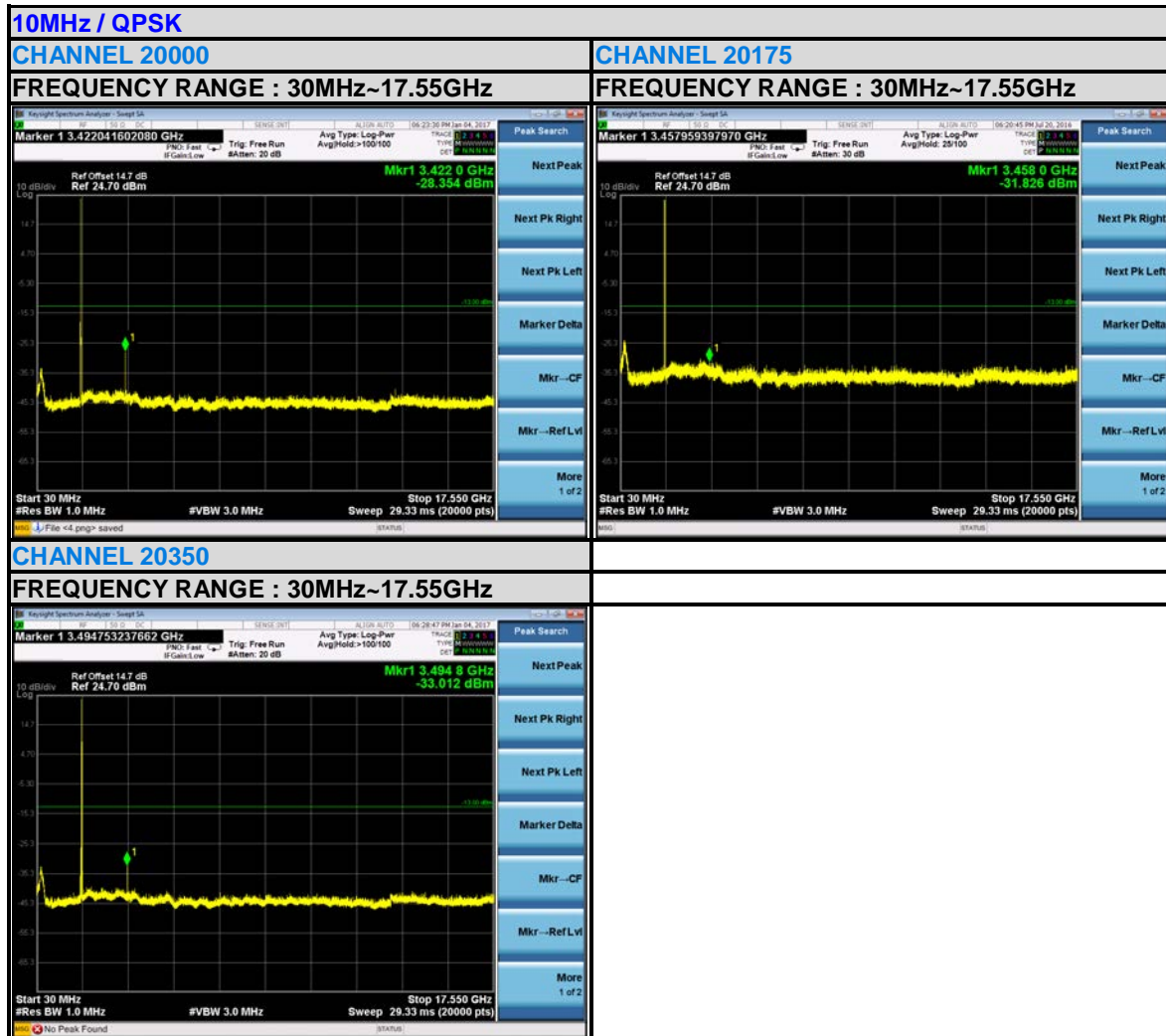



Test Report No.: RF170906W001-5

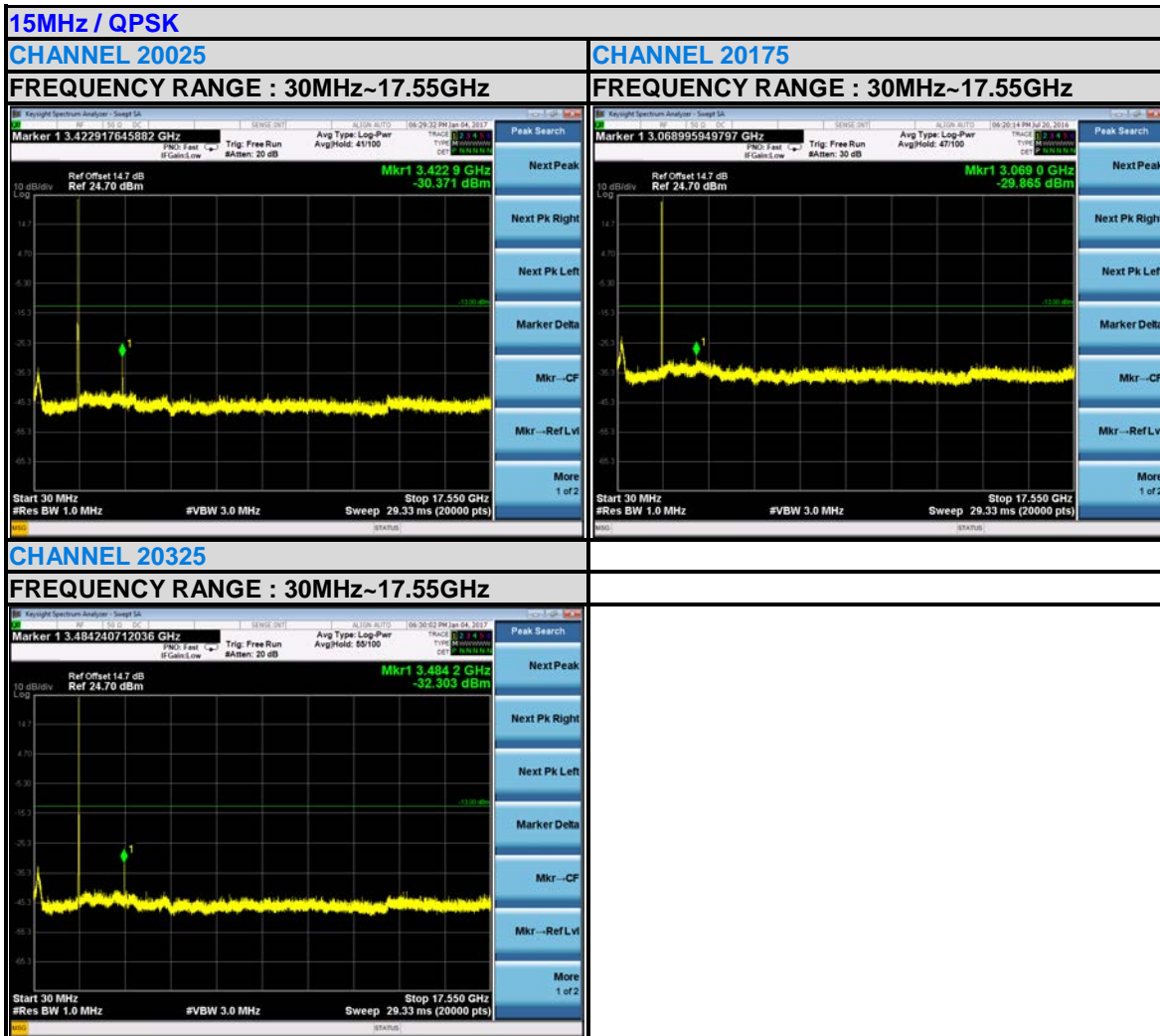

BV 7Layers Communications Technology (Shenzhen) Co. Ltd

No.B102, Dazu Chuangxin Mansion, North of Beiwan Avenue, North Area, Hi-Tech Industrial Park, Nanshan District, Shenzhen, Guangdong, China

Tel: +86 755 8869 6566
 Fax: +86 755 8869 6577
 Email: customerservice.dq@cn.bureauveritas.com



Test Report No.: RF170906W001-5

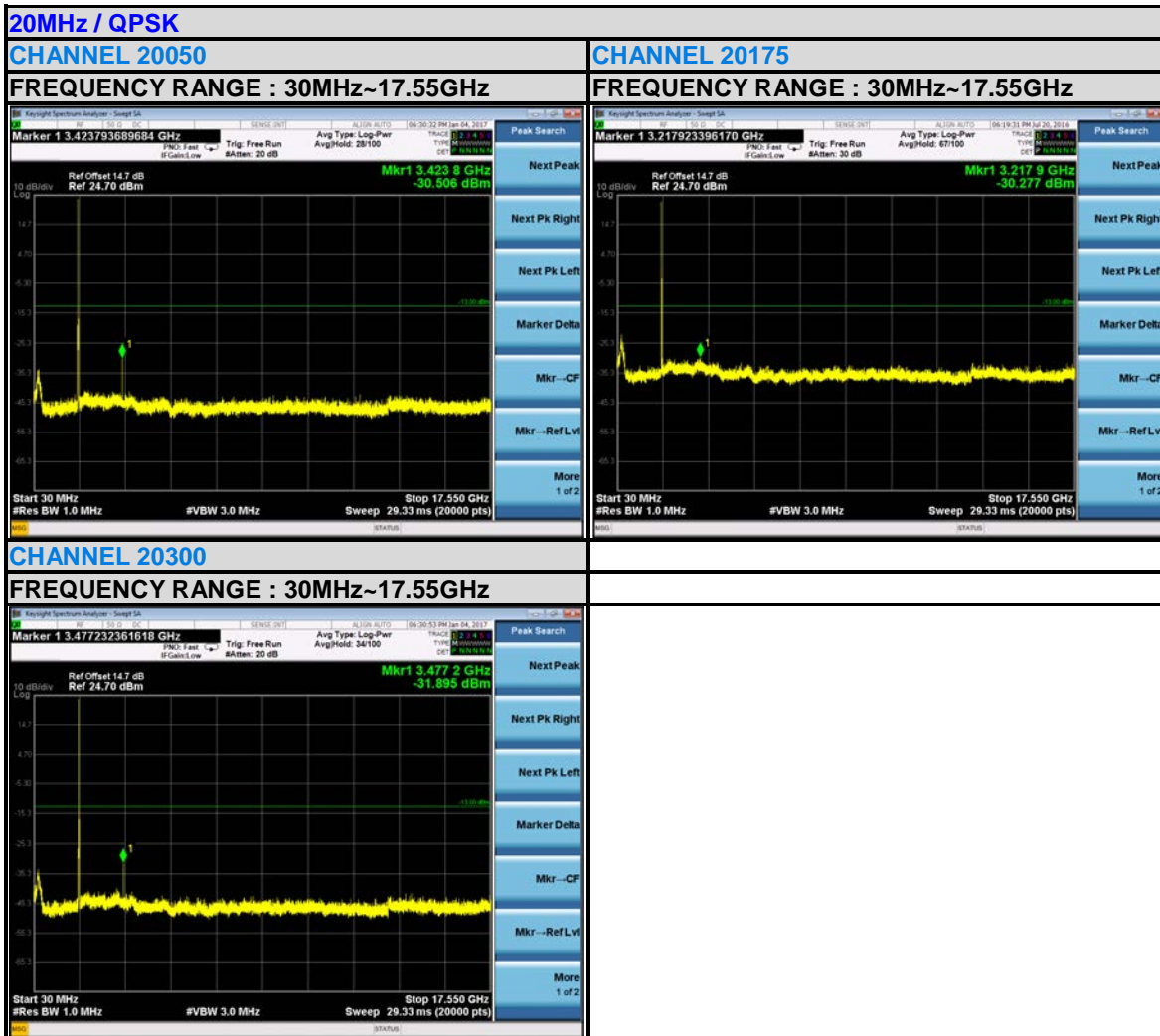



Test Report No.: RF170906W001-5

LTE BAND 12

1.4MHz / QPSK

CHANNEL 23017

FREQUENCY RANGE : 30MHz~7.16GHz

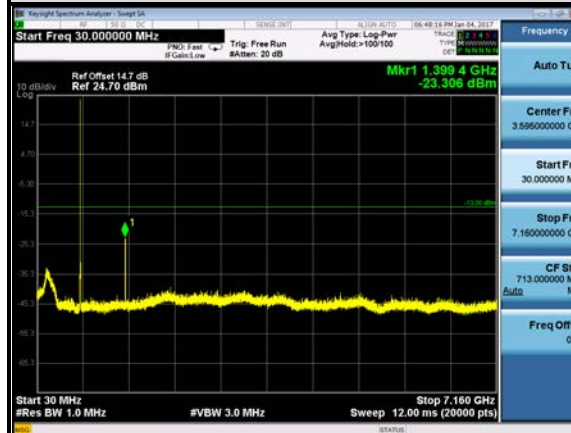

CHANNEL 23095

FREQUENCY RANGE : 30MHz~7.16GHz

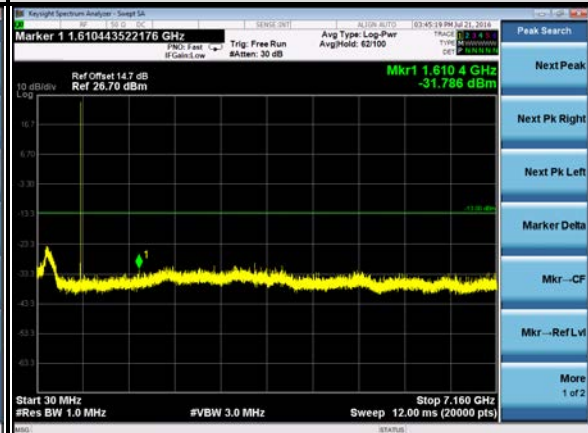

CHANNEL 23173

FREQUENCY RANGE : 30MHz~7.16GHz

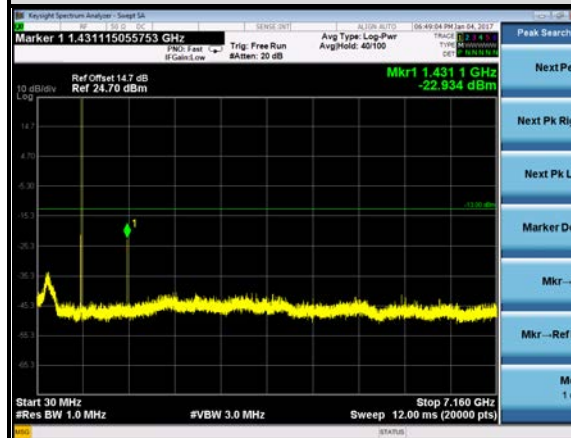



Test Report No.: RF170906W001-5

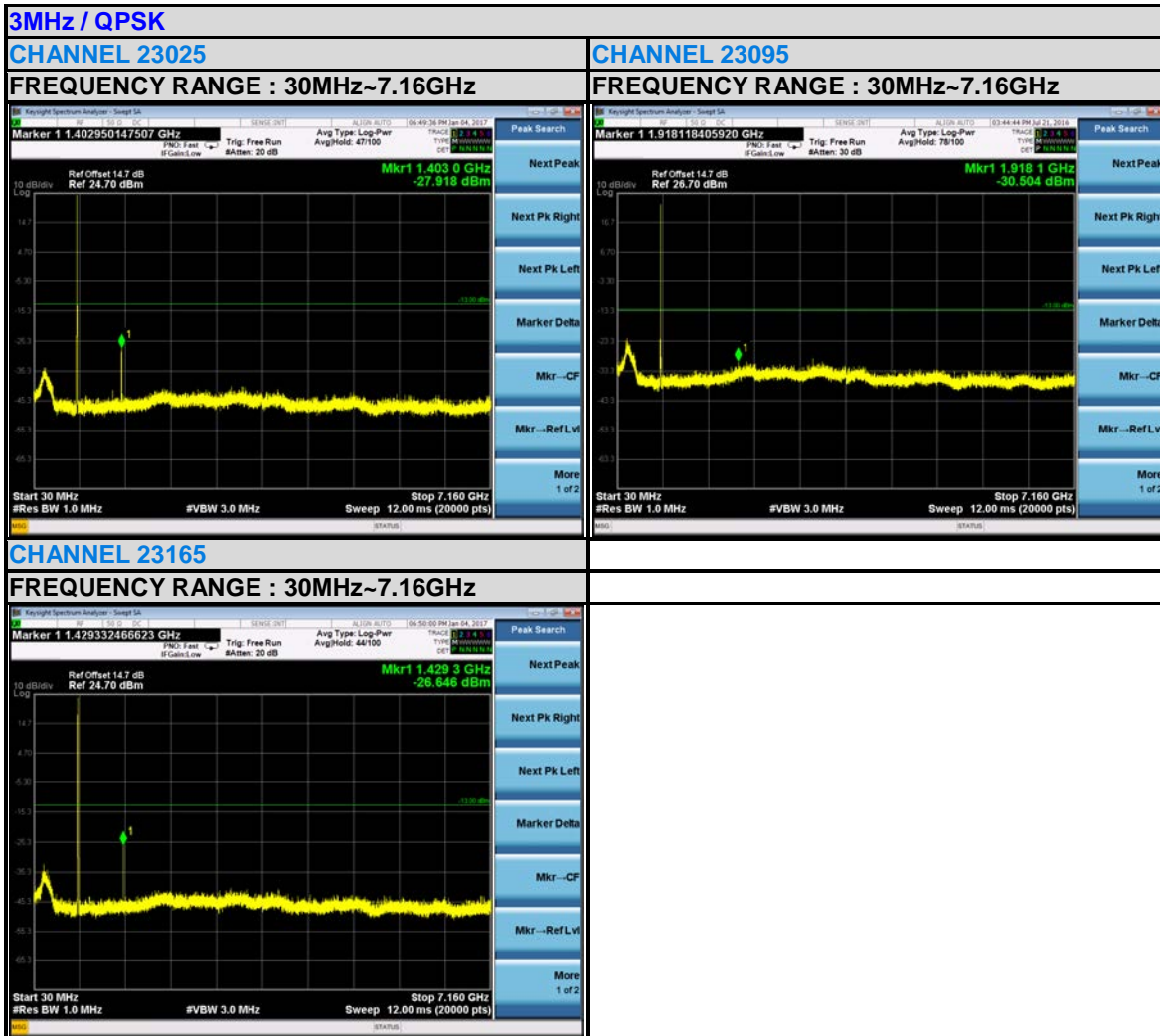

BV 7Layers Communications Technology (Shenzhen) Co. Ltd

No.B102, Dazu Chuangxin Mansion, North of Beihuan Avenue, North Area, Hi-Tech Industrial Park, Nanshan District, Shenzhen, Guangdong, China

Tel: +86 755 8869 6566
 Fax: +86 755 8869 6577
 Email: customerservice.dq@cn.bureauveritas.com



Test Report No.: RF170906W001-5



BV 7Layers Communications Technology (Shenzhen) Co. Ltd

No.B102, Dazu Chuangxin Mansion, North of Beihuan Avenue, North Area, Hi-Tech Industrial Park, Nanshan District, Shenzhen, Guangdong, China

Tel: +86 755 8869 6566
Fax: +86 755 8869 6577
Email: customerservice.dq@cn.bureauveritas.com



Test Report No.: RF170906W001-5

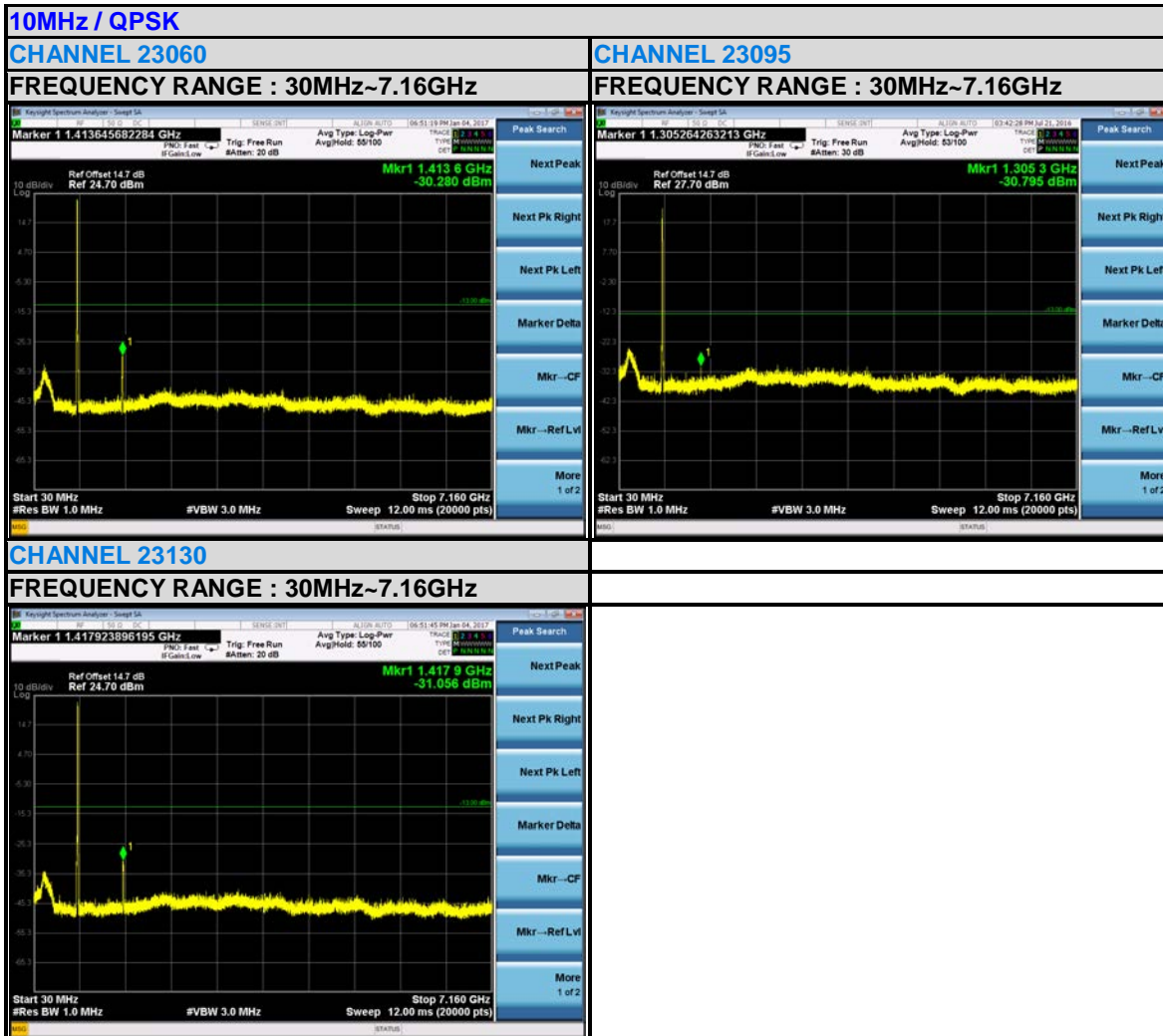



LTE BAND 17

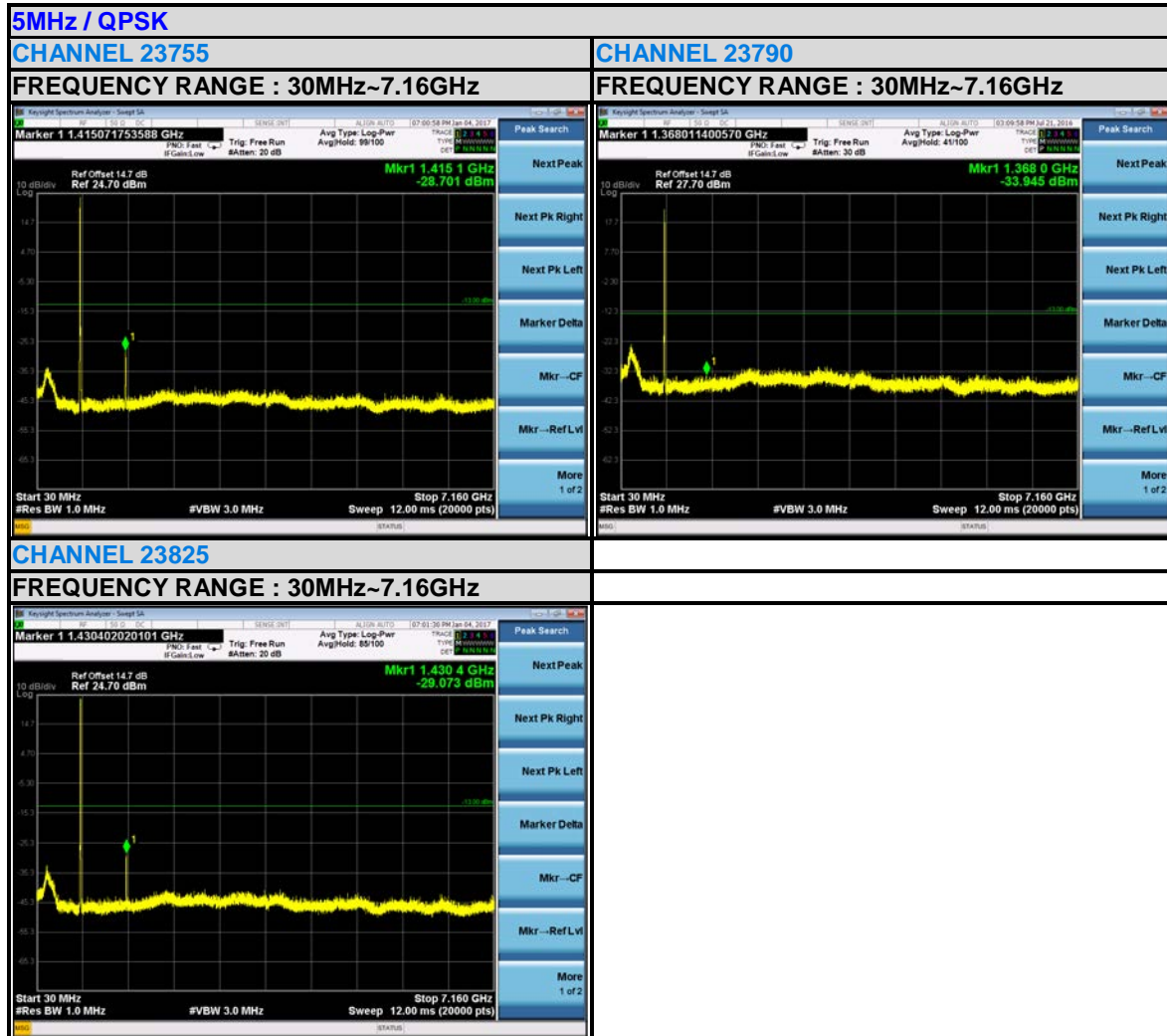



Test Report No.: RF170906W001-5

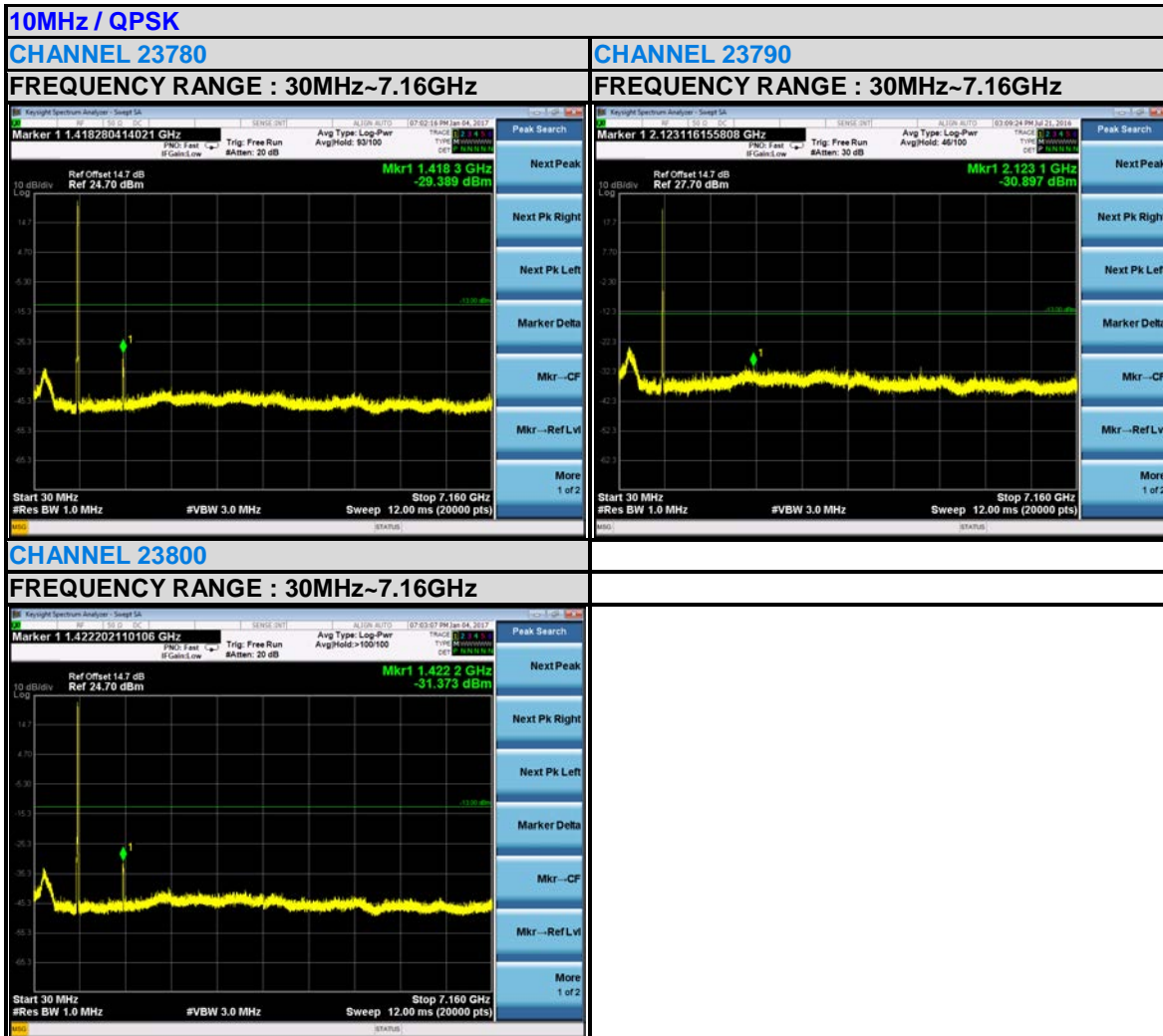



4.7 RADIATED EMISSION MEASUREMENT

4.7.1 LIMITS OF RADIATED EMISSION MEASUREMENT

The power of any emission outside a licensee's frequency block shall be attenuated below the transmitter power (P) by at least $43 + 10 \log_{10}(P)$ dB. The limit of emission equal to -13dBm

4.7.2 TEST PROCEDURES

- a. Substitution method is used for E.I.R.P measurement. In the semi-anechoic chamber, EUT placed on the 0.8m height of Turn Table, rotated the table around 360 degrees to search the maximum radiation power and receiver antenna shall be rotated vertical and horizontal polarization and moved height from 1m to 4m to find the maximum polar radiated power. The "Read Value" is the spectrum reading the maximum power value.
- b. The substitution horn antenna is substituted for EUT at the same position and signals generator export the CW signal to the substitution antenna via a TX cable. Rotated the Turn Table and moved receiving antenna to find the maximum radiation power. Adjust output power level of S.G to get a Value of spectrum reading equal to "Read Value" of step a. Record the power level of S.G
- c. $\text{EIRP} = \text{Output power level of S.G} - \text{TX cable loss} + \text{Antenna gain of substitution horn.}$
- d. E.R.P power can be calculated form E.I.R.P power by subtracting the gain of dipole, $\text{E.R.P power} = \text{E.I.P.R power} - 2.15\text{dBi.}$

NOTE: The resolution bandwidth of spectrum analyzer is 1 MHz and the video bandwidth is 3 MHz.

4.7.3 DEVIATION FROM TEST STANDARD

No deviation

4.7.4 TEST SETUP

<Below 30MHz>

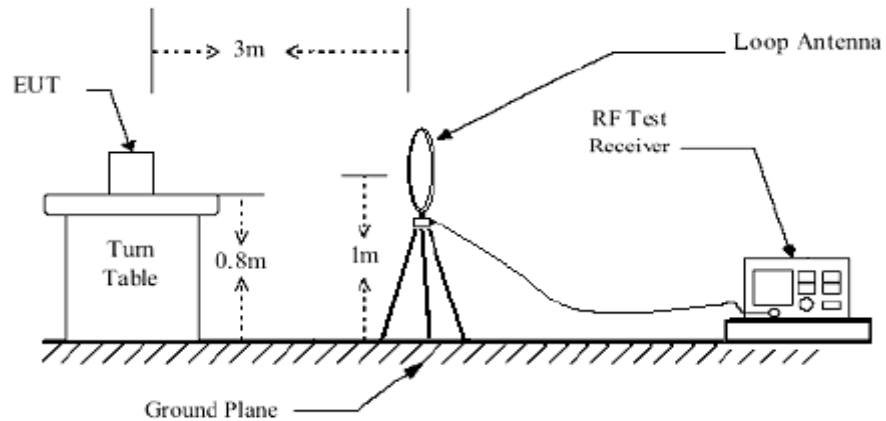

<Above 30MHz>

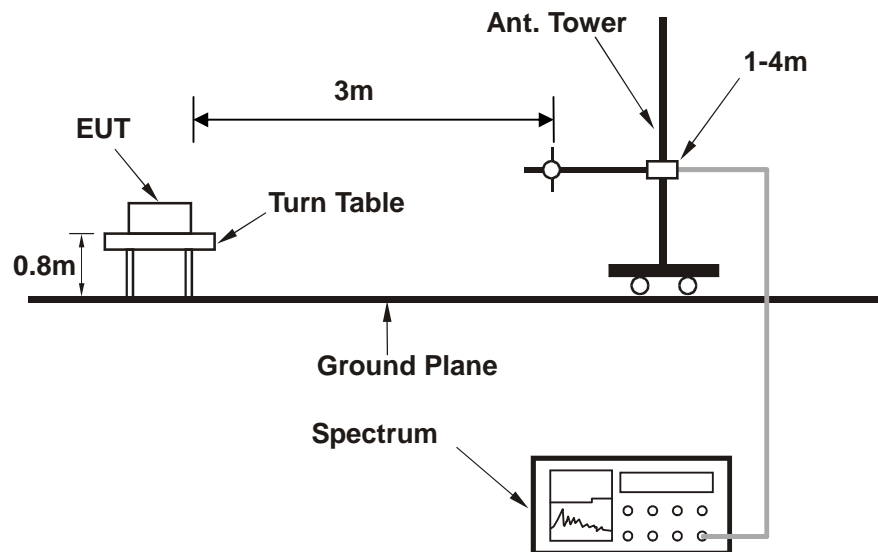

For the actual test configuration, please refer to the attached file (Test Setup Photo).



4.7.5 TEST RESULTS

BELOW 1GHz WORST-CASE DATA

9 KHz – 30 KHz data: the amplitude of spurious emissions attenuated more than 20 dB below the permissible value is not required in the report.

30 MHz – 1GHz data:

LTE Band 17:

MODE	TX channel 23790	FREQUENCY RANGE	Below 1000MHz
ENVIRONMENTAL CONDITIONS	23deg. C, 70%RH	INPUT POWER	DC 24V from adapter
TESTED BY	Simon Yang		
ANTENNA POLARITY & TEST DISTANCE: HORIZONTAL AT 3 M			

	Freq	Level	Read Level	Limit Line	Over Limit	Factor	Remark	Pol/Phase
	MHz	dBm/m	dBm	dBm/m	dB	dB/m		
1	46.490	-20.09	-26.43	-13.00	-7.09	6.34	Peak	Horizontal
2 PP	76.560	-18.78	-9.52	-13.00	-5.78	-9.26	Peak	Horizontal
3	156.100	-35.46	-16.73	-13.00	-22.46	-18.73	Peak	Horizontal
4	230.790	-33.49	-16.84	-13.00	-20.49	-16.65	Peak	Horizontal
5	303.540	-57.87	-44.18	-13.00	-44.87	-13.69	Peak	Horizontal
6	340.400	-53.86	-41.40	-13.00	-40.86	-12.46	Peak	Horizontal

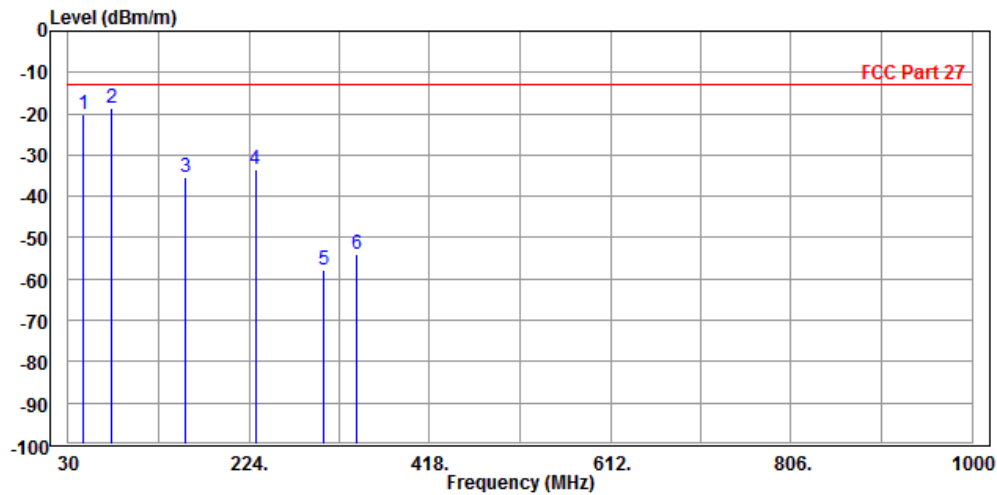



Test Report No.: RF170906W001-5

MODE	TX channel 23790	FREQUENCY RANGE	Below 1000MHz
ENVIRONMENTAL CONDITIONS	23deg. C, 70%RH	INPUT POWER	DC 24V from adapter
TESTED BY	Simon Yang		
ANTENNA POLARITY & TEST DISTANCE: VERTICAL AT 3 M			

	Freq	Level	Read Level	Limit Line	Over Limit	Factor	Remark	Pol/Phase
	MHz	dBm/m	dBm	dBm/m	dB	dB/m		
1	53.080	-20.39	-13.32	-13.00	-7.39	-7.07	Peak	Vertical
2	106.930	-28.28	-16.69	-13.00	-15.28	-11.59	Peak	Vertical
3	193.090	-20.41	-8.90	-13.00	-7.41	-11.51	Peak	Vertical
4	282.840	-39.93	-28.56	-13.00	-26.93	-11.37	Peak	Vertical
5	351.050	-50.90	-39.79	-13.00	-37.90	-11.11	Peak	Vertical
6	512.600	-41.12	-33.86	-13.00	-28.12	-7.26	Peak	Vertical

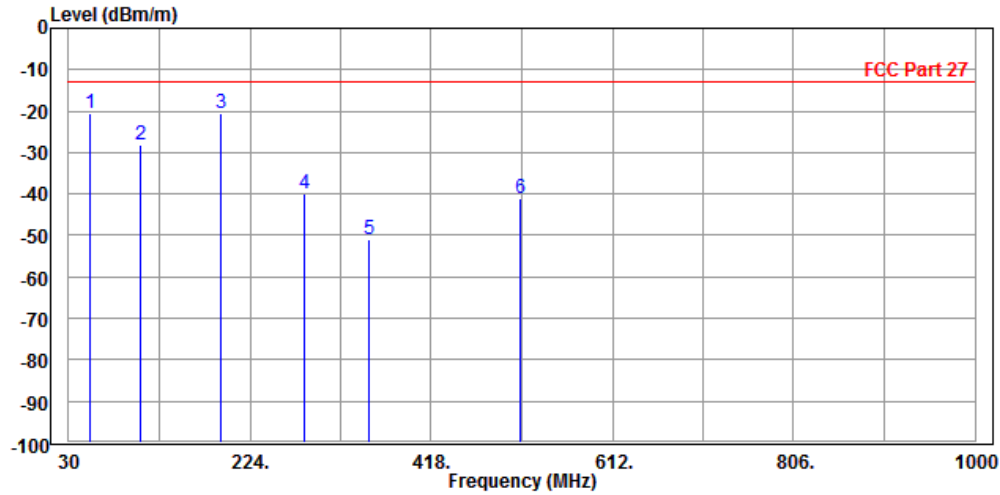



Test Report No.: RF170906W001-5

ABOVE 1GHz

Note: For higher frequency, the emission is too low to be detected.

LTE BAND 4

CHANNEL BANDWIDTH: 1.4MHz / QPSK

MODE	TX channel 20175	FREQUENCY RANGE	Above 1000MHz
ENVIRONMENTAL CONDITIONS	23deg. C, 70%RH	INPUT POWER	DC 24V from adapter
TESTED BY	Simon Yang		
ANTENNA POLARITY & TEST DISTANCE: HORIZONTAL AT 3 M			

	Freq	Level	Read Level	Limit Line	Over Limit	Factor	Remark	Pol/Phase
	MHz	dBm/m	dBm	dBm/m	dB	dB/m		
1	3470.000	-50.55	-52.60	-13.00	-37.55	2.05	Peak	Horizontal
2 PP	5197.000	-47.64	-56.25	-13.00	-34.64	8.61	Peak	Horizontal

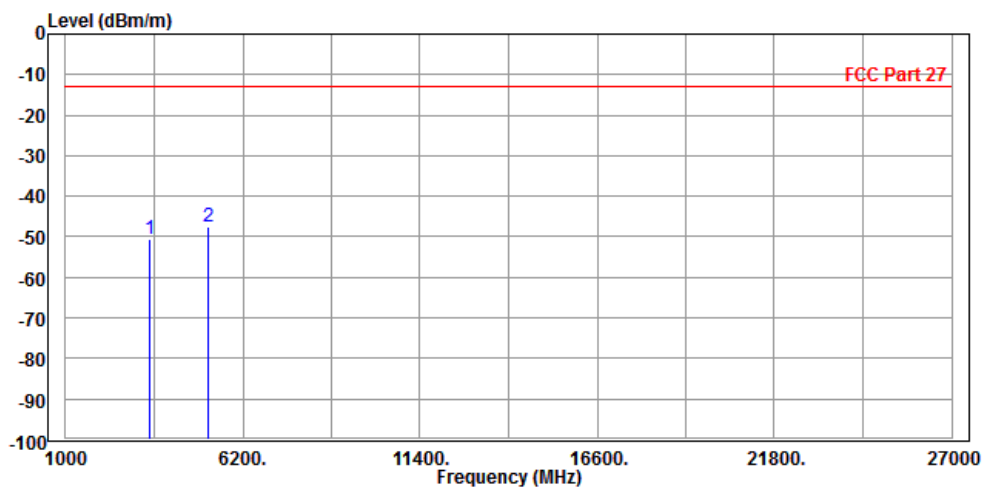



Test Report No.: RF170906W001-5

MODE	TX channel 20175	FREQUENCY RANGE	Above 1000MHz
ENVIRONMENTAL CONDITIONS	23deg. C, 70%RH	INPUT POWER	DC 24V from adapter
TESTED BY	Simon Yang		
ANTENNA POLARITY & TEST DISTANCE: VERTICAL AT 3 M			

	Freq	Level	Read Level	Limit	Over Limit	Factor	Remark	Pol/Phase
	MHz	dBm/m	dBm	dBm/m	dB	dB/m		
1	3470.000	-52.05	-54.58	-13.00	-39.05	2.53	Peak	Vertical
2	PP 5197.000	-47.50	-55.48	-13.00	-34.50	7.98	Peak	Vertical

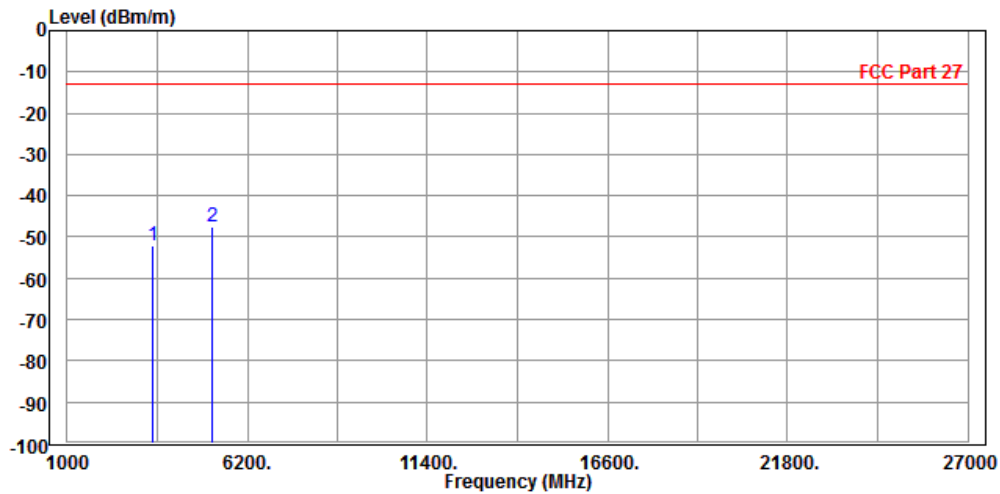



Test Report No.: RF170906W001-5

CHANNEL BANDWIDTH: 3MHz / QPSK

MODE	TX channel 20175	FREQUENCY RANGE	Above 1000MHz
ENVIRONMENTAL CONDITIONS	23deg. C, 70%RH	INPUT POWER	DC 24V from adapter
TESTED BY	Simon Yang		
ANTENNA POLARITY & TEST DISTANCE: HORIZONTAL AT 3 M			

	Freq	Level	Read Level	Limit Line	Over Limit	Factor	Remark	Pol/Phase
	MHz	dBm/m	dBm	dBm/m	dB	dB/m		
1	3470.000	-51.10	-53.15	-13.00	-38.10	2.05	Peak	Horizontal
2	PP 5197.000	-46.92	-55.53	-13.00	-33.92	8.61	Peak	Horizontal

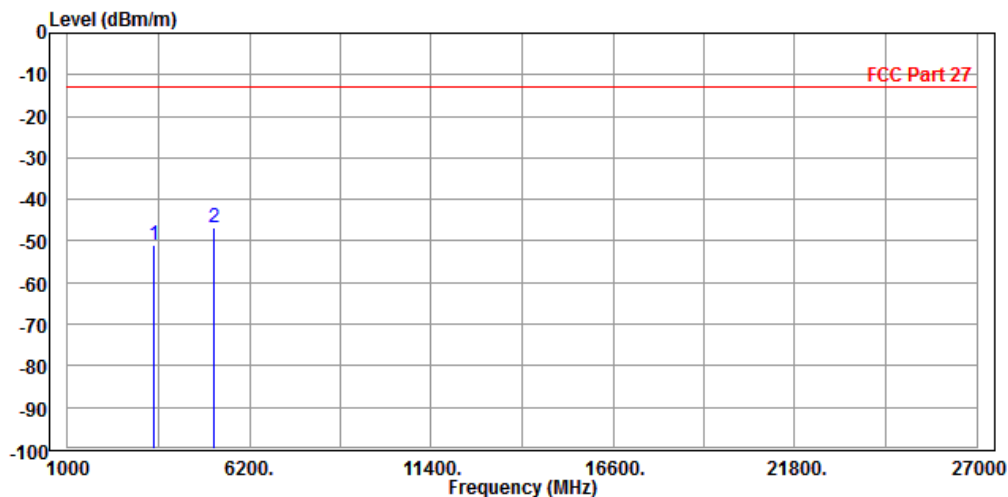



Test Report No.: RF170906W001-5

MODE	TX channel 20175	FREQUENCY RANGE	Above 1000MHz
ENVIRONMENTAL CONDITIONS	23deg. C, 70%RH	INPUT POWER	DC 24V from adapter
TESTED BY	Simon Yang		
ANTENNA POLARITY & TEST DISTANCE: VERTICAL AT 3 M			

	Freq	Level	Read Level	Limit Line	Over Limit	Factor	Remark	Pol/Phase
	MHz	dBm/m	dBm	dBm/m	dB	dB/m		
1	3470.000	-52.97	-55.50	-13.00	-39.97	2.53	Peak	Vertical
2 PP	5197.000	-47.97	-55.95	-13.00	-34.97	7.98	Peak	Vertical

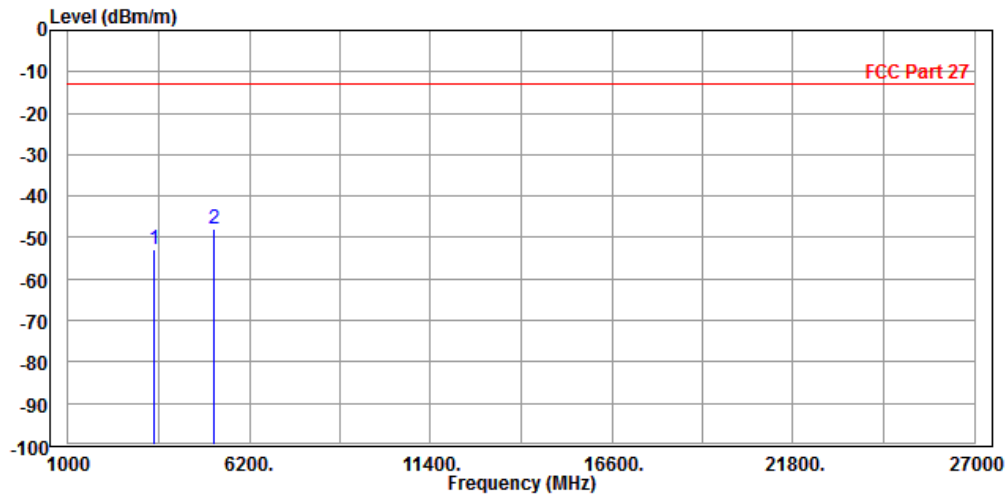



Test Report No.: RF170906W001-5

CHANNEL BANDWIDTH: 5MHz / QPSK

CH 19975

MODE	TX channel 19975	FREQUENCY RANGE	Above 1000MHz
ENVIRONMENTAL CONDITIONS	23deg. C, 70%RH	INPUT POWER	DC 24V from adapter
TESTED BY	Simon Yang		
ANTENNA POLARITY & TEST DISTANCE: HORIZONTAL AT 3 M			

	Freq	Level	Read Level	Limit Line	Over Limit	Factor	Remark	Pol/Phase
	MHz	dBm/m	dBm	dBm/m	dB	dB/m		
1	3418.000	-51.04	-52.89	-13.00	-38.04	1.85	Peak	Horizontal
2 PP	5137.500	-46.06	-54.60	-13.00	-33.06	8.54	Peak	Horizontal

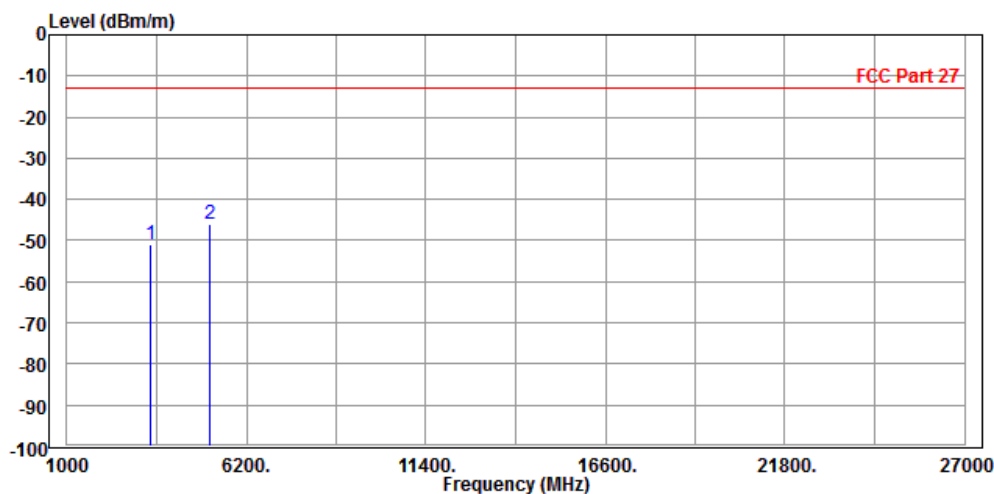



Test Report No.: RF170906W001-5

MODE	TX channel 19975	FREQUENCY RANGE	Above 1000MHz
ENVIRONMENTAL CONDITIONS	23deg. C, 70%RH	INPUT POWER	DC 24V from adapter
TESTED BY	Simon Yang		
ANTENNA POLARITY & TEST DISTANCE: VERTICAL AT 3 M			

	Freq	Level	Read Level	Limit Line	Over Limit	Factor	Remark	Pol/Phase
	MHz	dBm/m	dBm	dBm/m	dB	dB/m		
1	3418.000	-51.70	-54.17	-13.00	-38.70	2.47	Peak	Vertical
2 PP	5137.500	-46.95	-54.94	-13.00	-33.95	7.99	Peak	Vertical

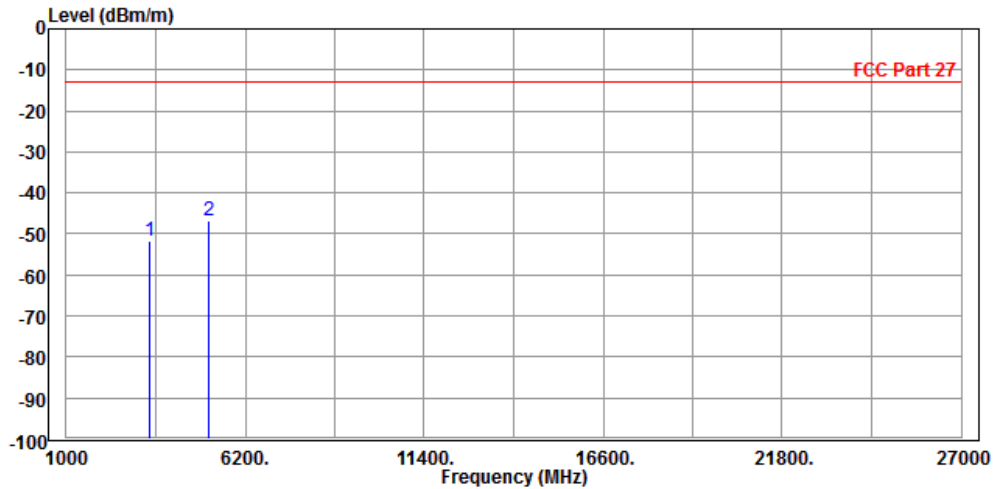



Test Report No.: RF170906W001-5

CH 20175

MODE	TX channel 20175	FREQUENCY RANGE	Above 1000MHz
ENVIRONMENTAL CONDITIONS	23deg. C, 70%RH	INPUT POWER	DC 24V from adapter
TESTED BY	Simon Yang		
ANTENNA POLARITY & TEST DISTANCE: HORIZONTAL AT 3 M			

	Freq	Level	Read Level	Limit Line	Over Limit	Factor	Remark	Pol/Phase
	MHz	dBm/m	dBm	dBm/m	dB	dB/m		
1	3470.000	-50.22	-52.27	-13.00	-37.22	2.05	Peak	Horizontal
2 PP	5197.000	-46.89	-55.50	-13.00	-33.89	8.61	Peak	Horizontal

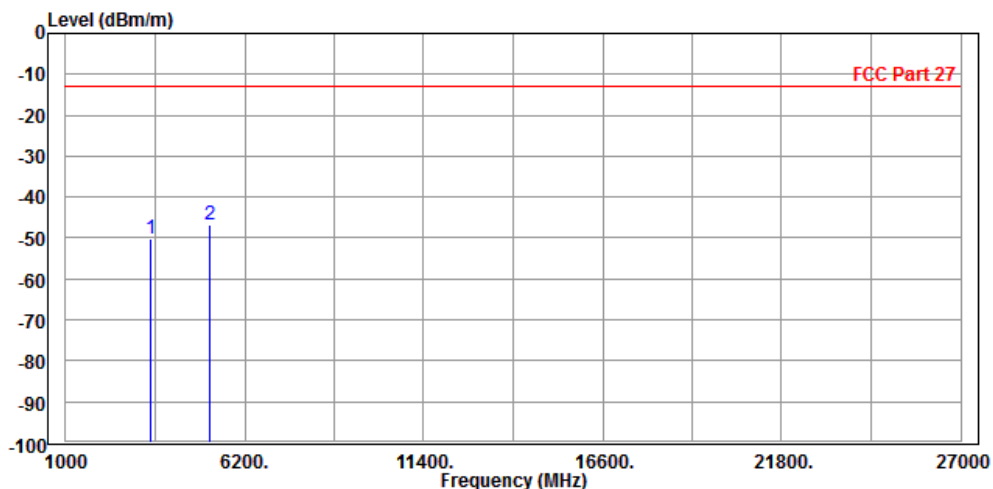



Test Report No.: RF170906W001-5

MODE	TX channel 20175	FREQUENCY RANGE	Above 1000MHz
ENVIRONMENTAL CONDITIONS	23deg. C, 70%RH	INPUT POWER	DC 24V from adapter
TESTED BY	Simon Yang		
ANTENNA POLARITY & TEST DISTANCE: VERTICAL AT 3 M			

	Freq	Level	Read Level	Limit Line	Over Limit	Factor	Remark	Pol/Phase
	MHz	dBm/m	dBm	dBm/m	dB	dB/m		
1	3470.000	-53.32	-55.85	-13.00	-40.32	2.53	Peak	Vertical
2 PP	5197.000	-48.55	-56.53	-13.00	-35.55	7.98	Peak	Vertical

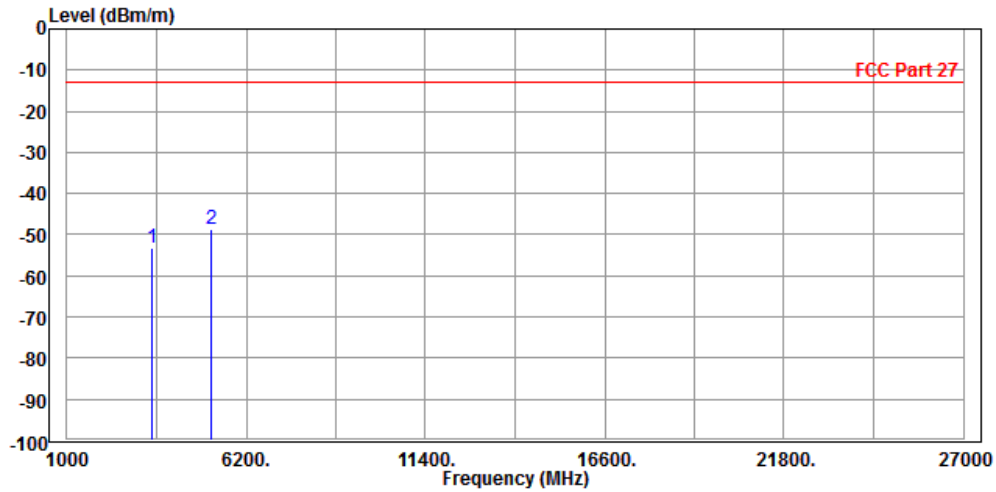



Test Report No.: RF170906W001-5

CH 20375

MODE	TX channel 20375	FREQUENCY RANGE	Above 1000MHz
ENVIRONMENTAL CONDITIONS	23deg. C, 70%RH	INPUT POWER	DC 24V from adapter
TESTED BY	Simon Yang		
ANTENNA POLARITY & TEST DISTANCE: HORIZONTAL AT 3 M			

	Freq	Level	Read Level	Limit Line	Over Limit	Factor	Remark	Pol/Phase
	MHz	dBm/m	dBm	dBm/m	dB	dB/m		
1	3496.000	-51.15	-53.30	-13.00	-38.15	2.15	Peak	Horizontal
2	PP 5257.500	-47.36	-56.04	-13.00	-34.36	8.68	Peak	Horizontal

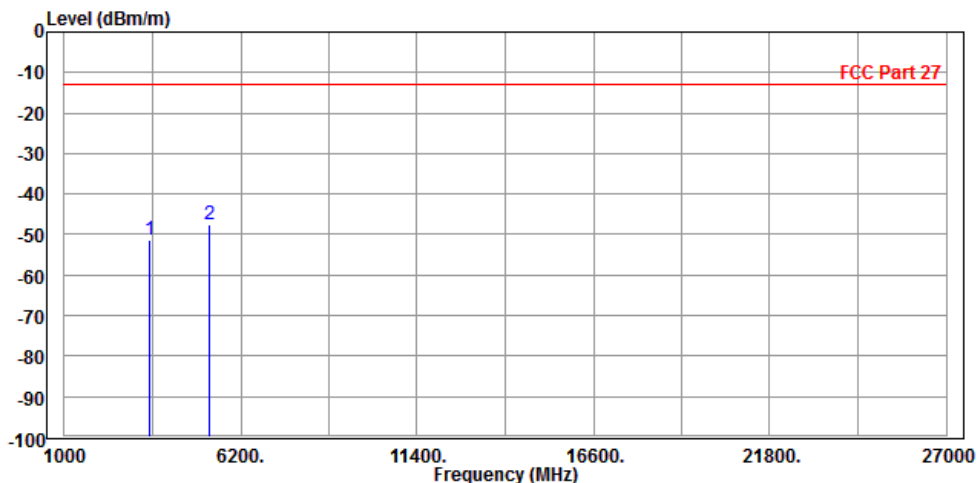



Test Report No.: RF170906W001-5

MODE	TX channel 20375	FREQUENCY RANGE	Above 1000MHz
ENVIRONMENTAL CONDITIONS	23deg. C, 70%RH	INPUT POWER	DC 24V from adapter
TESTED BY	Simon Yang		
ANTENNA POLARITY & TEST DISTANCE: VERTICAL AT 3 M			

	Freq	Level	Read Level	Limit Line	Over Limit	Factor	Remark	Pol/Phase
	MHz	dBm/m	dBm	dBm/m	dB	dB/m		
1	3496.000	-53.69	-56.25	-13.00	-40.69	2.56	Peak	Vertical
2 PP	5257.500	-48.42	-56.40	-13.00	-35.42	7.98	Peak	Vertical

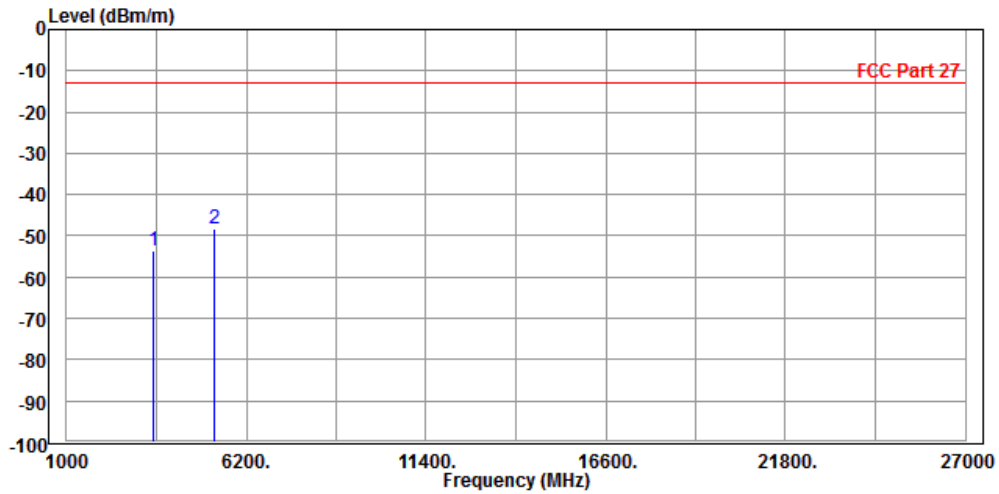



Test Report No.: RF170906W001-5

CHANNEL BANDWIDTH: 10MHz / QPSK

MODE	TX channel 20175	FREQUENCY RANGE	Above 1000MHz
ENVIRONMENTAL CONDITIONS	23deg. C, 70%RH	INPUT POWER	DC 24V from adapter
TESTED BY	Simon Yang		
ANTENNA POLARITY & TEST DISTANCE: HORIZONTAL AT 3 M			

	Freq	Level	Read Level	Limit Line	Over Limit	Factor	Remark	Pol/Phase
	MHz	dBm/m	dBm	dBm/m	dB	dB/m		
1	3470.000	-55.21	-57.26	-13.00	-42.21	2.05	Peak	Horizontal
2	5197.000	-46.99	-55.60	-13.00	-33.99	8.61	Peak	Horizontal

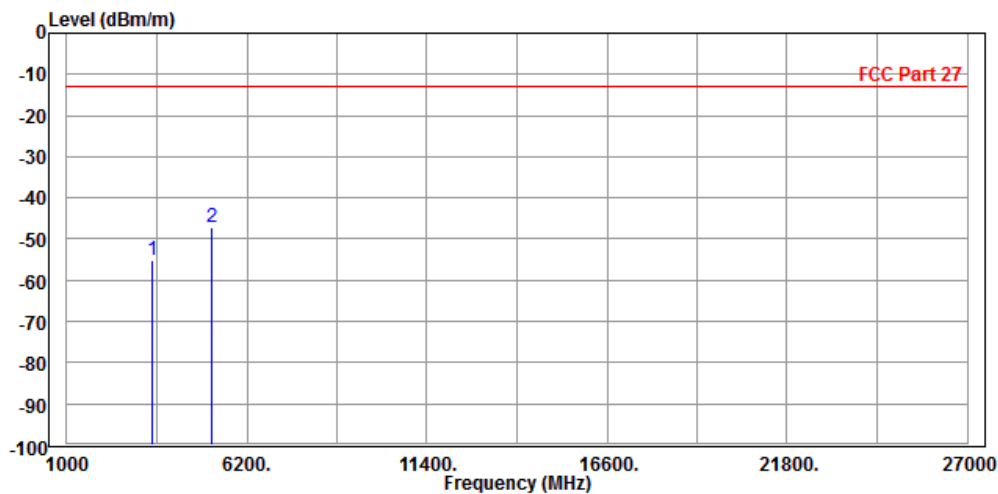



Test Report No.: RF170906W001-5

MODE	TX channel 20175	FREQUENCY RANGE	Above 1000MHz
ENVIRONMENTAL CONDITIONS	23deg. C, 70%RH	INPUT POWER	DC 24V from adapter
TESTED BY	Simon Yang		
ANTENNA POLARITY & TEST DISTANCE: VERTICAL AT 3 M			

	Freq	Level	Read Level	Limit Line	Over Limit	Factor	Remark	Pol/Phase
	MHz	dBm/m	dBm	dBm/m	dB	dB/m		
1	3470.000	-55.08	-57.61	-13.00	-42.08	2.53	Peak	Vertical
2 PP	5197.000	-47.42	-55.40	-13.00	-34.42	7.98	Peak	Vertical

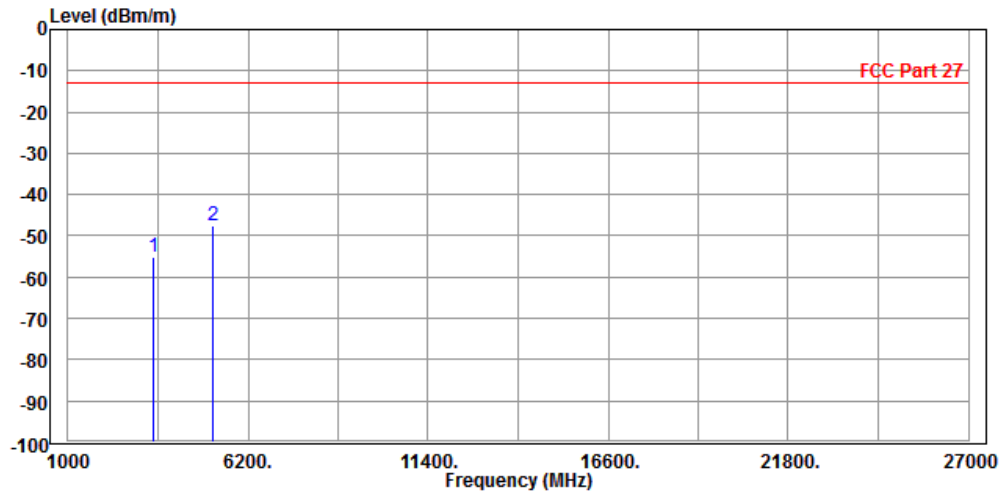



Test Report No.: RF170906W001-5

CHANNEL BANDWIDTH: 15MHz / QPSK

MODE	TX channel 20175	FREQUENCY RANGE	Above 1000MHz
ENVIRONMENTAL CONDITIONS	23deg. C, 70%RH	INPUT POWER	DC 24V from adapter
TESTED BY	Simon Yang		
ANTENNA POLARITY & TEST DISTANCE: HORIZONTAL AT 3 M			

	Freq	Level	Read Level	Limit Line	Over Limit	Factor	Remark	Pol/Phase
	MHz	dBm/m	dBm	dBm/m	dB	dB/m		
1	3470.000	-54.65	-56.70	-13.00	-41.65	2.05	Peak	Horizontal
2 PP	5197.000	-47.56	-56.17	-13.00	-34.56	8.61	Peak	Horizontal

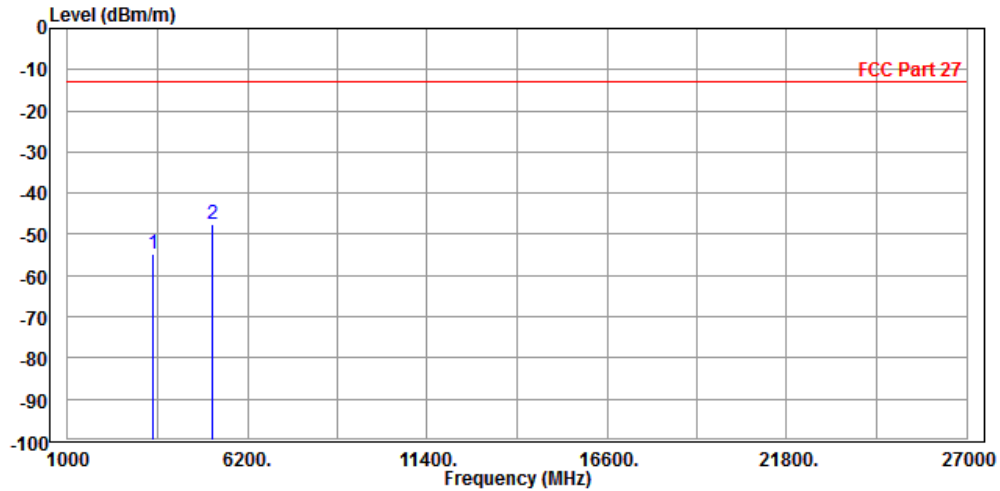



Test Report No.: RF170906W001-5

MODE	TX channel 20175	FREQUENCY RANGE	Above 1000MHz
ENVIRONMENTAL CONDITIONS	23deg. C, 70%RH	INPUT POWER	DC 24V from adapter
TESTED BY	Simon Yang		
ANTENNA POLARITY & TEST DISTANCE: VERTICAL AT 3 M			

	Freq	Level	Read Level	Limit Line	Over Limit	Factor	Remark	Pol/Phase
	MHz	dBm/m	dBm	dBm/m	dB	dB/m		
1	3470.000	-55.15	-57.68	-13.00	-42.15	2.53	Peak	Vertical
2 PP	5197.000	-47.92	-55.90	-13.00	-34.92	7.98	Peak	Vertical

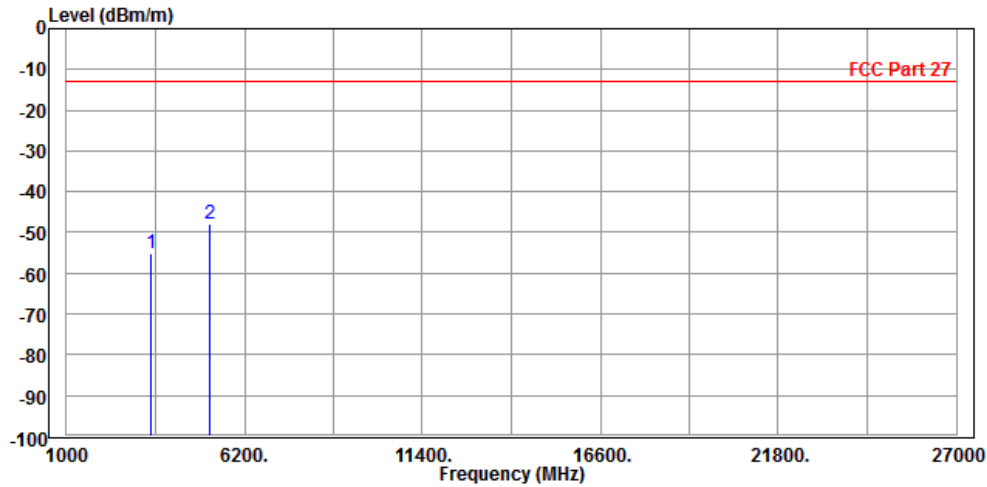



Test Report No.: RF170906W001-5

CHANNEL BANDWIDTH: 20MHz / QPSK

MODE	TX channel 20175	FREQUENCY RANGE	Above 1000MHz
ENVIRONMENTAL CONDITIONS	23deg. C, 70%RH	INPUT POWER	DC 24V from adapter
TESTED BY	Simon Yang		
ANTENNA POLARITY & TEST DISTANCE: HORIZONTAL AT 3 M			

	Freq	Level	Read Level	Limit Line	Over Limit	Factor	Remark	Pol/Phase
	MHz	dBm/m	dBm	dBm/m	dB	dB/m		
1	3470.000	-55.30	-57.35	-13.00	-42.30	2.05	Peak	Horizontal
2	PP 5197.000	-47.70	-56.31	-13.00	-34.70	8.61	Peak	Horizontal

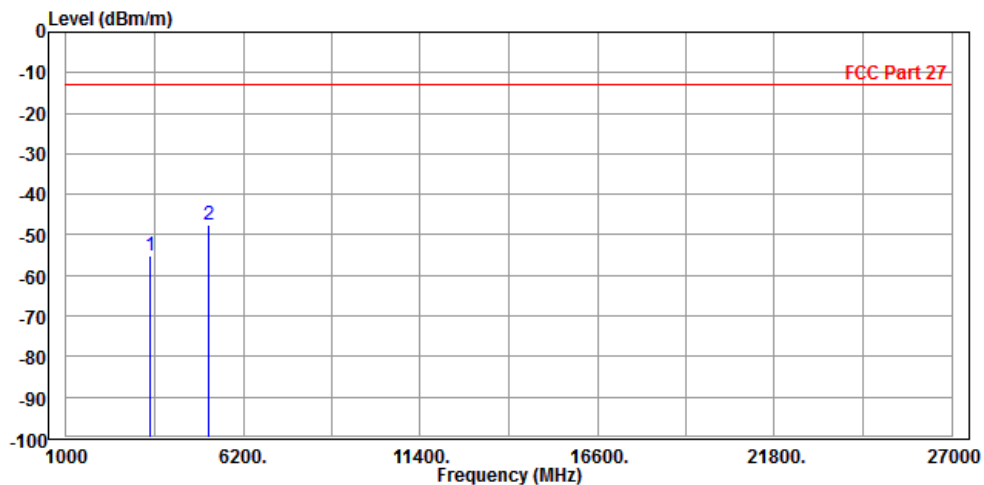



Test Report No.: RF170906W001-5

MODE	TX channel 20175	FREQUENCY RANGE	Above 1000MHz
ENVIRONMENTAL CONDITIONS	23deg. C, 70%RH	INPUT POWER	DC 24V from adapter
TESTED BY	Simon Yang		
ANTENNA POLARITY & TEST DISTANCE: VERTICAL AT 3 M			

	Freq	Level	Read Level	Limit Line	Over Limit	Factor	Remark	Pol/Phase
	MHz	dBm/m	dBm	dBm/m	dB	dB/m		
1	3470.000	-54.49	-57.02	-13.00	-41.49	2.53	Peak	Vertical
2 PP	5197.000	-48.32	-56.30	-13.00	-35.32	7.98	Peak	Vertical

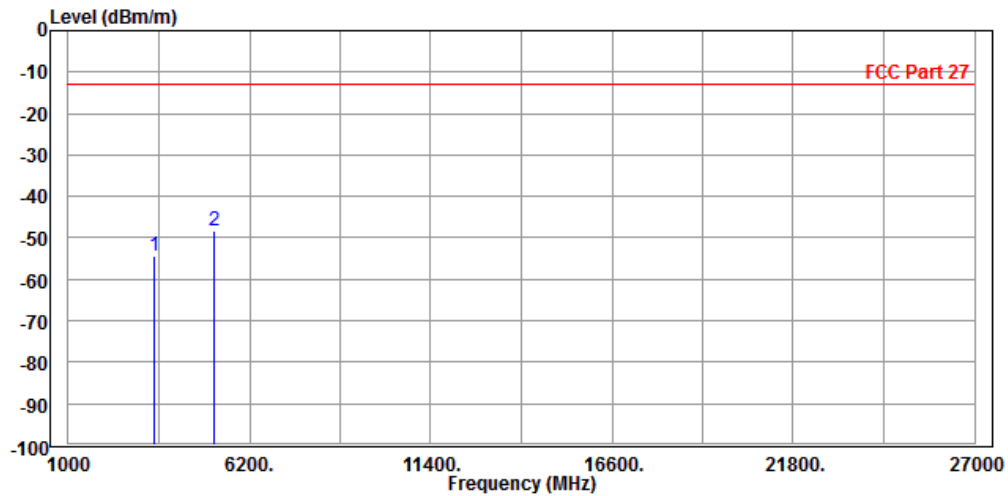



Test Report No.: RF170906W001-5

LTE BAND 12

CHANNEL BANDWIDTH: 1.4MHz / QPSK

MODE	TX channel 23095	FREQUENCY RANGE	Above 1000MHz
ENVIRONMENTAL CONDITIONS	23deg. C, 70%RH	INPUT POWER	DC 24V from adapter
TESTED BY	Simon Yang		
ANTENNA POLARITY & TEST DISTANCE: HORIZONTAL AT 3 M			

	Freq	Level	Read Level	Limit Line	Over Limit	Factor	Remark	Pol/Phase
	MHz	dBm/m	dBm	dBm/m	dB	dB/m		
1	PP 1416.000	-54.81	-48.09	-13.00	-41.81	-6.72	Peak	Horizontal
2	2122.000	-59.33	-57.39	-13.00	-46.33	-1.94	Peak	Horizontal

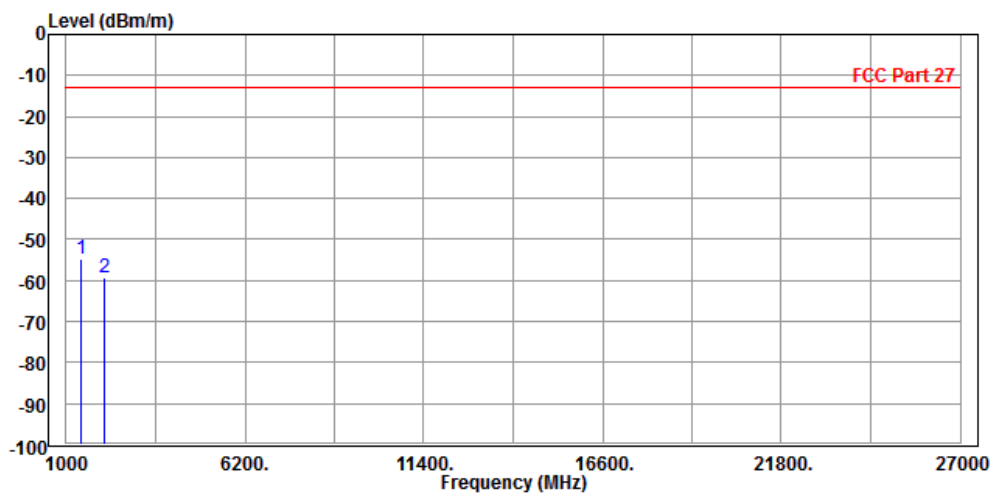



Test Report No.: RF170906W001-5

MODE	TX channel 23095	FREQUENCY RANGE	Above 1000MHz
ENVIRONMENTAL CONDITIONS	23deg. C, 70%RH	INPUT POWER	DC 24V from adapter
TESTED BY	Simon Yang		
ANTENNA POLARITY & TEST DISTANCE: VERTICAL AT 3 M			

	Freq	Level	Read Level	Limit Line	Over Limit	Factor	Remark	Pol/Phase
	MHz	dBm/m	dBm	dBm/m	dB	dB/m		
1	PP 1416.000	-53.94	-48.50	-13.00	-40.94	-5.44	Peak	Vertical
2	2122.000	-57.49	-57.25	-13.00	-44.49	-0.24	Peak	Vertical

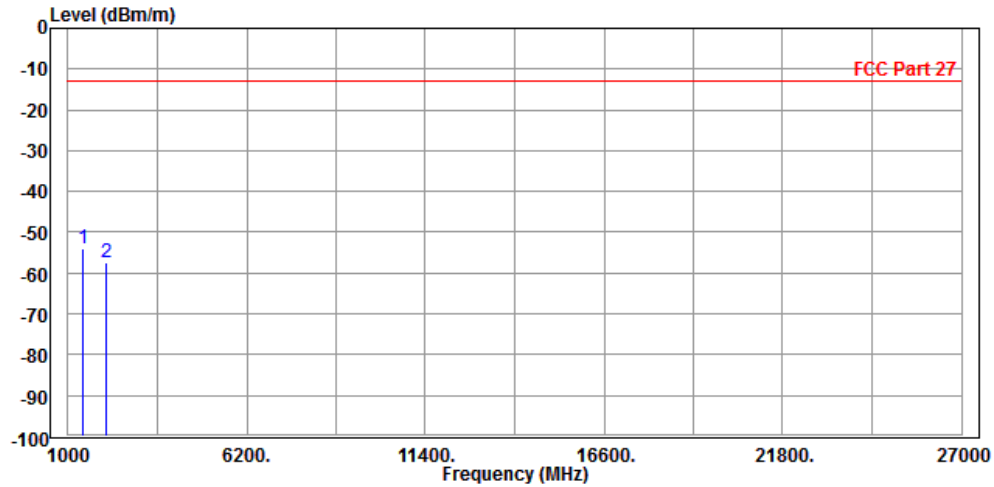



Test Report No.: RF170906W001-5

CHANNEL BANDWIDTH: 3MHz / QPSK

CH 23025

MODE	TX channel 23025	FREQUENCY RANGE	Above 1000MHz
ENVIRONMENTAL CONDITIONS	23deg. C, 70%RH	INPUT POWER	DC 24V from adapter
TESTED BY	Simon Yang		
ANTENNA POLARITY & TEST DISTANCE: HORIZONTAL AT 3 M			

	Freq	Level	Read Level	Limit Line	Over Limit	Factor	Remark	Pol/Phase
	MHz	dBm/m	dBm	dBm/m	dB	dB/m		
1	PP 1390.000	-43.67	-36.79	-13.00	-30.67	-6.88	Peak	Horizontal
2	2101.500	-58.27	-56.32	-13.00	-45.27	-1.95	Peak	Horizontal

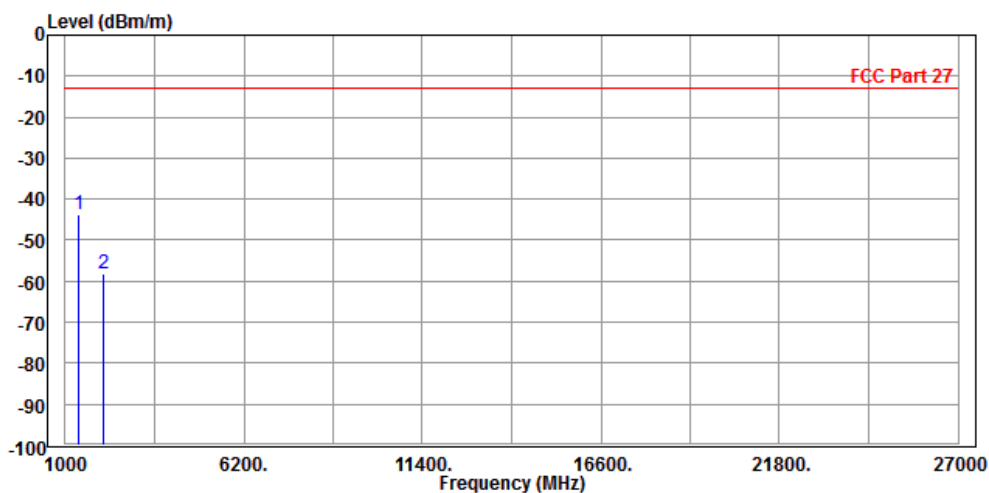



Test Report No.: RF170906W001-5

MODE	TX channel 23025	FREQUENCY RANGE	Above 1000MHz
ENVIRONMENTAL CONDITIONS	23deg. C, 70%RH	INPUT POWER	DC 24V from adapter
TESTED BY	Simon Yang		
ANTENNA POLARITY & TEST DISTANCE: VERTICAL AT 3 M			

	Freq	Level	Read Level	Limit Line	Over Limit	Factor	Remark	Pol/Phase
	MHz	dBm/m	dBm	dBm/m	dB	dB/m		
1	PP 1390.000	-54.01	-48.41	-13.00	-41.01	-5.60	Peak	Vertical
2	2101.500	-54.33	-54.08	-13.00	-41.33	-0.25	Peak	Vertical

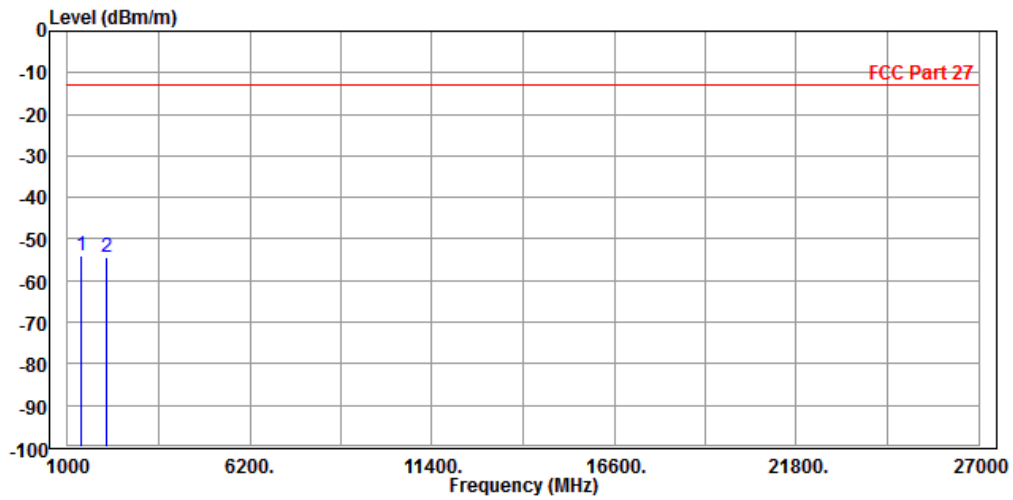



Test Report No.: RF170906W001-5

CH 23095

MODE	TX channel 23095	FREQUENCY RANGE	Above 1000MHz
ENVIRONMENTAL CONDITIONS	23deg. C, 70%RH	INPUT POWER	DC 24V from adapter
TESTED BY	Simon Yang		
ANTENNA POLARITY & TEST DISTANCE: HORIZONTAL AT 3 M			

	Freq	Level	Read Level	Limit Line	Over Limit	Factor	Remark	Pol/Phase
	MHz	dBm/m	dBm	dBm/m	dB	dB/m		
1	PP 1416.000	-47.73	-41.01	-13.00	-34.73	-6.72	Peak	Horizontal
2	2122.000	-58.38	-56.44	-13.00	-45.38	-1.94	Peak	Horizontal

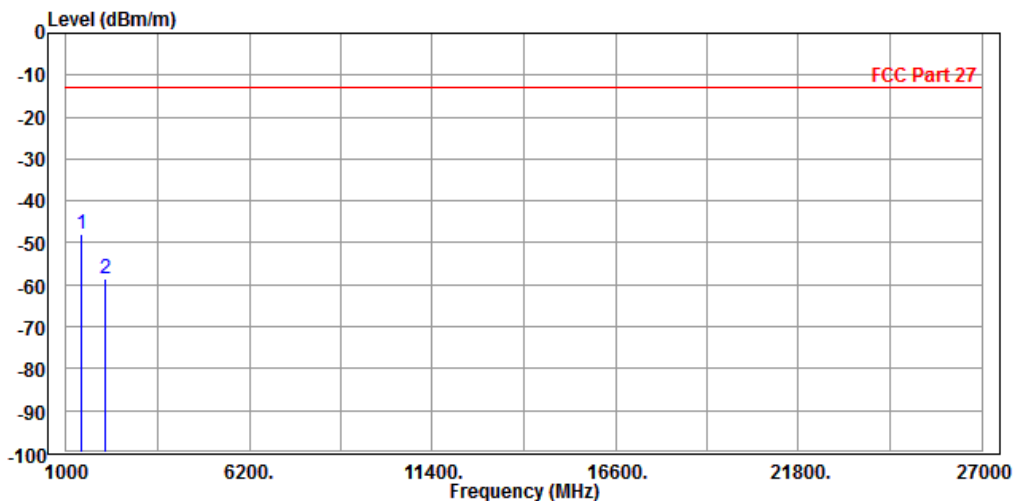



Test Report No.: RF170906W001-5

MODE	TX channel 23095	FREQUENCY RANGE	Above 1000MHz
ENVIRONMENTAL CONDITIONS	23deg. C, 70%RH	INPUT POWER	DC 24V from adapter
TESTED BY	Simon Yang		
ANTENNA POLARITY & TEST DISTANCE: VERTICAL AT 3 M			

	Freq	Level	Read Level	Limit Line	Over Limit	Factor	Remark	Pol/Phase
	MHz	dBm/m	dBm	dBm/m	dB	dB/m		
1	PP 1416.000	-48.68	-43.24	-13.00	-35.68	-5.44	Peak	Vertical
2	2122.000	-56.76	-56.52	-13.00	-43.76	-0.24	Peak	Vertical

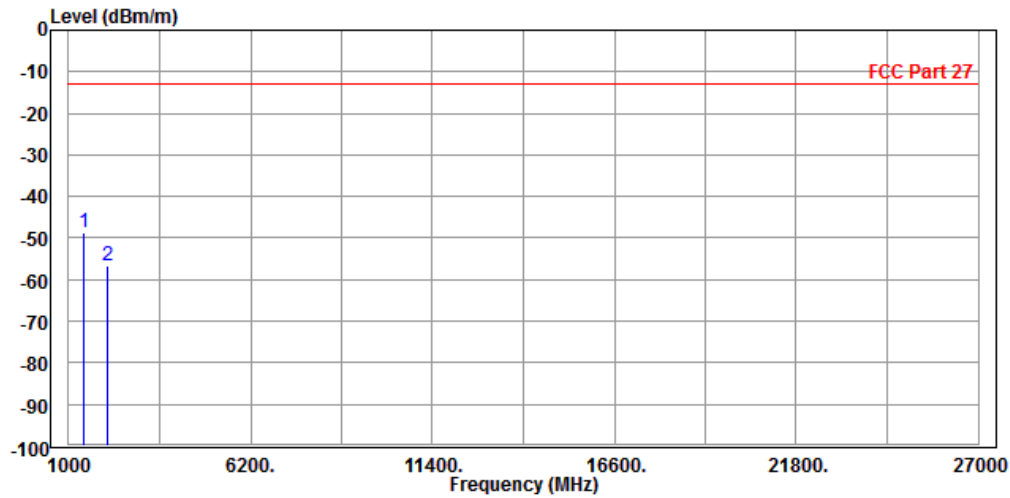



Test Report No.: RF170906W001-5

CH 23165

MODE	TX channel 23165	FREQUENCY RANGE	Above 1000MHz
ENVIRONMENTAL CONDITIONS	23deg. C, 70%RH	INPUT POWER	DC 24V from adapter
TESTED BY	Simon Yang		
ANTENNA POLARITY & TEST DISTANCE: HORIZONTAL AT 3 M			

	Freq	Level	Read Level	Limit Line	Over Limit	Factor	Remark	Pol/Phase
	MHz	dBm/m	dBm	dBm/m	dB	dB/m		
1	PP 1416.000	-49.55	-42.83	-13.00	-36.55	-6.72	Peak	Horizontal
2	2143.500	-58.13	-56.21	-13.00	-45.13	-1.92	Peak	Horizontal

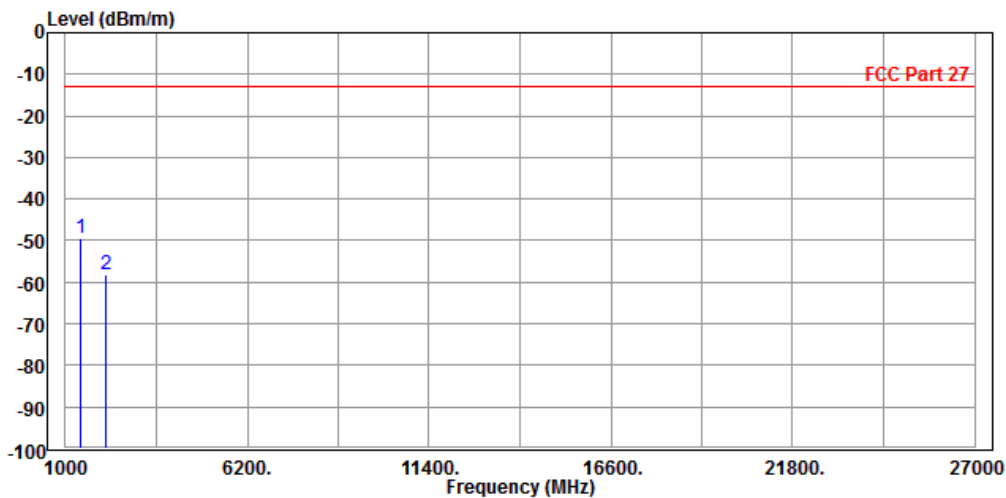



Test Report No.: RF170906W001-5

MODE	TX channel 23165	FREQUENCY RANGE	Above 1000MHz
ENVIRONMENTAL CONDITIONS	23deg. C, 70%RH	INPUT POWER	DC 24V from adapter
TESTED BY	Simon Yang		
ANTENNA POLARITY & TEST DISTANCE: VERTICAL AT 3 M			

	Freq	Level	Read Level	Limit Line	Over Limit	Factor	Remark	Pol/Phase
	MHz	dBm/m	dBm	dBm/m	dB	dB/m		
1	PP 1416.000	-49.89	-44.45	-13.00	-36.89	-5.44	Peak	Vertical
2	2143.500	-56.52	-56.28	-13.00	-43.52	-0.24	Peak	Vertical

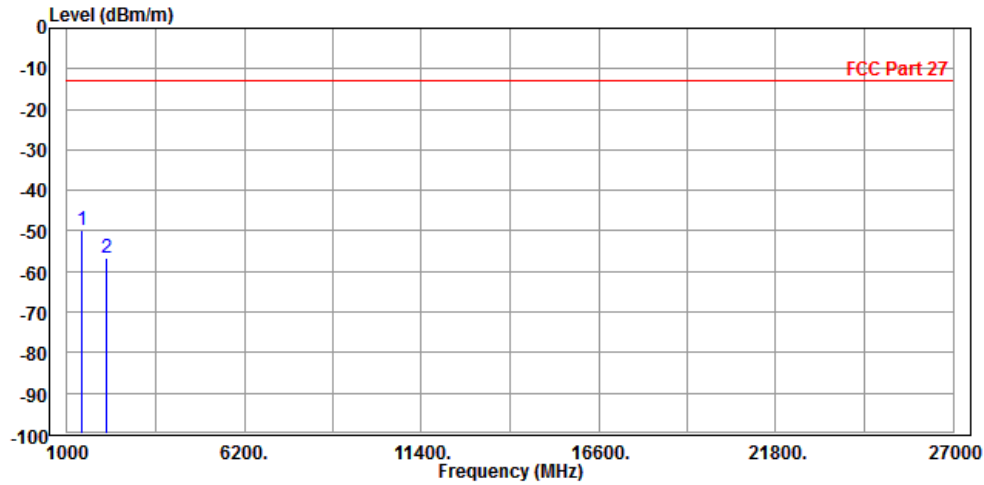



Test Report No.: RF170906W001-5

CHANNEL BANDWIDTH: 5MHz / QPSK

MODE	TX channel 23095	FREQUENCY RANGE	Above 1000MHz
ENVIRONMENTAL CONDITIONS	23deg. C, 70%RH	INPUT POWER	DC 24V from adapter
TESTED BY	Simon Yang		
ANTENNA POLARITY & TEST DISTANCE: HORIZONTAL AT 3 M			

	Freq	Level	Read Level	Limit Line	Over Limit	Factor	Remark	Pol/Phase
	MHz	dBm/m	dBm	dBm/m	dB	dB/m		
1	PP 1416.000	-49.50	-42.78	-13.00	-36.50	-6.72	Peak	Horizontal
2	2122.000	-57.75	-55.81	-13.00	-44.75	-1.94	Peak	Horizontal

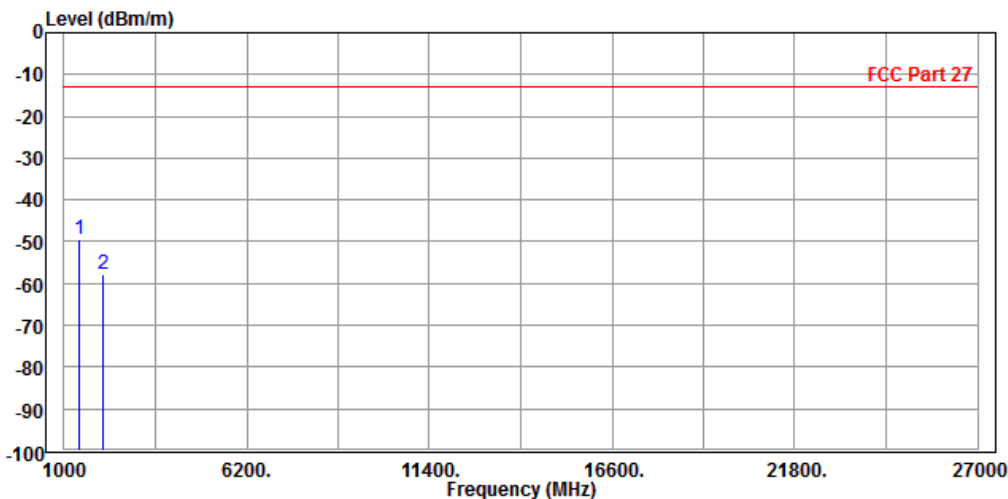



Test Report No.: RF170906W001-5

MODE	TX channel 23095	FREQUENCY RANGE	Above 1000MHz
ENVIRONMENTAL CONDITIONS	23deg. C, 70%RH	INPUT POWER	DC 24V from adapter
TESTED BY	Simon Yang		
ANTENNA POLARITY & TEST DISTANCE: VERTICAL AT 3 M			

	Freq	Level	Read Level	Limit Line	Over Limit	Factor	Remark	Pol/Phase
	MHz	dBm/m	dBm	dBm/m	dB	dB/m		
1	PP 1416.000	-49.37	-43.93	-13.00	-36.37	-5.44	Peak	Vertical
2	2122.000	-55.49	-55.25	-13.00	-42.49	-0.24	Peak	Vertical

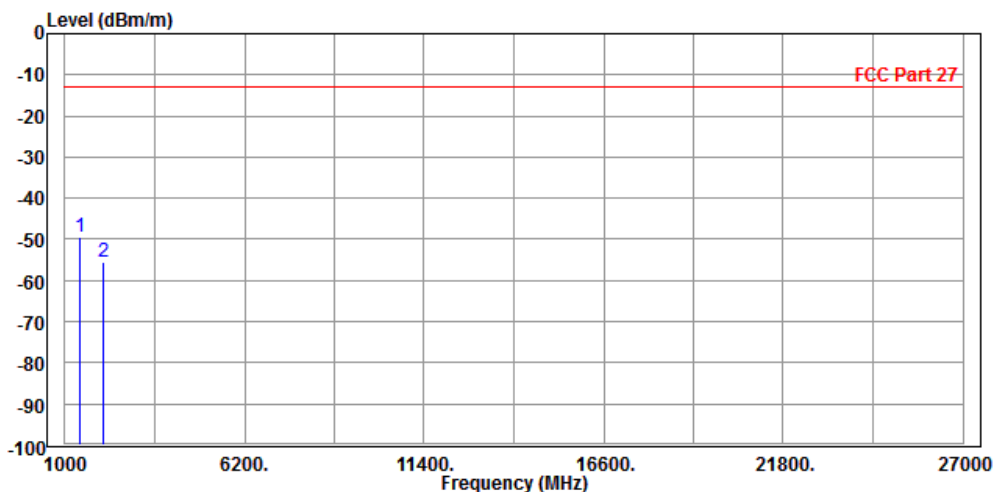



Test Report No.: RF170906W001-5

CHANNEL BANDWIDTH: 10MHz / QPSK

MODE	TX channel 23095	FREQUENCY RANGE	Above 1000MHz
ENVIRONMENTAL CONDITIONS	23deg. C, 70%RH	INPUT POWER	DC 24V from adapter
TESTED BY	Simon Yang		
ANTENNA POLARITY & TEST DISTANCE: HORIZONTAL AT 3 M			

	Freq	Level	Read Level	Limit Line	Over Limit	Factor	Remark	Pol/Phase
	MHz	dBm/m	dBm	dBm/m	dB	dB/m		
1	PP 1416.000	-53.69	-46.97	-13.00	-40.69	-6.72	Peak	Horizontal
2	2122.000	-59.12	-57.18	-13.00	-46.12	-1.94	Peak	Horizontal

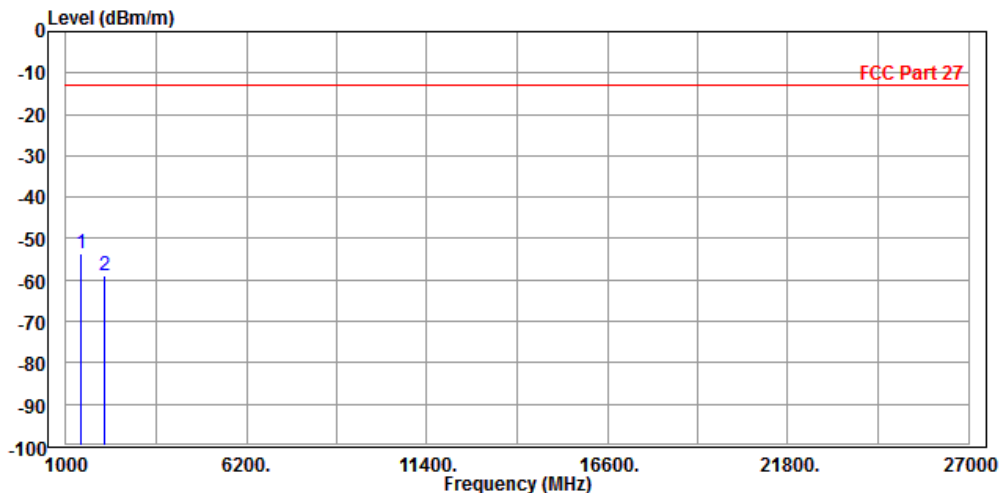



Test Report No.: RF170906W001-5

MODE	TX channel 23095	FREQUENCY RANGE	Above 1000MHz
ENVIRONMENTAL CONDITIONS	23deg. C, 70%RH	INPUT POWER	DC 24V from adapter
TESTED BY	Simon Yang		
ANTENNA POLARITY & TEST DISTANCE: VERTICAL AT 3 M			

	Freq	Level	Read Level	Limit Line	Over Limit	Factor	Remark	Pol/Phase
	MHz	dBm/m	dBm	dBm/m	dB	dB/m		
1	1416.000	-58.39	-52.95	-13.00	-45.39	-5.44	Peak	Vertical
2 PP	2122.000	-57.91	-57.67	-13.00	-44.91	-0.24	Peak	Vertical

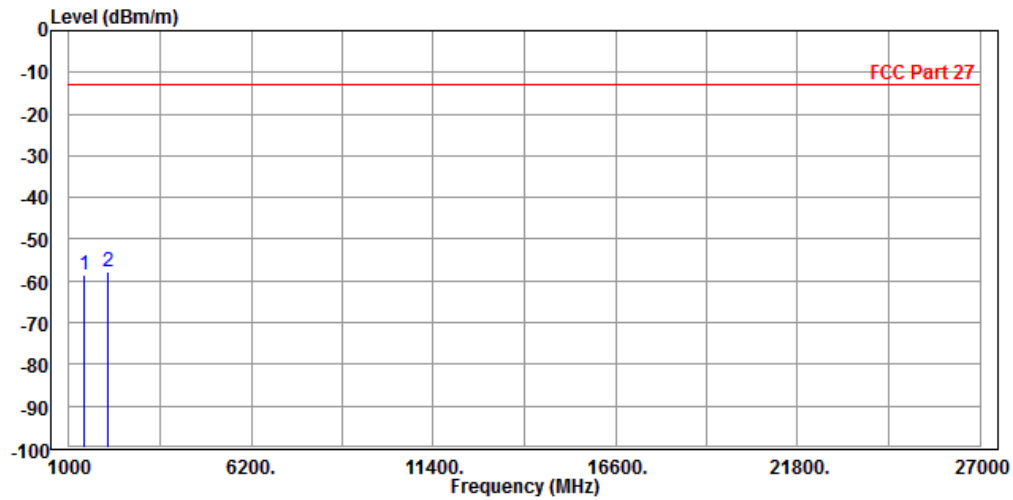



Test Report No.: RF170906W001-5

LTE Band 17

CHANNEL BANDWIDTH: 5MHz / QPSK

CH23755

MODE	TX channel 23755	FREQUENCY RANGE	Above 1000MHz
ENVIRONMENTAL CONDITIONS	23deg. C, 70%RH	INPUT POWER	DC 24V from adapter
TESTED BY	Simon Yang		
ANTENNA POLARITY & TEST DISTANCE: HORIZONTAL AT 3 M			

	Freq	Level	Read Level	Limit Line	Over Limit	Factor	Remark	Pol/Phase
	MHz	dBm/m	dBm	dBm/m	dB	dB/m		
1	PP 1416.000	-50.89	-44.17	-13.00	-37.89	-6.72	Peak	Horizontal
2	2119.000	-58.36	-56.42	-13.00	-45.36	-1.94	Peak	Horizontal

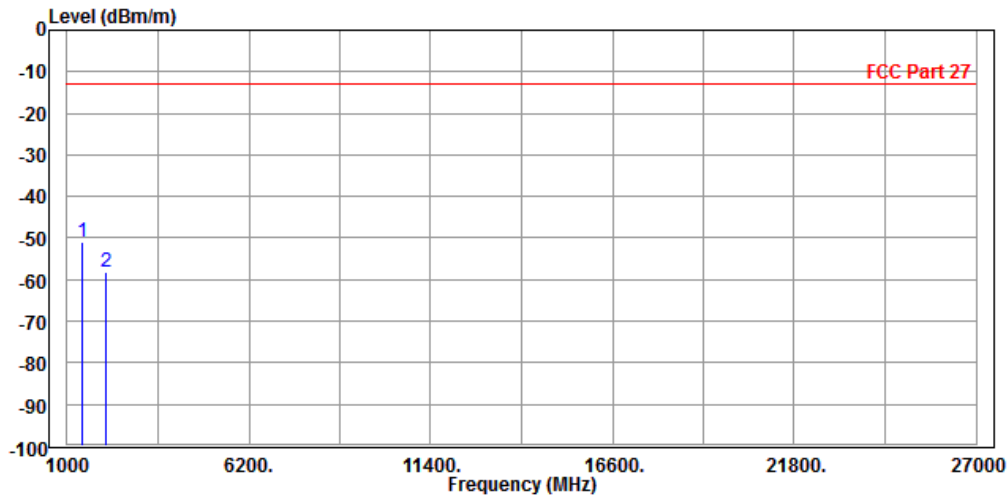



Test Report No.: RF170906W001-5

MODE	TX channel 23755	FREQUENCY RANGE	Above 1000MHz
ENVIRONMENTAL CONDITIONS	23deg. C, 70%RH	INPUT POWER	DC 24V from adapter
TESTED BY	Simon Yang		
ANTENNA POLARITY & TEST DISTANCE: VERTICAL AT 3 M			

	Freq	Level	Read Level	Limit Line	Over Limit	Factor	Remark	Pol/Phase
	MHz	dBm/m	dBm	dBm/m	dB	dB/m		
1	PP 1416.000	-50.19	-44.75	-13.00	-37.19	-5.44	Peak	Vertical
2	2119.000	-56.70	-56.46	-13.00	-43.70	-0.24	Peak	Vertical

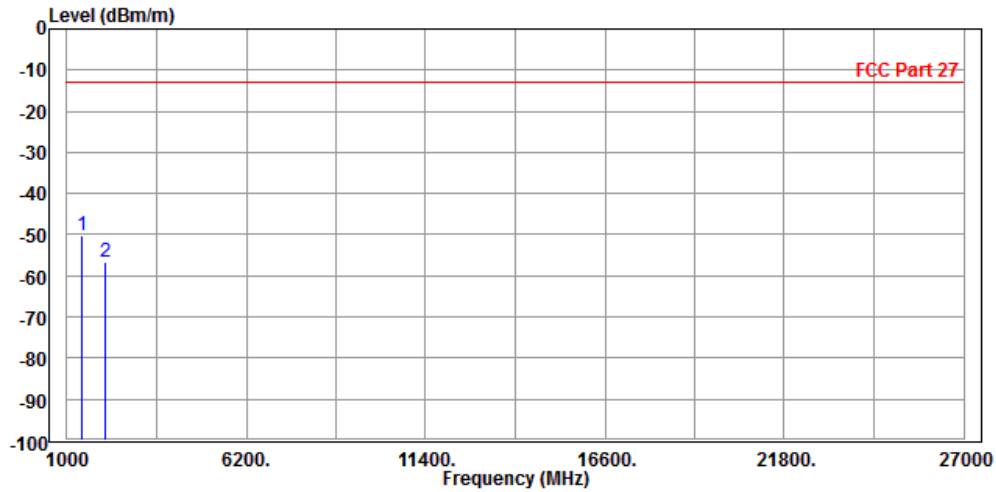



Test Report No.: RF170906W001-5

CH23790

MODE	TX channel 23790	FREQUENCY RANGE	Above 1000MHz
ENVIRONMENTAL CONDITIONS	23deg. C, 70%RH	INPUT POWER	DC 24V from adapter
TESTED BY	Simon Yang		
ANTENNA POLARITY & TEST DISTANCE: HORIZONTAL AT 3 M			

	Freq	Level	Read Level	Limit Line	Over Limit	Factor	Remark	Pol/Phase
	MHz	dBm/m	dBm	dBm/m	dB	dB/m		
1	PP 1416.000	-43.13	-36.41	-13.00	-30.13	-6.72	Peak	Horizontal
2	2130.000	-57.93	-56.00	-13.00	-44.93	-1.93	Peak	Horizontal

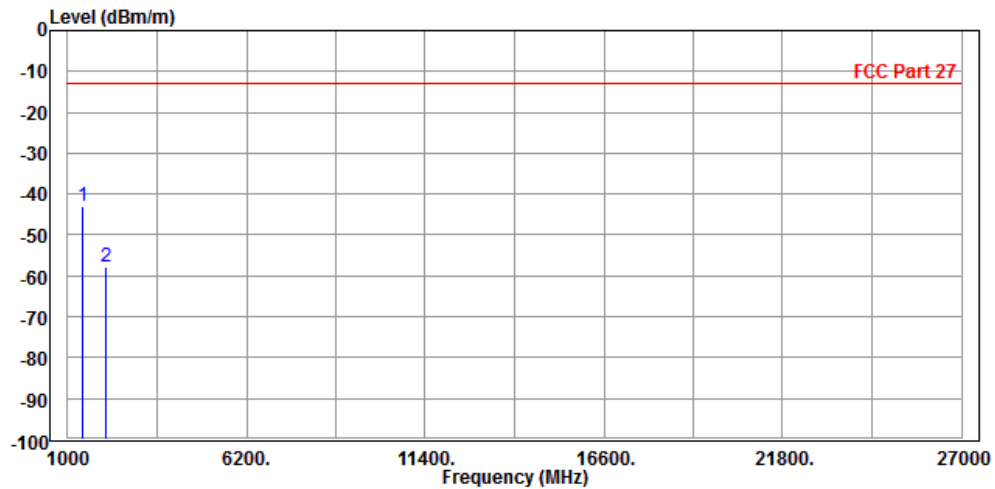



Test Report No.: RF170906W001-5

MODE	TX channel 23790	FREQUENCY RANGE	Above 1000MHz
ENVIRONMENTAL CONDITIONS	23deg. C, 70%RH	INPUT POWER	DC 24V from adapter
TESTED BY	Simon Yang		
ANTENNA POLARITY & TEST DISTANCE: VERTICAL AT 3 M			

	Freq	Level	Read Level	Limit Line	Over Limit	Factor	Remark	Pol/Phase
	MHz	dBm/m	dBm	dBm/m	dB	dB/m		
1	PP 1416.000	-49.32	-43.88	-13.00	-36.32	-5.44	Peak	Vertical
2	2130.000	-57.42	-57.18	-13.00	-44.42	-0.24	Peak	Vertical

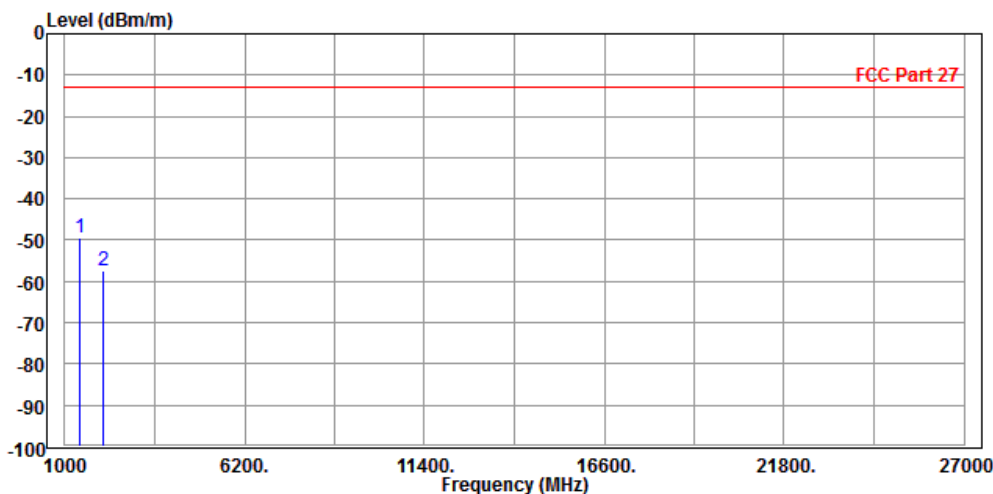



Test Report No.: RF170906W001-5

CH23825

MODE	TX channel 23825	FREQUENCY RANGE	Above 1000MHz
ENVIRONMENTAL CONDITIONS	23deg. C, 70%RH	INPUT POWER	DC 24V from adapter
TESTED BY	Simon Yang		
ANTENNA POLARITY & TEST DISTANCE: HORIZONTAL AT 3 M			

	Freq	Level	Read Level	Limit Line	Over Limit	Factor	Remark	Pol/Phase
	MHz	dBm/m	dBm	dBm/m	dB	dB/m		
1	PP 1416.000	-51.62	-44.90	-13.00	-38.62	-6.72	Peak	Horizontal
2	2140.000	-58.00	-56.08	-13.00	-45.00	-1.92	Peak	Horizontal

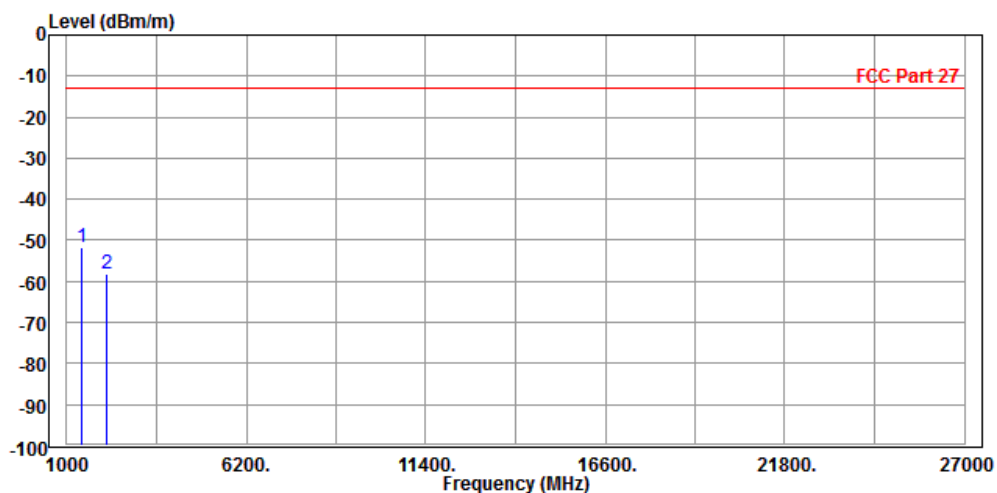



Test Report No.: RF170906W001-5

MODE	TX channel 23825	FREQUENCY RANGE	Above 1000MHz
ENVIRONMENTAL CONDITIONS	23deg. C, 70%RH	INPUT POWER	DC 24V from adapter
TESTED BY	Simon Yang		
ANTENNA POLARITY & TEST DISTANCE: VERTICAL AT 3 M			

	Freq	Level	Read Level	Limit Line	Over Limit	Factor	Remark	Pol/Phase
	MHz	dBm/m	dBm	dBm/m	dB	dB/m		
1	PP 1416.000	-51.37	-45.93	-13.00	-38.37	-5.44	Peak	Vertical
2	2140.000	-56.59	-56.35	-13.00	-43.59	-0.24	Peak	Vertical

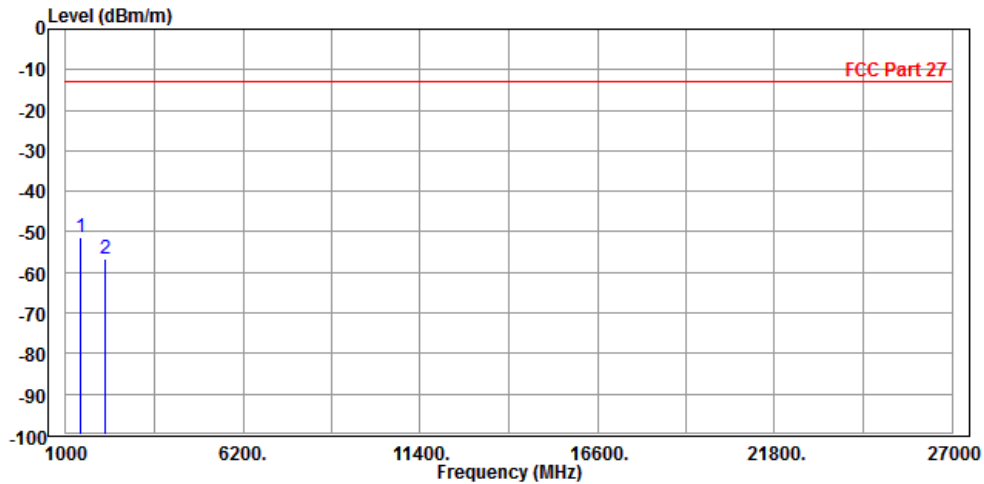



Test Report No.: RF170906W001-5

CHANNEL BANDWIDTH: 10MHz / QPSK

MODE	TX channel 23790	FREQUENCY RANGE	Above 1000MHz
ENVIRONMENTAL CONDITIONS	23deg. C, 70%RH	INPUT POWER	DC 24V from adapter
TESTED BY	Simon Yang		
ANTENNA POLARITY & TEST DISTANCE: HORIZONTAL AT 3 M			

	Freq	Level	Read Level	Limit Line	Over Limit	Factor	Remark	Pol/Phase
	MHz	dBm/m	dBm	dBm/m	dB	dB/m		
1	PP 1416.000	-49.09	-42.37	-13.00	-36.09	-6.72	Peak	Horizontal
2	2130.000	-59.29	-57.36	-13.00	-46.29	-1.93	Peak	Horizontal

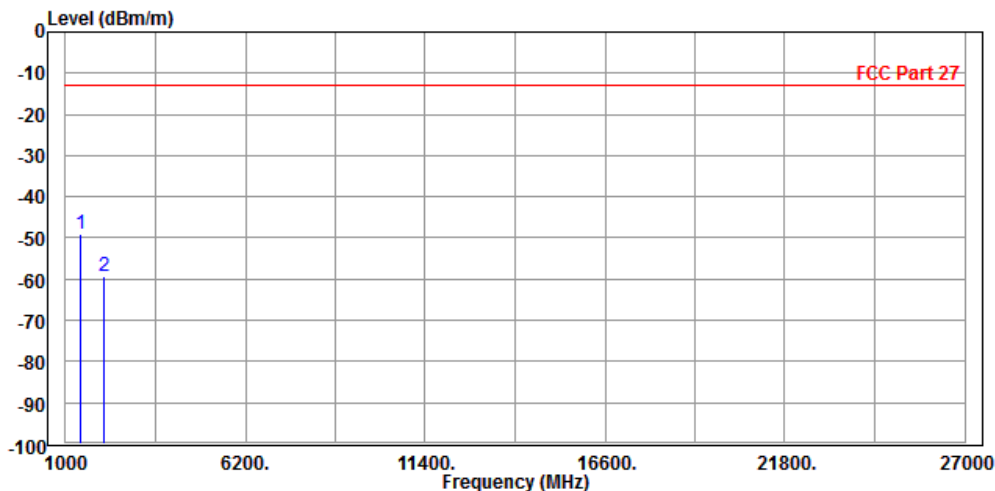



Test Report No.: RF170906W001-5

MODE	TX channel 23790	FREQUENCY RANGE	Above 1000MHz
ENVIRONMENTAL CONDITIONS	23deg. C, 70%RH	INPUT POWER	DC 24V from adapter
TESTED BY	Simon Yang		
ANTENNA POLARITY & TEST DISTANCE: VERTICAL AT 3 M			

	Freq	Level	Read Level	Limit Line	Over Limit	Factor	Remark	Pol/Phase
	MHz	dBm/m	dBm	dBm/m	dB	dB/m		
1	PP 1416.000	-49.68	-44.24	-13.00	-36.68	-5.44	Peak	Vertical
2	2130.000	-56.53	-56.29	-13.00	-43.53	-0.24	Peak	Vertical

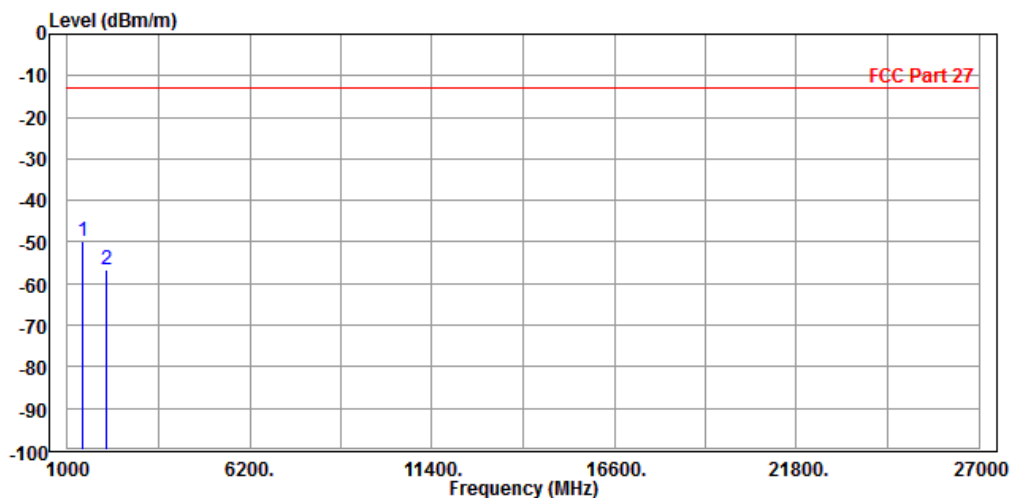



Test Report No.: RF170906W001-5

5 INFORMATION ON THE TESTING LABORATORIES

We, BV 7LAYERS COMMUNICATIONS TECHNOLOGY (SHENZHEN) CO. LTD., were founded in 2015 to provide our best service in EMC, Radio, Telecom and Safety consultation. Our laboratories are accredited and approved according to ISO/IEC 17025.

If you have any comments, please feel free to contact us at the following:

Shenzhen EMC/RF Lab:

Tel: +86-755-88696566

Fax: +86-755-88696577

Email: customerservice.dg@cn.bureauveritas.com

Web Site: www.adt.com.tw

The address and road map of all our labs can be found in our web site also.



Test Report No.: RF170906W001-5

6 APPENDIX A – MODIFICATIONS RECORDERS FOR ENGINEERING CHANGES TO THE EUT BY THE LAB

No modifications were made to the EUT by the lab during the test.

---END---