

**CFR 47 FCC PART 15 SUBPART C
ISED RSS-247 ISSUE 3**

TEST REPORT

For

Mobile Payment Terminal

MODEL NUMBER: D195

REPORT NUMBER: 4791059475-1-RF-3

ISSUE DATE: February 2, 2024

FCC ID: V5PD195

IC: 11689A-D195

Prepared for

PAX Technology Limited

Room 2416, 24/F., Sun Hung Kai Centre, 30 Harbour Road, Wanchai, Hong Kong

Prepared by

UL Verification Services (Guangzhou) Co., Ltd, Song Shan Lake Branch

Building 10, Innovation Technology Park, No. 1, Li Bin Road, Song Shan Lake Hi-Tech Development Zone Dongguan, 523808, People's Republic of China

Tel: +86 769 22038881

Fax: +86 769 33244054

Website: www.ul.com

Revision History

Rev.	Issue Date	Revisions	Revised By
V0	December 5, 2023	Initial Issue	Kebo.Zhang
V1	February 2, 2024	Updated the address of manufacturer	Kebo.Zhang

Summary of Test Results

Test Item	Clause	Limit/Requirement	Result
Antenna Requirement	N/A	FCC Part 15.203/15.247 (c) RSS-GEN Clause 6.8	Pass
AC Power Line Conducted Emission	ANSI C63.10-2013, Clause 6.2	FCC Part 15.207 RSS-GEN Clause 8.8	Pass
Conducted Output Power	ANSI C63.10-2013, Clause 11.9.1.3	FCC Part 15.247 (b)(3) RSS-247 Clause 5.4 (d)	Pass
6dB Bandwidth and 99% Occupied Bandwidth	ANSI C63.10-2013, Clause 11.8.1	FCC Part 15.247 (a)(2) RSS-247 Clause 5.2 (a) ISED RSS-Gen Clause 6.7	Pass
Power Spectral Density	ANSI C63.10-2013, Clause 11.10.2	FCC Part 15.247 (e) RSS-247 Clause 5.2 (b)	Pass
Conducted Band edge and spurious emission	ANSI C63.10-2013, Clause 11.11	FCC Part 15.247(d) RSS-247 Clause 5.5	Pass
Radiated Band edge and Spurious Emission	ANSI C63.10-2013, Clause 11.12 & Clause 11.13	FCC Part 15.247 (d) FCC Part 15.205/15.209 RSS-247 Clause 5.5 RSS-GEN Clause 8.9	Pass
Duty Cycle	ANSI C63.10-2013, Clause 11.6	None; for reporting purposes only.	Pass

*This test report is only published to and used by the applicant, and it is not for evidence purpose in China.

*The measurement result for the sample received is <Pass> according to <CFR 47 FCC PART 15 SUBPART C ISED RSS-247 ISSUE 3> when <Simple Acceptance> decision rule is applied.

CONTENTS

1. ATTESTATION OF TEST RESULTS	6
2. TEST METHODOLOGY	7
3. FACILITIES AND ACCREDITATION	7
4. CALIBRATION AND UNCERTAINTY	8
4.1. <i>MEASURING INSTRUMENT CALIBRATION</i>	8
4.2. <i>MEASUREMENT UNCERTAINTY</i>	8
5. EQUIPMENT UNDER TEST	9
5.1. <i>DESCRIPTION OF EUT</i>	9
5.2. <i>CHANNEL LIST</i>	9
5.3. <i>MAXIMUM POWER</i>	9
5.4. <i>TEST CHANNEL CONFIGURATION</i>	10
5.5. <i>THE WORSE CASE POWER SETTING PARAMETER</i>	10
5.6. <i>THE WORSE CASE CONFIGURATIONS</i>	11
5.7. <i>DESCRIPTION OF AVAILABLE ANTENNAS</i>	12
5.8. <i>SUPPORT UNITS FOR SYSTEM TEST</i>	13
6. MEASURING EQUIPMENT AND SOFTWARE USED	14
7. ANTENNA PORT TEST RESULTS	17
7.1. <i>CONDUCTED OUTPUT POWER</i>	17
7.2. <i>6DB BANDWIDTH AND 99% OCCUPIED BANDWIDTH</i>	18
7.3. <i>POWER SPECTRAL DENSITY</i>	20
7.4. <i>CONDUCTED BAND EDGE AND SPURIOUS EMISSION</i>	22
7.5. <i>DUTY CYCLE</i>	24
8. RADIATED TEST RESULTS	25
8.1. <i>RESTRICTED BANDEDGE</i>	33
8.2. <i>SPURIOUS EMISSIONS(1 GHZ~3 GHZ)</i>	50
8.3. <i>SPURIOUS EMISSIONS(3 GHZ~18 GHZ)</i>	56
8.4. <i>SPURIOUS EMISSIONS(9 KHZ~30 MHZ)</i>	80
8.5. <i>SPURIOUS EMISSIONS(18 GHZ~26 GHZ)</i>	83
8.6. <i>SPURIOUS EMISSIONS(30 MHZ~1 GHZ)</i>	85
9. ANTENNA REQUIREMENT	87
10. AC POWER LINE CONDUCTED EMISSION	88
11. TEST DATA	91
11.1. <i>APPENDIX A: DTS BANDWIDTH</i>	91

11.1.1.	Test Result	91
11.1.2.	Test Graphs	92
11.2.	<i>APPENDIX B: OCCUPIED CHANNEL BANDWIDTH</i>	96
11.2.1.	Test Result	96
11.2.2.	Test Graphs	97
11.3.	<i>APPENDIX C: MAXIMUM CONDUCTED OUTPUT POWER</i>	101
11.3.1.	Test Result	101
11.4.	<i>APPENDIX D: MAXIMUM POWER SPECTRAL DENSITY</i>	102
11.4.1.	Test Result	102
11.4.2.	Test Graphs	103
11.5.	<i>APPENDIX E: BAND EDGE MEASUREMENTS</i>	107
11.5.1.	Test Result	107
11.5.2.	Test Graphs	108
11.6.	<i>APPENDIX F: CONDUCTED SPURIOUS EMISSION</i>	111
11.6.1.	Test Result	111
11.6.2.	Test Graphs	112
11.7.	<i>APPENDIX G: DUTY CYCLE</i>	123
11.7.1.	Test Result	123
11.7.2.	Test Graphs	124

1. ATTESTATION OF TEST RESULTS

Applicant Information

Company Name: PAX Technology Limited
 Address: Room 2416, 24/F., Sun Hung Kai Centre, 30 Harbour Road, Wanchai, Hong Kong

Manufacturer Information

Company Name: PAX Computer Technology (Shenzhen) Co., Ltd.
 Address: Room 701, PAX Technology Building, Shanxia Community, Pinghu Sub-district, Longgang District, Shenzhen, China

EUT Information

EUT Name: Mobile Payment Terminal
 Model: D195
 Brand: PAX
 Sample Received Date: November 2, 2023
 Sample Status: Normal
 Sample ID: 6613116
 Date of Tested: November 2, 2023 to December 5, 2023

APPLICABLE STANDARDS	
STANDARD	TEST RESULTS
CFR 47 FCC PART 15 SUBPART C ISED RSS-247 ISSUE 3	Pass

Prepared By:

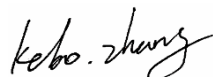

Kebo Zhang
 Senior Project Engineer

Checked By:

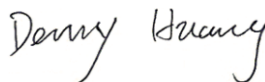

Denny Huang
 Senior Project Engineer

Approved By:



Stephen Guo
 Operations Manager

2. TEST METHODOLOGY

All tests were performed in accordance with the standard CFR 47 FCC PART 15 SUBPART C ISED RSS-247 ISSUE 3, KDB 558074 D01 15.247 Meas Guidance v05r02, KDB 414788 D01 Radiated Test Site v01r01, KDB 662911 D01 Multiple Transmitter Output v02r01, CFR 47 FCC Part 2, ANSI C63.10-2013 and ISED RSS-GEN Issue 5

3. FACILITIES AND ACCREDITATION

Accreditation Certificate	<p>A2LA (Certificate No.: 4102.01) UL Verification Services (Guangzhou) Co., Ltd. Song Shan Lake Branch. has been assessed and proved to be in compliance with A2LA.</p> <p>FCC (FCC Designation No.: CN1187) UL Verification Services (Guangzhou) Co., Ltd. Song Shan Lake Branch. Has been recognized to perform compliance testing on equipment subject to the Commission's Declaration of Conformity (DoC) and Certification rules</p> <p>ISED (Company No.: 21320) UL Verification Services (Guangzhou) Co., Ltd. Song Shan Lake Branch. has been registered and fully described in a report filed with ISED. The Company Number is 21320 and the test lab Conformity Assessment Body Identifier (CABID) is CN0046.</p> <p>VCCI (Registration No.: G-20192, C-20153, T-20155 and R-20202) UL Verification Services (Guangzhou) Co., Ltd. Song Shan Lake Branch. has been assessed and proved to be in compliance with VCCI, the Membership No. is 3793. Facility Name: Chamber D, the VCCI registration No. is G-20192 and R-20202 Shielding Room B, the VCCI registration No. is C-20153 and T-20155</p>
---------------------------	---

Note 1:

All tests measurement facilities use to collect the measurement data are located at Building 10, Innovation Technology Park, No. 1, Li Bin Road, Song Shan Lake Hi-Tech Development Zone Dongguan, 523808, People's Republic of China.

Note 2:

The test anechoic chamber in UL Verification Services (Guangzhou) Co., Ltd. Song Shan Lake Branch had been calibrated and compared to the open field sites and the test anechoic chamber is shown to be equivalent to or worst case from the open field site.

Note 3:

For below 30 MHz, lab had performed measurements at test anechoic chamber and comparing to measurements obtained on an open field site. And these measurements below 30 MHz had been correlated to measurements performed on an OFS.

4. CALIBRATION AND UNCERTAINTY

4.1. MEASURING INSTRUMENT CALIBRATION

The measuring equipment utilized to perform the tests documented in this report has been calibrated in accordance with the manufacturer's recommendations and is traceable to recognized national standards.

4.2. MEASUREMENT UNCERTAINTY

Where relevant, the following measurement uncertainty levels have been estimated for tests performed on the apparatus:

Test Item	Uncertainty
Conduction emission	3.62 dB
Radiated Emission (Included Fundamental Emission) (9 kHz ~ 30 MHz)	2.2 dB
Radiated Emission (Included Fundamental Emission) (30 MHz ~ 1 GHz)	4.00 dB
Radiated Emission (Included Fundamental Emission) (1 GHz to 26 GHz)	5.78 dB (1 GHz ~ 18 GHz)
	5.23 dB (18 GHz ~ 26 GHz)
Duty Cycle	±0.028%
DTS and 99% Occupied Bandwidth	±0.0196%
Maximum Conducted Output Power	±0.686 dB
Maximum Power Spectral Density Level	±0.743 dB
Conducted Band-edge Compliance	±1.328 dB
Conducted Unwanted Emissions In Non-restricted Frequency Bands	±0.746 dB (9 kHz ~ 1 GHz)
	±1.328dB (1 GHz ~ 26 GHz)
Note: This uncertainty represents an expanded uncertainty expressed at approximately the 95% confidence level using a coverage factor of k=2.	

5. EQUIPMENT UNDER TEST

5.1. DESCRIPTION OF EUT

EUT Name	Mobile Payment Terminal
Model	D195

Radio Technology	IEEE802.11b/g/n HT20/HT40
Operation frequency	IEEE 802.11b: 2412MHz ~ 2462MHz IEEE 802.11g: 2412MHz ~ 2462MHz IEEE 802.11n HT20: 2412MHz ~ 2462MHz IEEE 802.11n HT40: 2422MHz ~ 2452MHz
Modulation	IEEE 802.11b: DSSS (CCK) IEEE 802.11g: OFDM (64QAM, 16QAM, QPSK, BPSK) IEEE 802.11n HT20: OFDM (64QAM, 16QAM, QPSK, BPSK) IEEE 802.11n HT40: OFDM (64QAM, 16QAM, QPSK, BPSK)
Rated Input:	DC 5 V, 1 A
Battery:	3.7V/2100mAh

5.2. CHANNEL LIST

Channel List For Bandwidth=20 MHz							
Channel	Frequency (MHz)	Channel	Frequency (MHz)	Channel	Frequency (MHz)	Channel	Frequency (MHz)
1	2412	4	2427	7	2442	10	2457
2	2417	5	2432	8	2447	11	2462
3	2422	6	2437	9	2452	/	/

Channel List For Bandwidth=40 MHz							
Channel	Frequency (MHz)	Channel	Frequency (MHz)	Channel	Frequency (MHz)	Channel	Frequency (MHz)
3	2422	5	2432	7	2442	9	2452
4	2427	6	2437	8	2447	/	/

5.3. MAXIMUM POWER

IEEE Std. 802.11	Frequency (MHz)	Channel Number	Maximum Conducted AVG Output Power (dBm)
b	2412 ~ 2462	1-11[11]	17.28
g	2412 ~ 2462	1-11[11]	15.33
n HT20	2412 ~ 2462	1-11[11]	14.11
n HT40	2422 ~ 2452	3-9[7]	14.60

5.4. TEST CHANNEL CONFIGURATION

IEEE Std. 802.11	Test Channel Number	Frequency
b	CH 1(Low Channel), CH 6(MID Channel), CH 11(High Channel)	2412 MHz, 2437 MHz, 2462 MHz
g	CH 1(Low Channel), CH 6(MID Channel), CH 11(High Channel)	2412 MHz, 2437 MHz, 2462 MHz
n HT20	CH 1(Low Channel), CH 6(MID Channel), CH 11(High Channel)	2412 MHz, 2437 MHz, 2462 MHz
n HT40	CH 3(Low Channel), CH 6(MID Channel), CH 9(High Channel)	2422 MHz, 2437 MHz, 2452 MHz

5.5. THE WORSE CASE POWER SETTING PARAMETER

The Worse Case Power Setting Parameter under 2400 ~ 2483.5MHz Band							
Test Software		PUTTY					
Modulation Mode	Transmit Antenna Number	Test Channel					
		NCB: 20MHz			NCB: 40MHz		
		CH 1	CH 6	CH 11	CH 3	CH 6	CH 9
802.11b	1	42	42	42	/		
802.11g	1	48	48	48			
802.11n HT20	1	46	46	46			
802.11n HT40	1	/			46	46	46

5.6. THE WORSE CASE CONFIGURATIONS

The EUT was tested in the following configuration(s):

Controlled in test mode using a software application on the EUT supplied by customer. The application was used to enable a continuous transmission and to select the mode, test channels, bandwidth, data rates as required.

Test channels referring to section 5.4.

Maximum power setting referring to section 5.5.

Worst-case data rates as provided by the client were:

802.11b mode: 1 Mbps

802.11g mode: 6 Mbps

802.11n HT20 mode: MCS0

802.11n HT40 mode: MCS0

The measured additional path loss was included in any path loss calculations for all RF cable used during tested.

5.7. DESCRIPTION OF AVAILABLE ANTENNAS

Antenna	Frequency (MHz)	Antenna Type	MAX Antenna Gain (dBi)
1	2412-2462	FPC	0.63

Test Mode	Transmit and Receive Mode	Description
IEEE 802.11b	<input checked="" type="checkbox"/> 1TX, 1RX	ANT 1 can be used as transmitting/receiving antenna.
IEEE 802.11g	<input checked="" type="checkbox"/> 1TX, 1RX	ANT 1 can be used as transmitting/receiving antenna.
IEEE 802.11n HT20	<input checked="" type="checkbox"/> 1TX, 1RX	ANT 1 can be used as transmitting/receiving antenna.
IEEE 802.11n HT40	<input checked="" type="checkbox"/> 1TX, 1RX	ANT 1 can be used as transmitting/receiving antenna.

5.8. SUPPORT UNITS FOR SYSTEM TEST

SUPPORT EQUIPMENT

Item	Equipment	Brand Name	Model Name	Remarks
1	Laptop	Lenovo	E14	/
2	Adapter	N/A	GLH50E1000HW	Input: 100-240V~, 50/60Hz, 0.40A Output: DC 5V1A, 5W

I/O CABLES

Cable No	Port	Connector Type	Cable Type	Cable Length(m)	Remarks
1	USB	Type C	/	1.0	/

ACCESSORIES

Item	Equipment	Brand Name	Model Name	Remarks
/	/	/	/	/

TEST SETUP

The EUT can work in engineering mode with a software through a Laptop.

SETUP DIAGRAM FOR TESTS

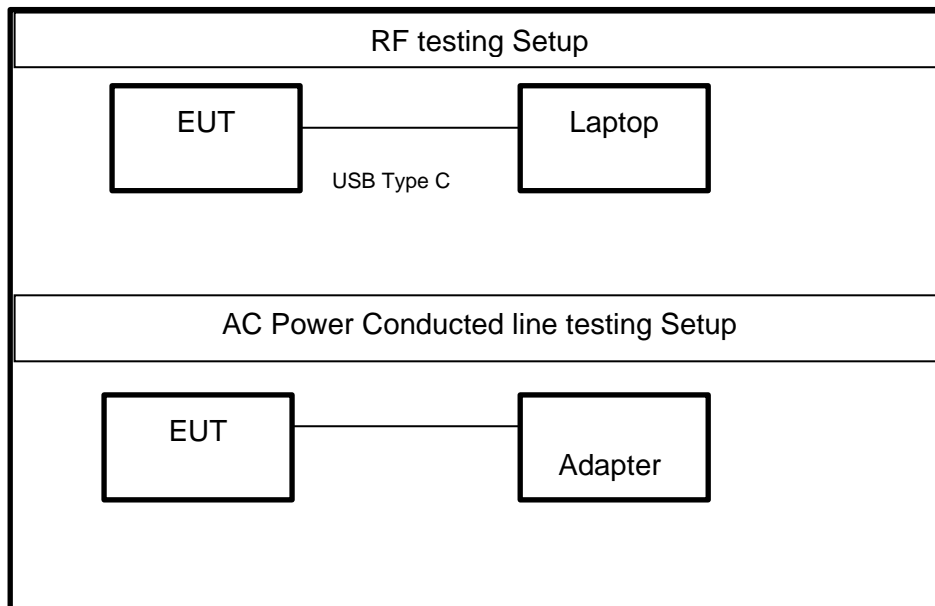

6. MEASURING EQUIPMENT AND SOFTWARE USED

R&S TS 8997 Test System					
Equipment	Manufacturer	Model No.	Serial No.	Last Cal.	Due. Date
Power sensor, Power Meter	R&S	OSP120	100921	Mar.31,2023	Mar.30,2024
Vector Signal Generator	R&S	SMBV100A	261637	Oct.12, 2023	Oct.11, 2024
Signal Generator	R&S	SMB100A	178553	Oct.12, 2023	Oct.11, 2024
Signal Analyzer	R&S	FSV40	101118	Oct.12, 2023	Oct.11, 2024
Software					
Description	Manufacturer	Name		Version	
For R&S TS 8997 Test System	Rohde & Schwarz	EMC 32		10.60.10	
Tonsend RF Test System					
Equipment	Manufacturer	Model No.	Serial No.	Last Cal.	Due. Date
Wideband Radio Communication Tester	R&S	CMW500	155523	Oct.12, 2023	Oct.11, 2024
Wireless Connectivity Tester	R&S	CMW270	1201.0002N75-102	Sep.25, 2023	Sep.24, 2024
PXA Signal Analyzer	Keysight	N9030A	MY55410512	Oct.12, 2023	Oct.11, 2024
MXG Vector Signal Generator	Keysight	N5182B	MY56200284	Oct.12, 2023	Oct.11, 2024
MXG Vector Signal Generator	Keysight	N5172B	MY56200301	Oct.12, 2023	Oct.11, 2024
DC power supply	Keysight	E3642A	MY55159130	Oct.12, 2023	Oct.11, 2024
Temperature & Humidity Chamber	SANMOOD	SG-80-CC-2	2088	Oct.12, 2023	Oct.11, 2024
Attenuator	Aglient	8495B	2814a12853	Oct.12, 2023	Oct.11, 2024
RF Control Unit	Tonscend	JS0806-2	23B80620666	April 18, 2023	April 17, 2024
Software					
Description	Manufacturer	Name		Version	
Tonsend SRD Test System	Tonsend	JS1120-3 RF Test System		V3.2.22	

Conducted Emissions					
Equipment	Manufacturer	Model No.	Serial No.	Last Cal.	Due Date
EMI Test Receiver	R&S	ESR3	101961	Oct.13, 2023	Oct.12, 2024
Two-Line V-Network	R&S	ENV216	101983	Oct.13, 2023	Oct.12, 2024
Artificial Mains Networks	Schwarzbeck	NSLK 8126	8126465	Oct.13, 2023	Oct.12, 2024
Software					
Description			Manufacturer	Name	Version
Test Software for Conducted Emissions			Farad	EZ-EMC	Ver. UL-3A1

Radiated Emissions					
Equipment	Manufacturer	Model No.	Serial No.	Last Cal.	Due Date
MXE EMI Receiver	KESIGHT	N9038A	MY56400036	Oct.12, 2023	Oct.11, 2024
Hybrid Log Periodic Antenna	TDK	HLP-3003C	130959	Aug.02, 2021	Aug.01, 2024
Preamplifier	HP	8447D	2944A09099	Oct.12, 2023	Oct.11, 2024
EMI Measurement Receiver	R&S	ESR26	101377	Oct.12, 2023	Oct.11, 2024
Horn Antenna	TDK	HRN-0118	130940	July 20, 2021	July 19, 2024
Preamplifier	TDK	PA-02-0118	TRS-305-00067	Oct.12, 2023	Oct.11, 2024
Horn Antenna	Schwarzbeck	BBHA9170	697	July 20, 2021	July 19, 2024
Preamplifier	TDK	PA-02-2	TRS-307-00003	Oct.12, 2023	Oct.11, 2024
Preamplifier	TDK	PA-02-3	TRS-308-00002	Oct.12, 2023	Oct.11, 2024
Loop antenna	Schwarzbeck	1519B	00008	Dec.14, 2021	Dec.13, 2024
Preamplifier	TDK	PA-02-001-3000	TRS-302-00050	Oct.12, 2023	Oct.11, 2024
High Pass Filter	Wi	WHKX10-2700-3000-18000-40SS	23	Oct.12, 2023	Oct.11, 2024
Highpass Filter	Wainwright	WHKX10-5850-6500-1800-40SS	4	Oct.12, 2023	Oct.11, 2024
Band Reject Filter	Wainwright	WRCJV12-5695-5725-5850-5880-40SS	4	Oct.12, 2023	Oct.11, 2024
Band Reject Filter	Wainwright	WRCJV20-5120-5150-5350-5380-60SS	2	Oct.12, 2023	Oct.11, 2024

Band Reject Filter	Wainwright	WRCJV20-5440-5470-5725-5755-60SS	1	Oct.12, 2023	Oct.11, 2024
Band Reject Filter	Wainwright	WRCJV8-2350-2400-2483.5-2533.5-40SS	4	Oct.12, 2023	Oct.11, 2024
Band Reject Filter	Wainwright	WRCD5-1879-1879.85-1880.15-1881-40SS	1	Oct.12, 2023	Oct.11, 2024
Notch Filter	Wainwright	WHJ10-882-980-7000-40SS	1	Oct.12, 2023	Oct.11, 2024
Highpass Filter	Xingbo	XBLBQ-GTA68	211115-2-1	Oct.12, 2023	Oct.11, 2024
Notch Filter (5905-6445 MHz)	Xingbo	XBLBQ-DZA175	210922-2-1	Oct.12, 2023	Oct.11, 2024
Notch Filter (6425-6525 MHz)	Xingbo	XBLBQ-DZA176	210922-2-2	Oct.12, 2023	Oct.11, 2024
Notch Filter (6825-7125 MHz)	Xingbo	XBLBQ-DZA177	210922-2-3	Oct.12, 2023	Oct.11, 2024
Notch Filter (6525-6875 MHz)	Xingbo	XBLBQ-DZA178	210922-2-4	Oct.12, 2023	Oct.11, 2024
Software					
Description			Manufacturer	Name	Version
Test Software for Radiated Emissions			Farad	EZ-EMC	Ver. UL-3A1

Other Instrument					
Equipment	Manufacturer	Model No.	Serial No.	Last Cal.	Due Date
Temperature humidity probe	OMEGA	ITHX-SD-5	18470007	Oct.21, 2023	Oct.20, 2024
Barometer	Yiyi	Baro	N/A	Oct.19, 2023	Oct.18, 2024
Attenuator	Agilent	8495B	2814a12853	Oct.12, 2023	Oct.11, 2024

7. ANTENNA PORT TEST RESULTS

7.1. CONDUCTED OUTPUT POWER

LIMITS

CFR 47 FCC Part15 (15.247) Subpart C ISED RSS-247 ISSUE 3			
Section	Test Item	Limit	Frequency Range (MHz)
CFR 47 FCC 15.247(b)(3) ISED RSS-247 5.4 (d)	AVG Output Power	1 watt or 30 dBm	2400-2483.5

TEST PROCEDURE

Refer to ANSI C63.10-2013 clause 11.9.2.3.1.

Connect the EUT to a low loss RF cable from the antenna port to the power sensor (video bandwidth is greater than the occupied bandwidth).

Measure peak emission level, the indicated level is the average output power, after any corrections for external attenuators and cables.

The test result in dBm by adding $[10 \log (1 / D)]$, where D is the duty cycle.

TEST SETUP

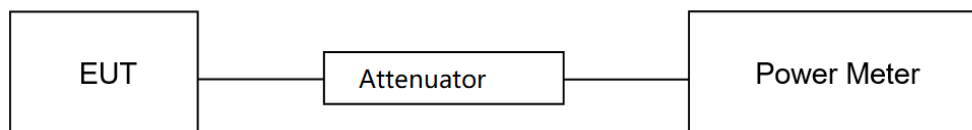

TEST ENVIRONMENT

Temperature	25.1°C	Relative Humidity	52%
Atmosphere Pressure	101.2kPa	Test Voltage	DC 5 V

TEST DATE / ENGINEER

Test Date	November 14, 2023	Test By	Walker Yuan
-----------	-------------------	---------	-------------

TEST RESULTS

Please refer to section "Test Data" - Appendix C

7.2. 6DB BANDWIDTH AND 99% OCCUPIED BANDWIDTH

LIMITS

CFR 47 FCC Part15 (15.247) Subpart C ISED RSS-247 ISSUE 3			
Section	Test Item	Limit	Frequency Range (MHz)
CFR 47 FCC 15.247(a)(2) ISED RSS-247 5.2 (a)	6 dB Bandwidth	≥ 500 kHz	2400-2483.5
ISED RSS-Gen Clause 6.7	99 % Occupied Bandwidth	For reporting purposes only.	2400-2483.5

TEST PROCEDURE

Refer to ANSI C63.10-2013 clause 11.8 for DTS bandwidth and clause 6.9 for Occupied Bandwidth.

Connect the EUT to the spectrum analyzer and use the following settings:

Center Frequency	The center frequency of the channel under test
Frequency Span	For 6 dB Bandwidth: Enough to capture all products of the modulation carrier emission For 99 % Occupied Bandwidth: Between 1.5 times and 5.0 times the OBW
Detector	Peak
RBW	For 6 dB Bandwidth: 100 kHz For 99 % Occupied Bandwidth: 1 % to 5 % of the occupied bandwidth
VBW	For 6 dB Bandwidth: ≥3 × RBW For 99 % Occupied Bandwidth: ≥3 × RBW
Trace	Max hold
Sweep	Auto couple

a) Use the 99 % power bandwidth function of the instrument, allow the trace to stabilize and report the measured bandwidth.

b) Allow the trace to stabilize and measure the maximum width of the emission that is constrained by the frequencies associated with the two outermost amplitude points (upper and lower frequencies) that are attenuated by 6 dB relative to the maximum level measured in the fundamental emission.

TEST SETUP

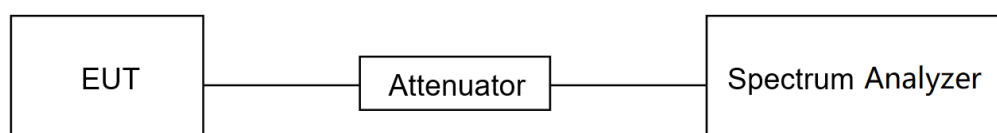

TEST ENVIRONMENT

Temperature	25.1°C	Relative Humidity	52%
Atmosphere Pressure	101.2kPa	Test Voltage	DC 5 V

TEST DATE / ENGINEER

Test Date	November 14, 2023	Test By	Walker Yuan
-----------	-------------------	---------	-------------

TEST RESULTS

Please refer to section "Test Data" - Appendix A&B

7.3. POWER SPECTRAL DENSITY

LIMITS

CFR 47 FCC Part15 (15.247) Subpart C ISED RSS-247 ISSUE 3			
Section	Test Item	Limit	Frequency Range (MHz)
CFR 47 FCC §15.247 (e) ISED RSS-247 5.2 (b)	Power Spectral Density	8 dBm in any 3 kHz band	2400-2483.5

TEST PROCEDURE

Refer to ANSI C63.10-2013 clause 11.10.5.

Connect the EUT to the spectrum analyzer and use the following settings:

Center Frequency	The center frequency of the channel under test
Detector	power averaging (rms)
RBW	$3 \text{ kHz} \leq \text{RBW} \leq 100 \text{ kHz}$
VBW	$\geq 3 \times \text{RBW}$
Span	1.5 x OBW bandwidth
Trace	Employ trace averaging(rms)mode over a minimum of 100 traces
Sweep time	Auto couple

Allow trace to fully stabilize and use the peak marker function to determine the maximum amplitude level within the RBW.

If measured value exceeds limit, reduce RBW (no less than 3 kHz) and repeat.

TEST SETUP

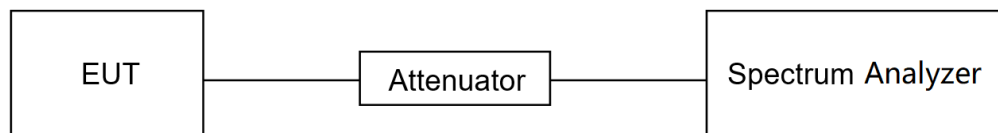

TEST ENVIRONMENT

Temperature	25.1°C	Relative Humidity	52%
Atmosphere Pressure	101.2kPa	Test Voltage	DC 5 V

TEST DATE / ENGINEER

Test Date	November 14, 2023	Test By	Walker Yuan
-----------	-------------------	---------	-------------

TEST RESULTS

Please refer to section "Test Data" - Appendix D

7.4. CONDUCTED BAND EDGE AND SPURIOUS EMISSION

TEST PROCEDURE

Refer to ANSI C63.10-2013 clause 11.11 and 11.13.

Connect the EUT to the spectrum analyzer and use the following settings for reference level measurement:

Center Frequency	The center frequency of the channel under test
Detector	Peak
RBW	100 kHz
VBW	$\geq 3 \times \text{RBW}$
Span	1.5 x DTS bandwidth
Trace	Max hold
Sweep time	Auto couple.

Allow trace to fully stabilize and use the peak marker function to determine the maximum PSD level.

Change the settings for emission level measurement:

Span	Set the center frequency and span to encompass frequency range to be measured
Detector	Peak
RBW	100 kHz
VBW	$\geq 3 \times \text{RBW}$
measurement points	$\geq \text{span}/\text{RBW}$
Trace	Max hold
Sweep time	Auto couple.

Allow trace to fully stabilize and use the peak marker function to determine the maximum PSD level. Ensure that the amplitude of all unwanted emissions outside of the authorized frequency band (excluding restricted frequency bands) is attenuated by at least the minimum requirements specified in 11.11.

TEST SETUP

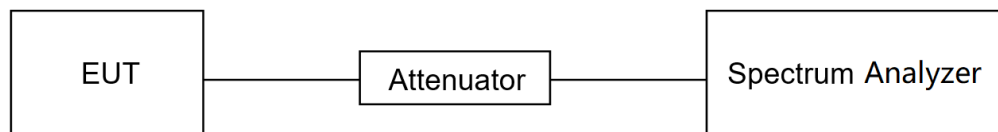

TEST ENVIRONMENT

Temperature	25.1°C	Relative Humidity	52%
Atmosphere Pressure	101.2kPa	Test Voltage	DC 5 V

TEST DATE / ENGINEER

Test Date	November 14, 2023	Test By	Walker Yuan
-----------	-------------------	---------	-------------

TEST RESULTS

Please refer to section "Test Data" - Appendix E&F

7.5. DUTY CYCLE

LIMITS

None; for reporting purposes only.

TEST PROCEDURE

Refer to ANSI C63.10-2013 clause 11.6 Zero – Span Spectrum Analyzer method.

TEST SETUP

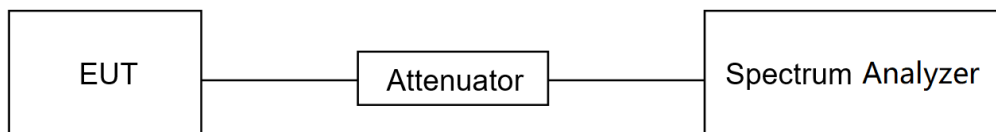

TEST ENVIRONMENT

Temperature	25.1°C	Relative Humidity	52%
Atmosphere Pressure	101.2kPa	Test Voltage	DC 5 V

TEST DATE / ENGINEER

Test Date	November 14, 2023	Test By	Walker Yuan
-----------	-------------------	---------	-------------

TEST RESULTS

Please refer to section "Test Data" - Appendix G

8. RADIATED TEST RESULTS

LIMITS

Please refer to CFR 47 FCC §15.205 and §15.209.

Please refer to ISED RSS-GEN Clause 8.9 and Clause 8.10.

Radiation Disturbance Test Limit for FCC (Class B) (9 kHz ~ 1 GHz)

Emissions radiated outside of the specified frequency bands above 30 MHz			
Frequency Range (MHz)	Field Strength Limit (uV/m) at 3 m	Field Strength Limit (dBuV/m) at 3 m	
		Quasi-Peak	
30 - 88	100	40	
88 - 216	150	43.5	
216 - 960	200	46	
Above 960	500	54	
Above 1000	500	Peak	Average
		74	54

FCC Emissions radiated outside of the specified frequency bands below 30 MHz		
Frequency (MHz)	Field strength (microvolts/meter)	Measurement distance (meters)
0.009-0.490	2400/F(kHz)	300
0.490-1.705	24000/F(kHz)	30
1.705-30.0	30	30

ISED General field strength limits at frequencies below 30 MHz

Table 6 – General field strength limits at frequencies below 30 MHz		
Frequency	Magnetic field strength (H-Field) (µA/m)	Measurement distance (m)
9 - 490 kHz ^{Note 1}	6.37/F (F in kHz)	300
490 - 1705 kHz	63.7/F (F in kHz)	30
1.705 - 30 MHz	0.08	30

Note 1: The emission limits for the ranges 9-90 kHz and 110-490 kHz are based on measurements employing a linear average detector.

ISED Restricted bands please refer to ISED RSS-GEN Clause 8.10

Table 7 – Restricted frequency bands ^{Note 1}		
MHz	MHz	GHz
0.090 - 0.110	149.9 - 150.05	9.0 - 9.2
0.495 - 0.505	156.52475 - 156.52525	9.3 - 9.5
2.1735 - 2.1905	156.7 - 156.9	10.6 - 12.7
3.020 - 3.026	162.0125 - 167.17	13.25 - 13.4
4.125 - 4.128	167.72 - 173.2	14.47 - 14.5
4.17725 - 4.17775	240 - 285	15.35 - 16.2
4.20725 - 4.20775	322 - 335.4	17.7 - 21.4
5.677 - 5.683	399.9 - 410	22.01 - 23.12
6.215 - 6.218	608 - 614	23.6 - 24.0
6.26775 - 6.26825	960 - 1427	31.2 - 31.8
6.31175 - 6.31225	1435 - 1626.5	36.43 - 36.5
8.291 - 8.294	1645.5 - 1646.5	Above 38.6
8.362 - 8.366	1660 - 1710	
8.37625 - 8.38675	1718.8 - 1722.2	
8.41425 - 8.41475	2200 - 2300	
12.29 - 12.293	2310 - 2390	
12.51975 - 12.52025	2483.5 - 2500	
12.57675 - 12.57725	2655 - 2900	
13.36 - 13.41	3260 - 3267	
16.42 - 16.423	3332 - 3339	
16.69475 - 16.69525	3345.8 - 3358	
16.80425 - 16.80475	3500 - 4400	
25.5 - 25.67	4500 - 5150	
37.5 - 38.25	5350 - 5460	
73 - 74.6	7250 - 7750	
74.8 - 75.2	8025 - 8500	
108 - 138		

Note 1: Certain frequency bands listed in table 7 and in bands above 38.6 GHz are designated for licence-exempt applications. These frequency bands and the requirements that apply to related devices are set out in the 200 and 300 series of RSSs.

FCC Restricted bands of operation refer to FCC §15.205 (a):

MHz	MHz	MHz	GHz
0.090-0.110	16.42-16.423	399.9-410	4.5-5.15
¹ 0.495-0.505	16.69475-16.69525	608-614	5.35-5.46
2.1735-2.1905	16.80425-16.80475	960-1240	7.25-7.75
4.125-4.128	25.5-25.67	1300-1427	8.025-8.5
4.17725-4.17775	37.5-38.25	1435-1626.5	9.0-9.2
4.20725-4.20775	73-74.6	1645.5-1646.5	9.3-9.5
6.215-6.218	74.8-75.2	1660-1710	10.6-12.7
6.26775-6.26825	108-121.94	1718.8-1722.2	13.25-13.4
6.31175-6.31225	123-138	2200-2300	14.47-14.5
8.291-8.294	149.9-150.05	2310-2390	15.35-16.2
8.362-8.366	156.52475-156.52525	2483.5-2500	17.7-21.4
8.37625-8.38675	156.7-156.9	2690-2900	22.01-23.12
8.41425-8.41475	162.0125-167.17	3260-3267	23.6-24.0
12.29-12.293	167.72-173.2	3332-3339	31.2-31.8
12.51975-12.52025	240-285	3345.8-3358	36.43-36.5
12.57675-12.57725	322-335.4	3600-4400	(²)
13.36-13.41			

Note: ¹Until February 1, 1999, this restricted band shall be 0.490-0.510 MHz.

²Above 38.6c

TEST PROCEDURE

Below 30 MHz

The setting of the spectrum analyzer

RBW	200 Hz (From 9 kHz to 0.15 MHz)/ 9 kHz (From 0.15 MHz to 30 MHz)
VBW	200 Hz (From 9 kHz to 0.15 MHz)/ 9 kHz (From 0.15 MHz to 30 MHz)
Sweep	Auto

1. The testing follows the guidelines in ANSI C63.10-2013 clause 6.4.
2. The EUT was arranged to its worst case and then turntable (from 0 degree to 360 degrees) to find the maximum reading. A pre-amp and a high pass filter are used for the test in order to get better signal level. Both Horizontal, Face-on and Face-off polarizations of the antenna are set to make the measurement.
3. The EUT was placed on a turntable with 80 cm above ground.
4. The EUT was set 3 meters from the interference receiving antenna, which was mounted on the top of a 1 m height antenna tower.
5. The radiated emission limits are based on measurements employing a CISPR quasi-peak detector except for the frequency bands 9-90 kHz, 110-490 kHz and above 1000 MHz Radiated emission limits in these three bands are based on measurements employing an average detector.
6. For measurement below 1 GHz, the initial step in collecting conducted emission data is a spectrum analyzer peak detector mode pre-scanning the measurement frequency range. Significant peaks are then marked and then Quasi Peak and average detector mode re-measured. If the emission level of the EUT measured by the peak detector is 3 dB lower than the applicable limit, the peak emission level will be reported. Otherwise, the emission measurement will be repeated using the quasi-peak and average detector and reported.
7. Although these tests were performed other than open field site, adequate comparison measurements were confirmed against 30m open field site. Therefore sufficient tests were made to demonstrate that the alternative site produces results that correlate with the ones of tests made in an open field site based on KDB 414788.
8. The limits in CFR 47, Part 15, Subpart C, paragraph 15.209 (a), are identical to those in RSS-GEN Section 8.9, Table 6, since the measurements are performed in terms of magnetic field strength and converted to electric field strength levels (as reported in the table) using the free space impedance of 377Ω . For example, the measurement frequency X kHz resulted in a level of Y dBuV/m, which is equivalent to $Y-51.5 = Z$ dBuA/m, which has the same margin, W dB, to the corresponding RSS-GEN Table 6 limit as it has to be 15.209(a) limit.

Below 1 GHz and above 30 MHz

The setting of the spectrum analyzer

RBW	120 kHz
VBW	300 kHz
Sweep	Auto
Detector	Peak/QP
Trace	Max hold

1. The testing follows the guidelines in ANSI C63.10-2013 clause 6.5.
2. The EUT was arranged to its worst case and then tune the antenna tower (from 1 m to 4 m) and turntable (from 0 degree to 360 degrees) to find the maximum reading. A pre-amp and a high pass filter are used for the test in order to get better signal level. Both horizontal and vertical polarizations of the antenna are set to make the measurement.
3. The EUT was placed on a turntable with 80 cm above ground.
4. The EUT was set 3 meters from the interference receiving antenna, which was mounted on the top of a variable height antenna tower.
5. For measurement below 1 GHz, the initial step in collecting conducted emission data is a spectrum analyzer peak detector mode pre-scanning the measurement frequency range. Significant peaks are then marked and then Quasi Peak detector mode re-measured. If the emission level of the EUT measured by the peak detector is 3 dB lower than the applicable limit, the peak emission level will be reported. Otherwise, the emission measurement will be repeated using the quasi-peak detector and reported.

Above 1 GHz

The setting of the spectrum analyzer

RBW	1 MHz
VBW	PEAK: 3 MHz AVG: see note 6
Sweep	Auto
Detector	Peak
Trace	Max hold

1. The testing follows the guidelines in ANSI C63.10-2013 clause 6.6.
2. The EUT was arranged to its worst case and then tune the antenna tower (from 1 m to 4 m) and turntable (from 0 degree to 360 degrees) to find the maximum reading. A pre-amp and a high pass filter are used for the test in order to get better signal level. Both horizontal and vertical polarizations of the antenna are set to make the measurement.
3. The EUT was placed on a turntable with 1.5 m above ground.
4. The EUT was set 3 meters from the interference receiving antenna, which was mounted on the top of a variable height antenna tower.
5. For measurement above 1 GHz, the emission measurement will be measured by the peak detector. This peak level, once corrected, must comply with the limit specified in Section 15.209.
6. For measurements above 1 GHz the resolution bandwidth is set to 1 MHz, then the video bandwidth is set to 3 MHz for peak measurements and 1 MHz resolution bandwidth with 1/T video bandwidth with peak detector for average measurements. For the Duty Cycle please refer to clause 7.5. ON TIME AND DUTY CYCLE.

X axis, Y axis, Z axis positions:

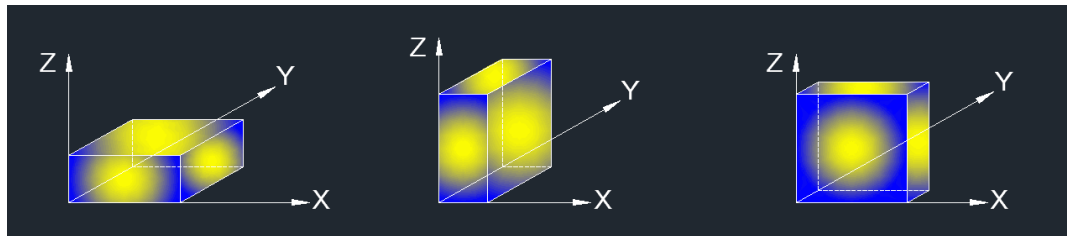

Note 1: For all radiated test, EUT in each of three orthogonal axis emissions had been tested, but only the worst case (X axis) data recorded in the report.

Note 2: The EUT was fully exercised with external accessories during the test. In the case of multiple accessory external ports, an external accessory shall be connected to one of each type of port.

For Restricted Bandedge:

Note:

1. Measurement = Reading Level + Correct Factor.
2. If the peak values are less than the average limit of 54 dBuV/m, the average result is deemed to comply with average limit.
3. PK=Peak: Peak detector.
4. AV=Average: VBW=1/Ton, where: Ton is the transmitting duration.
5. For the transmitting duration, please refer to clause 7.5.
6. Only the worst data was recorded, if it complies with the limit, the other emissions deemed to comply with the limit.
7. Both horizontal and vertical have been tested, only the worst data was recorded in the report.
8. All modes have been tested, but only the worst data was recorded in the report.

For Radiate Spurious emission (9 kHz ~ 30 MHz):

Note:

1. Measurement = Reading Level + Correct Factor.
2. If the peak values are less than the QP limit, the QP result is deemed to comply with QP limit.
3. All 3 polarizations (Horizontal, Face-on and Face-off) of the loop antenna had been tested, but only the worst data recorded in the report.
4. All modes have been tested, but only the worst data was recorded in the report.
5. $\text{dBuA/m} = \text{dBuV/m} - 20\text{Log}_{10}[120\pi] = \text{dBuV/m} - 51.5$

For Radiate Spurious Emission (30 MHz ~ 1 GHz):

Note:

1. Result Level = Read Level + Correct Factor.
2. If the peak values are less than the QP limit, the QP result is deemed to comply with QP limit.
3. All modes have been tested, but only the worst data was recorded in the report.

For Radiate Spurious Emission (1 GHz ~ 3 GHz):

Note:

1. Measurement = Reading Level + Correct Factor.
2. If the peak values are less than the average limit of 54 dBuV/m, the average result is deemed to comply with average limit.
3. Peak: Peak detector.
4. AVG: VBW=1/Ton, where: Ton is the transmitting duration.
5. For the transmitting duration, please refer to clause 7.5.
6. Filter losses were only considered in the spurious frequency bands and the authorized band was not corrected for Band reject filter losses.
7. Proper operation of the transmitter prior to adding the filter to the measurement chain.
8. All modes have been tested, but only the worst data was recorded in the report.

For Radiate Spurious Emission (3 GHz ~ 18 GHz):

Note:

1. Peak Result = Reading Level + Correct Factor.
2. If the peak values are less than the average limit of 54 dBuV/m, the average result is deemed to comply with average limit.
3. Peak: Peak detector.
4. AVG: $VBW=1/T_{on}$, where: T_{on} is the transmitting duration.
5. For the transmitting duration, please refer to clause 7.5.
6. Filter losses were only considered in the spurious frequency bands and the authorized band was not corrected for High Pass Filter losses.
7. Proper operation of the transmitter prior to adding the filter to the measurement chain.
8. All modes have been tested, but only the worst data was recorded in the report.

For Radiate Spurious emission (18 GHz ~ 26 GHz):

Note:

1. Measurement = Reading Level + Correct Factor.
2. If the peak values are less than the average limit of 54 dBuV/m, the average result is deemed to comply with average limit.
3. Peak: Peak detector.
4. All modes have been tested, but only the worst data was recorded in the report.

TEST SETUP

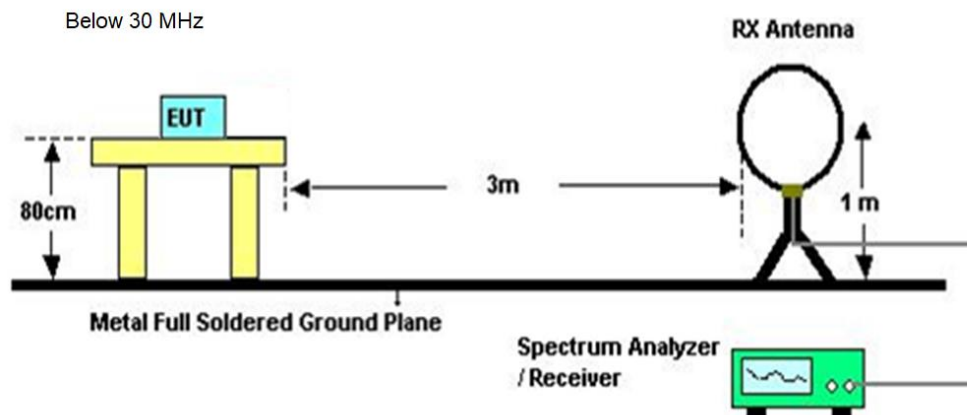

Below 1 GHz and above 30 MHz

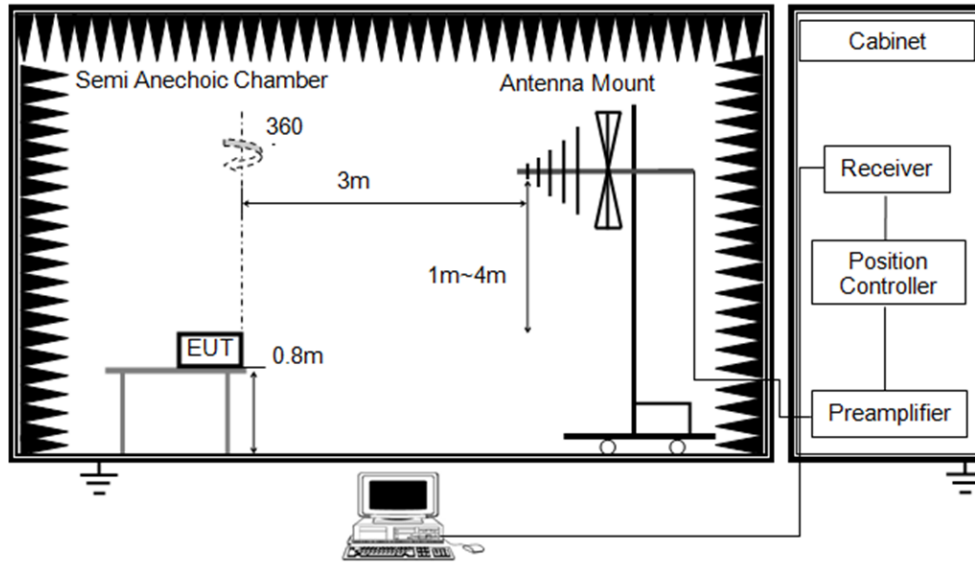

Above 1 GHz

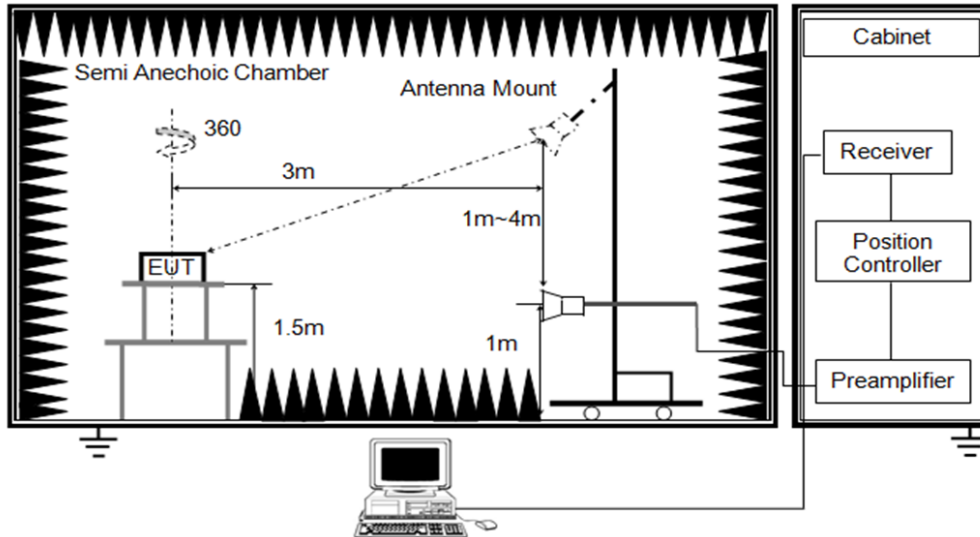

TEST ENVIRONMENT

Temperature	24.8°C	Relative Humidity	59%
Atmosphere Pressure	101kPa	Test Voltage	DC 5 V

TEST DATE / ENGINEER

Test Date	December 5, 2023	Test By	Rex Huang
-----------	------------------	---------	-----------

TEST RESULTS

8.1. RESTRICTED BANDEDGE

Test Mode:	802.11b PK	Frequency(MHz):	2412
Polarity:	Horizontal	Test Voltage:	DC 5 V

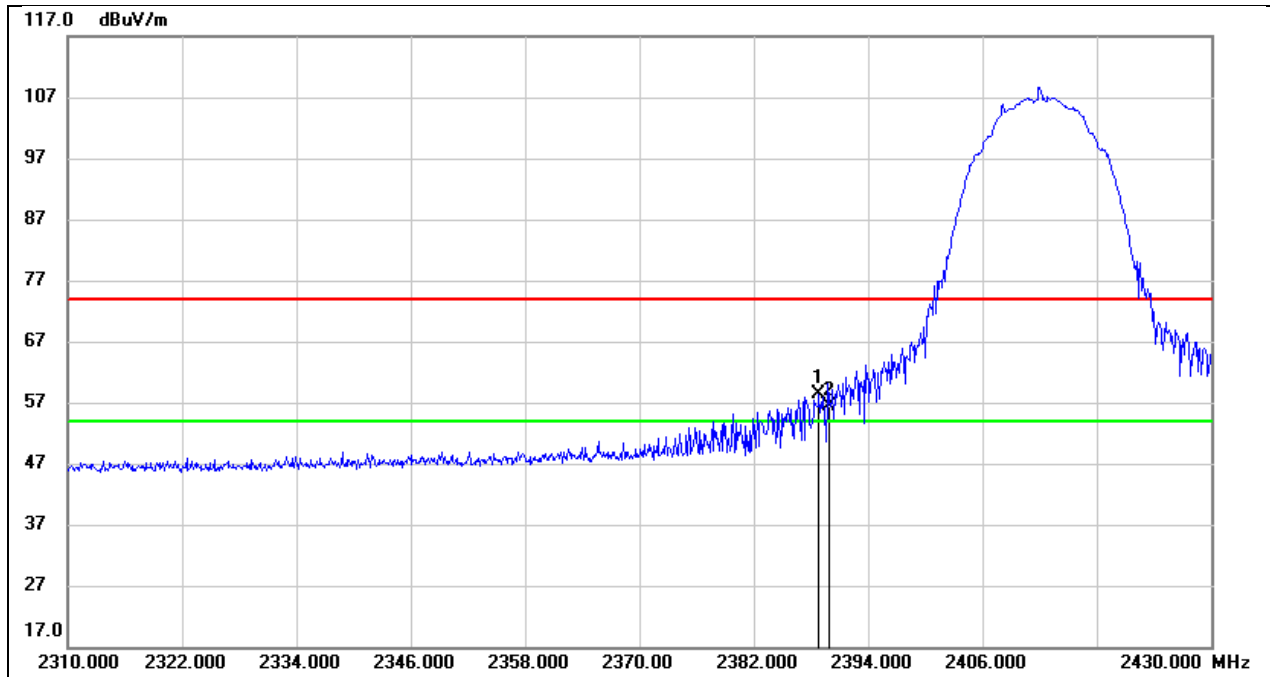

No.	Frequency (MHz)	Reading (dBuV)	Correct (dB/m)	Result (dBuV/m)	Limit (dBuV/m)	Margin (dB)	Remark
1	2388.840	26.25	32.16	58.41	74.00	-15.59	peak
2	2390.000	24.18	32.16	56.34	74.00	-17.66	peak

Test Mode:	802.11b PK	Frequency(MHz):	2412
Polarity:	Vertical	Test Voltage:	DC 5 V

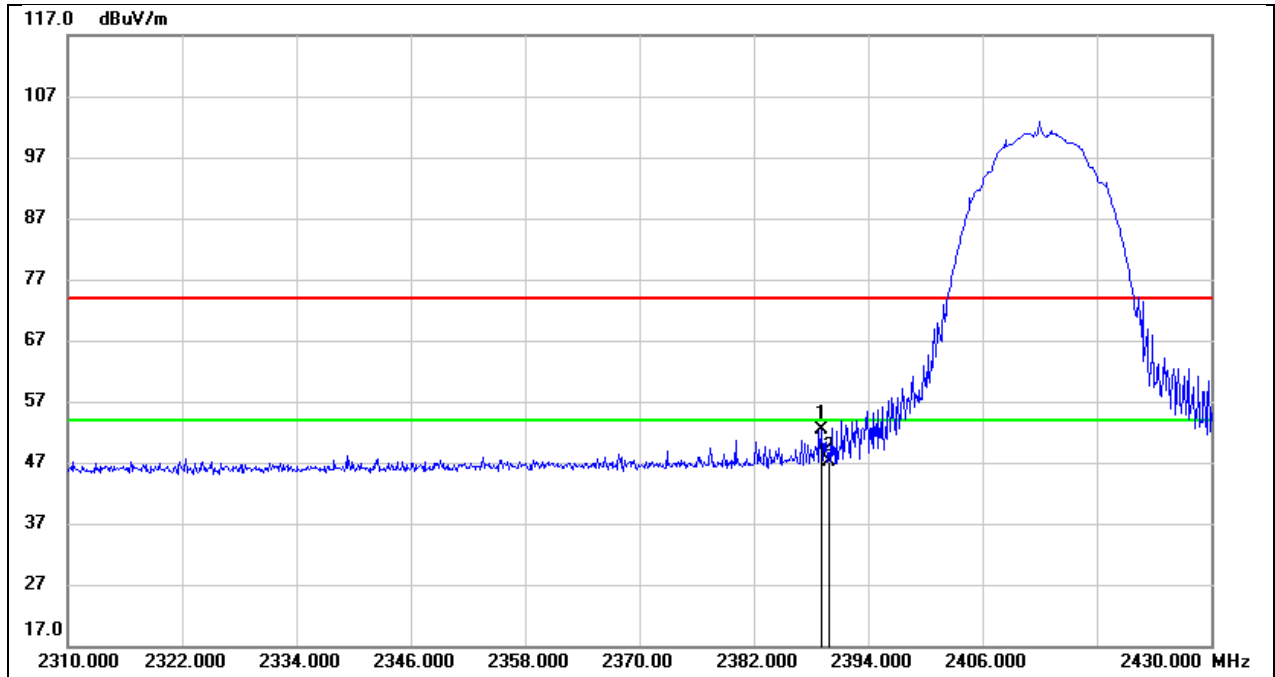

No.	Frequency (MHz)	Reading (dBuV)	Correct (dB/m)	Result (dBuV/m)	Limit (dBuV/m)	Margin (dB)	Remark
1	2389.080	20.20	32.16	52.36	74.00	-21.64	peak
2	2390.000	15.01	32.16	47.17	74.00	-26.83	peak

Test Mode:	802.11b AV	Frequency(MHz):	2412
Polarity:	Horizontal	Test Voltage:	DC 5 V

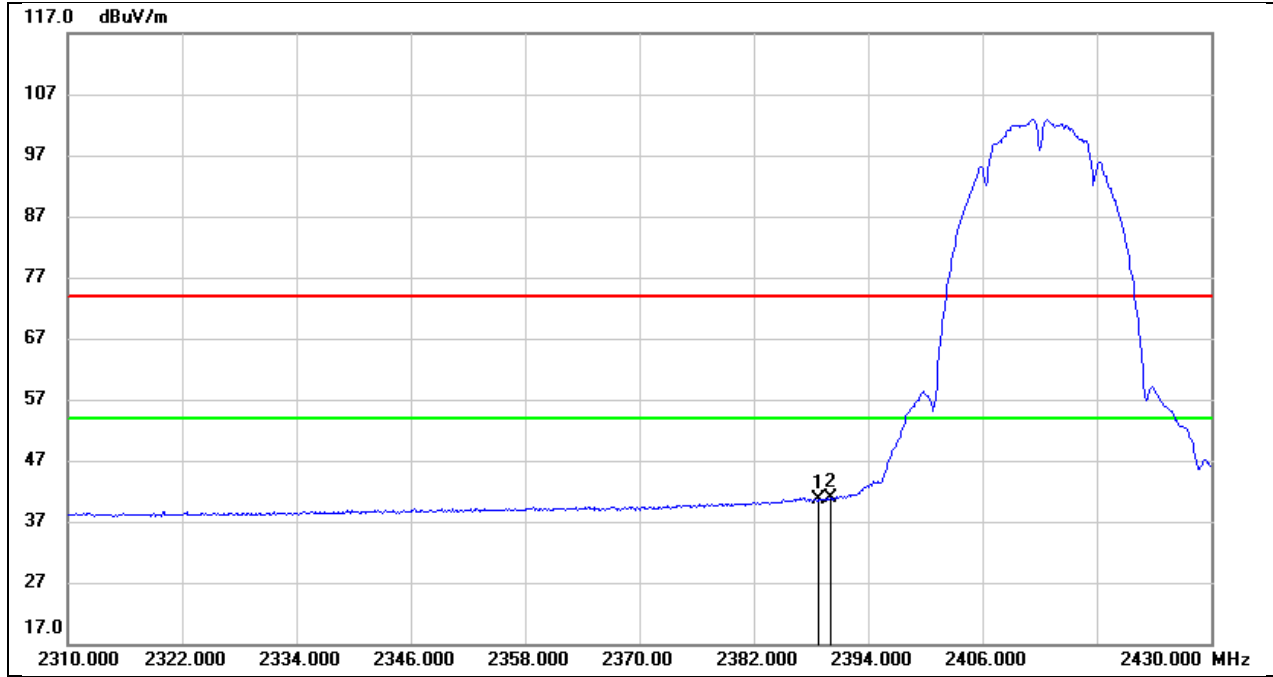

No.	Frequency (MHz)	Reading (dBuV)	Correct (dB/m)	Result (dBuV/m)	Limit (dBuV/m)	Margin (dB)	Remark
1	2388.840	8.35	32.16	40.51	54.00	-13.49	AVG
2	2390.000	8.73	32.16	40.89	54.00	-13.11	AVG

Test Mode:	802.11b PK	Frequency(MHz):	2462
Polarity:	Horizontal	Test Voltage:	DC 5 V

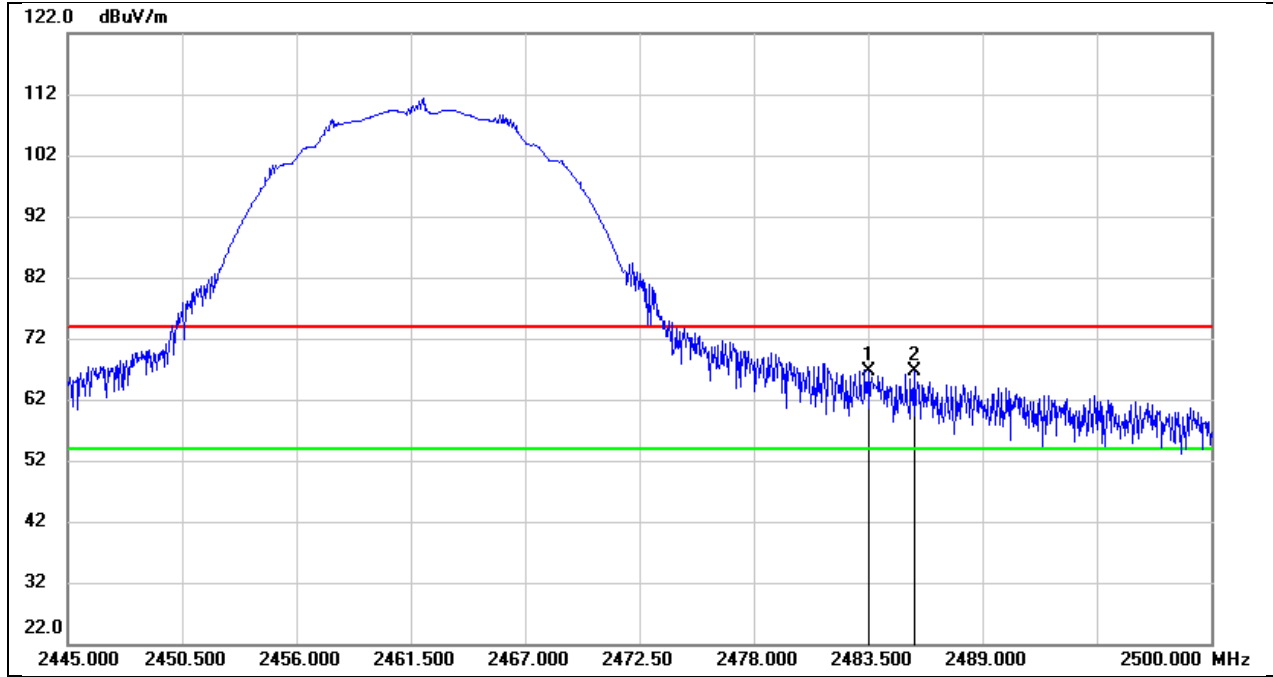

No.	Frequency (MHz)	Reading (dBuV)	Correct (dB/m)	Result (dBuV/m)	Limit (dBuV/m)	Margin (dB)	Remark
1	2483.500	34.12	32.44	66.56	74.00	-7.44	peak
2	2485.700	34.15	32.44	66.59	74.00	-7.41	peak

Test Mode:	802.11b AV	Frequency(MHz):	2462
Polarity:	Horizontal	Test Voltage:	DC 5 V

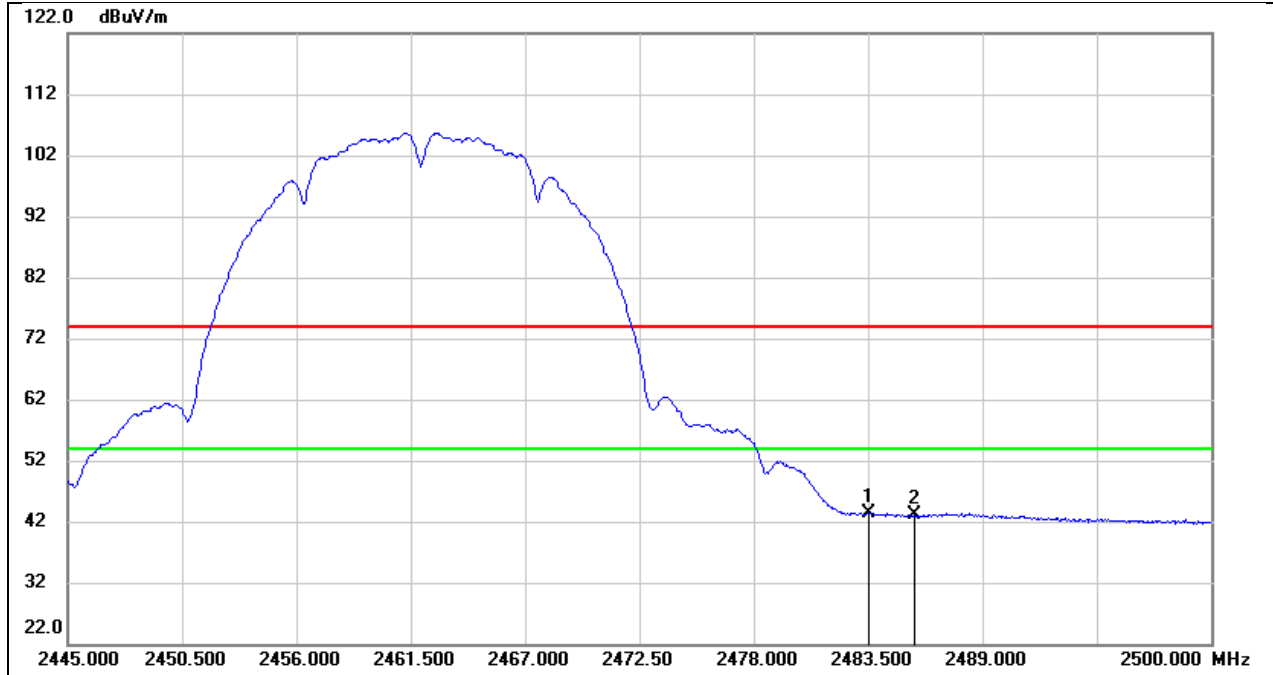

No.	Frequency (MHz)	Reading (dBuV)	Correct (dB/m)	Result (dBuV/m)	Limit (dBuV/m)	Margin (dB)	Remark
1	2483.500	11.04	32.44	43.48	54.00	-10.52	AVG
2	2485.700	10.62	32.44	43.06	54.00	-10.94	AVG

Test Mode:	802.11g PK	Frequency(MHz):	2412
Polarity:	Horizontal	Test Voltage:	DC 5 V

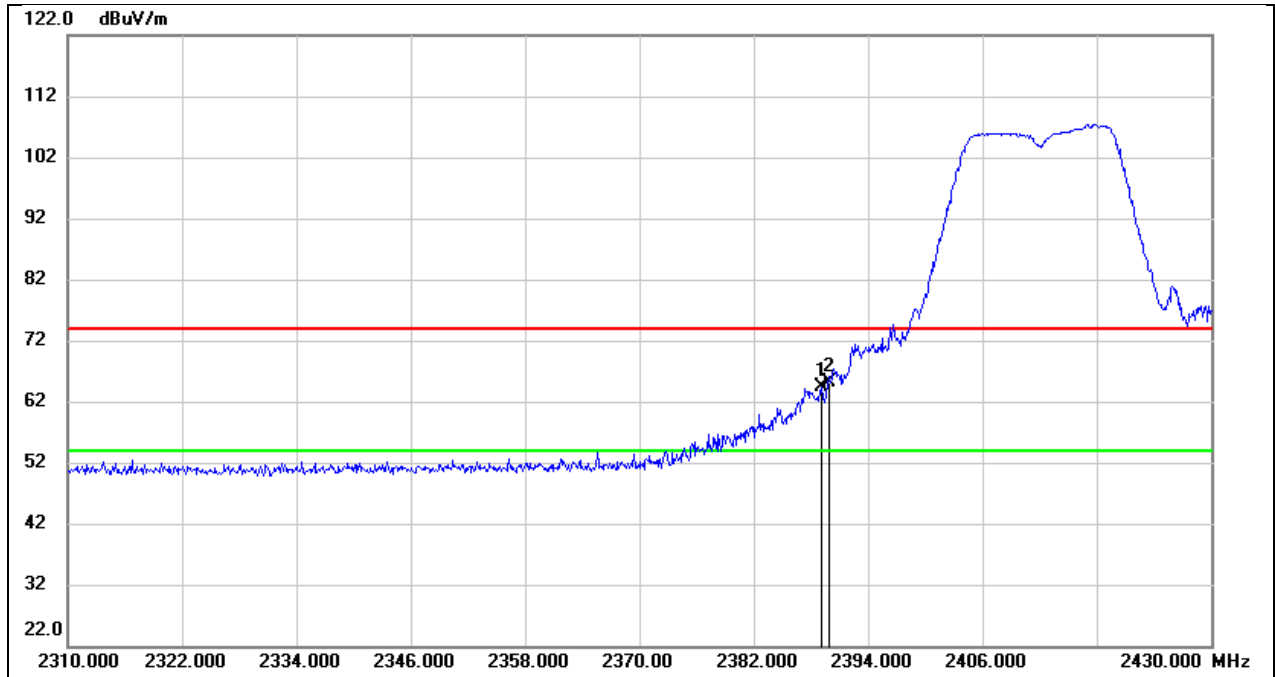

No.	Frequency (MHz)	Reading (dBuV)	Correct (dB/m)	Result (dBuV/m)	Limit (dBuV/m)	Margin (dB)	Remark
1	2389.080	32.18	32.16	64.34	74.00	-9.66	peak
2	2390.000	33.06	32.16	65.22	74.00	-8.78	peak

Test Mode:	802.11g AV	Frequency(MHz):	2412
Polarity:	Horizontal	Test Voltage:	DC 5 V

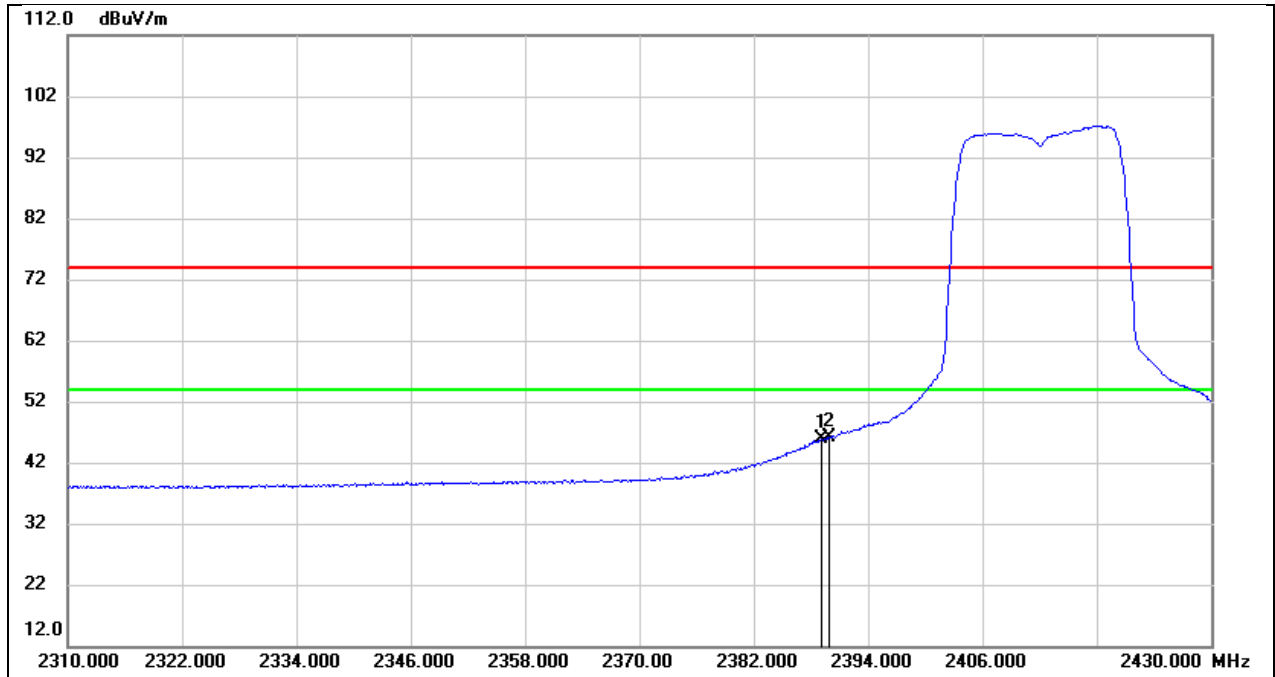

No.	Frequency (MHz)	Reading (dBuV)	Correct (dB/m)	Result (dBuV/m)	Limit (dBuV/m)	Margin (dB)	Remark
1	2389.080	13.64	32.16	45.80	54.00	-8.20	AVG
2	2390.000	14.05	32.16	46.21	54.00	-7.79	AVG

Test Mode:	802.11g PK	Frequency(MHz):	2462
Polarity:	Horizontal	Test Voltage:	DC 5 V

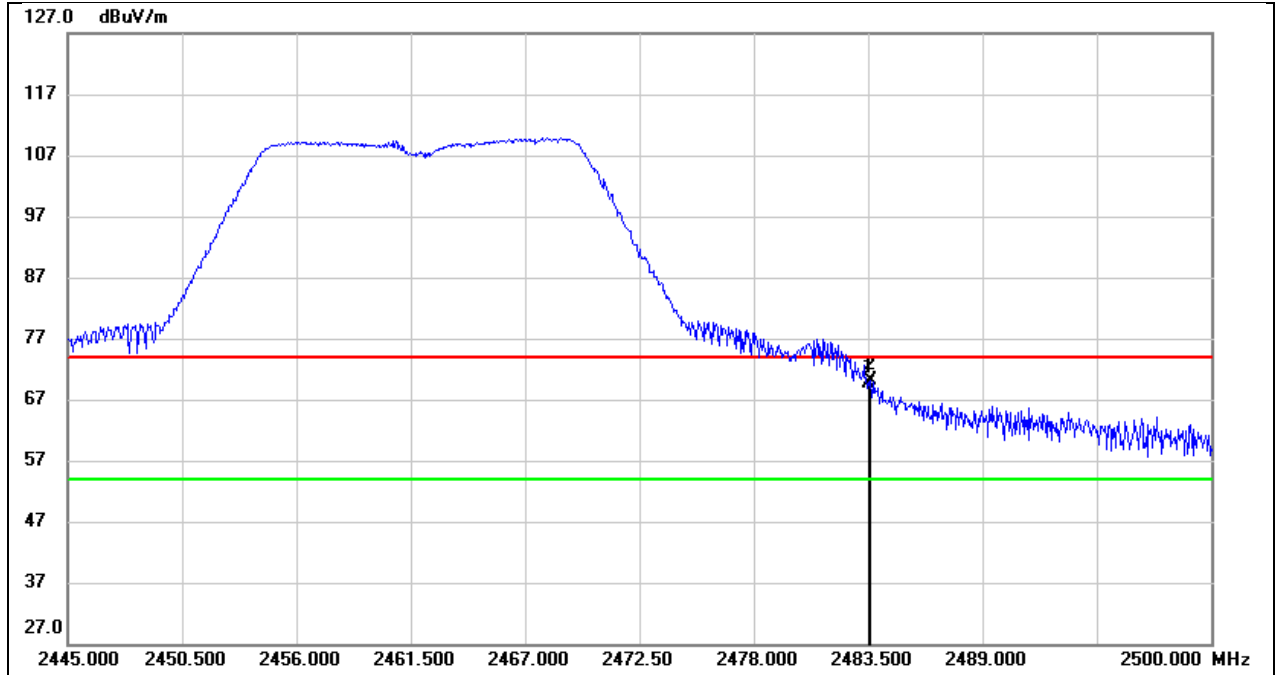

No.	Frequency (MHz)	Reading (dBuV)	Correct (dB/m)	Result (dBuV/m)	Limit (dBuV/m)	Margin (dB)	Remark
1	2483.500	37.24	32.44	69.68	74.00	-4.32	peak
2	2483.610	37.73	32.44	70.17	74.00	-3.83	peak

Test Mode:	802.11g AV	Frequency(MHz):	2462
Polarity:	Horizontal	Test Voltage:	DC 5 V

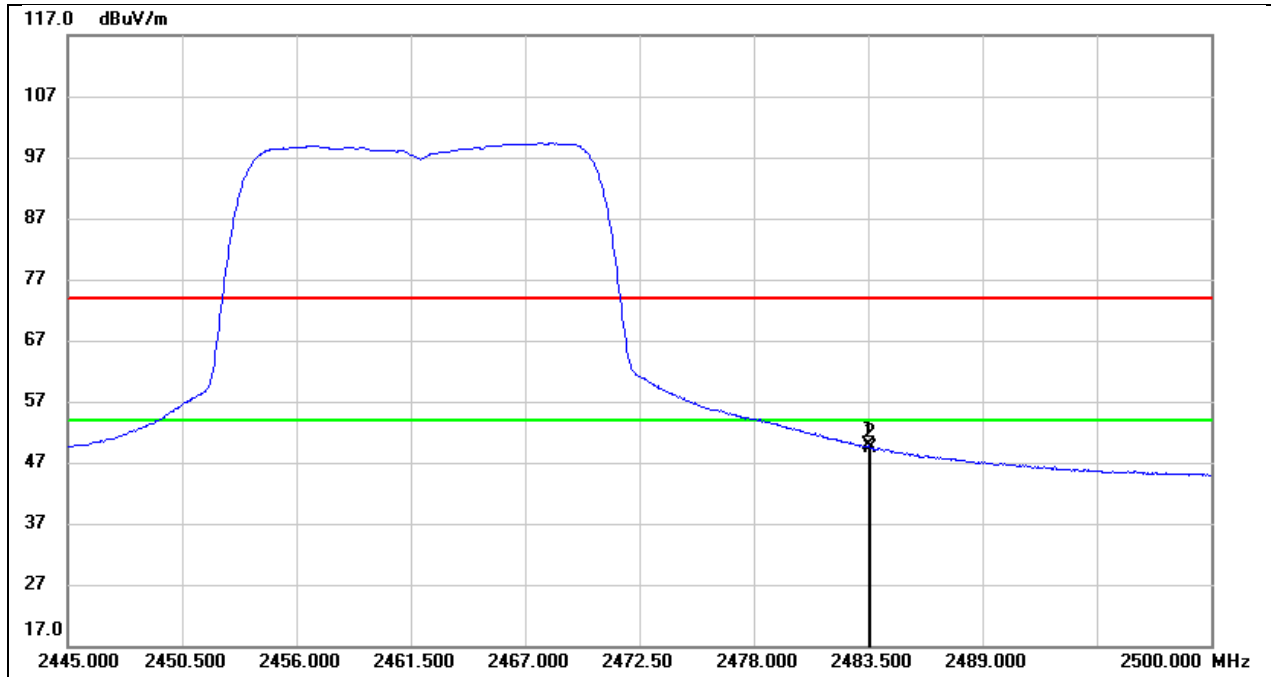

No.	Frequency (MHz)	Reading (dBuV)	Correct (dB/m)	Result (dBuV/m)	Limit (dBuV/m)	Margin (dB)	Remark
1	2483.500	17.34	32.44	49.78	54.00	-4.22	AVG
2	2483.610	16.99	32.44	49.43	54.00	-4.57	AVG

Test Mode:	802.11n HT20 PK	Frequency(MHz):	2412
Polarity:	Horizontal	Test Voltage:	DC 5 V

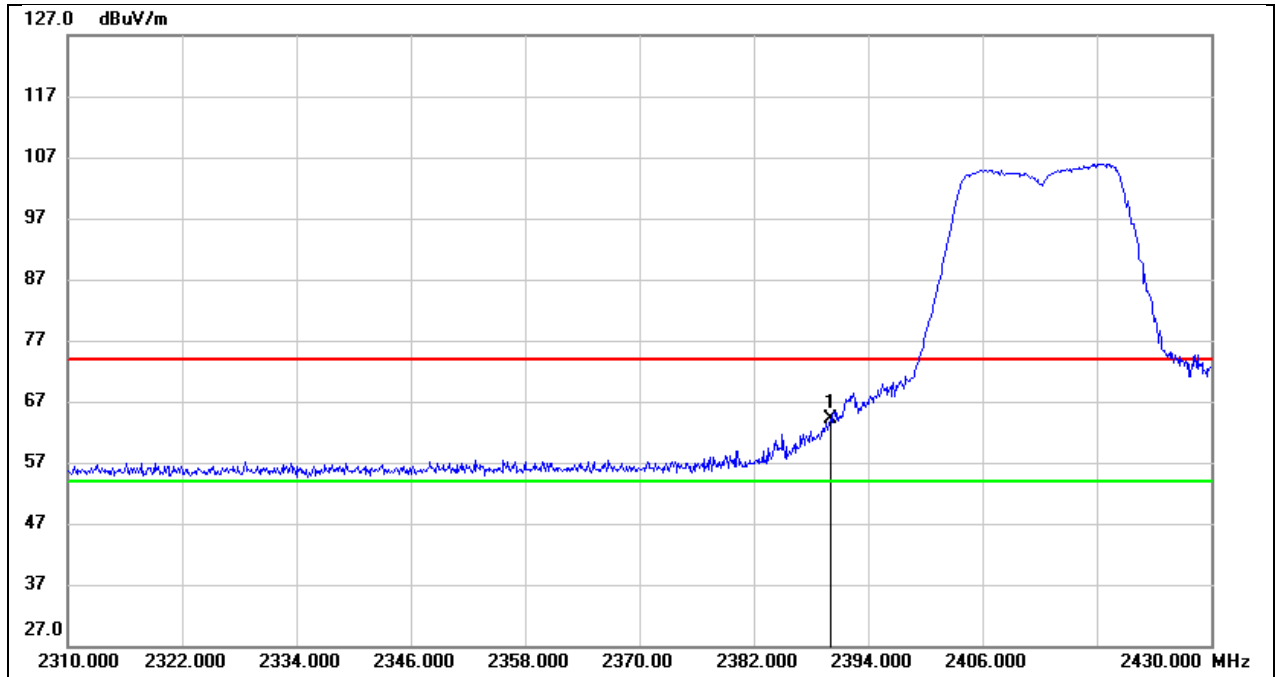

No.	Frequency (MHz)	Reading (dBuV)	Correct (dB/m)	Result (dBuV/m)	Limit (dBuV/m)	Margin (dB)	Remark
1	2390.000	31.93	32.16	64.09	74.00	-9.91	peak

Test Mode:	802.11n HT20 AV	Frequency(MHz):	2412
Polarity:	Horizontal	Test Voltage:	DC 5 V

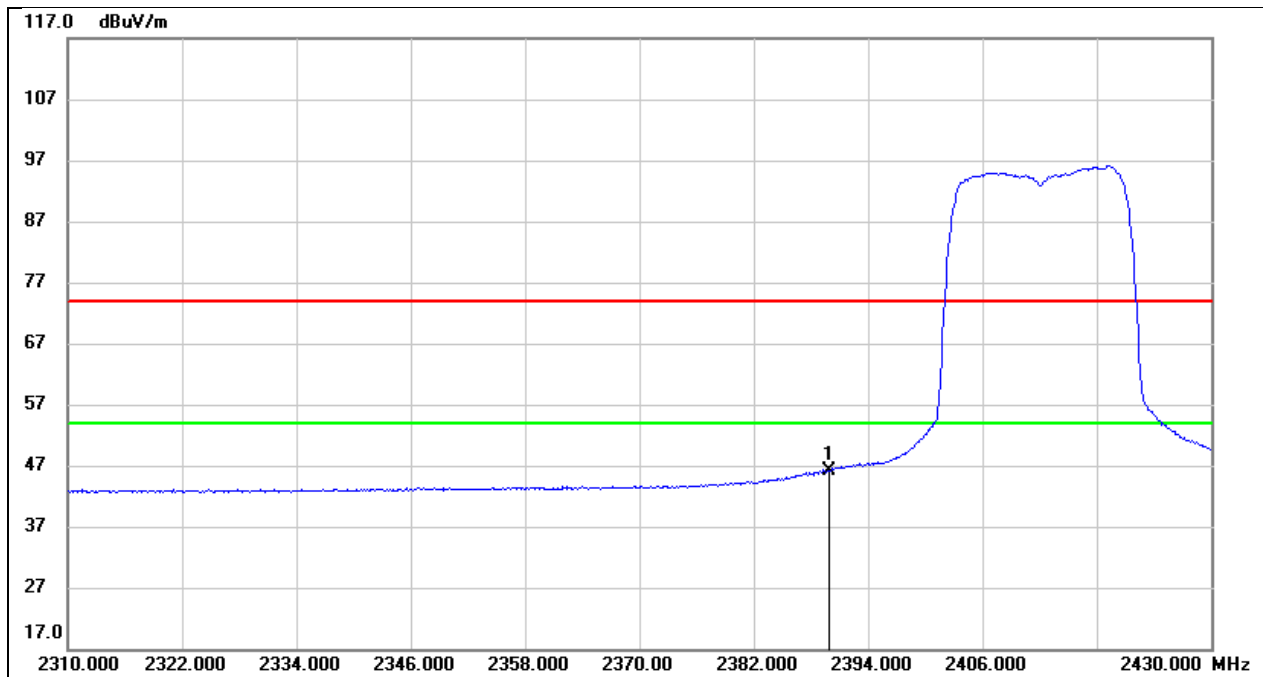

No.	Frequency (MHz)	Reading (dBuV)	Correct (dB/m)	Result (dBuV/m)	Limit (dBuV/m)	Margin (dB)	Remark
1	2390.000	14.02	32.16	46.18	54.00	-7.82	AVG

Test Mode:	802.11n HT20 PK	Frequency(MHz):	2462
Polarity:	Horizontal	Test Voltage:	DC 5 V

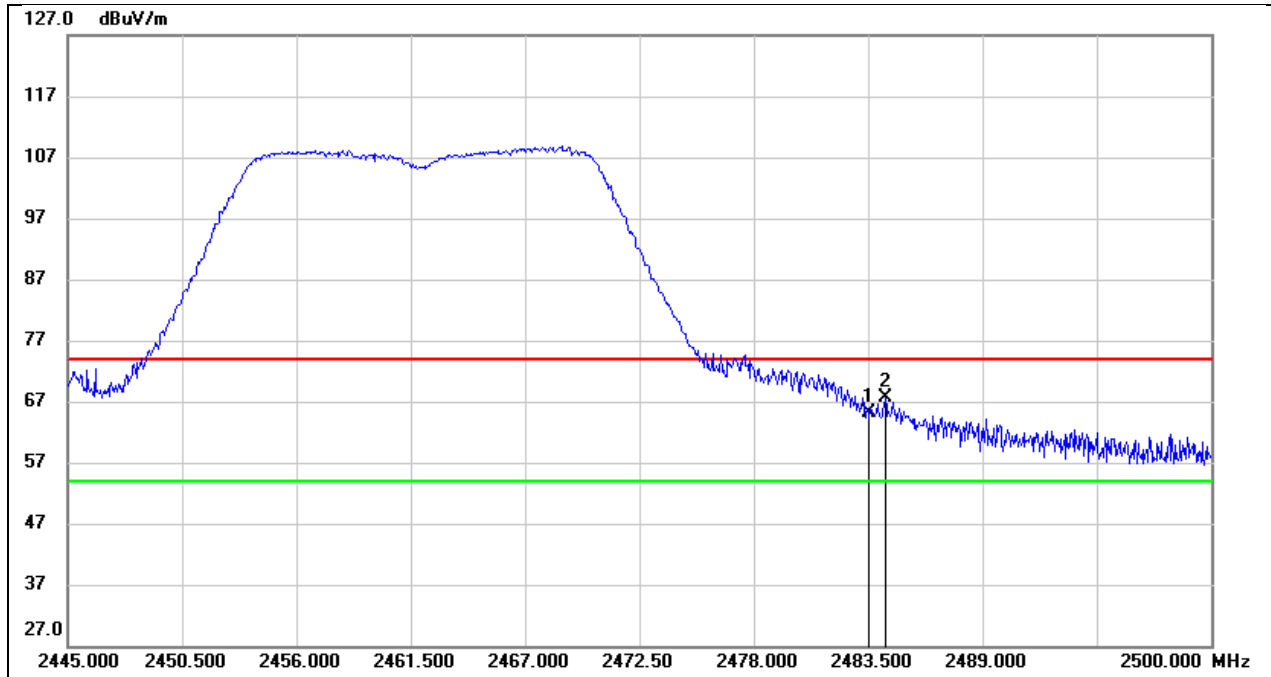

No.	Frequency (MHz)	Reading (dBuV)	Correct (dB/m)	Result (dBuV/m)	Limit (dBuV/m)	Margin (dB)	Remark
1	2483.500	32.68	32.44	65.12	74.00	-8.88	peak
2	2484.325	35.11	32.44	67.55	74.00	-6.45	peak

Test Mode:	802.11n HT20 AV	Frequency(MHz):	2462
Polarity:	Horizontal	Test Voltage:	DC 5 V

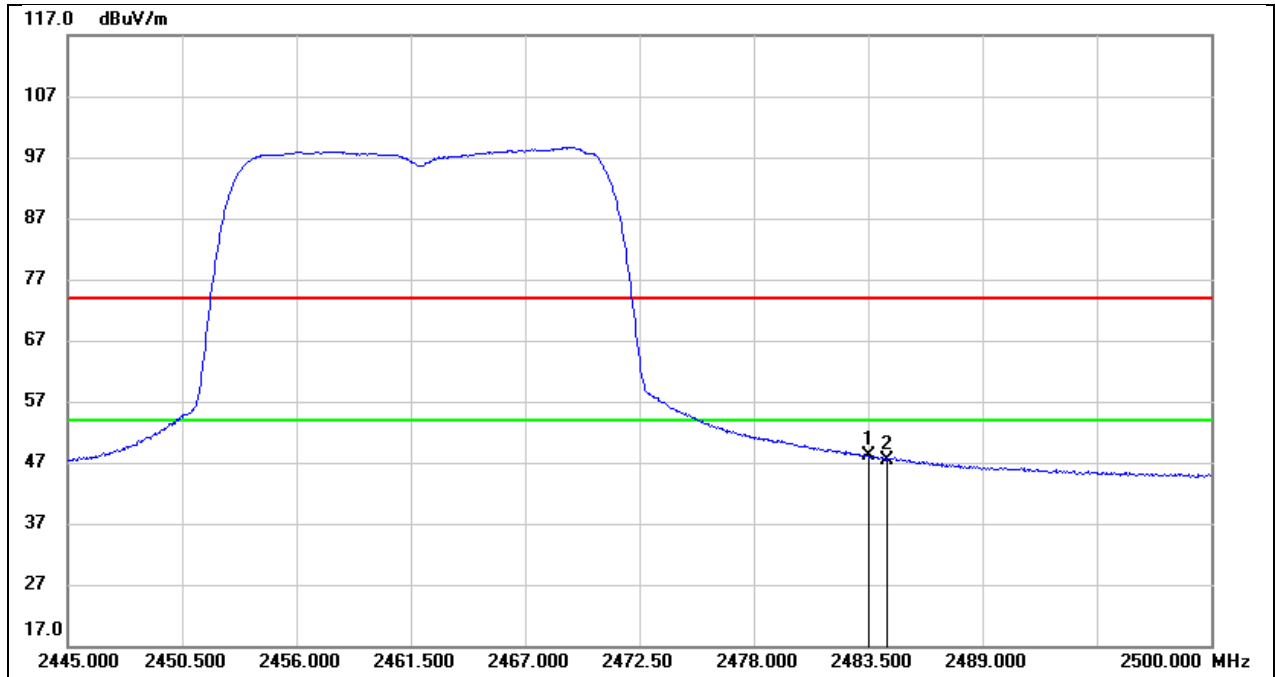

No.	Frequency (MHz)	Reading (dBuV)	Correct (dB/m)	Result (dBuV/m)	Limit (dBuV/m)	Margin (dB)	Remark
1	2483.500	15.74	32.44	48.18	54.00	-5.82	AVG
2	2484.325	15.04	32.44	47.48	54.00	-6.52	AVG

Test Mode:	802.11n HT40 PK	Frequency(MHz):	2422
Polarity:	Horizontal	Test Voltage:	DC 5 V

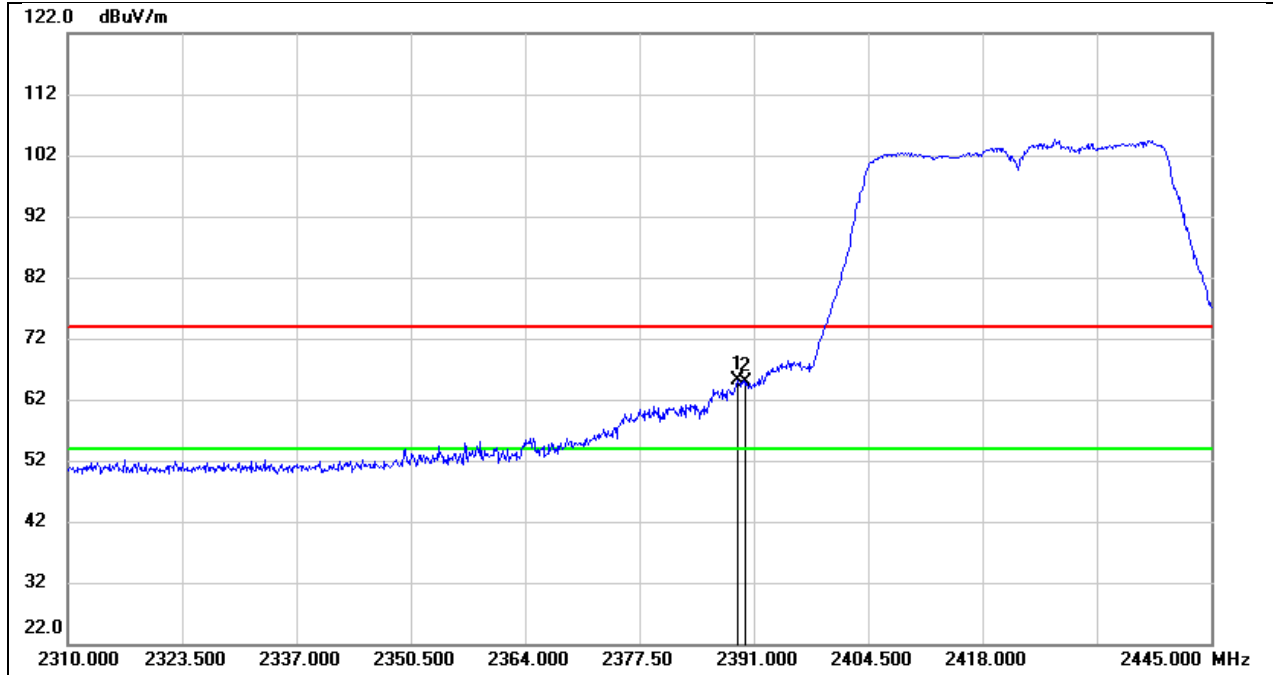

No.	Frequency (MHz)	Reading (dBuV)	Correct (dB/m)	Result (dBuV/m)	Limit (dBuV/m)	Margin (dB)	Remark
1	2389.110	32.85	32.16	65.01	74.00	-8.99	peak
2	2390.000	32.75	32.16	64.91	74.00	-9.09	peak

Test Mode:	802.11n HT40 AV	Frequency(MHz):	2422
Polarity:	Horizontal	Test Voltage:	DC 5 V

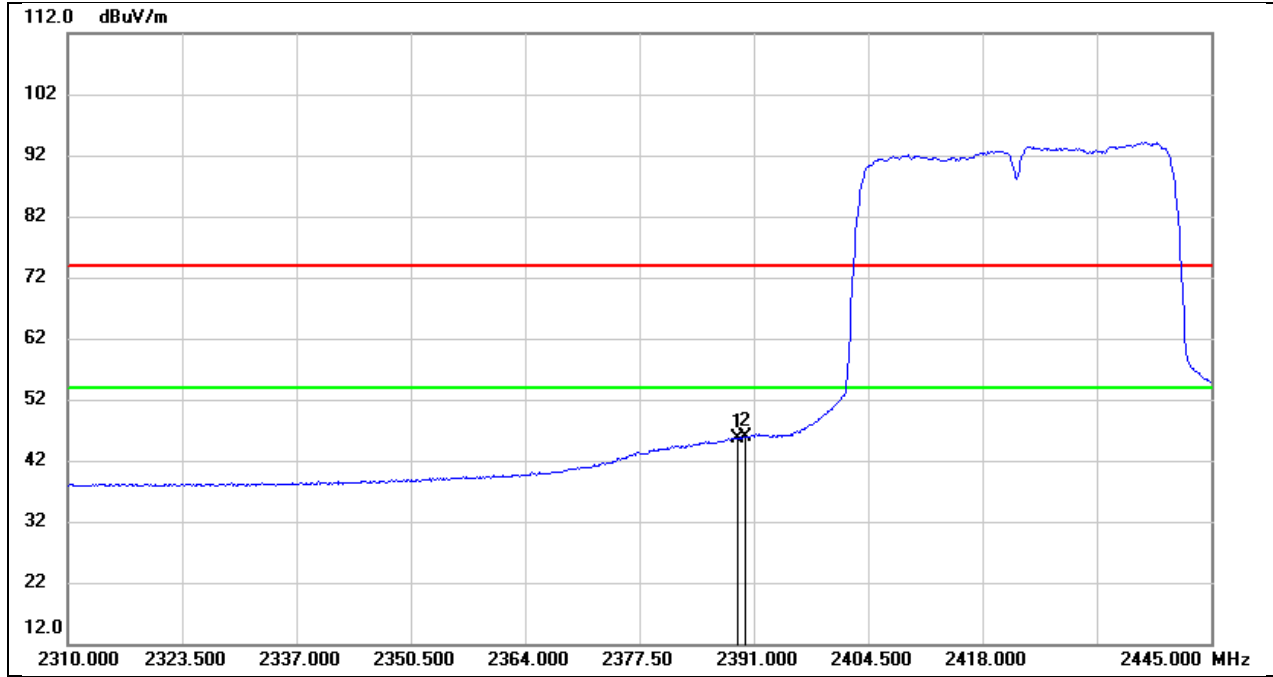

No.	Frequency (MHz)	Reading (dBuV)	Correct (dB/m)	Result (dBuV/m)	Limit (dBuV/m)	Margin (dB)	Remark
1	2389.110	13.49	32.16	45.65	54.00	-8.35	AVG
2	2390.000	13.72	32.16	45.88	54.00	-8.12	AVG

Test Mode:	802.11n HT40 PK	Frequency(MHz):	2452
Polarity:	Horizontal	Test Voltage:	DC 5 V

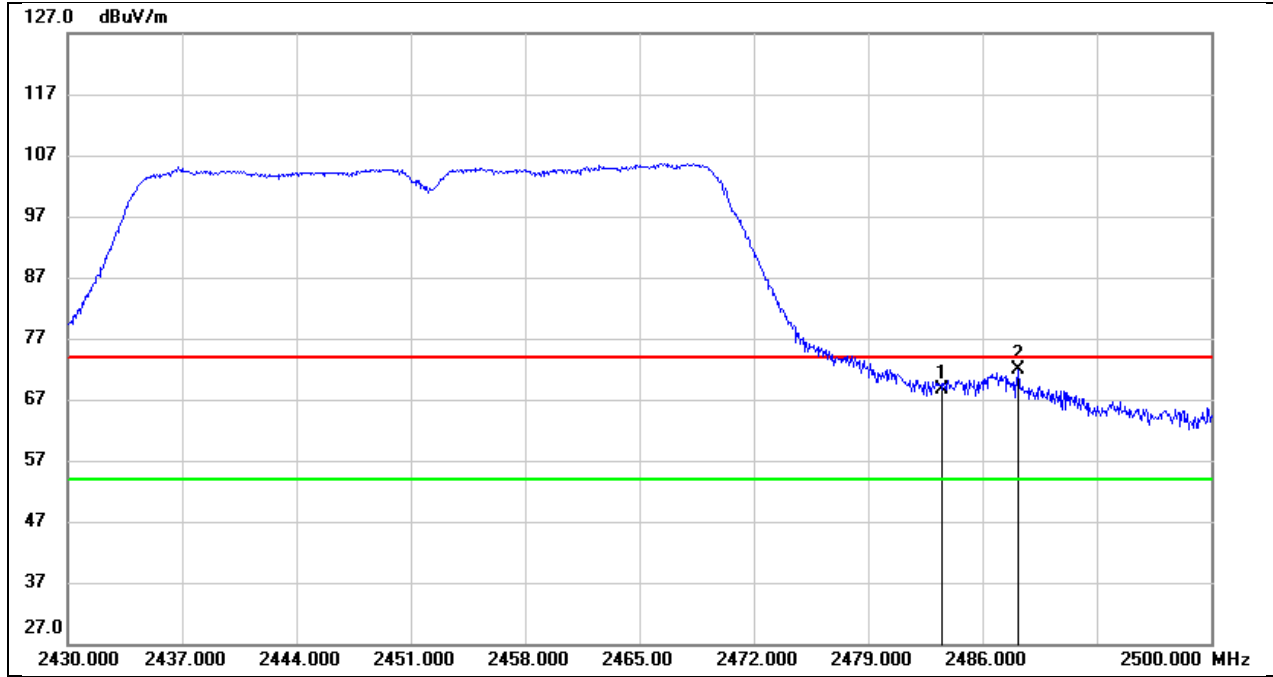

No.	Frequency (MHz)	Reading (dBuV)	Correct (dB/m)	Result (dBuV/m)	Limit (dBuV/m)	Margin (dB)	Remark
1	2483.500	36.08	32.44	68.52	74.00	-5.48	peak
2	2488.170	39.44	32.46	71.90	74.00	-2.10	peak

Test Mode:	802.11n HT40 AV	Frequency(MHz):	2452
Polarity:	Horizontal	Test Voltage:	DC 5 V

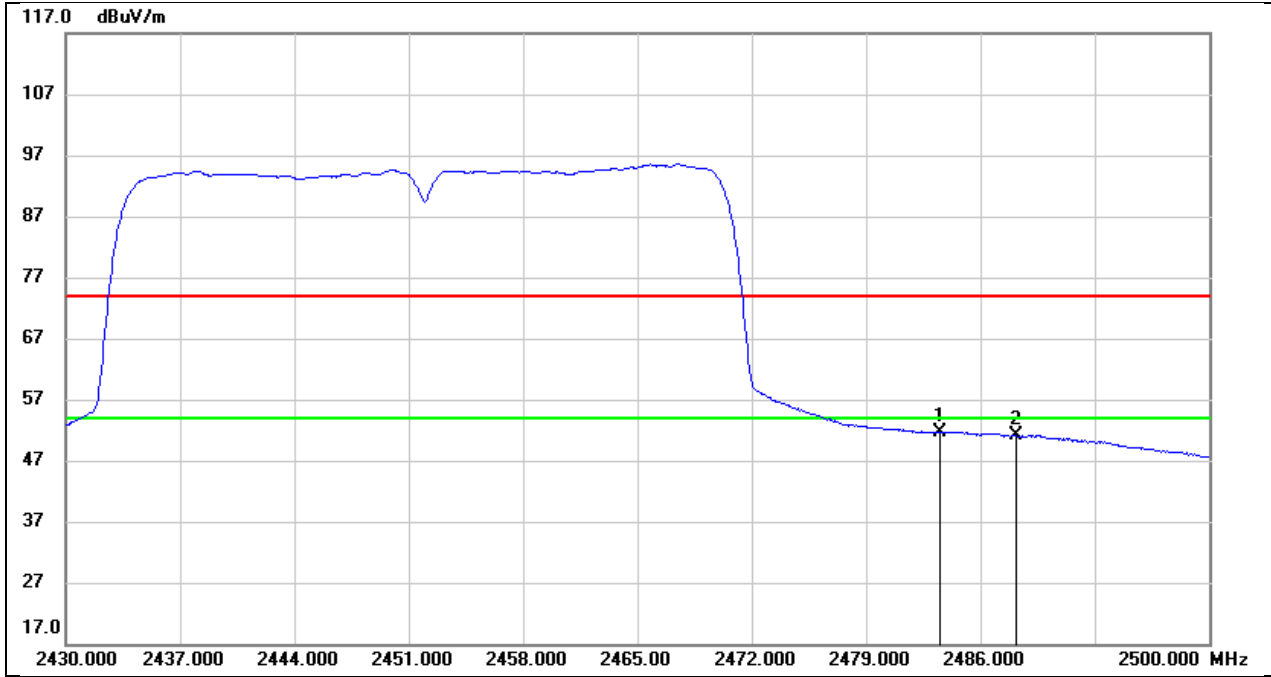

No.	Frequency (MHz)	Reading (dBuV)	Correct (dB/m)	Result (dBuV/m)	Limit (dBuV/m)	Margin (dB)	Remark
1	2483.500	19.19	32.44	51.63	54.00	-2.37	AVG
2	2488.170	18.58	32.46	51.04	54.00	-2.96	AVG

8.2. SPURIOUS EMISSIONS(1 GHZ~3 GHZ)

Test Mode:	802.11b	Frequency(MHz):	2412
Polarity:	Horizontal	Test Voltage:	DC 5 V

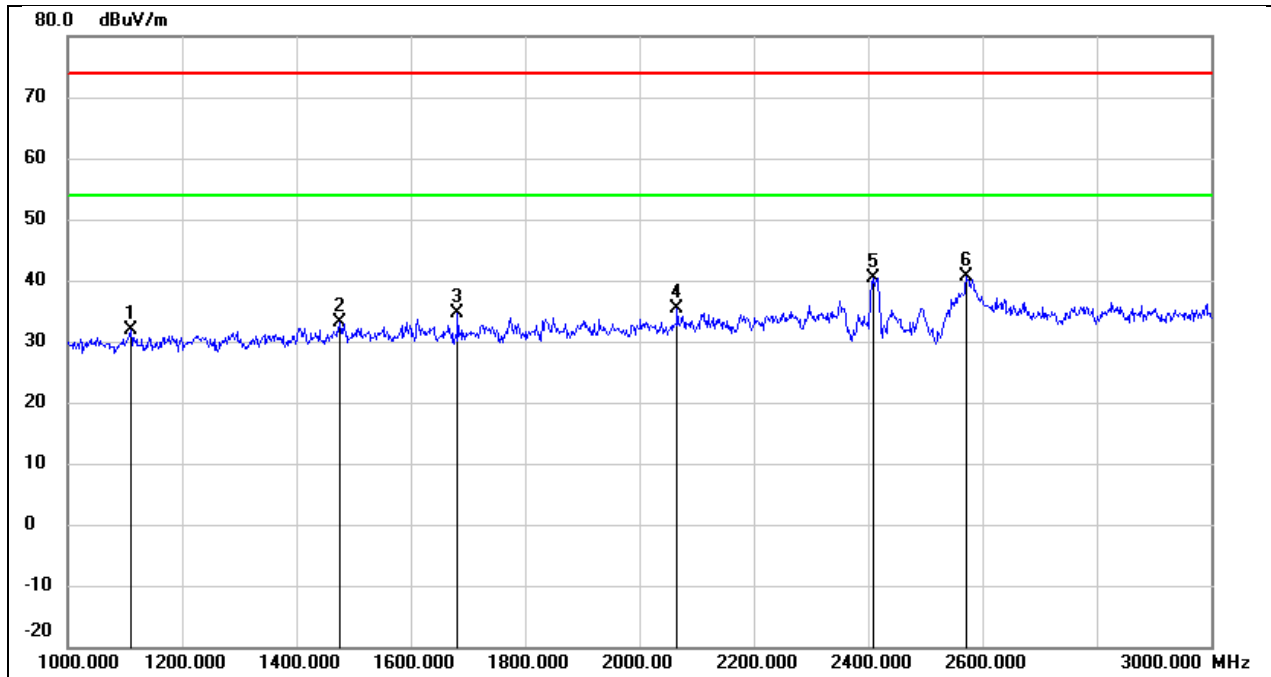

No.	Frequency (MHz)	Reading (dBuV)	Correct (dB/m)	Result (dBuV/m)	Limit (dBuV/m)	Margin (dB)	Remark
1	1110.000	46.30	-14.52	31.78	74.00	-42.22	peak
2	1476.000	46.02	-12.82	33.20	74.00	-40.80	peak
3	1682.000	46.70	-12.11	34.59	74.00	-39.41	peak
4	2066.000	45.98	-10.72	35.26	74.00	-38.74	peak
5	2412.000	49.41	-8.96	40.45	/	/	fundamental
6	2572.000	48.94	-8.27	40.67	74.00	-33.33	peak

Test Mode:	802.11b	Frequency(MHz):	2412
Polarity:	Vertical	Test Voltage:	DC 5 V

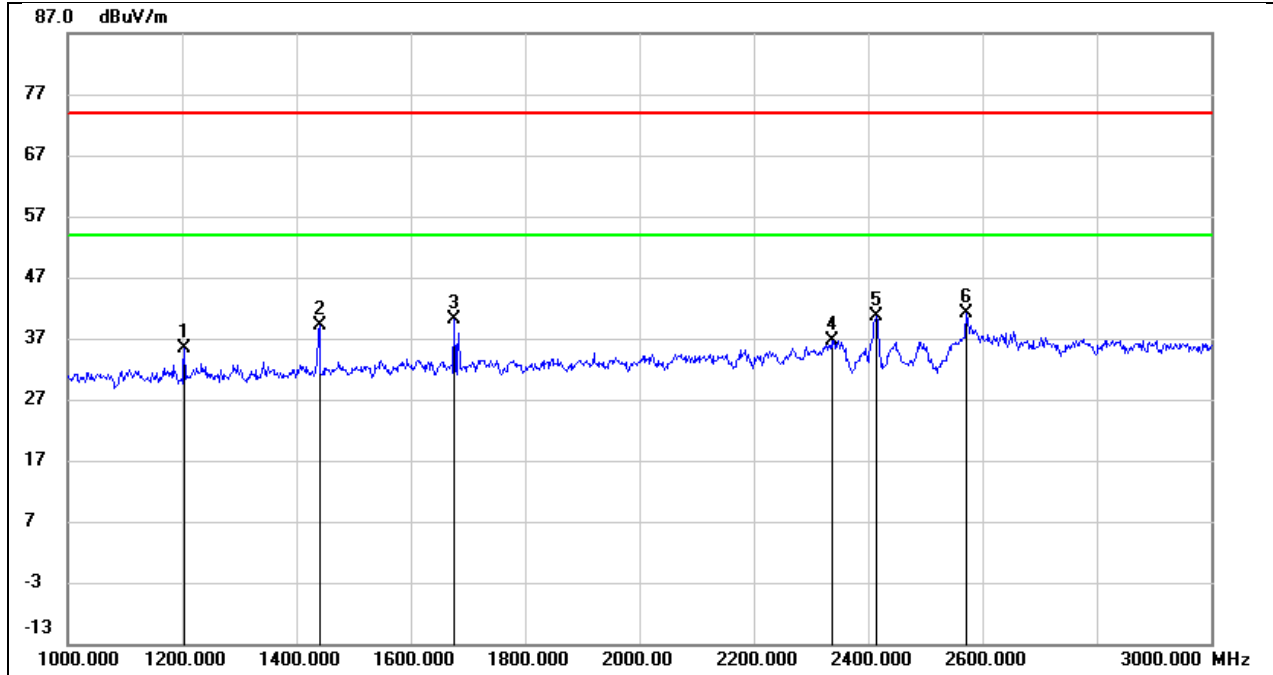

No.	Frequency (MHz)	Reading (dBuV)	Correct (dB/m)	Result (dBuV/m)	Limit (dBuV/m)	Margin (dB)	Remark
1	1204.000	49.38	-14.09	35.29	74.00	-38.71	peak
2	1440.000	52.03	-12.98	39.05	74.00	-34.95	peak
3	1676.000	52.20	-12.13	40.07	74.00	-33.93	peak
4	2336.000	46.02	-9.33	36.69	74.00	-37.31	peak
5	2412.000	49.50	-8.93	40.57	/	/	fundamental
6	2572.000	49.34	-8.27	41.07	74.00	-32.93	peak

Test Mode:	802.11b	Frequency(MHz):	2437
Polarity:	Horizontal	Test Voltage:	DC 5 V

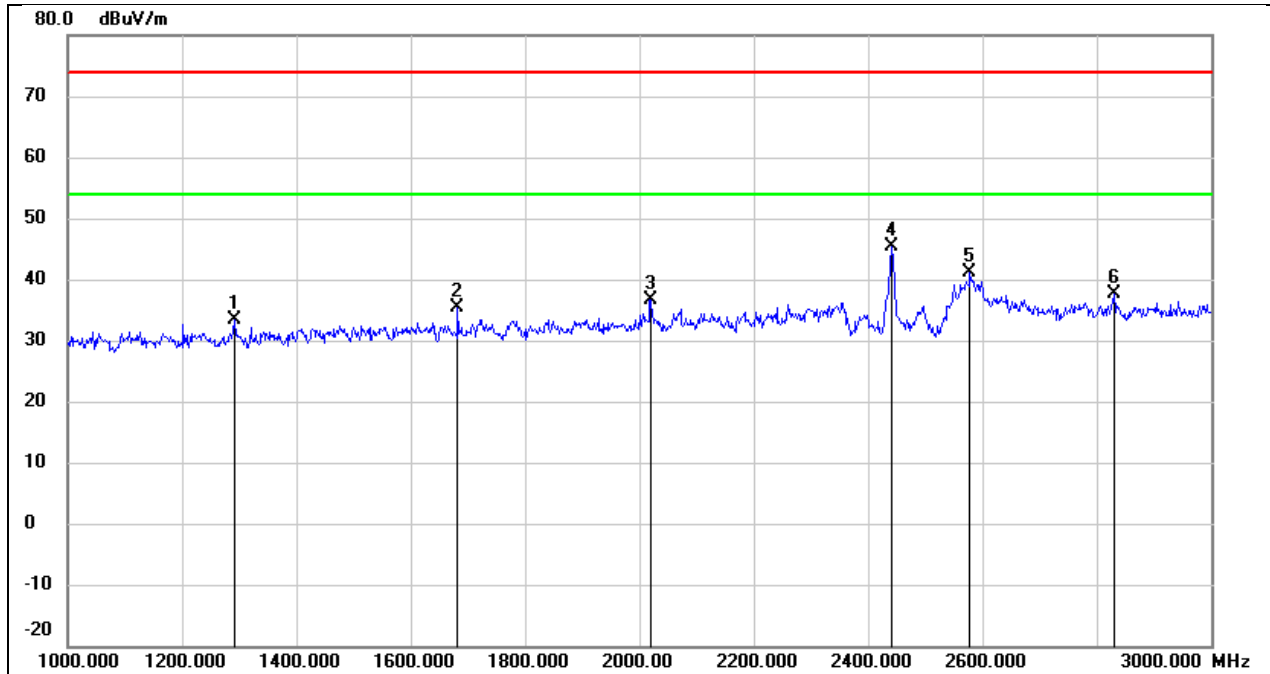

No.	Frequency (MHz)	Reading (dBuV)	Correct (dB/m)	Result (dBuV/m)	Limit (dBuV/m)	Margin (dB)	Remark
1	1292.000	47.14	-13.68	33.46	74.00	-40.54	peak
2	1682.000	47.46	-12.11	35.35	74.00	-38.65	peak
3	2020.000	47.68	-10.96	36.72	74.00	-37.28	peak
4	2437.000	54.13	-8.79	45.34	/	/	fundamental
5	2578.000	49.50	-8.26	41.24	74.00	-32.76	peak
6	2830.000	45.13	-7.50	37.63	74.00	-36.37	peak

Test Mode:	802.11b	Frequency(MHz):	2437
Polarity:	Vertical	Test Voltage:	DC 5 V

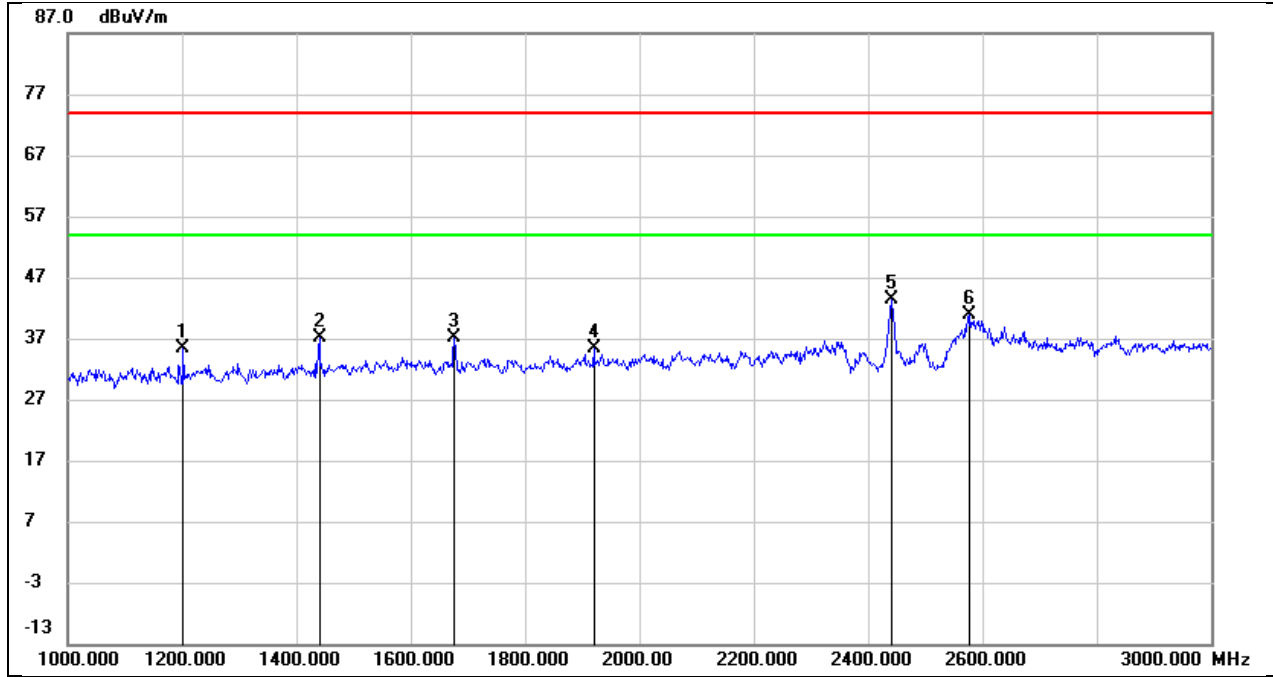

No.	Frequency (MHz)	Reading (dBuV)	Correct (dB/m)	Result (dBuV/m)	Limit (dBuV/m)	Margin (dB)	Remark
1	1202.000	49.57	-14.09	35.48	74.00	-38.52	peak
2	1440.000	50.01	-12.98	37.03	74.00	-36.97	peak
3	1676.000	49.32	-12.13	37.19	74.00	-36.81	peak
4	1920.000	46.73	-11.32	35.41	74.00	-38.59	peak
5	2437.000	52.07	-8.79	43.28	/	/	fundamental
6	2578.000	49.22	-8.26	40.96	74.00	-33.04	peak

Test Mode:	802.11b	Frequency(MHz):	2462
Polarity:	Horizontal	Test Voltage:	DC 5 V

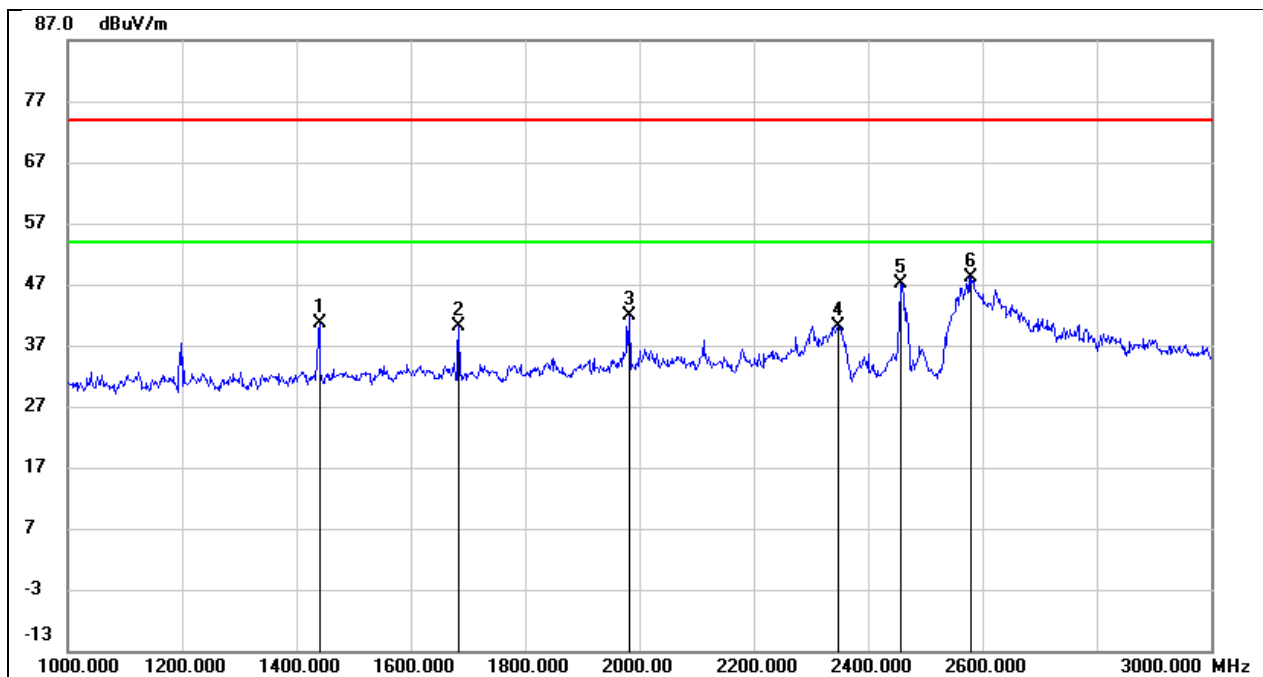

No.	Frequency (MHz)	Reading (dBuV)	Correct (dB/m)	Result (dBuV/m)	Limit (dBuV/m)	Margin (dB)	Remark
1	1440.000	53.71	-12.98	40.73	74.00	-33.27	peak
2	1684.000	52.28	-12.10	40.18	74.00	-33.82	peak
3	1982.000	52.98	-11.12	41.86	74.00	-32.14	peak
4	2348.000	49.44	-9.28	40.16	74.00	-33.84	peak
5	2462.000	55.84	-8.71	47.13	/	/	fundamental
6	2580.000	56.50	-8.25	48.25	74.00	-25.75	peak

Test Mode:	802.11b	Frequency(MHz):	2462
Polarity:	Vertical	Test Voltage:	DC 5 V

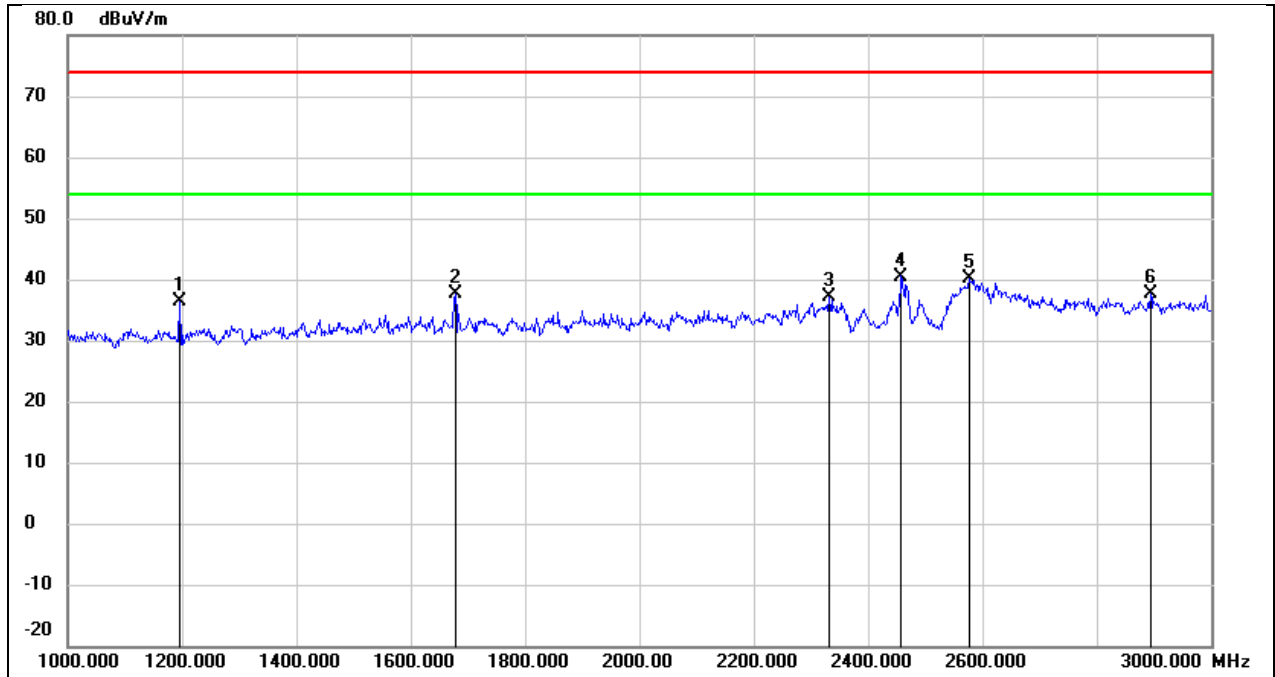

No.	Frequency (MHz)	Reading (dBuV)	Correct (dB/m)	Result (dBuV/m)	Limit (dBuV/m)	Margin (dB)	Remark
1	1196.000	50.43	-14.12	36.31	74.00	-37.69	peak
2	1678.000	49.83	-12.12	37.71	74.00	-36.29	peak
3	2332.000	46.40	-9.36	37.04	74.00	-36.96	peak
4	2462.000	49.21	-8.71	40.50	/	/	fundamental
5	2576.000	48.44	-8.26	40.18	74.00	-33.82	peak
6	2894.000	44.86	-7.30	37.56	74.00	-36.44	peak

8.3. SPURIOUS EMISSIONS(3 GHZ~18 GHZ)

Test Mode:	802.11b	Frequency(MHz):	2412
Polarity:	Horizontal	Test Voltage:	DC 5 V

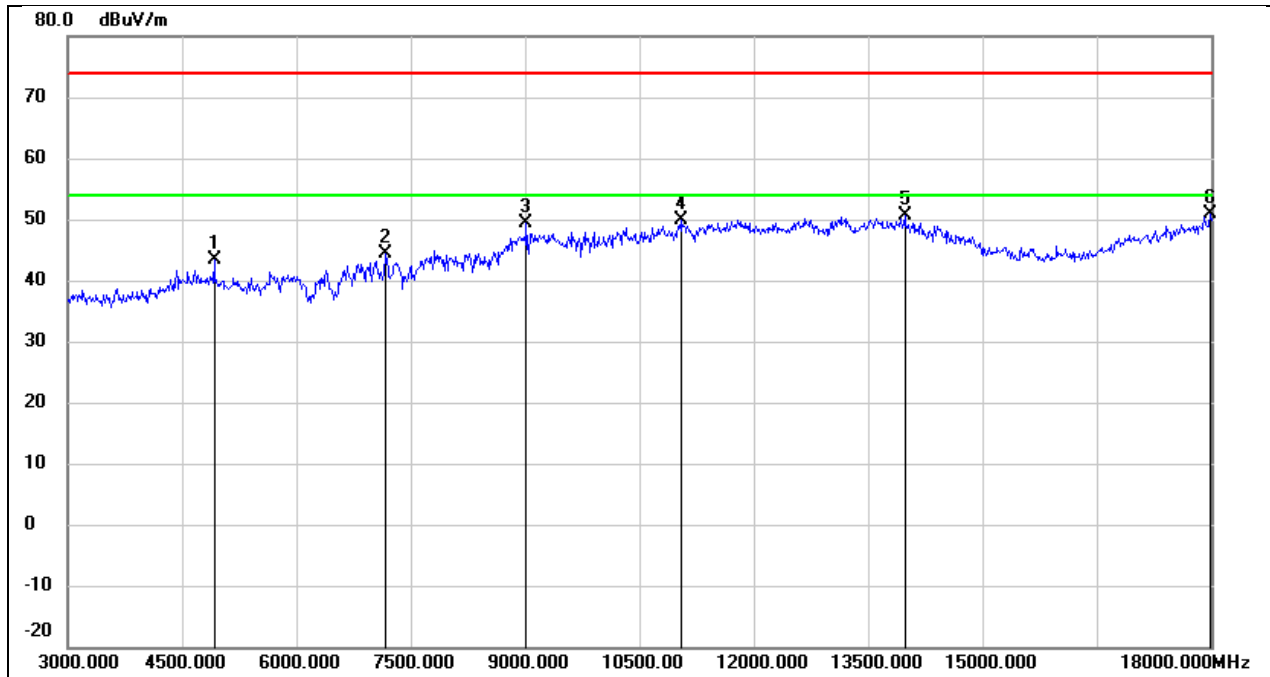

No.	Frequency (MHz)	Reading (dBuV)	Correct (dB/m)	Result (dBuV/m)	Limit (dBuV/m)	Margin (dB)	Remark
1	4920.000	43.13	0.14	43.27	74.00	-30.73	peak
2	7170.000	37.88	6.56	44.44	74.00	-29.56	peak
3	9015.000	38.87	10.49	49.36	74.00	-24.64	peak
4	11055.000	34.94	14.96	49.90	74.00	-24.10	peak
5	13980.000	28.70	21.92	50.62	74.00	-23.38	peak
6	17985.000	25.25	25.60	50.85	74.00	-23.15	peak

Test Mode:	802.11b	Frequency(MHz):	2412
Polarity:	Vertical	Test Voltage:	DC 5 V

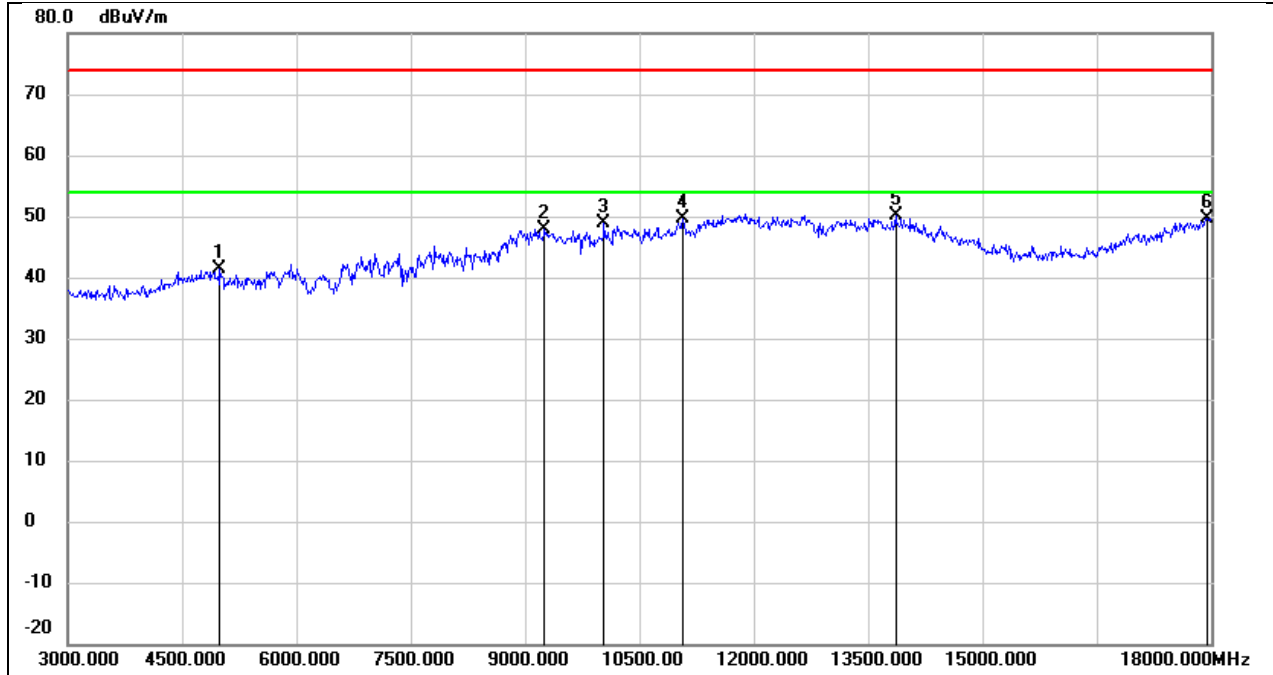

No.	Frequency (MHz)	Reading (dBuV)	Correct (dB/m)	Result (dBuV/m)	Limit (dBuV/m)	Margin (dB)	Remark
1	4995.000	41.02	0.43	41.45	74.00	-32.55	peak
2	9255.000	37.25	10.59	47.84	74.00	-26.16	peak
3	10035.000	36.68	12.08	48.76	74.00	-25.24	peak
4	11070.000	34.50	15.03	49.53	74.00	-24.47	peak
5	13860.000	28.36	21.67	50.03	74.00	-23.97	peak
6	17955.000	24.28	25.42	49.70	74.00	-24.30	peak

Test Mode:	802.11b	Frequency(MHz):	2437
Polarity:	Horizontal	Test Voltage:	DC 5 V

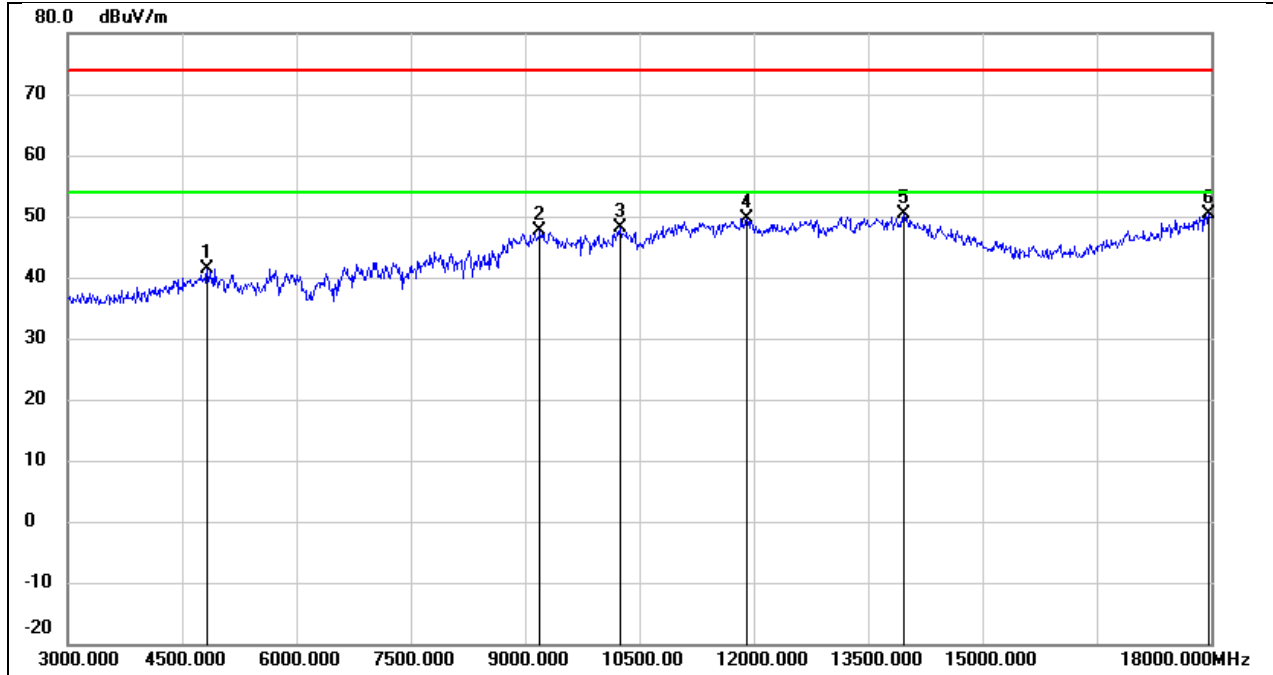

No.	Frequency (MHz)	Reading (dBuV)	Correct (dB/m)	Result (dBuV/m)	Limit (dBuV/m)	Margin (dB)	Remark
1	4830.000	41.55	-0.20	41.35	74.00	-32.65	peak
2	9195.000	36.99	10.56	47.55	74.00	-26.45	peak
3	10245.000	35.65	12.48	48.13	74.00	-25.87	peak
4	11910.000	31.83	17.72	49.55	74.00	-24.45	peak
5	13965.000	28.47	21.89	50.36	74.00	-23.64	peak
6	17970.000	24.85	25.51	50.36	74.00	-23.64	peak

Test Mode:	802.11b	Frequency(MHz):	2437
Polarity:	Vertical	Test Voltage:	DC 5 V

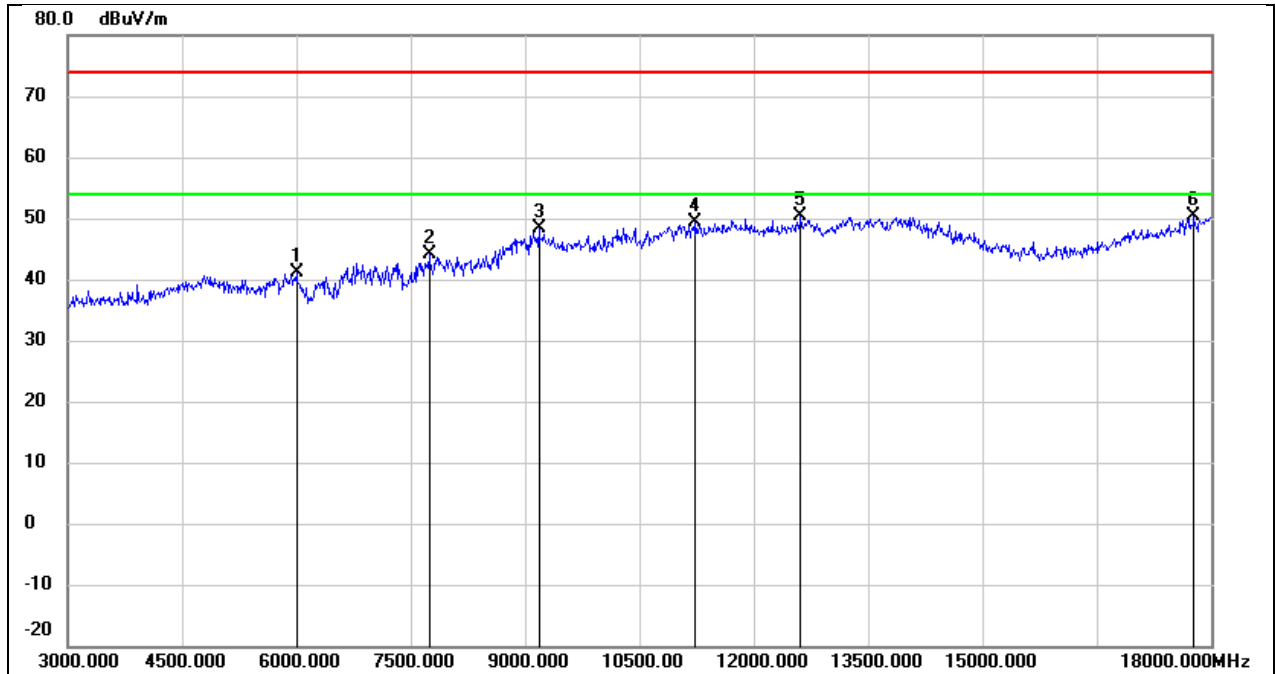

No.	Frequency (MHz)	Reading (dBuV)	Correct (dB/m)	Result (dBuV/m)	Limit (dBuV/m)	Margin (dB)	Remark
1	6000.000	38.78	2.25	41.03	74.00	-32.97	peak
2	7740.000	37.74	6.32	44.06	74.00	-29.94	peak
3	9180.000	37.70	10.56	48.26	74.00	-25.74	peak
4	11235.000	33.71	15.63	49.34	74.00	-24.66	peak
5	12615.000	32.56	17.86	50.42	74.00	-23.58	peak
6	17775.000	25.91	24.36	50.27	74.00	-23.73	peak

Test Mode:	802.11b	Frequency(MHz):	2462
Polarity:	Horizontal	Test Voltage:	DC 5 V

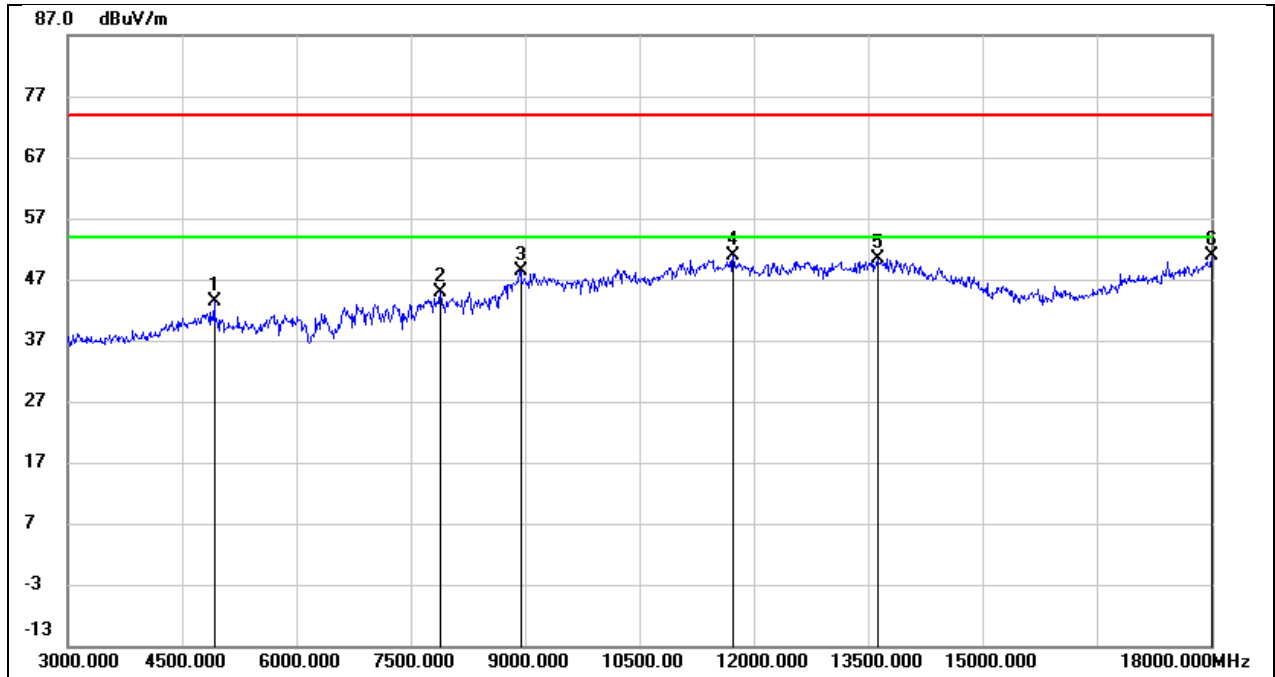

No.	Frequency (MHz)	Reading (dBuV)	Correct (dB/m)	Result (dBuV/m)	Limit (dBuV/m)	Margin (dB)	Remark
1	4920.000	43.34	0.14	43.48	74.00	-30.52	peak
2	7890.000	38.69	6.31	45.00	74.00	-29.00	peak
3	8940.000	38.28	10.04	48.32	74.00	-25.68	peak
4	11730.000	33.58	17.22	50.80	74.00	-23.20	peak
5	13620.000	29.27	21.15	50.42	74.00	-23.58	peak
6	18000.000	25.12	25.69	50.81	74.00	-23.19	peak

Test Mode:	802.11b	Frequency(MHz):	2462
Polarity:	Vertical	Test Voltage:	DC 5 V

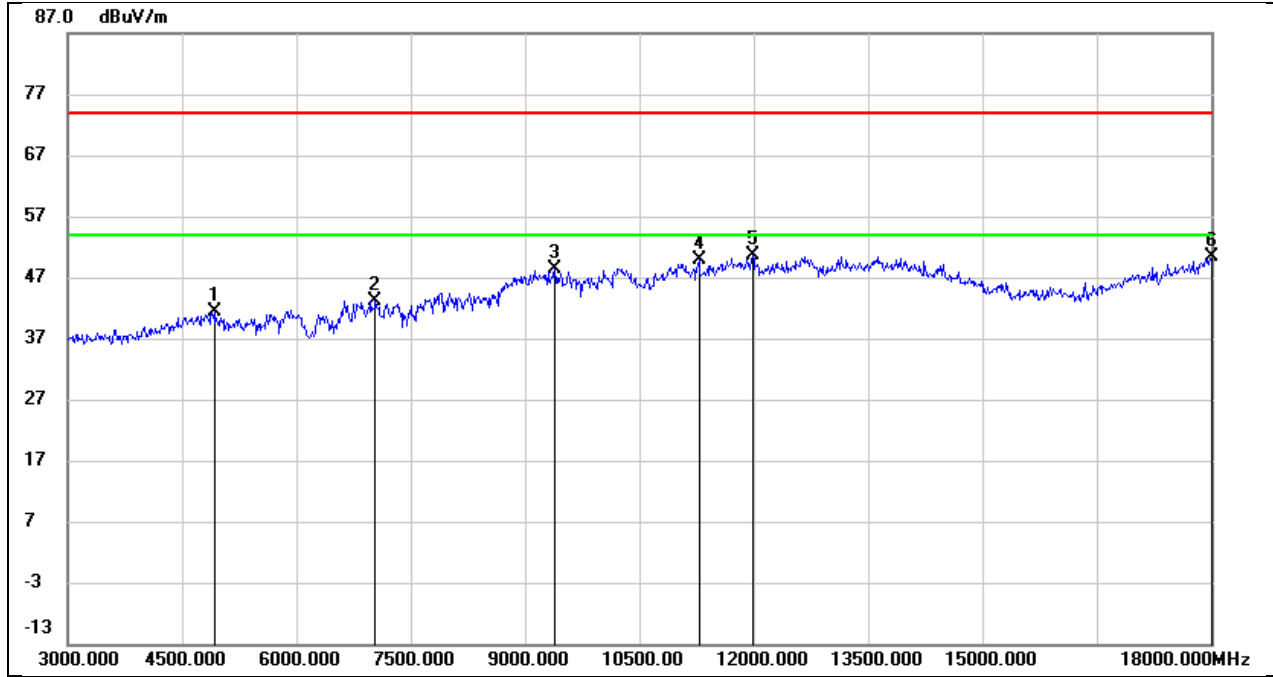

No.	Frequency (MHz)	Reading (dBuV)	Correct (dB/m)	Result (dBuV/m)	Limit (dBuV/m)	Margin (dB)	Remark
1	4920.000	41.27	0.14	41.41	74.00	-32.59	peak
2	7035.000	36.55	6.67	43.22	74.00	-30.78	peak
3	9390.000	37.82	10.64	48.46	74.00	-25.54	peak
4	11280.000	34.13	15.80	49.93	74.00	-24.07	peak
5	11985.000	32.80	17.92	50.72	74.00	-23.28	peak
6	18000.000	24.67	25.69	50.36	74.00	-23.64	peak

Test Mode:	802.11g	Frequency(MHz):	2412
Polarity:	Horizontal	Test Voltage:	DC 5 V

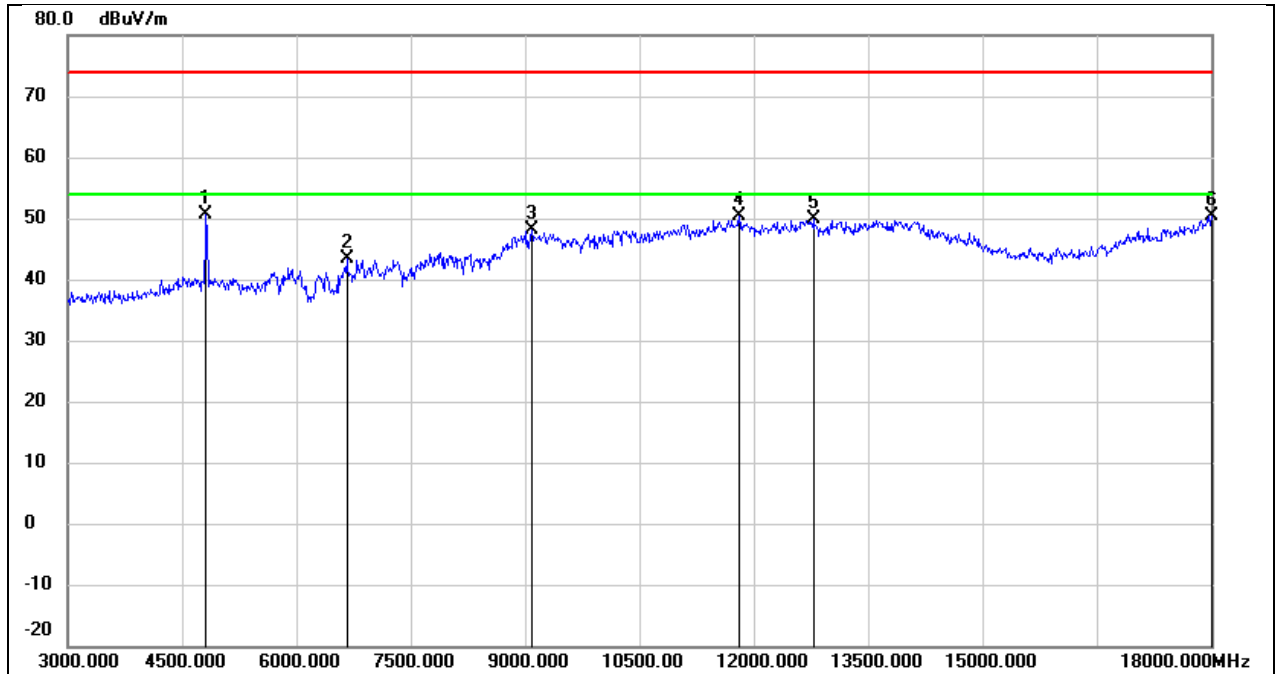

No.	Frequency (MHz)	Reading (dBuV)	Correct (dB/m)	Result (dBuV/m)	Limit (dBuV/m)	Margin (dB)	Remark
1	4815.000	50.81	-0.26	50.55	74.00	-23.45	peak
2	6660.000	38.28	5.02	43.30	74.00	-30.70	peak
3	9090.000	37.51	10.51	48.02	74.00	-25.98	peak
4	11805.000	32.89	17.43	50.32	74.00	-23.68	peak
5	12780.000	31.68	18.24	49.92	74.00	-24.08	peak
6	18000.000	24.81	25.69	50.50	74.00	-23.50	peak

Test Mode:	802.11g	Frequency(MHz):	2412
Polarity:	Vertical	Test Voltage:	DC 5 V

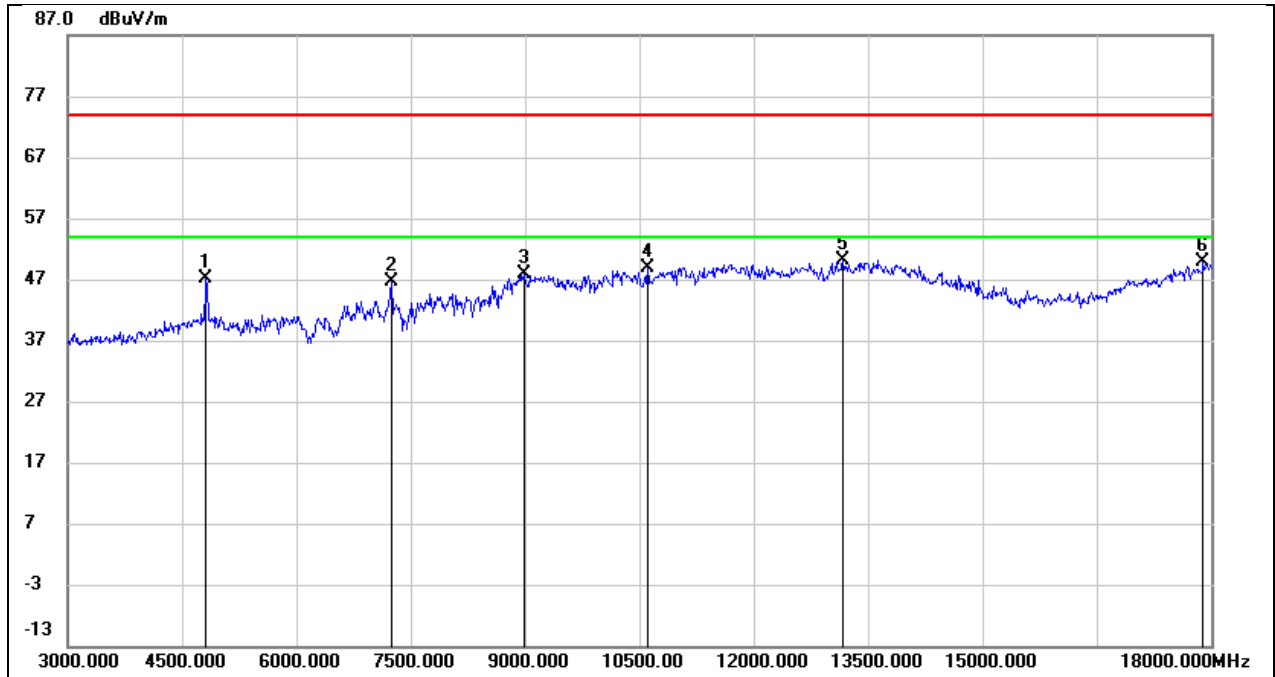

No.	Frequency (MHz)	Reading (dBuV)	Correct (dB/m)	Result (dBuV/m)	Limit (dBuV/m)	Margin (dB)	Remark
1	4815.000	47.44	-0.26	47.18	74.00	-26.82	peak
2	7245.000	40.03	6.51	46.54	74.00	-27.46	peak
3	8985.000	37.60	10.37	47.97	74.00	-26.03	peak
4	10605.000	35.54	13.37	48.91	74.00	-25.09	peak
5	13170.000	30.60	19.46	50.06	74.00	-23.94	peak
6	17895.000	24.77	25.07	49.84	74.00	-24.16	peak

Test Mode:	802.11g	Frequency(MHz):	2437
Polarity:	Horizontal	Test Voltage:	DC 5 V

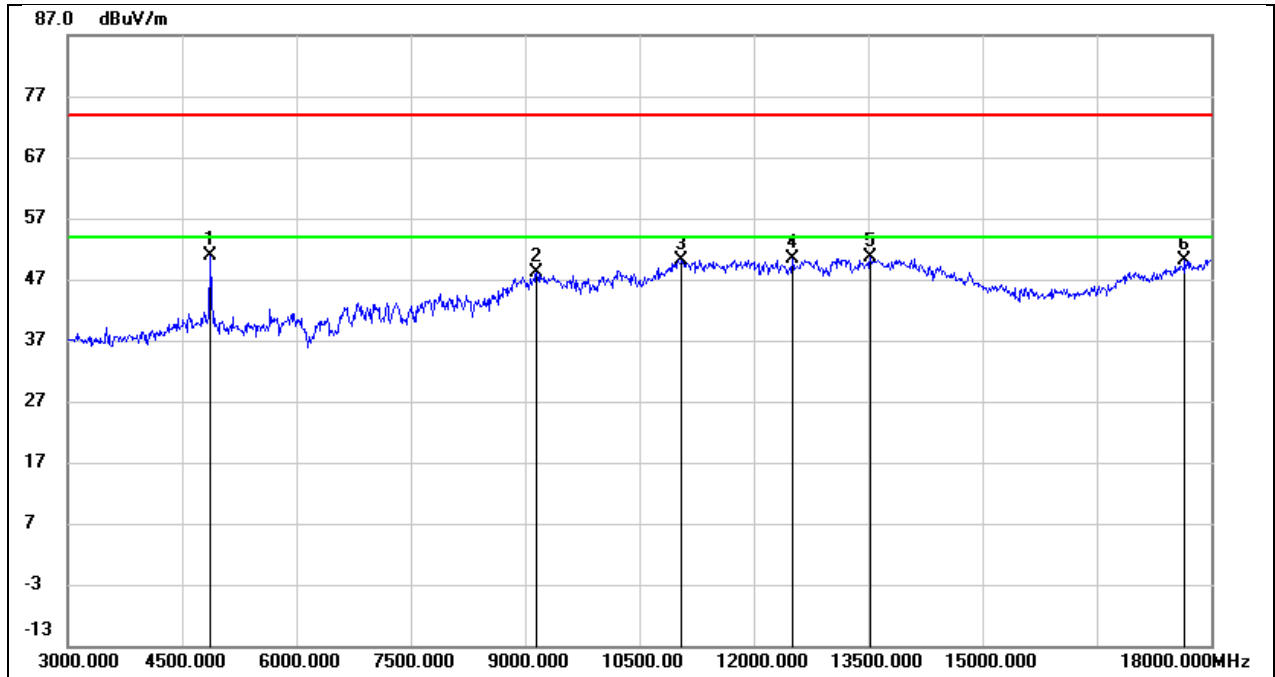

No.	Frequency (MHz)	Reading (dBuV)	Correct (dB/m)	Result (dBuV/m)	Limit (dBuV/m)	Margin (dB)	Remark
1	4875.000	50.94	-0.03	50.91	74.00	-23.09	peak
2	9150.000	37.61	10.54	48.15	74.00	-25.85	peak
3	11055.000	35.26	14.96	50.22	74.00	-23.78	peak
4	12510.000	32.78	17.62	50.40	74.00	-23.60	peak
5	13530.000	29.68	20.96	50.64	74.00	-23.36	peak
6	17655.000	26.52	23.64	50.16	74.00	-23.84	peak

Test Mode:	802.11g	Frequency(MHz):	2437
Polarity:	Vertical	Test Voltage:	DC 5 V

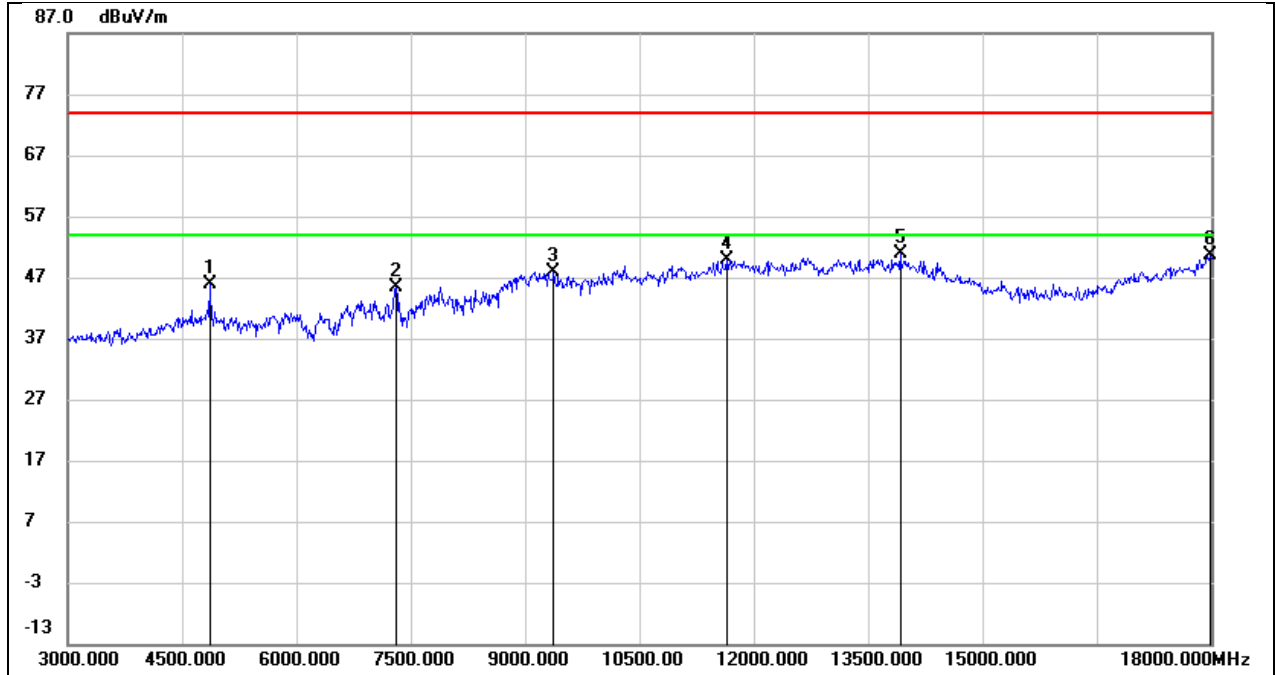

No.	Frequency (MHz)	Reading (dBuV)	Correct (dB/m)	Result (dBuV/m)	Limit (dBuV/m)	Margin (dB)	Remark
1	4860.000	45.96	-0.09	45.87	74.00	-28.13	peak
2	7305.000	38.86	6.47	45.33	74.00	-28.67	peak
3	9375.000	37.18	10.64	47.82	74.00	-26.18	peak
4	11640.000	32.79	16.98	49.77	74.00	-24.23	peak
5	13920.000	29.01	21.79	50.80	74.00	-23.20	peak
6	17985.000	25.05	25.60	50.65	74.00	-23.35	peak

Test Mode:	802.11g	Frequency(MHz):	2462
Polarity:	Horizontal	Test Voltage:	DC 5 V

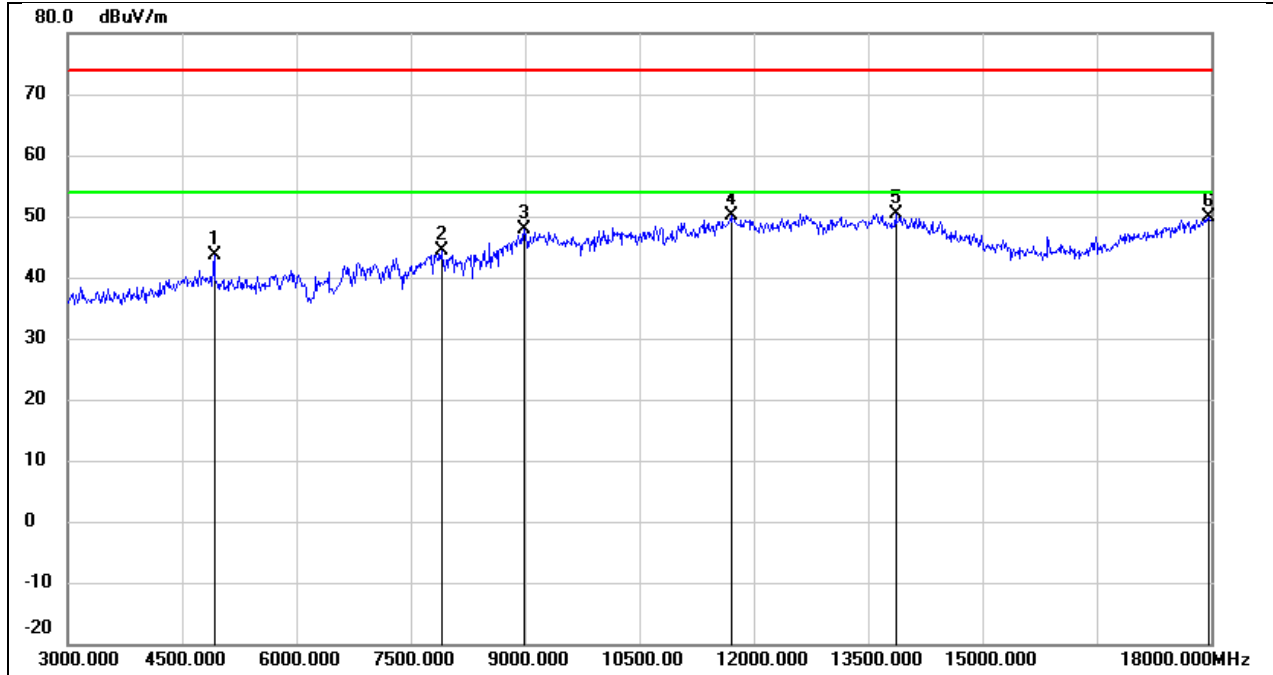

No.	Frequency (MHz)	Reading (dBuV)	Correct (dB/m)	Result (dBuV/m)	Limit (dBuV/m)	Margin (dB)	Remark
1	4920.000	43.43	0.14	43.57	74.00	-30.43	peak
2	7905.000	38.03	6.31	44.34	74.00	-29.66	peak
3	8985.000	37.46	10.37	47.83	74.00	-26.17	peak
4	11715.000	32.87	17.19	50.06	74.00	-23.94	peak
5	13860.000	28.75	21.67	50.42	74.00	-23.58	peak
6	17970.000	24.29	25.51	49.80	74.00	-24.20	peak

Test Mode:	802.11g	Frequency(MHz):	2462
Polarity:	Vertical	Test Voltage:	DC 5 V

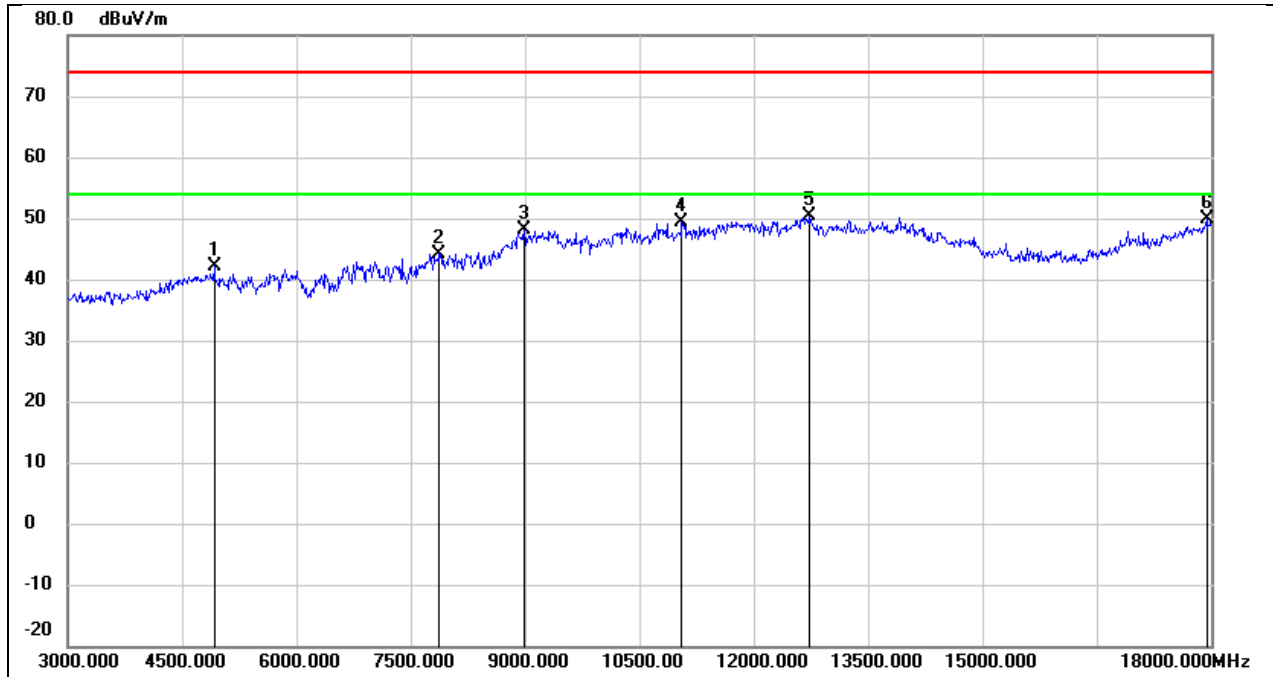

No.	Frequency (MHz)	Reading (dBuV)	Correct (dB/m)	Result (dBuV/m)	Limit (dBuV/m)	Margin (dB)	Remark
1	4920.000	41.95	0.14	42.09	74.00	-31.91	peak
2	7875.000	37.87	6.31	44.18	74.00	-29.82	peak
3	8985.000	37.84	10.37	48.21	74.00	-25.79	peak
4	11055.000	34.37	14.96	49.33	74.00	-24.67	peak
5	12735.000	32.26	18.12	50.38	74.00	-23.62	peak
6	17940.000	24.63	25.34	49.97	74.00	-24.03	peak

Test Mode:	802.11n HT20	Frequency(MHz):	2412
Polarity:	Horizontal	Test Voltage:	DC 5 V

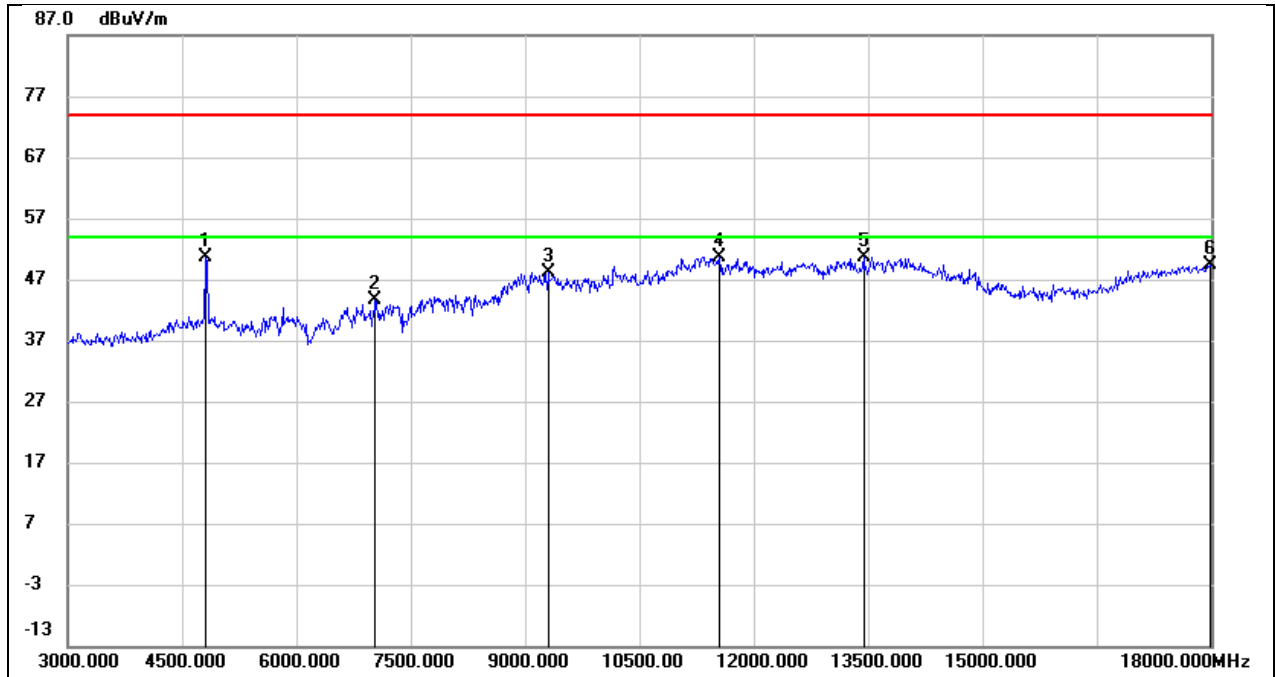

No.	Frequency (MHz)	Reading (dBuV)	Correct (dB/m)	Result (dBuV/m)	Limit (dBuV/m)	Margin (dB)	Remark
1	4815.000	50.87	-0.26	50.61	74.00	-23.39	peak
2	7035.000	37.05	6.67	43.72	74.00	-30.28	peak
3	9300.000	37.54	10.61	48.15	74.00	-25.85	peak
4	11550.000	33.93	16.74	50.67	74.00	-23.33	peak
5	13440.000	29.95	20.64	50.59	74.00	-23.41	peak
6	17985.000	23.89	25.60	49.49	74.00	-24.51	peak

Test Mode:	802.11n HT20	Frequency(MHz):	2412
Polarity:	Vertical	Test Voltage:	DC 5 V

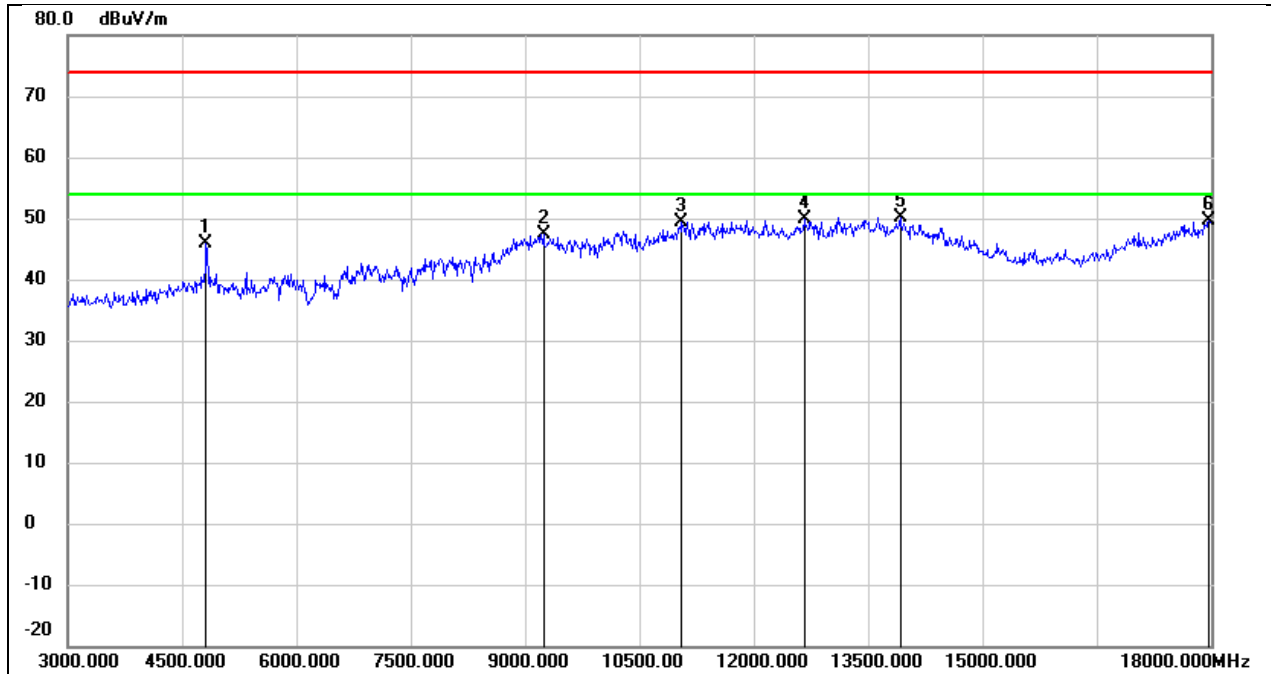

No.	Frequency (MHz)	Reading (dBuV)	Correct (dB/m)	Result (dBuV/m)	Limit (dBuV/m)	Margin (dB)	Remark
1	4815.000	46.20	-0.26	45.94	74.00	-28.06	peak
2	9240.000	36.88	10.58	47.46	74.00	-26.54	peak
3	11055.000	34.46	14.96	49.42	74.00	-24.58	peak
4	12660.000	31.92	17.95	49.87	74.00	-24.13	peak
5	13920.000	28.39	21.79	50.18	74.00	-23.82	peak
6	17970.000	24.10	25.51	49.61	74.00	-24.39	peak

Test Mode:	802.11n HT20	Frequency(MHz):	2437
Polarity:	Horizontal	Test Voltage:	DC 5 V

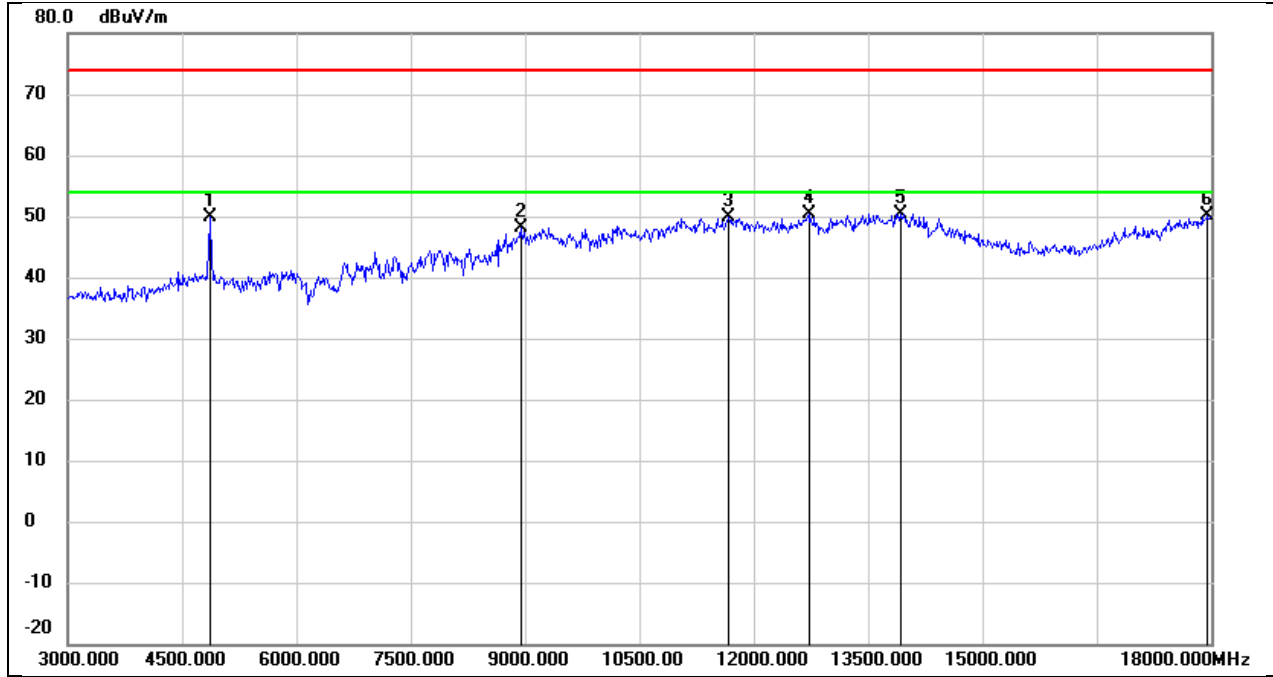

No.	Frequency (MHz)	Reading (dBuV)	Correct (dB/m)	Result (dBuV/m)	Limit (dBuV/m)	Margin (dB)	Remark
1	4875.000	49.89	-0.03	49.86	74.00	-24.14	peak
2	8940.000	38.11	10.04	48.15	74.00	-25.85	peak
3	11670.000	32.72	17.07	49.79	74.00	-24.21	peak
4	12720.000	32.25	18.08	50.33	74.00	-23.67	peak
5	13920.000	28.65	21.79	50.44	74.00	-23.56	peak
6	17955.000	24.78	25.42	50.20	74.00	-23.80	peak

Test Mode:	802.11n HT20	Frequency(MHz):	2437
Polarity:	Vertical	Test Voltage:	DC 5 V

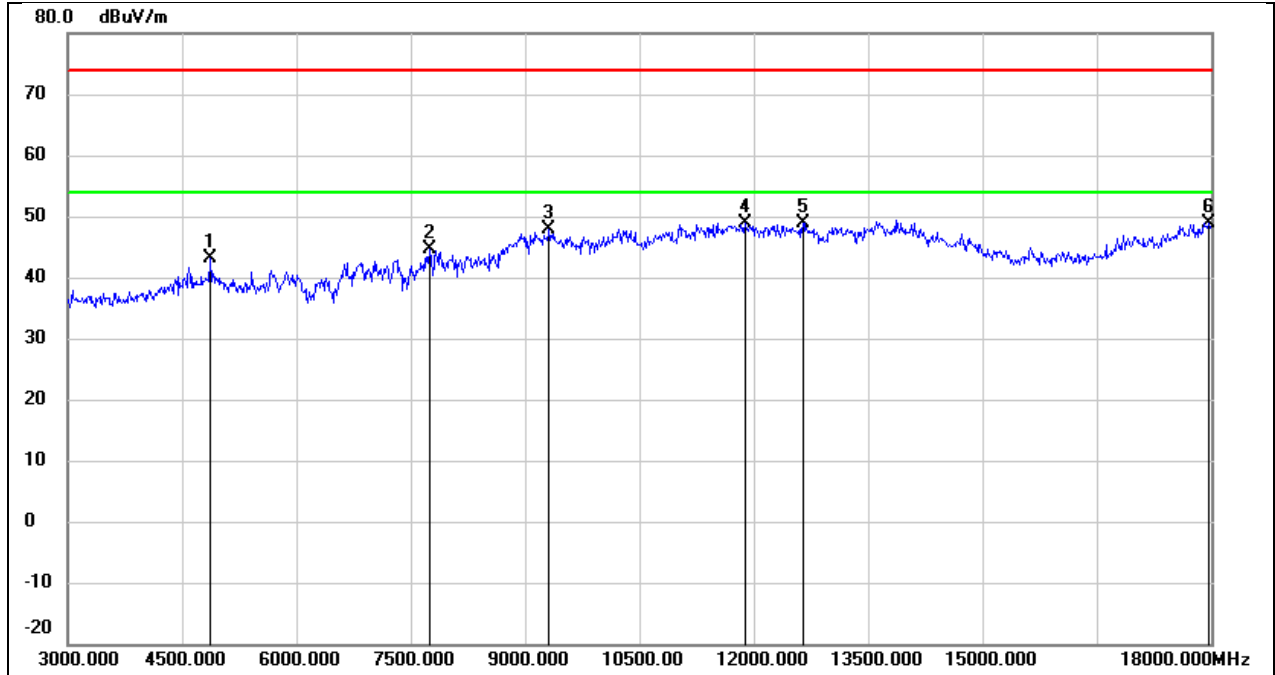

No.	Frequency (MHz)	Reading (dBuV)	Correct (dB/m)	Result (dBuV/m)	Limit (dBuV/m)	Margin (dB)	Remark
1	4875.000	43.23	-0.03	43.20	74.00	-30.80	peak
2	7740.000	38.19	6.32	44.51	74.00	-29.49	peak
3	9315.000	37.16	10.61	47.77	74.00	-26.23	peak
4	11880.000	31.28	17.63	48.91	74.00	-25.09	peak
5	12645.000	30.98	17.92	48.90	74.00	-25.10	peak
6	17970.000	23.45	25.51	48.96	74.00	-25.04	peak

Test Mode:	802.11n HT20	Frequency(MHz):	2462
Polarity:	Horizontal	Test Voltage:	DC 5 V

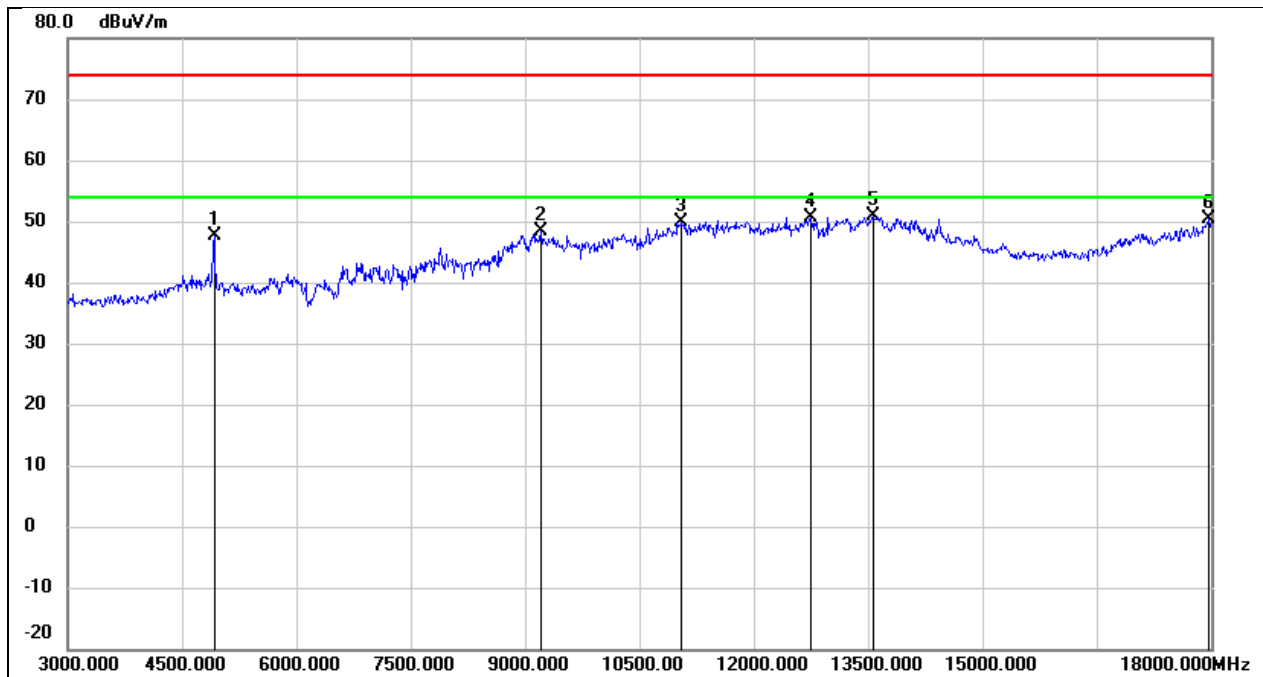

No.	Frequency (MHz)	Reading (dBuV)	Correct (dB/m)	Result (dBuV/m)	Limit (dBuV/m)	Margin (dB)	Remark
1	4920.000	47.44	0.14	47.58	74.00	-26.42	peak
2	9210.000	37.71	10.57	48.28	74.00	-25.72	peak
3	11055.000	34.94	14.96	49.90	74.00	-24.10	peak
4	12750.000	32.52	18.16	50.68	74.00	-23.32	peak
5	13560.000	29.82	21.04	50.86	74.00	-23.14	peak
6	17970.000	24.79	25.51	50.30	74.00	-23.70	peak

Test Mode:	802.11n HT20	Frequency(MHz):	2462
Polarity:	Vertical	Test Voltage:	DC 5 V

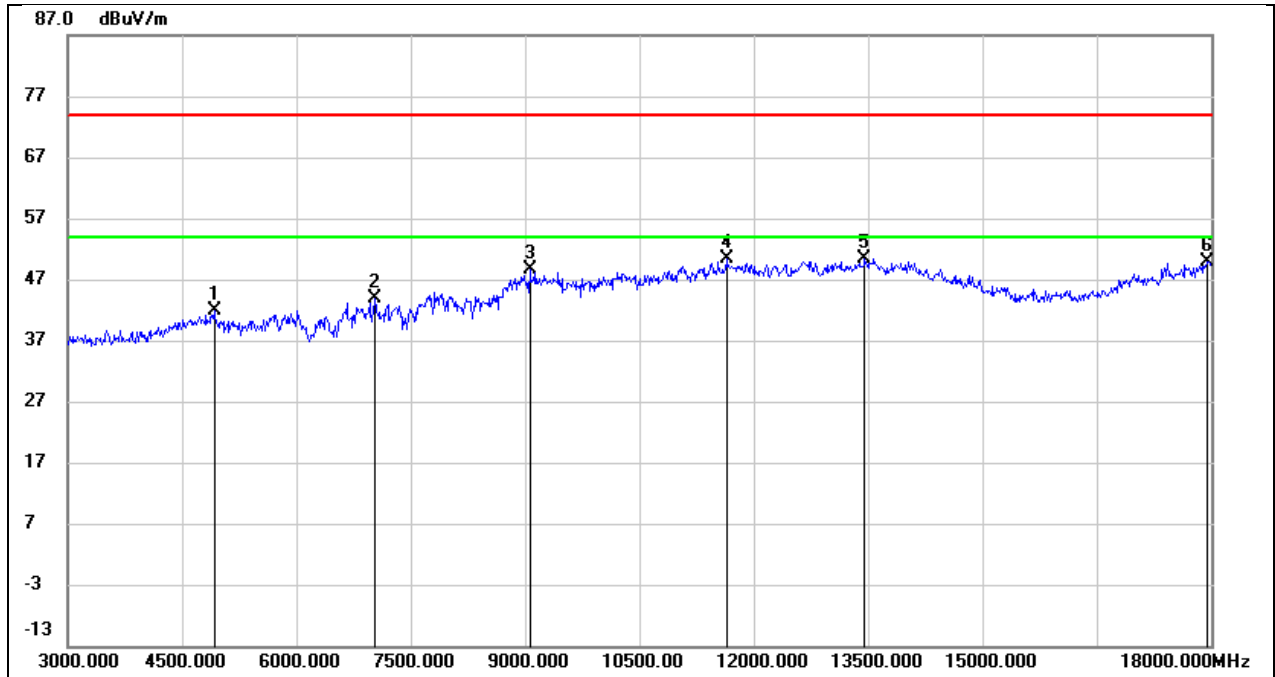

No.	Frequency (MHz)	Reading (dBuV)	Correct (dB/m)	Result (dBuV/m)	Limit (dBuV/m)	Margin (dB)	Remark
1	4920.000	41.69	0.14	41.83	74.00	-32.17	peak
2	7035.000	37.10	6.67	43.77	74.00	-30.23	peak
3	9060.000	38.12	10.51	48.63	74.00	-25.37	peak
4	11640.000	33.37	16.98	50.35	74.00	-23.65	peak
5	13455.000	29.64	20.71	50.35	74.00	-23.65	peak
6	17955.000	24.45	25.42	49.87	74.00	-24.13	peak

Test Mode:	802.11n HT40	Frequency(MHz):	2422
Polarity:	Horizontal	Test Voltage:	DC 5 V

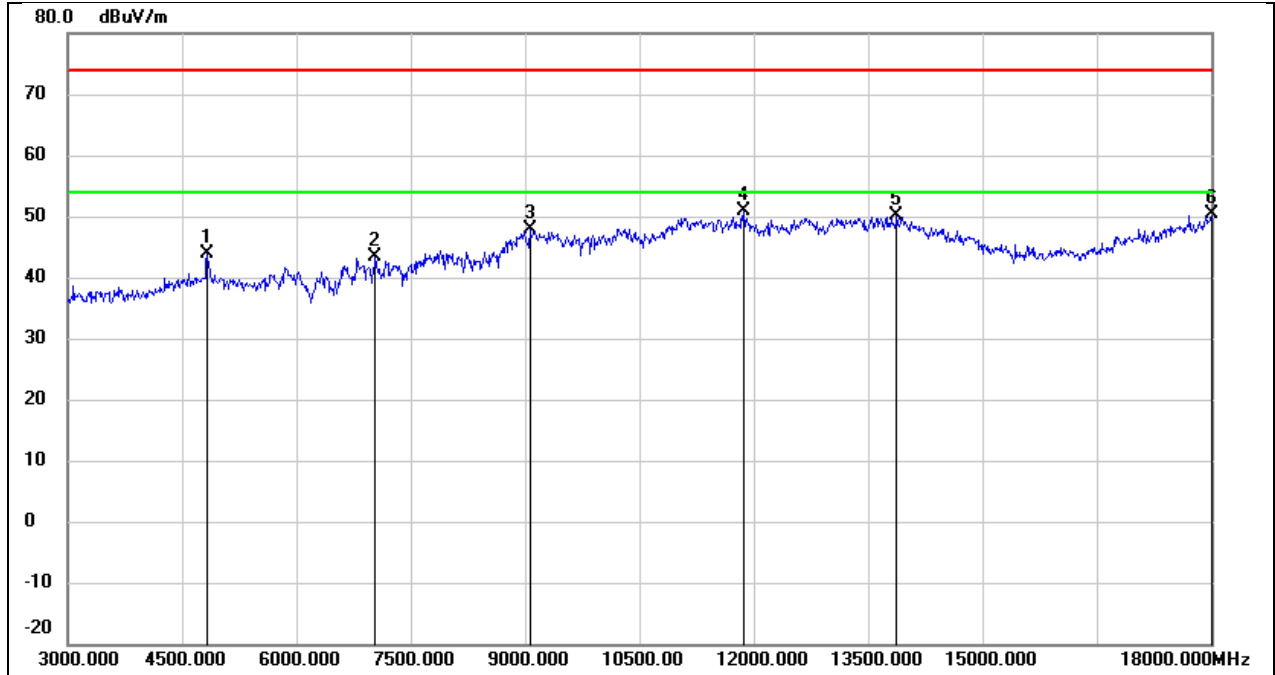

No.	Frequency (MHz)	Reading (dBuV)	Correct (dB/m)	Result (dBuV/m)	Limit (dBuV/m)	Margin (dB)	Remark
1	4830.000	44.17	-0.20	43.97	74.00	-30.03	peak
2	7035.000	36.70	6.67	43.37	74.00	-30.63	peak
3	9060.000	37.31	10.51	47.82	74.00	-26.18	peak
4	11865.000	33.26	17.59	50.85	74.00	-23.15	peak
5	13875.000	28.36	21.70	50.06	74.00	-23.94	peak
6	18000.000	24.61	25.69	50.30	74.00	-23.70	peak

Test Mode:	802.11n HT40	Frequency(MHz):	2422
Polarity:	Vertical	Test Voltage:	DC 5 V

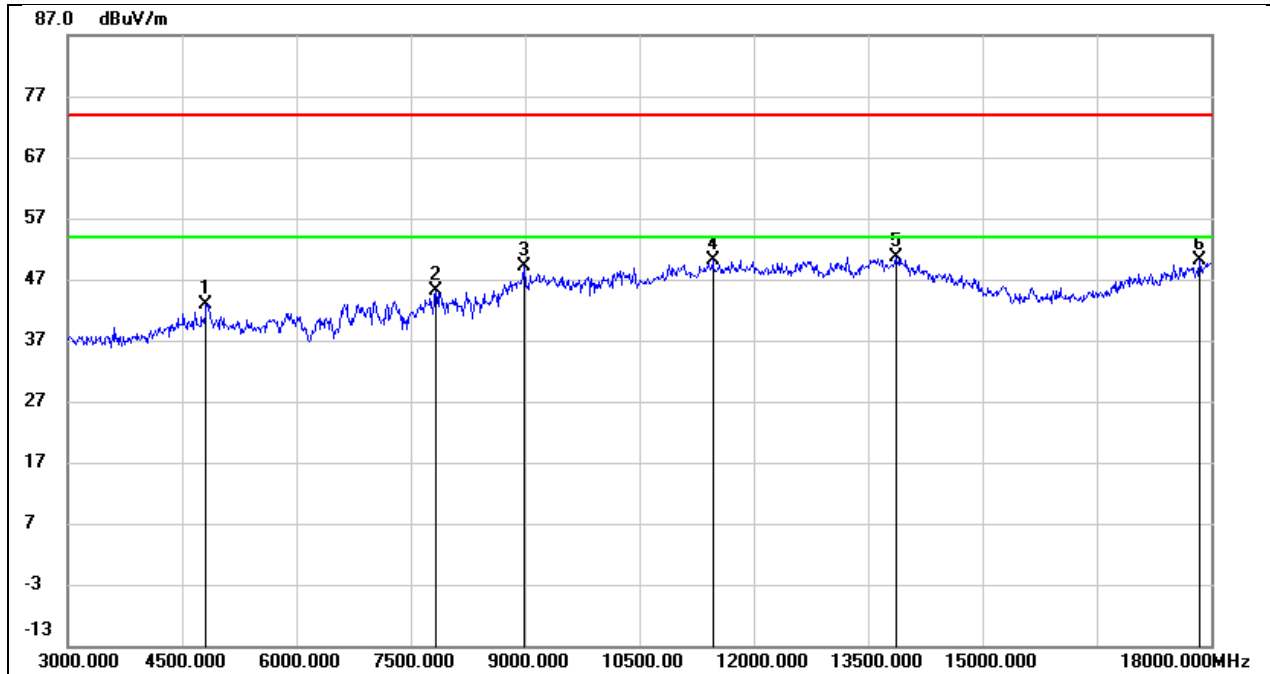

No.	Frequency (MHz)	Reading (dBuV)	Correct (dB/m)	Result (dBuV/m)	Limit (dBuV/m)	Margin (dB)	Remark
1	4815.000	43.22	-0.26	42.96	74.00	-31.04	peak
2	7830.000	38.83	6.32	45.15	74.00	-28.85	peak
3	8985.000	38.64	10.37	49.01	74.00	-24.99	peak
4	11460.000	33.66	16.46	50.12	74.00	-23.88	peak
5	13860.000	28.86	21.67	50.53	74.00	-23.47	peak
6	17850.000	25.21	24.81	50.02	74.00	-23.98	peak

Test Mode:	802.11n HT40	Frequency(MHz):	2437
Polarity:	Horizontal	Test Voltage:	DC 5 V

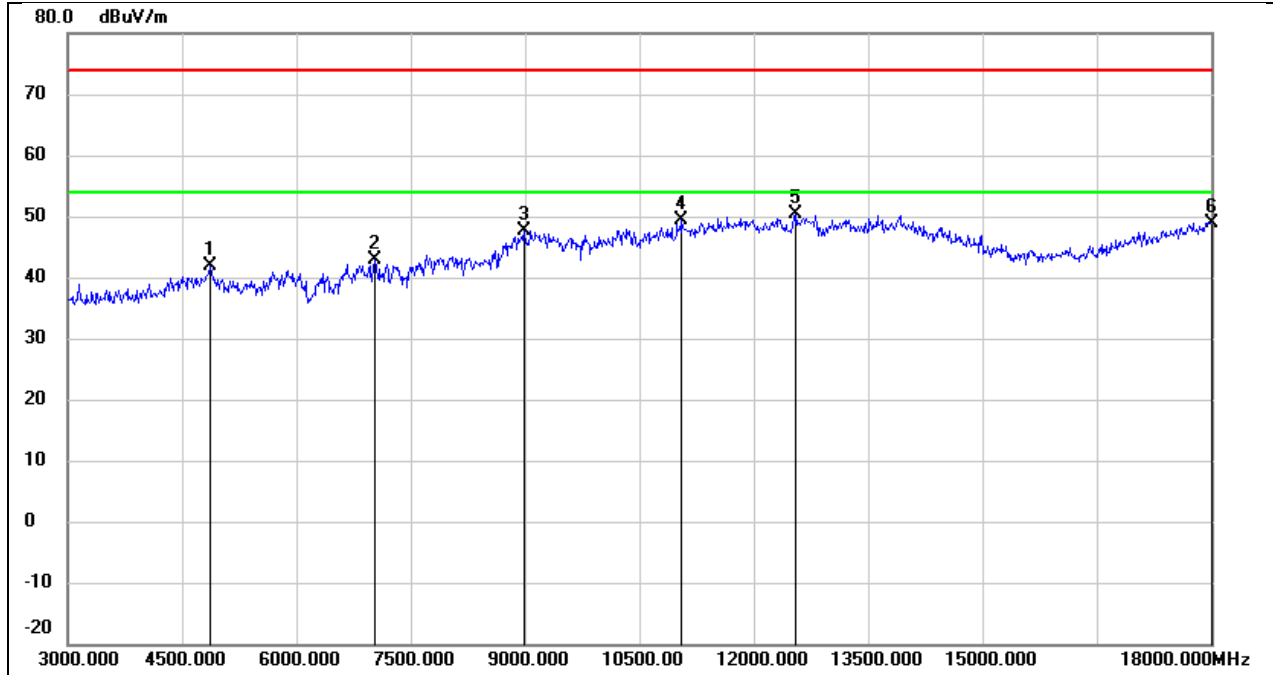

No.	Frequency (MHz)	Reading (dBuV)	Correct (dB/m)	Result (dBuV/m)	Limit (dBuV/m)	Margin (dB)	Remark
1	4860.000	42.08	-0.09	41.99	74.00	-32.01	peak
2	7035.000	36.09	6.67	42.76	74.00	-31.24	peak
3	8985.000	37.23	10.37	47.60	74.00	-26.40	peak
4	11055.000	34.39	14.96	49.35	74.00	-24.65	peak
5	12555.000	32.58	17.72	50.30	74.00	-23.70	peak
6	18000.000	23.24	25.69	48.93	74.00	-25.07	peak

Test Mode:	802.11n HT40	Frequency(MHz):	2437
Polarity:	Vertical	Test Voltage:	DC 5 V

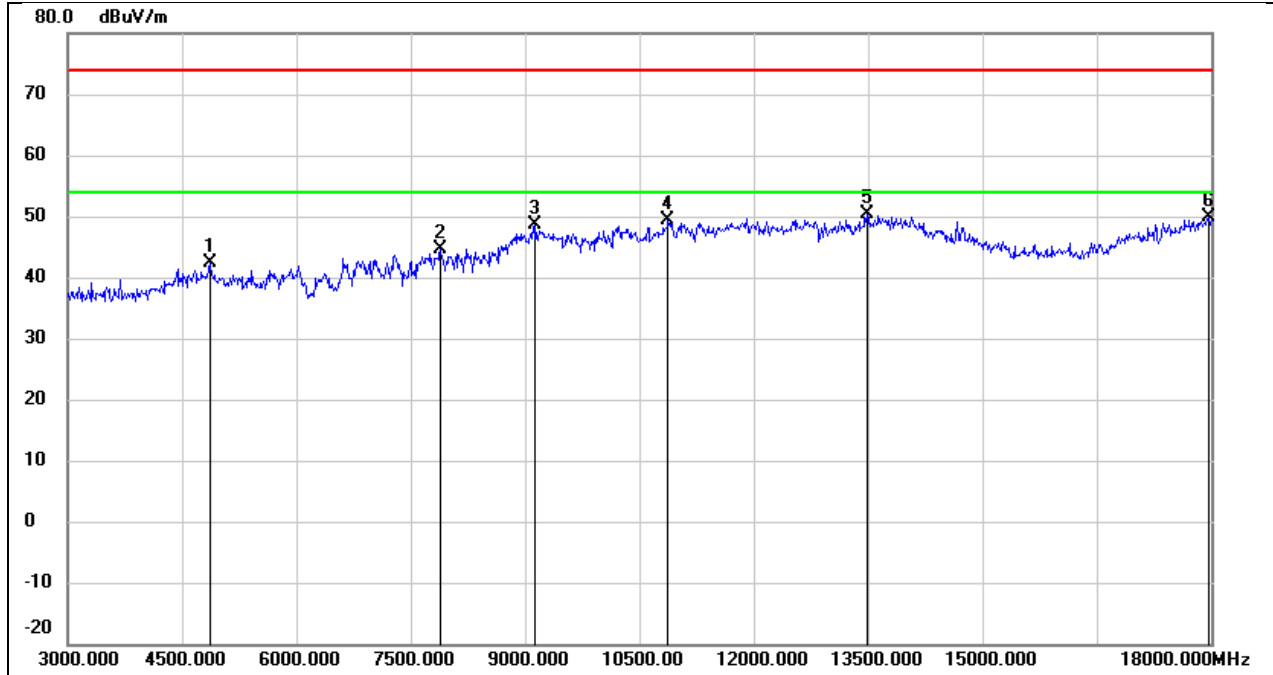

No.	Frequency (MHz)	Reading (dBuV)	Correct (dB/m)	Result (dBuV/m)	Limit (dBuV/m)	Margin (dB)	Remark
1	4860.000	42.42	-0.09	42.33	74.00	-31.67	peak
2	7890.000	38.23	6.31	44.54	74.00	-29.46	peak
3	9135.000	38.19	10.55	48.74	74.00	-25.26	peak
4	10875.000	35.08	14.32	49.40	74.00	-24.60	peak
5	13485.000	29.55	20.84	50.39	74.00	-23.61	peak
6	17970.000	24.34	25.51	49.85	74.00	-24.15	peak

Test Mode:	802.11n HT40	Frequency(MHz):	2452
Polarity:	Horizontal	Test Voltage:	DC 5 V

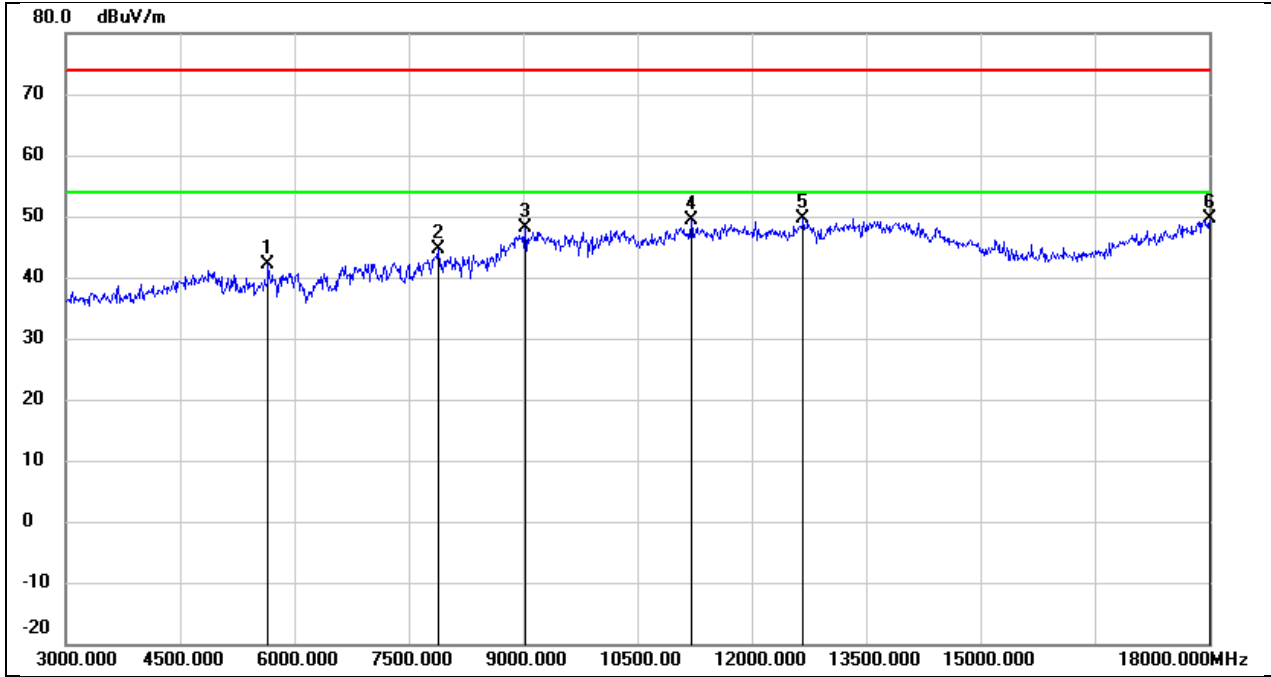

No.	Frequency (MHz)	Reading (dBuV)	Correct (dB/m)	Result (dBuV/m)	Limit (dBuV/m)	Margin (dB)	Remark
1	5655.000	40.74	1.29	42.03	74.00	-31.97	peak
2	7890.000	38.23	6.31	44.54	74.00	-29.46	peak
3	9030.000	37.57	10.49	48.06	74.00	-25.94	peak
4	11205.000	33.92	15.52	49.44	74.00	-24.56	peak
5	12675.000	31.63	17.99	49.62	74.00	-24.38	peak
6	18000.000	23.85	25.69	49.54	74.00	-24.46	peak

Test Mode:	802.11n HT40	Frequency(MHz):	2452
Polarity:	Vertical	Test Voltage:	DC 5 V

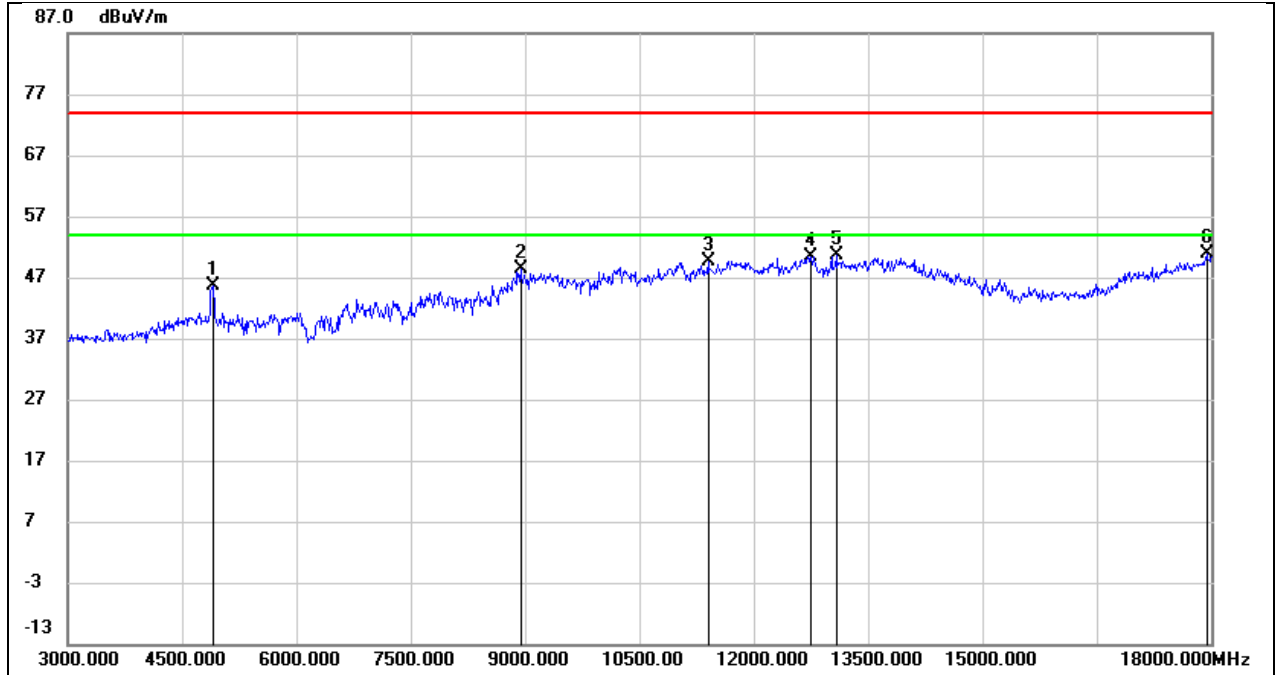

No.	Frequency (MHz)	Reading (dBuV)	Correct (dB/m)	Result (dBuV/m)	Limit (dBuV/m)	Margin (dB)	Remark
1	4905.000	45.50	0.09	45.59	74.00	-28.41	peak
2	8940.000	38.36	10.04	48.40	74.00	-25.60	peak
3	11400.000	33.37	16.23	49.60	74.00	-24.40	peak
4	12750.000	32.33	18.16	50.49	74.00	-23.51	peak
5	13080.000	31.68	19.07	50.75	74.00	-23.25	peak
6	17940.000	25.50	25.34	50.84	74.00	-23.16	peak

8.4. SPURIOUS EMISSIONS(9 KHZ~30 MHZ)

Test Mode:	802.11b	Frequency(MHz):	2412
Polarity:	Horizontal	Test Voltage:	DC 5V

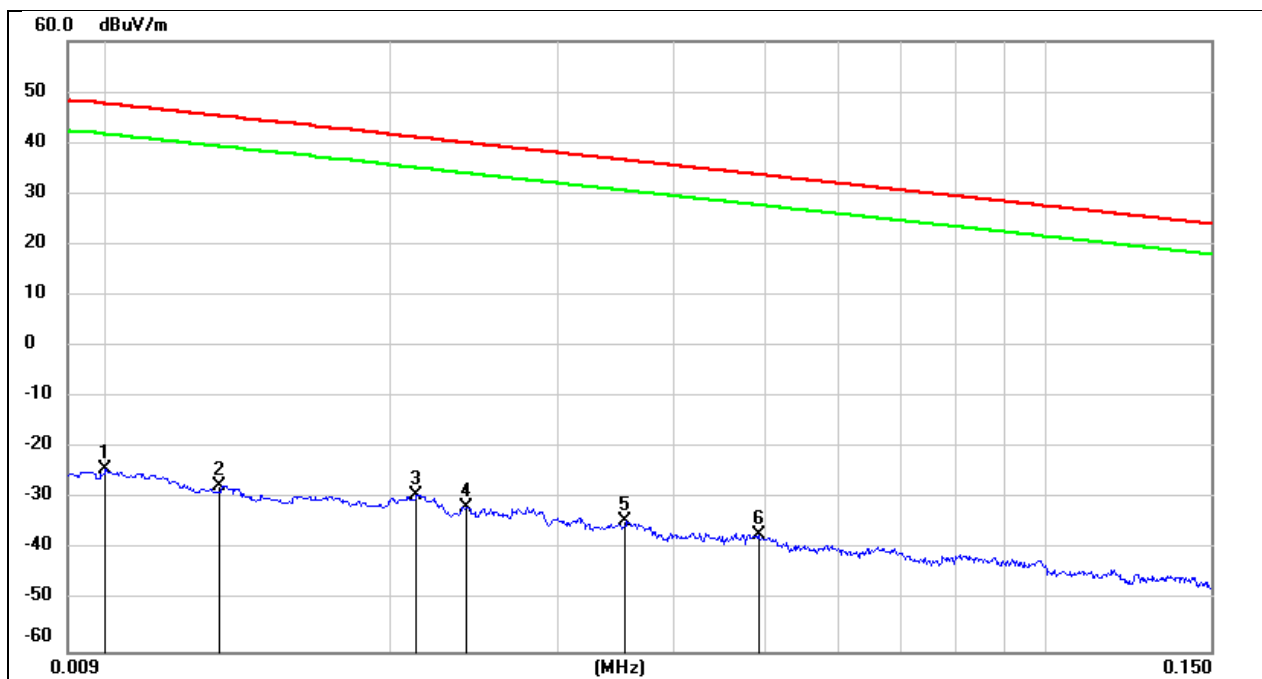

No.	Frequency (MHz)	Reading (dBuV)	Correct (dB/m)	FCC Result (dBuV/m)	FCC Limit (dBuV/m)	ISED Result (dBuA/m)	ISED Limit (dBuA/m)	Margin (dB)	Remark
1	0.01	77.22	-101.4	-24.18	47.6	-75.68	-3.9	-71.78	peak
2	0.0131	73.97	-101.38	-27.41	45.25	-78.91	-6.25	-72.66	peak
3	0.0212	72.04	-101.35	-29.31	41.07	-80.81	-10.43	-70.38	peak
4	0.024	69.82	-101.36	-31.54	40	-83.04	-11.5	-71.54	peak
5	0.0354	66.97	-101.41	-34.44	36.62	-85.94	-14.88	-71.06	peak
6	0.0492	64.55	-101.47	-36.92	33.76	-88.42	-17.74	-70.68	peak

Test Mode:	802.11b	Frequency(MHz):	2412
Polarity:	Horizontal	Test Voltage:	DC 5V

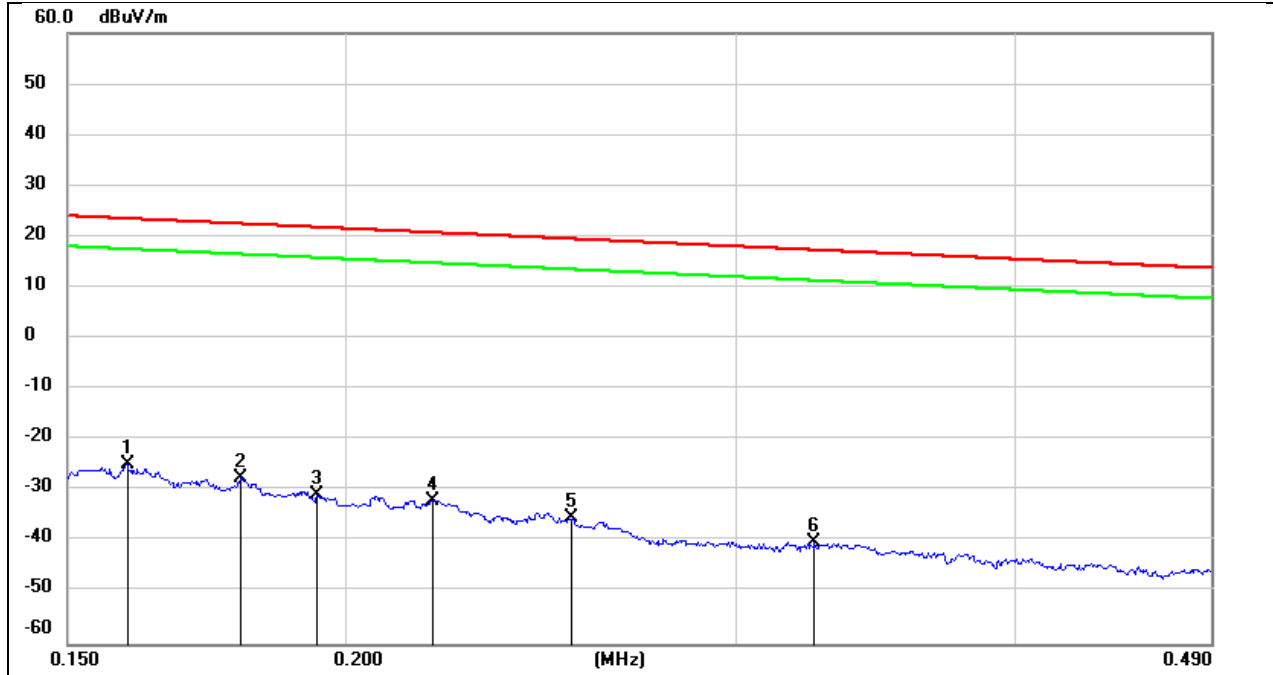

No.	Frequency (MHz)	Reading (dBuV)	Correct (dB/m)	FCC Result (dBuV/m)	FCC Limit (dBuV/m)	ISED Result (dBuA/m)	ISED Limit (dBuA/m)	Margin (dB)	Remark
1	0.1595	76.86	-101.65	-24.79	23.55	-76.29	-27.95	-48.34	peak
2	0.1794	74.27	-101.68	-27.41	22.53	-78.91	-28.97	-49.94	peak
3	0.1942	70.81	-101.7	-30.89	21.84	-82.39	-29.66	-52.73	peak
4	0.219	69.77	-101.75	-31.98	20.79	-83.48	-30.71	-52.77	peak
5	0.253	66.64	-101.8	-35.16	19.54	-86.66	-31.96	-54.7	peak
6	0.3251	61.71	-101.88	-40.17	17.36	-91.67	-34.14	-57.53	peak

Test Mode:	802.11b	Frequency(MHz):	2412
Polarity:	Horizontal	Test Voltage:	DC 5V

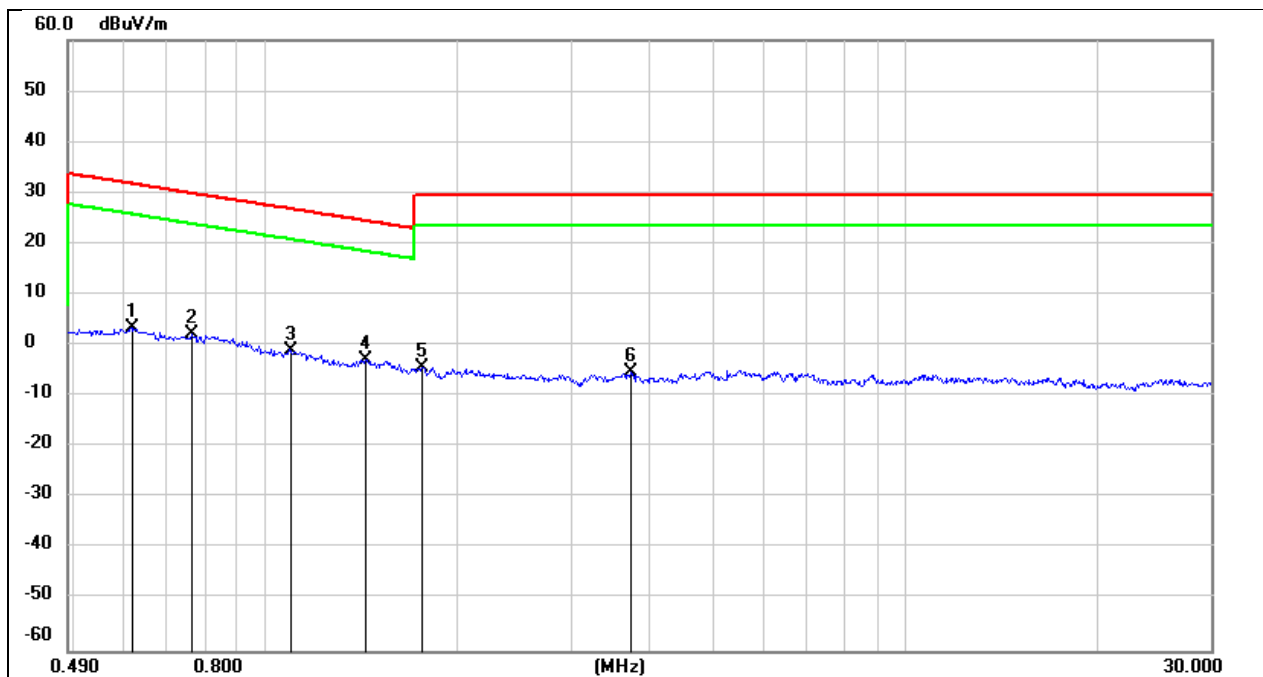

No.	Frequency (MHz)	Reading (dBuV)	Correct (dB/m)	FCC Result (dBuV/m)	FCC Limit (dBuV/m)	ISED Result (dBuA/m)	ISED Limit (dBuA/m)	Margin (dB)	Remark
1	0.6169	65.55	-62.08	3.47	31.8	-48.03	-19.7	-28.33	peak
2	0.7641	64.42	-62.12	2.3	29.94	-49.2	-21.56	-27.64	peak
3	1.0927	61.28	-62.22	-0.94	26.84	-52.44	-24.66	-27.78	peak
4	1.4274	59.38	-62.08	-2.7	24.51	-54.2	-26.99	-27.21	peak
5	1.758	57.58	-61.93	-4.35	29.54	-55.85	-21.96	-33.89	peak
6	3.71	56.2	-61.41	-5.21	29.54	-56.71	-21.96	-34.75	peak

8.5. SPURIOUS EMISSIONS(18 GHZ~26 GHZ)

Test Mode:	802.11b	Frequency(MHz):	2412
Polarity:	Horizontal	Test Voltage:	DC 5V

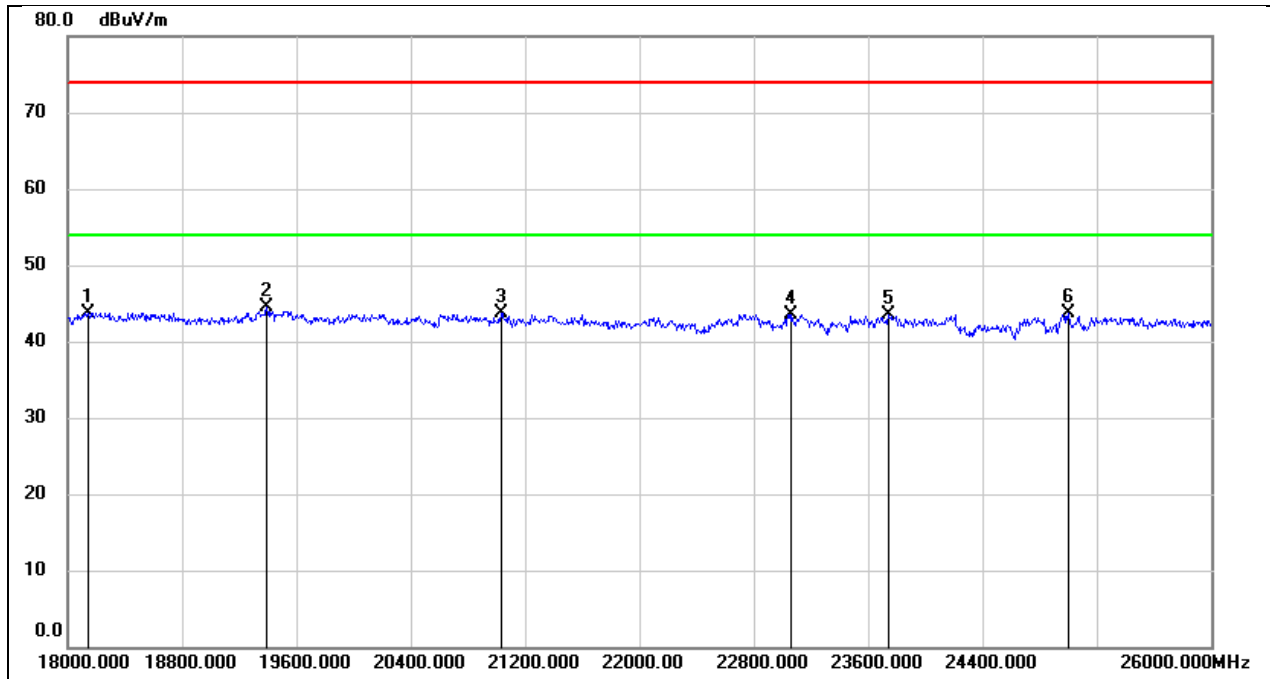

No.	Frequency (MHz)	Reading (dBuV)	Correct (dB/m)	Result (dBuV/m)	Limit (dBuV/m)	Margin (dB)	Remark
1	18144.000	49.27	-5.48	43.79	74.00	-30.21	peak
2	19392.000	50.12	-5.57	44.55	74.00	-29.45	peak
3	21032.000	48.65	-4.87	43.78	74.00	-30.22	peak
4	23064.000	46.99	-3.42	43.57	74.00	-30.43	peak
5	23744.000	46.65	-3.20	43.45	74.00	-30.55	peak
6	25000.000	45.86	-2.10	43.76	74.00	-30.24	peak

Test Mode:	802.11b	Frequency(MHz):	2412
Polarity:	Vertical	Test Voltage:	DC 5V

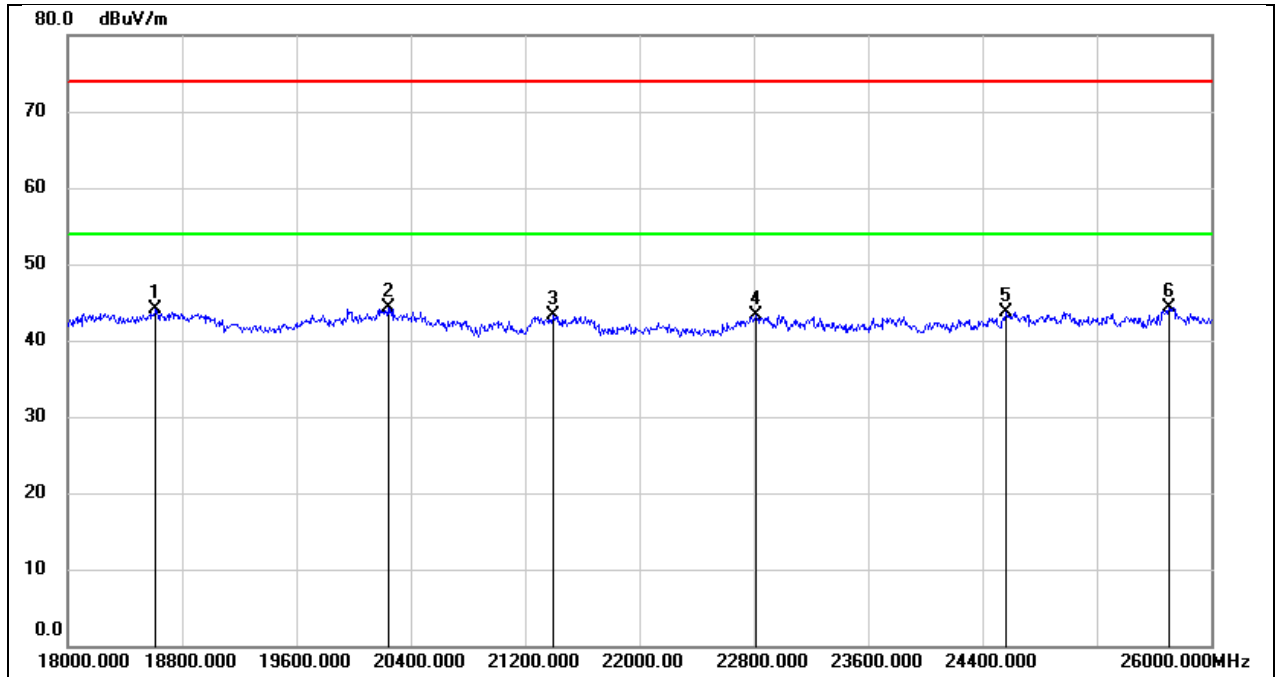

No.	Frequency (MHz)	Reading (dBuV)	Correct (dB/m)	Result (dBuV/m)	Limit (dBuV/m)	Margin (dB)	Remark
1	18616.000	49.39	-5.34	44.05	74.00	-29.95	peak
2	20240.000	49.82	-5.61	44.21	74.00	-29.79	peak
3	21400.000	48.04	-4.72	43.32	74.00	-30.68	peak
4	22816.000	46.93	-3.63	43.30	74.00	-30.70	peak
5	24568.000	46.10	-2.33	43.77	74.00	-30.23	peak
6	25704.000	45.04	-0.83	44.21	74.00	-29.79	peak

8.6. SPURIOUS EMISSIONS(30 MHZ~1 GHZ)

Test Mode:	802.11b	Frequency(MHz):	2412
Polarity:	Horizontal	Test Voltage:	DC5V

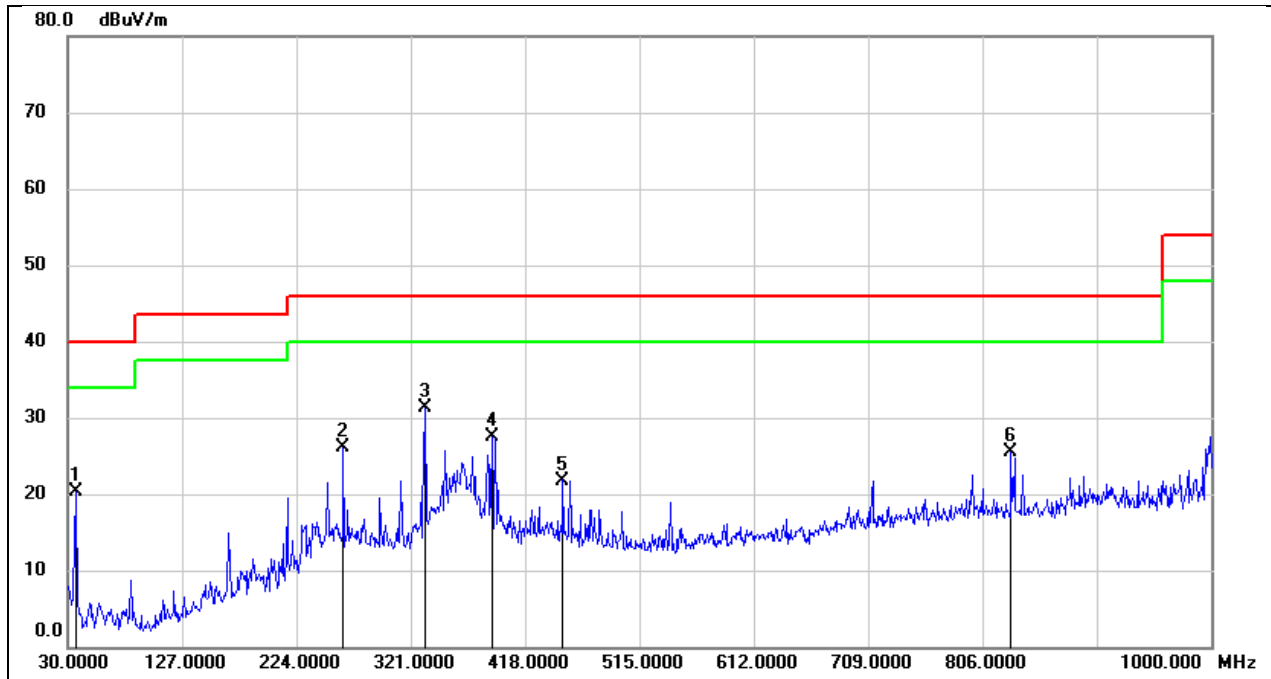

No.	Frequency (MHz)	Reading (dBuV)	Correct (dB/m)	Result (dBuV/m)	Limit (dBuV/m)	Margin (dB)	Remark
1	36.7900	39.14	-18.83	20.31	40.00	-19.69	QP
2	263.7700	43.46	-17.39	26.07	46.00	-19.93	QP
3	333.6099	44.49	-13.25	31.24	46.00	-14.76	QP
4	389.8700	40.01	-12.46	27.55	46.00	-18.45	QP
5	450.0100	33.18	-11.38	21.80	46.00	-24.20	QP
6	830.2500	31.58	-6.12	25.46	46.00	-20.54	QP

Test Mode:	802.11b	Frequency(MHz):	2412
Polarity:	Vertical	Test Voltage:	DC5V

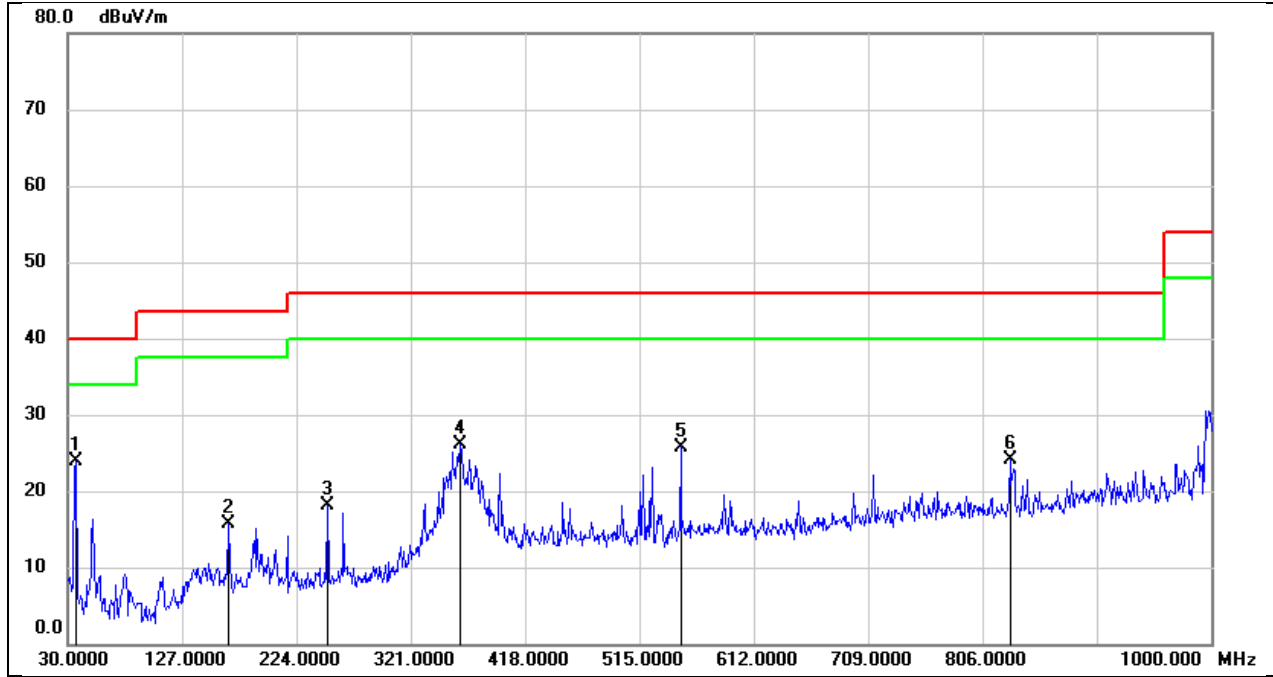

No.	Frequency (MHz)	Reading (dBuV)	Correct (dB/m)	Result (dBuV/m)	Limit (dBuV/m)	Margin (dB)	Remark
1	36.7900	42.70	-18.83	23.87	40.00	-16.13	QP
2	166.7700	32.29	-16.55	15.74	43.50	-27.76	QP
3	250.1900	36.52	-18.35	18.17	46.00	-27.83	QP
4	362.7100	38.65	-12.45	26.20	46.00	-19.80	QP
5	549.9200	36.07	-10.27	25.80	46.00	-20.20	QP
6	829.2800	30.13	-6.12	24.01	46.00	-21.99	QP

9. ANTENNA REQUIREMENT

REQUIREMENT

Please refer to FCC part 15.203

An intentional radiator shall be designed to ensure that no antenna other than that furnished by the responsible party shall be used with the device. The use of a permanently attached antenna or of an antenna that uses a unique coupling to the intentional radiator shall be considered sufficient to comply with the provisions of this section. The manufacturer may design the unit so that a broken antenna can be replaced by the user, but the use of a standard antenna jack or electrical connector is prohibited.

Please refer to FCC part 15.247(b)(4)

The conducted output power limit specified in paragraph (b) of this section is based on the use of antennas with directional gains that do not exceed 6 dBi. Except as shown in paragraph (c) of this section, if transmitting antennas of directional gain greater than 6 dBi are used, the conducted output power from the intentional radiator shall be reduced below the stated values in paragraphs (b)(1), (b)(2), and (b)(3) of this section, as appropriate, by the amount in dB that the directional gain of the antenna exceeds 6 dBi.

DESCRIPTION

Pass

10. AC POWER LINE CONDUCTED EMISSION

LIMITS

Please refer to CFR 47 FCC §15.207 (a) and ISED RSS-Gen Clause 8.8

FREQUENCY (MHz)	Quasi-peak	Average
0.15 -0.5	66 - 56 *	56 - 46 *
0.50 -5.0	56.00	46.00
5.0 -30.0	60.00	50.00

TEST PROCEDURE

The EUT is put on a table of non-conducting material that is 80 cm high. The vertical conducting wall of shielding is located 40 cm to the rear of the EUT. The power line of the EUT is connected to the AC mains through a Artificial Mains Network (A.M.N.). A EMI Measurement Receiver (R&S Test Receiver ESR3) is used to test the emissions from both sides of AC line. According to the requirements in Section 6.2 of ANSI C63.10-2013. Conducted emissions from the EUT measured in the frequency range between 0.15 MHz and 30 MHz using CISPR Quasi-Peak and average detector mode. The bandwidth of EMI test receiver is set at 9 kHz.

The arrangement of the equipment is installed to meet the standards and operating in a manner, which tends to maximize its emission characteristics in a normal application.

TEST SETUP

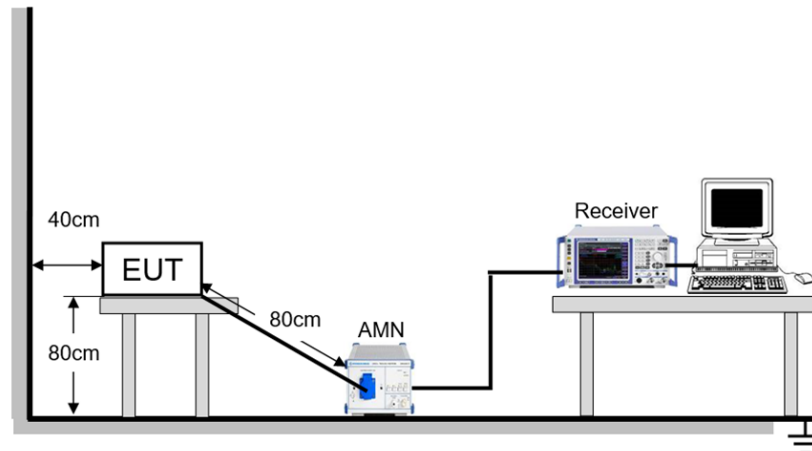

TEST ENVIRONMENT

Temperature	24.5°C	Relative Humidity	58%
Atmosphere Pressure	101kPa	Test Voltage	AC 120 V, 60 Hz

TEST DATE / ENGINEER

Test Date	December 5, 2023	Test By	Kebo Zhang
-----------	------------------	---------	------------

TEST RESULTS

Test Mode:	802.11b	Frequency(MHz):	2412
Line:	Line		

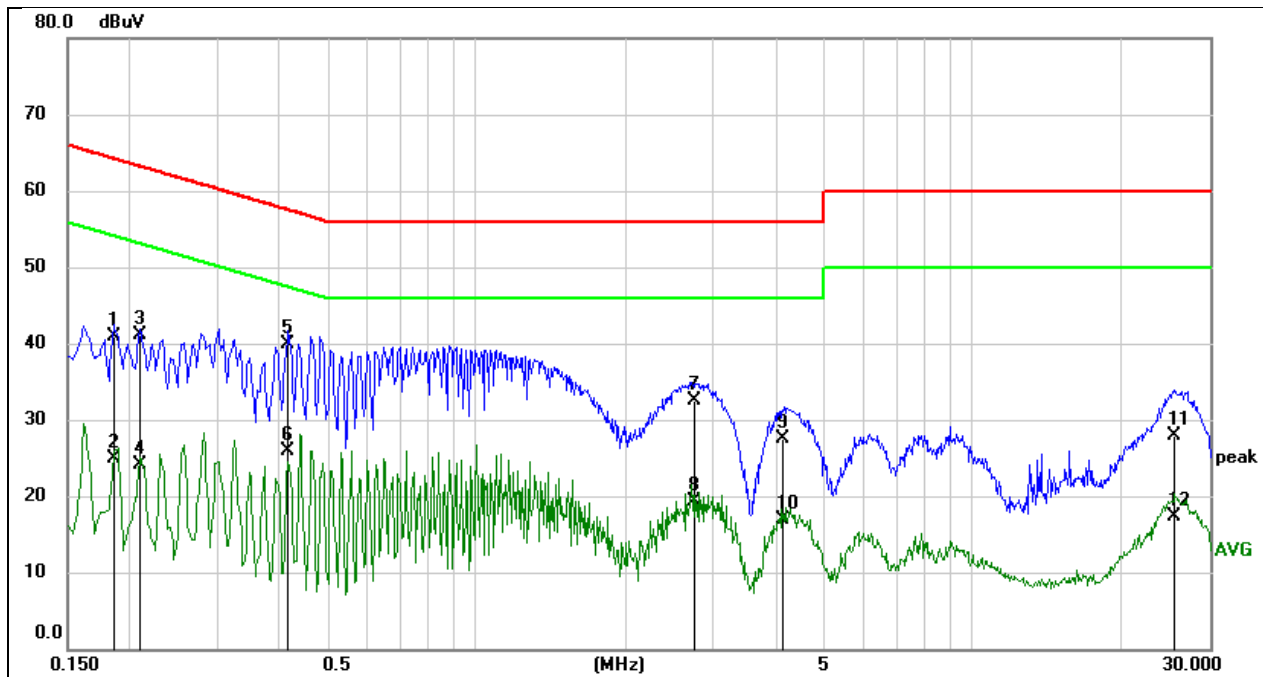

No.	Frequency (MHz)	Reading (dBuV)	Correct (dB)	Result (dBuV)	Limit (dBuV)	Margin (dB)	Remark
1	0.1861	31.38	9.59	40.97	64.21	-23.24	QP
2	0.1861	15.33	9.59	24.92	54.21	-29.29	AVG
3	0.2097	31.53	9.59	41.12	63.22	-22.10	QP
4	0.2097	14.58	9.59	24.17	53.22	-29.05	AVG
5	0.4187	30.34	9.60	39.94	57.47	-17.53	QP
6	0.4187	16.34	9.60	25.94	47.47	-21.53	AVG
7	2.7573	22.92	9.66	32.58	56.00	-23.42	QP
8	2.7573	9.71	9.66	19.37	46.00	-26.63	AVG
9	4.1373	17.75	9.70	27.45	56.00	-28.55	QP
10	4.1373	7.16	9.70	16.86	46.00	-29.14	AVG
11	25.4315	18.24	9.74	27.98	60.00	-32.02	QP
12	25.4315	7.53	9.74	17.27	50.00	-32.73	AVG

Note:

1. Result = Reading + Correct Factor.
2. If QP Result complies with AV limit, AV Result is deemed to comply with AV limit.
3. Test setup: RBW: 200 Hz (9 kHz ~ 150 kHz), 9 kHz (150 kHz ~ 30 MHz).
4. Step size: 80 Hz (0.009 MHz ~ 0.15 MHz), 4 kHz (0.15 MHz ~ 30 MHz), Scan time: auto.

Note: All the modes have been tested, only the worst data was recorded in the report.

Test Mode:	802.11b	Frequency(MHz):	2412
Line:	Neutral		

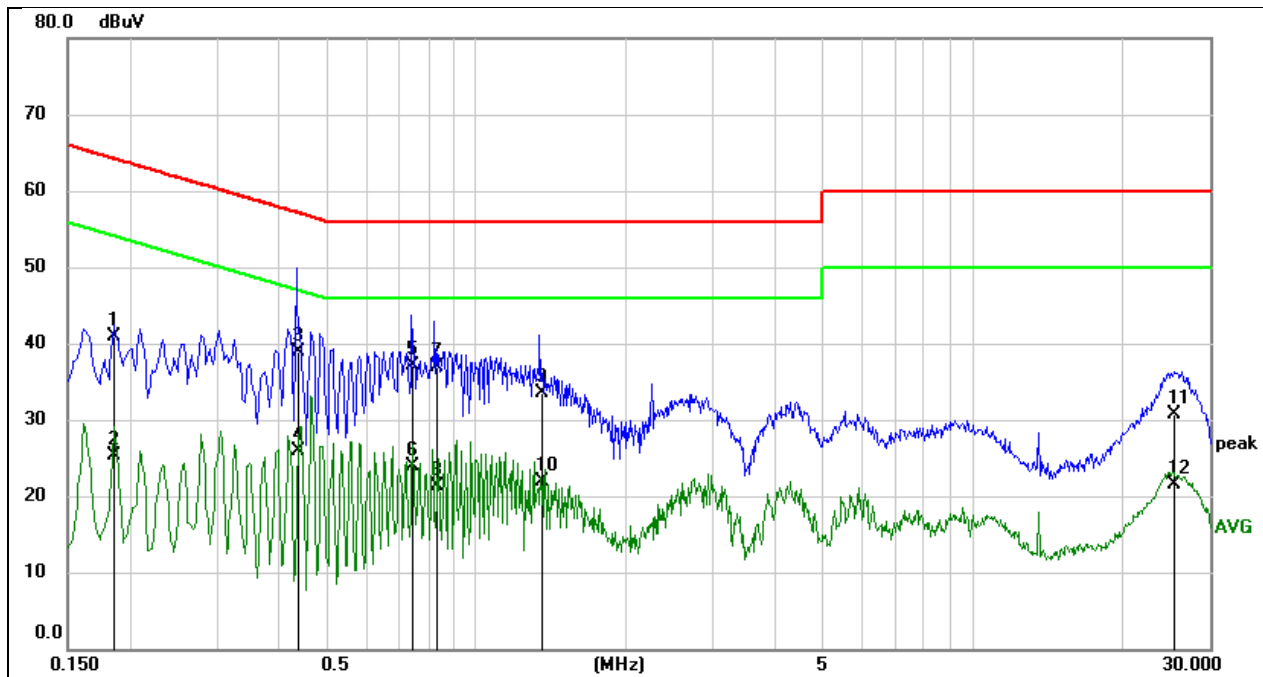

No.	Frequency (MHz)	Reading (dBuV)	Correct (dB)	Result (dBuV)	Limit (dBuV)	Margin (dB)	Remark
1	0.1859	31.29	9.56	40.85	64.22	-23.37	QP
2	0.1859	15.66	9.56	25.22	54.22	-29.00	AVG
3	0.4383	29.30	9.52	38.82	57.09	-18.27	QP
4	0.4383	16.30	9.52	25.82	47.09	-21.27	AVG
5	0.7480	27.57	9.50	37.07	56.00	-18.93	QP
6	0.7480	14.48	9.50	23.98	46.00	-22.02	AVG
7	0.8345	27.36	9.50	36.86	56.00	-19.14	QP
8	0.8345	11.83	9.50	21.33	46.00	-24.67	AVG
9	1.3504	23.99	9.54	33.53	56.00	-22.47	QP
10	1.3504	12.28	9.54	21.82	46.00	-24.18	AVG
11	25.5620	21.09	9.69	30.78	60.00	-29.22	QP
12	25.5620	11.79	9.69	21.48	50.00	-28.52	AVG

Note:

1. Result = Reading + Correct Factor.
2. If QP Result complies with AV limit, AV Result is deemed to comply with AV limit.
3. Test setup: RBW: 200 Hz (9 kHz ~ 150 kHz), 9 kHz (150 kHz ~ 30 MHz).
4. Step size: 80 Hz (0.009 MHz ~ 0.15 MHz), 4 kHz (0.15 MHz ~ 30 MHz), Scan time: auto.

Note: All the modes have been tested, only the worst data was recorded in the report.

11. TEST DATA

11.1. APPENDIX A: DTS BANDWIDTH

11.1.1. Test Result

Test Mode	Antenna	Frequency[MHz]	DTS BW [MHz]	FL[MHz]	FH[MHz]	Limit[MHz]	Verdict
11B	Ant1	2412	9.56	2406.96	2416.52	≥0.5	PASS
		2437	10.08	2431.96	2442.04	≥0.5	PASS
		2462	9.56	2456.96	2466.52	≥0.5	PASS
11G	Ant1	2412	16.36	2403.80	2420.16	≥0.5	PASS
		2437	16.28	2428.84	2445.12	≥0.5	PASS
		2462	16.36	2453.80	2470.16	≥0.5	PASS
11N20SISO	Ant1	2412	17.56	2403.20	2420.76	≥0.5	PASS
		2437	17.64	2428.16	2445.80	≥0.5	PASS
		2462	16.92	2453.60	2470.52	≥0.5	PASS
11N40SISO	Ant1	2422	35.84	2404.08	2439.92	≥0.5	PASS
		2437	35.52	2419.08	2454.60	≥0.5	PASS
		2452	35.52	2434.40	2469.92	≥0.5	PASS

11.1.2. Test Graphs

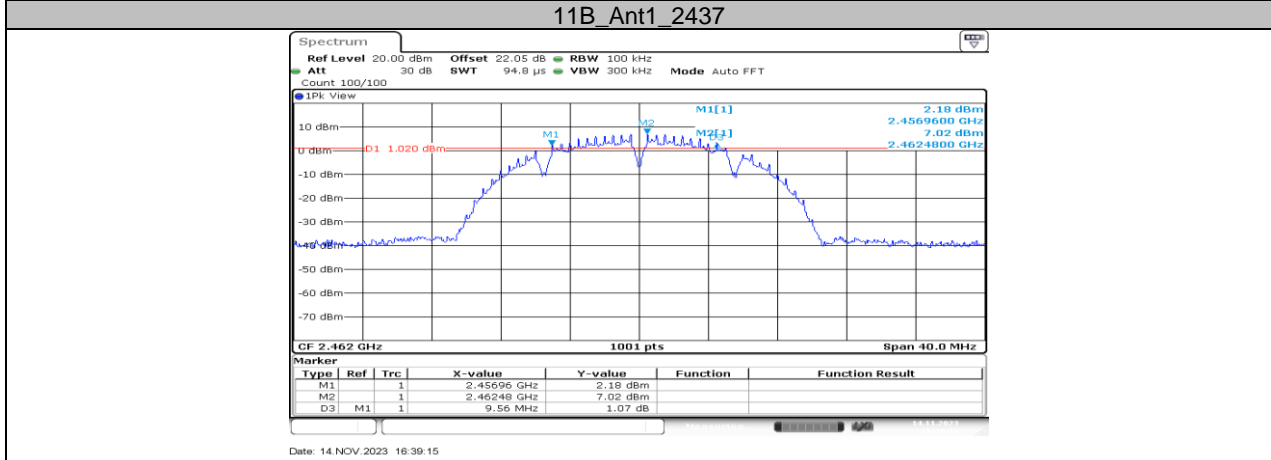
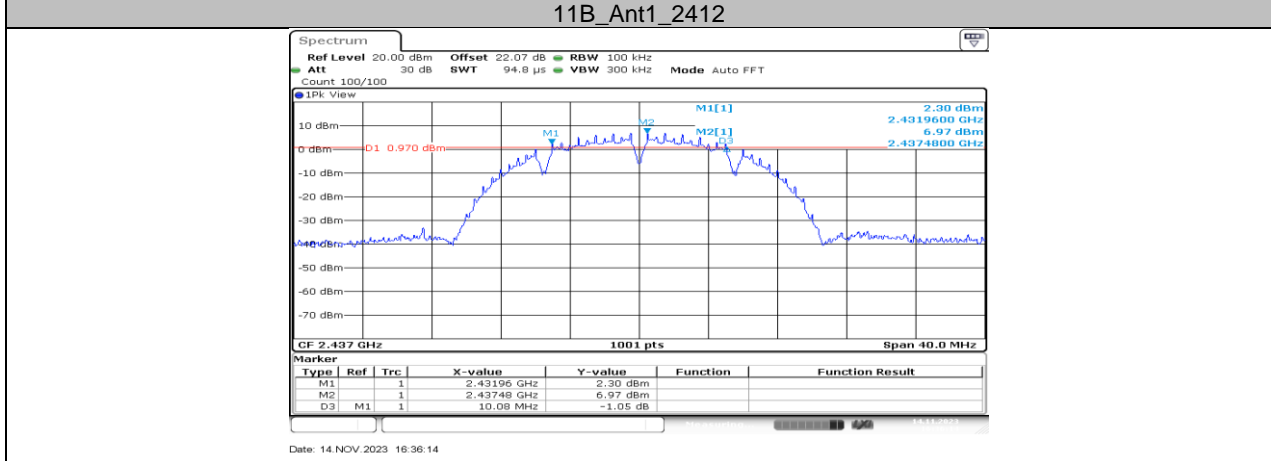
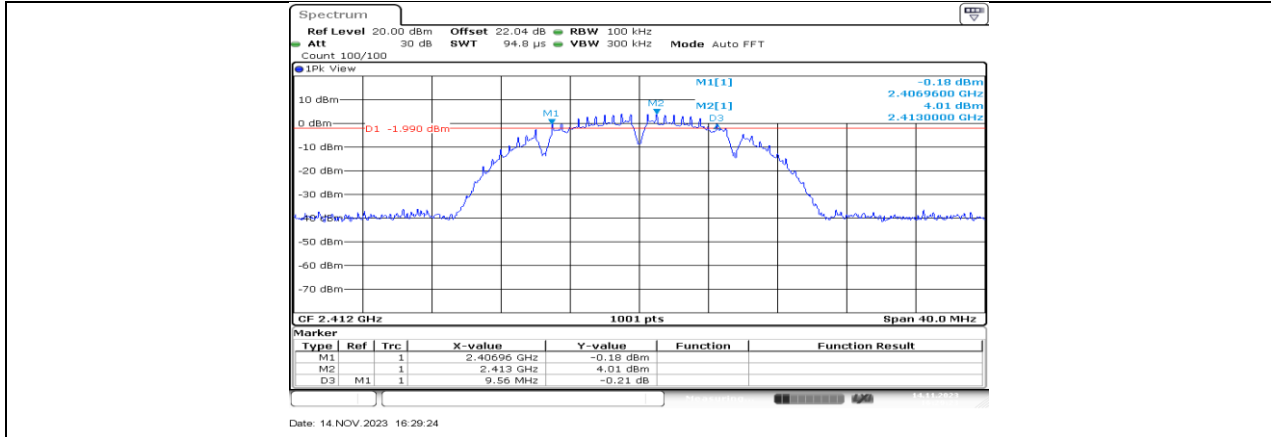

11B_Ant1_2462

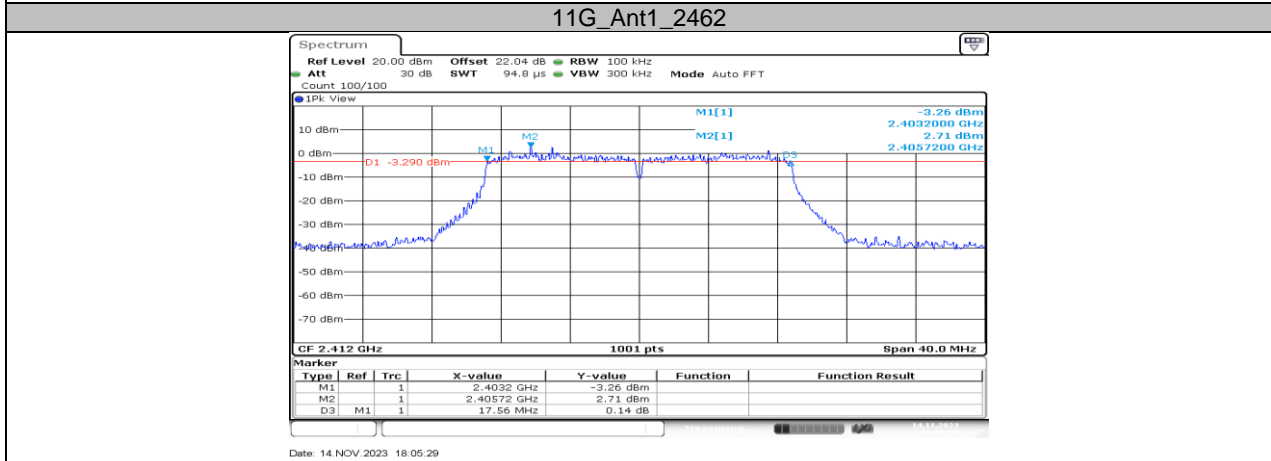
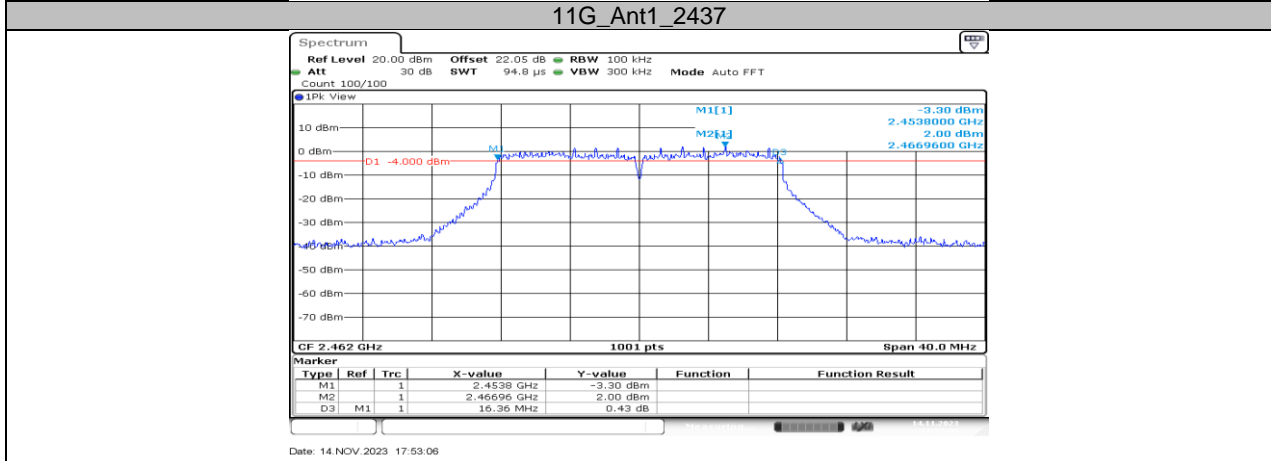
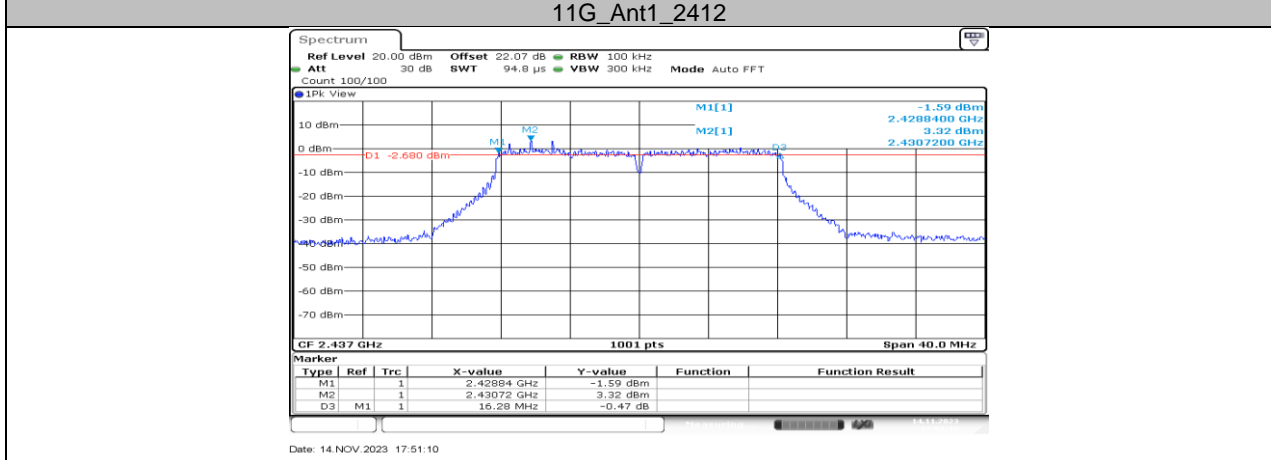
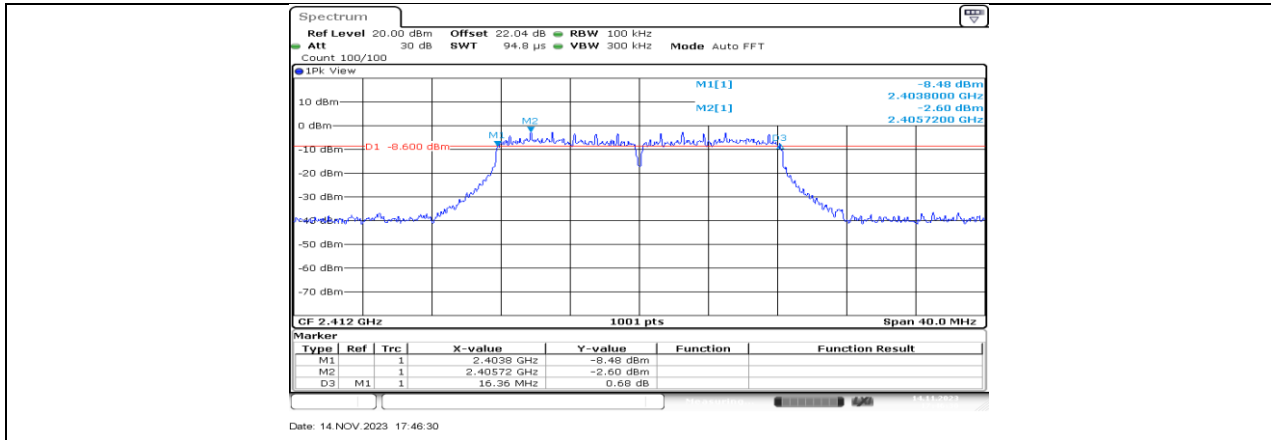

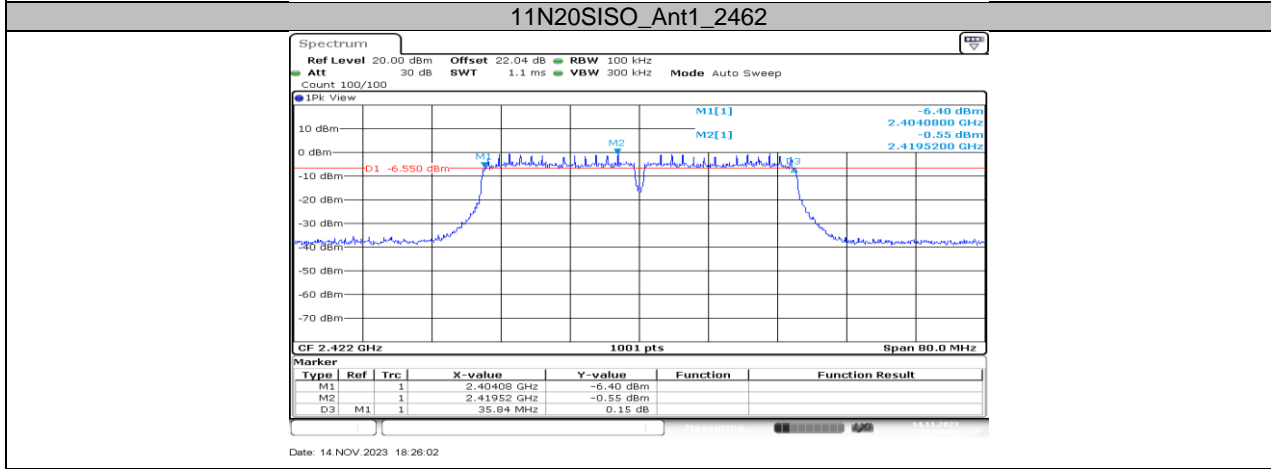
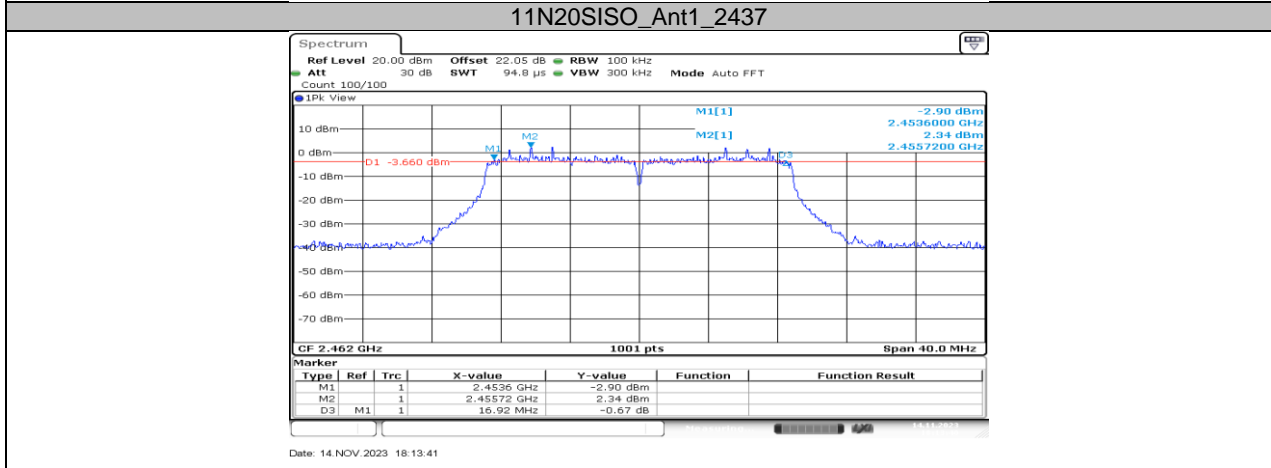
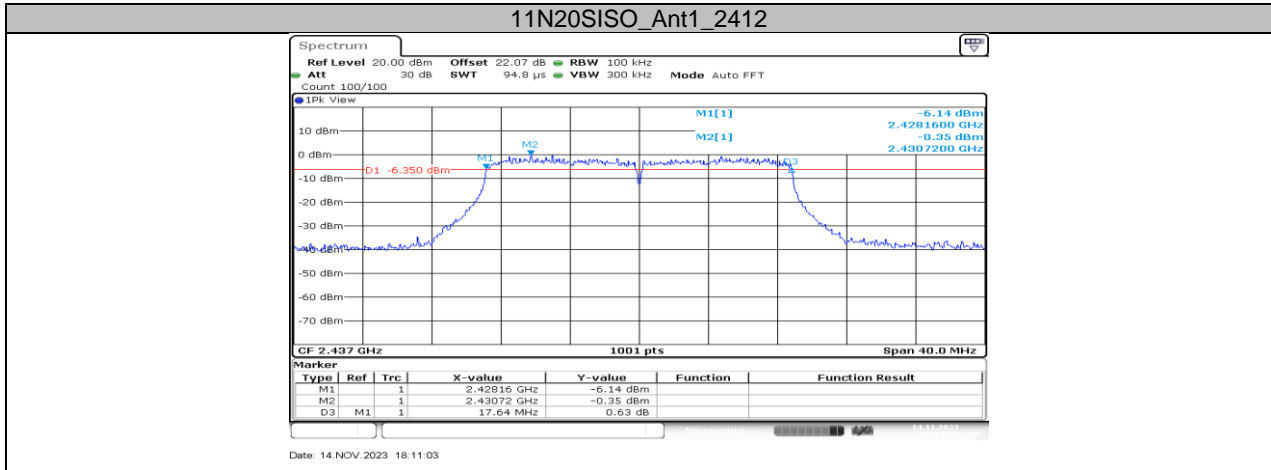

11N40SISO_Ant1_2422

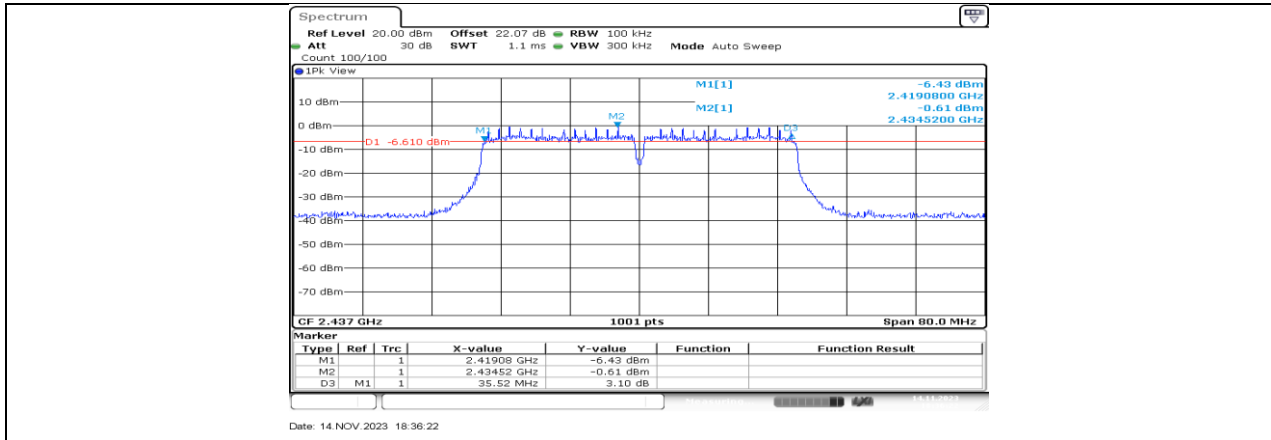

11N40SISO_Ant1_2437

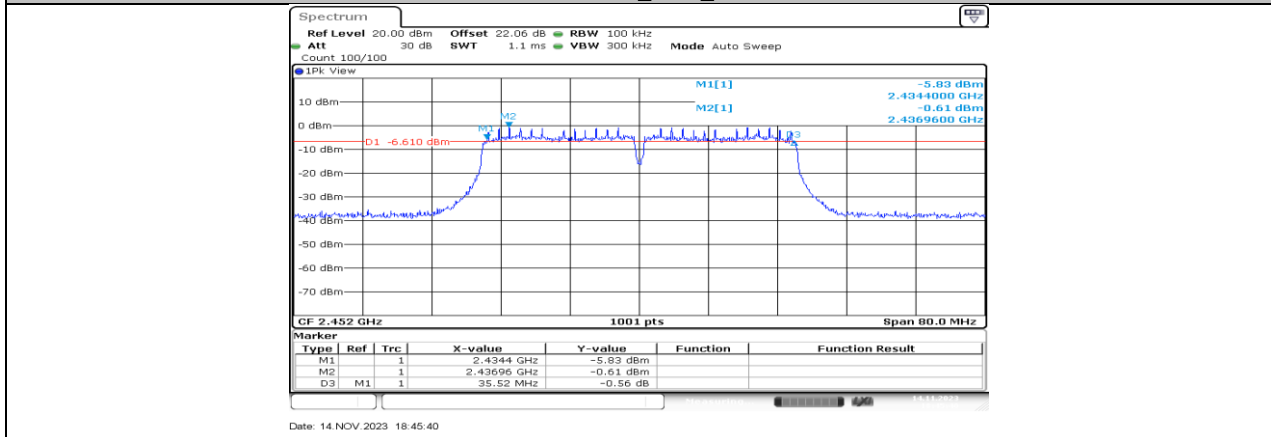

11N40SISO_Ant1_2452

11.2. APPENDIX B: OCCUPIED CHANNEL BANDWIDTH

11.2.1. Test Result

Test Mode	Antenna	Frequency[MHz]	OCB [MHz]	FL[MHz]	FH[MHz]	Verdict
11B	Ant1	2412	15.265	2404.3676	2419.6324	PASS
		2437	15.145	2429.4076	2444.5524	PASS
		2462	15.145	2454.4076	2469.5524	PASS
11G	Ant1	2412	17.542	2403.2088	2420.7512	PASS
		2437	17.502	2428.2088	2445.7113	PASS
		2462	17.383	2453.2488	2470.6314	PASS
11N20SISO	Ant1	2412	18.262	2402.8891	2421.1508	PASS
		2437	18.262	2427.8492	2446.1109	PASS
		2462	18.302	2452.8492	2471.1508	PASS
11N40SISO	Ant1	2422	36.843	2403.6983	2440.5415	PASS
		2437	36.683	2418.6983	2455.3816	PASS
		2452	36.683	2433.6983	2470.3816	PASS

11.2.2. Test Graphs

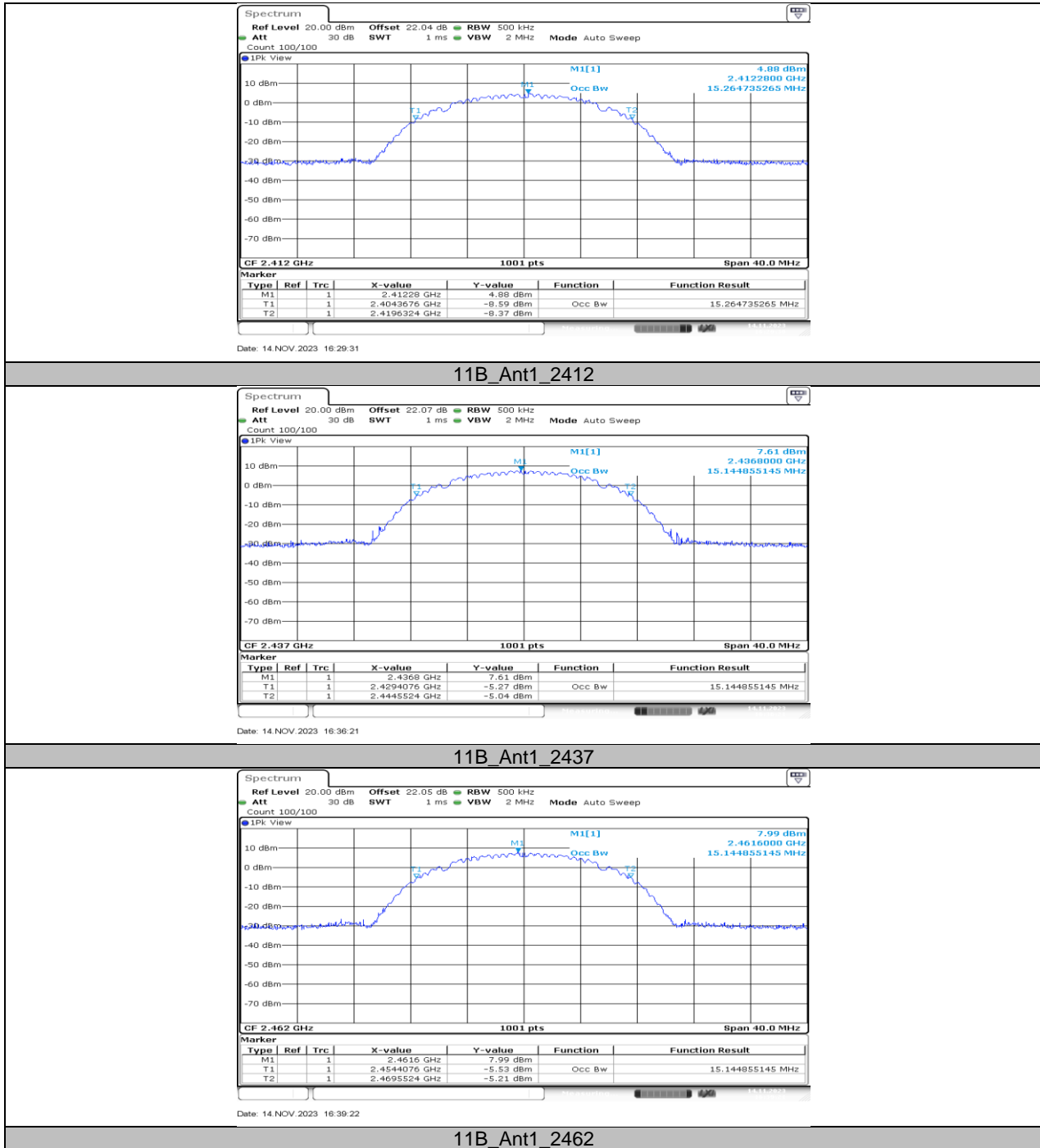

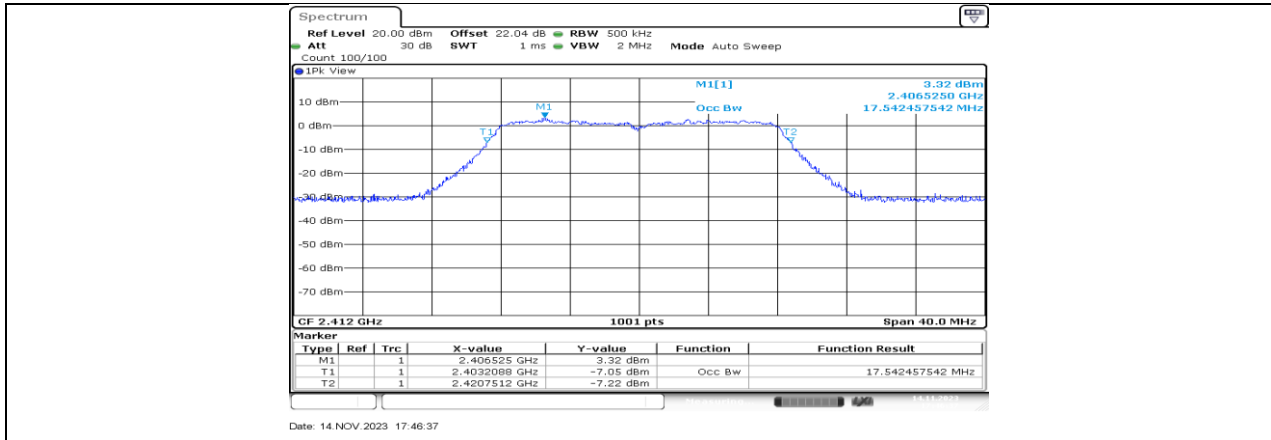

Date: 14.NOV.2023 17:46:37

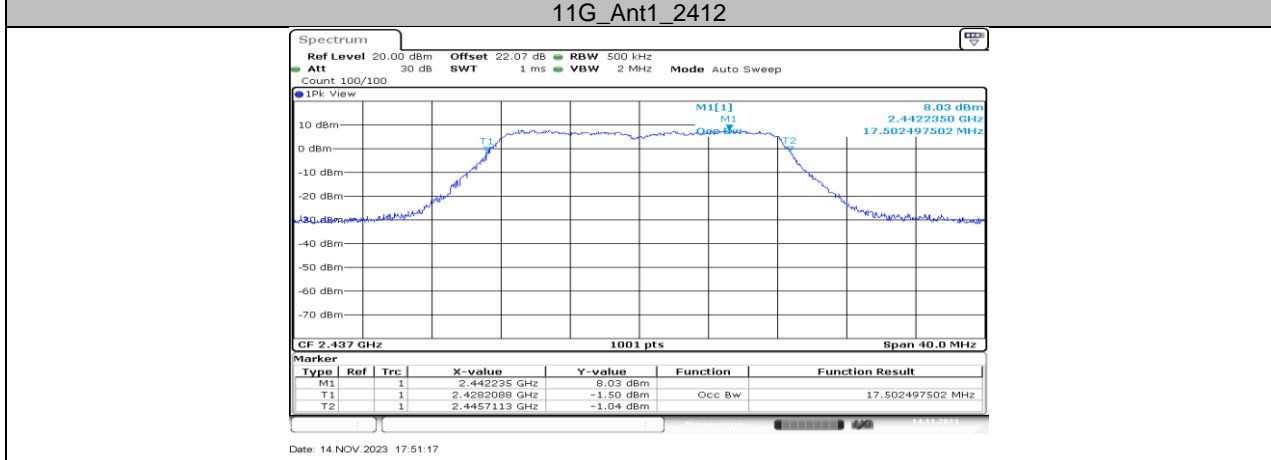

Date: 14.NOV.2023 17:51:17

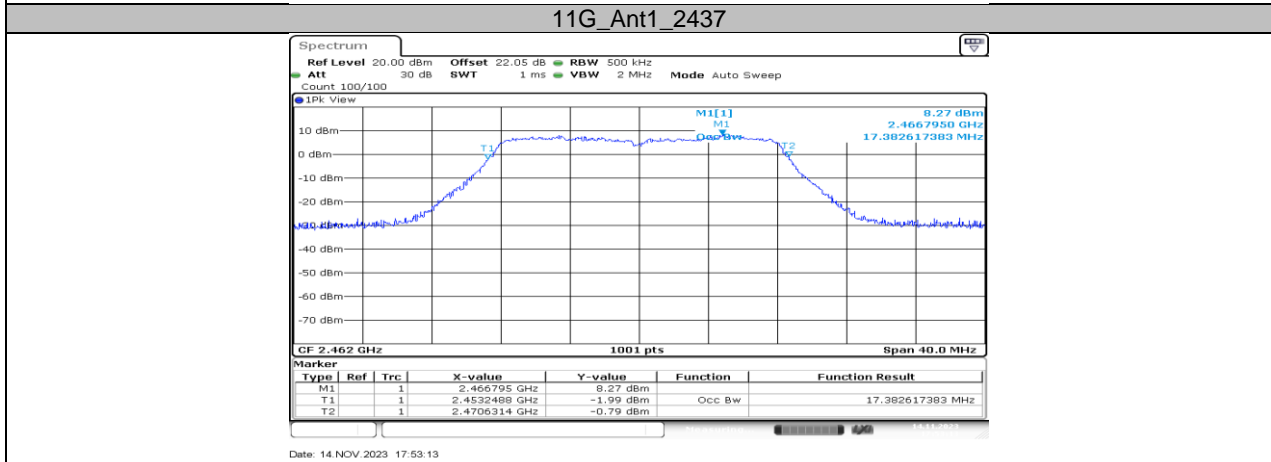

Date: 14.NOV.2023 17:53:13

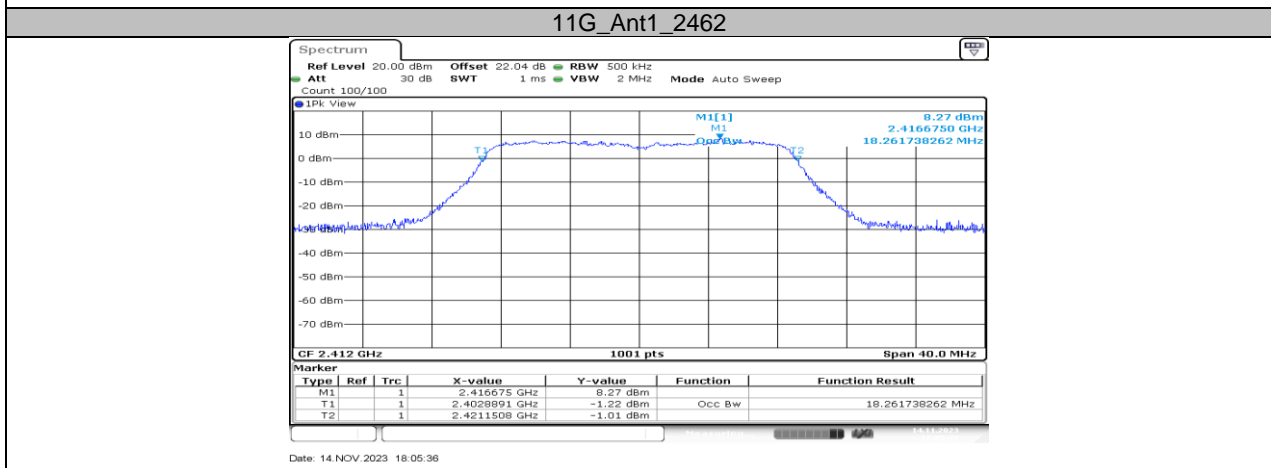

Date: 14.NOV.2023 18:05:36

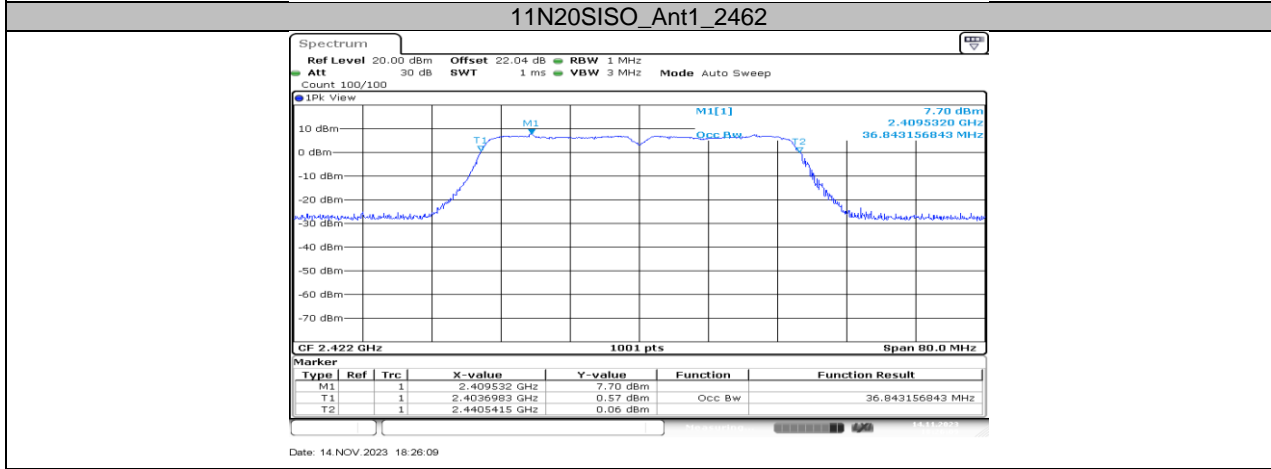
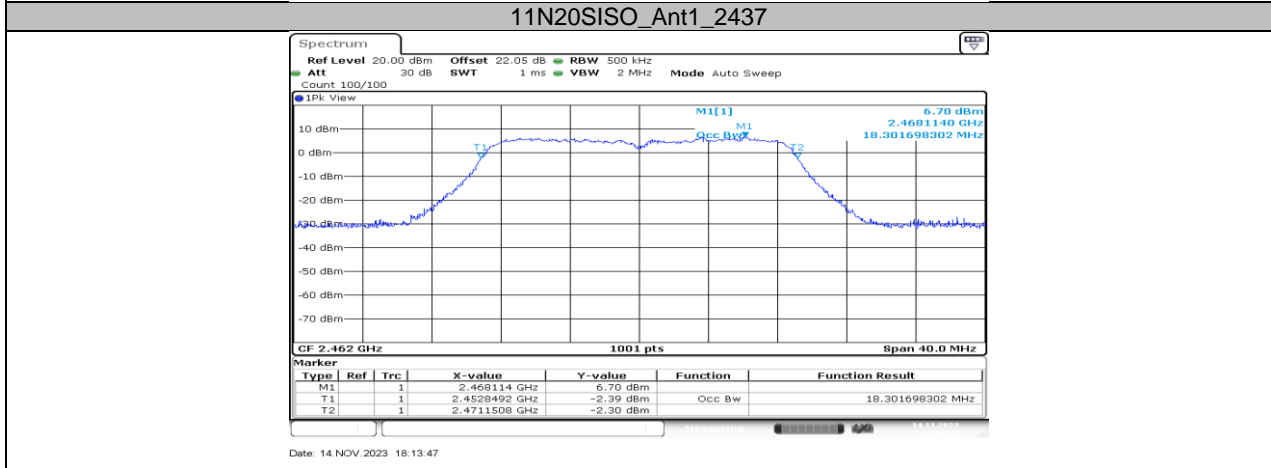
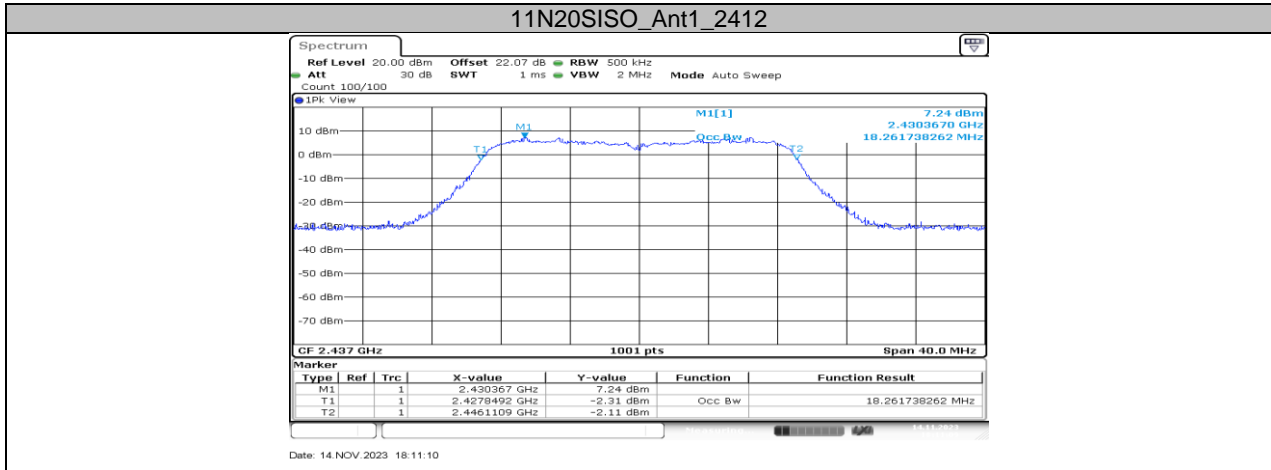

11N40SISO_Ant1_2422

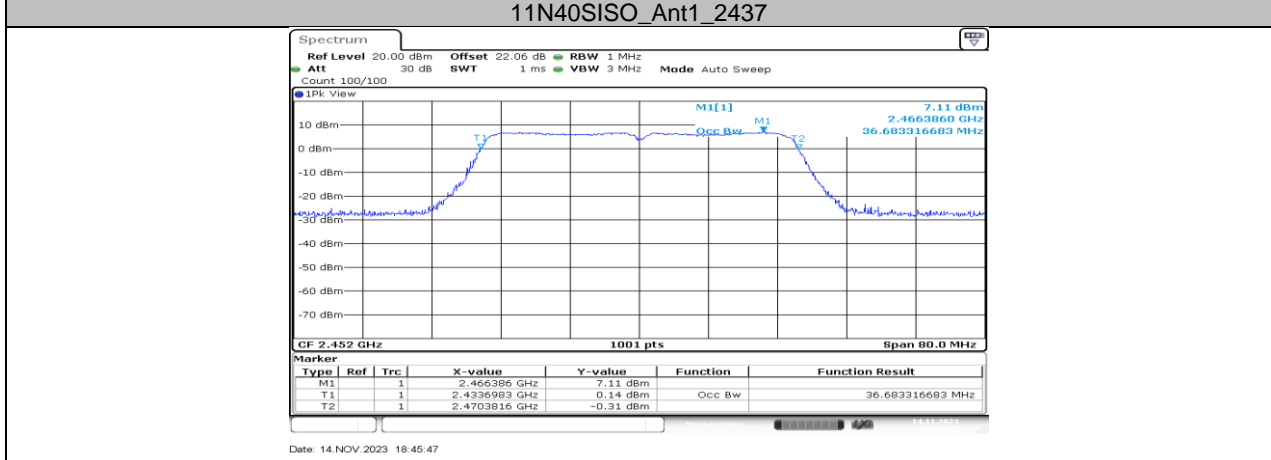
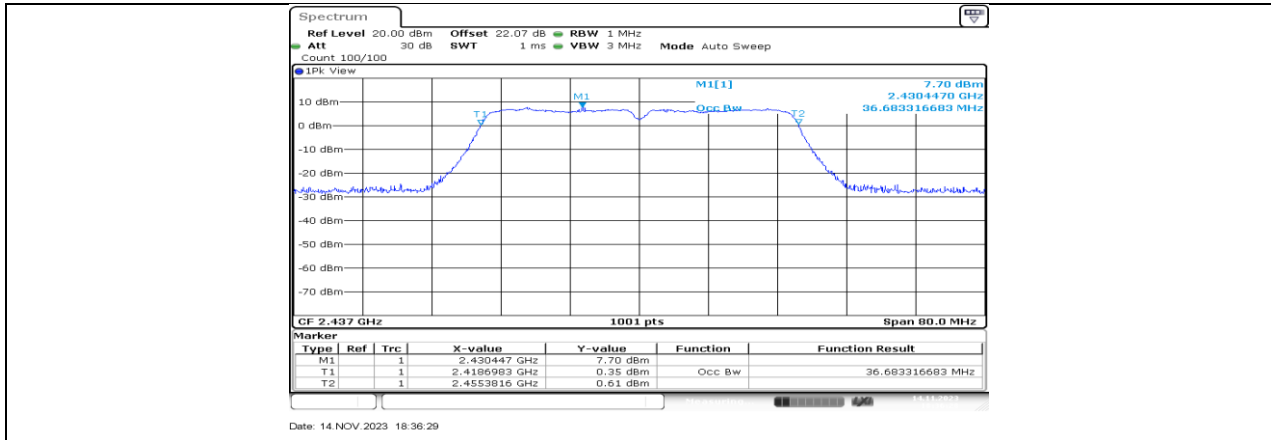

11.3. APPENDIX C: MAXIMUM CONDUCTED OUTPUT POWER

11.3.1. Test Result

Test Mode	Antenna	Frequency[MHz]	Result[dBm]	Limit[dBm]	Verdict
11B	Ant1	2412	17.28	≤30.00	PASS
		2437	16.83	≤30.00	PASS
		2462	16.84	≤30.00	PASS
11G	Ant1	2412	15.33	≤30.00	PASS
		2437	15.16	≤30.00	PASS
		2462	14.94	≤30.00	PASS
11N20SISO	Ant1	2412	14.11	≤30.00	PASS
		2437	13.97	≤30.00	PASS
		2462	14.02	≤30.00	PASS
11N40SISO	Ant1	2422	13.99	≤30.00	PASS
		2437	14.18	≤30.00	PASS
		2452	14.60	≤30.00	PASS

Note: 1. Conducted Power=Meas. Level+ Correction Factor

2. The Duty Cycle Factor (refer to section 7.5) had already compensated to the test data.

11.4. APPENDIX D: MAXIMUM POWER SPECTRAL DENSITY

11.4.1. Test Result

Test Mode	Antenna	Frequency[MHz]	Result[dBm/3kHz]	Limit[dBm/3kHz]	Verdict
11B	Ant1	2412	-15.71	≤8.00	PASS
		2437	-16.49	≤8.00	PASS
		2462	-16.02	≤8.00	PASS
11G	Ant1	2412	-16.77	≤8.00	PASS
		2437	-17.02	≤8.00	PASS
		2462	-17.02	≤8.00	PASS
11N20SISO	Ant1	2412	-18.88	≤8.00	PASS
		2437	-18.61	≤8.00	PASS
		2462	-18.37	≤8.00	PASS
11N40SISO	Ant1	2422	-20.68	≤8.00	PASS
		2437	-19.78	≤8.00	PASS
		2452	-20.27	≤8.00	PASS

Note: 1. The Duty Cycle Factor (refer to section 7.5) had already compensated to the test data.

11.4.2. Test Graphs

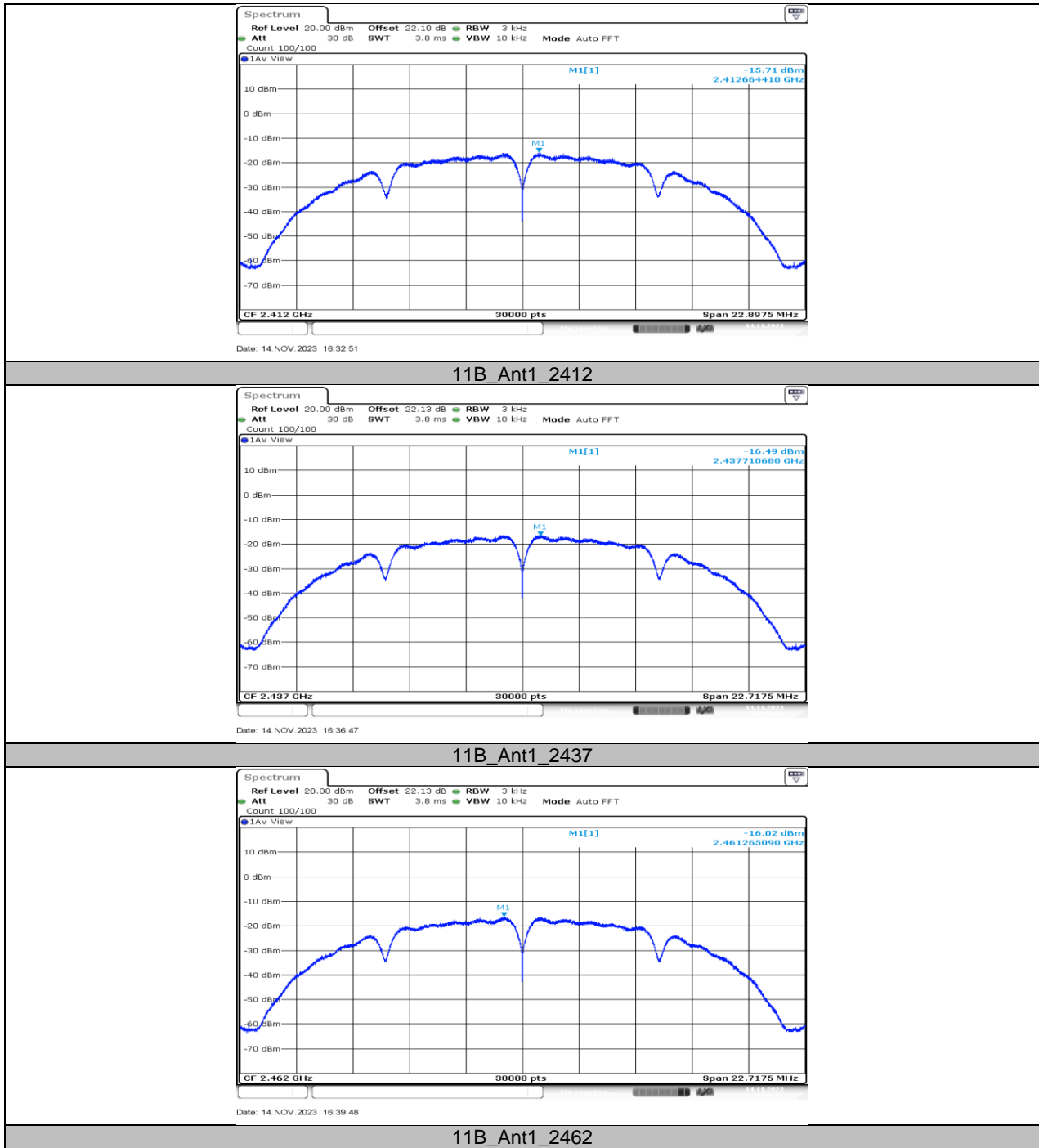

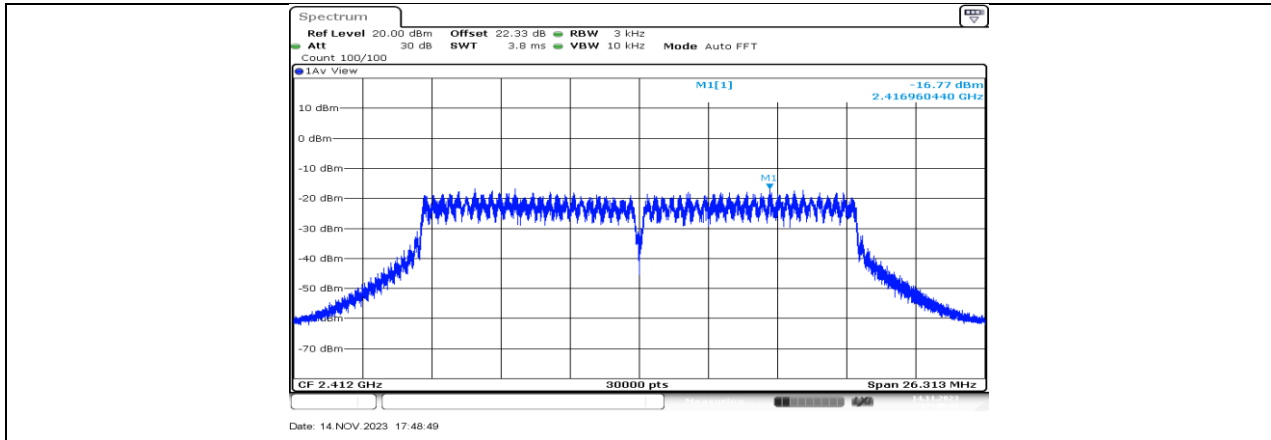

11G_Ant1_2412

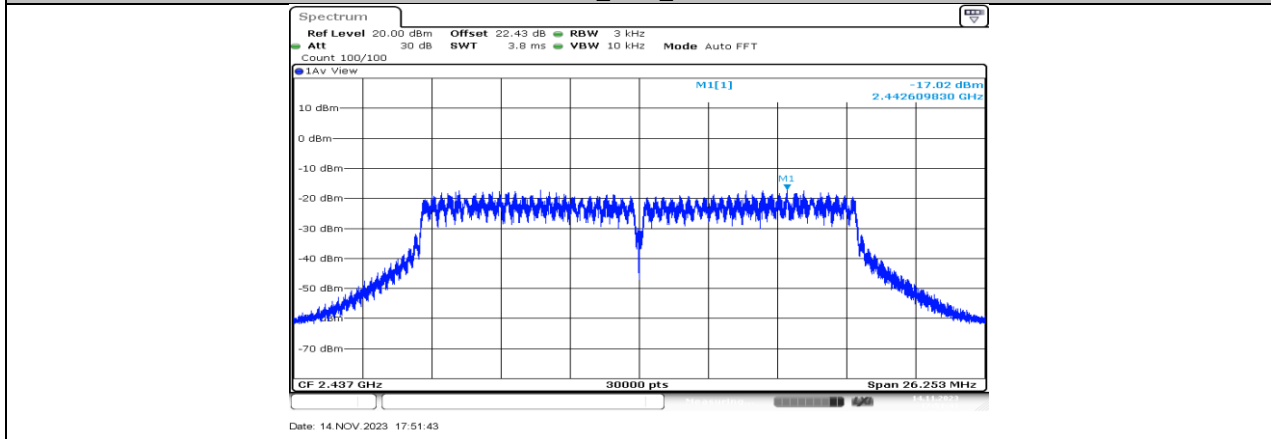

11G_Ant1_2437

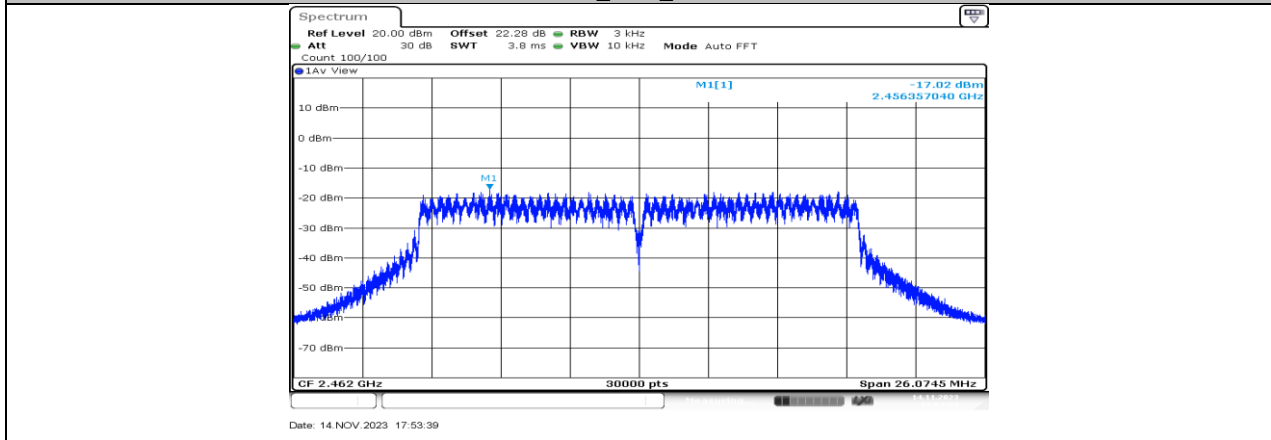

11G_Ant1_2462

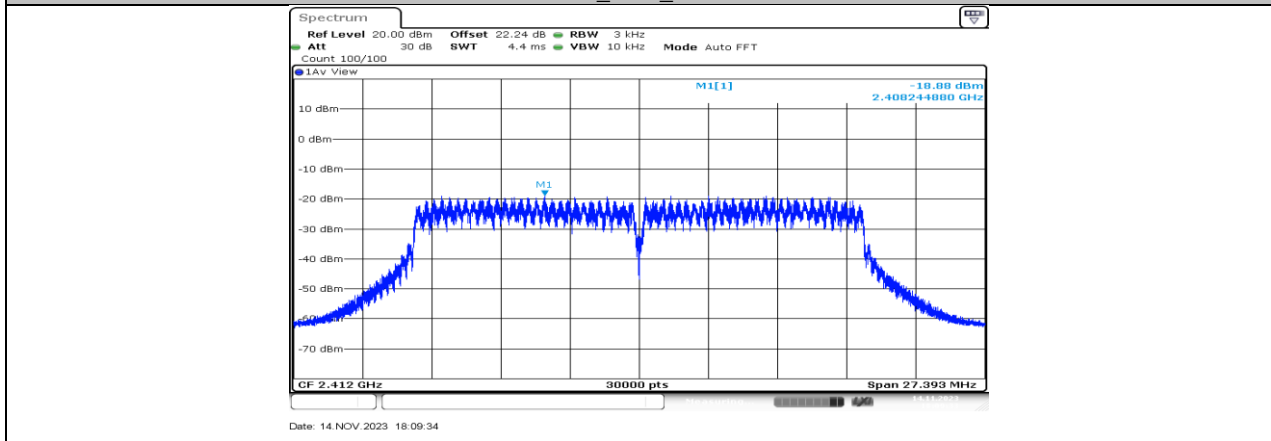

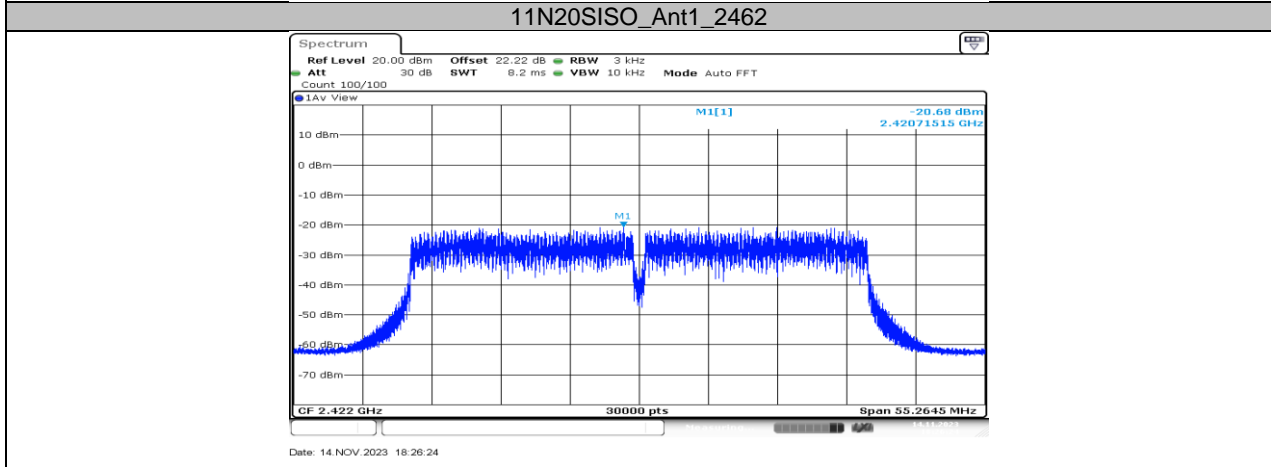
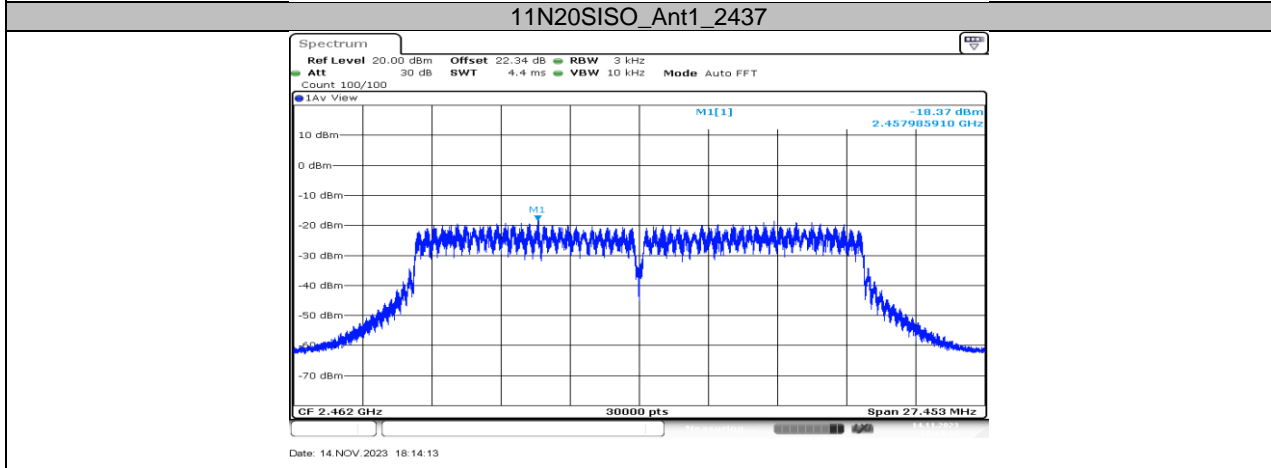
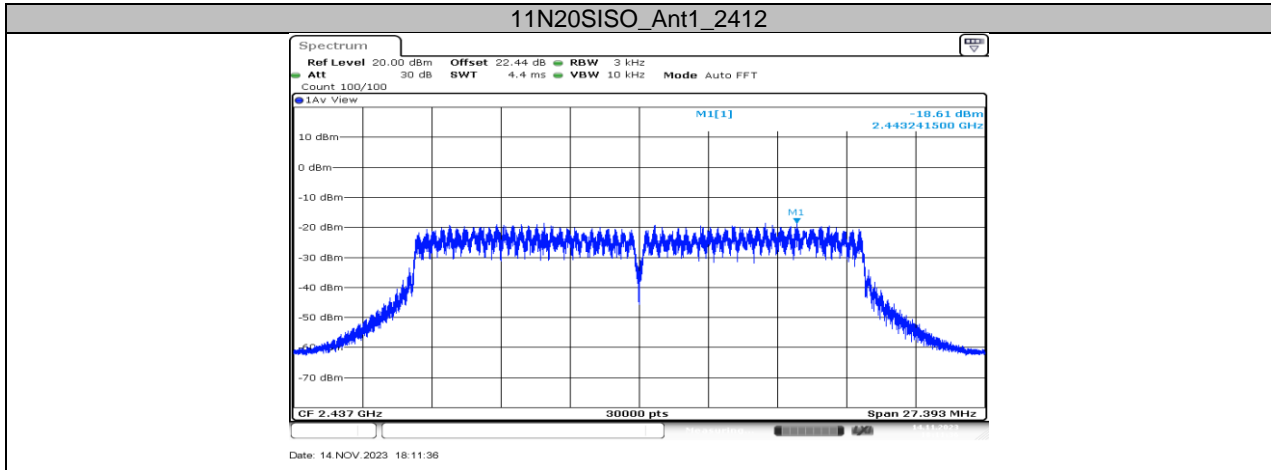

11N40SISO_Ant1_2422

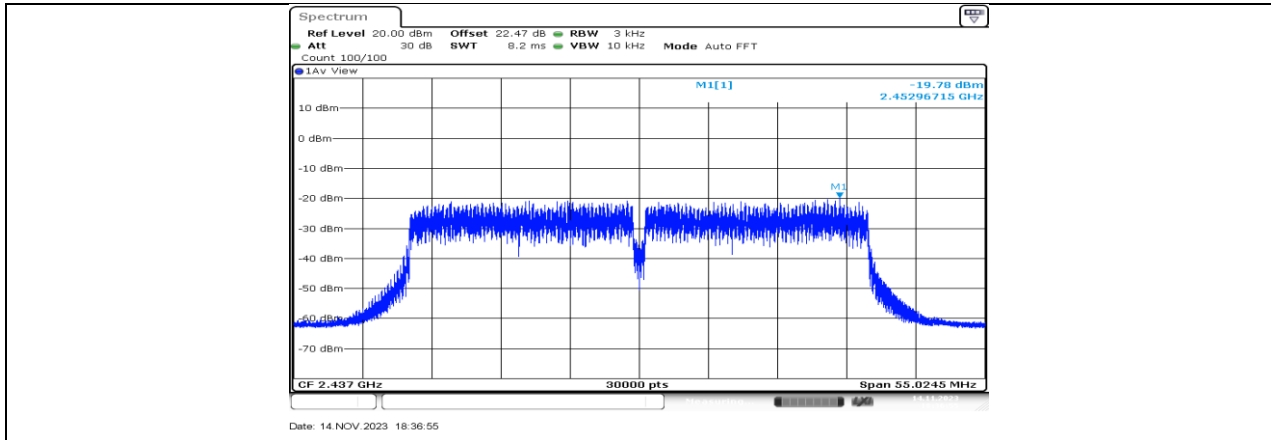

11N40SISO_Ant1_2437

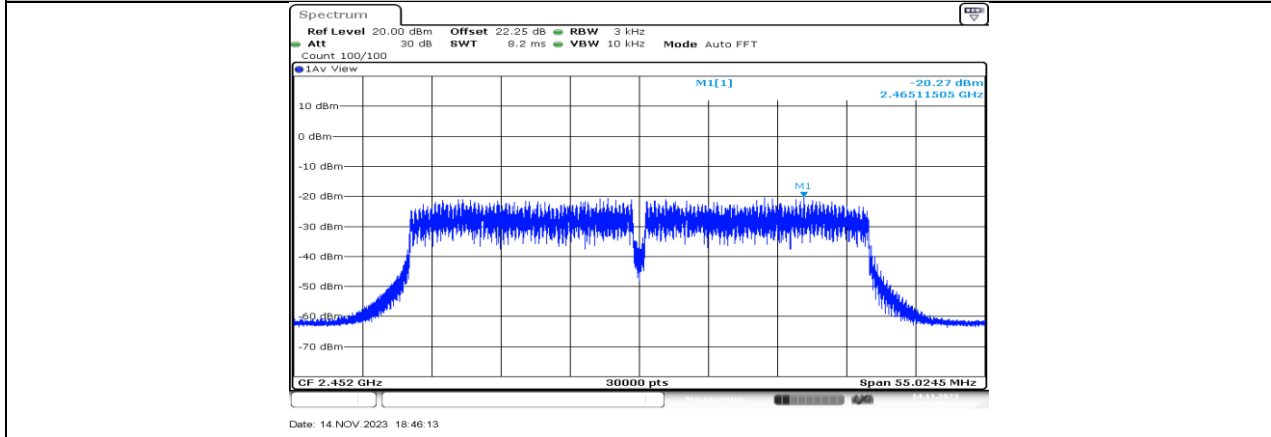

11N40SISO_Ant1_2452

11.5. APPENDIX E: BAND EDGE MEASUREMENTS

11.5.1. Test Result

Test Mode	Antenna	ChName	Frequency [MHz]	RefLevel [dBm]	Result [dBm]	Limit[dBm]	Verdict
11B	Ant1	Low	2412	6.56	-34.94	≤-23.44	PASS
		High	2462	6.44	-36.55	≤-23.56	PASS
11G	Ant1	Low	2412	3.20	-35.06	≤-26.8	PASS
		High	2462	2.89	-35.92	≤-27.11	PASS
11N20SISO	Ant1	Low	2412	1.16	-35.09	≤-28.84	PASS
		High	2462	1.72	-36.7	≤-28.28	PASS
11N40SISO	Ant1	Low	2422	-0.71	-35.26	≤-30.71	PASS
		High	2452	-0.90	-36.38	≤-30.9	PASS

11.5.2. Test Graphs

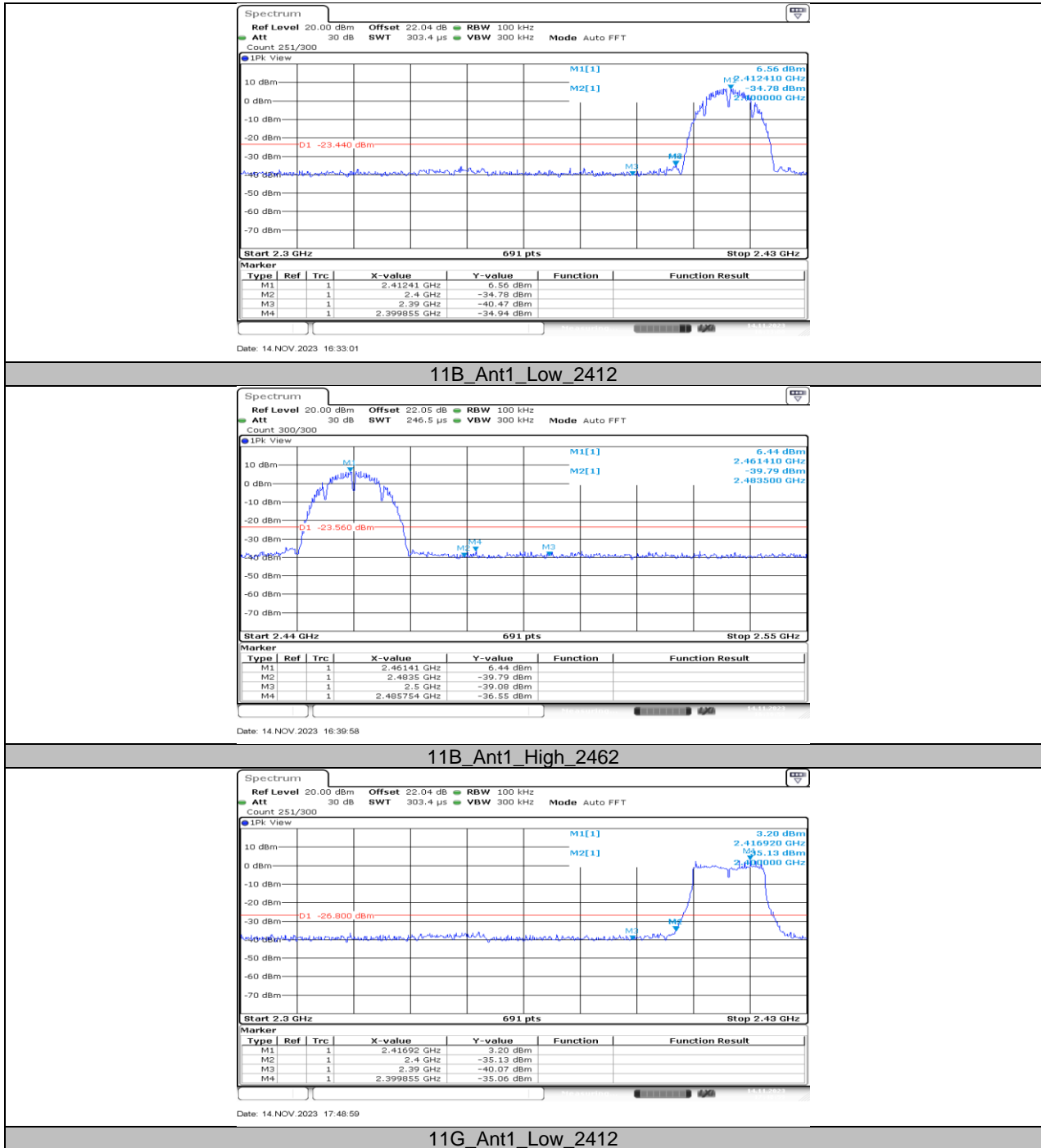

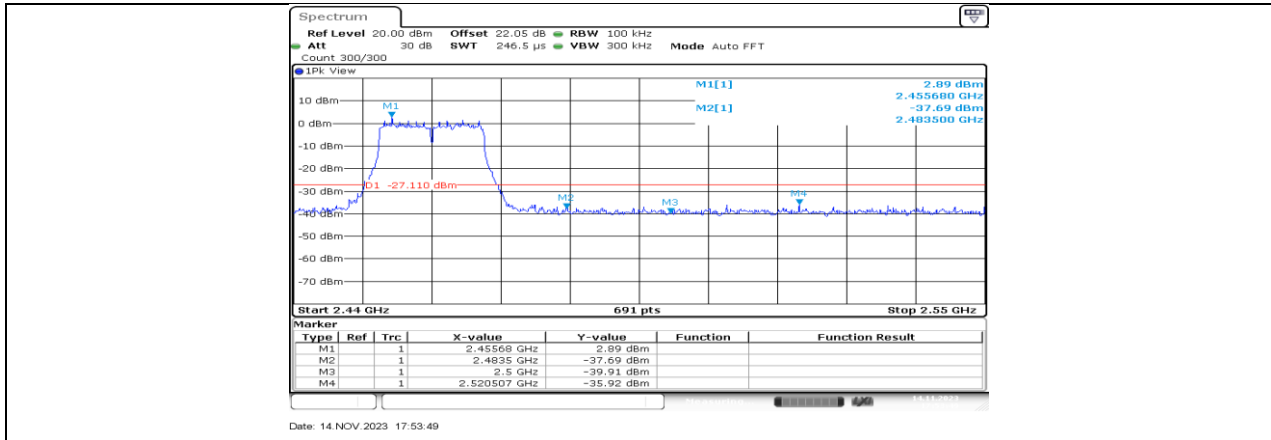

Date: 14.NOV.2023 17:53:49

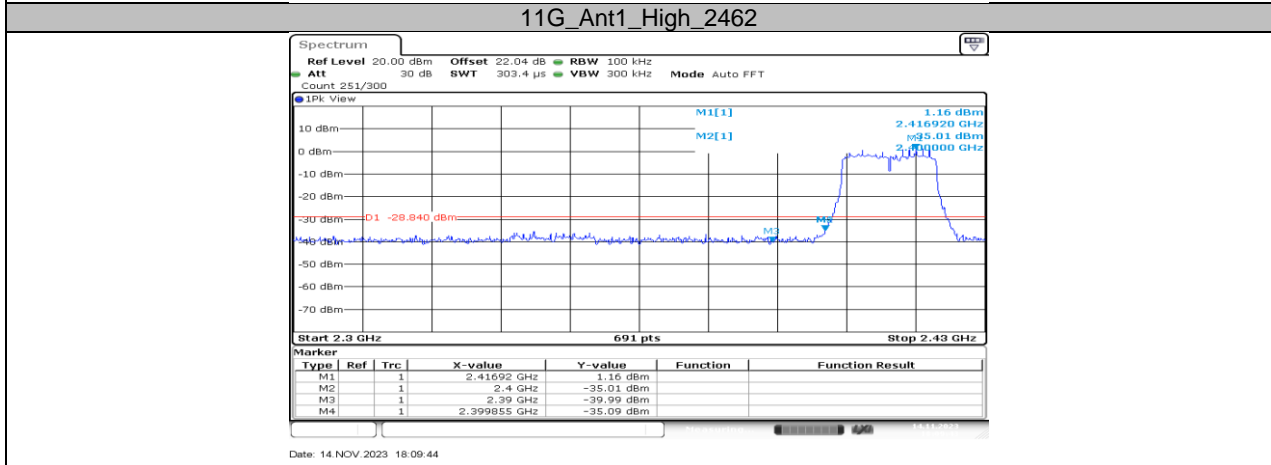

Date: 14.NOV.2023 18:09:44

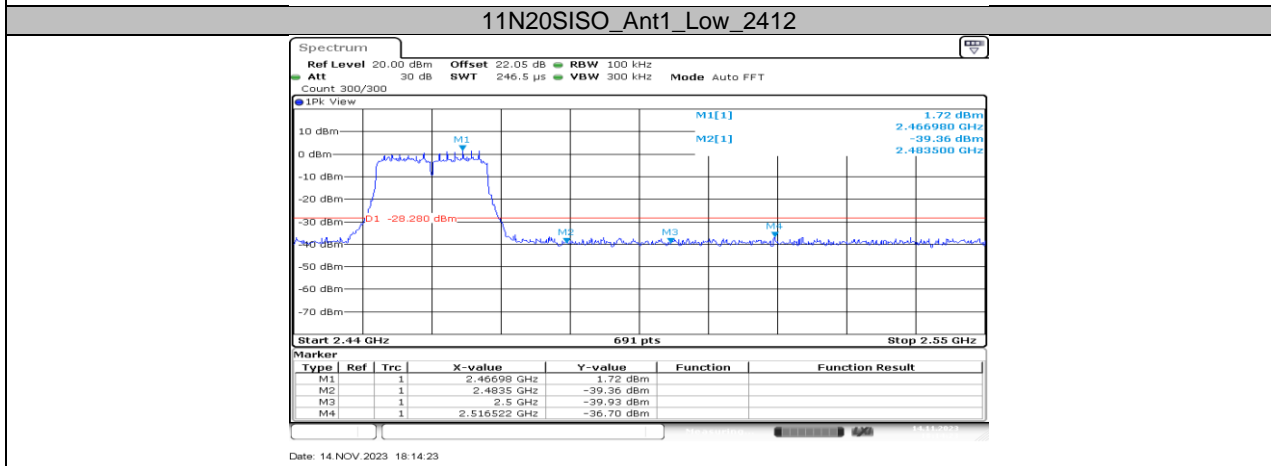

Date: 14.NOV.2023 18:14:23

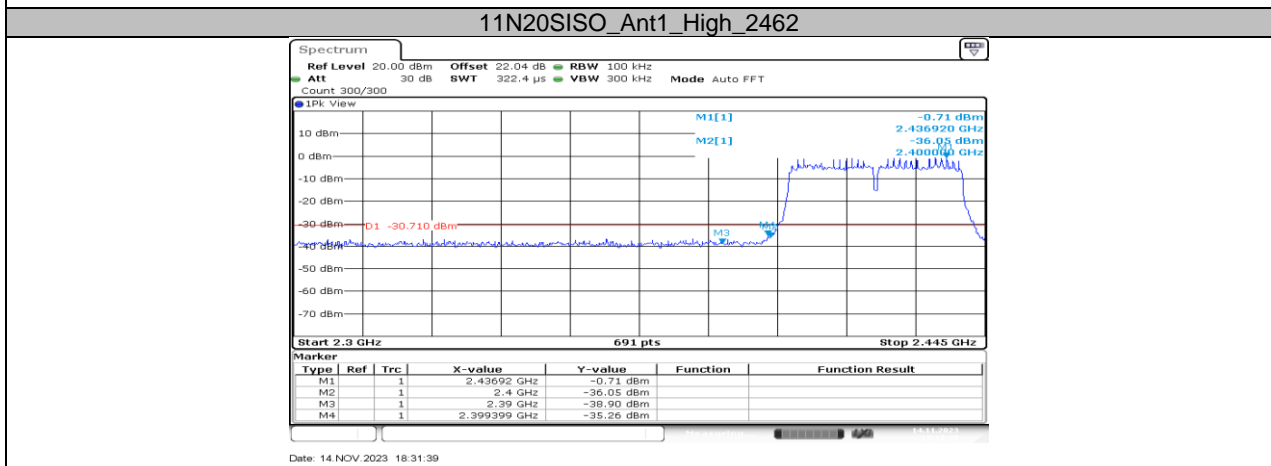

Date: 14.NOV.2023 18:31:39

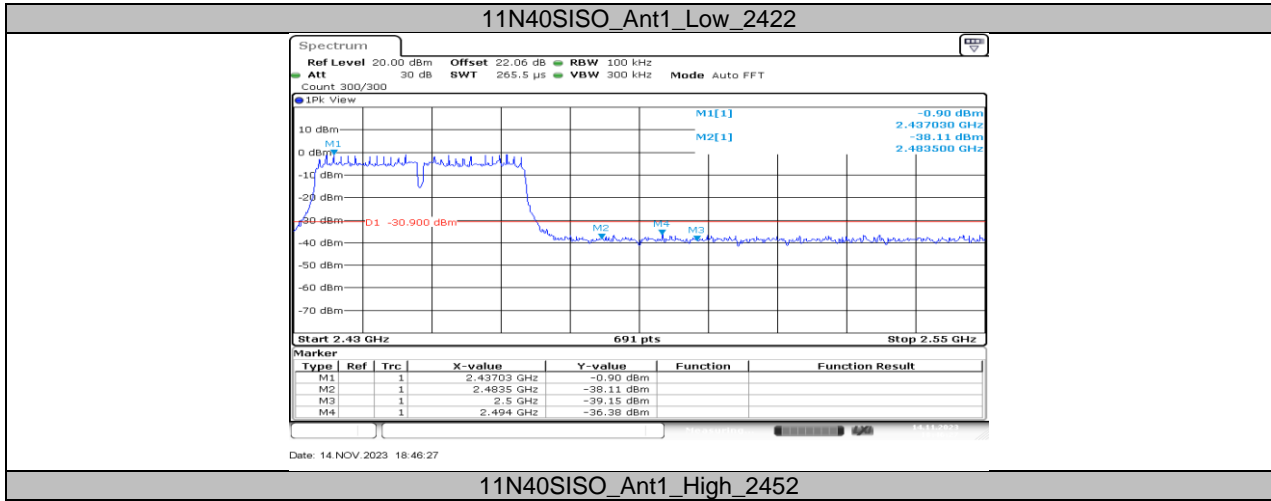

11.6. APPENDIX F: CONDUCTED SPURIOUS EMISSION

11.6.1. Test Result

Test Mode	Antenna	Frequency[MHz]	FreqRange [Mhz]	Result [dBm]	Limit [dBm]	Verdict
11B	Ant1	2412	Reference	7.10	---	PASS
			30~1000	-45.74	≤-22.9	PASS
			1000~26500	-43.34	≤-22.9	PASS
		2437	Reference	6.94	---	PASS
			30~1000	-45.77	≤-23.06	PASS
			1000~26500	-43.85	≤-23.06	PASS
		2462	Reference	7.05	---	PASS
			30~1000	-45.55	≤-22.95	PASS
			1000~26500	-43.26	≤-22.95	PASS
11G	Ant1	2412	Reference	3.36	---	PASS
			30~1000	-45.91	≤-26.64	PASS
			1000~26500	-43.78	≤-26.64	PASS
		2437	Reference	2.37	---	PASS
			30~1000	-45.09	≤-27.63	PASS
			1000~26500	-43.99	≤-27.63	PASS
		2462	Reference	3.01	---	PASS
			30~1000	-45.33	≤-26.99	PASS
			1000~26500	-43.22	≤-26.99	PASS
11N20SISO	Ant1	2412	Reference	2.13	---	PASS
			30~1000	-45.78	≤-27.87	PASS
			1000~26500	-43.22	≤-27.87	PASS
		2437	Reference	2.12	---	PASS
			30~1000	-45.27	≤-27.88	PASS
			1000~26500	-44.24	≤-27.88	PASS
		2462	Reference	1.97	---	PASS
			30~1000	-45.56	≤-28.03	PASS
			1000~26500	-43.06	≤-28.03	PASS
11N40SISO	Ant1	2422	Reference	-0.63	---	PASS
			30~1000	-44.85	≤-30.63	PASS
			1000~26500	-43.34	≤-30.63	PASS
		2437	Reference	-0.75	---	PASS
			30~1000	-44.3	≤-30.75	PASS
			1000~26500	-43.56	≤-30.75	PASS
		2452	Reference	-0.72	---	PASS
			30~1000	-45.75	≤-30.72	PASS
			1000~26500	-43.44	≤-30.72	PASS

11.6.2. Test Graphs

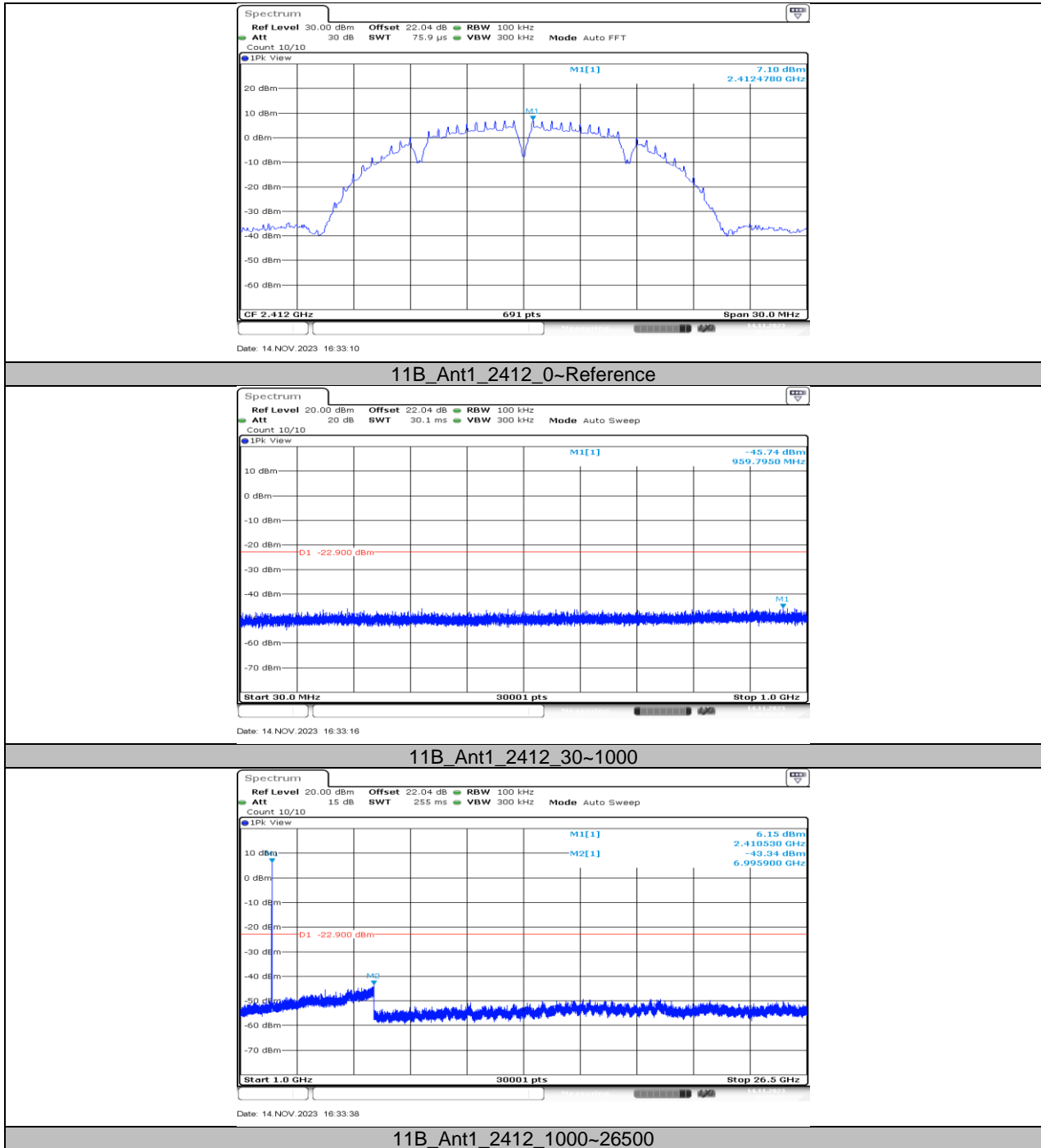

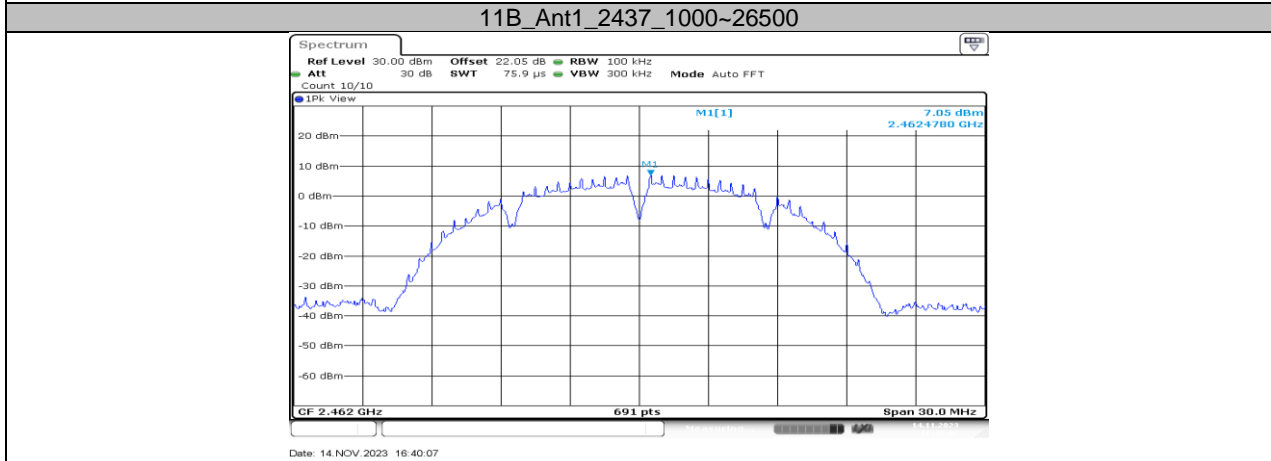
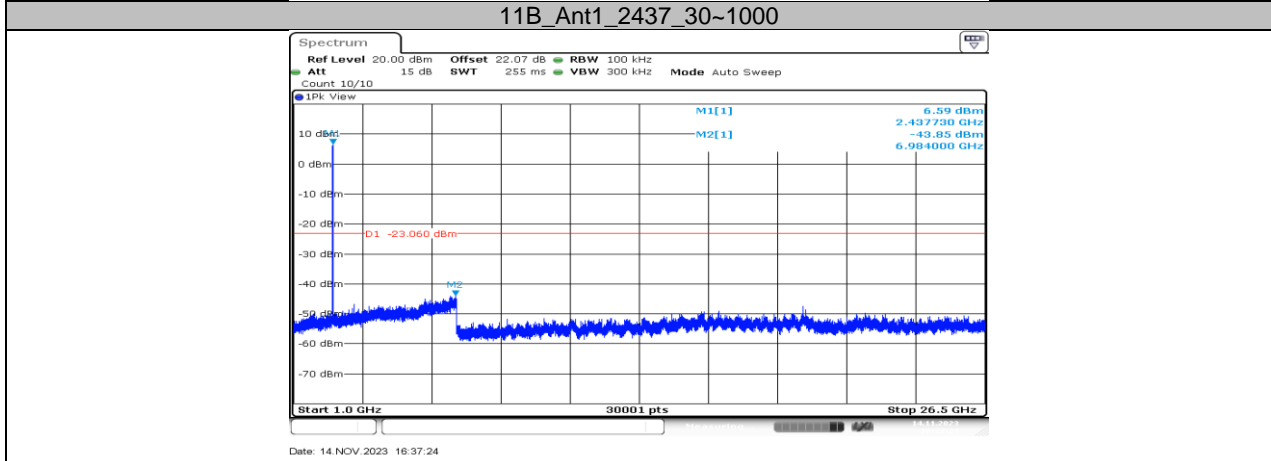
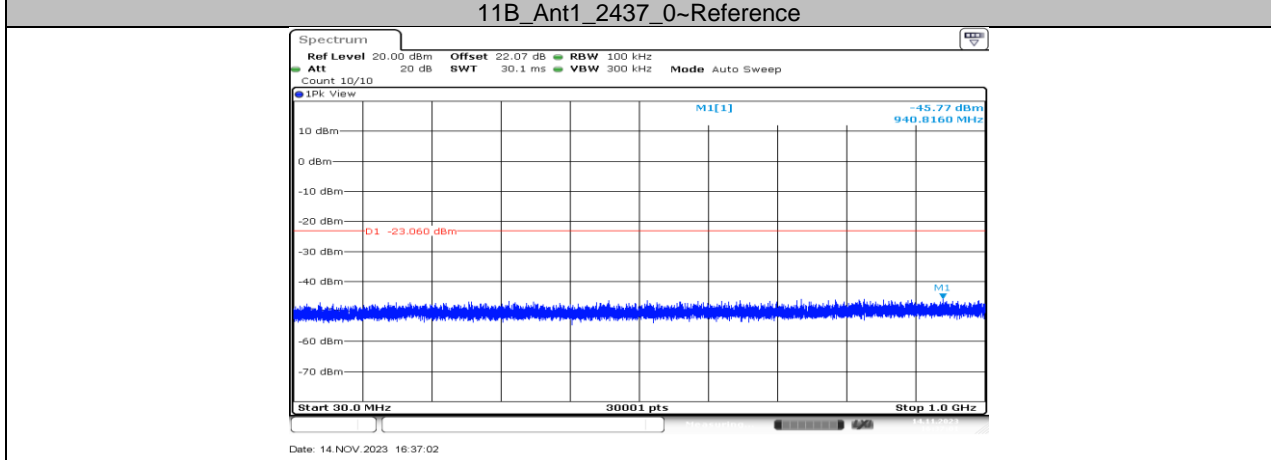
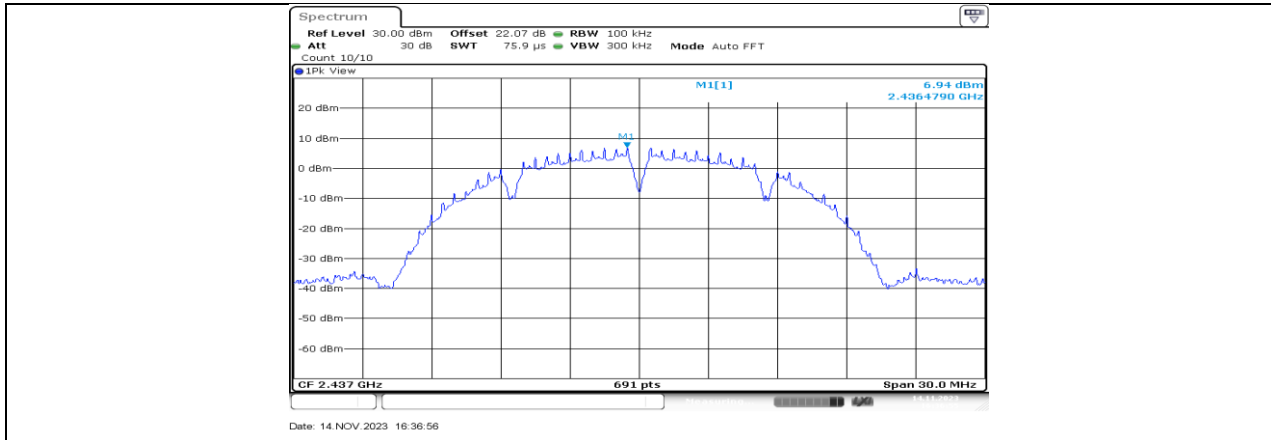

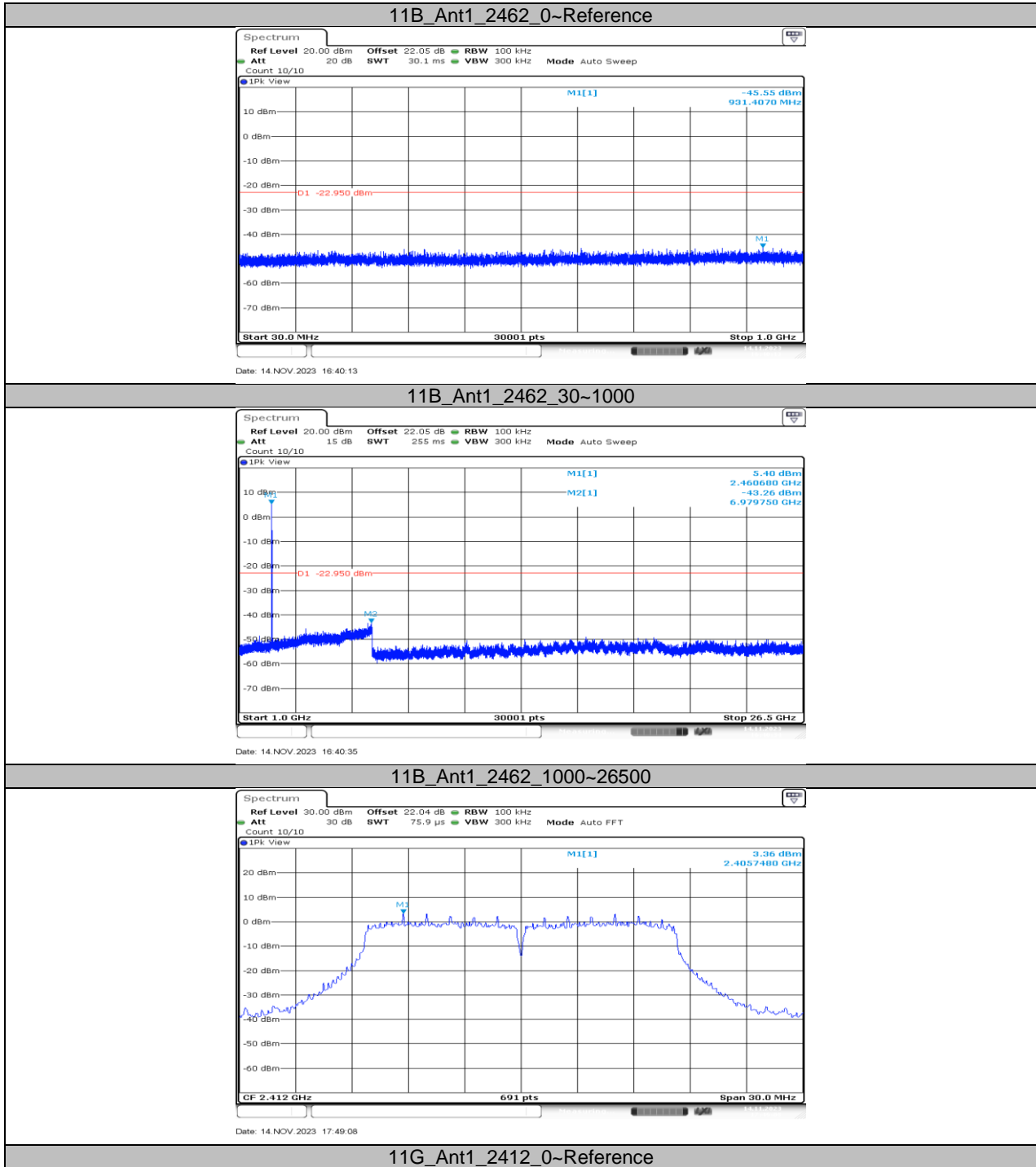

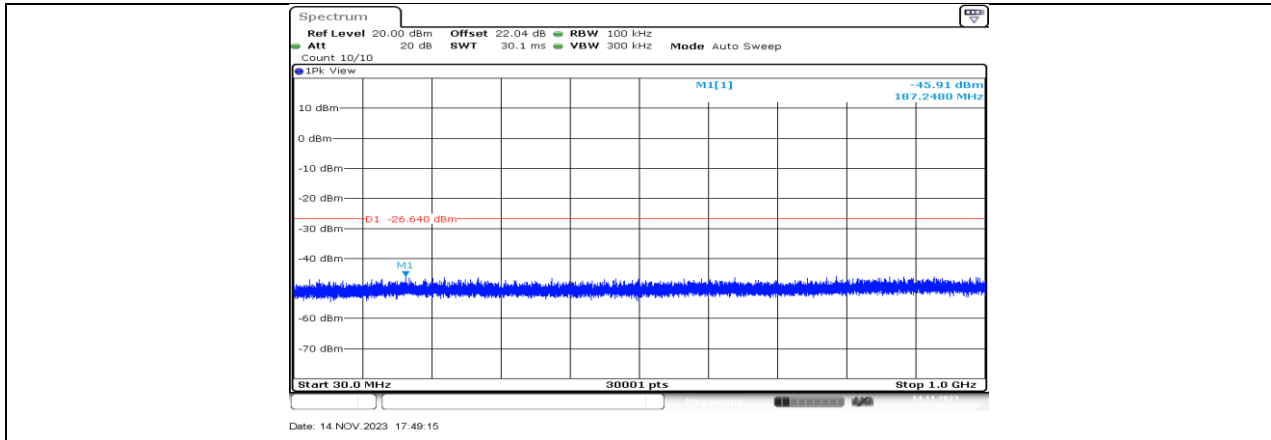

Date: 14.NOV.2023 17:49:15

11G_Ant1_2412_30~1000

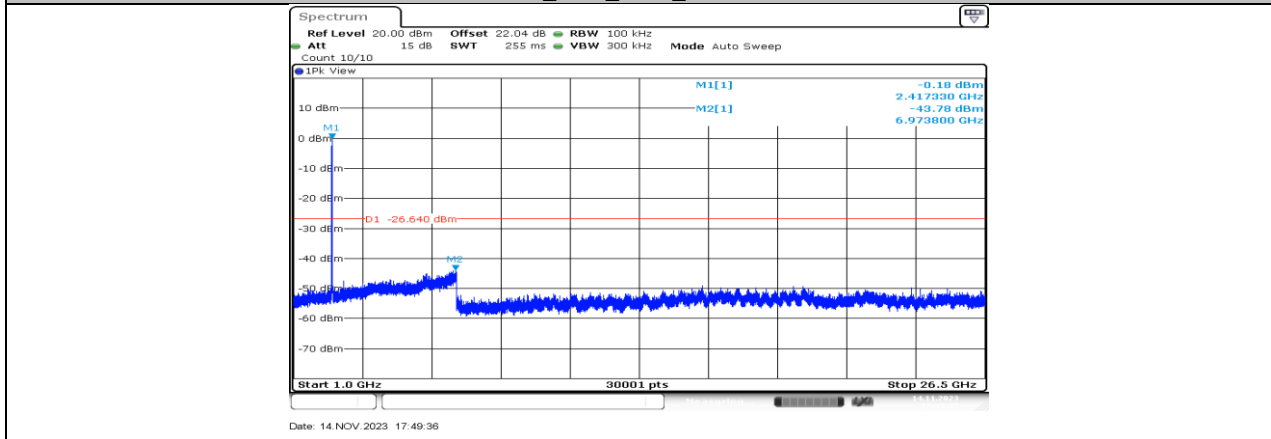

Date: 14.NOV.2023 17:49:36

11G_Ant1_2412_1000~26500

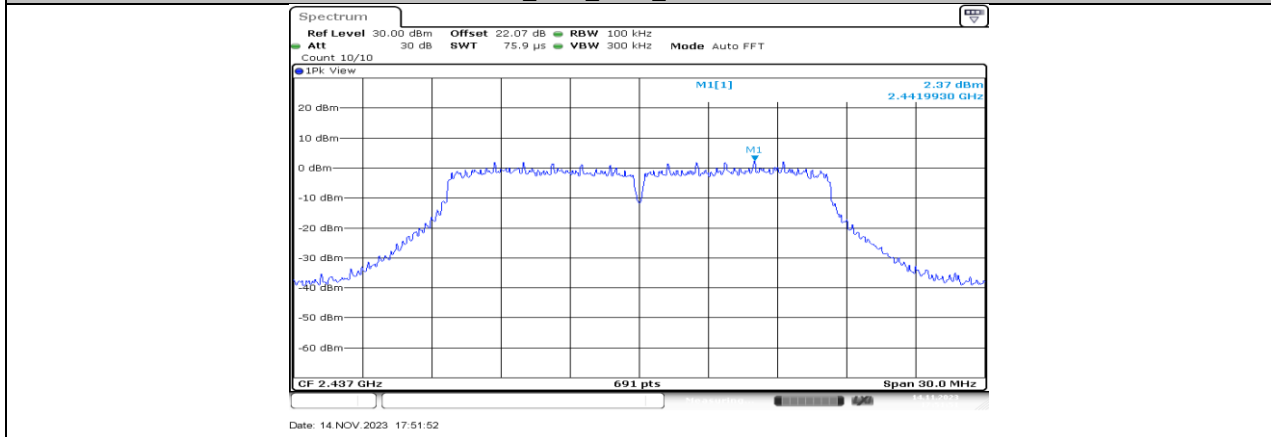

Date: 14.NOV.2023 17:51:52

11G_Ant1_2437_0~Reference

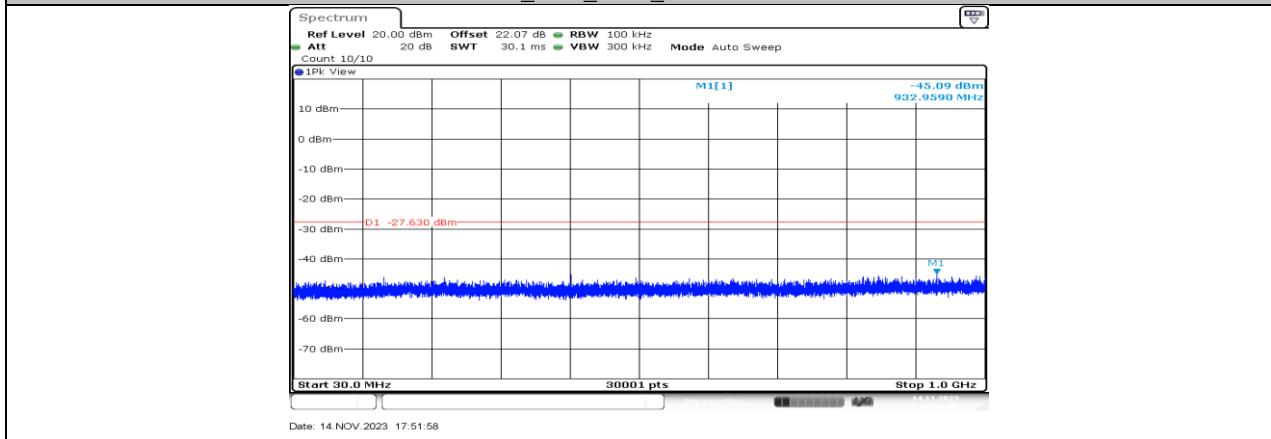

Date: 14.NOV.2023 17:51:58

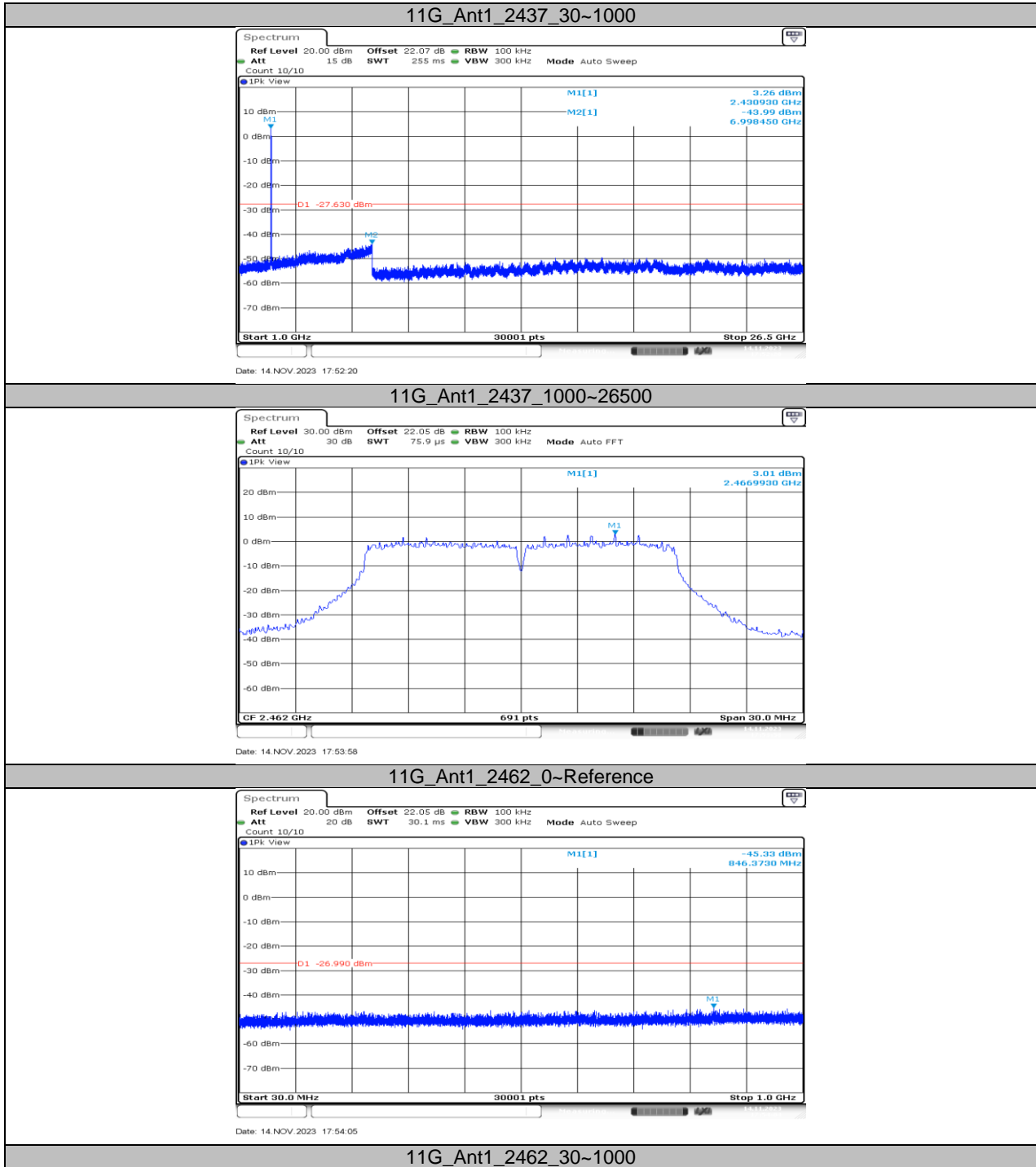

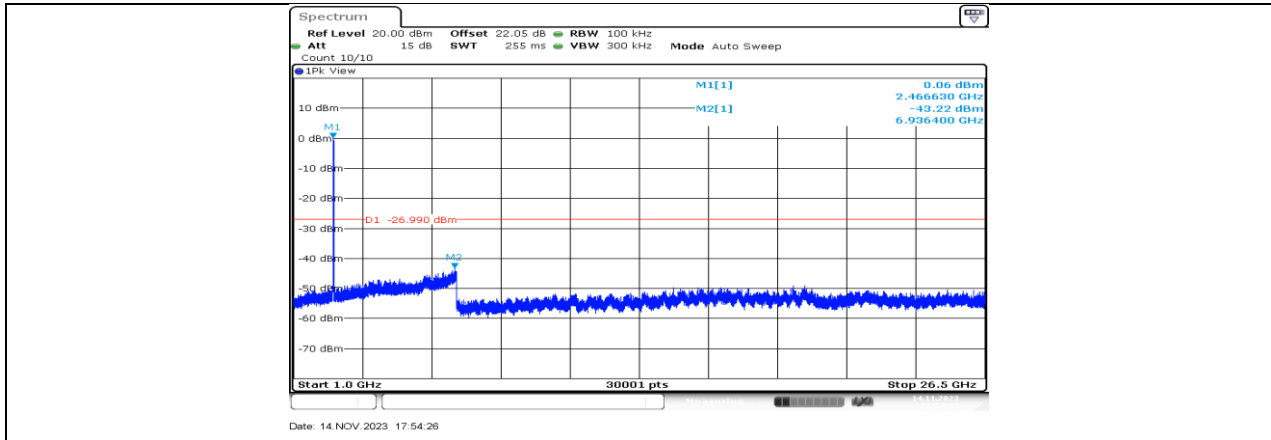

11G_Ant1_2462_1000~26500

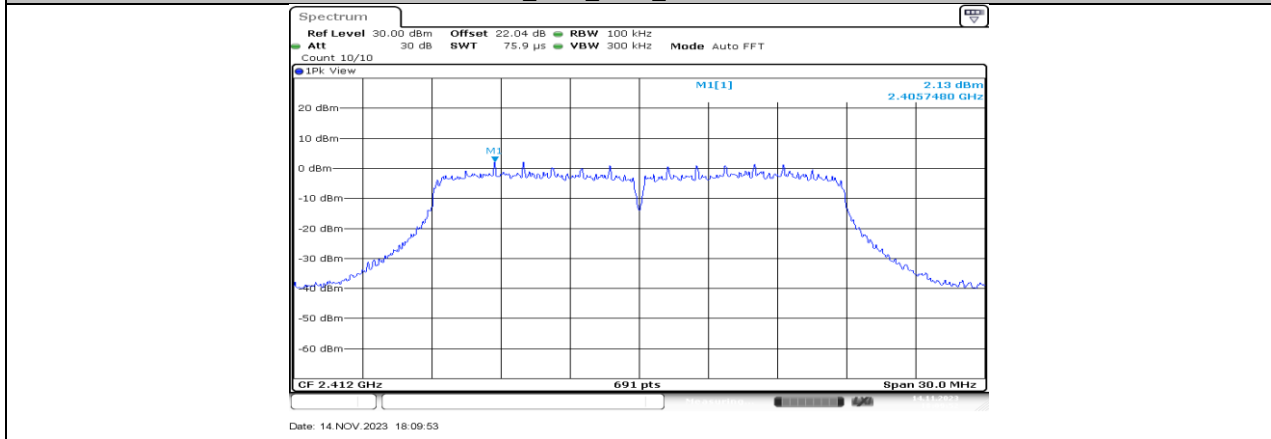

11N20SISO_Ant1_2412_0~Reference

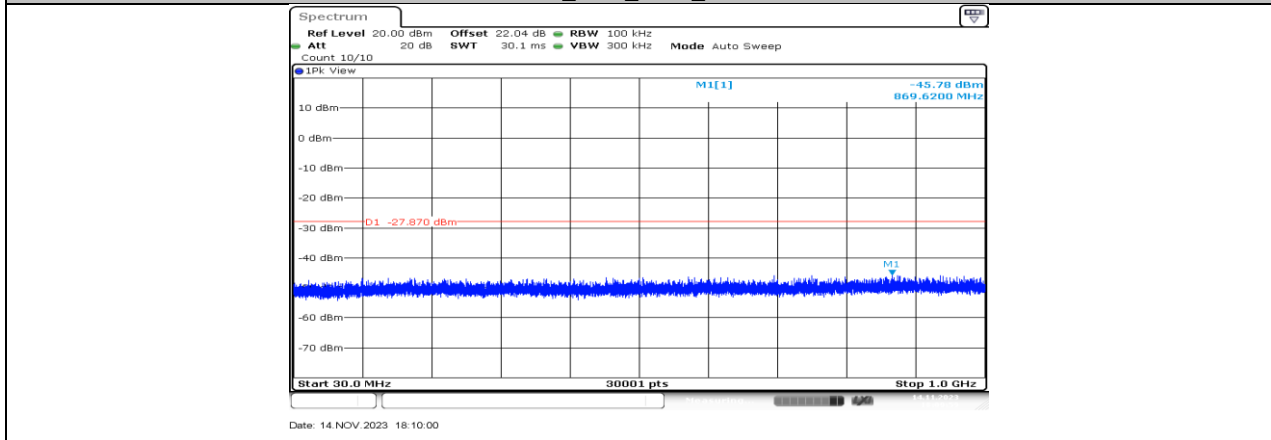

11N20SISO_Ant1_2412_30~1000

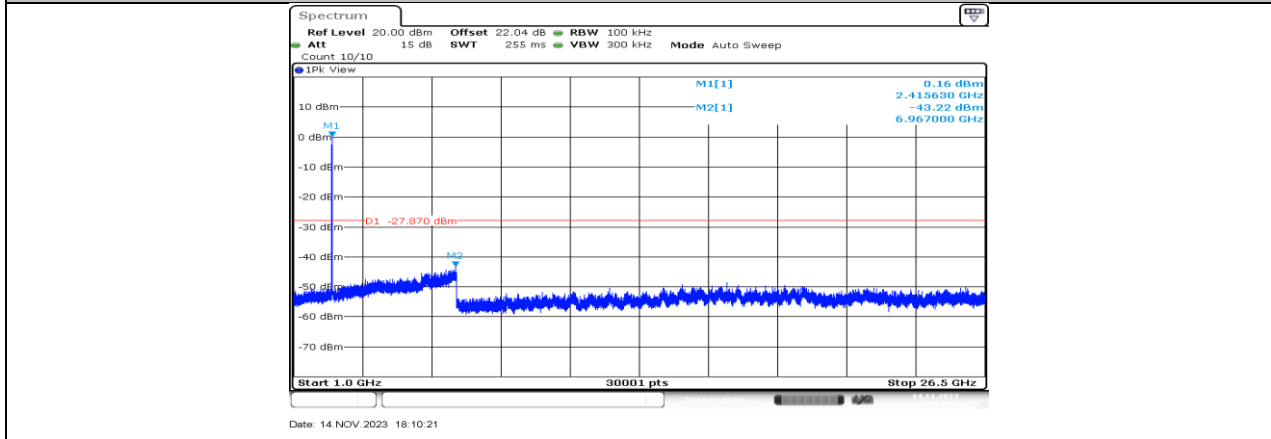

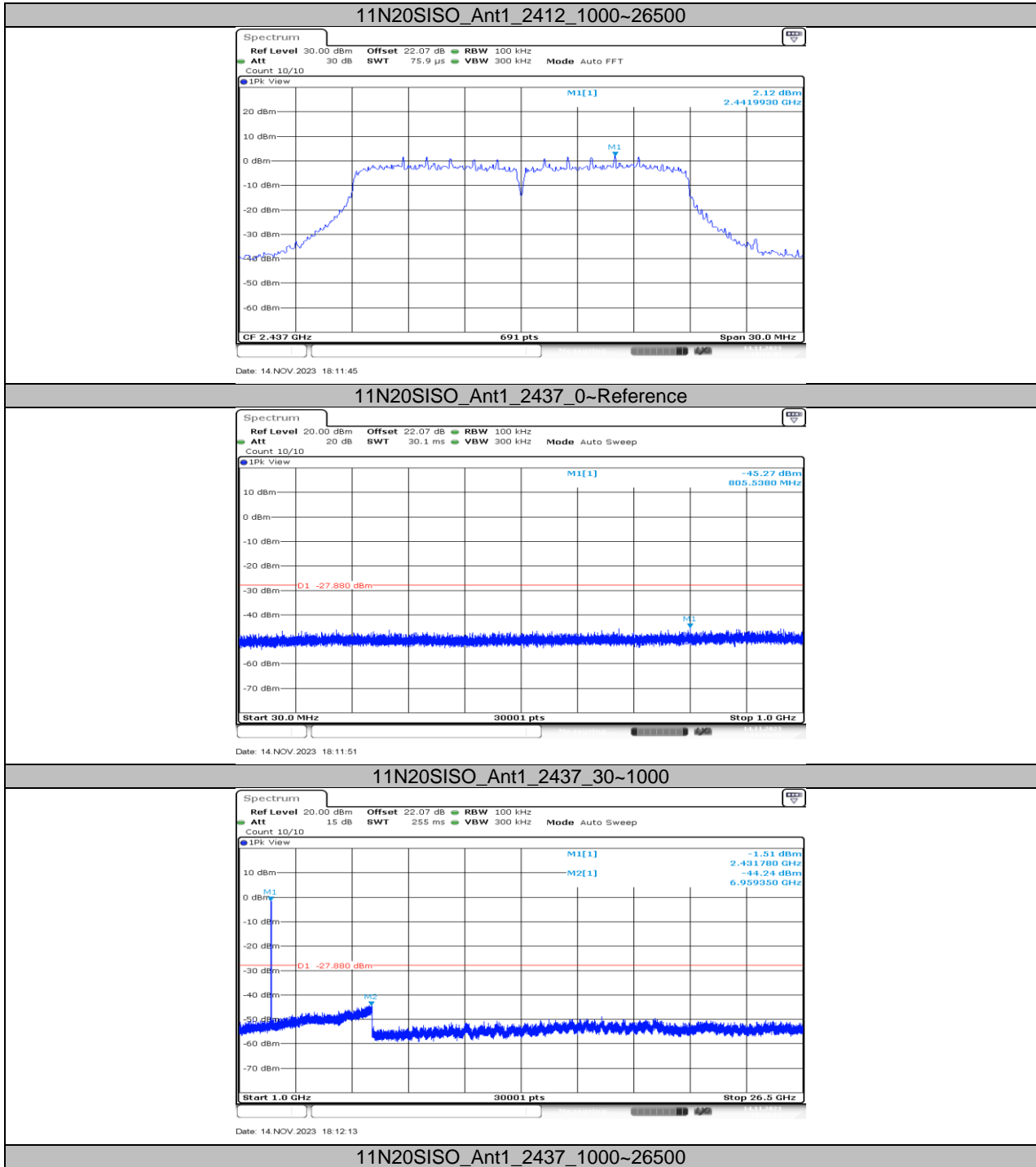

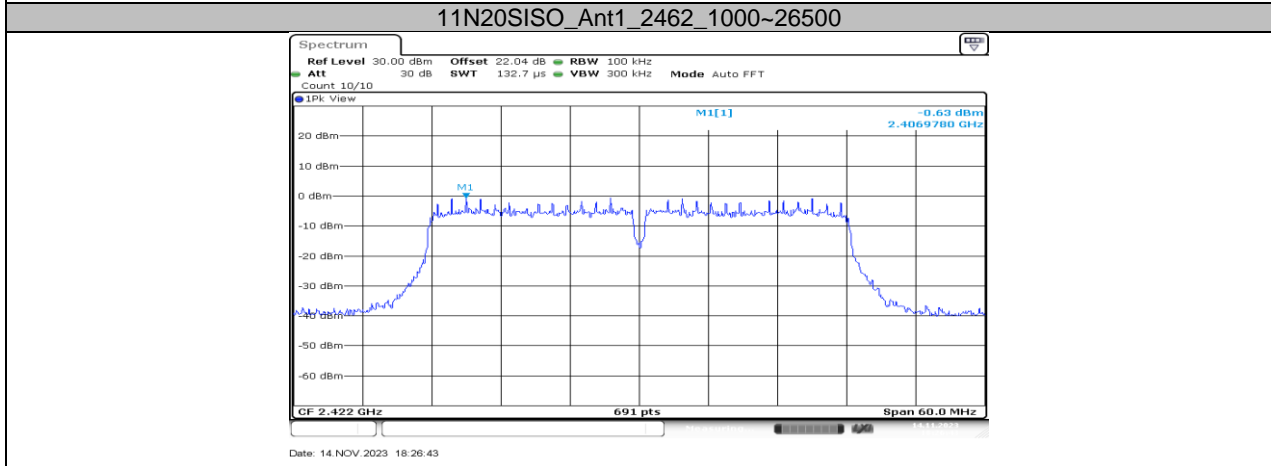
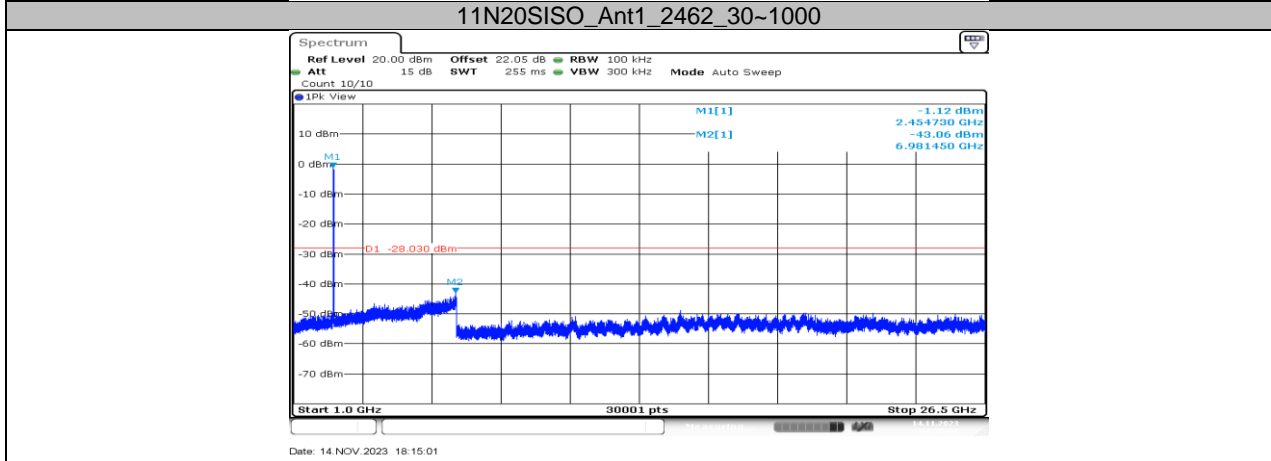
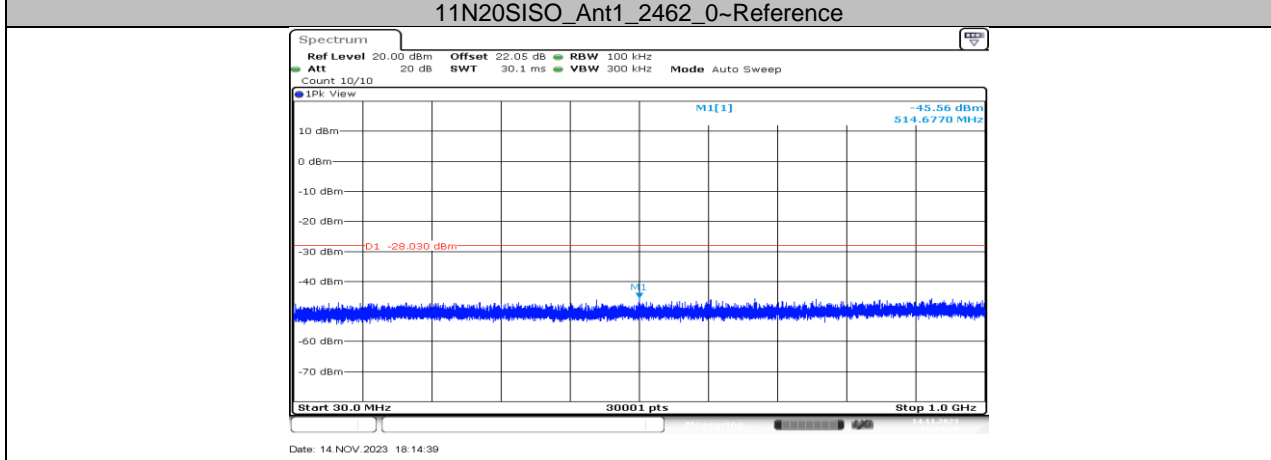
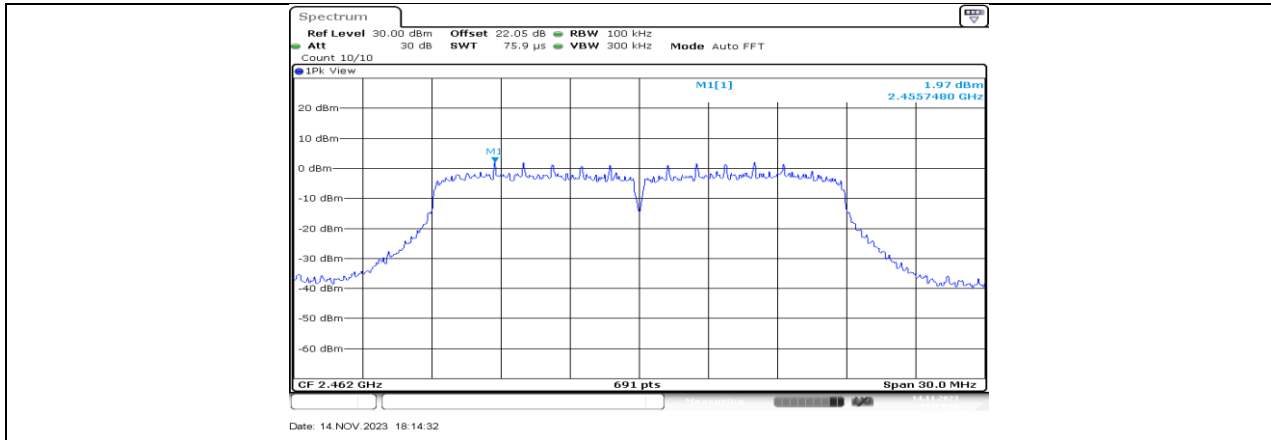

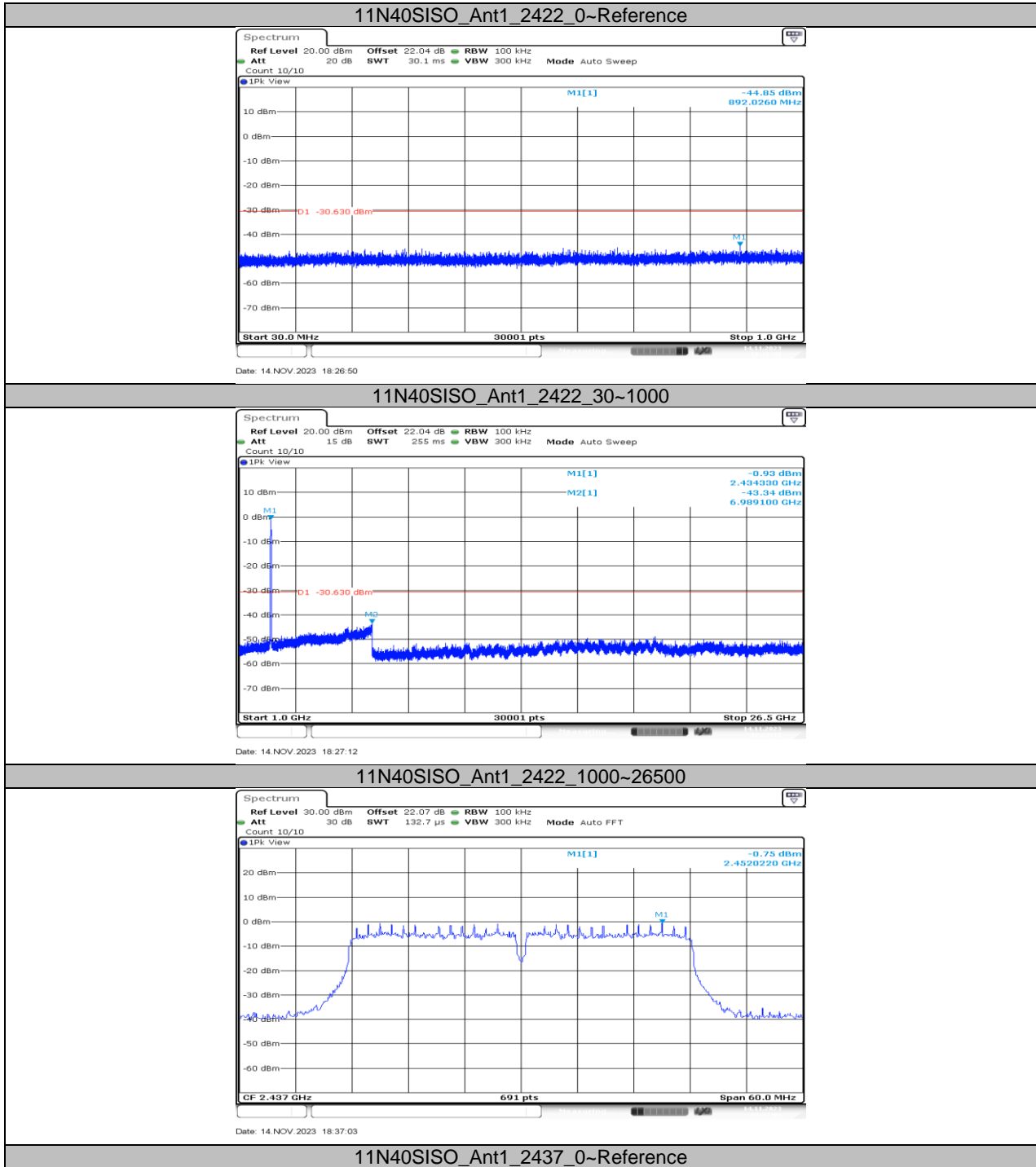

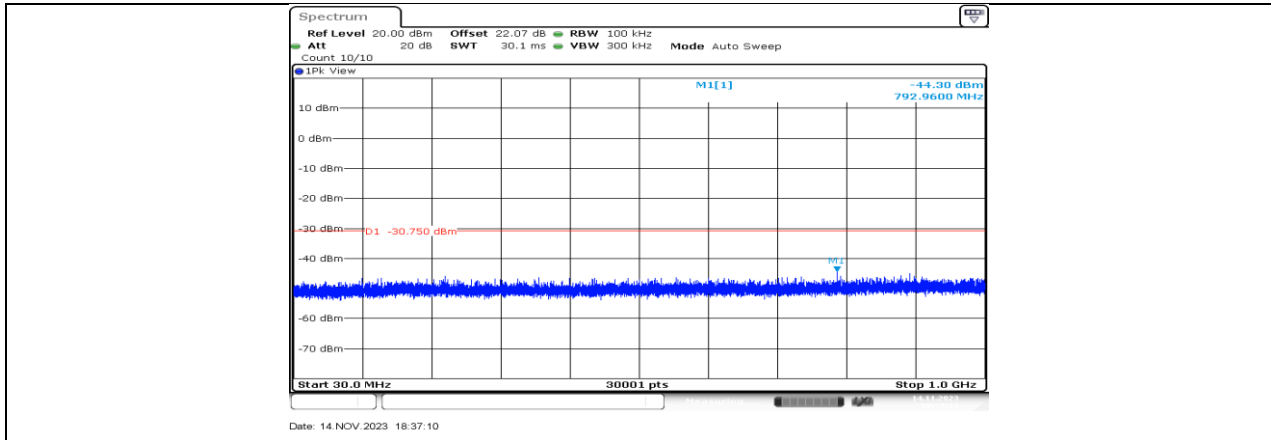

11N40SISO_Ant1_2437_30~1000

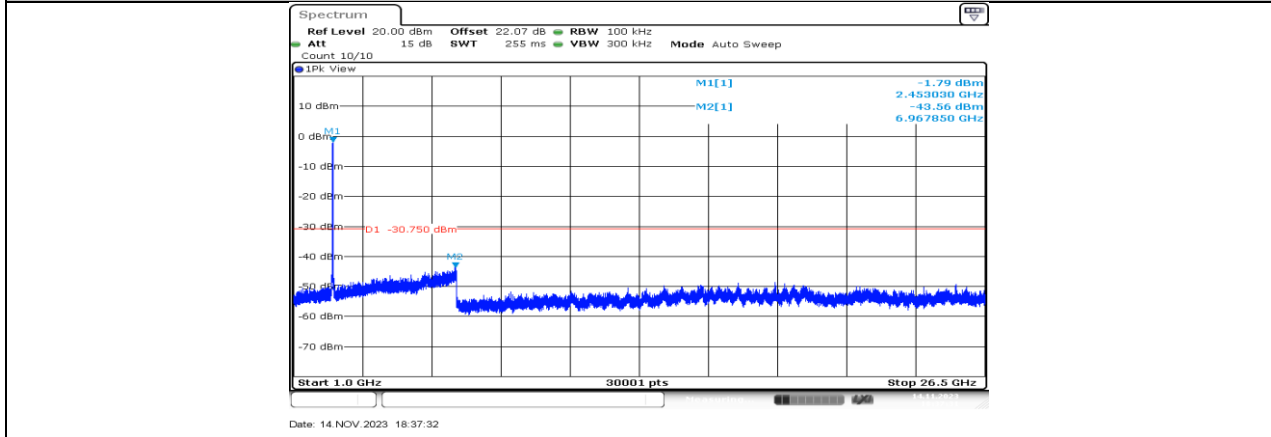

11N40SISO_Ant1_2437_1000~26500

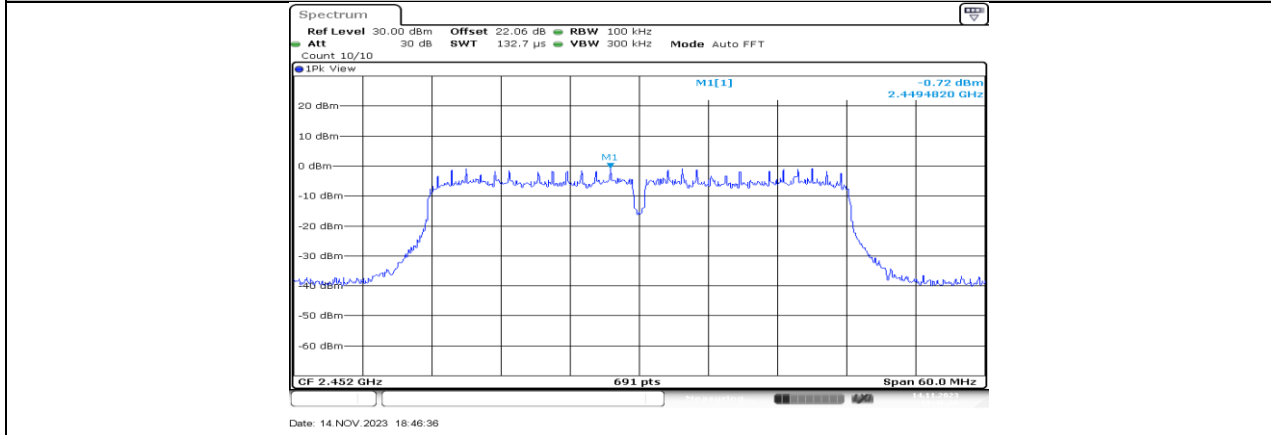

11N40SISO_Ant1_2452_0~Reference

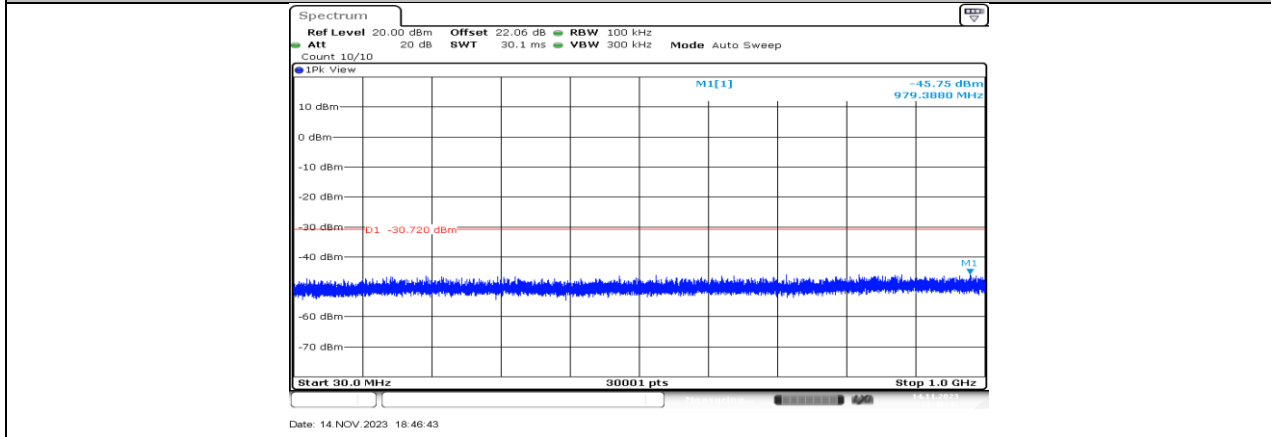

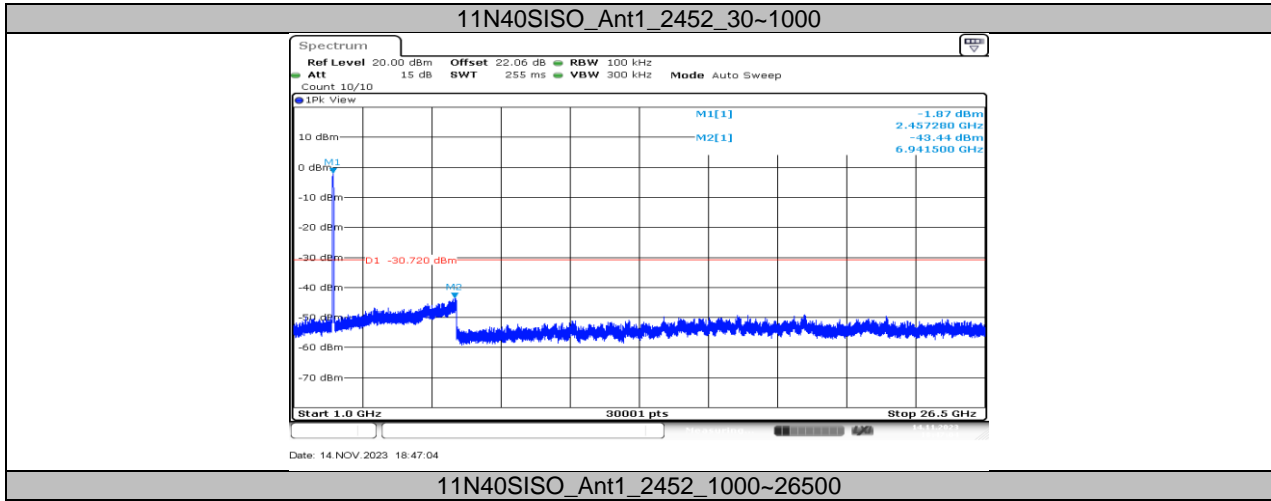

11.7. APPENDIX G: DUTY CYCLE

11.7.1. Test Result

Test Mode	On Time (msec)	Period (msec)	Duty Cycle x (Linear)	Duty Cycle (%)	Duty Cycle Correction Factor (dB)	1/T Minimum VBW (kHz)	Final setting For VBW (kHz)
11B	12.40	12.57	0.9865	98.65	0.06	0.08	0.01
11G	2.06	2.20	0.9364	93.64	0.29	0.49	1
11N20SISO	1.92	2.01	0.9552	95.52	0.20	0.52	1
11N40SISO	0.95	0.99	0.9596	95.96	0.18	1.05	2

Note:

Duty Cycle Correction Factor=10log (1/x).

Where: x is Duty Cycle (Linear)

Where: T is On Time

If that calculated VBW is not available on the analyzer then the next higher value should be used.

11.7.2. Test Graphs

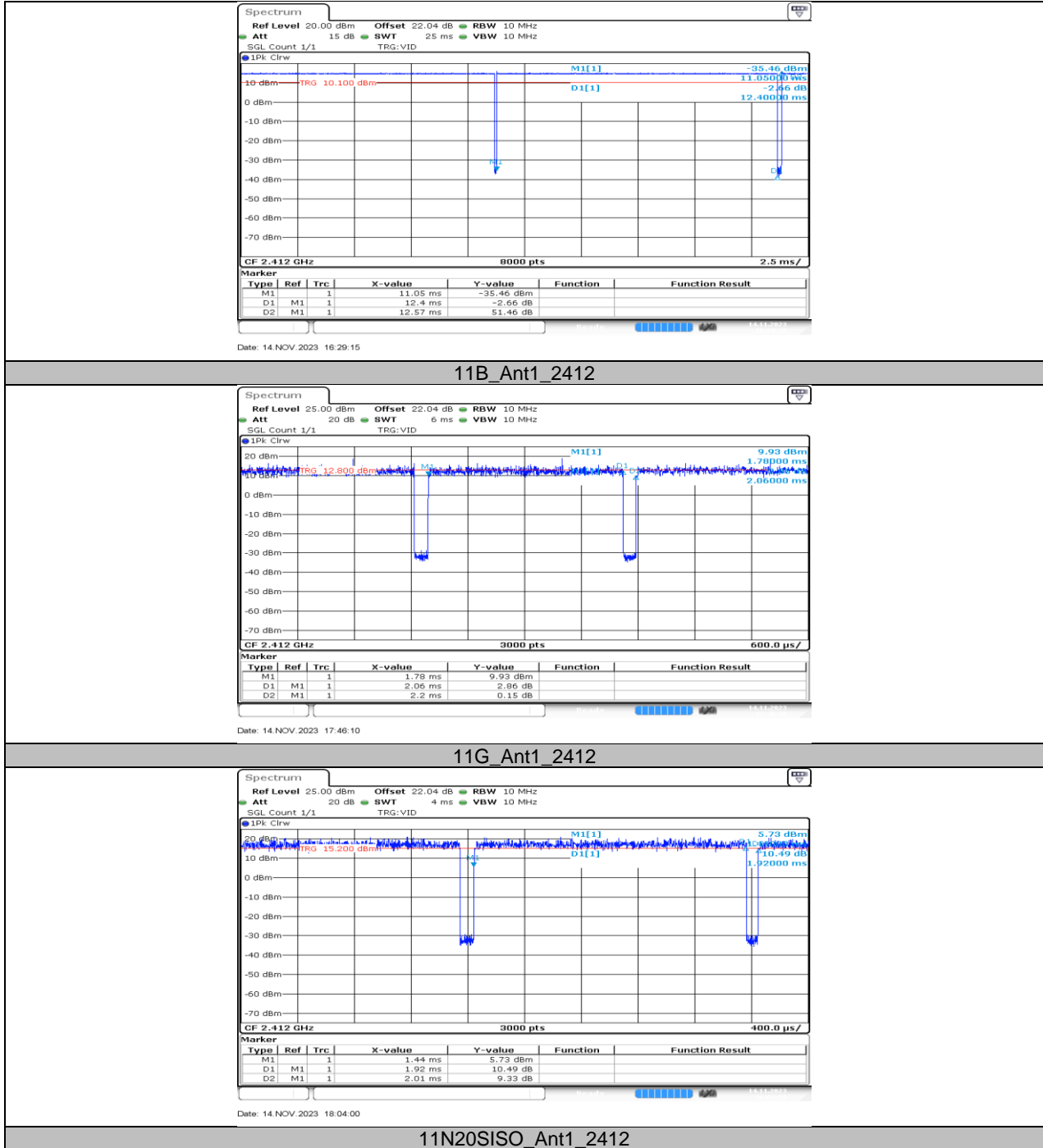

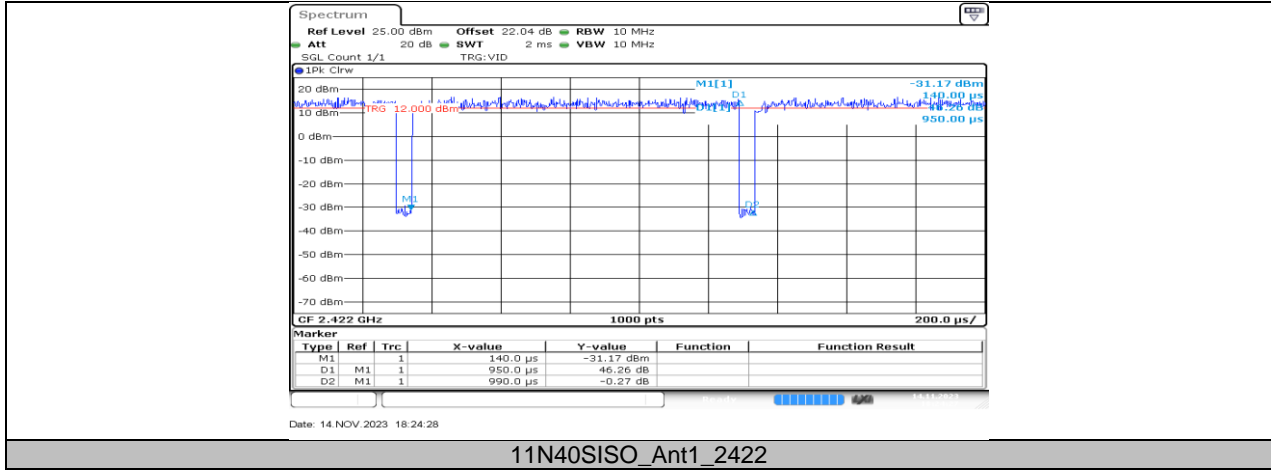

END OF REPORT