



**SGS-CSTC Standards Technical Services Co., Ltd.
Shenzhen Branch**

No. 1 Workshop, M-10, Middle section, Science & Technology Park, Nanshan District, Shenzhen, Guangdong, China 518057

Telephone: +86 (0) 755 2601 2053
Fax: +86 (0) 755 2671 0594
Email: ee.shenzhen@sgs.com

Report No.: SZEM180400321702
Page: 1 of 31

FCC TEST REPORT

Application No: SZEM1804003217RG
Applicant: Fibocom Wireless Inc.
Address of Applicant: 5/F, Tower A, Technology Building II, 1057 Nanhai Avenue, Shenzhen, China
Manufacturer: Fibocom Wireless Inc.
Address of Manufacturer: 5/F, Tower A, Technology Building II, 1057 Nanhai Avenue, Shenzhen, China
Factory: Shenzhen Eternity Technology Co., Ltd
Address of Factory: 1F, 2F, 4F Building A2, Yingzhan Industrial Zone, Longtian Community, Longtian Road, Pingshan District, Shenzhen, Guangdong Province, P.R. China
Product Name: LTE (CatM1,NB-IOT) Module
Model No.(EUT): M910-GL
Trade Mark: Fibocom
FCC ID: ZMOM910GL
Standards: 47 CFR Part 2
 47 CFR Part 22 subpart H
 47 CFR Part 24 subpart E
 47 CFR Part 27 subpart C
 47 CFR Part 90 subpart S
Test Method: FCC KDB 971168 D01 Power Meas License Digital Systems V03r01 TIA-603-E 2016
Date of Receipt: 2018-06-21
Date of Test: 2018-06-25 to 2018-08-05
Date of Issue: 2018-08-08

Test Result:	PASS *
---------------------	---------------

* In the configuration tested, the EUT detailed in this report complied with the standards specified above.

Authorized Signature:

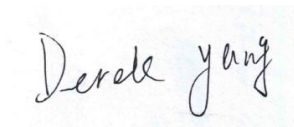

Derek Yang
Wireless Laboratory Manager

The manufacturer should ensure that all products in series production are in conformity with the product sample detailed in this report. If the product in this report is used in any configuration other than that detailed in the report, the manufacturer must ensure the new system complies with all relevant standards. Any mention of SGS International Electrical Approvals or testing done by SGS International Electrical Approvals in connection with, distribution or use of the product described in this report must be approved by SGS International Electrical Approvals in writing.

This document is issued by the Company subject to its General Conditions of Service printed overleaf, -available on request or accessible at <http://www.sgs.com/en/Terms-and-Conditions.aspx> and, for electronic format documents, subject to Terms and Conditions for Electronic Documents at <http://www.sgs.com/en/Terms-and-Conditions/Terms-e-Document.aspx>. Attention is drawn to the limitation of liability, indemnification and jurisdiction issues defined therein. Any holder of this document is advised that information contained hereon reflects the Company's findings at the time of its intervention only and within the limits of Client's instructions, if any. The Company's sole responsibility is to its Client and this document does not exonerate parties to a transaction from exercising all their rights and obligations under the transaction documents. This document cannot be reproduced except in full, without prior written approval of the Company. Any unauthorized alteration, forgery or falsification of the content or appearance of this document is unlawful and offenders may be prosecuted to the fullest extent of the law. Unless otherwise stated the results shown in this test report refer only to the sample(s) tested and such sample(s) are retained for 30 days only.



1 Version

Revision Record				
Version	Chapter	Date	Modifier	Remark
01		2018-08-08		Original

Authorized for issue by:				
Tested By				2018-08-08
				Date
Checked By				2018-08-08
				Date
		(Mike Hu) /Project Engineer		
		(David Chen) /Reviewer		



Content

	Page
1 VERSION	2
2 TEST SUMMARY	5
2.1 GSM850/ LTE BAND 5/26 (824-849 MHz)	5
2.2 GSM1900/LTE BAND 2 (1850-1915 MHz)	5
2.3 LTE BAND 4 (1710-1780 MHz)	6
2.4 LTE BAND 12 (699-716MHz)	6
2.5 LTE BAND 13 (777-787MHz)	7
2.6 LTE BAND 26 (814-824 MHz)	9
3 GENERAL INFORMATION	10
3.1 CLIENT INFORMATION	10
3.2 GENERAL DESCRIPTION OF EUT	10
3.3 TEST MODE	10
3.4 FREQUENCY LIST OF LOW/MIDDLE/HIGH CHANNELS	11
3.5 TEST ENVIRONMENT	16
3.6 TEST LOCATION	16
3.7 TEST FACILITY	16
3.8 DEVIATION FROM STANDARDS	17
3.9 ABNORMALITIES FROM STANDARD CONDITIONS	17
3.10 OTHER INFORMATION REQUESTED BY THE CUSTOMER	17
3.11 TECHNICAL SPECIFICATION	17
4 DESCRIPTION OF TESTS	19
4.1 CONDUCTED OUTPUT POWER	19
4.2 EFFECTIVE (ISOTROPIC) RADIATED POWER OF TRANSMITTER	19
4.3 OCCUPIED BANDWIDTH	20
4.4 BAND EDGE AT ANTENNA TERMINALS	21
4.5 SPURIOUS AND HARMONIC EMISSIONS AT ANTENNA TERMINAL	21
4.6 PEAK-AVERAGE RATIO	22
4.7 FIELD STRENGTH OF SPURIOUS RADIATION	22
4.8 FREQUENCY STABILITY / TEMPERATURE VARIATION	23
4.9 TEST SETUPS	25
4.9.1 Test Setup 1	25



4.9.2	<i>Test Setup 2</i>	25
4.9.3	<i>Test Setup 3</i>	26
4.9.4	<i>Test Setup 4</i>	26
4.10	TEST CONDITIONS	27
5	MAIN TEST INSTRUMENTS	29
6	MEASUREMENT UNCERTAINTY	31
7	PHOTOGRAPHS - EUT CONSTRUCTIONAL DETAILS	31



2 Test Summary

2.1 GSM850/ LTE BAND 5/26 (824-849 MHz)

Test Item	FCC Rule No.	Requirements	Test Result	Verdict
Effective (Isotropic) Radiated Power Output Data	§2.1046, §22.913	ERP ≤ 7 W	Section 1 of Appendix B	Pass
Peak-Average Ratio	---	Limits ≤ 13 dB	Section 2 of Appendix B	Pass
Modulation Characteristics	§2.1047	Digital modulation	Section 3 of Appendix B	Pass
Bandwidth	§2.1049	OBW: No limit. EBW: No limit.	Section 4 of Appendix B	Pass
Band Edges Compliance	§2.1051, §22.917	≤ -13 dBm/1%*EBW, in 1 MHz bands immediately outside and adjacent to the frequency block.	Section 5 of Appendix B	Pass
Spurious Emission at Antenna Terminals	§2.1051, §22.917	FCC: ≤ -13 dBm/100 kHz, from 9 kHz to 10 th harmonics but outside authorized operating frequency ranges.	Section 6 of Appendix B	Pass
Field Strength of Spurious Radiation	§2.1053, §22.917	FCC: ≤ -13 dBm/100 kHz.	Section 7 of Appendix B	Pass
Frequency Stability	§2.1055, §22.355	≤ ±2.5ppm.	Section 8 of Appendix B	Pass

NOTE: For the verdict, the "N/A" denotes "not applicable", the "N/T" denotes "not tested".

2.2 GSM1900/LTE BAND 2 (1850-1915 MHz)

Test Item	FCC Rule No.	Requirements	Test Result	Verdict
Effective (Isotropic) Radiated Power Output Data	§2.1046, §24.232	EIRP ≤ 2 W	Section 1 of Appendix B	Pass
Peak-Average Ratio	§2.1046, §24.232	Limits ≤ 13 dB	Section 2 of Appendix B	Pass
Modulation Characteristics	§2.1047	Digital modulation	Section 3 of Appendix B	Pass
Bandwidth	§2.1049	OBW: No limit. EBW: No limit.	Section 4 of Appendix B	Pass
Band Edges Compliance	§2.1051, §24.238	≤ -13 dBm/1%*EBW, in 1 MHz bands immediately outside and adjacent to the frequency block.	Section 5 of Appendix B	Pass
Spurious Emission at Antenna Terminals	§2.1051, §24.238	≤ -13 dBm/1 MHz, from 9 kHz to 10 th harmonics but outside authorized operating frequency ranges.	Section 6 of Appendix B	Pass



Test Item	FCC Rule No.	Requirements	Test Result	Verdict
Field Strength of Spurious Radiation	§2.1053, §24.238	≤ -13 dBm/1 MHz.	Section 7 of Appendix B	Pass
Frequency Stability	§2.1055, §24.235	≤ ±2.5 ppm.	Section 8 of Appendix B	Pass

NOTE: For the verdict, the "N/A" denotes "not applicable", the "N/T" denotes "not tested".

2.3 LTE BAND 4 (1710-1780 MHz)

Test Item	FCC Rule No.	Requirements	Test Result	Verdict
Effective (Isotropic) Radiated Power Output Data	§2.1046, §27.50(d)	EIRP ≤ 1 W	Section 1 of Appendix B	Pass
Peak-Average Ratio	§2.1046, §27.50(d)	Limits ≤ 13 dB	Section 2 of Appendix B	Pass
Modulation Characteristics	§2.1047	Digital modulation	Section 3 of Appendix B	Pass
Bandwidth	§2.1049	OBW: No limit. EBW: No limit.	Section 4 of Appendix B	Pass
Band Edges Compliance	§2.1051, §27.53(h)	≤ -13 dBm/1%*EBW, in 1 MHz bands immediately outside and adjacent to the frequency block.	Section 5 of Appendix B	Pass
Spurious Emission at Antenna Terminals	§2.1051, §27.53(h)	≤ -13 dBm/1 MHz, from 9 kHz to 10 th harmonics but outside authorized operating frequency ranges.	Section 6 of Appendix B	Pass
Field Strength of Spurious Radiation	§2.1053, §27.53(h)	≤ -13 dBm/1 MHz.	Section 7 of Appendix B	Pass
Frequency Stability	§2.1055, §27.54	≤ ±2.5 ppm.	Section 8 of Appendix B	Pass

NOTE: For the verdict, the "N/A" denotes "not applicable", the "N/T" denotes "not tested".

2.4 LTE BAND 12 (699-716MHz)

Test Item	FCC Rule No	Requirements	Test Result	Verdict
Effective (Isotropic) Radiated Power Output Data	§27.50(c)	FCC: ERP ≤ 3 W.	Section 1 of Appendix B	Pass
Peak-Average Ratio	§2.1046, §27.50(c)	Limits ≤ 13 dB	Section 2 of Appendix B	Pass
Modulation Characteristics	§2.1047	Digital modulation	Section 3 of Appendix B	Pass
Bandwidth	§2.1049	OBW: No limit. EBW: No limit.	Section 4 of Appendix B	Pass
Band Edges Compliance	§2.1051, §27.53(g)	≤ -13 dBm/1%*EBW, in 1 MHz bands immediately outside and adjacent to the frequency block.	Section 5 of Appendix B	Pass
Spurious Emission at	§2.1051, §27.53(g)	FCC: ≤ -13 dBm/100 kHz, from 9 kHz to 10 th harmonics but outside authorized operating	Section 6 of Appendix B	Pass



Test Item	FCC Rule No	Requirements	Test Result	Verdict
Antenna Terminals		frequency ranges.		
Field Strength of Spurious Radiation	§2.1053, §27.53(g)	FCC: ≤ -13 dBm/100 kHz.	Section 7 of Appendix B	Pass
Frequency Stability	§2.1055, §27.54	$\leq \pm 2.5$ ppm.	Section 8 of Appendix B	Pass

NOTE: For the verdict, the "N/A" denotes "not applicable", the "N/T" denotes "not tested".

2.5 LTE BAND 13 (777-787MHz)

Test Item	FCC Rule No.	Requirements	Test Result	Verdict
Effective (Isotropic) Radiated Power Output Data	§2.1046, §27.50(b)	FCC: ERP ≤ 3 W.	Section 1 of Appendix B	Pass
Peak-Average Ratio	§27.50	Limit ≤ 13 dB	Section 2 of Appendix B	N/T
Modulation Characteristics	§2.1047	Digital modulation	Section 3 of Appendix B	Pass
Bandwidth	§2.1049,	OBW: No limit. EBW: No limit.	Section 4 of Appendix B	Pass
Band Edges Compliance	§2.1051, §27.53(c)	≤ -13 dBm/1%*EBW, in 1 MHz bands immediately outside and adjacent to the frequency block.	Section 5 of Appendix B	Pass
Spurious Emission at Antenna Terminals	§2.1051, §27.53(c) §27.53(f)	<p>≤ -13 dBm/100 kHz, from 9 kHz to 10th harmonics but outside authorized operating frequency ranges.</p> <p>(c) For operations in the 746-758 MHz band and the 776-788 MHz band, the power of any emission outside the licensee's frequency band(s) of operation shall be attenuated below the transmitter power (P) within the licensed band(s) of operation, measured in watts, in accordance with the following:</p> <p>(1) On any frequency outside the 746-758 MHz band, the power of any emission shall be attenuated outside the band below the transmitter power (P) by at least $43 + 10 \log (P)$ dB;</p> <p>(2) On any frequency outside the 776-788 MHz band, the power of any emission shall be attenuated outside the band below the transmitter power (P) by at least $43 + 10 \log (P)$ dB;</p> <p>(3) On all frequencies between 763-775 MHz and 793-805 MHz, by a factor not less than $76 + 10 \log (P)$ dB in a 6.25 kHz band segment, for base and fixed stations;</p>	Section 6 of Appendix B	Pass



**SGS-CSTC Standards Technical Services Co., Ltd.
Shenzhen Branch**

Report No.: SZEM180400321702

Page: 8 of 31

Test Item	FCC Rule No.	Requirements	Test Result	Verdict
		(4) On all frequencies between 763-775 MHz and 793-805 MHz, by a factor not less than $65 + 10 \log (P)$ dB in a 6.25 kHz band segment, for mobile and portable stations; For operations in the 746-758 MHz, 775-788 MHz, and 805-806 MHz bands, emissions in the band 1559-1610 MHz shall be limited to -70 dBW/MHz equivalent isotropically radiated power (EIRP) for wideband signals, and -80 dBW EIRP for discrete emissions of less than 700 Hz bandwidth.		
Field Strength of Spurious Radiation	§2.1053, §27.53(c) §27.53(f)	<p>FCC: ≤ -13 dBm/100 kHz.</p> <p>(c) For operations in the 746-758 MHz band and the 776-788 MHz band, the power of any emission outside the licensee's frequency band(s) of operation shall be attenuated below the transmitter power (P) within the licensed band(s) of operation, measured in watts, in accordance with the following:</p> <p>(1) On any frequency outside the 746-758 MHz band, the power of any emission shall be attenuated outside the band below the transmitter power (P) by at least $43 + 10 \log (P)$ dB;</p> <p>(2) On any frequency outside the 776-788 MHz band, the power of any emission shall be attenuated outside the band below the transmitter power (P) by at least $43 + 10 \log (P)$ dB;</p> <p>(3) On all frequencies between 763-775 MHz and 793-805 MHz, by a factor not less than $76 + 10 \log (P)$ dB in a 6.25 kHz band segment, for base and fixed stations;</p> <p>(4) On all frequencies between 763-775 MHz and 793-805 MHz, by a factor not less than $65 + 10 \log (P)$ dB in a 6.25 kHz band segment, for mobile and portable stations; For operations in the 746-758 MHz, 775-788 MHz, and 805-806 MHz bands, emissions in the band 1559-1610 MHz shall be limited to -70 dBW/MHz equivalent isotropically radiated power (EIRP) for wideband signals, and -80 dBW EIRP for discrete emissions of less than 700 Hz bandwidth.</p>	Section 7 of Appendix B	Pass
Frequency Stability	§2.1055, §27.54	Within authorized bands of operation/frequency block.	Section 8 of Appendix B	Pass
NOTE: For the verdict, the "N/A" denotes "not applicable", the "N/T" denotes "not tested".				



2.6 LTE BAND 26 (814-824 MHz)

Test Item	FCC Rule No.	Requirements	Test Result	Verdict
Transmitter Conducted Power Output	§2.1046, §90.635	< 100 W.	Section 1 of Appendix B	PASS
Peak-Average Ratio	---	FCC: Limit≤13 dB	Section 2 of Appendix B	N/T
Modulation Characteristics	§2.1047	Digital modulation	Section 3 of Appendix B	PASS
Bandwidth	§2.1049	OBW: No limit. EBW: No limit.	Section 4 of Appendix B	PASS
Emission Mask	§2.1051 § 90.210	For any frequency removed from the EA licensee's frequency block by up to and including 37.5 kHz, the power of any emission shall be attenuated below the transmitter power (P) in watts by at least $116 \text{Log}_{10}(f/6.1)$ decibels or $50+10\text{Log}_{10}(P)$ decibels or 80 decibels, whichever is the lesser attenuation, where f is the frequency removed from the center of the outer channel in the block in kilohertz and where f is greater than 12.5 kHz.	Section 5 of Appendix B	PASS
Spurious Emission at Antenna Terminals	§2.1051, §90.691	< $43 + 10\text{Log}_{10}(P[\text{Watts}])$ for all out-of-band emissions	Section 6 of Appendix B	PASS
Field Strength of Spurious Radiation	§2.1053, §90.691	< $43 + 10\text{Log}_{10}(P[\text{Watts}])$ for all out-of-band emissions	Section 7 of Appendix B	PASS
Frequency Stability	§2.1055, §90.213	< ±2.5ppm.	Section 8 of Appendix B	PASS

NOTE: For the verdict, the "N/A" denotes "not applicable", the "N/T" denotes "not tested".

Note:

LTE BAND 26 (814-849MHz) overlaps the entire frequency range of LTE BAND 5 (824-849MHz), therefore, test data provided in this report covers BAND 5 as well as BAND 26 subject to Part 22.



3 General Information

3.1 Client Information

Applicant:	Fibocom Wireless Inc.
Address of Applicant:	5/F, Tower A, Technology Building II, 1057 Nanhai Avenue, Shenzhen, China
Manufacturer:	Fibocom Wireless Inc.
Address of Manufacturer:	5/F, Tower A, Technology Building II, 1057 Nanhai Avenue, Shenzhen, China
Factory:	Shenzhen Eternity Technology Co., Ltd
Address of Factory:	1F, 2F, 4F Building A2, Yingzhan Industrial Zone, Longtian Community, Longtian Road, Pingshan District, Shenzhen, Guangdong Province, P.R. China

3.2 General Description of EUT

Product Name:	LTE (CatM1,NB-IOT) Module
Model No.:	M910-GL
Trade Mark:	Fibocom
Sample Type:	LTE (CatM1,NB-IOT) Module
Antenna Type:	PIFA

3.3 Test Mode

Test Mode	Test Modes Description	
GSM/TM1	GSM system, GPRS, GMSK modulation	
GSM/TM2	GSM system, EGPRS, 8PSK modulation	
	LTE-M1	LTE-NB1
LTE/TM1	LTE system, QPSK modulation	LTE system, BPSK modulation
LTE/TM2	LTE system, 16QAM modulation	LTE system, QPSK modulation

NOTE: The test mode(s) are selected according to relevant radio technology specifications.



3.4 Frequency List of Low/Middle/High Channels

Test Mode	TX / RX	RF Channel		
		Low (L)	Middle (M)	High (H)
GSM850	TX	Channel 128	Channel 190	Channel 251
		824.2MHz	836.6 MHz	848.8 MHz
	RX	Channel 128	Channel 190	Channel 251
		869.2 MHz	881.6 MHz	893.8 MHz

Test Mode	TX / RX	RF Channel		
		Low (L)	Middle (M)	High (H)
GSM1900	TX	Channel 512	Channel 661	Channel 810
		1850.2MHz	1880.0 MHz	1909.8 MHz
	RX	Channel 512	Channel 661	Channel 810
		1930.2 MHz	1960.0 MHz	1989.8 MHz

LTE-NB1 BAND 2 Channel and Frequency List			
Channel/Frequency(MHz)	Lowest	Middle	Highest
Channel	18601	18900	19199
Frequency	1850.1	1880	1909.9

LTE-NB1 BAND 4 Channel and Frequency List			
Channel/Frequency(MHz)	Lowest	Middle	Highest
Channel	19951	20175	20399
Frequency	1710.1	1732.5	1754.9

LTE-NB1 BAND 5 Channel and Frequency List			
Channel/Frequency(MHz)	Lowest	Middle	Highest
Channel	20401	20525	20649
Frequency	824.1	836.5	848.9

LTE-NB1 BAND 12 Channel and Frequency List			
Channel/Frequency(MHz)	Lowest	Middle	Highest
Channel	23011	23095	23179
Frequency	699.1	707.5	715.9

LTE-NB1 BAND 13 Channel and Frequency List			
Channel/Frequency(MHz)	Lowest	Middle	Highest
Channel	23181	23230	23279
Frequency	777.1	782	786.9

LTE-NB1 BAND 26(814-824) Channel and Frequency List			
Channel/Frequency(MHz)	Lowest	Middle	Highest
Channel	26691	26740	26789
Frequency	814.1	819	823.9



LTE-NB1 BAND 26(824-849) Channel and Frequency List			
Channel/Frequency(MHz)	Lowest	Middle	Highest
Channel	26791	26925	27039
Frequency	824.1	836.5	848.9

Test Mode	Bandwidth	TX / RX	RF Channel		
			Low (L)	Middle (M)	High (H)
LTE BAND 2	1.4MHz	TX	Channel 18607	Channel 18900	Channel 19193
			1850.7 MHz	1880 MHz	1909.3 MHz
		RX	Channel 607	Channel 900	Channel 1193
			1930.7 MHz	1960 MHz	1989.3 MHz
	3MHz	TX	Channel 18615	Channel 18900	Channel 19185
			1851.5 MHz	1880 MHz	1908.5 MHz
		RX	Channel 615	Channel 900	Channel 1185
			1931.5 MHz	1960 MHz	1988.5 MHz
	5MHz	TX	Channel 18625	Channel 18900	Channel 19175
			1852.5 MHz	1880 MHz	1907.5 MHz
		RX	Channel 625	Channel 900	Channel 1175
			1932.5 MHz	1960 MHz	1987.5 MHz
	10MHz	TX	Channel 18650	Channel 18900	Channel 19150
			1855 MHz	1880 MHz	1905 MHz
		RX	Channel 650	Channel 900	Channel 1150
			1935 MHz	1960 MHz	1985 MHz
	15MHz	TX	Channel 18675	Channel 18900	Channel 19125
			1857.5 MHz	1880 MHz	1902.5 MHz
		RX	Channel 675	Channel 900	Channel 1125
			1937.5 MHz	1960 MHz	1982.5 MHz
	20MHz	TX	Channel 18700	Channel 18900	Channel 19100
			1860 MHz	1880 MHz	1900 MHz
		RX	Channel 700	Channel 900	Channel 1100
			1940 MHz	1960 MHz	1980 MHz

Test Mode	Bandwidth	TX / RX	RF Channel		
			Low (L)	Middle (M)	High (H)
LTE BAND 4	1.4MHz	TX	Channel 19957	Channel 20175	Channel 20393
			1710.7 MHz	1732.5 MHz	1754.3 MHz
		RX	Channel 1975	Channel 2175	Channel 2375
			2112.5 MHz	2132.5MHz	2152.5 MHz
	3MHz	TX	Channel 19965	Channel 20175	Channel 20385
			1711.5 MHz	1732.5 MHz	1753.5 MHz
RX	Channel 2000	Channel 2175	Channel 2350		



	5MHz	TX	2115 MHz	2132.5MHz	2150 MHz
			Channel 19975	Channel 20175	Channel 20375
		RX	1712.5 MHz	1732.5 MHz	1752.5 MHz
			Channel 1975	Channel 2175	Channel 2375
	10MHz	TX	2112.5 MHz	2132.5MHz	2152.5 MHz
			Channel 20000	Channel 20175	Channel 20350
		RX	1715 MHz	1732.5 MHz	1750 MHz
			Channel 2000	Channel 2175	Channel 2350
	15MHz	TX	2115 MHz	2132.5MHz	2150 MHz
			Channel 20025	Channel 20175	Channel 20325
		RX	1717.5 MHz	1732.5 MHz	1747.5 MHz
			Channel 2025	Channel 2175	Channel 2325
	20MHz	TX	2117.5 MHz	2132.5MHz	2147.5 MHz
			Channel 20050	Channel 20175	Channel 20300
		RX	1720 MHz	1732.5 MHz	1745 MHz
			Channel 2050	Channel 2175	Channel 2300
			2120 MHz	2132.5MHz	2145 MHz

Test Mode	Bandwidth	TX / RX	RF Channel		
			Low (L)	Middle (M)	High (H)
LTE BAND 5	1.4MHz	TX	Channel 20407	Channel 20525	Channel 20643
			824.7 MHz	836.5 MHz	848.3 MHz
		RX	Channel 2407	Channel 2525	Channel 2643
			869.7 MHz	881.5 MHz	893.3 MHz
	3MHz	TX	Channel 20415	Channel 20525	Channel 20635
			825.5 MHz	836.5 MHz	847.5 MHz
		RX	Channel 2415	Channel 2525	Channel 2635
			870.5 MHz	881.5 MHz	892.5 MHz
	5MHz	TX	Channel 20425	Channel 20525	Channel 20625
			826.5 MHz	836.5 MHz	846.5 MHz
		RX	Channel 2425	Channel 2525	Channel 2625
			871.5 MHz	881.5 MHz	891.5 MHz
	10MHz	TX	Channel 20450	Channel 20525	Channel 20600
			829 MHz	836.5 MHz	844 MHz
		RX	Channel 2450	Channel 2525	Channel 2600
			874 MHz	881.5 MHz	889 MHz

Test Mode	Bandwidth	TX / RX	RF Channel
-----------	-----------	---------	------------



			Low (L)	Middle (M)	High (H)
LTE BAND12	1.4MHz	TX	Channel 23017	Channel 23095	Channel 23173
			699.7 MHz	707.5 MHz	715.3 MHz
		RX	Channel 5017	Channel 5095	Channel 5173
			729.7 MHz	737.5 MHz	745.3 MHz
	3MHz	TX	Channel 23025	Channel 23095	Channel 23165
			700.5 MHz	707.5 MHz	714.5 MHz
		RX	Channel 5025	Channel 5095	Channel 5165
			730.5 MHz	737.5 MHz	744.5 MHz
	5MHz	TX	Channel 23035	Channel 23095	Channel 23155
			701.5 MHz	707.5 MHz	713.5 MHz
		RX	Channel 5035	Channel 5095	Channel 5155
			731.5 MHz	737.5 MHz	743.5 MHz
10MHz	TX	Channel 23060	Channel 23095	Channel 23130	
		704 MHz	707.5 MHz	711 MHz	
	RX	Channel 5060	Channel 5095	Channel 5130	
		734 MHz	737.5 MHz	741 MHz	

Test Mode	Bandwidth	TX / RX	RF Channel		
			Low (L)	Middle (M)	High (H)
LTE BAND 13	5MHz	TX	Channel 23025	Channel 23230	Channel 23255
			779.5 MHz	782 MHz	784.5 MHz
		RX	Channel 5205	Channel 5230	Channel 5255
			748.5 MHz	751 MHz	753.5 MHz
	10MHz	TX	Channel 23230	Channel 23230	Channel 23230
			782 MHz	782 MHz	782 MHz
RX	Channel 5230	Channel 5230	Channel 5230		
	751 MHz	751 MHz	751 MHz		

Test Mode	Bandwidth	TX / RX	RF Channel		
			Low (L)	Middle (M)	High (H)
LTE BAND26 (814-824)	1.4MHz	TX	Channel 26697	Channel 26740	Channel 26783
			814.7 MHz	819 MHz	823.3 MHz
		RX	Channel 8697	Channel 8740	Channel 8783
			859.7 MHz	864MHz	868.3 MHz
	3MHz	TX	Channel 26705	Channel 26740	Channel 26775
			815.5 MHz	819 MHz	822.5 MHz
		RX	Channel 8705	Channel 8740	Channel 8775
			860.5 MHz	864MHz	867.5 MHz
5MHz	TX	Channel 26715	Channel 26740	Channel 26765	



		RX	816.5 MHz	819 MHz	821.5 MHz
			Channel 8715	Channel 8740	Channel 8755
		861.5 MHz	864MHz	866.5 MHz	
	10MHz	TX	Channel 26740	Channel 26740	Channel 26740
			819 MHz	819 MHz	819 MHz
		RX	Channel 8740	Channel 8740	Channel 8740
864MHz	864MHz		864MHz		

Test Mode	Bandwidth	TX / RX	RF Channel		
			Low (L)	Middle (M)	High (H)
LTE BAND26 (824-849)	1.4MHz	TX	Channel 26797	Channel 26915	Channel 27033
			824.7 MHz	836.5 MHz	848.3 MHz
		RX	Channel 8697	Channel 8915	Channel 9033
			859.7 MHz	881.5 MHz	893.3 MHz
	3MHz	TX	Channel 26805	Channel 26915	Channel 27025
			825.5 MHz	836.5 MHz	847.5 MHz
		RX	Channel 8805	Channel 8915	Channel 9025
			860.5 MHz	881.5 MHz	892.5 MHz
	5MHz	TX	Channel 26815	Channel 26915	Channel 27015
			826.5 MHz	836.5 MHz	846.5 MHz
		RX	Channel 8815	Channel 8915	Channel 9015
			871.5 MHz	881.5 MHz	891.5 MHz
	10MHz	TX	Channel 26840	Channel 26915	Channel 26990
			829 MHz	836.5 MHz	844 MHz
		RX	Channel 8840	Channel 8915	Channel 8990
			874 MHz	881.5 MHz	889 MHz
	15MHz	TX	Channel 26865	Channel 26915	Channel 26965
			831.5 MHz	836.5 MHz	841.5 MHz
		RX	Channel 8865	Channel 8915	Channel 8965
			876.5 MHz	881.5 MHz	886.5 MHz



3.5 Test Environment

Environment Parameter	Selected Values During Tests	
Relative Humidity	52%	
Atmospheric Pressure:	101.32 KPa	
Temperature	NT	25 °C
Voltage:	LV	3.3V
	NV	3.8V
	HV	4.3V

NOTE: LV= lower extreme test voltage; NV= nominal voltage
HV= upper extreme test voltage; NT= normal temperature

3.6 Test Location

All tests were performed at:

SGS-CSTC Standards Technical Services Co., Ltd., Shenzhen Branch

No. 1 Workshop, M-10, Middle Section, Science & Technology Park, Shenzhen, Guangdong, China.
518057.

Tel: +86 755 2601 2053 Fax: +86 755 2671 0594

No tests were sub-contracted.

3.7 Test Facility

The test facility is recognized, certified, or accredited by the following organizations:

• **CNAS (No. CNAS L2929)**

CNAS has accredited SGS-CSTC Standards Technical Services Co., Ltd. Shenzhen Branch EMC Lab to ISO/IEC 17025:2005 General Requirements for the Competence of Testing and Calibration Laboratories (CNAS-CL01 Accreditation Criteria for the Competence of Testing and Calibration Laboratories) for the competence in the field of testing.

• **A2LA (Certificate No. 3816.01)**

SGS-CSTC Standards Technical Services Co., Ltd., Shenzhen EMC Laboratory is accredited by the American Association for Laboratory Accreditation(A2LA). Certificate No. 3816.01.

• **VCCI**

The 3m Fully-anechoic chamber for above 1GHz, 10m Semi-anechoic chamber for below 1GHz, Shielded Room for Mains Port Conducted Interference Measurement and Telecommunication Port Conducted Interference Measurement of SGS-CSTC Standards Technical Services Co., Ltd. have been registered in accordance with the Regulations for Voluntary Control Measures with Registration No.: G-20026, R-14188, C-12383 and T-11153 respectively.

• **FCC –Designation Number: CN1178**

SGS-CSTC Standards Technical Services Co., Ltd., Shenzhen EMC Laboratory has been recognized as an accredited testing laboratory.

Designation Number: CN1178. Test Firm Registration Number: 406779.

• **Industry Canada (IC)**



Two 3m Semi-anechoic chambers and the 10m Semi-anechoic chamber of SGS-CSTC Standards Technical Services Co., Ltd. Shenzhen Branch EMC Lab have been registered by Certification and Engineering Bureau of Industry Canada for radio equipment testing with Registration No.: 4620C-1, 4620C-2, 4620C-3.

3.8 Deviation from Standards

None.

3.9 Abnormalities from Standard Conditions

None.

3.10 Other Information Requested by the Customer

None.

3.11 Technical Specification

Characteristics	Description	
Radio System Type	<input checked="" type="checkbox"/> GSM	
	<input checked="" type="checkbox"/> LTE	
Supported Frequency Range	GSM850 Transmission (TX):824 to 849 MHz Receiving (RX):869 to 894 MHz	
	GSM1900 Transmission (TX):1850 to 1910 MHz Receiving (RX): 1930 to 1990 MHz	
	LTE BAND 2 Transmission (TX):1850 to 1910 MHz Receiving (RX):1930 to 1990 MHz	
	LTE BAND 4 Transmission (TX):1710 to 1755 MHz Receiving (RX): 2110 to 2155 MHz	
	LTE BAND 5 Transmission (TX): 824 to 849 MHz Receiving (RX): 869 to 894 MHz	
	LTE BAND 12 Transmission (TX):699 to 716 MHz Receiving (RX): 729 to 746 MHz	
	LTE BAND 13 Transmission (TX):777 to 787 MHz Receiving (RX): 746 to 756 MHz	
	LTE BAND 26 (814 to 824 MHz) Transmission (TX): 814 to 824MHz Receiving (RX): 859 to 869 MHz	
	LTE BAND 26 (824 to 849 MHz) Transmission (TX):824 to 849 MHz Receiving (RX):869 to 894 MHz	
	Target TX Output Power	GSM850:32.5 dBm GSM1900: 30dBm



	LTE -M1 BAND 2: 24dBm LTE -M1 BAND 4: 24dBm LTE -M1 BAND 5: 24dBm LTE -M1 BAND 12: 24dBm LTE -M1 BAND 13: 24dBm LTE -M1 BAND 26: 24dBm LTE -NB1 BAND 2: 23.5dBm LTE -NB1 BAND 4: 23.5dBm LTE -NB1 BAND 5: 23.5dBm LTE -NB1 BAND 12: 23.5dBm LTE -NB1 BAND 13: 23.5dBm LTE -NB1 BAND 26: 23.5dBm		
Supported Channel Bandwidth	GSM System: <input checked="" type="checkbox"/> 0.2 MHz		
	LTE-M1	LTE BAND 2 <input checked="" type="checkbox"/> 5 MHz; <input checked="" type="checkbox"/> 10 MHz; <input checked="" type="checkbox"/> 15 MHz, <input checked="" type="checkbox"/> 20 MHz	
		LTE BAND 4 <input checked="" type="checkbox"/> 1.4 MHz; <input checked="" type="checkbox"/> 3 MHz; <input checked="" type="checkbox"/> 5 MHz; <input checked="" type="checkbox"/> 10 MHz; <input checked="" type="checkbox"/> 15 MHz, <input checked="" type="checkbox"/> 20 MHz	
		LTE BAND 5 <input checked="" type="checkbox"/> 1.4 MHz; <input checked="" type="checkbox"/> 3 MHz; <input checked="" type="checkbox"/> 5 MHz; <input checked="" type="checkbox"/> 10 MHz	
		LTE BAND 12 <input checked="" type="checkbox"/> 1.4 MHz; <input checked="" type="checkbox"/> 3 MHz; <input checked="" type="checkbox"/> 5 MHz; <input checked="" type="checkbox"/> 10 MHz	
		LTE BAND 13 <input checked="" type="checkbox"/> 5 MHz; <input checked="" type="checkbox"/> 10 MHz	
		LTE BAND 26 (814-824) <input checked="" type="checkbox"/> 1.4 MHz; <input checked="" type="checkbox"/> 3 MHz; <input checked="" type="checkbox"/> 5 MHz; <input checked="" type="checkbox"/> 10 MHz;	
		LTE BAND 26 (824-849) <input checked="" type="checkbox"/> 1.4 MHz; <input checked="" type="checkbox"/> 3 MHz; <input checked="" type="checkbox"/> 5 MHz; <input checked="" type="checkbox"/> 10 MHz; <input checked="" type="checkbox"/> 15 MHz	
	LTE-NB1	LTE BAND 2 Subcarrier: <input checked="" type="checkbox"/> 3.75KHz MHz; <input checked="" type="checkbox"/> 15 KHz	
		LTE BAND 4 Subcarrier: <input checked="" type="checkbox"/> 3.75KHz MHz; <input checked="" type="checkbox"/> 15 KHz	
		LTE BAND 5 Subcarrier: <input checked="" type="checkbox"/> 3.75KHz MHz; <input checked="" type="checkbox"/> 15 KHz	
		LTE BAND 12 Subcarrier: <input checked="" type="checkbox"/> 3.75KHz MHz; <input checked="" type="checkbox"/> 15 KHz	
		LTE BAND 13 Subcarrier: <input checked="" type="checkbox"/> 3.75KHz MHz; <input checked="" type="checkbox"/> 15 KHz	
		LTE BAND 26 (814-824) Subcarrier: <input checked="" type="checkbox"/> 3.75KHz MHz; <input checked="" type="checkbox"/> 15 KHz	
LTE BAND 26 (824-849) Subcarrier: <input checked="" type="checkbox"/> 3.75KHz MHz; <input checked="" type="checkbox"/> 15 KHz			
Characteristics	Description		
Designation of Emissions (Note: the necessary bandwidth of which is the worst value from the measured occupied	GSM850		
	GSM1900		
	LTE-M1	LTE M1 BAND 2	1M11G7D;1M13W7D;
		LTE M1 BAND 4	1M11G7D;1M12W7D;
LTE M1 BAND 12		1M11G7D;1M11W7D;	



bandwidths for each type of channel bandwidth configuration.)		LTE M1 BAND13	1M10G7D;1M11W7D;
		LTE M1 BAND 26 (814-824)	1M10G7D;1M11W7D
		LTE M1 BAND 5 LTE M1 BAND 26 (824-849)	1M12G7D;1M11W7D;
	LTE-NB1	LTE NB1 BAND 2	186KG7D
		LTE NB1 BAND 4	185KG7D
		LTE NB1 BAND 12	187KG7D
		LTE NB1 BAND13	186KG7D
		LTE NB1 BAND 26 (814-824)	185KG7D
		LTE NB1 BAND 5 LTE NB1 BAND 26 (824-849)	185KG7D

4 Description of Tests

4.1 Conducted Output Power

Measurement Procedure: FCC KDB 971168 D01 V03r01

The transmitter output was connected to a calibrated coaxial cable, attenuator and power meter, the other end of which was connected to a Base Station Simulator. The Base Station Simulator was set to force the EUT to its maximum power setting. The power output at the transmitter antenna port was determined by adding the value of the cable insertion loss to the power reading. The tests were performed at three frequencies (low channel, middle channel and high channel) and on the highest power levels, which can be setup on the transmitters.

Note: Reference test setup 1

4.2 Effective (Isotropic) Radiated Power of Transmitter

Measurement Procedure: FCC KDB 971168 D01 V03r01 ; ANSI/TIA-603-E-2016-Section 2.2.17

Below 1GHz test procedure as below:

- 1). The EUT was powered ON and placed on a 0.8m high table in the chamber. The antenna of the transmitter was extended to its maximum length.
- 2). The disturbance of the transmitter was maximized on the test receiver display by raising and lowering from 1m to 4m the receive antenna and by rotating through 360° the turntable. After the fundamental emission was maximized, a field strength measurement was made.
- 3). Steps 1) and 2) were performed with the EUT and the receive antenna in both vertical and horizontal polarization.
- 4). The transmitter was then removed and replaced with another antenna. The center of the antenna was approximately at the same location as the center of the transmitter.
- 5). A signal at the disturbance was fed to the substitution antenna by means of a non-radiating cable. With both the substitution and the receive antennas horizontally polarized, the receive antenna was raised and lowered to obtain a maximum reading at the test receiver. The level of the signal generator was adjusted until the measured field strength level in step 2) is obtained for this set of conditions.
- 6). The output power into the substitution antenna was then measured.
- 7). Steps 5) and 6) were repeated with both antennas polarized.



8). Calculate power in dBm by the following formula:

$$\text{ERP (dBm)} = \text{Pg(dBm)} - \text{cable loss (dB)} + \text{antenna gain (dBd)}$$

Where:

Pg is the generator output power into the substitution antenna.

Above 1GHz test procedure as below:

- 1). Different between above is the test site, change from Semi- Anechoic Chamber to fully Anechoic Chamber
- 2). Calculate power in dBm by the following formula:
$$\text{EIRP(dBm)} = \text{Pg(dBm)} - \text{cable loss (dB)} + \text{antenna gain (dBi)}$$
$$\text{EIRP} = \text{ERP} + 2.15\text{dB}$$

Where:
Pg is the generator output power into the substitution antenna.
- 3). Test the EUT in the lowest channel, the middle channel the Highest channel
- 4). The radiation measurements are performed in X, Y, Z axis positioning. And found the X axis positioning which it is worse case, Only the test worst case mode is recorded in the report.
- 5). Repeat above procedures until all frequencies measured was complete.

Note: Reference test setup 2

4.3 Occupied Bandwidth

Measurement Procedure: FCC KDB 971168 D01 V03r01 Section 4.2

The occupied bandwidth, that is the frequency bandwidth such that, below its lower and above its upper frequency limits, the mean powers radiated are each equal to 0.5 percent of the total mean power radiated by a given emission shall be measured. The transmitter output was connected to a calibrated coaxial cable, attenuator and Spectrum analyser, the other end of which was connected to a Base Station Simulator. The Base Station Simulator was set to force the EUT to its maximum power setting. The tests were performed at three frequencies (low channel, middle channel and high channel). The span of the analyzer shall be set to capture all products of the modulation process, including the emission skirts. The resolution bandwidth shall be set to as close to 1 percent of the selected span as is possible without being below 1 percent. The video bandwidth shall be set to 3 times the resolution bandwidth. Video averaging is not permitted. Where practical, a sampling detector shall be used since a peak or, peak hold, may produce a wider bandwidth than actual. The trace data points are recovered and are directly summed in linear terms. The recovered amplitude data points, beginning at the lowest frequency, are placed in a running sum until 0.5 percent of the total is reached and that frequency recorded. The process is repeated for the highest frequency data points. This frequency is recorded. The span between the two recorded frequencies is the occupied bandwidth.

Note: Reference test setup 1



Test Settings

1. The signal analyzer's automatic bandwidth measurement capability was used to perform the 99% occupied bandwidth and the 26dB bandwidth. The bandwidth measurement was not influenced by any intermediate power nulls in the fundamental emission.
2. RBW = 1 – 5% of the expected OBW
3. VBW \geq 3 x RBW
4. Detector = Peak
5. Trace mode = max hold
6. Sweep = auto couple
7. The trace was allowed to stabilize
8. If necessary, steps 2 – 7 were repeated after changing the RBW such that it would be within 1 – 5% of the 99% occupied bandwidth observed in Step 7

4.4 Band Edge at Antenna Terminals

Measurement Procedure: FCC KDB 971168 D01 V03r01 Section 6.0

The transmitter output was connected to a calibrated coaxial cable, attenuator and Spectrum analyser, the other end of which was connected to a Base Station Simulator. The Base Station Simulator was set to force the EUT to its maximum power setting. The tests were performed at three frequencies (low channel and high channel).in the 1MHz bands immediately outside and adjacent to the frequency block a resolution bandwidth of 100kHz or 1% of the emission bandwidth of the fundamental emission of the transmitter may be employed. The EUT emission bandwidth is measured as the width of the signal between two points, outside of which all emission are attenuated at least 26dB below the transmitter power. The video bandwidth of the spectrum analyzer was set at thrice the resolution bandwidth. Detector Mode was set to peak or peak hold power.

Note: Reference test setup 1

Test Settings

1. Start and stop frequency were set such that the band edge would be placed in the center of the plot
2. Span was set large enough so as to capture all out of band emissions near the band edge
3. RBW \geq 1% of the emission bandwidth
4. VBW \geq 3 x RBW
5. Detector = RMS
6. Number of sweep points \geq 2 x Span/RBW
7. Trace mode = trace average for continuous emissions, max hold for pulse emissions
8. Sweep time = auto couple
9. The trace was allowed to stabilize

4.5 Spurious And Harmonic Emissions at Antenna Terminal

Measurement Procedure: FCC KDB 971168 D01 V03r01

The transmitter output was connected to a calibrated coaxial cable, attenuator and Spectrum analyzer, the other end of which was connected to a Base Station Simulator. The Base Station Simulator was set to force the EUT to its maximum power setting. The tests were performed at three frequencies (low channel and high channel).The level of the carrier and the various conducted spurious and harmonic frequencies is



measured by means of a calibrated spectrum analyzer. The spectrum is scanned from the lowest frequency generated in the equipment up to a frequency including its 10th harmonic. On any frequency outside a licensee's frequency block, the power of any emission shall be attenuated below the transmitter power (P) by at least $43 + 10 \log(P)$ dB. Compliance with these provisions is based on the use of measurement instrumentation employing a resolution bandwidth of 1 MHz or greater. However, in the 1 MHz bands immediately outside and adjacent to the frequency block a resolution bandwidth of at least one percent of the emission bandwidth of the fundamental emission of the transmitter may be employed. The emission bandwidth is defined as the width of the signal between two points, one below the carrier center frequency and one above the carrier center frequency, outside of which all emission are attenuated at least 26 dB below the transmitter power.

Note: Reference test setup 1

Test Settings

1. Start frequency was set to 30MHz and stop frequency was set to at least $10 * \text{the fundamental frequency}$ (separated into at least two plots per channel)
2. Detector = RMS
3. Trace mode = trace average for continuous emissions, max hold for pulse emissions
4. Sweep time = auto couple
5. The trace was allowed to stabilize
6. Please see test notes below for RBW and VBW settings

4.6 Peak-Average Ratio

Measurement Procedure: FCC KDB 971168 D01 V03r01 Section 5.7.1

A peak to average ratio measurement is performed at the conducted port of the EUT. For WCDMA signals, the spectrum analyzers Complementary Cumulative Distribution Function (CCDF) measurement profile is used to determine the largest deviation between the average and the peak power of the EUT in a given bandwidth. The CCDF curve shows how much time the peak waveform spends at or above a given average power level. The percent of time the signal spends at or above the level defines the probability for that particular power level. For GSM signals, an average and a peak trace are used on a spectrum analyzer to determine the largest deviation between the average and the peak power of the EUT in a bandwidth greater than the emission bandwidth. The traces are generated with the spectrum analyzer set to zero span mode.

Note: Reference test setup 1

Test Settings

1. The signal analyzer's CCDF measurement profile is enabled
2. Frequency = carrier center frequency
3. Measurement BW > Emission bandwidth of signal
4. The signal analyzer was set to collect one million samples to generate the CCDF curve
5. The measurement interval was set depending on the type of signal analyzed. For continuous signals (>98% duty cycle), the measurement interval was set to 1ms. For burst transmissions, the spectrum analyzer is set to use an internal "RF Burst" trigger that is synced with an incoming pulse and the measurement interval is set to less than the duration of the "on time" of one burst to ensure that energy is only captured during a time in which the transmitter is operating at maximum power

4.7 Field Strength of Spurious Radiation

Measurement Procedure: FCC KDB 971168 D01 V03r01

Below 1GHz test procedure as below:



- 1). The EUT was powered ON and placed on a 150cm high table in the chamber. The antenna of the transmitter was extended to its maximum length.
- 2). The disturbance of the transmitter was maximized on the test receiver display by raising and lowering from 1m to 4m (for the test frequency of below 30MHz, the antenna was tuned to heights 1 meter) the receive antenna and by rotating through 360° the turntable. After the fundamental emission was maximized, a field strength measurement was made.
- 3). Steps 1) and 2) were performed with the EUT and the receive antenna in both vertical and horizontal polarization.
- 4). The transmitter was then removed and replaced with another antenna. The center of the antenna was approximately at the same location as the center of the transmitter.
- 5). A signal at the disturbance was fed to the substitution antenna by means of a non-radiating cable. With both the substitution and the receive antennas horizontally polarized, the receive antenna was raised and lowered to obtain a maximum reading at the test receiver. The level of the signal generator was adjusted until the measured field strength level in step 2) is obtained for this set of conditions.
- 6). The output power into the substitution antenna was then measured.
- 7). Steps 5) and 6) were repeated with both antennas polarized.
- 8) Calculate power in dBm by the following formula:

$$\text{ERP(dBm)} = \text{Pg(dBm)} - \text{cable loss (dB)} + \text{antenna gain (dBd)}$$

Where:

Pd is the dipole equivalent power, Pg is the generator output into the substitution antenna, and the antenna gain is the gain of the substitute antenna used relative to either a half-wave dipole (dBd) or an isotropic source (dBi). The substitute level is equal to Pg [dBm] – cable loss [dB]. The calculated Pd levels are then compared to the absolute spurious emission limit of -13dBm which is equivalent to the required minimum attenuation of $43 + 10\log_{10}(\text{Power [Watts]})$.

Above 1GHz test procedure as below:

- 1) Different between above is the test site, change from Semi- Anechoic Chamber to fully Anechoic Chamber
- 2) Calculate power in dBm by the following formula:

$$\text{EIRP(dBm)} = \text{Pg(dBm)} - \text{cable loss (dB)} + \text{antenna gain (dBi)}$$

$$\text{EIRP} = \text{ERP} + 2.15\text{dB}$$

Where:

Pg is the generator output power into the substitution antenna.

3. Test the EUT in the lowest channel, the middle channel the Highest channel
4. The radiation measurements are performed in X, Y, Z axis positioning. And found the X axis positioning which it is worse case, Only the test worst case mode is recorded in the report.
5. Repeat above procedures until all frequencies measured was complete

Note: Reference test setup 3

4.8 Frequency Stability / Temperature Variation

Measurement Procedure:

Frequency stability testing is performed in accordance with the guidelines of FCC KDB 971168 D01 V03r01; ANSI/TIA-603-E-2016

. The frequency stability of the transmitter is measured by:

- a.) **Temperature:** The temperature is varied from -30°C to +50°C in 10°C increments using an environmental chamber.
- b.) **Primary Supply Voltage:** The primary supply voltage is varied from 85% to 115% of the nominal value for non hand-carried battery and AC powered equipment. For hand-carried, battery-powered equipment,

This document is issued by the Company subject to its General Conditions of Service printed overleaf, available on request or accessible at <http://www.sgs.com/en/Terms-and-Conditions.aspx> and, for electronic format documents, subject to Terms and Conditions for Electronic Documents at <http://www.sgs.com/en/Terms-and-Conditions/Terms-e-Document.aspx>. Attention is drawn to the limitation of liability, indemnification and jurisdiction issues defined therein. Any holder of this document is advised that information contained hereon reflects the Company's findings at the time of its intervention only and within the limits of Client's instructions, if any. The Company's sole responsibility is to its Client and this document does not exonerate parties to a transaction from exercising all their rights and obligations under the transaction documents. This document cannot be reproduced except in full, without prior written approval of the Company. Any unauthorized alteration, forgery or falsification of the content or appearance of this document is unlawful and offenders may be prosecuted to the fullest extent of the law. Unless otherwise stated the results shown in this test report refer only to the sample(s) tested and such sample(s) are retained for 30 days only.



primary supply voltage is reduced to the battery operating end point which shall be specified by the manufacturer.

Specification – The frequency stability shall be sufficient to ensure that the fundamental emission stays within the authorized frequency block. The frequency stability of the transmitter shall be maintained within $\pm 0.00025\%$ (± 2.5 ppm) of the center frequency.

Time Period and Procedure:

1. The carrier frequency of the transmitter is measured at room temperature (20°C to provide a reference).
2. The equipment is turned on in a “standby” condition for fifteen minutes before applying power to the transmitter. Measurement of the carrier frequency of the transmitter is made within one minute after applying power to the transmitter.
3. Frequency measurements are made at 10°C intervals ranging from -30°C to +50°C. A period of at least one half-hour is provided to allow stabilization of the equipment at each temperature level.

Note: Reference test setup 4

4.9 Test Setups

4.9.1 Test Setup 1

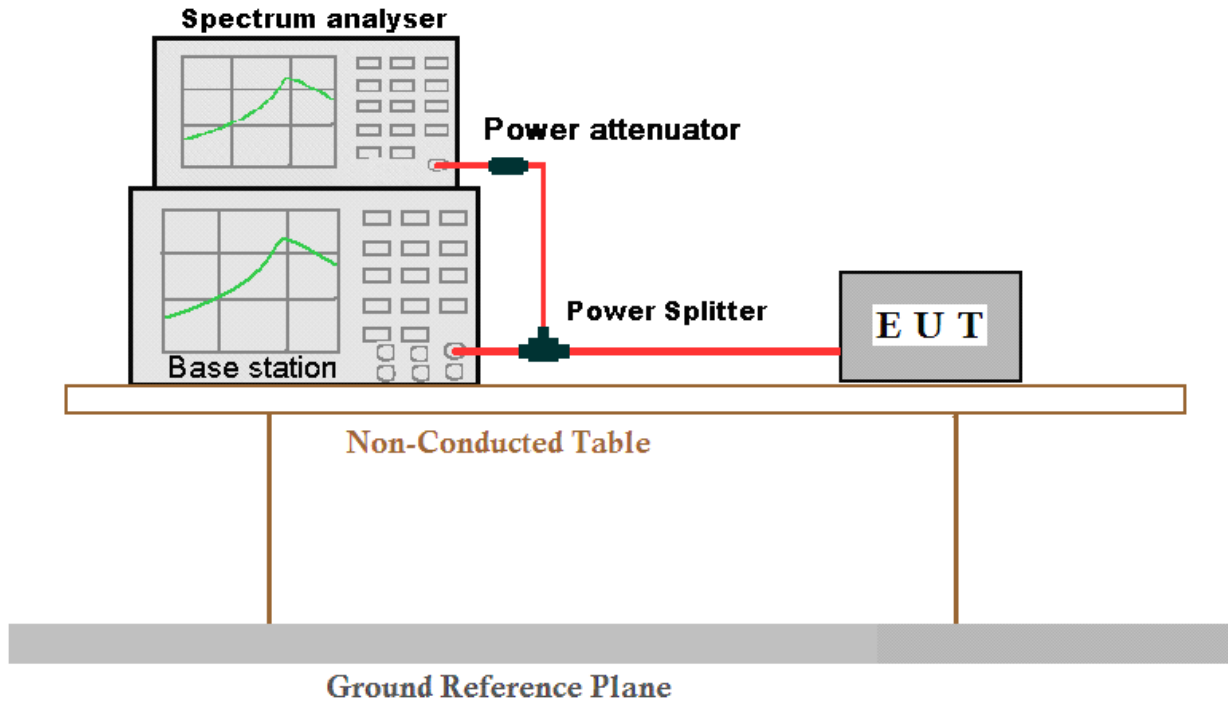

4.9.2 Test Setup 2

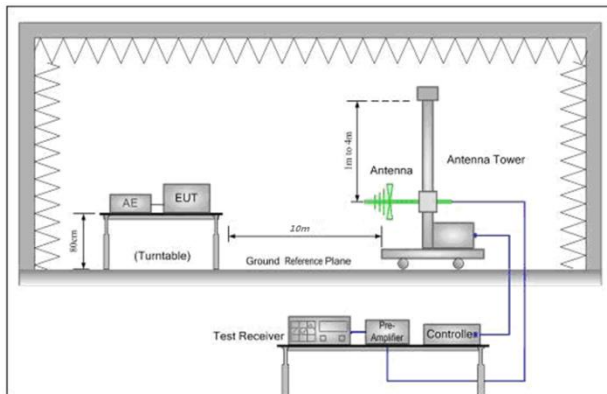

Figure 1. 30MHz to 1GHz

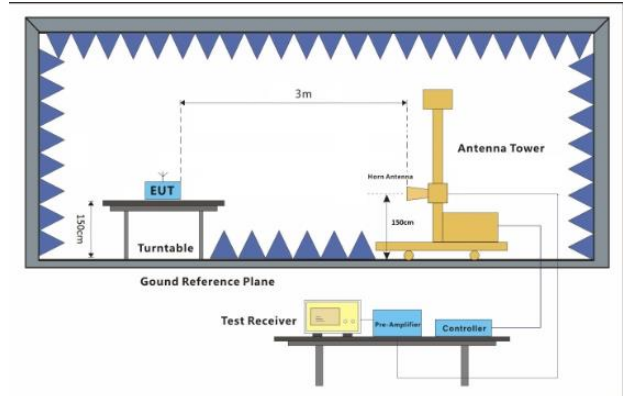

Figure 2. above 1GHz

4.9.3 Test Setup 3

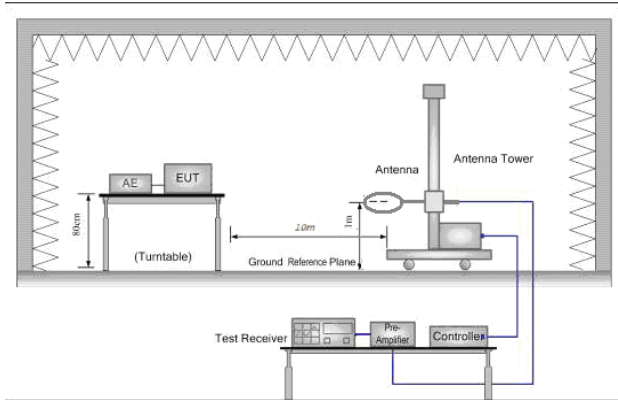

Figure 1. Below 30MHz

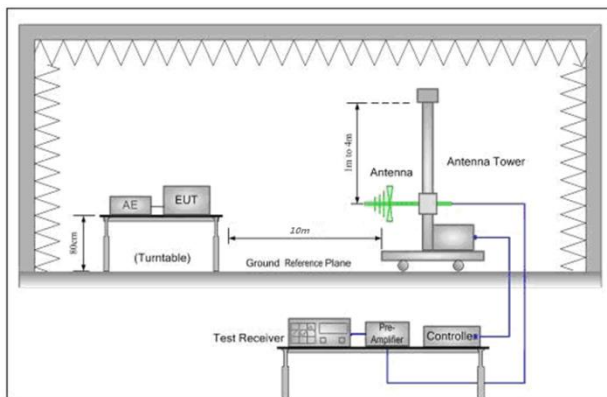

Figure 2. 30MHz to 1GHz

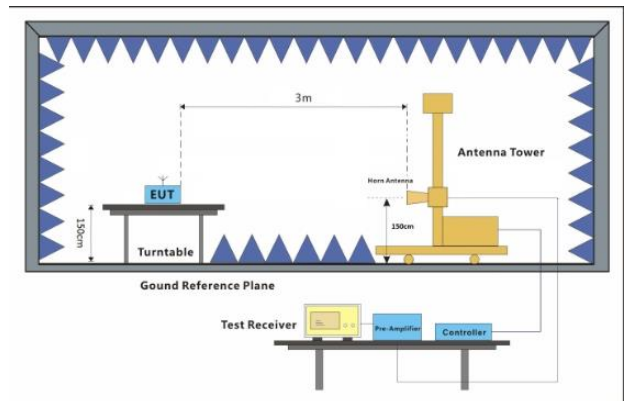
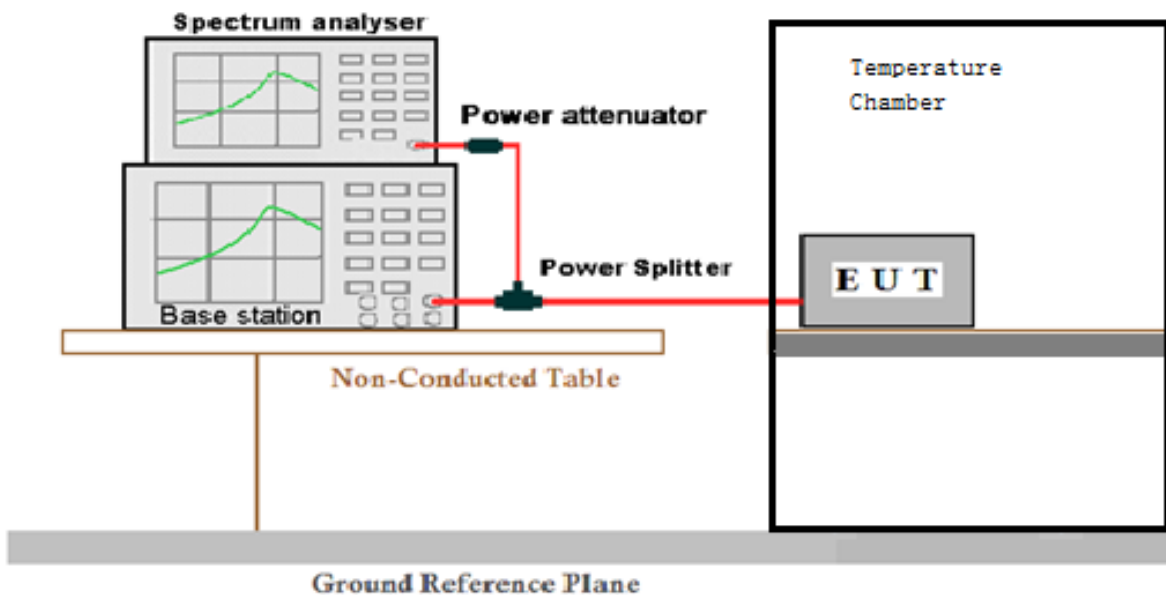

Figure 3. above 1GHz

4.9.4 Test Setup 4



4.10 Test Conditions

Test Case		Test Conditions	
Transmit Output Power Data	Average Power, Total	Test Environment	Ambient Climate & Rated Voltage
		Test Setup	Test Setup 1
		RF Channels (TX)	L, M, H (L= low channel, M= middle channel, H= high channel)
		Test Mode	GSM/TM1;GSM/TM2; LTE/TM1;LTE/TM2
	Average Power, Spectral Density (if required)	Test Environment	Ambient Climate & Rated Voltage
		Test Setup	Test Setup 1
		RF Channels (TX)	L, M, H (L= low channel, M= middle channel, H= high channel)
		Test Mode	GSM/TM1;GSM/TM2; LTE/TM1;LTE/TM2
Peak-to-Average Ratio (if required)	Test Environment	Ambient Climate & Rated Voltage	
	Test Setup	Test Setup 1	
	RF Channels (TX)	L, M, H (L= low channel, M= middle channel, H= high channel)	
	Test Mode	GSM/TM1;GSM/TM2;LTE/TM1;LTE/TM2	
Modulation Characteristics	Test Environment	Ambient Climate & Rated Voltage	
	Test Setup	Test Setup 1	
	RF Channels (TX)	M (M= middle channel)	
	Test Mode	GSM/TM1;GSM/TM2; LTE/TM1;LTE/TM2	
Bandwidth	Occupied Bandwidth	Test Environment	Ambient Climate & Rated Voltage
		Test Setup	Test Setup 1
		RF Channels (TX)	L, M, H (L= low channel, M= middle channel, H= high channel)
		Test Mode	GSM/TM1;GSM/TM2; LTE/TM1;LTE/TM2
	Emission Bandwidth (if required)	Test Environment	Ambient Climate & Rated Voltage
		Test Setup	Test Setup 1
		RF Channels (TX)	L, M, H (L= low channel, M= middle channel, H= high channel)
		Test Mode	GSM/TM1;GSM/TM2; LTE/TM1;LTE/TM2
Band Edges Compliance		Test Environment	Ambient Climate & Rated Voltage



	Test Setup	Test Setup 1
	RF Channels (TX)	L, H (L= low channel, H= high channel)
	Test Mode	GSM/TM1;GSM/TM2; LTE/TM1;LTE/TM2
Spurious Emission at Antenna Terminals	Test Environment	Ambient Climate & Rated Voltage
	Test Setup	Test Setup 1
	RF Channels (TX)	L,M, H (L= low channel, M= middle channel, H= high channel)
	Test Mode	GSM/TM1;UMTS/TM1; LTE/TM1
Field Strength of Spurious Radiation	Test Environment	Ambient Climate & Rated Voltage
	Test Setup	Test Setup 2
	Test Mode	GSM/TM1;GSM/TM2; LTE/TM1;LTE/TM2; NOTE: If applicable, the EUT conf. that has maximum power density (based on the equivalent power level) is selected.
	RF Channels (TX)	L, M, H (L= low channel, M= middle channel, H= high channel)
Frequency Stability	Test Environment	(1) -30 °C to +50 °C with step 10 °C at Rated Voltage; (2) VL, VN and VH of Rated Voltage at Ambient Climate.
	Test Setup	Test Setup 4
	RF Channels (TX)	L, M, H (L= low channel, M= middle channel, H= high channel)
	Test Mode	GSM/TM1;GSM/TM2; LTE/TM1;LTE/TM2



5 Main Test Instruments

RE in Chamber						
Item	Test Equipment	Manufacturer	Model No.	Inventory No.	Cal. date (yyyy/mm/dd)	Cal.Due date (yyyy/mm/dd)
1	3m Semi-Anechoic Chamber	ETS-LINDGREN	N/A	SEM001-01	2018/03/13	2021/03/12
2	3m Semi-Anechoic Chamber	AUDIX	N/A	SEM001-02	2018/03/13	2021/03/12
3	EMI Test Receiver	Agilent Technologies	N9038A	SEM004-05	2017/10/09	2018/10/09
4	EXA Signal Analyzer (10Hz-26.5GHz)	Agilent Technologies Inc	N9010A	SEM004-09	2018/04/13	2019/04/12
5	BiConiLog Antenna (26-3000MHz)	ETS-LINDGREN	3142C	SEM003-02	201711/15	2020/11/15
6	Double-ridged horn (1-18GHz)	ETS-LINDGREN	3117	SEM003-11	2015/10/17	2018/10/17
7	Horn Antenna (18-26GHz)	ETS-LINDGREN	3160	SEM003-12	2017/11/24	2020/11/24
8	Horn Antenna (15GHz-40GHz)	Schwarzbeck	BBHA 9170	SEM003-15	2017/10/17	2020/10/17
9	Low Noise Amplifier (100MHz-18GHz)	Black Diamond Series	BDLNA-0118-352810	SEM005-05	2017/09/27	2018/09/26
10	Band filter	N/A	N/A	N/A	N/A	N/A
11	Pre-amplifier (0.1-1300MHz)	Agilent Technologies	8447D	SEM005-01	2018/03/13	2019/03/12
12	Pre-Amplifier (0.1-26.5GHz)	Compliance Directions Systems Inc.	PAP-0126	SEM004-10	2017/10/17	2018/10/17
13	Pre-amplifier (26GHz-40GHz)	Compliance Directions Systems Inc.	PAP-2640-50	SEM005-08	2018/03/14	2019/03/14
14	Band filter	Amindeon	82346	SEM023-01	N/A	N/A
15	Universal radio communication tester	Rohde &Schwarz	CMU200	SEM010-01	2017/10/09	2018/10/09
16	Universal radio communication tester	Rohde &Schwarz	CMW500	SEM010-03	2017/10/23	2018/10/23
17	DC Power Supply	Zhao Xin	RXN-305D	SEM011-02	2017/10/09	2018/10/09
18	BiConiLog Antenna	Schwarzbeck	VULB9163	SEM003-05	2015/10/17	2018/10/17



	(30MHz-3GHz)					
19	Horn Antenna (800MHz-18GHz)	Rohde & Schwarz	HF907	SEM003-06	2018/06/06	2021/06/06

RE in Chamber						
Item	Test Equipment	Manufacturer	Model No.	Inventory No.	Cal. Date (yyyy-mm-dd)	Cal. Due date (yyyy-mm-dd)
1	10m Semi-Anechoic Chamber	SAEMC	FSAC1018	SEM001-03	2018/3/10	2019/3/9
2	EMI Test Receiver (9k-7GHz)	Rohde & Schwarz	ESR	SEM004-03	2018/02/14	2019/02/14
3	Trilog-Broadband Antenna(30M-1GHz)	Schwarzbeck	VULB9168	SEM003-18	2016/06/29	2019/06/29
4	Pre-amplifier	Sonoma Instrument Co	310N	SEM005-03	2018/6/6	2019/6/5
5	.Loop Antenna	ETS-Lindgren	6502	SEM003-08	2015/08/14	2018/08/14

RF connected test						
Item	Test Equipment	Manufacturer	Model No.	Inventory No.	Cal. date (yyyy-mm-dd)	Cal. Due date (yyyy-mm-dd)
1	Humi/ Temp Indicator	MingGao	TH101B	W006-09	2018/03/13	2019/03/12
2	Signal Analyzer	Rohde Schwarz	FSV	W005-02	2018/03/13	2019/03/12
3	Spectrum Analyzer (20Hz-43GHz)	Rohde & Schwarz	FSU43	SEM004-08	2018/04/14	2019/04/13
4	Barometer	ChangChun	DYM3	SEL0088	2018/05/24	2019/05/24
5	Dual Output Mobile Communication DC Source	Agilent Technologies Inc	66311B	W009-09	2018/4/28	2019/4/28
6	Digital Multimeter	Fluke	15B+	W055-01	2018/03/13	2019/03/12
7	Wideband Radio Communication Tester	Rohde & Schwarz	CMW500	W005-02	2018/03/13	2019/03/12
8	Wideband Radio Communication Tester	Rohde & Schwarz	CMW500	W005-02	2018/03/13	2019/03/12
9	Temperature Chamber	GIANT FORCE	ICT-150-40-CP-AR	W027-04	2017/12/04	2018/12/04
10	Wideband Radio Communication Teste	Anristu	MT8821C	6201462742	2017/8/13	2018/8/12



6 Measurement Uncertainty

For a 95% confidence level ($k = 2$), the measurement expanded uncertainties for defined systems, in accordance with the recommendations of ISO 17025 as following:

Test Item	Extended Uncertainty	Data
Transmit Output Power Data	Power [dBm]	$U = \pm 0.37$ dB
Bandwidth	Magnitude [%]	$U = \pm 0.2\%$
Band Edge Compliance	Disturbance Power [dBm]	$U = \pm 2.0$ dB
Spurious Emissions, Conducted	Disturbance Power [dBm]	$U = \pm 2.0$ dB
Field Strength of Spurious Radiation	ERP[dBm]/EIRP [dBm]	For 3 m Chamber: $U = \pm 4.5$ dB (30 MHz to 1GHz) $U = \pm 3.3$ dB (above 1 GHz) For 10 m Chamber: $U = \pm 4.5$ dB (30 MHz to 1GHz) $U = \pm 3.2$ dB (above 1 GHz)
Frequency Stability	Frequency Accuracy [ppm]	$U = \pm 0.24$ ppm

7 Photographs - EUT Constructional Details

Refer to Appendix A - Photographs of EUT Constructional Details for SZEM1804003217RG.

The End