



## **Aries6 Kit**

# **QUICK SETUP GUIDE**

**Note: Product images shown may be different than actual product received**

**PAX TECHNOLOGY INC.**

## **Contents**

Welcome to the Aries6 Kit Family -----	1
Aries6 Kit Accessories-----	2
Get to Know the Aries6 Kit-----	3
Aries6 Kit Communication Interfaces-----	4
Install and Remove SIM and SAM Cards-----	5
Privacy Shield Options-----	6
How to Make Payments-----	7
Attach and Remove AR6P from Stand-----	8
Safety Precautions-----	9

# Welcome to the Aries6 Kit Family

## Introduction

The Aries6 Kit includes a tablet and a mounting plate, it is a combination product that allows universal attachment on most of the 3rd party stands. The plate can also provide standard communication interfaces to meet your diverse demands.

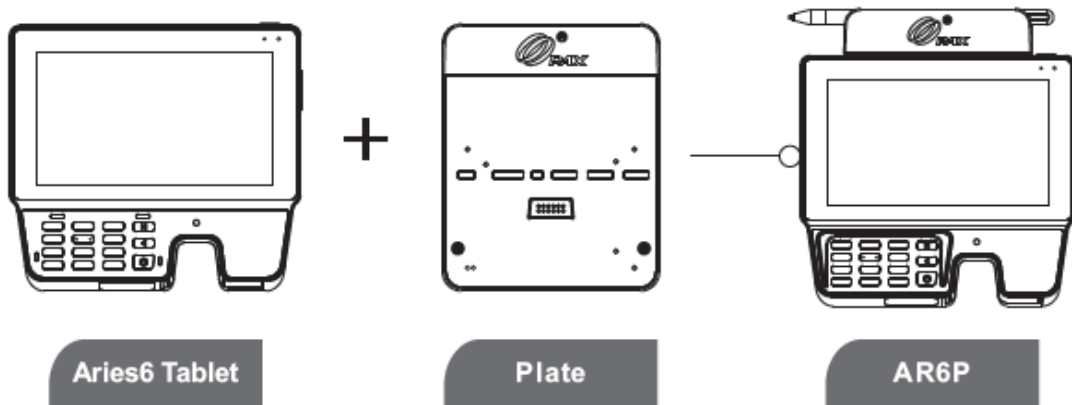

## Aries6 Kit Accessories

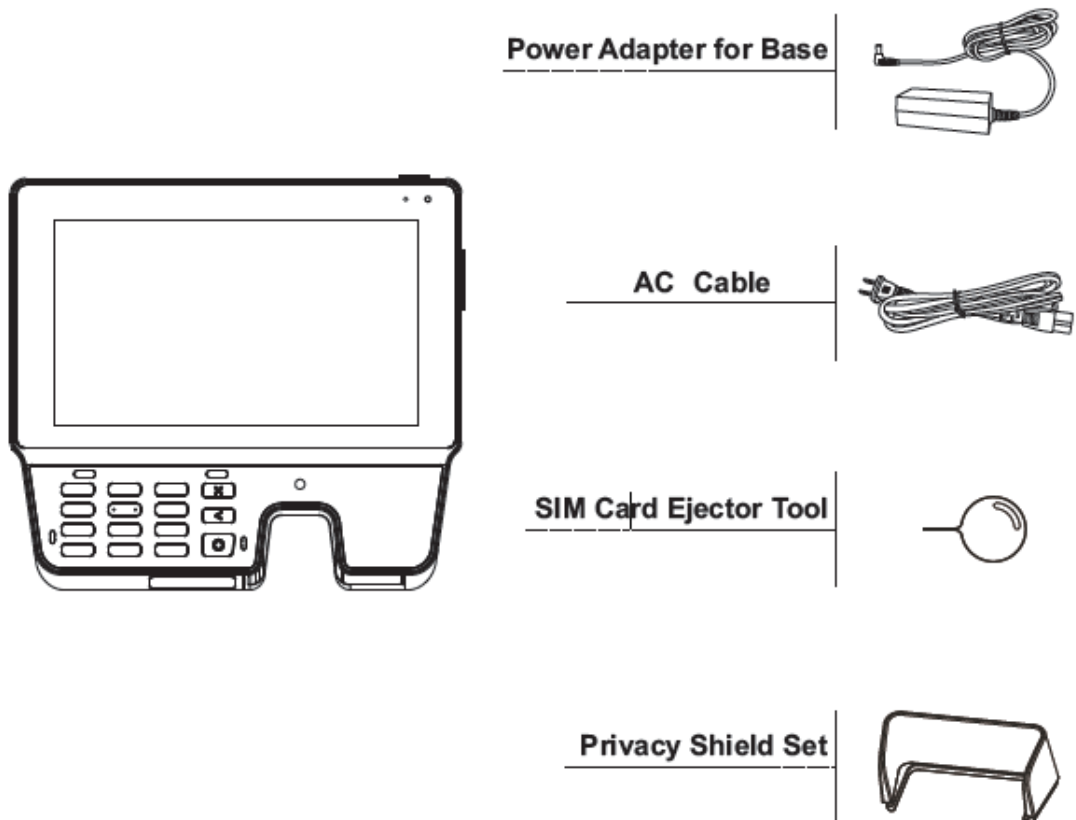

# Get to Know Aries6 Kit

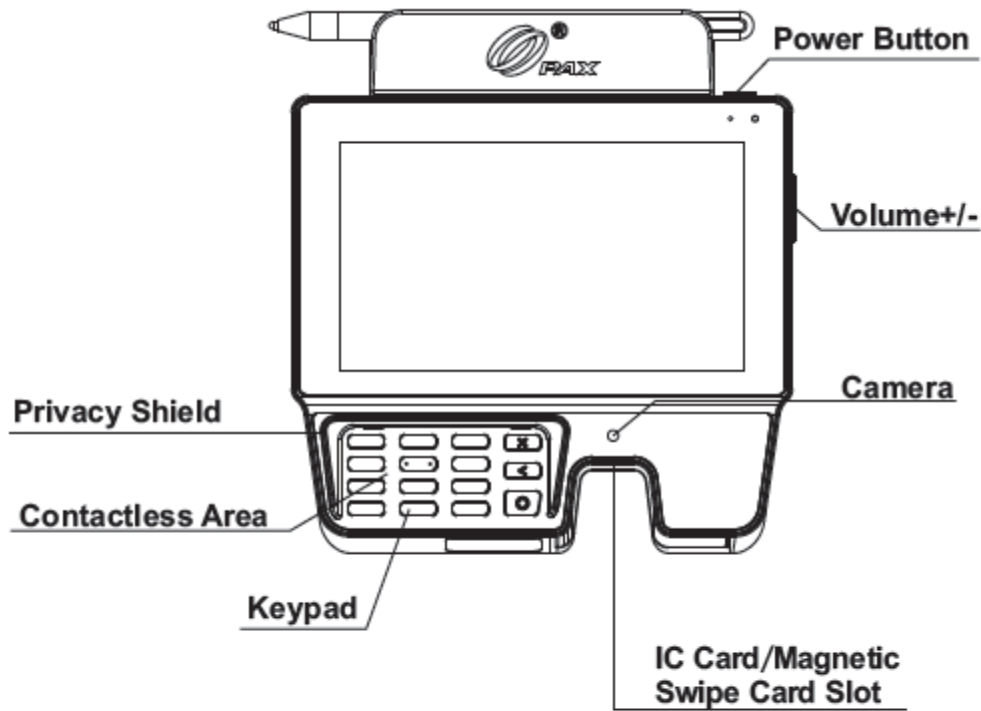

Front View

## Aries6 Kit Communication Interfaces

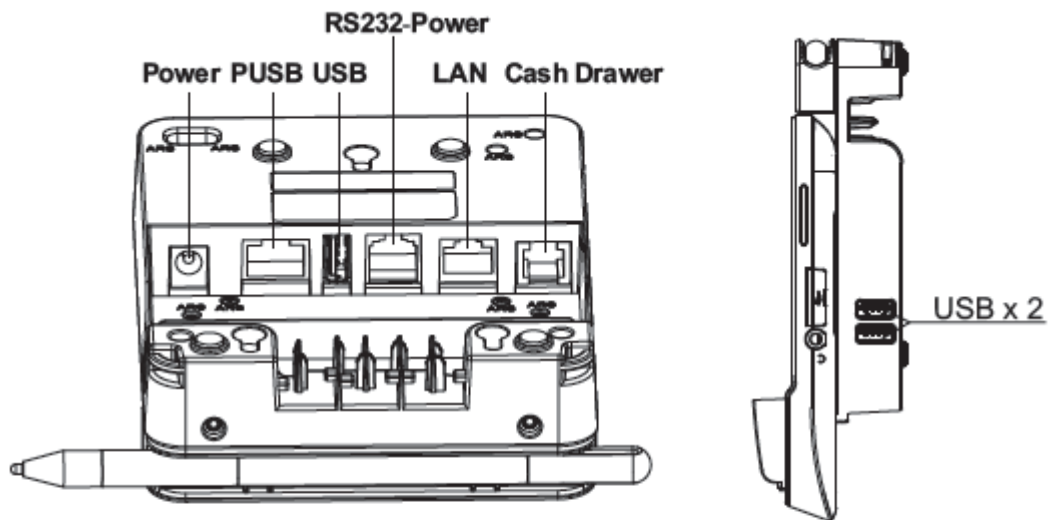

Communication Box Ports

- LAN x 1
- Cash Drawer x 1
- Power RS232 x 1
- USB Type A x 3
- PUSB x 1
- Power port x 1

# Install and Remove SIM and PSAM Cards

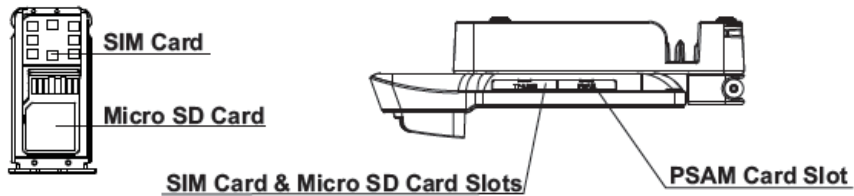

## SIM and Micro SD Cards

- Install** Use ejector tool to open tray. Position SIM Card and Micro SD card on tray. Gently push tray back into slot until firmly seated.

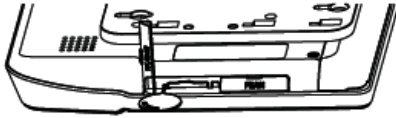

- Remove** Use ejector tool to open tray, take cards out and gently push tray back into slot until firmly seated.

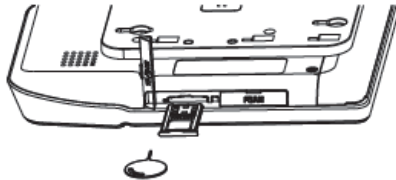

## PSAM Card

- Install** Open cover. Insert card with chip facing up. Close PSAM card slot cover.

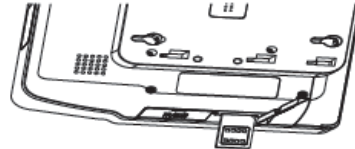

- Remove** Push PSAM card further into slot. (The card will protrude slightly out of the slot) Push card again to remove it.

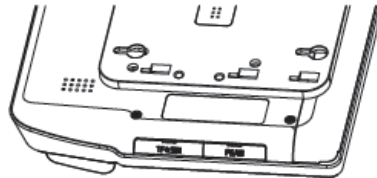

# Privacy Shield Options



**Caution:** If the privacy shield is not installed, you must use PCI-approved alternative methods to secure the tablet keypad.



Low Privacy Shield



High Privacy Shield

## Install High Privacy Shield



- Align the four pegs on lower privacy shield with the four holes around the tablet keypad.
- Press to secure privacy shield to tablet.
- Snap the higher rubber privacy shield onto the lower one.

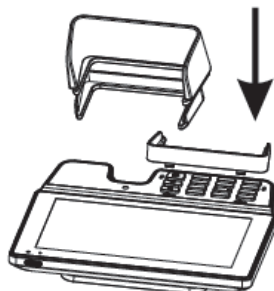

## Install Low Privacy Shield



- Align the four pegs on privacy shield with the four holes around the tablet keypad.
- Press to secure privacy shield to tablet.

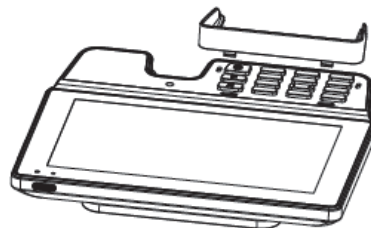

# Payment Options

## Tap



Hold contactless card or device over or under keypad to trigger payment.



## Dip



Insert card with IC chip facing up, then push it to the end of the card slot with blue light flashing and icon displaying on screen. Leave card inserted until prompted to remove.

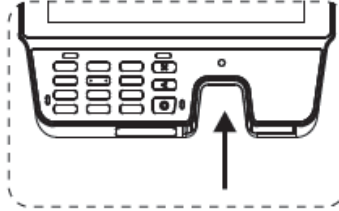

## Swipe



Insert magnetic stripe card into card slot and push to the end with magnetic stripe facing down, then pull out card at a constant speed to swipe card.

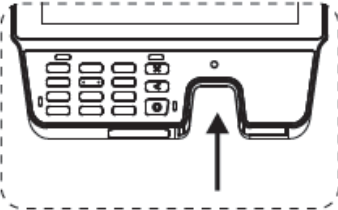

## Scan



Hold QR code in front of camera to trigger payment.

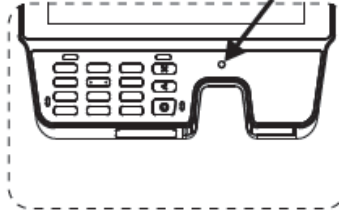

# Attach and Remove from Stand

## Install AR6P



Align the 3 orienting holes on the AR6P with the 3 pegs on the stand.

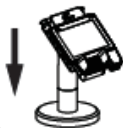

Lower AR6P onto the stand and push it in the direction shown to secure the AR6P.

## 3 Orienting Holes

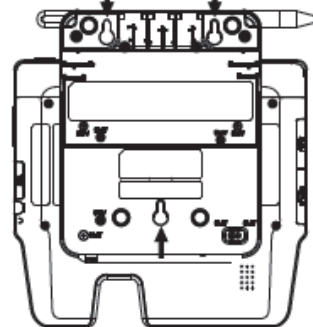

## Remove AR6P



Push AR6P in the direction shown to remove it.

# Safety Precautions

## Location Cautions

1. Keep the device away from direct sunlight, excessive dust, moisture and heat.
2. Keep the device from the electrical devices that might introduce interferencesuchas microwave ovens and blow dryers.

## Cleaning Cautions

1. Do not use industrial strength or abrasive cleaner as it may damage or scratch thescreen.
2. Do not immerse device into any kind of liquid.
3. Do not spray water or cleaner into card reader or ports.
4. To clean screen, apply distilled water or mild glass cleaner onto a soft, link-freeclothand gently wipe screen.
5. To clean tablet, apply distilled water or plastic-safe cleaner onto a soft, lint-freeclothand gently wipe tablet.

## Usage Tips

1. Avoid exposing the device to an excessively hot, humid, dusty, or strongelectromagnetic environment.
2. Do not vibrate, shake, or drop the device.
3. Do not plug or unplug any part of the device while it is powered on. This maycausedamage to an internal circuit.
4. Please contact PAX technical support for assistance with the device.

## FCC Regulations

This device complies with part 15 of the FCC Rules. Operation is subject to thefollowing twoconditions: (1) This device may not cause harmful interference, and (2) this device must acceptany interference received, including interference that may cause undesired operation.

This device has been tested and found to comply with the limits for a Class B digital device,pursuant to Part 15 of the FCC Rules. These limits are designed to provide reasonable protectionagainst harmful interference in a residential installation. This equipment generates, uses and canradiated radio frequency energy and, if not installed and used in accordance with the instructions,may cause harmful interference to radio communications. However, there is no guarantee thatinterference will not occur in a particular installation If this equipment does cause harmfulinterference to radio or television reception, which can be determined by turning the equipmentoff and on, the user is encouraged to try to correct the interference by one or more of thefollowing measures:

- Reorient or relocate the receiving antenna.
- Increase the separation between the equipment and receiver.
- Connect the equipment into an outlet on a circuit different from that to which the receiver isconnected.
- Consult the dealer or an experienced radio/TV technician for help.

**Caution:** Changes or modifications not expressly approved by the party responsible forcompliance could void the user's authority to operate the equipment.

# FCC RF Exposure Information (SAR)

This device complies with FCC radiation exposure limits set forth for an uncontrolled environment. In order to avoid the possibility of exceeding the FCC radio frequency exposure limits, human proximity to the antenna shall not be less than 20cm (8 inches) during normal operation.

P/N:200312000000512

PAX TECHNOLOGY LIMITED reserves the right to change product technology specifications without notifying.



**PAX TECHNOLOGY LIMITED**

**Manufacturer: PAX Computer Technology (Shenzhen) Co.,Ltd.**

**Address:4/F, No.3 Building, Software Park, Second Central Science-Tech Road,  
High-Tech Industrial Park, Shenzhen, Guangdong, P.R.C.**

**Tel: 0755-86169630 Fax: 0755-86169634**

**Website: <http://www.pax.com.cn>**

**Responsible Party: PAX Technology, Inc.**

**8880 Freedom Crossing Trail, Building 400, 3rd Floor Suite 300, Jacksonville ,  
Florida, 32256**

**Help-desk**

**1 877-859-0099**