



# FCC RF Test Report

**APPLICANT** : PAX Technology Limited  
**EQUIPMENT** : Smart Tablet  
**BRAND NAME** : PAX  
**MODEL NAME** : Aries6  
**FCC ID** : V5PAR6  
**STANDARD** : FCC Part 15 Subpart C §15.225  
**CLASSIFICATION** : (DXX) Low Power Communication Device Transmitter

The product was received on Apr. 11, 2019 and testing was completed on Jun. 23, 2019. We, Sporton International (Shenzhen) Inc., would like to declare that the tested sample has been evaluated in accordance with the test procedures and has been in compliance with the applicable technical standards.

The test results in this report apply exclusively to the tested model / sample. Without written approval of Sporton International (Shenzhen) Inc., the test report shall not be reproduced except in full.

*Derreck Chen*

Reviewed by: Derreck Chen / Supervisor

*Eric Shih*

Approved by: Eric Shih / Manager



**Sporton International (ShenZhen) Inc.**

**1/F, 2/F, Bldg 5, Shiling Industrial Zone, Xinwei Village, Xili, Nanshan, Shenzhen, 518055  
People's Republic of China**



# TABLE OF CONTENTS

**TABLE OF CONTENTS** .....2

**REVISION HISTORY** .....3

**SUMMARY OF THE TEST RESULT** .....4

**1. GENERAL DESCRIPTION** .....5

    1.1 Applicant..... 5

    1.2 Manufacturer ..... 5

    1.3 Product Feature of Equipment Under Test ..... 5

    1.4 Product Specification of Equipment Under Test ..... 6

    1.5 Modification of EUT ..... 6

    1.6 Testing Location ..... 7

    1.7 Applicable Standards..... 7

**2. TEST CONFIGURATION OF EQUIPMENT UNDER TEST** .....8

    2.1 Descriptions of Test Mode ..... 8

    2.2 Connection Diagram of Test System ..... 9

    2.3 Table for Supporting Units ..... 10

    2.4 EUT Operation Test Setup ..... 10

**3. TEST RESULTS**.....11

    3.1 AC Power Line Conducted Emissions Measurement ..... 11

    3.2 20dB and 99% OBW Spectrum Bandwidth Measurement..... 13

    3.3 Frequency Stability Measurement ..... 14

    3.4 Field Strength of Fundamental Emissions and Mask Measurement..... 15

    3.5 Radiated Emissions Measurement ..... 17

    3.6 Antenna Requirements..... 20

**4. LIST OF MEASURING EQUIPMENT** .....21

**5. UNCERTAINTY OF EVALUATION** .....22

**APPENDIX A. TEST RESULTS OF CONDUCTED EMISSION TEST**

**APPENDIX B. TEST RESULTS OF CONDUCTED TEST ITEMS**

    B1. Test Result of 20dB Spectrum Bandwidth

    B2. Test Result of Frequency Stability

**APPENDIX C. TEST RESULTS OF RADIATED TEST ITEMS**

    C1. Test Result of Field Strength of Fundamental Emissions

    C2. Results of Radiated Emissions (9 kHz~30MHz)

    C3. Results of Radiated Emissions (30MHz~1GHz)

**APPENDIX D. SETUP PHOTOGRAPHS**



### REVISION HISTORY

REPORT NO.	VERSION	DESCRIPTION	ISSUED DATE
FR941109D	Rev. 01	Initial issue of report	Aug. 02, 2019



### SUMMARY OF THE TEST RESULT

Report Section	FCC Rule	Description of Test	Result	Remark
3.1	15.207	AC Power Line Conducted Emissions	Complies	Under limit 3.15 dB at 13.560MHz
3.2	15.215(c)	20dB Spectrum Bandwidth	Complies	-
	-	99% OBW Spectrum Bandwidth	Complies	-
3.3	15.225(e)	Frequency Stability	Complies	-
3.4	15.225(a)(b)(c)	Field Strength of Fundamental Emissions	Complies	Max level 82.37 dB $\mu$ V/m at 13.560 MHz
3.5	15.225(d) & 15.209	Radiated Spurious Emissions	Complies	Under limit 3.01 dB at 30.000MHz for Quasi-Peak
3.6	15.203	Antenna Requirements	Complies	-



# 1. General Description

## 1.1 Applicant

**PAX Technology Limited**

Room 2416, 24/F., Sun Hung Kai Centre, 30 Harbour Road, Wanchai, Hong Kong

## 1.2 Manufacturer

**PAX Computer Technology (Shenzhen) Co., Ltd.**

4/F, No.3 Building, Software Park, Second Central Science-Tech Road, High-Tech industrial Park, Shenzhen, Guangdong, P.R.C.

## 1.3 Product Feature of Equipment Under Test

Product Feature	
<b>Equipment</b>	Smart Tablet
<b>Brand Name</b>	PAX
<b>Model Name</b>	Aries6
<b>FCC ID</b>	V5PAR6
<b>EUT supports Radios application</b>	WCDMA/HSPA/DC-HSDPA/HSPA+(16QAM uplink is not supported)/LTE/GPS/NFC WLAN 2.4GHz 802.11b/g/n HT20 WLAN 5GHz 802.11a/n HT20/HT40 WLAN 5GHz 802.11ac VHT20/VHT40/VHT80 Bluetooth BR/EDR/LE
<b>IMEI Code</b>	Conducted: 866732039393476 Conduction: 866732039389946 Radiation: 866732039389581
<b>HW Version</b>	N/A
<b>SW Version</b>	N/A
<b>EUT Stage</b>	Production Unit

**Remark:** The above EUT's information was declared by manufacturer. Please refer to the specifications or user's manual for more detailed description.



### 1.4 Product Specification of Equipment Under Test

Standards-related Product Specification	
Tx/Rx Frequency Range	13.553 ~ 13.567MHz
Channel Number	1
20dBW	2.458 kHz
99%OBW	2.078 kHz
Antenna Type	PCB Antenna
Type of Modulation	ASK

**Remark:** The above EUT's information was declared by manufacturer. Please refer to the specifications or user's manual for more detailed description.

### 1.5 Modification of EUT

No modifications are made to the EUT during all test items.



### 1.6 Testing Location

Sporton International (Shenzhen) Inc. is accredited to ISO/IEC 17025:2017 by American Association for Laboratory Accreditation with Certificate Number 5145.01.

<b>Test Site</b>	Sporton International (Shenzhen) Inc.		
<b>Test Site Location</b>	1/F, 2/F, Bldg 5, Shiling Industrial Zone, Xinwei Village, Xili, Nanshan, Shenzhen, 518055 People's Republic of China TEL: +86-755-86379589 FAX: +86-755-86379595		
<b>Test Site No.</b>	<b>Sporton Site No.</b>		<b>FCC Designation No.</b>
	TH01-SZ	CO01-SZ	
<b>Test Engineer</b>	Zhang Jiang	Bear Xiong	CN1256
<b>Temperature</b>	24~26°C	22~25°C	
<b>Relative Humidity</b>	50~53%	50~55%	
			421272

<b>Test Site</b>	Sporton International (Shenzhen) Inc.		
<b>Test Site Location</b>	No. 3 Bldg the third floor of south, Shahe River west, Fengzeyuan Warehouse, Nanshan Shenzhen, 518055 People's Republic of China TEL: +86-755-33202398		
<b>Test Site No.</b>	<b>Sporton Site No.</b>		<b>FCC Designation No.</b>
	03CH03-SZ		
<b>Test Engineer</b>	Zhongmin Zhang		CN1256
<b>Temperature</b>	23~25°C		
<b>Relative Humidity</b>	48~52%		
			421272

### 1.7 Applicable Standards

According to the specifications of the manufacturer, the EUT must comply with the requirements of the following standards:

- ♦ 47 CFR Part 15 Subpart C §15.225
- ♦ ANSI C63.10-2013



## 2. Test Configuration of Equipment Under Test

### 2.1 Descriptions of Test Mode

Investigation has been done on all the possible configurations.

The following table is a list of the test modes shown in this test report.

Test Items	
AC Power Line Conducted Emissions	Field Strength of Fundamental Emissions
20dB Spectrum Bandwidth	Frequency Stability
Radiated Emissions 9kHz~30MHz	Radiated Emissions 30MHz~1GHz

The EUT pre-scanned in four NFC type, A, B. The worst type (type A) was recorded in this report.

Pre-scanned tests, X, Y, Z in three orthogonal panels to determine the final configuration (Y plane as worst plane) from all possible combinations.

Test Cases	
<b>AC Conducted Emission</b>	Mode 1: LTE Band5 Idle + Bluetooth Link + WLAN Link (2.4G) + NFC Tx + USB Cable(Charging from Adapter) + Earphone
<b>Remark:</b> For Radiated Test Cases, The tests were performed with Adapter, Earphone and USB Cable	



## 2.2 Connection Diagram of Test System

For Radiation

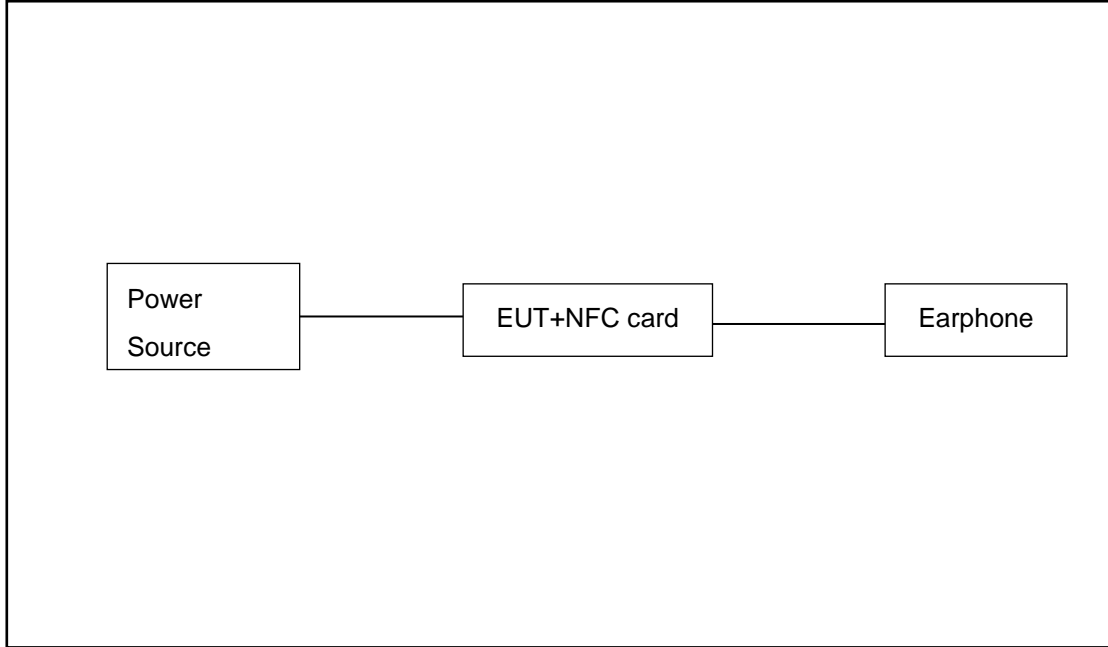

For Conducted Emission

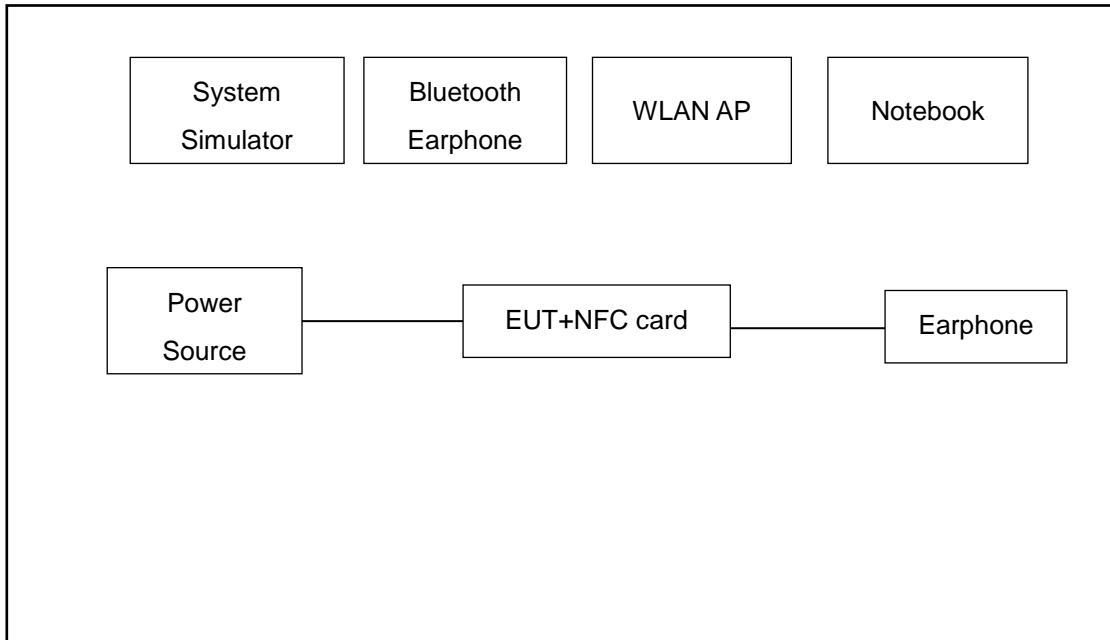

### 2.3 Table for Supporting Units

Item	Equipment	Trade Name	Model Name	FCC ID	Data Cable	Power Cord
1.	System Simulator	Anritsu	MT8820C	N/A	N/A	Unshielded,1.8m
2.	WLAN AP	D-Link	DIR-820L	KA2IR820LA1	N/A	Unshielded,1.8m
3.	Notebook	Lenovo	E540	FCC DoC	N/A	AC I/P: Unshielded,1.2m DC O/P: Shielded, 1.8 m
4.	Earphone	Apple	MC690ZP/A	N/A	Shielded, 1.0m	N/A
5.	Bluetooth Earphone	Samsung	EO-MG900	N/A	N/A	N/A
6.	NFC Card	N/A	N/A	N/A	N/A	N/A
7.	DC Power Supply	GW	GPS-3030D	N/A	N/A	Unshielded,1.8m

### 2.4 EUT Operation Test Setup

The EUT was programmed to be in continuously transmitting mode.

The ancillary equipment, NFC card, is used to make the EUT (NFC) continuously transmit at 13.56MHz and is placed around 3 cm gap to the EUT.

### 3. Test Results

#### 3.1 AC Power Line Conducted Emissions Measurement

##### 3.1.1 Limit of AC Conducted Emission

For equipment that is designed to be connected to the public utility (AC) power line, the radio frequency voltage that is conducted back onto the AC power line on any frequency or frequencies within the band 150 kHz to 30 MHz shall not exceed the limits in the following table.

Frequency of Emission (MHz)	Conducted Limit (dB $\mu$ V)	
	Quasi-Peak	Average
0.15-0.5	66 to 56*	56 to 46*
0.5-5	56	46
5-30	60	50

\*Decreases with the logarithm of the frequency.

##### 3.1.2 Measuring Instruments

See list of measuring instruments of this test report.

##### 3.1.3 Test Procedures

1. The EUT was placed 0.4 meter from the conducting wall of the shielding room, and it was kept at least 80 centimeters from any other grounded conducting surface.
2. Connect EUT to the power mains through a line impedance stabilization network (LISN).
3. All the support units are connecting to the other LISN.
4. The LISN provides 50 ohm coupling impedance for the measuring instrument.
5. The FCC states that a 50 ohm, 50 microhenry LISN should be used.
6. Both sides of AC line were checked for maximum conducted interference.
7. The frequency range from 150 kHz to 30 MHz was searched.
8. Set the test-receiver system to Peak Detect Function and specified bandwidth (IF Bandwidth = 9kHz) with Maximum Hold Mode. Then measurement is also conducted by Average Detector and Quasi-Peak Detector Function respectively.

### 3.1.4 Test setup

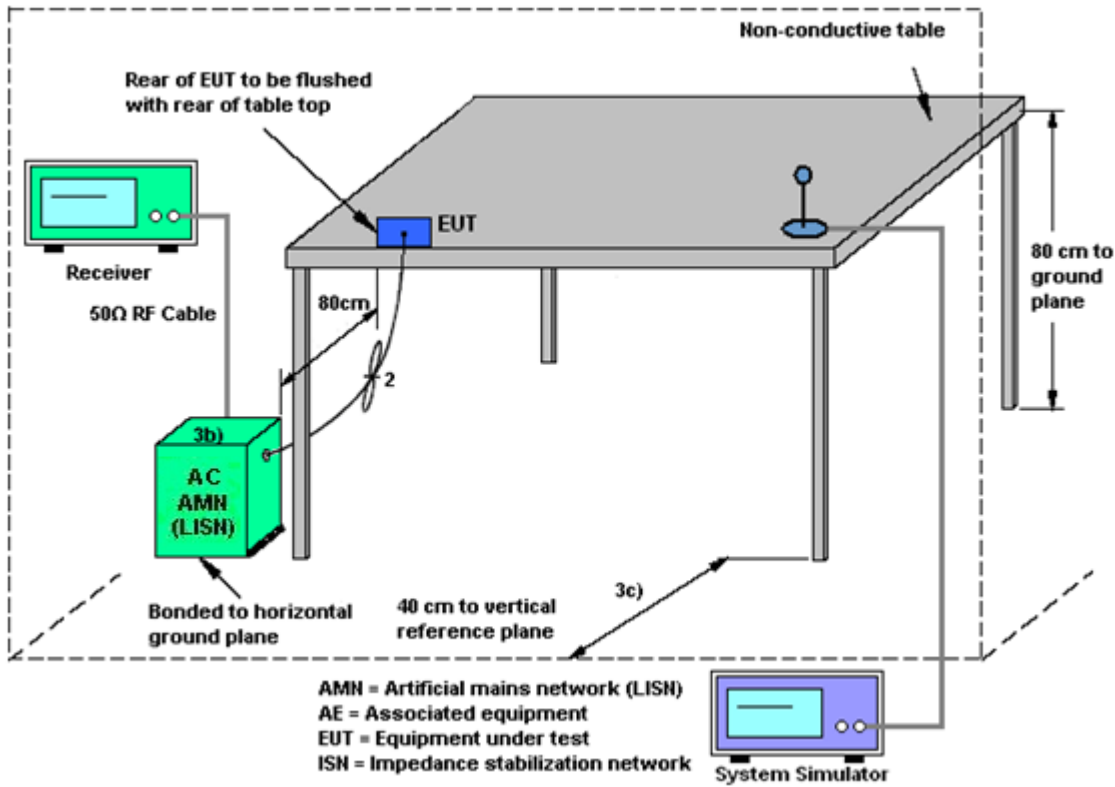

### 3.1.5 Test Result of AC Conducted Emission

Please refer to Appendix A.

## 3.2 20dB and 99% OBW Spectrum Bandwidth Measurement

### 3.2.1 Limit

Intentional radiators must be designed to ensure that the 20dB and 99% emission bandwidth in the specific band 13.553~13.567MHz.

### 3.2.2 Measuring Instruments

See list of measuring instruments of this test report.

### 3.2.3 Test Procedures

1. The spectrum analyzer connected via a receive antenna placed near the EUT in peak Max hold mode.
2. The resolution bandwidth of 1 kHz and the video bandwidth of 3 kHz were used.
3. Measured the spectrum width with power higher than 20dB below carrier.
4. Measured the 99% OBW.

### 3.2.4 Test Setup

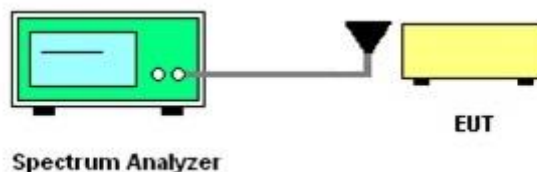

### 3.2.5 Test Result of Conducted Test Items

Please refer to Appendix B.

### 3.3 Frequency Stability Measurement

#### 3.3.1 Limit

The frequency tolerance of the carrier signal shall be maintained within +/- 0.01% (100ppm) of the operating frequency over a temperature variation of -20 degrees to +50 degrees C at normal supply voltage, and for a variation in the primary supply voltage from 85% to 115% of the rated supply voltage at a temperature of 20 degrees C. For battery operated equipment, the equipment tests shall be performed using a new battery.

#### 3.3.2 Measuring Instruments

See list of measuring instruments of this test report.

#### 3.3.3 Test Procedures

1. The spectrum analyzer connected via a receive antenna placed near the EUT.
2. EUT have transmitted signal and fixed channelize.
3. Set the spectrum analyzer span to view the entire emissions bandwidth.
4. Set RBW = 1 kHz, VBW = 3 kHz with peak detector and maxhold settings.
5. The  $f_c$  is declaring of channel frequency. Then the frequency error formula is  $(f_c - f) / f_c \times 10^6$  ppm and the limit is less than  $\pm 100$ ppm.
6. Extreme temperature rule is -20°C~50°C.

#### 3.3.4 Test Setup

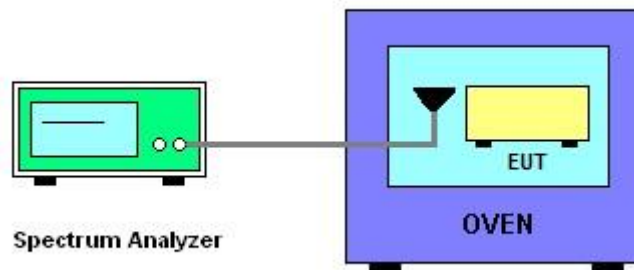

#### 3.3.5 Test Result of Conducted Test Items

Please refer to Appendix B.



### 3.4 Field Strength of Fundamental Emissions and Mask Measurement

#### 3.4.1 Limit

Rules and specifications	FCC CFR 47 Part 15 section 15.225			
Description	Compliance with the spectrum mask is tested with RBW set to 9kHz.			
Freq. of Emission (MHz)	Field Strength (μV/m) at 30m	Field Strength (dBμV/m) at 30m	Field Strength (dBμV/m) at 10m	Field Strength (dBμV/m) at 3m
1.705~13.110	30	29.5	48.58	69.5
13.110~13.410	106	40.5	59.58	80.5
13.410~13.553	334	50.5	69.58	90.5
13.553~13.567	15848	84.0	103.08	124.0
13.567~13.710	334	50.5	69.58	90.5
13.710~14.010	106	40.5	59.58	80.5
14.010~30.000	30	29.5	48.58	69.5

#### 3.4.2 Measuring Instruments

See list of measuring instruments of this test report.

### 3.4.3 Test Procedures

1. Configure the EUT according to ANSI C63.10. The EUT was placed on the top of the turntable 0.8 meter above ground. The phase center of the loop receiving antenna mounted antenna tower was placed 3 meters far away from the turntable.
2. Power on the EUT and all the supporting units. The turntable was rotated by 360 degrees to determine the position of the highest radiation.
3. The height of the receiving antenna was fixed at one meter above ground to find the maximum emissions field strength.
4. For Fundamental emissions, use the receiver to measure QP reading.
5. When the radiated emissions limits are expressed in terms of the average value of the emissions, and pulsed operation is employed, the measurement field strength shall be determined by averaging over one complete pulse train, including blanking intervals, as long as the pulse train does not exceed 0.1 seconds. As an alternative (provided the transmitter operates for longer than 0.1 seconds) or in cases where the pulse train exceeds 0.1 seconds, the measured field strength shall be determined from the average absolute voltage during a 0.1 second interval during which the field strength is at its maximum value.
6. Compliance with the spectrum mask is tested with RBW set to 9kHz.  
Note: Emission level (dB $\mu$ V/m) = 20 log Emission level ( $\mu$ V/m).

### 3.4.4 Test Setup

For radiated emissions below 30MHz

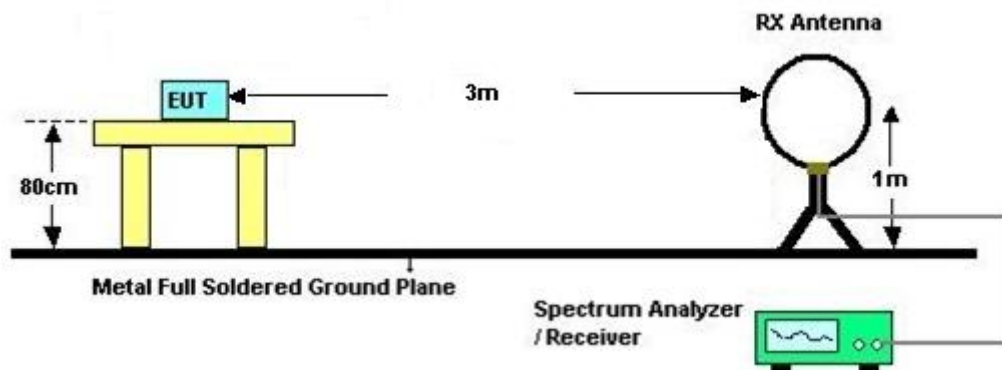

### 3.4.5 Test Result of Field Strength of Fundamental Emissions and Mask

Please refer to Appendix C.



## 3.5 Radiated Emissions Measurement

### 3.5.1 Limit

The field strength of any emissions which appear outside of 13.110 ~14.010MHz band shall not exceed the general radiated emissions limits.

Frequencies (MHz)	Field Strength ( $\mu\text{V/m}$ )	Measurement Distance (meters)
0.009~0.490	2400/F(kHz)	300
0.490~1.705	24000/F(kHz)	30
1.705~30.0	30	30
30~88	100	3
88~216	150	3
216~960	200	3
Above 960	500	3

### 3.5.2 Measuring Instruments

See list of measuring instruments of this test report.

### 3.5.3 Measuring Instrument Setting

The following table is the setting of receiver.

Receiver Parameter	Setting
Attenuation	Auto
Frequency Range: 9kHz~150kHz	RBW 200Hz for QP
Frequency Range: 150kHz~30MHz	RBW 9kHz for QP
Frequency Range: 30MHz~1000MHz	RBW 120kHz for Peak

**Note:** The emission limits shown in the above table are based on measurements employing a CISPR quasi-peak detector except for the frequency bands 9-90 kHz, 110-490 kHz. Radiated emission limits in these two bands are based on measurements employing an average detector.



### **3.5.4 Test Procedures**

1. Configure the EUT according to ANSI C63.10. The EUT was placed on the top of the turntable 0.8 meter above ground. The phase center of the receiving antenna mounted on the top of a height-variable antenna tower was placed 3 meters far away from the turntable.
2. Power on the EUT and all the supporting units. The turntable was rotated by 360 degrees to determine the position of the highest radiation.
3. The height of the broadband receiving antenna was varied between one meter and four meters above ground to find the maximum emissions field strength of both horizontal and vertical polarization.
4. For each suspected emissions, the antenna tower was scan (from 1 M to 4 M) and then the turntable was rotated (from 0 degree to 360 degrees) to find the maximum reading.
5. Set the test-receiver system to Peak or CISPR quasi-peak Detect Function with specified bandwidth under Maximum Hold Mode.
6. When the radiated emissions limits are expressed in terms of the average value of the emissions, and pulsed operation is employed, the measurement field strength shall be determined by averaging over one complete pulse train, including blanking intervals, as long as the pulse train does not exceed 0.1 seconds. As an alternative (provided the transmitter operates for longer than 0.1 seconds) or in cases where the pulse train exceeds 0.1 seconds, the measured field strength shall be determined from the average absolute voltage during a 0.1 second interval during which the field strength is at its maximum value.
7. In case the emission is lower than 30MHz, loop antenna has to be used for measurement and the recorded data should be QP measured by receiver. Antenna Requirements

### 3.5.5 Test Setup

For radiated emissions below 30MHz

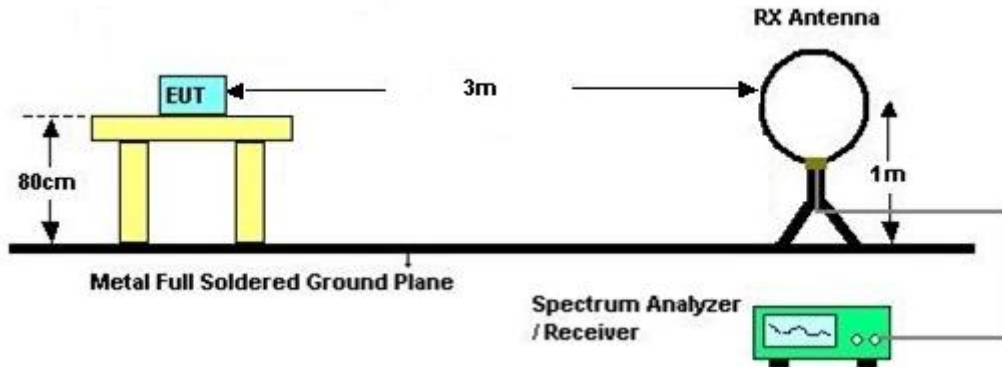

For radiated emissions above 30MHz

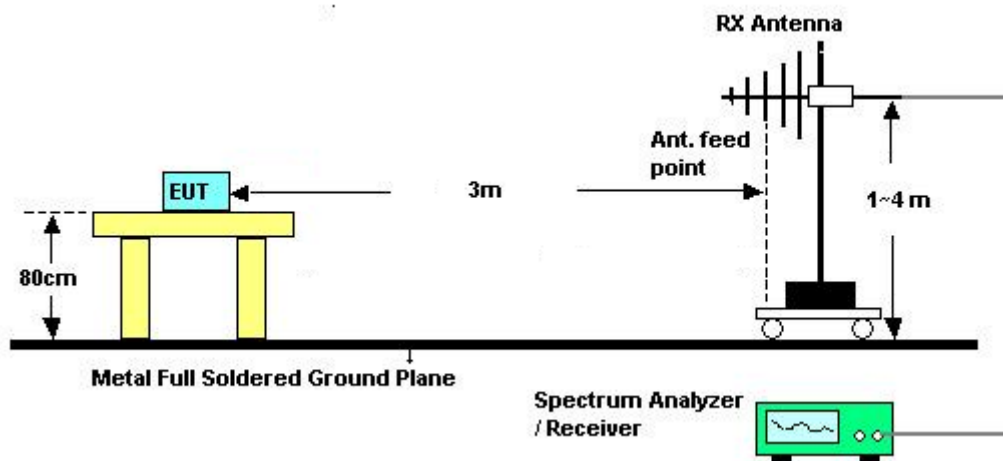

### 3.5.6 Test Result of Radiated Emissions Measurement

Please refer to Appendix C.

**Remark:** There is a comparison data of both open-field test site and semi-Anechoic chamber, and the result came out very similar.



## **3.6 Antenna Requirements**

### **3.6.1 Standard Applicable**

Except for special regulations, the Low-power Radio-frequency Devices must not be equipped with any jacket for installing an antenna with extension cable. An intentional radiator shall be designed to ensure that no antenna other than that furnished by the responsible party shall be used with the device. The use of a permanently attached antenna or of an antenna that uses a unique coupling to the intentional radiator shall be considered sufficient to comply with the provisions of this Section. The manufacturer may design the unit so that the user can replace a broken antenna, but the use of a standard antenna jack or electrical connector is prohibited.

The use of a permanently attached antenna or of an antenna that uses a unique coupling to the intentional radiator shall be considered sufficient to comply with the rule.

### **3.6.2 Antenna Anti-Replacement Construction**

An embedded-in antenna design is used.



### 4. List of Measuring Equipment

Instrument	Manufacturer	Model No.	Serial No.	Characteristics	Calibration Date	Test Date	Due Date	Remark
Spectrum Analyzer	R&S	FSV40	101078	10Hz~40GHz	Apr. 18, 2019	Jun. 23, 2019	Apr. 17, 2020	Conducted (TH01-SZ)
Pulse Power Sensor	Anritsu	MA2411B	1207253	30MHz~40GHz	Dec. 22, 2018	Jun. 23, 2019	Dec. 21, 2019	Conducted (TH01-SZ)
Power Meter	Anritsu	ML2495A	1218010	50MHz Bandwidth	Dec. 22, 2018	Jun. 23, 2019	Dec. 21, 2019	Conducted (TH01-SZ)
EMI Test Receiver&SA	KEYSIGHT	N9038A	MY54450083	20Hz~8.4GHz	Apr. 18, 2019	Jun. 13, 2019	Apr. 17, 2020	Radiation (03CH03-SZ)
EXA Spectrum Analyzer	KEYSIGHT	N9010A	MY55150246	10Hz~44GHz;	Apr. 18, 2019	Jun. 13, 2019	Apr. 17, 2020	Radiation (03CH03-SZ)
Loop Antenna	R&S	HFH2-Z2	100354	9kHz~30MHz	May 29, 2019	Jun. 13, 2019	May 28, 2020	Radiation (03CH03-SZ)
Bilog Antenna	TeseQ	CBL6112D	35408	30MHz-2GHz	Apr. 19, 2019	Jun. 13, 2019	Apr. 18, 2020	Radiation (03CH03-SZ)
Amplifier	Burgeon	BPA-530	102210	0.01Hz ~3000MHz	Oct. 18, 2018	Jun. 13, 2019	Oct. 17, 2019	Radiation (03CH03-SZ)
AC Power Source	Chroma	61601	616010001985	N/A	NCR	Jun. 13, 2019	NCR	Radiation (03CH03-SZ)
Turn Table	EM	EM1000	N/A	0~360 degree	NCR	Jun. 13, 2019	NCR	Radiation (03CH03-SZ)
Antenna Mast	EM	EM1000	N/A	1 m~4 m	NCR	Jun. 13, 2019	NCR	Radiation (03CH03-SZ)
EMI Receiver	R&S	ESR7	101630	9kHz~7GHz;	Dec. 23, 2018	Jun. 03, 2019	Dec. 22, 2019	Conduction (CO01-SZ)
AC LISN	EMCO	3816/2SH	00103912	9kHz~30MHz	Oct. 18, 2018	Jun. 03, 2019	Oct. 17, 2019	Conduction (CO01-SZ)
AC LISN (for auxiliary equipment)	EMCO	3816/2SH	00103892	9kHz~30MHz	Dec. 23, 2018	Jun. 03, 2019	Dec. 22, 2019	Conduction (CO01-SZ)
AC Power Source	Chroma	61602	616020000891	100Vac~250Vac	Jul. 18, 2018	Jun. 03, 2019	Jul. 17, 2019	Conduction (CO01-SZ)

NCR: No Calibration Required



## 5. Uncertainty of Evaluation

The measurement uncertainties shown below were calculated in accordance with the requirements of ANSI 63.10-2013. All the measurement uncertainty value were shown with a coverage K=2 to indicate 95% level of confidence. The measurement data show herein meets or exceeds the CISPR measurement uncertainty values specified in CISPR 16-4-2 and can be compared directly to specified limit to determine compliance.

### Uncertainty of Conducted Emission Measurement (150 kHz ~ 30 MHz)

Measuring Uncertainty for a Level of Confidence of 95% (U = 2Uc(y))	2.6 dB
---	--------

### Uncertainty of Radiated Emission Measurement (9 kHz ~ 30 MHz)

Measuring Uncertainty for a Level of Confidence of 95% (U = 2Uc(y))	5.0 dB
---	--------

### Uncertainty of Radiated Emission Measurement (30 MHz ~ 1000 MHz)

Measuring Uncertainty for a Level of Confidence of 95% (U = 2Uc(y))	5.0 dB
---	--------



## Appendix A. Test Results of Conducted Emission Test

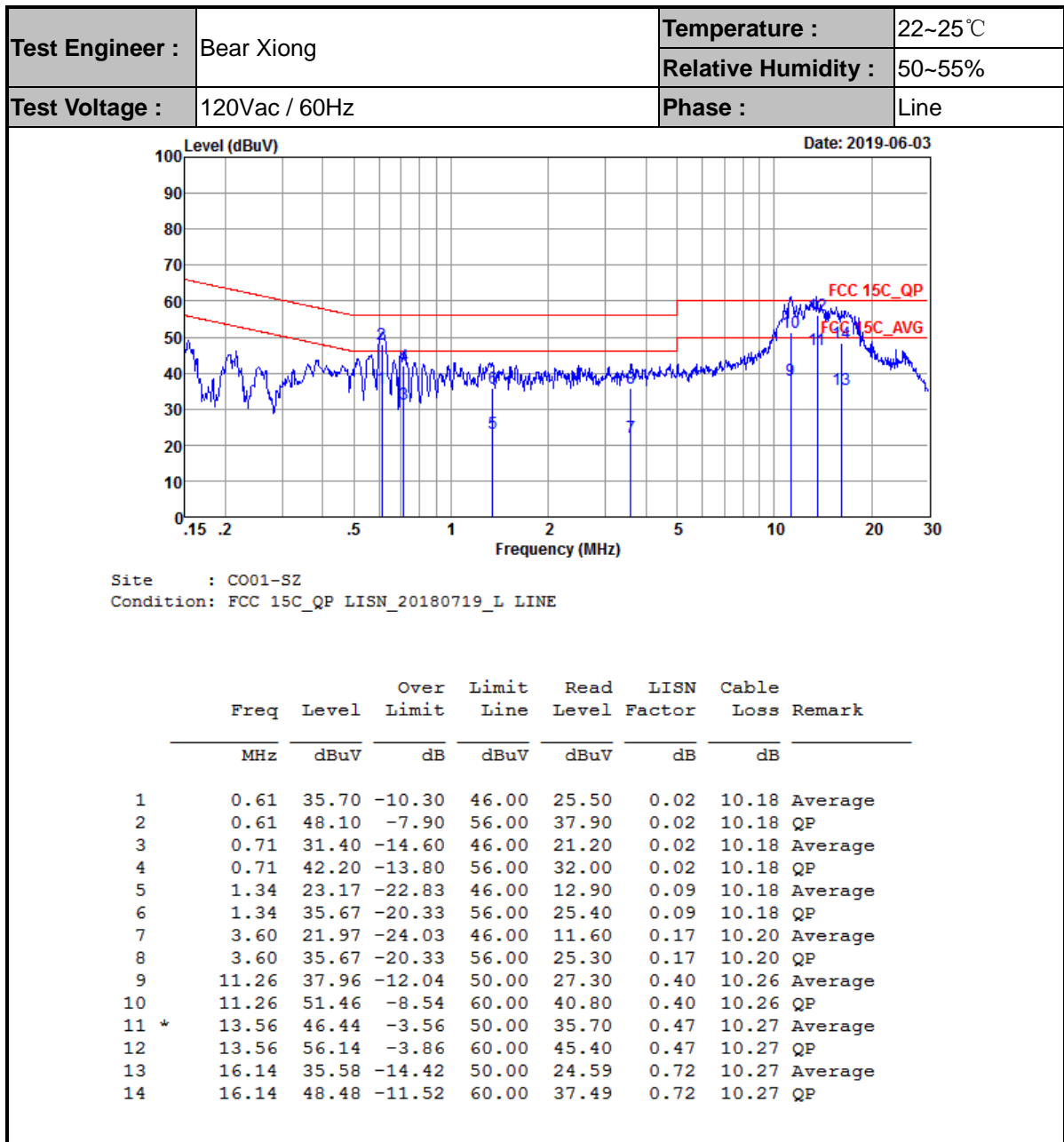



Test Engineer :	Bear Xiong	Temperature :	22~25°C
		Relative Humidity :	50~55%
Test Voltage :	120Vac / 60Hz	Phase :	Neutral

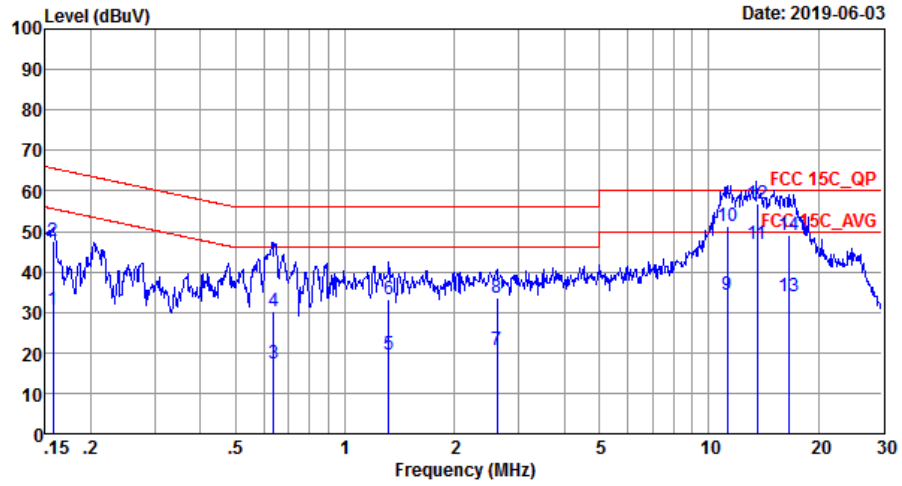

Site : C001-SZ  
 Condition: FCC 15C\_QP LISN\_20180719\_N NEUTRAL

	Freq	Level	Over Limit	Limit Line	Read Level	LISN Factor	Cable Loss	Remark
	MHz	dBuV	dB	dBuV	dBuV	dB	dB	
1	0.16	30.79	-24.81	55.60	20.60	0.03	10.16	Average
2	0.16	47.49	-18.11	65.60	37.30	0.03	10.16	QP
3	0.64	17.20	-28.80	46.00	7.00	0.02	10.18	Average
4	0.64	30.10	-25.90	56.00	19.90	0.02	10.18	QP
5	1.32	19.43	-26.57	46.00	9.20	0.05	10.18	Average
6	1.32	33.23	-22.77	56.00	23.00	0.05	10.18	QP
7	2.62	20.73	-25.27	46.00	10.50	0.04	10.19	Average
8	2.62	33.53	-22.47	56.00	23.30	0.04	10.19	QP
9	11.26	34.27	-15.73	50.00	23.80	0.21	10.26	Average
10	11.26	51.37	-8.63	60.00	40.90	0.21	10.26	QP
11	13.56	46.75	-3.25	50.00	36.19	0.29	10.27	Average
12 *	13.56	56.85	-3.15	60.00	46.29	0.29	10.27	QP
13	16.57	33.98	-16.02	50.00	23.29	0.42	10.27	Average
14	16.57	48.98	-11.02	60.00	38.29	0.42	10.27	QP





# Appendix B. Test Results of Conducted Test Items

## B1. Test Result of 20dB Spectrum Bandwidth

Test mode	NFC Tx	Test Frequency (MHz)	13.56
<b>20dB Bandwidth (kHz)</b>	2.458	<b>99% Occupied BW(kHz)</b>	2.078
<b>Frequency range (MHz)</b>	$f_L > 13.553$	13.55885	<b>Test Result</b>
	$f_H < 13.567$	13.56131	<b>Complies</b>



B2. Test Result of Frequency Stability

B3. Voltage vs. Frequency Stability		Temperature vs. Frequency Stability	
Voltage (Vdc)	Measurement Frequency (MHz)	Temperature (°C)	Measurement Frequency (MHz)
3.55	13.560075	-20	13.560090
3.70	13.560075	-10	13.560080
4.20	13.560075	0	13.560110
-	-	10	13.560090
-	-	20	13.560095
-	-	30	13.560080
-	-	40	13.560090
-	-	50	13.560090
<b>Max.Deviation (MHz)</b>	0.000075	<b>Max.Deviation (MHz)</b>	0.000110
<b>Max.Deviation (ppm)</b>	5.5310	<b>Max.Deviation (ppm)</b>	8.1121
<b>Limit</b>	<b>FS &lt; ±100 ppm</b>	<b>Limit</b>	<b>FS &lt; ±100 ppm</b>
<b>Test Result</b>	<b>PASS</b>	<b>Test Result</b>	<b>PASS</b>



# Appendix C. Test Results of Radiated Test Items

## C1. Test Result of Field Strength of Fundamental Emissions

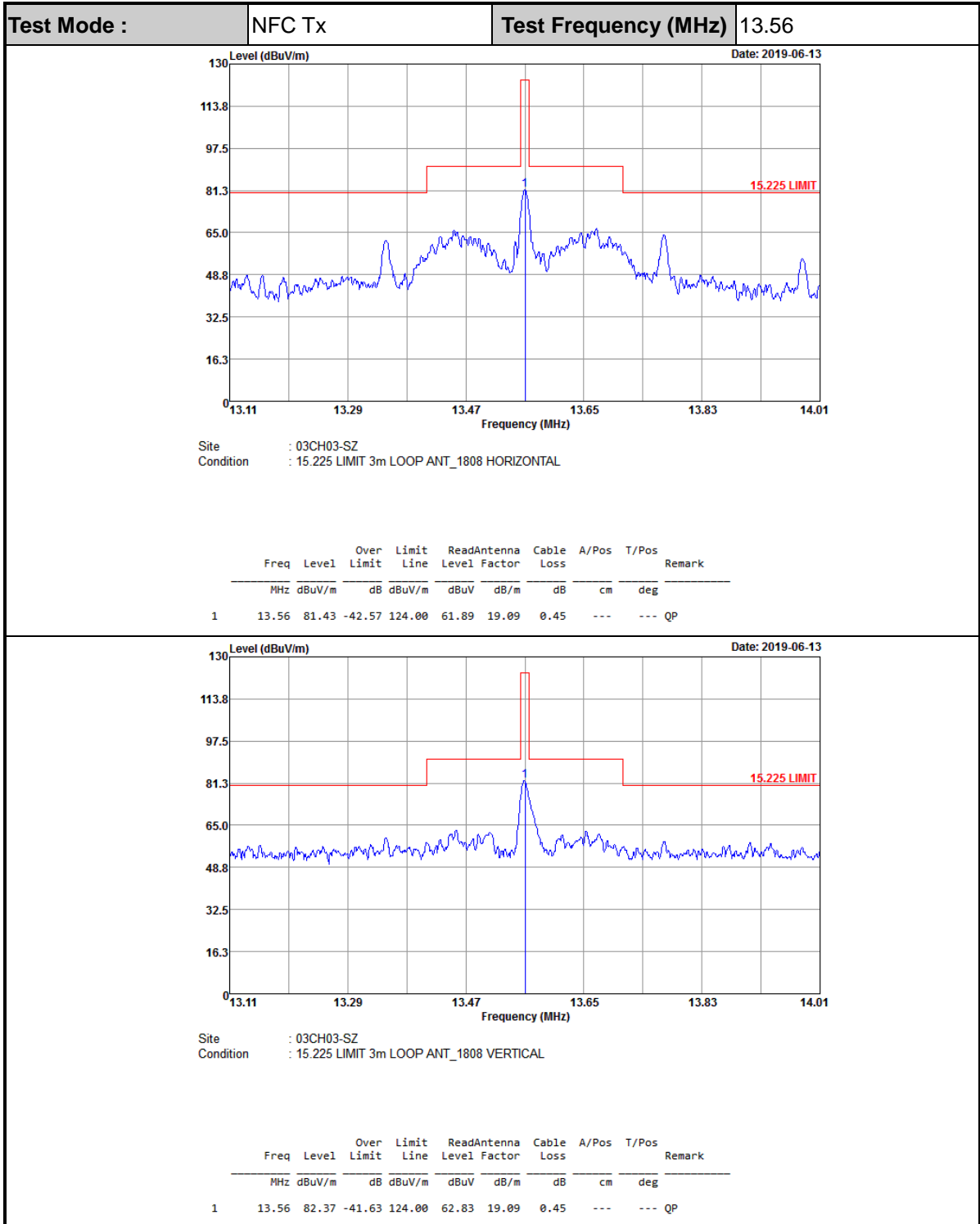



C2. Results of Radiated Spurious Emissions (9 kHz~30MHz)

Test Mode :		NFC Tx			Polarization :		Horizontal		
Frequency ( MHz )	Level ( dBμV/m )	Over Limit ( dB )	Limit Line ( dBμV/m )	Read Level (dBμV)	Antenna Factor ( dB )	Cable Loss ( dB )	Ant Pos ( cm )	Table Pos ( deg )	Remark
0.03838	58.19	-57.73	115.92	38.33	19.80	0.06	-	-	Average
0.07695	53.70	-56.18	109.88	34.34	19.30	0.06	-	-	Average
0.11514	51.13	-55.25	106.38	31.46	19.59	0.08	-	-	Average
0.14799	48.86	-55.34	104.20	29.19	19.57	0.10	-	-	Average
0.95105	42.93	-25.11	68.04	23.38	19.44	0.11	-	-	QP
2.150	37.92	-32.08	70	18.22	19.51	0.19	-	-	QP
9.704	35.47	-34.53	70	15.58	19.51	0.38	-	-	QP
22.885	37.12	-32.88	70	16.85	19.71	0.56	-	-	QP
28.830	35.87	-34.13	70	16.34	18.87	0.66	-	-	QP



Test Mode :		NFC Tx			Polarization :		Vertical		
Frequency ( MHz )	Level ( dBμV/m )	Over Limit ( dB )	Limit Line ( dBμV/m )	Read Level ( dBμV )	Antenna Factor ( dB )	Cable Loss ( dB )	Ant Pos ( cm )	Table Pos ( deg )	Remark
0.03838	58.06	-57.86	115.92	38.20	19.80	0.06	-	-	Average
0.07677	53.99	-55.91	109.9	34.63	19.30	0.06	-	-	Average
0.11517	51.8	-54.58	106.38	32.13	19.59	0.08	-	-	Average
0.14793	49.36	-54.84	104.2	29.69	19.57	0.10	-	-	Average
0.53295	42.91	-30.16	73.07	23.35	19.48	0.08	-	-	QP
2.300	37.43	-32.57	70	17.73	19.51	0.19	-	-	QP
10.512	34.94	-35.06	70	15.07	19.47	0.40	-	-	QP
22.156	36.49	-33.51	70	16.14	19.79	0.56	-	-	QP
27.895	35.92	-34.08	70	16.25	19.03	0.64	-	-	QP

Note:

1. The amplitude of spurious emissions which are attenuated by more than 20dB below the permissible value has no need to be reported.
2. Distance extrapolation factor = 40 log (specific distance / test distance) (dB);
3. Limit line = specific limits (dBμV) + distance extrapolation factor.



C3. Results of Radiated Spurious Emissions (30MHz~1GHz)

Test Mode :		NFC Tx			Polarization :		Horizontal			
Frequency ( MHz )	Level ( dBμV/m )	Over Limit ( dB )	Limit Line ( dBμV/m )	Read Level (dBμV)	Antenna Factor ( dB )	Cable Loss ( dB )	Preamp Factor ( dB )	Ant Pos ( cm )	Table Pos ( deg )	Remark
30.00	28.27	-11.73	40	35.91	24.30	0.56	32.50	-	-	Peak
94.99	28.12	-15.38	43.5	43.42	15.70	1.00	32.00	-	-	Peak
194.90	28.35	-15.15	43.5	43.22	15.50	1.44	31.81	-	-	Peak
480.08	34.83	-11.17	46	40.95	23.14	2.34	31.60	-	-	Peak
623.64	39.96	-6.04	46	44.17	24.79	2.72	31.72	130	77	Peak
960.00	38.72	-7.28	46	39.65	27.06	3.41	31.40	-	-	Peak



Test Mode :		NFC Tx			Polarization :		Vertical			
Frequency ( MHz )	Level ( dBμV/m )	Over Limit ( dB )	Limit Line ( dBμV/m )	Read Level (dBμV)	Antenna Factor ( dB )	Cable Loss ( dB )	Preamp Factor ( dB )	Ant Pos ( cm )	Table Pos ( deg )	Remark
30.00	36.99	-3.01	40	44.63	24.30	0.56	32.50	100	236	QP
50.37	35.22	-4.78	40	53.20	13.90	0.72	32.60	-	-	Peak
67.83	30.72	-9.28	40	49.66	12.62	0.84	32.40	-	-	Peak
94.99	27.36	-16.14	43.5	42.66	15.70	1.00	32.00	-	-	Peak
190.05	30.04	-13.46	43.5	45.05	15.40	1.41	31.82	-	-	Peak
623.64	36.85	-9.15	46	41.06	24.79	2.72	31.72	-	-	Peak

**Note:**

1. The amplitude of spurious emissions which are attenuated by more than 20dB below the permissible value has no need to be reported.
2. Emission level (dBμV/m) = 20 log Emission level (μV/m).
3. Corrected Reading: Antenna Factor + Cable Loss + Read Level - Preamp Factor= Level.