



Test Report No.: RF200327S003-4



FCC TEST REPORT (PART 27)

Applicant:	PAX Technology Limited
Address:	Room 2416, 24/F., Sun Hung Kai Centre, 30 Harbour Hong Kong, China

Manufacturer or Supplier:	PAX Computer Technology (Shenzhen) Co., Ltd.
Address:	4/F, No.3 Building, Software Park, Second Central Science-Tech Road, High-Tech industrial Park, Shenzhen, Guangdong, P.R.C.
Product:	Smart Mobile Payment Terminal
Brand Name:	PAX
Model Name:	A920Pro
FCC ID:	V5PA920PRO
Date of tests:	Apr. 01, 2020~ May 15, 2020

The tests have been carried out according to the requirements of the following standard:

- FCC Part 27, Subpart C, M
- ANSI/TIA/EIA-603-D
- FCC Part 2
- ANSI/TIA/EIA-603-E
- ANSI C63.26-2015

CONCLUSION: The submitted sample was found to COMPLY with the test requirement

Prepared by Evans He Engineer / Mobile Department	Approved by David Huang Manager / Mobile Department
Date: May 18, 2020	Date: May 18, 2020

This report is governed by, and incorporates by reference, CPS Conditions of Service as posted at the date of issuance of this report at <http://www.bureauveritas.com/home/about-us/our-business/cps/about-us/terms-conditions> and is intended for your exclusive use. Any copying or replication of this report to or for any other person or entity, or use of our name or trademark, is permitted only with our prior written permission. This report sets forth our findings solely with respect to the test samples identified herein. The results set forth in this report are not indicative or representative of the quality or characteristics of the lot from which a test sample was taken or any similar or identical product unless specifically and expressly noted. Our report includes all of the tests requested by you and the results thereof based upon the information that you provided to us. Measurement uncertainty is only provided upon request for accredited tests. You have 60 days from date of issuance of this report to notify us of any material error or omission caused by our negligence or if you require measurement uncertainty; provided, however, that such notice shall be in writing and shall specifically address the issue you wish to raise. A failure to raise such issue within the prescribed time shall constitute your unqualified acceptance of the completeness of this report, the tests conducted and the correctness of the report contents.



TABLE OF CONTENTS

RELEASE CONTROL RECORD 4

1 SUMMARY OF TEST RESULTS 5

1.1 MEASUREMENT UNCERTAINTY 5

1.2 TEST SITE AND INSTRUMENTS..... 6

2 GENERAL INFORMATION 7

2.1 GENERAL DESCRIPTION OF EUT 7

2.2 CONFIGURATION OF SYSTEM UNDER TEST..... 9

2.3 DESCRIPTION OF SUPPORT UNITS 10

2.4 TEST ITEM AND TEST CONFIGURATION 10

2.5 GENERAL DESCRIPTION OF APPLIED STANDARDS..... 13

3 TEST TYPES AND RESULTS 14

3.1 OUTPUT POWER MEASUREMENT..... 14

3.1.1 LIMITS OF OUTPUT POWER MEASUREMENT 14

3.1.2 TEST PROCEDURES 14

3.1.3 TEST SETUP 15

3.1.4 TEST RESULTS..... 15

3.2 FREQUENCY STABILITY MEASUREMENT..... 18

3.2.1 LIMITS OF FREQUENCY STABILITY MEASUREMENT 18

3.2.2 TEST PROCEDURE 18

3.2.3 TEST SETUP 18

3.2.4 TEST RESULTS..... 19

3.3 OCCUPIED BANDWIDTH MEASUREMENT 21

3.3.1 LIMITS OF OCCUPIED BANDWIDTH MEASUREMENT 21

3.3.2 TEST SETUP 21

3.3.3 TEST PROCEDURES 21

3.3.4 TEST RESULTS..... 22

3.4 PEAK TO AVERAGE RATIO..... 24

3.4.1 LIMITS OF PEAK TO AVERAGE RATIO MEASUREMENT 24

3.4.2 TEST SETUP 24

3.4.3 TEST PROCEDURES 24

3.4.4 TEST RESULTS..... 25

3.5 BAND EDGE MEASUREMENT 26

3.5.1 LIMITS OF BAND EDGE MEASUREMENT 26

3.5.2 TEST SETUP 27

3.5.3 TEST PROCEDURES 28

3.5.4 TEST RESULTS..... 29

3.6 CONDUCTED SPURIOUS EMISSIONS..... 31

3.6.1 LIMITS OF CONDUCTED SPURIOUS EMISSIONS MEASUREMENT 31

3.6.2 TEST PROCEDURE 32

3.6.3 TEST SETUP 32

3.6.4 TEST RESULTS..... 33

3.7 RADIATED EMISSION MEASUREMENT 35

3.7.1 LIMITS OF RADIATED EMISSION MEASUREMENT..... 35

3.7.2 TEST PROCEDURES 36

3.7.3 DEVIATION FROM TEST STANDARD..... 37

3.7.4 TEST SETUP 38

3.7.5 TEST RESULTS..... 39



**BUREAU
VERITAS**

Test Report No.: RF200327S003-4

**5 APPENDIX A – MODIFICATIONS RECORDERS FOR ENGINEERING CHANGES TO THE EUT
BY THE LAB 45**



Test Report No.: RF200327S003-4

RELEASE CONTROL RECORD

ISSUE NO.	REASON FOR CHANGE	DATE ISSUED
RF200327S003-4	Original release	May 18, 2020

1 SUMMARY OF TEST RESULTS

The EUT has been tested according to the following specifications:

APPLIED STANDARD: FCC Part 27 & Part 2		
STANDARD SECTION	TEST TYPE AND LIMIT	RESULT
2.1046 27.50(b)(10) (c)(10) (h)(2)	Equivalent Isotropically Radiated Power	Compliance
2.1055 27.54	Frequency Stability	Compliance
2.1049	Occupied Bandwidth	Compliance
27.50(d)(5)	Peak to average ratio	Compliance
2.1051 27.53(c)(f)(g) (m)(4)(6)	Band Edge Measurements	Compliance
2.1051 27.53(c)(f)(g) (m)(4)	Conducted Spurious Emissions	Compliance
2.1053 27.53(c)(f)(g) (m)(4)	Radiated Spurious Emissions	Compliance

1.1 MEASUREMENT UNCERTAINTY

Where relevant, the following measurement uncertainty levels have been estimated for tests performed on the EUT as specified in CISPR 16-4-2:

MEASUREMENT	FREQUENCY	UNCERTAINTY
Conducted emissions	9kHz~30MHz	2.70dB
Radiated emissions	9KHz ~ 30MHz	2.16dB
	30MHz ~ 1GHz	3.74dB
	1GHz ~ 18GHz	4.66dB
	18GHz ~ 40GHz	4.67dB

This uncertainty represents an expanded uncertainty expressed at approximately the 95% confidence level using a coverage factor of k=2.



**BUREAU
VERITAS**

Test Report No.: RF200327S003-4

1.2 TEST SITE AND INSTRUMENTS

Equipment	Manufacturer	Model No.	Serial No.	Last Cal.	Next Cal.
EMI Test Receiver	Rohde&Schwarz	ESL6	1300.5001K06-10 0262-eQ	Mar. 24,20	Mar. 24,21
Bilog Antenna	Sunol Sciences	JB6	A110712	Apr. 08, 20	Apr. 07, 21
Active Antenna	CMO-POWER	AL-130	121031	Mar. 27, 20	Mar. 26, 21
Signal Amplifier	HP	8447E	443008	Mar. 24, 20	Mar. 24, 21
Spectrum	Agilent	E4446A	MY46180622	Mar. 24, 20	Mar. 24, 21
MXA signal analyzer	Agilent	N9020A	MY49100060	Mar. 22, 20	Mar. 21, 21
Horn Antenna	COM-POWER	HAH-118	71259	Mar. 20, 20	Mar. 19, 21
Horn Antenna	COM-POWER	HAH-118	71283	Jun. 30, 19	Jun. 29, 20
SHF-EHF Horn	Schwarzbeck	BBHA9170	BBHA9170147	Jun. 30, 19	Jun. 29, 20
SHF-EHF Horn	Schwarzbeck	BBHA9170	BBHA9170242	Mar. 24, 20	Mar. 24, 21
AMPLIFIER	EM Electornic Corporation	EM01G26G	60613	Jan. 04, 20	Jan. 03,21
AMPLIFIER	Emc Instruments Corporation	Emc012645	980077	Oct. 18,18	Oct. 17,21
3m Semi-anechoic Chamber	SAEMC	9m*6m*6m	N/A	Mar. 24, 20	Mar. 24, 21
Test Software	EZ-EMC	ICP-03A1	N/A	N/A	N/A
Wireless Connectivity Tester	R&S	CMW270	1201.0002K75	Dec. 18, 19	Dec. 17, 20
MXA VEXTOR SIGNAL	Agilent	n5182a	MY50140530	Mar. 24,20	Mar. 24,21
MXA signal analyzer	Agilent	n9020a	MY49100060	Mar. 24,20	Mar. 24,21
RF Control Unit	Tonscend	JS0806-2	188060112	Mar. 24,20	Mar. 24,21
Signal Generation	Agilent	E4421B	US40051152	Dec. 18, 19	Dec. 17, 20
DC Power Supply	Agilent	E3640A	MY40004013	Mar. 28,20	Mar. 27,21
Programmable Temperature & Humidity Chamber	Hongjin	HYC-TH-22 5DH	DG-180746	Mar. 24,20	Mar. 24,21
Test System	Tonscend	JS 1120-3	N/A	N/A	N/A
Power Splitter	Weinschel	1580-1	TL177	Mar. 20,20	Mar. 19,21
Universal Radio Communication	ROHDE&SCHW ARZ	CMU200	112012	Mar. 24,20	Mar. 24,21
Universal Radio Communication	ROHDE&SCHW ARZ	CMU200	121393	Mar. 28,20	Mar. 27,21
Wireless Communication Test Set	ROHDE&SCHW ARZ	CMW500	1201.0002K500-1 55842-Gd	Nov. 1, 19	Oct. 31, 20

- NOTE:**
1. The calibration interval of the above test instruments is 12 months (except 3m Semi-anechoic Chamber). And the calibrations are traceable to CEPREI/CHINA, GRGT/CHINA and NIM/CHINA.
 2. The test was performed in 3m Semi-anechoic Chamber and RF Oven Room.
 3. The horn antenna is used only for the measurement of emission frequency above 1GHz if tested.
 4. The FCC Site Registration No. is 535293.

2 GENERAL INFORMATION

2.1 GENERAL DESCRIPTION OF EUT

PRODUCT	Smart Mobile Payment Terminal	
BRAND NAME	PAX	
MODEL NAME	A920Pro	
POWER SUPPLY	5.0Vdc (adapter or host equipment) 3.7Vdc (Li-ion, ion battery)	
MODULATION TECHNOLOGY	LTE	QPSK, 16QAM
FREQUENCY RANGE	LTE Band 17 Channel Bandwidth: 5MHz	706.5MHz ~ 713.5MHz
	LTE Band 17 Channel Bandwidth: 10MHz	709MHz ~ 711MHz
EMISSION DESIGNATOR	LTE Band 17 Channel Bandwidth: 5MHz	QPSK: 4M48G7D 16QAM: 4M49W7D
	LTE Band 17 Channel Bandwidth: 10MHz	QPSK: 8M97G7D 16QAM: 8M7W7D
MAX. EIRP POWER	LTE Band 17 Channel Bandwidth: 5MHz	186.21mW
	LTE Band 17 Channel Bandwidth: 10MHz	189.67mW
ANTENNA TYPE	FPC Antenna with 1dBi gain	
HW VERSION	N/A	
SW VERSION	N/A	
DATA CABLE	USB cable: non-shielded, detachable, 1.0m	
EUT STAGE	Production Unit	

NOTE:

- For a more detailed features description, please refer to the manufacturer's specifications or the user's manual.
- The EUT was powered by the following adapter:

ADAPTER	
BRAND:	N/A
MODEL:	GLH50D2000HW
INPUT:	100-240V~50/60Hz 0.40A
OUTPUT:	5.0V --- 2000mA

- The EUT matched the following USB cable:

USB CABLE	
BRAND:	N/A
MODEL:	N/A
SIGNAL LINE:	1.0 METER



**BUREAU
VERITAS**

Test Report No.: RF200327S003-4

4. The EUT was powered by the following Battery:

ADAPTER	
BRAND:	VEKEN
MODEL:	YW-008
POWER RATING:	3.7V --- 5150mAh 19.05Wh

5. For the test results, the EUT had been tested with all conditions. But only the worst case was shown in test report.

2.2 CONFIGURATION OF SYSTEM UNDER TEST

FOR RADIATION EMISSION TEST

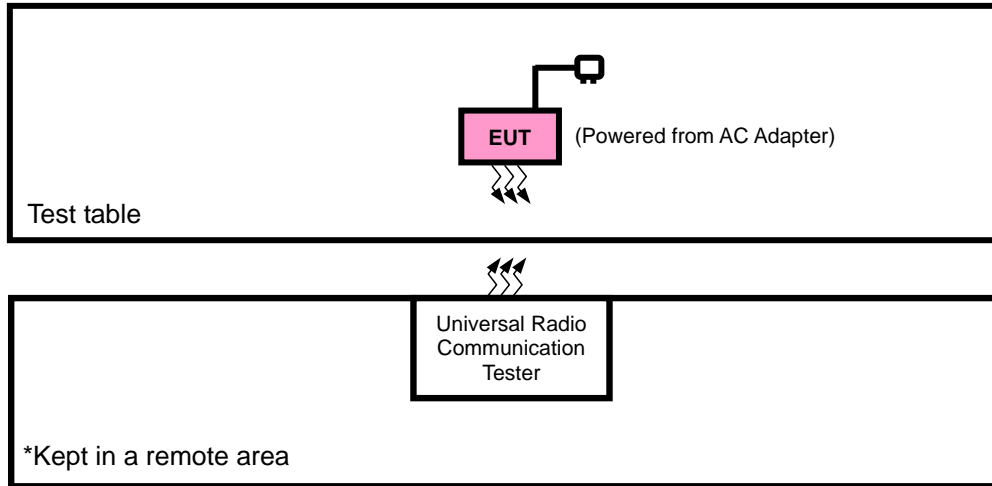

FOR CONDUCTED & E.I.R.P. TEST

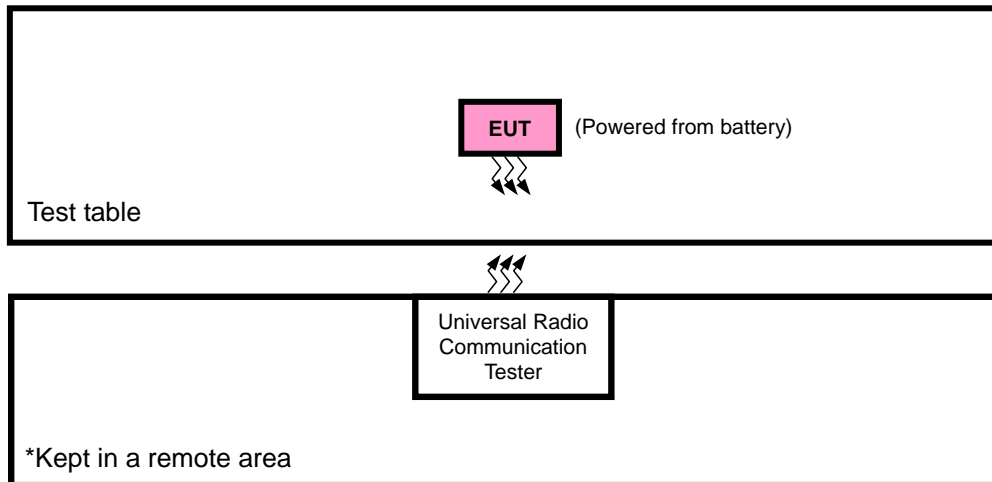

2.3 DESCRIPTION OF SUPPORT UNITS

The EUT has been tested as an independent unit together with other necessary accessories or support units. The following support units or accessories were used to form a representative test configuration during the tests.

NO.	PRODUCT	BRAND	MODEL NO.	SERIAL NO.	FCC ID
1	N/A	N/A	N/A	N/A	N/A

NO.	SIGNAL CABLE DESCRIPTION OF THE ABOVE SUPPORT UNITS
1	N/A

2.4 TEST ITEM AND TEST CONFIGURATION

Pre-Scan has been conducted to determine the worst-case mode from all possible combinations between available modulations, data rates, XYZ axis and antenna ports. The worst case was found when positioned on Y-plane for EIRP and X-axis for radiated emission. Following channel(s) was (were) selected for the final test as listed below:

EUT CONFIGURE MODE	DESCRIPTION
A	EUT + Adapter + USB Cable with LTE link
B	EUT + Battery with LTE link

LTE BAND 7 MODE

TEST ITEM	AVAILABLE CHANNEL	TESTED CHANNEL	CHANNEL BANDWIDTH	MODULATION	MODE	
EIRP	20775 to 21425	20775, 21100, 21425	5MHz	QPSK, 16QAM	1 RB / 0 RB Offset	
	20800 to 21400	20800, 21100, 21400	10MHz	QPSK, 16QAM	1 RB / 0RB Offset	
	20825 to 21375	20825, 21100, 21375	15MHz	QPSK, 16QAM	1 RB / 0 RB Offset	
	20850 to 21350	20850, 21100, 21350	20MHz	QPSK, 16QAM	1 RB / 0 RB Offset	
FREQUENCY STABILITY	20775 to 21425	20775, 21425	5MHz	QPSK	1 RB / 0 RB Offset	
	20800 to 21400	20800, 21400	10MHz	QPSK	1 RB / 0RB Offset	
	20825 to 21375	20825, 21375	15MHz	QPSK	1 RB / 0 RB Offset	
	20850 to 21350	20850, 21350	20MHz	QPSK	1 RB / 0 RB Offset	
OCCUPIED BANDWIDTH	20775 to 21425	20775, 21100, 21425	5MHz	QPSK, 16QAM	25 RB / 0 RB Offset	
	20800 to 21400	20800, 21100, 21400	10MHz	QPSK, 16QAM	50 RB / 0 RB Offset	
	20825 to 21375	20825, 21100, 21375	15MHz	QPSK, 16QAM	75 RB / 0 RB Offset	
	20850 to 21350	20850, 21100, 21350	20MHz	QPSK, 16QAM	100 RB / 0 RB Offset	
PEAK TO AVERAGE RATIO	20775 to 21425	20775, 21100, 21425	5MHz	QPSK	1 RB / 0 RB Offset	
	20800 to 21400	20800, 21100, 21400	10MHz	QPSK	1 RB / 0RB Offset	
	20825 to 21375	20825, 21100, 21375	15MHz	QPSK	1 RB / 0 RB Offset	
	20850 to 21350	20850, 21100, 21350	20MHz	QPSK	1 RB / 0 RB Offset	
BAND EDGE	20775 to 21425	20775	5MHz	QPSK, 16QAM	1 RB / 0 RB Offset 25 RB / 0 RB Offset	
		21425	5MHz	QPSK, 16QAM	1 RB / 24 RB Offset 25 RB / 0 RB Offset	
	20800 to 21400	20800	10MHz	QPSK, 16QAM	1 RB / 0 RB Offset 50 RB / 0 RB Offset	
		21400	10MHz	QPSK, 16QAM	1 RB / 49 RB Offset 50 RB / 0 RB Offset	
	20825 to 21375	20825	15MHz	QPSK, 16QAM	1 RB / 0 RB Offset 75 RB / 0 RB Offset	
		21375	15MHz	QPSK, 16QAM	1 RB / 74 RB Offset 75 RB / 0 RB Offset	
	20850 to 21350	20850	20MHz	QPSK, 16QAM	1 RB / 0 RB Offset 100 RB / 0 RB Offset	
		21350	20MHz	QPSK, 16QAM	1 RB / 99 RB Offset 100 RB / 0 RB Offset	
	CONDCUDET ED EMISSION	20775 to 21425	20775, 21100, 21425	5MHz	QPSK	1 RB / 0 RB Offset
		20800 to 21400	20800, 21100, 21400	10MHz	QPSK	1 RB / 0RB Offset
		20825 to 21375	20825, 21100, 21375	15MHz	QPSK	1 RB / 0 RB Offset
		20850 to 21350	20850, 21100, 21350	20MHz	QPSK	1 RB / 0 RB Offset
RADIATED EMISSION	20775 to 21425	21100	5MHz	QPSK	1 RB / 0 RB Offset	
	20800 to 21400	20800, 21100, 21400	10MHz	QPSK	1 RB / 0RB Offset	
	20825 to 21375	21100	15MHz	QPSK	1 RB / 0 RB Offset	
	20850 to 21350	21100	20MHz	QPSK	1 RB / 0 RB Offset	

Note: This device was tested under all bandwidths, RB configurations and modulations. The worst case was found in QPSK modulation.

LTE BAND 17 MODE

TEST ITEM	AVAILABLE CHANNEL	TESTED CHANNEL	CHANNEL BANDWIDTH	MODULATION	MODE	
EIRP	23755 to 23825	23755, 23790, 23825	5MHz	QPSK, 16QAM	1 RB / 0 RB Offset	
	23780 to 23800	23780, 23790, 23800	10MHz	QPSK, 16QAM	1 RB / 0RB Offset	
FREQUENCY STABILITY	23755 to 23825	23755, 23825	5MHz	QPSK	1 RB / 0 RB Offset	
	23780 to 23800	23780, 23800	10MHz	QPSK	1 RB / 0RB Offset	
OCCUPIED BANDWIDTH	23755 to 23825	23755, 23790, 23825	5MHz	QPSK, 16QAM	25 RB / 0 RB Offset	
	23780 to 23800	23780, 23790, 23800	10MHz	QPSK, 16QAM	50 RB / 0 RB Offset	
PEAK TO AVERAGE RATIO	23755 to 23825	23755, 23790, 23825	5MHz	QPSK	1 RB / 0 RB Offset	
	23780 to 23800	23780, 23790, 23800	10MHz	QPSK	1 RB / 0RB Offset	
BAND EDGE	23755 to 23825	23755	5MHz	QPSK, 16QAM	1 RB / 0 RB Offset 25 RB / 0 RB Offset	
		23825	5MHz	QPSK, 16QAM	1 RB / 24 RB Offset 25 RB / 0 RB Offset	
	23780 to 23800	23780	10MHz	QPSK, 16QAM	1 RB / 0 RB Offset 50 RB / 0 RB Offset	
		23800	10MHz	QPSK, 16QAM	1 RB / 49 RB Offset 50 RB / 0 RB Offset	
	CONDUCTED EMISSION	23755 to 23825	23755, 23790, 23825	5MHz	QPSK	1 RB / 0 RB Offset
		23780 to 23800	23780, 23790, 23800	10MHz	QPSK	1 RB / 0RB Offset
RADIATED EMISSION	23755 to 23825	23790	5MHz	QPSK	1 RB / 0 RB Offset	
	23780 to 23800	23780, 23790, 23800	10MHz	QPSK	1 RB / 0RB Offset	

Note: This device was tested under all bandwidths, RB configurations and modulations. The worst case was found in QPSK modulation.



TEST CONDITION:

TEST ITEM	ENVIRONMENTAL CONDITIONS	INPUT POWER	TESTED BY
EIRP	24deg. C, 55%RH	3.7Vdc from Battery	Aaron liang
FREQUENCY STABILITY	24deg. C, 55%RH	DC 3.4V/3.7V/4.2V	Aaron liang
OCCUPIED BANDWIDTH	24deg. C, 55%RH	3.7Vdc from Battery	Aaron liang
PEAK TO AVERAGE RATIO	24deg. C, 55%RH	3.7Vdc from Battery	Aaron liang
BAND EDGE	24deg. C, 55%RH	3.7Vdc from Battery	Aaron liang
CONDCUDED EMISSION	24deg. C, 55%RH	3.7Vdc from Battery	Aaron liang
RADIATED EMISSION	24deg. C, 55%RH	5Vdc from adapter	Aaron liang

2.5 GENERAL DESCRIPTION OF APPLIED STANDARDS

The EUT is a RF product. According to the specifications of the manufacturer, it must comply with the requirements of the following standards:

FCC 47 CFR Part 2

FCC 47 CFR Part 27

KDB 971168 D01 Power Meas License Digital Systems v03r01

ANSI/TIA/EIA-603-D

ANSI/TIA/EIA-603-E

ANSI C63.26-2015

NOTE: All test items have been performed and recorded as per the above standards.

3 TEST TYPES AND RESULTS

3.1 OUTPUT POWER MEASUREMENT

3.1.1 LIMITS OF OUTPUT POWER MEASUREMENT

27.50(c)(10) Portable stations (hand-held devices) operating in the 699-716 MHz bands are limited to 3 watts ERP.

3.1.2 TEST PROCEDURES

EIRP MEASUREMENT:

Per KDB 971168 D01 Power Meas License Digital Systems v03r01 or subclause 5.2.5.5 of ANSI C63.26-2015, the relevant equation for determining the ERP or EIRP from the conducted RF output power measured using the guidance provided above is:

$$\text{ERP or EIRP} = P_{\text{Meas}} + G_{\text{T}} - L_{\text{c}}$$

Where:

ERP or EIRP = effective radiated power or equivalent isotropically radiated power, respectively

(expressed in the same units as P_{Meas} , typically dBW or dBm);

P_{Meas} = measured transmitter output power or PSD, in dBm or dBW;

G_{T} = gain of the transmitting antenna, in dBd (ERP) or dBi (EIRP);

L_{c} = signal attenuation in the connecting cable between the transmitter and antenna, in dB.

CONDUCTED POWER MEASUREMENT:

- The EUT was set up for the maximum power with LTE link data modulation and link up with simulator.
- Set the EUT to transmit under low, middle and high channel and record the power level shown on simulator.

3.1.3 TEST SETUP

CONDUCTED POWER MEASUREMENT:

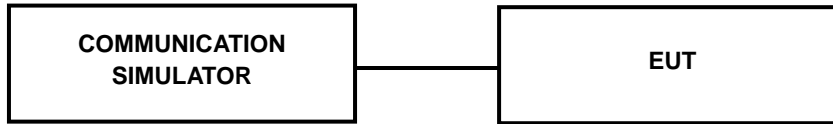

For the actual test configuration, please refer to the attached file (Test Setup Photo).

3.1.4 TEST RESULTS

LTE Band 17							
BW	Modulation	RB Size	RB Offset	Low CH 23755	Mid CH 23790	High CH 23825	3GPP MPR (dB)
				Frequency 706.5 MHz	Frequency 710 MHz	Frequency 713.5MHz	
5MHz	QPSK	1	0	23.61	23.55	23.49	0
		1	12	23.6	23.85	23.54	0
		1	24	23.65	23.44	23.53	0
		12	0	22.54	22.51	22.58	1
		12	6	22.62	22.78	22.49	1
		12	13	22.65	22.58	22.41	1
		25	0	22.6	22.76	22.66	1
	16QAM	1	0	22.62	22.31	22.56	1
		1	12	22.52	22.59	22.43	1
		1	24	22.63	22.21	22.56	1
		12	0	21.82	21.56	21.61	2
		12	6	21.83	21.75	21.61	2
		12	13	21.78	21.79	21.54	2
		25	0	21.82	21.69	21.64	2

LTE Band 17							
BW	Modulation	RB Size	RB Offset	Low CH 23780	Mid CH 23790	High CH 23800	3GPP MPR (dB)
				Frequency 709 MHz	Frequency 710 MHz	Frequency 711 MHz	
10MHz	QPSK	1	0	23.47	23.5	23.64	0
		1	24	23.37	23.77	23.93	0
		1	49	23.57	23.51	23.7	0
		25	0	22.54	22.63	22.64	1
		25	12	22.51	22.69	22.71	1
		25	25	22.54	22.47	22.62	1
		50	0	22.69	22.74	22.69	1
	16QAM	1	0	22.04	22.8	23.04	1
		1	24	22.07	23.14	23.2	1
		1	49	22.05	22.92	22.92	1
		25	0	21.82	21.72	21.9	2
		25	12	21.77	21.87	21.92	2
		25	25	21.89	21.87	21.94	2
		50	0	21.64	21.76	21.75	2

EIRP

LTE BAND 17

CHANNEL BANDWIDTH: 5MHz QPSK

Channel	Frequency (MHz)	Conducted Power (dBm)	GT-LC (dB)	EIRP (dBm)	EIRP (mW)	Limit (W)
23755	706.5	23.65	1	22.5	177.83	3
23790	710.0	23.85	1	22.7	186.21	3
23825	713.5	23.54	1	22.39	173.38	3

CHANNEL BANDWIDTH: 5MHz 16QAM

Channel	Frequency (MHz)	Conducted Power (dBm)	GT-LC (dB)	EIRP (dBm)	EIRP (mW)	Limit (W)
23755	706.5	22.63	1	21.48	140.6	3
23790	710.0	22.59	1	21.44	139.32	3
23825	713.5	22.56	1	21.41	138.36	3

CHANNEL BANDWIDTH: 10MHz QPSK

Channel	Frequency (MHz)	Conducted Power (dBm)	GT-LC (dB)	EIRP (dBm)	EIRP (mW)	Limit (W)
23780	706.5	23.57	1	22.42	174.58	3
23790	710.0	23.77	1	22.62	182.81	3
23800	713.5	23.93	1	22.78	189.67	3

CHANNEL BANDWIDTH: 10MHz 16QAM

Channel	Frequency (MHz)	Conducted Power (dBm)	GT-LC (dB)	EIRP (dBm)	EIRP (mW)	Limit (W)
23780	706.5	22.07	1	20.92	123.59	3
23790	710.0	23.14	1	21.99	158.12	3
23800	713.5	23.2	1	22.05	160.32	3

REMARKS: 1. ERP Output Power (dBm) = SPA LVL (dBm) + Correction Factor (dB) -2.15(dB).
 2. Correction factor (dB) = Free Space Loss + Antenna Factor + Cable Loss

3.2 FREQUENCY STABILITY MEASUREMENT

3.2.1 LIMITS OF FREQUENCY STABILITY MEASUREMENT

The frequency stability shall be sufficient to ensure that the fundamental emissions stay within the authorized bands of operation.

3.2.2 TEST PROCEDURE

- a. Device is placed at the oven room. The oven room could control the temperatures and humidity. Power warm up is at least 15 min and power applied should perform before recording frequency error.
- b. EUT is connected the external power supply to control the DC input power. The test voltage range is from minimum to maximum working voltage. Each step shall be record the frequency error rate.
- c. The temperature range step is 10 degrees in this test items. All temperature levels shall be hold the $\pm 0.5^{\circ}\text{C}$ during the measurement testing. The each temperature step shall be at least 0.5 hours, consider the EUT could be test under the stability condition.

NOTE: The frequency error was recorded frequency error from the communication simulator.

3.2.3 TEST SETUP

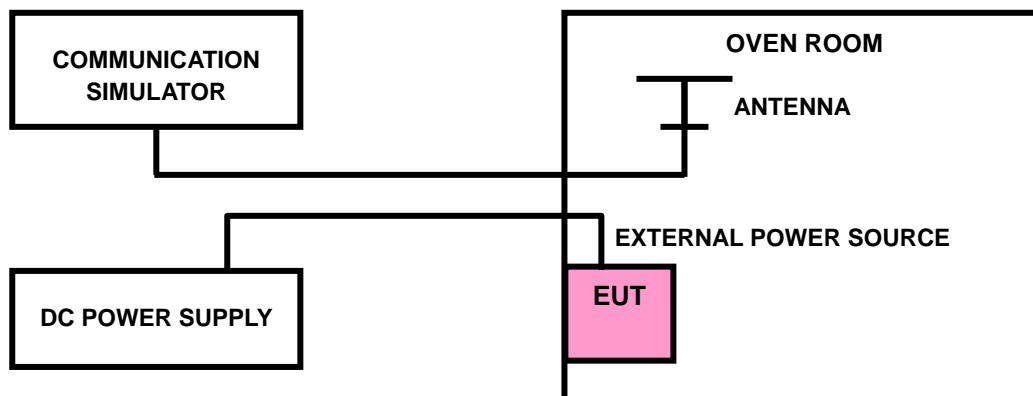

3.2.4 TEST RESULTS

LTE BAND 17

FREQUENCY ERROR VS. VOLTAGE

VOLTAGE (Volts)	5MHz		LIMIT (ppm)
	FREQUENCY ERROR (ppm)		
	Low Channel	High Channel	
3.8	0.1112	0.0965	2.5
3.55(BEP)	0.1191	0.0999	2.5
4.35	0.1282	0.1051	2.5

NOTE: The applicant defined the normal working voltage of the battery is from 3.5Vdc to 4.2Vdc.

FREQUENCY ERROR vs. TEMPERATURE.

TEMP. (°C)	5MHz		LIMIT (ppm)
	FREQUENCY ERROR (ppm)		
	Low Channel	High Channel	
-30	0.1213	0.1013	2.5
-20	0.1076	0.1019	2.5
-10	0.1221	0.0889	2.5
0	0.1145	0.0907	2.5
10	0.1024	0.105	2.5
20	0.1083	0.0945	2.5
30	0.0939	0.0928	2.5
40	0.0812	0.1066	2.5
50	0.0775	0.1116	2.5

FREQUENCY ERROR VS. VOLTAGE

VOLTAGE (Volts)	10MHz		LIMIT (ppm)
	FREQUENCY ERROR (ppm)		
	Low Channel	High Channel	
3.8	0.1037	0.0995	2.5
3.55(BEP)	0.1076	0.1126	2.5
4.35	0.1152	0.11	2.5

NOTE: The applicant defined the normal working voltage of the battery is from 3.5Vdc to 4.2Vdc.

FREQUENCY ERROR vs. TEMPERATURE.

TEMP. (°C)	10MHz		LIMIT (ppm)
	FREQUENCY ERROR (ppm)		
	Low Channel	High Channel	
-30	0.0981	0.1067	2.5
-20	0.0892	0.1133	2.5
-10	0.0911	0.1118	2.5
0	0.078	0.1004	2.5
10	0.0888	0.1082	2.5
20	0.0972	0.1139	2.5
30	0.1073	0.1211	2.5
40	0.101	0.1303	2.5
50	0.0928	0.1452	2.5

3.3 OCCUPIED BANDWIDTH MEASUREMENT

3.3.1 LIMITS OF OCCUPIED BANDWIDTH MEASUREMENT

The width of a frequency band such that, below the lower and above the upper frequency limits, the mean powers emitted are each equal to a specified percentage 0.5 % of the total mean power of a given emission.

3.3.2 TEST SETUP

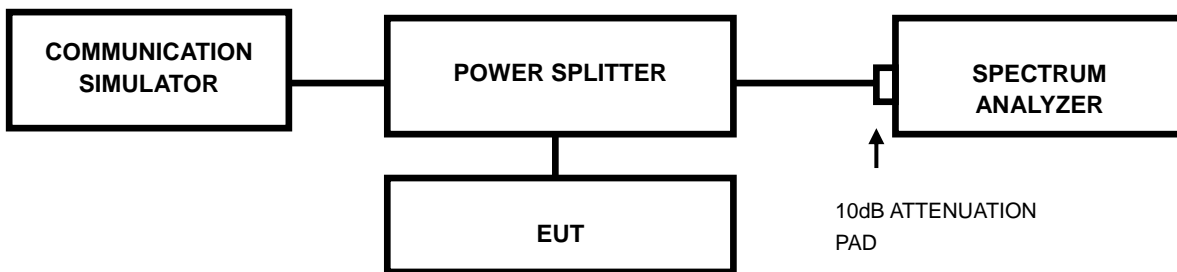

3.3.3 TEST PROCEDURES

- The conducted occupied bandwidth used the power splitter via EUT RF power connector between simulation base station and spectrum analyzer.
- Use OBW measurement function of Spectrum analyzer to measure 99 % occupied bandwidth.

3.3.4 TEST RESULTS

LTE band 17							
Channel Bandwidth : 5MHz							
Channel	Frequency (MHz)	99% Occupied bandwidth (MHz)		Channel	Frequency (MHz)	26 dB bandwidth (MHz)	
		QPSK	16QAM			QPSK	16QAM
23755	706.5	4.48	4.48	23755	706.5	4.99	5.02
23790	710	4.48	4.49	23790	710	4.93	4.95
23825	713.5	4.45	4.46	23825	713.5	5.06	5.06



LTE band 17							
Channel Bandwidth : 10MHz							
Channel	Frequency (MHz)	99% Occupied bandwidth (MHz)		Channel	Frequency (MHz)	26 dB bandwidth (MHz)	
		QPSK	16QAM			QPSK	16QAM
23780	709	8.97	8.97	23780	709	9.74	9.73
23790	710	8.95	8.95	23790	710	9.78	9.86
23800	711	8.94	8.94	23800	711	9.84	9.82

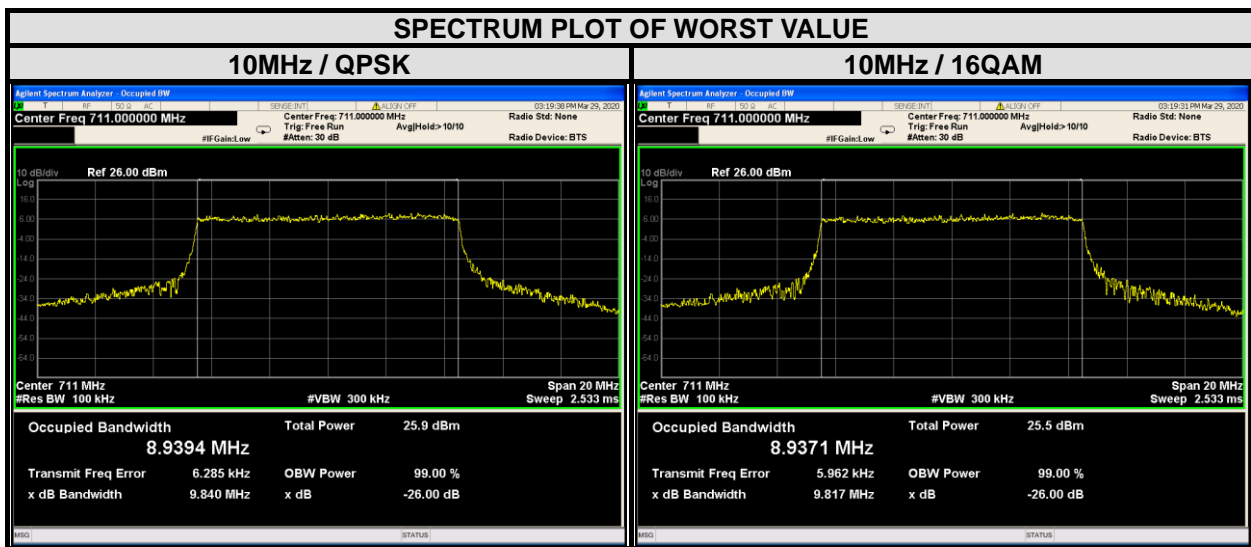

3.4 PEAK TO AVERAGE RATIO

3.4.1 LIMITS OF PEAK TO AVERAGE RATIO MEASUREMENT

In measuring transmissions in this band using an average power technique, the peak to-average ratio (PAR) of the transmission may not exceed 13 dB

3.4.2 TEST SETUP

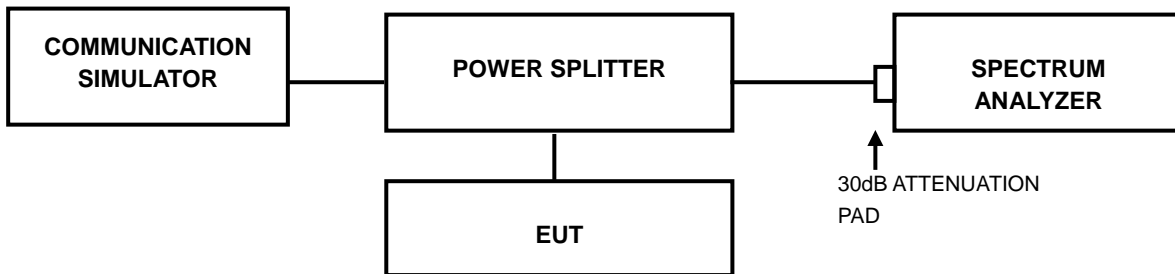

3.4.3 TEST PROCEDURES

1. Set resolution/measurement bandwidth \geq signal's occupied bandwidth;
2. Set the number of counts to a value that stabilizes the measured CCDF curve;
3. Record the maximum PAPR level associated with a probability of 0.1%.

3.4.4 TEST RESULTS

LTE BAND 17

CHANNEL BANDWIDTH: 5MHz				CHANNEL BANDWIDTH: 10MHz			
CHANNEL	FREQUENCY (MHz)	PEAK TO AVERAGE RATIO (dB)		CHANNEL	FREQUENCY (MHz)	PEAK TO AVERAGE RATIO (dB)	
		QPSK	16QAM			QPSK	16QAM
23755	706.5	5.61	6.34	23780	709	5.74	6.48
23790	710	5.60	6.52	23790	710	5.68	6.39
23825	713.5	5.45	6.14	23800	711	5.47	6.13

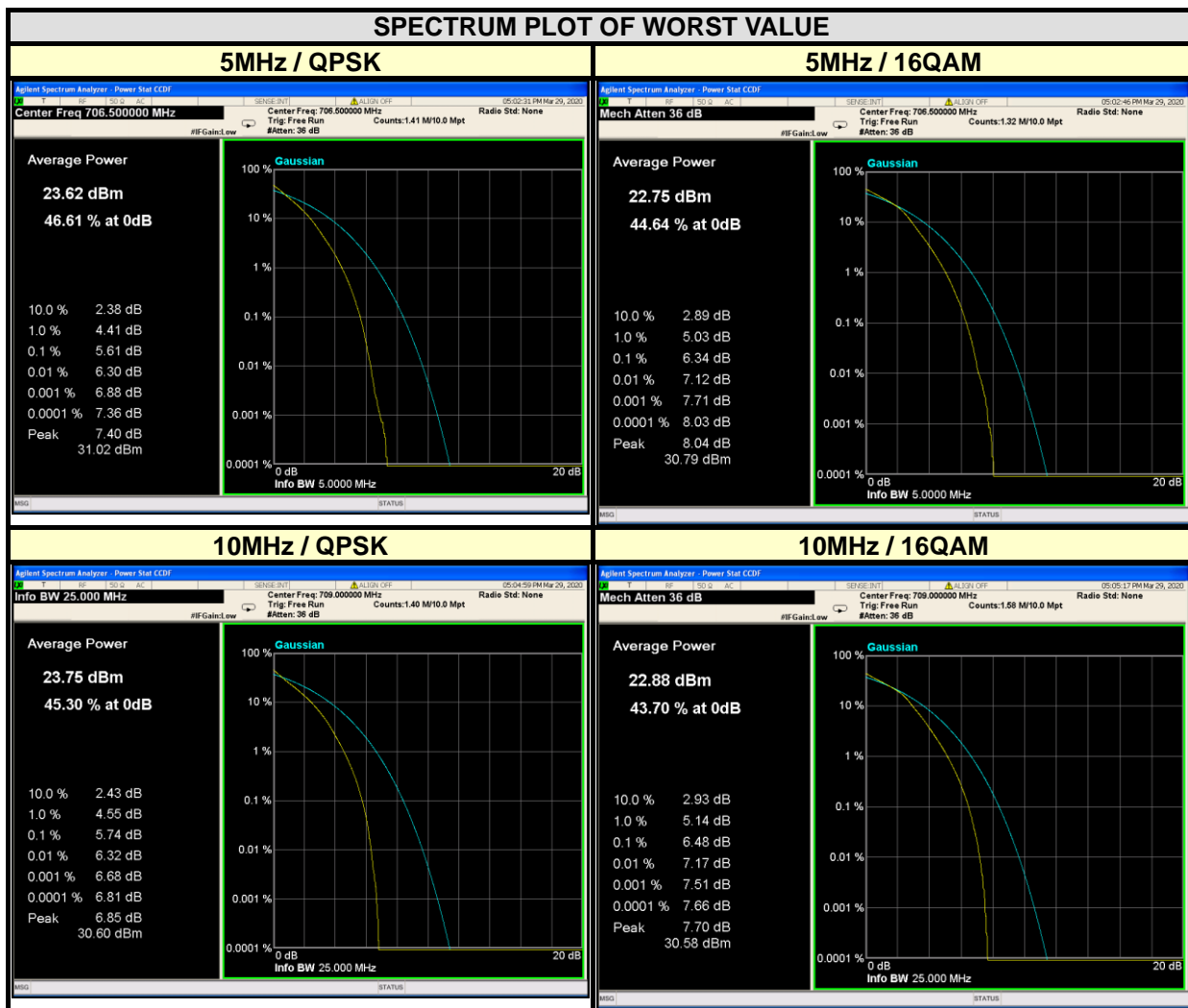

3.5 BAND EDGE MEASUREMENT

3.5.1 LIMITS OF BAND EDGE MEASUREMENT

27.53(c) For operations in the 746-758 MHz band and the 776-788 MHz band, the power of any emission outside the licensee's frequency band(s) of operation shall be attenuated below the transmitter power (P) within the licensed band(s) of operation, measured in watts, in accordance with the following:

(1) On any frequency outside the 746-758 MHz band, the power of any emission shall be attenuated outside the band below the transmitter power (P) by at least $43 + 10 \log (P)$ dB;

(2) On any frequency outside the 776-788 MHz band, the power of any emission shall be attenuated outside the band below the transmitter power (P) by at least $43 + 10 \log (P)$ dB;

(3) On all frequencies between 763-775 MHz and 793-805 MHz, by a factor not less than $76 + 10 \log (P)$ dB in a 6.25 kHz band segment, for base and fixed stations;

(4) On all frequencies between 763-775 MHz and 793-805 MHz, by a factor not less than $65 + 10 \log (P)$ dB in a 6.25 kHz band segment, for mobile and portable stations;

(5) Compliance with the provisions of paragraphs (c)(1) and (c)(2) of this section is based on the use of measurement instrumentation employing a resolution bandwidth of 100 kHz or greater. However, in the 100 kHz bands immediately outside and adjacent to the frequency block, a resolution bandwidth of at least 30 kHz may be employed;

(6) Compliance with the provisions of paragraphs (c)(3) and (c)(4) of this section is based on the use of measurement instrumentation such that the reading taken with any resolution bandwidth setting should be adjusted to indicate spectral energy in a 6.25 kHz segment.

27.53(f) For operations in the 746-758 MHz, 775-788 MHz, and 805-806 MHz bands, emissions in the band 1559-1610 MHz shall be limited to -70 dBW/MHz equivalent isotropically radiated power (EIRP) for wideband signals, and -80 dBW EIRP for discrete emissions of less than 700 Hz bandwidth. For the purpose of equipment authorization, a transmitter shall be tested with an antenna that is representative of the type that will be used with the equipment in normal operation.

27.53(g) For operations in the 600 MHz band and the 698-746 MHz band, the power of any emission outside a licensee's frequency band(s) of operation shall be attenuated below the transmitter power (P) within the licensed band(s) of operation, measured in watts, by at least $43 + 10 \log (P)$ dB. Compliance with this provision is based on the use of measurement instrumentation employing a resolution bandwidth of 100 kilohertz or greater. However, in the 100 kilohertz bands immediately outside and adjacent to a licensee's frequency block, a resolution bandwidth of at least 30 kHz may be employed.

27.53(m)(4) For mobile digital stations, the attenuation factor shall be not less than $40 + 10 \log (P)$ dB on all frequencies between the channel edge and 5 megahertz from the channel edge, $43 + 10 \log (P)$ dB on all frequencies between 5 megahertz and X megahertz from the channel edge, and $55 + 10 \log (P)$ dB on all frequencies more than X megahertz from the channel edge, where X is the greater of 6 megahertz or the actual emission bandwidth as defined in paragraph (m)(6) of this section. In addition, the attenuation factor shall not be less than $43 + 10 \log (P)$ dB on all frequencies between 2490.5 MHz and 2496 MHz and $55 + 10 \log (P)$ dB at or below 2490.5 MHz. Mobile Satellite Service licensees operating on frequencies below 2495 MHz may also submit a documented interference complaint against BRS licensees operating on channel BRS Channel 1 on the same terms and conditions as adjacent channel BRS or EBS licensees.

3.5.2 TEST SETUP

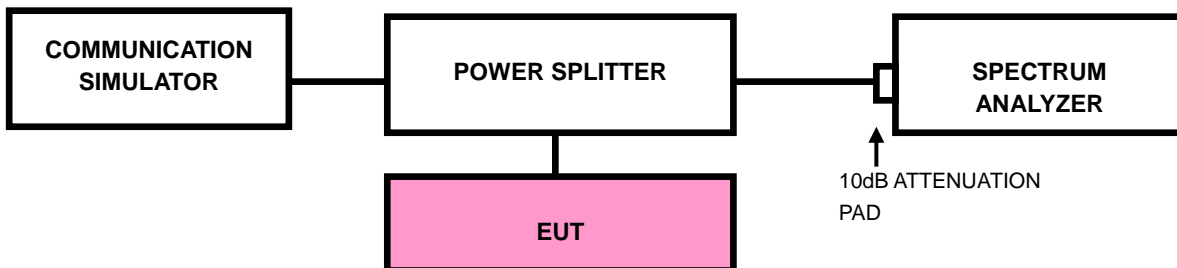

3.5.3 TEST PROCEDURES

- a. The EUT was set up for the maximum peak power with LTE link data modulation. The power was measured with R&S Spectrum Analyzer. All measurements were done at 2 channels (low and high operational frequency range.).
- b. The band edge measurement used the power splitter via EUT RF power connector between simulation base station and spectrum analyzer.
- c. The center frequency of spectrum is the band edge frequency and span is 35MHz. RBW of the spectrum is 100kHz and VBW of the spectrum is 300kHz (Channel bandwidth 5MHz).
- d. The center frequency of spectrum is the band edge frequency and span is 50MHz. RBW of the spectrum is 200kHz and VBW of the spectrum is 1MHz (Channel bandwidth 10MHz).
- e. The center frequency of spectrum is the band edge frequency and span is 60MHz. RBW of the spectrum is 300kHz and VBW of the spectrum is 1MHz (Channel bandwidth 15MHz).
- f. The center frequency of spectrum is the band edge frequency and span is 80MHz. RBW of the spectrum is 500kHz and VBW of the spectrum is 2MHz (Channel bandwidth 20MHz).
- g. Record the max trace plot into the test report.



3.5.4 TEST RESULTS

LTE BAND 17

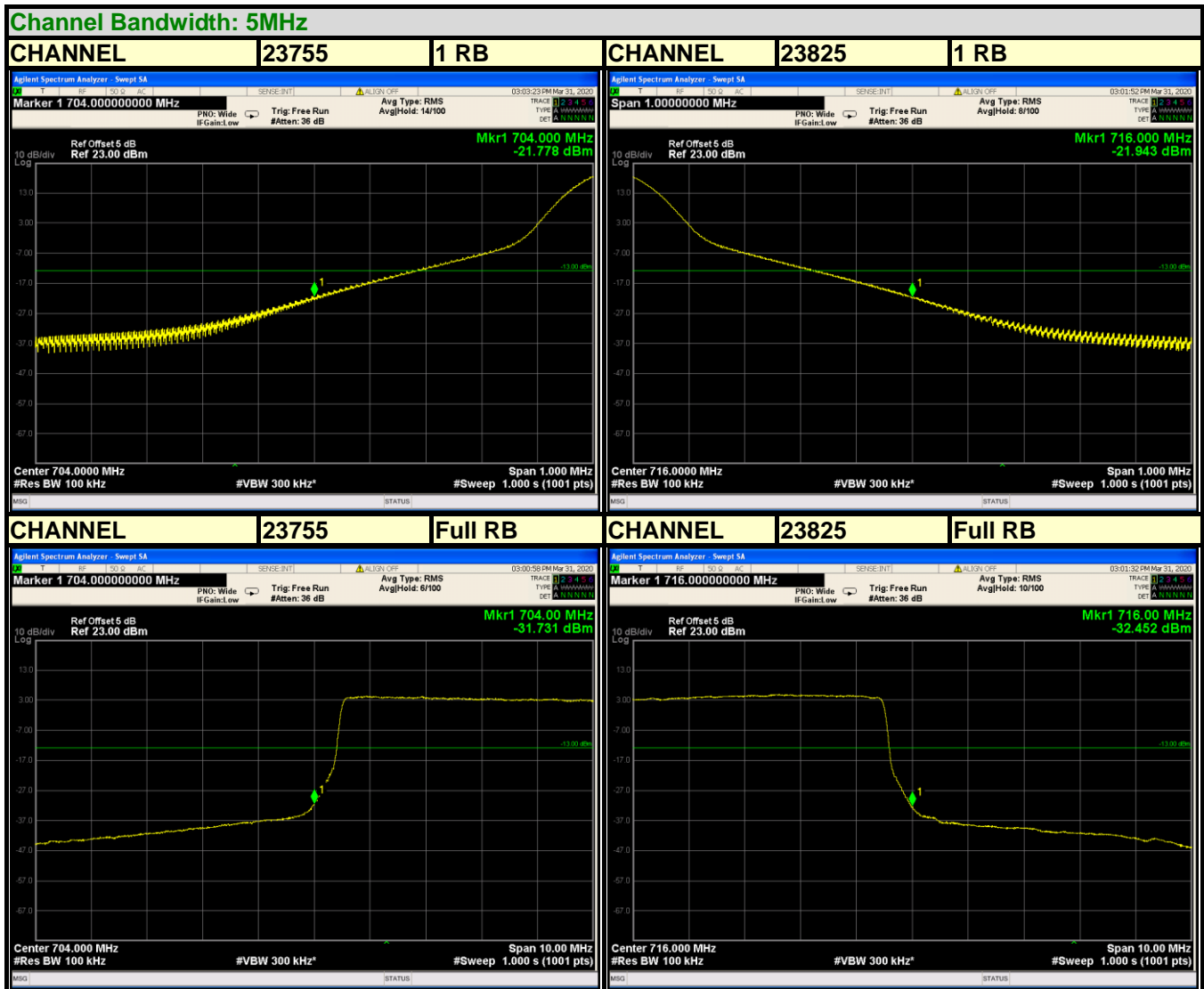



LTE BAND 17

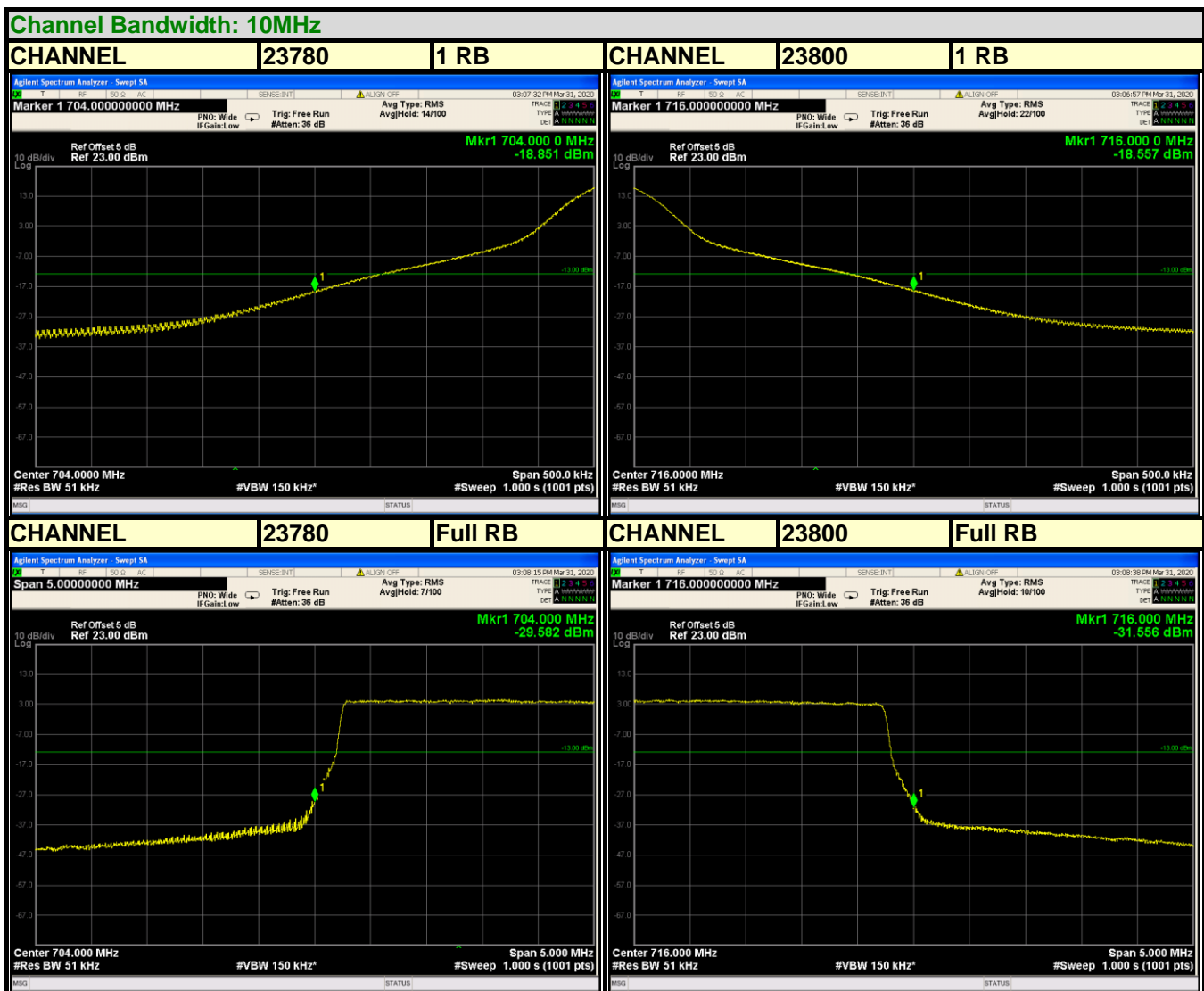

3.6 CONDUCTED SPURIOUS EMISSIONS

3.6.1 LIMITS OF CONDUCTED SPURIOUS EMISSIONS MEASUREMENT

27.53(c) For operations in the 746-758 MHz band and the 776-788 MHz band, the power of any emission outside the licensee's frequency band(s) of operation shall be attenuated below the transmitter power (P) within the licensed band(s) of operation, measured in watts, in accordance with the following:

(1) On any frequency outside the 746-758 MHz band, the power of any emission shall be attenuated outside the band below the transmitter power (P) by at least $43 + 10 \log (P)$ dB;

(2) On any frequency outside the 776-788 MHz band, the power of any emission shall be attenuated outside the band below the transmitter power (P) by at least $43 + 10 \log (P)$ dB;

(3) On all frequencies between 763-775 MHz and 793-805 MHz, by a factor not less than $76 + 10 \log (P)$ dB in a 6.25 kHz band segment, for base and fixed stations;

(4) On all frequencies between 763-775 MHz and 793-805 MHz, by a factor not less than $65 + 10 \log (P)$ dB in a 6.25 kHz band segment, for mobile and portable stations;

(5) Compliance with the provisions of paragraphs (c)(1) and (c)(2) of this section is based on the use of measurement instrumentation employing a resolution bandwidth of 100 kHz or greater. However, in the 100 kHz bands immediately outside and adjacent to the frequency block, a resolution bandwidth of at least 30 kHz may be employed;

(6) Compliance with the provisions of paragraphs (c)(3) and (c)(4) of this section is based on the use of measurement instrumentation such that the reading taken with any resolution bandwidth setting should be adjusted to indicate spectral energy in a 6.25 kHz segment.

27.53(f) For operations in the 746-758 MHz, 775-788 MHz, and 805-806 MHz bands, emissions in the band 1559-1610 MHz shall be limited to -70 dBW/MHz equivalent isotropically radiated power (EIRP) for wideband signals, and -80 dBW EIRP for discrete emissions of less than 700 Hz bandwidth. For the purpose of equipment authorization, a transmitter shall be tested with an antenna that is representative of the type that will be used with the equipment in normal operation.

27.53(g) For operations in the 600 MHz band and the 698-746 MHz band, the power of any emission outside a licensee's frequency band(s) of operation shall be attenuated below the transmitter power (P) within the licensed band(s) of operation, measured in watts, by at least $43 + 10 \log (P)$ dB. Compliance with this provision is based on the use of measurement instrumentation employing a resolution bandwidth of 100 kilohertz or greater. However, in the 100 kilohertz bands immediately outside and adjacent to a licensee's frequency block, a resolution bandwidth of at least 30 kHz may be employed.

27.53(m)(4) For mobile digital stations, the attenuation factor shall be not less than $40 + 10 \log (P)$ dB on all frequencies between the channel edge and 5 megahertz from the channel edge, $43 + 10 \log (P)$ dB on all frequencies between 5 megahertz and X megahertz from the channel edge, and $55 + 10 \log (P)$ dB on all frequencies more than X megahertz from the channel edge, where X is the greater of 6 megahertz or the actual emission bandwidth as defined in paragraph (m)(6) of this section. In addition, the attenuation factor shall not be less than $43 + 10 \log (P)$ dB on all frequencies between 2490.5 MHz and 2496 MHz and $55 + 10 \log (P)$ dB at or below 2490.5 MHz. Mobile Satellite Service licensees operating on frequencies below 2495 MHz may also submit a documented interference complaint against BRS licensees operating on channel BRS Channel 1 on the same terms and conditions as adjacent channel BRS or EBS licensees.

3.6.2 TEST PROCEDURE

- a. The EUT makes a phone call to the communication simulator. All measurements were done at low, middle and high operational frequency range.
- b. Measuring frequency range is from 30MHz~25.7GHz for LTE Band 7 & LTE Band 41. 10dB attenuation pad is connected with spectrum. RBW=1MHz and VBW=3MHz are used for conducted emission measurement.

3.6.3 TEST SETUP

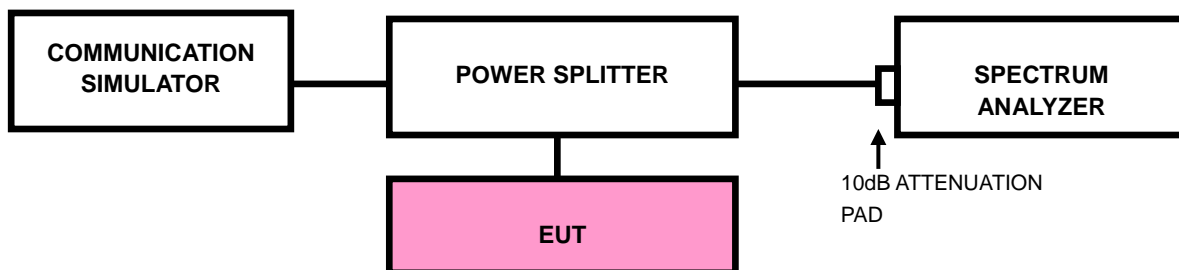



BUREAU VERITAS

Test Report No.: RF200327S003-4

3.6.4 TEST RESULTS

LTE BAND 17







3.7 RADIATED EMISSION MEASUREMENT

3.7.1 LIMITS OF RADIATED EMISSION MEASUREMENT

27.53(c) For operations in the 746-758 MHz band and the 776-788 MHz band, the power of any emission outside the licensee's frequency band(s) of operation shall be attenuated below the transmitter power (P) within the licensed band(s) of operation, measured in watts, in accordance with the following:

(1) On any frequency outside the 746-758 MHz band, the power of any emission shall be attenuated outside the band below the transmitter power (P) by at least $43 + 10 \log (P)$ dB;

(2) On any frequency outside the 776-788 MHz band, the power of any emission shall be attenuated outside the band below the transmitter power (P) by at least $43 + 10 \log (P)$ dB;

(3) On all frequencies between 763-775 MHz and 793-805 MHz, by a factor not less than $76 + 10 \log (P)$ dB in a 6.25 kHz band segment, for base and fixed stations;

(4) On all frequencies between 763-775 MHz and 793-805 MHz, by a factor not less than $65 + 10 \log (P)$ dB in a 6.25 kHz band segment, for mobile and portable stations;

(5) Compliance with the provisions of paragraphs (c)(1) and (c)(2) of this section is based on the use of measurement instrumentation employing a resolution bandwidth of 100 kHz or greater. However, in the 100 kHz bands immediately outside and adjacent to the frequency block, a resolution bandwidth of at least 30 kHz may be employed;

(6) Compliance with the provisions of paragraphs (c)(3) and (c)(4) of this section is based on the use of measurement instrumentation such that the reading taken with any resolution bandwidth setting should be adjusted to indicate spectral energy in a 6.25 kHz segment.

27.53(f) For operations in the 746-758 MHz, 775-788 MHz, and 805-806 MHz bands, emissions in the band 1559-1610 MHz shall be limited to -70 dBW/MHz equivalent isotropically radiated power (EIRP) for wideband signals, and -80 dBW EIRP for discrete emissions of less than 700 Hz bandwidth. For the purpose of equipment authorization, a transmitter shall be tested with an antenna that is representative of the type that will be used with the equipment in normal operation.



27.53(g) For operations in the 600 MHz band and the 698-746 MHz band, the power of any emission outside a licensee's frequency band(s) of operation shall be attenuated below the transmitter power (P) within the licensed band(s) of operation, measured in watts, by at least $43 + 10 \log (P)$ dB. Compliance with this provision is based on the use of measurement instrumentation employing a resolution bandwidth of 100 kilohertz or greater. However, in the 100 kilohertz bands immediately outside and adjacent to a licensee's frequency block, a resolution bandwidth of at least 30 kHz may be employed.

27.53(m)(4) For mobile digital stations, the attenuation factor shall be not less than $40 + 10 \log (P)$ dB on all frequencies between the channel edge and 5 megahertz from the channel edge, $43 + 10 \log (P)$ dB on all frequencies between 5 megahertz and X megahertz from the channel edge, and $55 + 10 \log (P)$ dB on all frequencies more than X megahertz from the channel edge, where X is the greater of 6 megahertz or the actual emission bandwidth as defined in paragraph (m)(6) of this section. In addition, the attenuation factor shall not be less than $43 + 10 \log (P)$ dB on all frequencies between 2490.5 MHz and 2496 MHz and $55 + 10 \log (P)$ dB at or below 2490.5 MHz. Mobile Satellite Service licensees operating on frequencies below 2495 MHz may also submit a documented interference complaint against BRS licensees operating on channel BRS Channel 1 on the same terms and conditions as adjacent channel BRS or EBS licensees.

3.7.2 TEST PROCEDURES

- a. Substitution method is used for E.I.R.P measurement. In the semi-anechoic chamber, EUT placed on the 0.8m height of Turn Table, rotated the table around 360 degrees to search the maximum radiation power and receiver antenna shall be rotated vertical and horizontal polarization and moved height from 1m to 4m to find the maximum polar radiated power. The "Read Value" is the spectrum reading the maximum power value.
- b. The substitution horn antenna is substituted for EUT at the same position and signals generator export the CW signal to the substitution antenna via a TX cable. Rotated the Turn Table and moved receiving antenna to find the maximum radiation power. Adjust output power level of S.G to get a Value of spectrum reading equal to "Read Value" of step a. Record the power level of S.G.
- c. $EIRP = \text{Output power level of S.G} - \text{TX cable loss} + \text{Antenna gain of substitution horn.}$
- d. E.R.P power can be calculated form E.I.R.P power by subtracting the gain of dipole, $E.R.P \text{ power} = E.I.P.R \text{ power} - 2.15\text{dBi.}$

NOTE: The resolution bandwidth of spectrum analyzer is 1 MHz and the video bandwidth is 3 MHz.



Test Report No.: RF200327S003-4

3.7.3 DEVIATION FROM TEST STANDARD

No deviation

3.7.4 TEST SETUP

< Frequency Range 30MHz~1GHz >

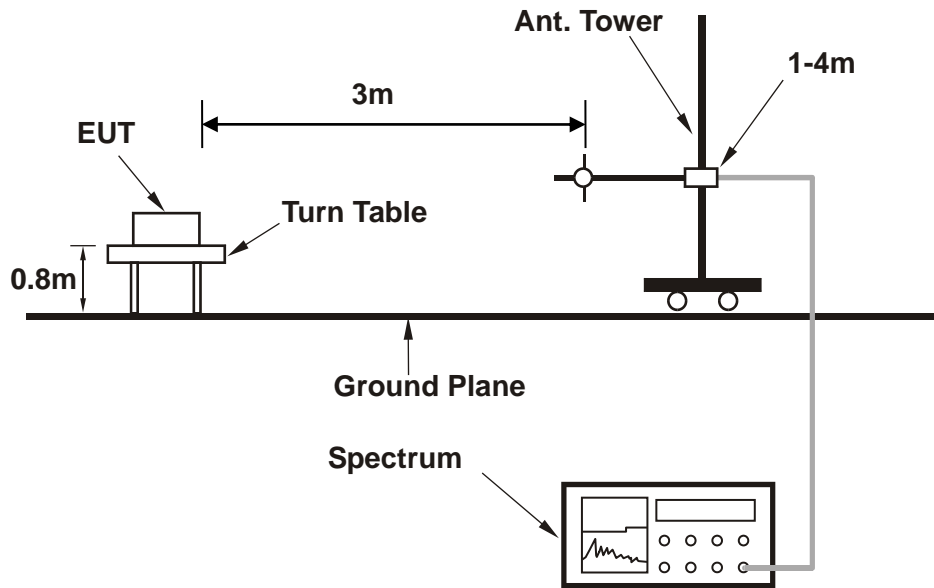

<Frequency Range above 1GHz>

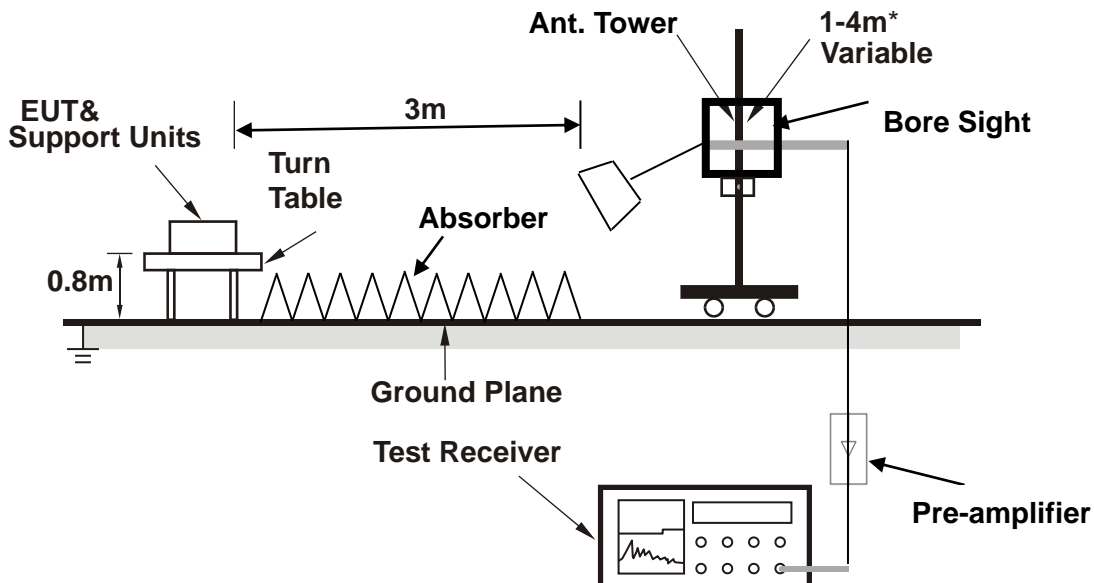

Note: Above 1G is a directional antenna depends on the EUT height and the antenna 3dB beamwidth both, refer to section 7.3 of CISPR 16-2-3.

For the actual test configuration, please refer to the attached file (Test Setup Photo).

3.7.5 TEST RESULTS

BELOW 1GHz WORST-CASE DATA

30 MHz – 1GHz data:

LTE Band 17

MODE	TX channel 23790	FREQUENCY RANGE	Below 1000MHz
ENVIRONMENTAL CONDITIONS	24deg. C, 60%RH	INPUT POWER	DC 5V from adapter
TESTED BY	Aaron Liang		

NO.	FREQ. (MHz)	Antenna Polarization (H/V)	EMISSION LEVEL (dBm/m)	DETECTOR (PK/AV)	LIMIT (dBm/m)	MARGIN (dB)	RAW VALUE (dBm)	CORRECTION FACTOR (dB/m)
1	31.9546	H	-52.04	peak	-13	-39.04	-64.38	-12.34
2	138.8735	H	-72.56	peak	-13	-59.56	-72.6	-0.04
3	194.4534	H	-68.82	peak	-13	-55.82	-69.07	-0.25
4	239.9873	H	-69.46	peak	-13	-56.46	-70.25	-0.79
5	742.2587	H	-62.39	peak	-13	-49.39	-71.07	-8.68
6	945.4399	H	-59.18	peak	-13	-46.18	-71.53	-12.35

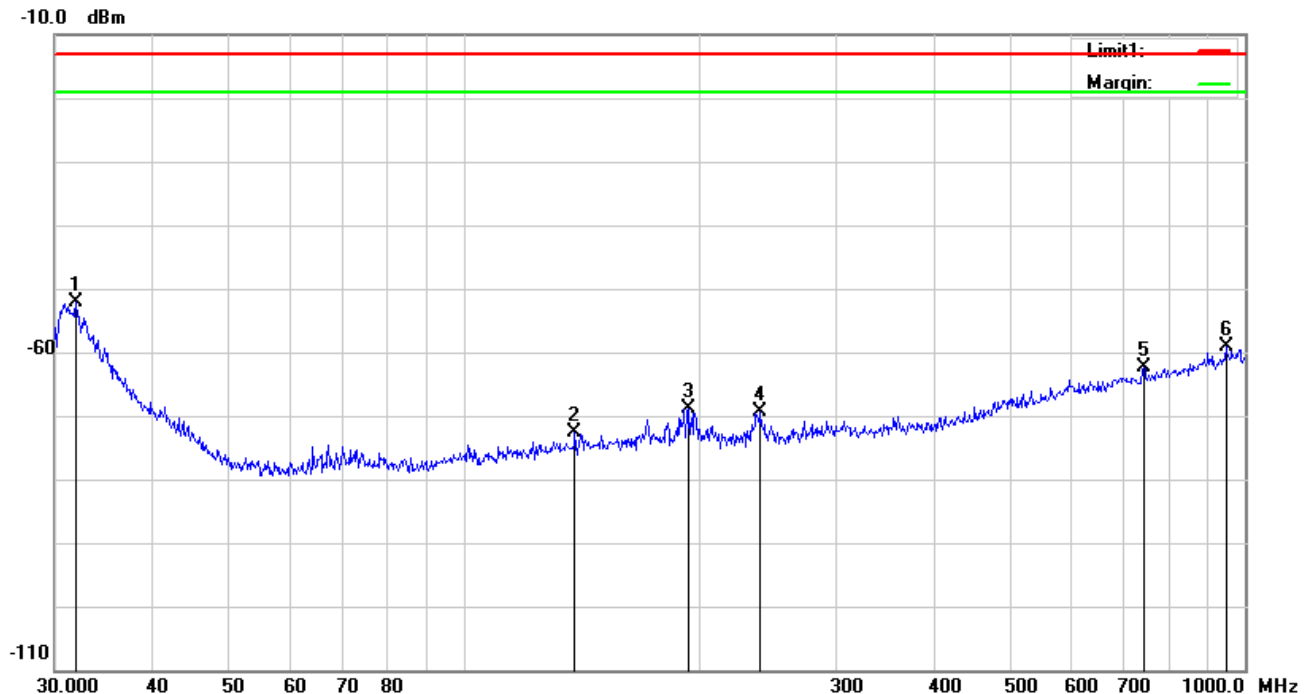

MODE	TX channel 23790	FREQUENCY RANGE	Below 1000MHz
ENVIRONMENTAL CONDITIONS	24deg. C, 60%RH	INPUT POWER	DC 5V from adapter
TESTED BY	Aaron Liang		

NO.	FREQ. (MHz)	Antenna Polarization (H/V)	EMISSION LEVEL (dBm/m)	DETECTOR (PK/AV)	LIMIT (dBm/m)	MARGIN (dB)	RAW VALUE (dBm)	CORRECTION FACTOR (dB/m)
1	32.2925	V	-60.66	peak	-13	-47.66	-65.8	-5.14
2	43.3534	V	-63.56	peak	-13	-50.56	-61.62	1.94
3	129.9226	V	-67.42	peak	-13	-54.42	-72.56	-5.14
4	182.5592	V	-67.64	peak	-13	-54.64	-71.53	-3.89
5	426.521	V	-65.95	peak	-13	-52.95	-72.66	-6.71
6	955.4381	V	-56.23	peak	-13	-43.23	-70.94	-14.71

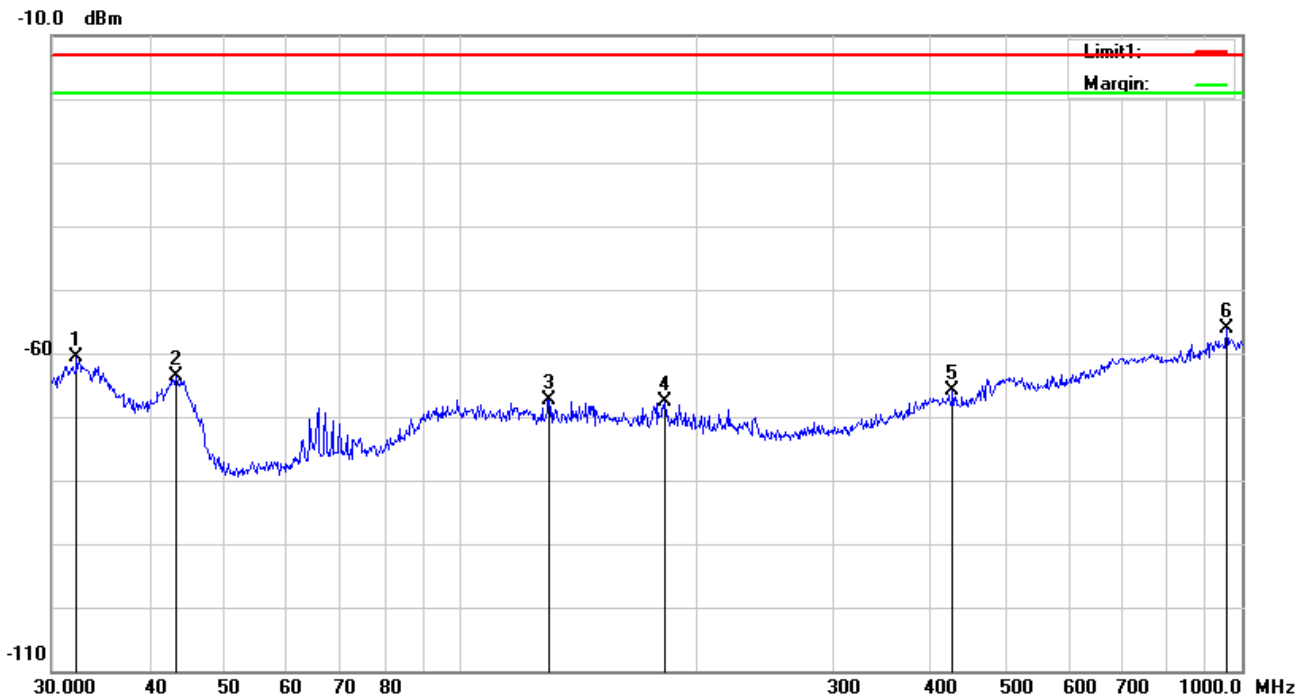



Test Report No.: RF200327S003-4

ABOVE 1GHz

Note: For higher frequency, the emission is too low to be detected.

LTE BAND 17

CHANNEL BANDWIDTH: 5MHz / QPSK

Low channel

NO.	FREQ. (MHz)	Antenna Polarization (H/V)	EMISSION LEVEL (dBm/m)	DETECTOR (PK/AV)	LIMIT (dBm/m)	MARGIN (dB)	RAW VALUE (dBm)	CORRECTIO N FACTOR (dB/m)
1	1413	V	-34.85	PK	-13	-21.85	-45.03	10.18
2	1413	H	-41.28	PK	-13	-28.28	-51.46	10.18
3	2826	V	-35.82	PK	-13	-22.82	-52.54	16.72
4	2826	H	-32.38	PK	-13	-19.38	-49.1	16.72

Middle channel

NO.	FREQ. (MHz)	Antenna Polarization (H/V)	EMISSION LEVEL (dBm/m)	DETECTOR (PK/AV)	LIMIT (dBm/m)	MARGIN (dB)	RAW VALUE (dBm)	CORRECTIO N FACTOR (dB/m)
1	1420	V	-34.58	PK	-13	-21.58	-44.76	10.18
2	1420	H	-43.67	PK	-13	-30.67	-53.85	10.18
3	2840	V	-36.37	PK	-13	-23.37	-53.09	16.72
4	2840	H	-33.51	PK	-13	-20.51	-50.23	16.72

High channel

NO.	FREQ. (MHz)	Antenna Polarization (H/V)	EMISSION LEVEL (dBm/m)	DETECTOR (PK/AV)	LIMIT (dBm/m)	MARGIN (dB)	RAW VALUE (dBm)	CORRECTIO N FACTOR (dB/m)
1	1427	V	-34.87	PK	-13	-21.87	-45.05	10.18
2	1427	H	-37.49	PK	-13	-24.49	-47.67	10.18
3	2854	V	-44.04	PK	-13	-31.04	-60.76	16.72
4	2854	H	-39.87	PK	-13	-26.87	-56.59	16.72

Note:

1, The testing has been conformed to $10 \times 713.5\text{MHz} = 7,135\text{MHz}$

2, All other emissions more than 30 dB below the limit

3, X-Axis, Y-Axis and Z-Axis were investigated. The results above show only the worst case.



Test Report No.: RF200327S003-4

CHANNEL BANDWIDTH: 10MHz / QPSK

Low channel

NO.	FREQ. (MHz)	Antenna Polarization (H/V)	EMISSION LEVEL (dBm/m)	DETECTOR (PK/AV)	LIMIT (dBm/m)	MARGIN (dB)	RAW VALUE (dBm)	CORRECTION FACTOR (dB/m)
1	1418	V	-35.38	PK	-13	-22.38	-45.56	10.18
2	2836	H	-30.91	PK	-13	-17.91	-47.63	16.72
3	2836	V	-34.17	PK	-13	-21.17	-50.89	16.72
4	3545	H	-25.77	PK	-13	-12.77	-43.73	17.96

Middle channel

NO.	FREQ. (MHz)	Antenna Polarization (H/V)	EMISSION LEVEL (dBm/m)	DETECTOR (PK/AV)	LIMIT (dBm/m)	MARGIN (dB)	RAW VALUE (dBm)	CORRECTION FACTOR (dB/m)
1	1420	V	-33.07	PK	-13	-20.07	-43.25	10.18
2	2840	H	-31.64	PK	-13	-18.64	-48.36	16.72
3	2840	V	-35.58	PK	-13	-22.58	-52.3	16.72
4	3550	H	-30.16	PK	-13	-17.16	-48.12	17.96

High channel

NO.	FREQ. (MHz)	Antenna Polarization (H/V)	EMISSION LEVEL (dBm/m)	DETECTOR (PK/AV)	LIMIT (dBm/m)	MARGIN (dB)	RAW VALUE (dBm)	CORRECTIO N FACTOR (dB/m)
1	1422	V	-29.4	PK	-13	-16.4	-39.58	10.18
2	2844	H	-32.88	PK	-13	-19.88	-49.6	16.72
3	2844	V	-37.4	PK	-13	-24.4	-54.12	16.72
4	3555	H	-30.27	PK	-13	-17.27	-48.23	17.96

Note:

1, The testing has been conformed to $10 \times 711 \text{MHz} = 7,110 \text{MHz}$

2, All other emissions more than 30 dB below the limit

3, X-Axis, Y-Axis and Z-Axis were investigated. The results above show only the worst case.



Test Report No.: RF200327S003-4

5 APPENDIX A – MODIFICATIONS RECORDERS FOR ENGINEERING CHANGES TO THE EUT BY THE LAB

No any modifications are made to the EUT by the lab during the test.

---END---