

FCC SAR Test Report

APPLICANT : PAX Technology Limited
EQUIPMENT : Smart Mobile Payment Terminal
BRAND NAME : PAX
MODEL NAME : A920
FCC ID : V5PA920-2019
STANDARD : FCC 47 CFR Part 2 (2.1093)
ANSI/IEEE C95.1-1992
IEEE 1528-2013

The product was received on Dec. 18, 2018 and testing was started from Jan. 14, 2019 and completed on Jan. 19, 2019. We, Sporton International (Shenzhen) Inc., would like to declare that the tested sample has been evaluated in accordance with the test procedures and has been in compliance with the applicable technical standards.

The test results in this variant report apply exclusively to the tested model / sample. Without written approval of Sporton International (Shenzhen) Inc., the test report shall not be reproduced except in full.



Approved by: Mark Qu / Manager



Sporton International (Shenzhen) Inc.
1/F, 2/F, Bldg 5, Shiling Industrial Zone, Xinwei Village, Xili, Nanshan Shenzhen City
Guangdong Province 518055 China



Table of Contents

1. Statement of Compliance 4

2. Administration Data 5

3. Guidance Applied..... 5

4. Equipment Under Test (EUT) Information..... 6

 4.1 General Information 6

 4.2 General LTE SAR Test and Reporting Considerations 7

5. RF Exposure Limits..... 9

 5.1 Uncontrolled Environment..... 9

 5.2 Controlled Environment..... 9

6. Specific Absorption Rate (SAR).....10

 6.1 Introduction10

 6.2 SAR Definition.....10

7. System Description and Setup11

 7.1 E-Field Probe12

 7.2 Data Acquisition Electronics (DAE)12

 7.3 Phantom.....13

 7.4 Device Holder.....14

8. Measurement Procedures15

 8.1 Spatial Peak SAR Evaluation.....15

 8.2 Power Reference Measurement.....16

 8.3 Area Scan16

 8.4 Zoom Scan.....17

 8.5 Volume Scan Procedures.....17

 8.6 Power Drift Monitoring.....17

9. Test Equipment List18

10. System Verification19

 10.1 Tissue Simulating Liquids.....19

 10.2 Tissue Verification20

 10.3 System Performance Check Results.....21

11. RF Exposure Positions22

 11.1 SAR Testing for Tablet22

12. Conducted RF Output Power (Unit: dBm).....23

13. Antenna Location46

14. SAR Test Results47

 14.1 Body SAR49

 14.2 Repeated SAR Measurement52

15. Simultaneous Transmission Analysis.....53

 15.1 Body Exposure Conditions54

16. Uncertainty Assessment55

17. References.....56

Appendix A. Plots of System Performance Check

Appendix B. Plots of High SAR Measurement

Appendix C. DASy Calibration Certificate

Appendix D. Test Setup Photos



History of this test report

Report No.	Version	Description	Issued Date
FA8D1822	01	Initial issue of report	Mar. 14, 2019

1. Statement of Compliance

The maximum results of Specific Absorption Rate (SAR) found during testing for **PAX Technology Limited, Smart Mobile Payment Terminal, A920**, are as follows.

Highest 1g SAR Summary				
Equipment Class	Frequency Band	Highest SAR Summary		Highest Simultaneous Transmission 1g SAR (W/kg)
		Body (Separation 0mm)		
		1g SAR (W/kg)		
Licensed	WCDMA	Band V	0.75	1.44
		Band IV	0.23	
		Band II	0.19	
	LTE	Band 5	0.67	
		Band 12/17	1.24	
		Band 13	1.15	
		Band 4	0.25	
		Band 2	0.19	
		Band 7	0.27	
DTS	WLAN	2.4GHz WLAN	0.20	1.44
NII		5GHz WLAN	0.16	1.40
DSS	Bluetooth	Bluetooth	<0.10	1.27
Date of Testing:		2019/1/14 ~ 2019/1/19		
Remark : This device supports both LTE B12 and B17. Since the supported frequency span for LTE B17 falls completely within the supports frequency span for LTE B12, both LTE bands have the same target power, and both LTE bands share the same transmission path; therefore, SAR was only assessed for LTE B12.				

This device is in compliance with Specific Absorption Rate (SAR) for general population/uncontrolled exposure limits (1.6 W/kg for Partial-Body 1g SAR specified in FCC 47 CFR part 2 (2.1093) and ANSI/IEEE C95.1-1992, and had been tested in accordance with the measurement methods and procedures specified in IEEE 1528-2013 and FCC KDB publications.

2. Administration Data

Testing Laboratory	
Test Site	Sporton International (Shenzhen) Inc.
Test Site Location	1/F, 2/F, Bldg 5, Shiling Industrial Zone, Xinwei Village, Xili, Nanshan, Shenzhen City, Guangdong Province 518055, China TEL: +86-755-8637-9589 FAX: +86-755-8637-9595

Applicant	
Company Name	PAX Technology Limited
Address	Room 2416, 24/F., Sun Hung Kai Centre, 30 Harbour Road, Wanchai, Hong Kong

Manufacturer	
Company Name	PAX Computer Technology (Shenzhen) Co., Ltd.
Address	4/F, No.3 Building, Software Park, Second Central Science-Tech Road, High-Tech industrial Park, Shenzhen, Guangdong, P.R.C.

3. Guidance Applied

The Specific Absorption Rate (SAR) testing specification, method, and procedure for this device is in accordance with the following standards:

- FCC 47 CFR Part 2 (2.1093)
- ANSI/IEEE C95.1-1992
- IEEE 1528-2013
- FCC KDB 865664 D01 SAR Measurement 100 MHz to 6 GHz v01r04
- FCC KDB 865664 D02 SAR Reporting v01r02
- FCC KDB 447498 D01 General RF Exposure Guidance v06
- FCC KDB 248227 D01 802.11 Wi-Fi SAR v02r02
- FCC KDB 941225 D01 3G SAR Procedures v03r01
- FCC KDB 941225 D05 SAR for LTE Devices v02r05

4. Equipment Under Test (EUT) Information

4.1 General Information

Product Feature & Specification	
Equipment Name	Smart Mobile Payment Terminal
Brand Name	PAX
Model Name	A920
FCC ID	V5PA920-2019
IMEI Code	352110098999940
Wireless Technology and Frequency Range	WCDMA Band II: 1852.4 MHz ~ 1907.6 MHz WCDMA Band IV: 1712.4 MHz ~ 1752.6 MHz WCDMA Band V: 826.4 MHz ~ 846.6 MHz LTE Band 2: 1850.7 MHz ~ 1909.3 MHz LTE Band 4: 1710.7 MHz ~ 1754.3 MHz LTE Band 5: 824.7 MHz ~ 848.3 MHz LTE Band 7: 2502.5 MHz ~ 2567.5 MHz LTE Band 12: 699.7 MHz ~ 715.3 MHz LTE Band 13: 779.5 MHz ~ 784.5 MHz LTE Band 17: 706.5 MHz ~ 713.5 MHz WLAN 2.4GHz Band: 2412 MHz ~ 2462 MHz WLAN 5.2GHz Band: 5180 MHz ~ 5240 MHz WLAN 5.8GHz Band: 5745 MHz ~ 5825 MHz Bluetooth: 2402 MHz ~ 2480 MHz NFC : 13.56 MHz
Mode	RMC 12.2Kbps HSDPA HSUPA DC-HSDPA HSPA+ (16QAM uplink is not supported) LTE: QPSK, 16QAM WLAN 2.4GHz : 802.11b/g/n HT20/HT40 WLAN 5GHz : 802.11a/n HT20/HT40 Bluetooth BR/EDR/LE NFC:ASK
HW Version	N/A
SW Version	N/A
EUT Stage	Production Unit
Remark: 1. This device does not support voice function. 2. There are two type batteries, with the same capacity, only different manufacturer, so we only chose battery 1 to perform SAR testing.	



4.2 General LTE SAR Test and Reporting Considerations

Summarized necessary items addressed in KDB 941225 D05 v02r05																																																															
FCC ID	V5PA920-2019																																																														
Equipment Name	Smart Mobile Payment Terminal																																																														
Operating Frequency Range of each LTE transmission band	LTE Band 2: 1850.7 MHz ~ 1909.3 MHz LTE Band 4: 1710.7 MHz ~ 1754.3 MHz LTE Band 5: 824.7 MHz ~ 848.3 MHz LTE Band 7: 2502.5 MHz ~ 2567.5 MHz LTE Band 12: 699.7 MHz ~ 715.3 MHz LTE Band 13: 779.5 MHz ~ 784.5 MHz LTE Band 17: 706.5 MHz ~ 713.5 MHz																																																														
Channel Bandwidth	LTE Band 2: 1.4MHz, 3MHz, 5MHz, 10MHz, 15MHz, 20MHz LTE Band 4: 1.4MHz, 3MHz, 5MHz, 10MHz, 15MHz, 20MHz LTE Band 5: 1.4MHz, 3MHz, 5MHz, 10MHz LTE Band 7: 5MHz, 10MHz, 15MHz, 20MHz LTE Band 12: 1.4MHz, 3MHz, 5MHz, 10MHz LTE Band 13: 5MHz, 10MHz LTE Band 17: 5MHz, 10MHz																																																														
Uplink Modulations Used	QPSK / 16QAM																																																														
LTE Voice / Data requirements	Data only																																																														
LTE Release Version	R10, Cat4																																																														
CA Support	Not Supported																																																														
LTE MPR permanently built-in by design	<table border="1"> <caption>Table 6.2.3-1: Maximum Power Reduction (MPR) for Power Class 1, 2 and 3</caption> <thead> <tr> <th rowspan="2">Modulation</th> <th colspan="6">Channel bandwidth / Transmission bandwidth (N_{RB})</th> <th rowspan="2">MPR (dB)</th> </tr> <tr> <th>1.4 MHz</th> <th>3.0 MHz</th> <th>5 MHz</th> <th>10 MHz</th> <th>15 MHz</th> <th>20 MHz</th> </tr> </thead> <tbody> <tr> <td>QPSK</td> <td>> 5</td> <td>> 4</td> <td>> 8</td> <td>> 12</td> <td>> 16</td> <td>> 18</td> <td>≤ 1</td> </tr> <tr> <td>16 QAM</td> <td>≤ 5</td> <td>≤ 4</td> <td>≤ 8</td> <td>≤ 12</td> <td>≤ 16</td> <td>≤ 18</td> <td>≤ 1</td> </tr> <tr> <td>16 QAM</td> <td>> 5</td> <td>> 4</td> <td>> 8</td> <td>> 12</td> <td>> 16</td> <td>> 18</td> <td>≤ 2</td> </tr> <tr> <td>64 QAM</td> <td>≤ 5</td> <td>≤ 4</td> <td>≤ 8</td> <td>≤ 12</td> <td>≤ 16</td> <td>≤ 18</td> <td>≤ 2</td> </tr> <tr> <td>64 QAM</td> <td>> 5</td> <td>> 4</td> <td>> 8</td> <td>> 12</td> <td>> 16</td> <td>> 18</td> <td>≤ 3</td> </tr> <tr> <td>256 QAM</td> <td colspan="6" style="text-align: center;">≥ 1</td> <td>≤ 5</td> </tr> </tbody> </table>	Modulation	Channel bandwidth / Transmission bandwidth (N _{RB})						MPR (dB)	1.4 MHz	3.0 MHz	5 MHz	10 MHz	15 MHz	20 MHz	QPSK	> 5	> 4	> 8	> 12	> 16	> 18	≤ 1	16 QAM	≤ 5	≤ 4	≤ 8	≤ 12	≤ 16	≤ 18	≤ 1	16 QAM	> 5	> 4	> 8	> 12	> 16	> 18	≤ 2	64 QAM	≤ 5	≤ 4	≤ 8	≤ 12	≤ 16	≤ 18	≤ 2	64 QAM	> 5	> 4	> 8	> 12	> 16	> 18	≤ 3	256 QAM	≥ 1						≤ 5
Modulation	Channel bandwidth / Transmission bandwidth (N _{RB})						MPR (dB)																																																								
	1.4 MHz	3.0 MHz	5 MHz	10 MHz	15 MHz	20 MHz																																																									
QPSK	> 5	> 4	> 8	> 12	> 16	> 18	≤ 1																																																								
16 QAM	≤ 5	≤ 4	≤ 8	≤ 12	≤ 16	≤ 18	≤ 1																																																								
16 QAM	> 5	> 4	> 8	> 12	> 16	> 18	≤ 2																																																								
64 QAM	≤ 5	≤ 4	≤ 8	≤ 12	≤ 16	≤ 18	≤ 2																																																								
64 QAM	> 5	> 4	> 8	> 12	> 16	> 18	≤ 3																																																								
256 QAM	≥ 1						≤ 5																																																								
LTE A-MPR	In the base station simulator configuration, Network Setting value is set to NS_01 to disable A-MPR during SAR testing and the LTE SAR tests was transmitting on all TTI frames (Maximum TTI)																																																														
Spectrum plots for RB configuration	A properly configured base station simulator was used for the SAR and power measurement; therefore, spectrum plots for each RB allocation and offset configuration are not included in the SAR report.																																																														



Transmission (H, M, L) channel numbers and frequencies in each LTE band												
LTE Band 2												
	Bandwidth 1.4 MHz		Bandwidth 3 MHz		Bandwidth 5 MHz		Bandwidth 10 MHz		Bandwidth 15 MHz		Bandwidth 20 MHz	
	Ch. #	Freq. (MHz)	Ch. #	Freq. (MHz)	Ch. #	Freq. (MHz)	Ch. #	Freq. (MHz)	Ch. #	Freq. (MHz)	Ch. #	Freq. (MHz)
L	18607	1850.7	18615	1851.5	18625	1852.5	18650	1855	18675	1857.5	18700	1860
M	18900	1880	18900	1880	18900	1880	18900	1880	18900	1880	18900	1880
H	19193	1909.3	19185	1908.5	19175	1907.5	19150	1905	19125	1902.5	19100	1900
LTE Band 4												
	Bandwidth 1.4 MHz		Bandwidth 3 MHz		Bandwidth 5 MHz		Bandwidth 10 MHz		Bandwidth 15 MHz		Bandwidth 20 MHz	
	Ch. #	Freq. (MHz)	Ch. #	Freq. (MHz)	Ch. #	Freq. (MHz)	Ch. #	Freq. (MHz)	Ch. #	Freq. (MHz)	Ch. #	Freq. (MHz)
L	19957	1710.7	19965	1711.5	19975	1712.5	20000	1715	20025	1717.5	20050	1720
M	20175	1732.5	20175	1732.5	20175	1732.5	20175	1732.5	20175	1732.5	20175	1732.5
H	20393	1754.3	20385	1753.5	20375	1752.5	20350	1750	20325	1747.5	20300	1745
LTE Band 5												
	Bandwidth 1.4 MHz		Bandwidth 3 MHz		Bandwidth 5 MHz		Bandwidth 10 MHz					
	Ch. #	Freq. (MHz)	Ch. #	Freq. (MHz)	Ch. #	Freq. (MHz)	Ch. #	Freq. (MHz)	Ch. #	Freq. (MHz)	Ch. #	Freq. (MHz)
L	20407	824.7	20415	825.5	20425	826.5	20450	829				
M	20525	836.5	20525	836.5	20525	836.5	20525	836.5				
H	20643	848.3	20635	847.5	20625	846.5	20600	844				
LTE Band 7												
	Bandwidth 5 MHz		Bandwidth 10 MHz		Bandwidth 15 MHz		Bandwidth 20 MHz					
	Ch. #	Freq. (MHz)	Ch. #	Freq. (MHz)	Ch. #	Freq. (MHz)	Ch. #	Freq. (MHz)	Ch. #	Freq. (MHz)	Ch. #	Freq. (MHz)
L	20775	2502.5	20800	2505	20825	2507.5	20850	2510				
M	21100	2535	21100	2535	21100	2535	21100	2535				
H	21425	2567.5	21400	2565	21375	2562.5	21350	2560				
LTE Band 12												
	Bandwidth 1.4 MHz		Bandwidth 3 MHz		Bandwidth 5 MHz		Bandwidth 10 MHz					
	Ch. #	Freq. (MHz)	Ch. #	Freq. (MHz)	Ch. #	Freq. (MHz)	Ch. #	Freq. (MHz)	Ch. #	Freq. (MHz)	Ch. #	Freq. (MHz)
L	23017	699.7	23025	700.5	23035	701.5	23060	704				
M	23095	707.5	23095	707.5	23095	707.5	23095	707.5				
H	23173	715.3	23165	714.5	23155	713.5	23130	711				
LTE Band 13												
	Bandwidth 5 MHz				Bandwidth 10 MHz							
	Channel #		Freq.(MHz)		Channel #		Freq.(MHz)		Channel #		Freq.(MHz)	
L	23205		779.5		23230		782					
M	23230		782									
H	23255		784.5									
LTE Band 17												
	Bandwidth 5 MHz				Bandwidth 10 MHz							
	Channel #		Freq.(MHz)		Channel #		Freq. (MHz)		Channel #		Freq. (MHz)	
L	23755		706.5		23780		709					
M	23790		710		23790		710					
H	23825		713.5		23800		711					

5. RF Exposure Limits

5.1 Uncontrolled Environment

Uncontrolled Environments are defined as locations where there is the exposure of individuals who have no knowledge or control of their exposure. The general population/uncontrolled exposure limits are applicable to situations in which the general public may be exposed or in which persons who are exposed as a consequence of their employment may not be made fully aware of the potential for exposure or cannot exercise control over their exposure. Members of the general public would come under this category when exposure is not employment-related; for example, in the case of a wireless transmitter that exposes persons in its vicinity.

5.2 Controlled Environment

Controlled Environments are defined as locations where there is exposure that may be incurred by persons who are aware of the potential for exposure, (i.e. as a result of employment or occupation). In general, occupational/controlled exposure limits are applicable to situations in which persons are exposed as a consequence of their employment, who have been made fully aware of the potential for exposure and can exercise control over their exposure. The exposure category is also applicable when the exposure is of a transient nature due to incidental passage through a location where the exposure levels may be higher than the general population/uncontrolled limits, but the exposed person is fully aware of the potential for exposure and can exercise control over his or her exposure by leaving the area or by some other appropriate means.

Limits for Occupational/Controlled Exposure (W/kg)

Whole-Body	Partial-Body	Hands, Wrists, Feet and Ankles
0.4	8.0	20.0

Limits for General Population/Uncontrolled Exposure (W/kg)

Whole-Body	Partial-Body	Hands, Wrists, Feet and Ankles
0.08	1.6	4.0

Whole-Body SAR is averaged over the entire body, partial-body SAR is averaged over any 1 gram of tissue defined as a tissue volume in the shape of a cube. SAR for hands, wrists, feet and ankles is averaged over any 10 grams of tissue defined as a tissue volume in the shape of a cube.

6. Specific Absorption Rate (SAR)

6.1 Introduction

SAR is related to the rate at which energy is absorbed per unit mass in an object exposed to a radio field. The SAR distribution in a biological body is complicated and is usually carried out by experimental techniques or numerical modeling. The standard recommends limits for two tiers of groups, occupational/controlled and general population/uncontrolled, based on a person's awareness and ability to exercise control over his or her exposure. In general, occupational/controlled exposure limits are higher than the limits for general population/uncontrolled.

6.2 SAR Definition

The SAR definition is the time derivative (rate) of the incremental energy (dW) absorbed by (dissipated in) an incremental mass (dm) contained in a volume element (dv) of a given density (ρ). The equation description is as below:

$$SAR = \frac{d}{dt} \left(\frac{dW}{dm} \right) = \frac{d}{dt} \left(\frac{dW}{\rho dv} \right)$$

SAR is expressed in units of Watts per kilogram (W/kg)

$$SAR = \frac{\sigma |E|^2}{\rho}$$

Where: σ is the conductivity of the tissue, ρ is the mass density of the tissue and E is the RMS electrical field strength.

7. System Description and Setup

The DASY system used for performing compliance tests consists of the following items:

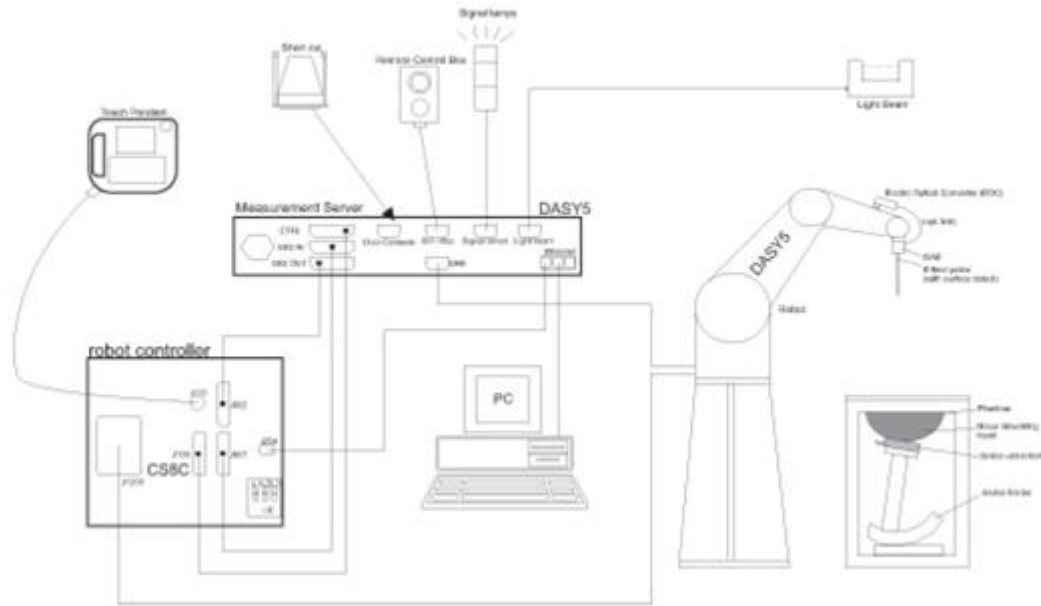

- A standard high precision 6-axis robot with controller, teach pendant and software. An arm extension for accommodating the data acquisition electronics (DAE).
- An isotropic Field probe optimized and calibrated for the targeted measurement.
- A data acquisition electronics (DAE) which performs the signal amplification, signal multiplexing, AD-conversion, offset measurements, mechanical surface detection, collision detection, etc. The unit is battery powered with standard or rechargeable batteries. The signal is optically transmitted to the EOC.
- The Electro-optical converter (EOC) performs the conversion from optical to electrical signals for the digital communication to the DAE. To use optical surface detection, a special version of the EOC is required. The EOC signal is transmitted to the measurement server.
- The function of the measurement server is to perform the time critical tasks such as signal filtering, control of the robot operation and fast movement interrupts.
- The Light Beam used is for probe alignment. This improves the (absolute) accuracy of the probe positioning.
- A computer running WinXP or Win7 and the DASY5 software.
- Remote control and teach pendant as well as additional circuitry for robot safety such as warning lamps, etc.
- The phantom, the device holder and other accessories according to the targeted measurement.

7.1 E-Field Probe

The SAR measurement is conducted with the dosimetric probe (manufactured by SPEAG).The probe is specially designed and calibrated for use in liquid with high permittivity. The dosimetric probe has special calibration in liquid at different frequency. This probe has a built in optical surface detection system to prevent from collision with phantom.

<EX3DV4 Probe>

Construction	Symmetric design with triangular core Built-in shielding against static charges PEEK enclosure material (resistant to organic solvents, e.g., DGBE)	
Frequency	10 MHz – >6 GHz Linearity: ±0.2 dB (30 MHz – 6 GHz)	
Directivity	±0.3 dB in TSL (rotation around probe axis) ±0.5 dB in TSL (rotation normal to probe axis)	
Dynamic Range	10 µW/g – >100 mW/g Linearity: ±0.2 dB (noise: typically <1 µW/g)	
Dimensions	Overall length: 337 mm (tip: 20 mm) Tip diameter: 2.5 mm (body: 12 mm) Typical distance from probe tip to dipole centers: 1 mm	

7.2 Data Acquisition Electronics (DAE)

The data acquisition electronics (DAE) consists of a highly sensitive electrometer-grade preamplifier with auto-zeroing, a channel and gain-switching multiplexer, a fast 16 bit AD-converter and a command decoder and control logic unit. Transmission to the measurement server is accomplished through an optical downlink for data and status information as well as an optical uplink for commands and the clock.

The input impedance of the DAE is 200 MOhm; the inputs are symmetrical and floating. Common mode rejection is above 80 dB.



Photo of DAE

7.3 Phantom

<SAM Twin Phantom>

Shell Thickness	2 ± 0.2 mm; Center ear point: 6 ± 0.2 mm	
Filling Volume	Approx. 25 liters	
Dimensions	Length: 1000 mm; Width: 500 mm; Height: adjustable feet	
Measurement Areas	Left Hand, Right Hand, Flat Phantom	

The bottom plate contains three pair of bolts for locking the device holder. The device holder positions are adjusted to the standard measurement positions in the three sections. A white cover is provided to tap the phantom during off-periods to prevent water evaporation and changes in the liquid parameters. On the phantom top, three reference markers are provided to identify the phantom position with respect to the robot.

<ELI Phantom>

Shell Thickness	2 ± 0.2 mm (sagging: <1%)	
Filling Volume	Approx. 30 liters	
Dimensions	Major ellipse axis: 600 mm Minor axis: 400 mm	

The ELI phantom is intended for compliance testing of handheld and body-mounted wireless devices in the frequency range of 30 MHz to 6 GHz. ELI4 is fully compatible with standard and all known tissue simulating liquids.

7.4 Device Holder

<Mounting Device for Hand-Held Transmitter>

In combination with the Twin SAM V5.0/V5.0c or ELI phantoms, the Mounting Device for Hand-Held Transmitters enables rotation of the mounted transmitter device to specified spherical coordinates. At the heads, the rotation axis is at the ear opening. Transmitter devices can be easily and accurately positioned according to IEC 62209-1, IEEE 1528, FCC, or other specifications. The device holder can be locked for positioning at different phantom sections (left head, right head, flat). And upgrade kit to Mounting Device to enable easy mounting of wider devices like big smart-phones, e-books, small tablets, etc. It holds devices with width up to 140 mm.



Mounting Device for Hand-Held Transmitters



Mounting Device Adaptor for Wide-Phones

<Mounting Device for Laptops and other Body-Worn Transmitters>

The extension is lightweight and made of POM, acrylic glass and foam. It fits easily on the upper part of the mounting device in place of the phone positioned. The extension is fully compatible with the SAM Twin and ELI phantoms.



Mounting Device for Laptops

8. Measurement Procedures

The measurement procedures are as follows:

<Conducted power measurement>

- (a) For WWAN power measurement, use base station simulator to configure EUT WWAN transmission in conducted connection with RF cable, at maximum power in each supported wireless interface and frequency band.
- (b) Read the WWAN RF power level from the base station simulator.
- (c) For WLAN/BT power measurement, use engineering software to configure EUT WLAN/BT continuously transmission, at maximum RF power in each supported wireless interface and frequency band
- (d) Connect EUT RF port through RF cable to the power meter, and measure WLAN/BT output power

<SAR measurement>

- (a) Use base station simulator to configure EUT WWAN transmission in radiated connection, and engineering software to configure EUT WLAN/BT continuously transmission, at maximum RF power, in the highest power channel.
- (b) Place the EUT in the positions as Appendix D demonstrates.
- (c) Set scan area, grid size and other setting on the DASY software.
- (d) Measure SAR results for the highest power channel on each testing position.
- (e) Find out the largest SAR result on these testing positions of each band
- (f) Measure SAR results for other channels in worst SAR testing position if the reported SAR of highest power channel is larger than 0.8 W/kg

According to the test standard, the recommended procedure for assessing the peak spatial-average SAR value consists of the following steps:

- (a) Power reference measurement
- (b) Area scan
- (c) Zoom scan
- (d) Power drift measurement

8.1 Spatial Peak SAR Evaluation

The procedure for spatial peak SAR evaluation has been implemented according to the test standard. It can be conducted for 1g and 10g, as well as for user-specific masses. The DASY software includes all numerical procedures necessary to evaluate the spatial peak SAR value.

The base for the evaluation is a "cube" measurement. The measured volume must include the 1g and 10g cubes with the highest averaged SAR values. For that purpose, the center of the measured volume is aligned to the interpolated peak SAR value of a previously performed area scan.

The entire evaluation of the spatial peak values is performed within the post-processing engine (SEMCAD). The system always gives the maximum values for the 1g and 10g cubes. The algorithm to find the cube with highest averaged SAR is divided into the following stages:

- (a) Extraction of the measured data (grid and values) from the Zoom Scan
- (b) Calculation of the SAR value at every measurement point based on all stored data (A/D values and measurement parameters)
- (c) Generation of a high-resolution mesh within the measured volume
- (d) Interpolation of all measured values from the measurement grid to the high-resolution grid
- (e) Extrapolation of the entire 3-D field distribution to the phantom surface over the distance from sensor to surface
- (f) Calculation of the averaged SAR within masses of 1g and 10g

8.2 Power Reference Measurement

The Power Reference Measurement and Power Drift Measurements are for monitoring the power drift of the device under test in the batch process. The minimum distance of probe sensors to surface determines the closest measurement point to phantom surface. This distance cannot be smaller than the distance of sensor calibration points to probe tip as defined in the probe properties.

8.3 Area Scan

The area scan is used as a fast scan in two dimensions to find the area of high field values, before doing a fine measurement around the hot spot. The sophisticated interpolation routines implemented in DASY software can find the maximum found in the scanned area, within a range of the global maximum. The range (in dB0) is specified in the standards for compliance testing. For example, a 2 dB range is required in IEEE standard 1528 and IEC 62209 standards, whereby 3 dB is a requirement when compliance is assessed in accordance with the ARIB standard (Japan), if only one zoom scan follows the area scan, then only the absolute maximum will be taken as reference. For cases where multiple maximums are detected, the number of zoom scans has to be increased accordingly.

Area scan parameters extracted from FCC KDB 865664 D01v01r04 SAR measurement 100 MHz to 6 GHz.

	≤ 3 GHz	> 3 GHz
Maximum distance from closest measurement point (geometric center of probe sensors) to phantom surface	5 ± 1 mm	$\frac{1}{2} \cdot \delta \cdot \ln(2) \pm 0.5$ mm
Maximum probe angle from probe axis to phantom surface normal at the measurement location	30° ± 1°	20° ± 1°
Maximum area scan spatial resolution: $\Delta x_{Area}, \Delta y_{Area}$	≤ 2 GHz: ≤ 15 mm 2 – 3 GHz: ≤ 12 mm	3 – 4 GHz: ≤ 12 mm 4 – 6 GHz: ≤ 10 mm
	When the x or y dimension of the test device, in the measurement plane orientation, is smaller than the above, the measurement resolution must be ≤ the corresponding x or y dimension of the test device with at least one measurement point on the test device.	

8.4 Zoom Scan

Zoom scans are used assess the peak spatial SAR values within a cubic averaging volume containing 1 gram and 10 gram of simulated tissue. The zoom scan measures points (refer to table below) within a cube shoes base faces are centered on the maxima found in a preceding area scan job within the same procedure. When the measurement is done, the zoom scan evaluates the averaged SAR for 1 gram and 10 gram and displays these values next to the job's label.

Zoom scan parameters extracted from FCC KDB 865664 D01v01r04 SAR measurement 100 MHz to 6 GHz.

		≤ 3 GHz	> 3 GHz	
Maximum zoom scan spatial resolution: $\Delta x_{Zoom}, \Delta y_{Zoom}$		≤ 2 GHz: ≤ 8 mm 2 – 3 GHz: ≤ 5 mm*	3 – 4 GHz: ≤ 5 mm* 4 – 6 GHz: ≤ 4 mm*	
Maximum zoom scan spatial resolution, normal to phantom surface	uniform grid: $\Delta z_{Zoom}(n)$	≤ 5 mm	3 – 4 GHz: ≤ 4 mm 4 – 5 GHz: ≤ 3 mm 5 – 6 GHz: ≤ 2 mm	
	graded grid	$\Delta z_{Zoom}(1)$: between 1 st two points closest to phantom surface	≤ 4 mm	3 – 4 GHz: ≤ 3 mm 4 – 5 GHz: ≤ 2.5 mm 5 – 6 GHz: ≤ 2 mm
		$\Delta z_{Zoom}(n>1)$: between subsequent points	$\leq 1.5 \cdot \Delta z_{Zoom}(n-1)$	
Minimum zoom scan volume	x, y, z	≥ 30 mm	3 – 4 GHz: ≥ 28 mm 4 – 5 GHz: ≥ 25 mm 5 – 6 GHz: ≥ 22 mm	
Note: δ is the penetration depth of a plane-wave at normal incidence to the tissue medium; see draft standard IEEE P1528-2011 for details. * When zoom scan is required and the <i>reported</i> SAR from the <i>area scan based 1-g SAR estimation</i> procedures of KDB 447498 is ≤ 1.4 W/kg, ≤ 8 mm, ≤ 7 mm and ≤ 5 mm zoom scan resolution may be applied, respectively, for 2 GHz to 3 GHz, 3 GHz to 4 GHz and 4 GHz to 6 GHz.				

8.5 Volume Scan Procedures

The volume scan is used for assess overlapping SAR distributions for antennas transmitting in different frequency bands. It is equivalent to an oversized zoom scan used in standalone measurements. The measurement volume will be used to enclose all the simultaneous transmitting antennas. For antennas transmitting simultaneously in different frequency bands, the volume scan is measured separately in each frequency band. In order to sum correctly to compute the 1g aggregate SAR, the EUT remain in the same test position for all measurements and all volume scan use the same spatial resolution and grid spacing. When all volume scan were completed, the software, SEMCAD postprocessor can combine and subsequently superpose these measurement data to calculating the multiband SAR.

8.6 Power Drift Monitoring

All SAR testing is under the EUT install full charged battery and transmit maximum output power. In DASy measurement software, the power reference measurement and power drift measurement procedures are used for monitoring the power drift of EUT during SAR test. Both these procedures measure the field at a specified reference position before and after the SAR testing. The software will calculate the field difference in dB. If the power drifts more than 5%, the SAR will be retested.



9. Test Equipment List

Manufacturer	Name of Equipment	Type/Model	Serial Number	Calibration	
				Last Cal.	Due Date
SPEAG	750MHz System Validation Kit	D750V3	1099	2018/12/6	2019/12/5
SPEAG	835MHz System Validation Kit	D835V2	4d162	2018/12/5	2019/12/4
SPEAG	1750MHz System Validation Kit	D1750V2	1137	2018/7/30	2019/7/29
SPEAG	1900MHz System Validation Kit	D1900V2	5d182	2018/12/7	2019/12/6
SPEAG	2450MHz System Validation Kit	D2450V2	924	2018/3/22	2019/3/21
SPEAG	2600MHz System Validation Kit	D2600V2	1070	2018/12/7	2019/12/6
SPEAG	5000MHz System Validation Kit	D5GHzV2	1167	2018/8/3	2019/8/2
SPEAG	Data Acquisition Electronics	DAE4	1437	2018/10/15	2019/10/14
SPEAG	Dosimetric E-Field Probe	EX3DV4	3753	2018/5/29	2019/5/28
SPEAG	ELI4 Phantom	QD OVA 002 AA	TP-1149	NCR	NCR
SPEAG	Phone Positioner	N/A	N/A	NCR	NCR
Anritsu	Radio communication analyzer	MT8820C	6201300653	2018/7/18	2019/7/17
Agilent	Wireless Communication Test Set	E5515C	MY50267224	2018/9/11	2019/9/10
Agilent	Network Analyzer	E5071C	MY46523671	2018/10/18	2019/10/17
Speag	Dielectric Assessment KIT	DAK-3.5	1071	2018/11/20	2019/11/19
Agilent	Signal Generator	N5181A	MY50145381	2018/12/22	2019/12/21
Anritsu	Power Sensor	MA2411B	1306099	2018/7/30	2019/7/29
Anritsu	Power Meter	ML2495A	1349001	2018/7/26	2019/7/25
Anritsu	Power Sensor	MA2411B	1207253	2018/12/22	2019/12/21
Anritsu	Power Meter	ML2495A	1218010	2018/12/22	2019/12/21
R&S	CBT BLUETOOTH TESTER	CBT	100963	2018/12/22	2019/12/21
R&S	Spectrum Analyzer	FSP7	100818	2018/7/18	2019/7/17
Anymetre	Thermo-Hygrometer	JR593	2015030904	2018/4/19	2019/4/18
Anymetre	Thermo-Hygrometer	JR593	2015030903	2018/12/22	2019/12/21
ARRA	Power Divider	A3200-2	N/A	Note	
PASTERNAK	Dual Directional Coupler	PE2214-10	N/A	Note	
Agilent	Dual Directional Coupler	778D	50422	Note	
MCL	Attenuation1	BW-S10W5	N/A	Note	
Weinschel	Attenuation2	3M-20	N/A	Note	
Zhongjilianhe	Attenuation3	MVE2214-03	N/A	Note	
mini-circuits	Amplifier	ZHL-42W+	QA1341002	Note	
mini-circuits	Amplifier	ZVE-3W-83+	599201528	Note	

Note: Prior to system verification and validation, the path loss from the signal generator to the system check source and the power meter, which includes the amplifier, cable, attenuator and directional coupler, was measured by the network analyzer. The reading of the power meter was offset by the path loss difference between the path to the power meter and the path to the system check source to monitor the actual power level fed to the system check source.

10. System Verification

10.1 Tissue Simulating Liquids

For the measurement of the field distribution inside the SAM phantom with DASY, the phantom must be filled with around 25 liters of homogeneous body tissue simulating liquid. For body SAR testing, the liquid height from the center of the flat phantom to the liquid top surface is larger than 15 cm, which is shown in Fig. 10.1.

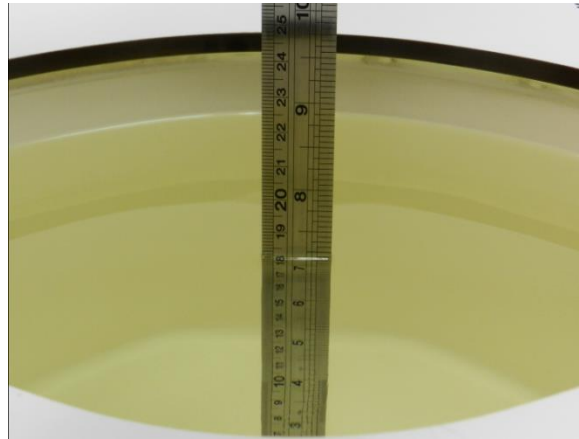

Fig 10.1 Photo of Liquid Height for Body SAR

10.2 Tissue Verification

The following tissue formulations are provided for reference only as some of the parameters have not been thoroughly verified. The composition of ingredients may be modified accordingly to achieve the desired target tissue parameters required for routine SAR evaluation.

Frequency (MHz)	Water (%)	Sugar (%)	Cellulose (%)	Salt (%)	Preventol (%)	DGBE (%)	Conductivity (σ)	Permittivity (ϵ_r)
For Body								
750	51.7	47.2	0	0.9	0.1	0	0.96	55.5
835	50.8	48.2	0	0.9	0.1	0	0.97	55.2
1800, 1900, 2000	70.2	0	0	0.4	0	29.4	1.52	53.3
2450	68.6	0	0	0	0	31.4	1.95	52.7
2600	68.1	0	0	0.1	0	31.8	2.16	52.5

Simulating Liquid for 5GHz, Manufactured by SPEAG

Ingredients	(% by weight)
Water	64~78%
Mineral oil	11~18%
Emulsifiers	9~15%
Additives and Salt	2~3%

<Tissue Dielectric Parameter Check Results>

Frequency (MHz)	Tissue Type	Liquid Temp. (°C)	Conductivity (σ)	Permittivity (ϵ_r)	Conductivity Target (σ)	Permittivity Target (ϵ_r)	Delta (σ) (%)	Delta (ϵ_r) (%)	Limit (%)	Date
750	Body	22.4	0.963	54.228	0.96	55.50	0.31	-2.29	±5	2019/1/19
835	Body	22.5	0.972	53.975	0.97	55.20	0.21	-2.22	±5	2019/1/19
1750	Body	22.5	1.511	51.994	1.49	53.40	1.41	-2.63	±5	2019/1/18
1900	Body	22.6	1.512	53.903	1.52	53.30	-0.53	1.13	±5	2019/1/18
2450	Body	22.5	1.938	51.276	1.95	52.70	-0.62	-2.70	±5	2019/1/14
2600	Body	22.6	2.192	50.732	2.16	52.50	1.48	-3.37	±5	2019/1/15
5250	Body	22.5	5.290	50.979	5.36	48.90	-1.31	4.25	±5	2019/1/14
5750	Body	22.7	6.115	50.005	5.94	48.30	2.95	3.53	±5	2019/1/14

10.3 System Performance Check Results

Comparing to the original SAR value provided by SPEAG, the verification data should be within its specification of 10 %. Below table shows the target SAR and measured SAR after normalized to 1W input power. The table below indicates the system performance check can meet the variation criterion and the plots can be referred to Appendix A of this report.

Date	Frequency (MHz)	Tissue Type	Input Power (mW)	Dipole S/N	Probe S/N	DAE S/N	Measured 1g SAR (W/kg)	Targeted 1g SAR (W/kg)	Normalized 1g SAR (W/kg)	Deviation (%)
2019/1/19	750	Body	250	1099	3753	1437	2.23	8.61	8.92	3.60
2019/1/19	835	Body	250	4d162	3753	1437	2.25	9.70	9.00	-7.22
2019/1/18	1750	Body	250	1137	3753	1437	9.29	37.00	37.16	0.43
2019/1/18	1900	Body	250	5d182	3753	1437	9.71	39.90	38.84	-2.66
2019/1/14	2450	Body	250	924	3753	1437	12.50	50.70	50.00	-1.38
2019/1/15	2600	Body	250	1070	3753	1437	13.90	54.60	55.60	1.83
2019/1/14	5250	Body	100	1167	3753	1437	7.50	74.40	75.00	0.81
2019/1/14	5750	Body	100	1167	3753	1437	7.48	74.30	74.80	0.67

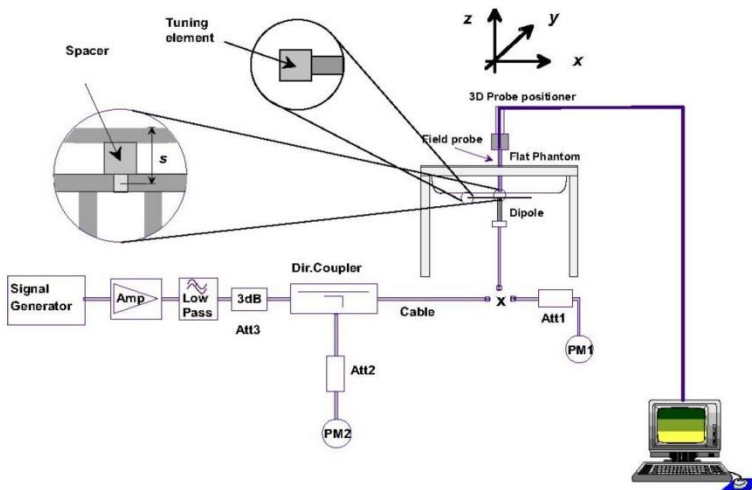

Fig 10.3.1 System Performance Check Setup



Fig 10.3.2 Setup Photo



11. RF Exposure Positions

11.1 SAR Testing for Tablet

- (a) To position the device parallel to the phantom surface with either keypad up or down.
- (b) To adjust the device parallel to the flat phantom.
- (c) To adjust the distance between the device surface and the flat phantom to 0 cm.

Please refer to Appendix D for the test setup photos.

12. Conducted RF Output Power (Unit: dBm)

<WCDMA Conducted Power>

1. The following tests were conducted according to the test requirements outlines in 3GPP TS 34.121 specification.
2. The procedures in KDB 941225 D01v03r01 are applied for 3GPP Rel. 6 HSPA to configure the device in the required sub-test mode(s) to determine SAR test exclusion.
3. For DC-HSDPA, the device was configured according to the H-Set 12, Fixed Reference Channel (FRC) configuration in Table C.8.1.12 of 3GPP TS 34.121-1, with the primary and the secondary serving HS-DSCH Cell enabled during the power measurement.

A summary of these settings are illustrated below:

HSDPA Setup Configuration:

- a. The EUT was connected to Base Station Agilent E5515C referred to the Setup Configuration.
- b. The RF path losses were compensated into the measurements.
- c. A call was established between EUT and Base Station with following setting:
 - i. Set Gain Factors (β_c and β_d) and parameters were set according to each
 - ii. Specific sub-test in the following table, C10.1.4, quoted from the TS 34.121
 - iii. Set RMC 12.2Kbps + HSDPA mode.
 - iv. Set Cell Power = -86 dBm
 - v. Set HS-DSCH Configuration Type to FRC (H-set 1, QPSK)
 - vi. Select HSDPA Uplink Parameters
 - vii. Set Delta ACK, Delta NACK and Delta CQI = 8
 - viii. Set Ack-Nack Repetition Factor to 3
 - ix. Set CQI Feedback Cycle (k) to 4 ms
 - x. Set CQI Repetition Factor to 2
 - xi. Power Ctrl Mode = All Up bits
- d. The transmitted maximum output power was recorded.

Table C.10.1.4: β values for transmitter characteristics tests with HS-DPCCH

Sub-test	β_c	β_d	β_d (SF)	β_c/β_d	β_{HS} (Note 1, Note 2)	CM (dB) (Note 3)	MPR (dB) (Note 3)
1	2/15	15/15	64	2/15	4/15	0.0	0.0
2	12/15 (Note 4)	15/15 (Note 4)	64	12/15 (Note 4)	24/15	1.0	0.0
3	15/15	8/15	64	15/8	30/15	1.5	0.5
4	15/15	4/15	64	15/4	30/15	1.5	0.5

Note 1: $\Delta_{ACK}, \Delta_{NACK}$ and $\Delta_{CQI} = 30/15$ with $\beta_{HS} = 30/15 * \beta_c$.

Note 2: For the HS-DPCCH power mask requirement test in clause 5.2C, 5.7A, and the Error Vector Magnitude (EVM) with HS-DPCCH test in clause 5.13.1A, and HSDPA EVM with phase discontinuity in clause 5.13.1AA, Δ_{ACK} and $\Delta_{NACK} = 30/15$ with $\beta_{HS} = 30/15 * \beta_c$, and $\Delta_{CQI} = 24/15$ with $\beta_{HS} = 24/15 * \beta_c$.

Note 3: CM = 1 for $\beta_c/\beta_d = 12/15, \beta_{HS}/\beta_c = 24/15$. For all other combinations of DPDCCH, DPCCH and HS-DPCCH the MPR is based on the relative CM difference. This is applicable for only UEs that support HSDPA in release 6 and later releases.

Note 4: For subtest 2 the β_c/β_d ratio of 12/15 for the TFC during the measurement period (TF1, TF0) is achieved by setting the signalled gain factors for the reference TFC (TF1, TF1) to $\beta_c = 11/15$ and $\beta_d = 15/15$.

Setup Configuration

HSUPA Setup Configuration:

- a. The EUT was connected to Base Station Agilent E5515C referred to the Setup Configuration.
- b. The RF path losses were compensated into the measurements.
- c. A call was established between EUT and Base Station with following setting * :
 - i. Call Configs = 5.2B, 5.9B, 5.10B, and 5.13.2B with QPSK
 - ii. Set the Gain Factors (β_c and β_d) and parameters (AG Index) were set according to each specific sub-test in the following table, C11.1.3, quoted from the TS 34.121
 - iii. Set Cell Power = -86 dBm
 - iv. Set Channel Type = 12.2k + HSPA
 - v. Set UE Target Power
 - vi. Power Ctrl Mode= Alternating bits
 - vii. Set and observe the E-TFCl
 - viii. Confirm that E-TFCl is equal to the target E-TFCl of 75 for sub-test 1, and other subtest's E-TFCl
- d. The transmitted maximum output power was recorded.

Table C.11.1.3: β values for transmitter characteristics tests with HS-DPCCH and E-DCH

Sub-test	β_c	β_d	β_d (SF)	β_c/β_d	β_{HS} (Note1)	β_{ec}	β_{ed} (Note 4) (Note 5)	β_{ed} (SF)	β_{ed} (Codes)	CM (dB) (Note 2)	MPR (dB) (Note 2) (Note 6)	AG Index (Note 5)	E-TFCl
1	11/15 (Note 3)	15/15 (Note 3)	64	11/15 (Note 3)	22/15	209/25	1309/225	4	1	1.0	0.0	20	75
2	6/15	15/15	64	6/15	12/15	12/15	94/75	4	1	3.0	2.0	12	67
3	15/15	9/15	64	15/9	30/15	30/15	$\beta_{ed1}: 47/15$ $\beta_{ed2}: 47/15$	4 4	2	2.0	1.0	15	92
4	2/15	15/15	64	2/15	4/15	2/15	56/75	4	1	3.0	2.0	17	71
5	15/15	0	-	-	5/15	5/15	47/15	4	1	1.0	0.0	12	67

Note 1: For sub-test 1 to 4, Δ_{ACK} , Δ_{NACK} and $\Delta_{CQI} = 30/15$ with $\beta_{hs} = 30/15 * \beta_c$. For sub-test 5, Δ_{ACK} , Δ_{NACK} and $\Delta_{CQI} = 5/15$ with $\beta_{hs} = 5/15 * \beta_c$.

Note 2: CM = 1 for $\beta_c/\beta_d = 12/15$, $\beta_{hs}/\beta_c = 24/15$. For all other combinations of DPDCH, DPCCH, HS-DPCCH, E-DPDCH and E-DPCCH the MPR is based on the relative CM difference.

Note 3: For subtest 1 the β_c/β_d ratio of 11/15 for the TFC during the measurement period (TF1, TF0) is achieved by setting the signalled gain factors for the reference TFC (TF1, TF1) to $\beta_c = 10/15$ and $\beta_d = 15/15$.

Note 4: In case of testing by UE using E-DPDCH Physical Layer category 1, Sub-test 3 is omitted according to TS25.306 Table 5.1g.

Note 5: β_{ed} can not be set directly; it is set by Absolute Grant Value.

Note 6: For subtests 2, 3 and 4, UE may perform E-DPDCH power scaling at max power which could results in slightly smaller MPR values.

Setup Configuration

DC-HSDPA 3GPP release 8 Setup Configuration:

- a. The EUT was connected to Base Station Agilent E5515C referred to the Setup Configuration below
- b. The RF path losses were compensated into the measurements.
- c. A call was established between EUT and Base Station with following setting:
 - i. Set RMC 12.2Kbps + HSDPA mode.
 - ii. Set Cell Power = -25 dBm
 - iii. Set HS-DSCH Configuration Type to FRC (H-set 12, QPSK)
 - iv. Select HSDPA Uplink Parameters
 - v. Set Gain Factors (β_c and β_d) and parameters were set according to each Specific sub-test in the following table, C10.1.4, quoted from the TS 34.121
 - a). Subtest 1: $\beta_c/\beta_d=2/15$
 - b). Subtest 2: $\beta_c/\beta_d=12/15$
 - c). Subtest 3: $\beta_c/\beta_d=15/8$
 - d). Subtest 4: $\beta_c/\beta_d=15/4$
 - vi. Set Delta ACK, Delta NACK and Delta CQI = 8
 - vii. Set Ack-Nack Repetition Factor to 3
 - viii. Set CQI Feedback Cycle (k) to 4 ms
 - ix. Set CQI Repetition Factor to 2
 - x. Power Ctrl Mode = All Up bits
- d. The transmitted maximum output power was recorded.

The following tests were conducted according to the test requirements outlines in 3GPP TS 34.121 specification. A summary of these settings are illustrated below:

C.8.1.12 Fixed Reference Channel Definition H-Set 12

Table C.8.1.12: Fixed Reference Channel H-Set 12

Parameter	Unit	Value
Nominal Avg. Inf. Bit Rate	kbps	60
Inter-TTI Distance	TTI's	1
Number of HARQ Processes	Processes	6
Information Bit Payload (N_{INF})	Bits	120
Number Code Blocks	Blocks	1
Binary Channel Bits Per TTI	Bits	960
Total Available SML's in UE	SML's	19200
Number of SML's per HARQ Proc.	SML's	3200
Coding Rate		0.15
Number of Physical Channel Codes	Codes	1
Modulation		QPSK
Note 1: The RMC is intended to be used for DC-HSDPA mode and both cells shall transmit with identical parameters as listed in the table. Note 2: Maximum number of transmission is limited to 1, i.e., retransmission is not allowed. The redundancy and constellation version 0 shall be used.		

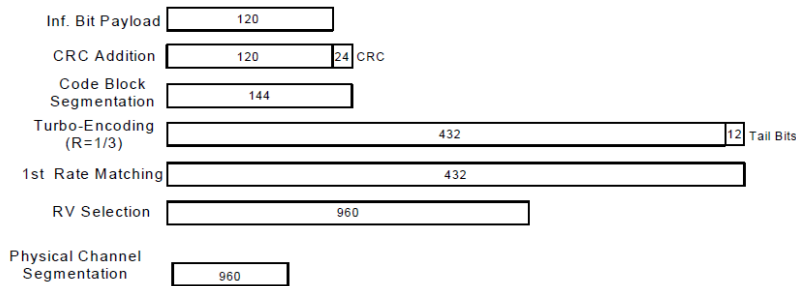

Figure C.8.19: Coding rate for Fixed reference Channel H-Set 12 (QPSK)

Setup Configuration



<WCDMA Conducted Power>

General Note:

1. Per KDB 941225 D01v03r01, for SAR testing is measured using a 12.2 kbps RMC with TPC bits configured to all "1's".
2. Per KDB 941225 D01v03r01, RMC 12.2kbps setting is used to evaluate SAR. The maximum output power and tune-up tolerance specified for production units in HSDPA / HSUPA / DC-HSDPA is ≤ ¼ dB higher than RMC 12.2Kbps or when the highest reported SAR of the RMC12.2Kbps is scaled by the ratio of specified maximum output power and tune-up tolerance of HSDPA / HSUPA / DC-HSDPA to RMC12.2Kbps and the adjusted SAR is ≤ 1.2 W/kg, SAR measurement is not required for HSDPA / HSUPA / DC-HSDPA, and according to the following RF output power, the output power results of the secondary modes (HSUPA, HSDPA, DC-HSDPA) are less than ¼ dB higher than the primary modes; therefore, SAR measurement is not required for HSDPA / HSUPA / DC-HSDPA.

Band		WCDMA Band II			Tune-up Limit (dBm)	WCDMA Band IV			Tune-up Limit (dBm)	WCDMA Band V			Tune-up Limit (dBm)
Tx Channel		9262	9400	9538		1312	1413	1513		4132	4182	4233	
Rx Channel		9662	9800	9938		1537	1638	1738		4357	4407	4458	
Frequency (MHz)		1852.4	1880	1907.6		1712.4	1732.6	1752.6		826.4	836.4	846.6	
3GPP Rel 99	RMC 12.2Kbps	22.67	22.55	22.61	23.00	21.89	21.83	21.85	22.00	23.50	23.69	23.57	24.00
3GPP Rel 6	HSDPA Subtest-1	21.79	21.76	21.80	22.50	20.91	20.89	20.91	21.50	22.81	22.71	22.59	23.50
3GPP Rel 6	HSDPA Subtest-2	21.87	21.78	21.92	22.50	20.91	20.89	20.91	21.50	22.78	22.76	22.66	23.50
3GPP Rel 6	HSDPA Subtest-3	21.38	21.29	21.43	22.00	20.45	20.44	20.43	21.00	22.24	22.32	22.19	23.00
3GPP Rel 6	HSDPA Subtest-4	21.36	21.41	21.43	22.00	20.44	20.43	20.43	21.00	22.31	22.32	22.19	23.00
3GPP Rel 8	DC-HSDPA Subtest-1	20.63	20.56	20.43	21.00	19.91	19.87	19.88	20.00	21.23	21.29	21.26	21.50
3GPP Rel 8	DC-HSDPA Subtest-2	20.66	20.51	20.40	21.00	19.96	19.86	19.85	20.00	21.20	21.30	21.22	21.50
3GPP Rel 8	DC-HSDPA Subtest-3	20.21	20.13	20.01	20.50	19.58	19.52	19.50	20.00	20.98	21.00	20.99	21.50
3GPP Rel 8	DC-HSDPA Subtest-4	20.23	20.15	20.03	20.50	19.60	19.55	19.52	20.00	20.99	21.05	21.00	21.50
3GPP Rel 6	HSUPA Subtest-1	21.25	21.08	21.29	22.00	20.73	20.27	20.63	21.00	22.49	22.60	22.51	23.00
3GPP Rel 6	HSUPA Subtest-2	20.89	20.59	20.73	21.00	19.76	19.77	19.27	20.00	21.26	21.30	21.59	22.00
3GPP Rel 6	HSUPA Subtest-3	20.48	20.39	20.33	21.00	19.45	19.33	19.38	20.00	21.10	21.31	21.21	21.50
3GPP Rel 6	HSUPA Subtest-4	21.05	20.56	21.00	21.50	19.76	19.62	19.67	20.00	21.65	21.57	21.48	22.00
3GPP Rel 6	HSUPA Subtest-5	21.90	21.70	21.70	22.00	20.80	20.90	20.70	21.50	22.50	22.60	22.60	23.00



<LTE Conducted Power>

General Note:

1. Anritsu MT8820C base station simulator was used to setup the connection with EUT; the frequency band, channel bandwidth, RB allocation configuration, modulation type are set in the base station simulator to configure EUT transmitting at maximum power and at different configurations which are requested to be reported to FCC, for conducted power measurement and SAR testing.
2. Per KDB 941225 D05v02r05, when a properly configured base station simulator is used for the SAR and power measurements, spectrum plots for each RB allocation and offset configuration is not required.
3. Per KDB 941225 D05v02r05, start with the largest channel bandwidth and measure SAR for QPSK with 1 RB allocation, using the RB offset and required test channel combination with the highest maximum output power for RB offsets at the upper edge, middle and lower edge of each required test channel.
4. Per KDB 941225 D05v02r05, 50% RB allocation for QPSK SAR testing follows 1RB QPSK allocation procedure.
5. Per KDB 941225 D05v02r05, for QPSK with 100% RB allocation, SAR is not required when the highest maximum output power for 100 % RB allocation is less than the highest maximum output power in 50% and 1 RB allocations and the highest reported SAR for 1 RB and 50% RB allocation are ≤ 0.8 W/kg. Otherwise, SAR is measured for the highest output power channel; and if the reported SAR is > 1.45 W/kg, the remaining required test channels must also be tested.
6. Per KDB 941225 D05v02r05, 16QAM output power for each RB allocation configuration is $>$ not $\frac{1}{2}$ dB higher than the same configuration in QPSK and the reported SAR for the QPSK configuration is ≤ 1.45 W/kg; Per KDB 941225 D05v02r05, 16QAM SAR testing is not required.
7. Per KDB 941225 D05v02r05, smaller bandwidth output power for each RB allocation configuration is $>$ not $\frac{1}{2}$ dB higher than the same configuration in the largest supported bandwidth, and the reported SAR for the largest supported bandwidth is ≤ 1.45 W/kg; Per KDB 941225 D05v02r05, smaller bandwidth SAR testing is not required.
8. For LTE B4 / B5 / B12 the maximum bandwidth does not support three non-overlapping channels, per KDB 941225 D05v02r05, when a device supports overlapping channel assignment in a channel bandwidth configuration, the middle channel of the group of overlapping channels should be selected for testing.
9. LTE band 17 SAR test was covered by Band 12; according to April 2015 TCB workshop, SAR test for overlapping LTE bands can be reduced if
 - a. the maximum output power, including tolerance, for the smaller band is \leq the larger band to qualify for the SAR test exclusion
 - b. the channel bandwidth and other operating parameters for the smaller band are fully supported by the larger band



<LTE Band 2>

BW [MHz]	Modulation	RB Size	RB Offset	Power Low Ch. / Freq.	Power Middle Ch. / Freq.	Power High Ch. / Freq.	Tune-up limit (dBm)	MPR (dB)
Channel				18700	18900	19100		
Frequency (MHz)				1860	1880	1900		
20	QPSK	1	0	22.70	22.82	22.71	23	0
20	QPSK	1	49	22.62	22.61	22.70		
20	QPSK	1	99	22.53	22.42	22.70		
20	QPSK	50	0	21.57	21.58	21.51	22	1
20	QPSK	50	24	21.56	21.45	21.50		
20	QPSK	50	50	21.54	21.41	21.46		
20	QPSK	100	0	21.56	21.57	21.48		
20	16QAM	1	0	21.86	21.94	21.77	22	1
20	16QAM	1	49	21.84	21.99	21.69		
20	16QAM	1	99	21.86	21.99	21.97		
20	16QAM	50	0	20.54	20.29	20.52	21	2
20	16QAM	50	24	20.63	20.34	20.35		
20	16QAM	50	50	20.57	20.25	20.49		
20	16QAM	100	0	20.58	20.34	20.40		
Channel				18675	18900	19125	Tune-up limit (dBm)	MPR (dB)
Frequency (MHz)				1857.5	1880	1902.5		
15	QPSK	1	0	22.66	22.59	22.76	23	0
15	QPSK	1	37	22.43	22.34	22.43		
15	QPSK	1	74	22.58	22.61	22.54		
15	QPSK	36	0	21.60	21.57	21.59	22	1
15	QPSK	36	20	21.52	21.47	21.59		
15	QPSK	36	39	21.61	21.42	21.51		
15	QPSK	75	0	21.64	21.44	21.53		
15	16QAM	1	0	21.68	21.62	21.53	22	1
15	16QAM	1	37	21.60	21.49	21.28		
15	16QAM	1	74	21.59	21.28	21.49		
15	16QAM	36	0	20.50	20.62	20.45	21	2
15	16QAM	36	20	20.47	20.44	20.36		
15	16QAM	36	39	20.50	20.35	20.47		
15	16QAM	75	0	20.59	20.37	20.46		



Channel				18650	18900	19150	Tune-up limit (dBm)	MPR (dB)
Frequency (MHz)				1855	1880	1905		
10	QPSK	1	0	22.54	22.68	22.63	23	0
10	QPSK	1	25	22.58	22.60	22.70		
10	QPSK	1	49	22.49	22.34	22.59		
10	QPSK	25	0	21.54	21.55	21.47	22	1
10	QPSK	25	12	21.56	21.53	21.51		
10	QPSK	25	25	21.56	21.51	21.47		
10	QPSK	50	0	21.58	21.43	21.47	22	1
10	16QAM	1	0	21.81	21.58	21.96		
10	16QAM	1	25	21.80	21.59	21.72		
10	16QAM	1	49	21.69	21.69	21.81	21	2
10	16QAM	25	0	20.55	20.66	20.50		
10	16QAM	25	12	20.57	20.63	20.54		
10	16QAM	25	25	20.48	20.59	20.49	21	2
10	16QAM	50	0	20.53	20.27	20.53		
Channel				18625	18900	19175	Tune-up limit (dBm)	MPR (dB)
Frequency (MHz)				1852.5	1880	1907.5		
5	QPSK	1	0	22.54	22.68	22.63	23	0
5	QPSK	1	12	22.58	22.60	22.70		
5	QPSK	1	24	22.49	22.34	22.59		
5	QPSK	12	0	21.54	21.55	21.47	22	1
5	QPSK	12	7	21.56	21.53	21.51		
5	QPSK	12	13	21.56	21.51	21.47		
5	QPSK	25	0	21.58	21.43	21.47	22	1
5	16QAM	1	0	21.81	21.58	21.96		
5	16QAM	1	12	21.80	21.59	21.72		
5	16QAM	1	24	21.69	21.69	21.81	21	2
5	16QAM	12	0	20.55	20.66	20.50		
5	16QAM	12	7	20.57	20.63	20.54		
5	16QAM	12	13	20.48	20.59	20.49	21	2
5	16QAM	25	0	20.53	20.27	20.53		



Channel				18615	18900	19185	Tune-up limit (dBm)	MPR (dB)
Frequency (MHz)				1851.5	1880	1908.5		
3	QPSK	1	0	22.78	22.73	22.53	23	0
3	QPSK	1	8	22.78	22.81	22.48		
3	QPSK	1	14	22.80	22.67	22.71		
3	QPSK	8	0	21.70	21.50	21.62	22	1
3	QPSK	8	4	21.59	21.53	21.62		
3	QPSK	8	7	21.62	21.47	21.63		
3	QPSK	15	0	21.52	21.53	21.64		
3	16QAM	1	0	21.64	21.56	21.48	22	1
3	16QAM	1	8	21.61	21.52	21.39		
3	16QAM	1	14	21.85	21.58	21.55		
3	16QAM	8	0	20.75	20.38	20.74	21	2
3	16QAM	8	4	20.78	20.31	20.76		
3	16QAM	8	7	20.71	20.44	20.78		
3	16QAM	15	0	20.69	20.31	20.57		
Channel				18607	18900	19193	Tune-up limit (dBm)	MPR (dB)
Frequency (MHz)				1850.7	1880	1909.3		
1.4	QPSK	1	0	22.46	22.53	22.48	23	0
1.4	QPSK	1	3	22.77	22.75	22.49		
1.4	QPSK	1	5	22.50	22.66	22.35		
1.4	QPSK	3	0	22.53	22.37	22.57		
1.4	QPSK	3	1	22.58	22.51	22.50		
1.4	QPSK	3	3	22.59	22.52	22.49		
1.4	QPSK	6	0	21.63	21.56	21.53	22	1
1.4	16QAM	1	0	21.61	21.53	21.60	22	1
1.4	16QAM	1	3	21.81	21.69	21.31		
1.4	16QAM	1	5	21.61	21.62	21.34		
1.4	16QAM	3	0	21.77	21.44	21.71		
1.4	16QAM	3	1	21.84	21.48	21.73		
1.4	16QAM	3	3	21.69	21.38	21.72		
1.4	16QAM	6	0	20.59	20.51	20.51	21	2



<LTE Band 4>

BW [MHz]	Modulation	RB Size	RB Offset	Power Low Ch. / Freq.	Power Middle Ch. / Freq.	Power High Ch. / Freq.	Tune-up limit (dBm)	MPR (dB)
Channel				20050	20175	20300		
Frequency (MHz)				1720	1732.5	1745		
20	QPSK	1	0	22.29	22.39	22.39	23	0
20	QPSK	1	49	22.20	22.47	22.39		
20	QPSK	1	99	21.98	22.22	21.99		
20	QPSK	50	0	21.30	21.34	21.33	22	1
20	QPSK	50	24	21.15	21.07	21.14		
20	QPSK	50	50	20.88	21.08	21.07		
20	QPSK	100	0	21.05	20.97	21.15		
20	16QAM	1	0	21.55	21.56	21.69	22	1
20	16QAM	1	49	21.71	21.69	21.59		
20	16QAM	1	99	21.43	21.41	21.22		
20	16QAM	50	0	20.25	20.01	20.31	21	2
20	16QAM	50	24	20.13	19.94	20.11		
20	16QAM	50	50	19.86	20.07	20.10		
20	16QAM	100	0	20.04	20.00	20.07		
Channel				20025	20175	20325	Tune-up limit (dBm)	MPR (dB)
Frequency (MHz)				1717.5	1732.5	1747.5		
15	QPSK	1	0	22.28	22.27	22.29	23	0
15	QPSK	1	37	22.20	22.00	22.00		
15	QPSK	1	74	22.10	22.06	22.00		
15	QPSK	36	0	21.28	21.07	21.22	22	1
15	QPSK	36	20	21.07	21.11	21.16		
15	QPSK	36	39	21.04	21.11	21.11		
15	QPSK	75	0	21.18	21.09	21.24		
15	16QAM	1	0	21.06	21.20	21.21	22	1
15	16QAM	1	37	20.98	20.87	20.93		
15	16QAM	1	74	21.09	21.06	21.01		
15	16QAM	36	0	20.11	20.00	20.14	21	2
15	16QAM	36	20	20.10	19.95	19.99		
15	16QAM	36	39	20.08	20.15	19.94		
15	16QAM	75	0	20.10	20.14	20.14		



Channel				20000	20175	20350	Tune-up limit (dBm)	MPR (dB)
Frequency (MHz)				1715	1732.5	1750		
10	QPSK	1	0	22.12	21.78	22.01	23	0
10	QPSK	1	25	22.14	21.95	22.09		
10	QPSK	1	49	21.85	22.12	21.96		
10	QPSK	25	0	21.28	20.99	21.25	22	1
10	QPSK	25	12	21.16	21.04	21.14		
10	QPSK	25	25	21.12	21.14	21.18		
10	QPSK	50	0	21.19	21.01	21.21		
10	16QAM	1	0	21.69	21.43	21.33	22	1
10	16QAM	1	25	21.59	21.59	21.47		
10	16QAM	1	49	21.69	21.63	21.49		
10	16QAM	25	0	20.36	19.89	20.35	21	2
10	16QAM	25	12	20.27	19.96	20.27		
10	16QAM	25	25	19.91	19.96	20.32		
10	16QAM	50	0	20.02	20.06	20.02		
Channel				19975	20175	20375	Tune-up limit (dBm)	MPR (dB)
Frequency (MHz)				1712.5	1732.5	1752.5		
5	QPSK	1	0	22.19	22.26	22.18	23	0
5	QPSK	1	12	22.35	22.23	22.09		
5	QPSK	1	24	22.32	22.30	21.98		
5	QPSK	12	0	21.15	21.00	21.15	22	1
5	QPSK	12	7	21.12	21.02	21.18		
5	QPSK	12	13	21.05	21.11	21.10		
5	QPSK	25	0	21.06	21.04	21.22		
5	16QAM	1	0	21.35	21.39	21.49	22	1
5	16QAM	1	12	21.21	21.38	21.64		
5	16QAM	1	24	21.31	21.28	21.46		
5	16QAM	12	0	20.06	19.90	20.13	21	2
5	16QAM	12	7	19.92	19.93	20.08		
5	16QAM	12	13	20.00	20.03	20.09		
5	16QAM	25	0	20.16	20.01	20.41		



Channel				19965	20175	20385	Tune-up limit (dBm)	MPR (dB)
Frequency (MHz)				1711.5	1732.5	1753.5		
3	QPSK	1	0	22.26	22.13	22.33	23	0
3	QPSK	1	8	22.33	22.01	22.21		
3	QPSK	1	14	22.45	22.24	22.05		
3	QPSK	8	0	21.27	21.00	21.19	22	1
3	QPSK	8	4	21.11	21.09	21.06		
3	QPSK	8	7	21.12	21.07	20.96		
3	QPSK	15	0	21.10	20.99	21.06		
3	16QAM	1	0	21.02	21.12	20.99	22	1
3	16QAM	1	8	21.20	20.91	21.02		
3	16QAM	1	14	21.40	21.22	21.24		
3	16QAM	8	0	20.10	19.84	20.24	21	2
3	16QAM	8	4	20.14	20.04	20.22		
3	16QAM	8	7	20.18	19.90	19.90		
3	16QAM	15	0	20.07	19.76	20.16		
Channel				19957	20175	20393	Tune-up limit (dBm)	MPR (dB)
Frequency (MHz)				1710.7	1732.5	1754.3		
1.4	QPSK	1	0	21.94	21.78	21.88	23	0
1.4	QPSK	1	3	22.01	21.90	21.90		
1.4	QPSK	1	5	21.86	21.83	21.75		
1.4	QPSK	3	0	21.94	21.92	22.11		
1.4	QPSK	3	1	22.00	21.95	21.94		
1.4	QPSK	3	3	22.01	21.94	21.92		
1.4	QPSK	6	0	21.09	21.02	21.00	22	1
1.4	16QAM	1	0	20.93	20.99	20.97	22	1
1.4	16QAM	1	3	21.16	21.24	21.21		
1.4	16QAM	1	5	20.98	20.93	20.89		
1.4	16QAM	3	0	21.23	20.90	20.89		
1.4	16QAM	3	1	21.15	21.05	21.03		
1.4	16QAM	3	3	21.18	21.03	21.02		
1.4	16QAM	6	0	19.65	19.80	19.91	21	2



<LTE Band 5>

BW [MHz]	Modulation	RB Size	RB Offset	Power Low Ch. / Freq.	Power Middle Ch. / Freq.	Power High Ch. / Freq.	Tune-up limit (dBm)	MPR (dB)
Channel				20450	20525	20600		
Frequency (MHz)				829	836.5	844		
10	QPSK	1	0	23.90	23.86	23.80	24.5	0
10	QPSK	1	25	23.95	24.10	23.85		
10	QPSK	1	49	23.91	23.70	23.62		
10	QPSK	25	0	22.80	22.97	22.76	23.5	1
10	QPSK	25	12	22.73	22.89	22.64		
10	QPSK	25	25	22.69	22.94	22.65		
10	QPSK	50	0	22.90	23.02	22.89		
10	16QAM	1	0	22.82	23.10	22.81	23.5	1
10	16QAM	1	25	22.70	23.09	22.71		
10	16QAM	1	49	22.71	23.11	22.81		
10	16QAM	25	0	21.84	22.12	21.87	22.5	2
10	16QAM	25	12	21.85	22.18	21.68		
10	16QAM	25	25	21.82	22.16	21.77		
10	16QAM	50	0	21.63	21.91	21.64		
Channel				20425	20525	20625	Tune-up limit (dBm)	MPR (dB)
Frequency (MHz)				826.5	836.5	846.5		
5	QPSK	1	0	23.66	23.83	23.60	24.5	0
5	QPSK	1	12	23.52	23.64	23.85		
5	QPSK	1	24	23.53	23.90	23.82		
5	QPSK	12	0	22.73	22.89	22.65	23.5	1
5	QPSK	12	7	22.49	22.85	22.74		
5	QPSK	12	13	22.57	22.87	22.77		
5	QPSK	25	0	22.70	22.93	22.71		
5	16QAM	1	0	22.98	22.85	23.24	23.5	1
5	16QAM	1	12	22.86	23.00	22.80		
5	16QAM	1	24	22.84	23.18	23.21		
5	16QAM	12	0	21.84	21.75	21.85	22.5	2
5	16QAM	12	7	21.60	21.81	21.93		
5	16QAM	12	13	21.51	21.79	21.65		
5	16QAM	25	0	21.80	21.98	21.68		



Channel				20415	20525	20635	Tune-up limit (dBm)	MPR (dB)
Frequency (MHz)				825.5	836.5	847.5		
3	QPSK	1	0	23.81	23.77	23.71	24.5	0
3	QPSK	1	8	23.54	23.81	23.68		
3	QPSK	1	14	23.65	23.71	23.65		
3	QPSK	8	0	22.62	22.92	22.76	23.5	1
3	QPSK	8	4	22.54	22.88	22.76		
3	QPSK	8	7	22.47	22.89	22.74		
3	QPSK	15	0	22.64	22.84	22.72	23.5	1
3	16QAM	1	0	22.75	22.89	22.99		
3	16QAM	1	8	22.67	23.01	23.03		
3	16QAM	1	14	22.71	23.07	23.00	22.5	2
3	16QAM	8	0	21.78	21.78	21.87		
3	16QAM	8	4	21.69	21.73	21.85		
3	16QAM	8	7	21.59	22.07	21.79	22.5	2
3	16QAM	15	0	21.49	21.94	21.77		
Channel				20407	20525	20643	Tune-up limit (dBm)	MPR (dB)
Frequency (MHz)				824.7	836.5	848.3		
1.4	QPSK	1	0	23.74	23.75	23.65	24.5	0
1.4	QPSK	1	3	23.71	23.94	23.74		
1.4	QPSK	1	5	23.48	23.79	23.66		
1.4	QPSK	3	0	23.74	23.91	23.86		
1.4	QPSK	3	1	23.80	24.07	23.82		
1.4	QPSK	3	3	23.81	23.98	23.71	23.5	1
1.4	QPSK	6	0	22.72	22.86	22.83		
1.4	16QAM	1	0	22.81	23.01	22.85	23.5	1
1.4	16QAM	1	3	22.73	22.92	22.85		
1.4	16QAM	1	5	22.75	22.63	22.70		
1.4	16QAM	3	0	22.89	22.71	22.96		
1.4	16QAM	3	1	22.83	23.00	22.98		
1.4	16QAM	3	3	22.67	22.78	22.85	22.5	2
1.4	16QAM	6	0	21.46	21.76	21.74		



<LTE Band 7>

BW [MHz]	Modulation	RB Size	RB Offset	Power Low Ch. / Freq.	Power Middle Ch. / Freq.	Power High Ch. / Freq.	Tune-up limit (dBm)	MPR (dB)
Channel				20850	21100	21350		
Frequency (MHz)				2510	2535	2560		
20	QPSK	1	0	23.04	23.10	22.95	24	0
20	QPSK	1	49	23.01	23.03	22.83		
20	QPSK	1	99	22.91	22.94	22.89		
20	QPSK	50	0	22.00	22.02	21.79	23	1
20	QPSK	50	24	21.82	21.82	21.69		
20	QPSK	50	50	21.86	21.76	21.65		
20	QPSK	100	0	21.92	21.95	21.77	23	1
20	16QAM	1	0	22.05	22.31	22.21		
20	16QAM	1	49	21.98	21.96	22.08		
20	16QAM	1	99	21.92	21.81	21.97	22	2
20	16QAM	50	0	21.08	20.99	20.82		
20	16QAM	50	24	20.92	20.86	20.74		
20	16QAM	50	50	20.96	21.05	20.70	22	2
20	16QAM	100	0	21.01	20.88	20.90		
Channel				20825	21100	21375		
Frequency (MHz)				2507.5	2535	2562.5		
15	QPSK	1	0	23.09	22.95	22.90	24	0
15	QPSK	1	37	22.89	22.81	22.80		
15	QPSK	1	74	22.92	22.90	22.67		
15	QPSK	36	0	21.91	21.85	21.76	23	1
15	QPSK	36	20	21.89	21.77	21.75		
15	QPSK	36	39	21.87	21.73	21.63		
15	QPSK	75	0	21.85	21.80	21.80	23	1
15	16QAM	1	0	21.97	21.99	21.88		
15	16QAM	1	37	21.57	21.92	21.83		
15	16QAM	1	74	21.82	21.67	21.68	22	2
15	16QAM	36	0	21.00	20.73	20.82		
15	16QAM	36	20	20.91	20.73	20.86		
15	16QAM	36	39	20.93	20.67	20.58	22	2
15	16QAM	75	0	20.82	20.92	20.81		



Channel				20800	21100	21400	Tune-up limit (dBm)	MPR (dB)
Frequency (MHz)				2505	2535	2565		
10	QPSK	1	0	22.88	22.89	22.97	24	0
10	QPSK	1	25	22.90	22.79	22.83		
10	QPSK	1	49	22.68	22.99	22.77		
10	QPSK	25	0	21.93	21.91	21.95	23	1
10	QPSK	25	12	21.85	21.76	21.69		
10	QPSK	25	25	21.80	21.75	21.58		
10	QPSK	50	0	21.85	21.80	21.73	23	1
10	16QAM	1	0	22.11	21.79	22.24		
10	16QAM	1	25	22.17	21.83	22.03		
10	16QAM	1	49	22.05	21.86	21.89	22	2
10	16QAM	25	0	21.00	21.06	21.11		
10	16QAM	25	12	20.76	20.99	20.93		
10	16QAM	25	25	20.76	20.91	20.75	22	2
10	16QAM	50	0	20.99	20.82	20.82		
Channel				20775	21100	21425	Tune-up limit (dBm)	MPR (dB)
Frequency (MHz)				2502.5	2535	2567.5		
5	QPSK	1	0	22.85	22.82	22.72	24	0
5	QPSK	1	12	22.81	22.66	22.63		
5	QPSK	1	24	22.73	22.88	22.70		
5	QPSK	12	0	21.78	21.80	21.73	23	1
5	QPSK	12	7	21.90	21.80	21.57		
5	QPSK	12	13	21.86	21.75	21.54		
5	QPSK	25	0	21.87	21.78	21.69	23	1
5	16QAM	1	0	22.26	21.91	21.88		
5	16QAM	1	12	22.05	21.98	21.89		
5	16QAM	1	24	21.88	22.37	21.97	22	2
5	16QAM	12	0	20.81	20.69	20.84		
5	16QAM	12	7	20.96	20.69	20.76		
5	16QAM	12	13	20.77	20.63	20.56	22	2
5	16QAM	25	0	21.25	20.83	20.71		

<LTE Band 12>

BW [MHz]	Modulation	RB Size	RB Offset	Power Low Ch. / Freq.	Power Middle Ch. / Freq.	Power High Ch. / Freq.	Tune-up limit (dBm)	MPR (dB)
Channel				23060	23095	23130		
Frequency (MHz)				704	707.5	711		
10	QPSK	1	0	23.34	23.30	23.48	24	0
10	QPSK	1	25	23.43	23.20	23.67		
10	QPSK	1	49	23.40	23.35	23.53		
10	QPSK	25	0	22.55	22.50	22.69	23	1
10	QPSK	25	12	22.40	22.38	22.63		
10	QPSK	25	25	22.46	22.43	22.60		
10	QPSK	50	0	22.47	22.45	22.68	23	1
10	16QAM	1	0	22.72	22.49	22.62		
10	16QAM	1	25	22.56	22.47	22.66		
10	16QAM	1	49	22.83	22.51	22.78	22	2
10	16QAM	25	0	21.41	21.56	21.81		
10	16QAM	25	12	21.46	21.44	21.71		
10	16QAM	25	25	21.50	21.78	21.89	22	2
10	16QAM	50	0	21.55	21.56	21.68		
Channel				23035	23095	23155		
Frequency (MHz)				701.5	707.5	713.5	Tune-up limit (dBm)	MPR (dB)
5	QPSK	1	0	23.38	23.37	23.39		
5	QPSK	1	12	23.62	23.28	23.38		
5	QPSK	1	24	23.47	23.40	23.29	24	0
5	QPSK	12	0	22.54	22.40	22.63		
5	QPSK	12	7	22.50	22.56	22.56		
5	QPSK	12	13	22.40	22.60	22.47	23	1
5	QPSK	25	0	22.44	22.51	22.54		
5	16QAM	1	0	22.63	22.71	22.68		
5	16QAM	1	12	22.27	22.64	22.71	23	1
5	16QAM	1	24	22.35	22.49	22.66		
5	16QAM	12	0	21.43	21.32	21.41		
5	16QAM	12	7	21.48	21.30	21.45	22	2
5	16QAM	12	13	21.46	21.45	21.54		
5	16QAM	25	0	21.52	21.45	21.62		



Channel				23025	23095	23165	Tune-up limit (dBm)	MPR (dB)
Frequency (MHz)				700.5	707.5	714.5		
3	QPSK	1	0	23.40	23.33	23.60	24	0
3	QPSK	1	8	23.59	23.61	23.60		
3	QPSK	1	14	23.60	23.51	23.40		
3	QPSK	8	0	22.43	22.42	22.55	23	1
3	QPSK	8	4	22.50	22.57	22.47		
3	QPSK	8	7	22.52	22.46	22.50		
3	QPSK	15	0	22.38	22.46	22.43	23	1
3	16QAM	1	0	22.61	22.55	22.51		
3	16QAM	1	8	22.64	22.50	22.40		
3	16QAM	1	14	22.63	22.45	22.37	22	2
3	16QAM	8	0	21.27	21.19	21.65		
3	16QAM	8	4	21.49	21.39	21.39		
3	16QAM	8	7	21.63	21.62	21.44	22	2
3	16QAM	15	0	21.63	21.47	21.37		
Channel				23017	23095	23173	Tune-up limit (dBm)	MPR (dB)
Frequency (MHz)				699.7	707.5	715.3		
1.4	QPSK	1	0	23.30	23.37	23.31	24	0
1.4	QPSK	1	3	23.40	23.40	23.44		
1.4	QPSK	1	5	23.38	23.31	23.33		
1.4	QPSK	3	0	23.47	23.39	23.35		
1.4	QPSK	3	1	23.55	23.56	23.31		
1.4	QPSK	3	3	23.40	23.44	23.41	23	1
1.4	QPSK	6	0	22.49	22.48	22.45		
1.4	16QAM	1	0	22.86	22.49	22.55	23	1
1.4	16QAM	1	3	22.88	22.73	22.49		
1.4	16QAM	1	5	22.89	22.46	22.46		
1.4	16QAM	3	0	22.48	22.55	22.57		
1.4	16QAM	3	1	22.63	22.54	22.53		
1.4	16QAM	3	3	22.61	22.65	22.74	22	2
1.4	16QAM	6	0	21.32	21.40	21.30		



<LTE Band 13>

BW [MHz]	Modulation	RB Size	RB Offset	Power Low Ch. / Freq.	Power Middle Ch. / Freq.	Power High Ch. / Freq.	Tune-up limit (dBm)	MPR (dB)
Channel				23230				
Frequency (MHz)				782				
10	QPSK	1	0		23.62		24	0
10	QPSK	1	25		23.44			
10	QPSK	1	49		23.31			
10	QPSK	25	0		22.38		23	1
10	QPSK	25	12		22.26			
10	QPSK	25	25		22.24			
10	QPSK	50	0		22.28		23	1
10	16QAM	1	0		22.34			
10	16QAM	1	25		22.34			
10	16QAM	1	49		22.47		22	2
10	16QAM	25	0		21.39			
10	16QAM	25	12		21.18			
10	16QAM	25	25		21.27		22	2
10	16QAM	50	0		21.33			
Channel				23205	23230	23255		
Frequency (MHz)				779.5	782	784.5		
5	QPSK	1	0	23.52	23.40	23.34	24	0
5	QPSK	1	12	23.60	23.51	23.54		
5	QPSK	1	24	23.34	23.28	23.60		
5	QPSK	12	0	22.57	22.37	22.24	23	1
5	QPSK	12	7	22.53	22.32	22.25		
5	QPSK	12	13	22.30	22.30	22.19		
5	QPSK	25	0	22.33	22.32	22.25	23	1
5	16QAM	1	0	22.32	22.28	22.55		
5	16QAM	1	12	22.11	22.08	22.12		
5	16QAM	1	24	22.10	22.15	22.51	22	2
5	16QAM	12	0	21.48	21.33	21.24		
5	16QAM	12	7	21.48	21.31	21.12		
5	16QAM	12	13	21.35	21.30	21.11	22	2
5	16QAM	25	0	21.54	21.49	21.26		



<LTE Band 17>

BW [MHz]	Modulation	RB Size	RB Offset	Power Low Ch. / Freq.	Power Middle Ch. / Freq.	Power High Ch. / Freq.	Tune-up limit (dBm)	MPR (dB)
Channel				23780	23790	23800		
Frequency (MHz)				709	710	711		
10	QPSK	1	0	23.51	23.59	23.50	24	0
10	QPSK	1	25	23.68	23.73	23.59		
10	QPSK	1	49	23.50	23.54	23.39		
10	QPSK	25	0	22.57	22.65	22.50	23	1
10	QPSK	25	12	22.51	22.63	22.48		
10	QPSK	25	25	22.50	22.60	22.38		
10	QPSK	50	0	22.56	22.58	22.44	23	1
10	16QAM	1	0	22.76	22.69	22.69		
10	16QAM	1	25	22.89	23.00	22.98		
10	16QAM	1	49	22.79	22.85	22.77	22	2
10	16QAM	25	0	21.51	21.59	21.62		
10	16QAM	25	12	21.50	21.54	21.50		
10	16QAM	25	25	21.54	21.62	21.32	22	2
10	16QAM	50	0	21.68	21.61	21.37		
Channel				23755	23790	23825		
Frequency (MHz)				706.5	710	713.5	Tune-up limit (dBm)	MPR (dB)
5	QPSK	1	0	23.41	23.39	23.53	24	0
5	QPSK	1	12	23.29	23.67	23.56		
5	QPSK	1	24	23.30	23.51	23.27		
5	QPSK	12	0	22.29	22.39	22.47	23	1
5	QPSK	12	7	22.30	22.44	22.36		
5	QPSK	12	13	22.42	22.41	22.34		
5	QPSK	25	0	22.37	22.48	22.49	23	1
5	16QAM	1	0	22.66	22.46	22.59		
5	16QAM	1	12	22.55	22.45	22.62		
5	16QAM	1	24	22.49	22.38	22.58	22	2
5	16QAM	12	0	21.33	21.44	21.27		
5	16QAM	12	7	21.34	21.42	21.35		
5	16QAM	12	13	21.47	21.47	21.18	22	2
5	16QAM	25	0	21.48	21.53	21.26		

<WLAN Conducted Power>

General Note:

1. Per KDB 248227 D01v02r02, SAR test reduction is determined according to 802.11 transmission mode configurations and certain exposure conditions with multiple test positions. In the 2.4 GHz band, separate SAR procedures are applied to DSSS and OFDM configurations to simplify DSSS test requirements. For OFDM, in both 2.4 and 5 GHz bands, an initial test configuration must be determined for each standalone and aggregated frequency band, according to the transmission mode configuration with the highest maximum output power specified for production units to perform SAR measurements. If the same highest maximum output power applies to different combinations of channel bandwidths, modulations and data rates, additional procedures are applied to determine which test configurations require SAR measurement. When applicable, an initial test position may be applied to reduce the number of SAR measurements required for next to the ear, UMPC mini-tablet or hotspot mode configurations with multiple test positions.
2. For 2.4 GHz 802.11b DSSS, either the initial test position procedure for multiple exposure test positions or the DSSS procedure for fixed exposure position is applied; these are mutually exclusive. For 2.4 GHz and 5 GHz OFDM configurations, the initial test configuration is applied to measure SAR using either the initial test position procedure for multiple exposure test position configurations or the initial test configuration procedures for fixed exposure test conditions. Based on the reported SAR of the measured configurations and maximum output power of the transmission mode configurations that are not included in the initial test configuration, the subsequent test configuration and initial test position procedures are applied to determine if SAR measurements are required for the remaining OFDM transmission configurations. In general, the number of test channels that require SAR measurement is minimized based on maximum output power measured for the test sample(s).
3. For OFDM transmission configurations in the 2.4 GHz and 5 GHz bands, When the same maximum power is specified for multiple transmission modes in a frequency band, the largest channel bandwidth, lowest order modulation, lowest data rate and lowest order 802.11a/g/n/ac mode is used for SAR measurement, on the highest measured output power channel for each frequency band.
4. DSSS and OFDM configurations are considered separately according to the required SAR procedures. SAR is measured in the initial test position using the 802.11 transmission mode configuration required by the DSSS procedure or initial test configuration and subsequent test configuration(s) according to the OFDM procedures.¹⁸ The initial test position procedure is described in the following:
 - a. When the reported SAR of the initial test position is ≤ 0.4 W/kg, further SAR measurement is not required for the other test positions in that exposure configuration and 802.11 transmission mode combinations within the frequency band or aggregated band.
 - b. When the reported SAR of the test position is > 0.4 W/kg, SAR is repeated for the 802.11 transmission mode configuration tested in the initial test position to measure the subsequent next closet/smallest test separation distance and maximum coupling test position on the highest maximum output power channel, until the report SAR is ≤ 0.8 W/kg or all required test position are tested.
 - c. For all positions/configurations, when the reported SAR is > 0.8 W/kg, SAR is measured for these test positions/configurations on the subsequent next highest measured output power channel(s) until the reported SAR is ≤ 1.2 W/kg or all required channels are tested.

<2.4GHz WLAN>

2.4GHz WLAN	Mode	Channel	Frequency (MHz)	Average power (dBm)	Tune-Up Limit (dBm)	Duty Cycle %
	802.11b 1Mbps	1	2412	15.89	16.50	97.93
		6	2437	15.97	16.50	
		11	2462	16.14	16.50	
	802.11g 6Mbps	1	2412	14.86	15.50	87.72
		6	2437	15.12	15.50	
		10	2457	13.65	14.00	
		11	2462	10.77	11.00	
	802.11n-HT20 MCS0	1	2412	14.06	15.00	86.70
		6	2437	14.42	15.00	
10		2457	13.57	14.00		
11		2462	9.93	10.00		
802.11n-HT40 MCS0	3	2422	13.76	14.00	76.12	
	6	2437	14.08	15.00		
	8	2447	11.53	12.00		
	9	2452	9.38	10.00		



<5GHz WLAN >

	Mode	Channel	Frequency (MHz)	Average power (dBm)	Tune-Up Limit (dBm)	Duty Cycle %
5.2GHz WLAN	802.11a 6Mbps	36	5180	15.03	15.50	87.44
		40	5200	15.00	15.50	
		44	5220	14.92	15.50	
		48	5240	14.79	15.50	
	802.11n-HT20 MCS0	36	5180	11.90	12.00	86.72
		40	5200	11.89	12.00	
		44	5220	11.89	12.00	
		48	5240	11.83	12.00	
	802.11n-HT40 MCS0	38	5190	11.91	12.00	76.39
		46	5230	11.89	12.00	

	Mode	Channel	Frequency (MHz)	Average power (dBm)	Tune-Up Limit (dBm)	Duty Cycle %
5.8GHz WLAN	802.11a MCS0	149	5745	14.92	15.50	87.44
		157	5785	14.74	15.50	
		165	5825	14.59	15.50	
	802.11n-HT20 MCS0	149	5745	11.95	12.50	86.72
		157	5785	11.79	12.50	
		165	5825	11.75	12.50	
	802.11n-HT40 MCS0	151	5755	11.86	12.50	76.39
		159	5795	11.68	12.50	

<2.4GHz Bluetooth>

General Note:

1. For 2.4GHz Bluetooth SAR testing was selected 1Mbps, due to its highest average power.
2. The Bluetooth duty cycle is 76.83 %, according to 2016 Oct. TCB workshop for Bluetooth SAR scaling need further consideration and the theoretical duty cycle is 83.3%, therefore the actual duty cycle will be scaled up to the theoretical value of Bluetooth reported SAR calculation

Mode	Channel	Frequency (MHz)	Average power (dBm)
			1Mbps
BR/EDR	CH 00	2402	9.23
	CH 39	2441	10.77
	CH 78	2480	9.46
Tune-up limit (dBm)			11.00

Mode	Channel	Frequency (MHz)	Average power (dBm)
			GFSK
LE	CH 00	2402	0.82
	CH 19	2440	2.52
	CH 39	2480	1.09
Tune-up Limit			3.00

13. Antenna Location

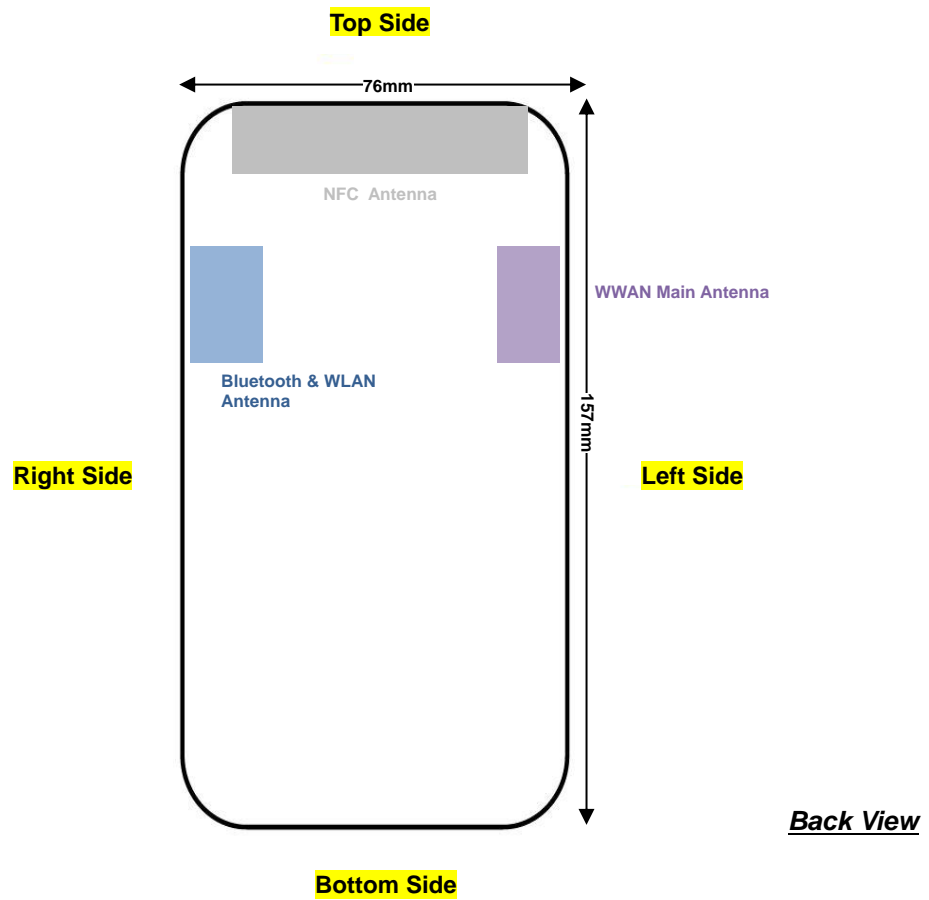

14. SAR Test Results

General Note:

1. Per KDB 447498 D01v06, the reported SAR is the measured SAR value adjusted for maximum tune-up tolerance.
 - a. Tune-up scaling Factor = tune-up limit power (mW) / EUT RF power (mW), where tune-up limit is the maximum rated power among all production units.
 - b. For SAR testing of WLAN signal with non-100% duty cycle, the measured SAR is scaled-up by the duty cycle scaling factor which is equal to "1/(duty cycle)"
 - c. For WWAN: Reported SAR(W/kg)= Measured SAR(W/kg)*Tune-up Scaling Factor
 - d. For WLAN/Bluetooth: Reported SAR(W/kg)= Measured SAR(W/kg)* Duty Cycle scaling factor * Tune-up scaling factor
2. Per KDB 447498 D01v06, for each exposure position, testing of other required channels within the operating mode of a frequency band is not required when the *reported* 1-g or 10-g SAR for the mid-band or highest output power channel is:
 - ≤ 0.8 W/kg or 2.0 W/kg, for 1-g or 10-g respectively, when the transmission band is ≤ 100 MHz
 - ≤ 0.6 W/kg or 1.5 W/kg, for 1-g or 10-g respectively, when the transmission band is between 100 MHz and 200 MHz
 - ≤ 0.4 W/kg or 1.0 W/kg, for 1-g or 10-g respectively, when the transmission band is ≥ 200 MHz
3. Per KDB 865664 D01v01r04, for each frequency band, repeated SAR measurement is required only when the measured SAR is ≥ 0.8 W/kg.

WCDMA Note:

1. Per KDB 941225 D01v03r01, for SAR testing is measured using a 12.2 kbps RMC with TPC bits configured to all "1's".
2. Per KDB 941225 D01v03r01, RMC 12.2kbps setting is used to evaluate SAR. The maximum output power and tune-up tolerance specified for production units in HSDPA / HSUPA / DC-HSDPA is $\leq 1/4$ dB higher than RMC 12.2Kbps or when the highest reported SAR of the RMC12.2Kbps is scaled by the ratio of specified maximum output power and tune-up tolerance of HSDPA / HSUPA / DC-HSDPA to RMC12.2Kbps and the adjusted SAR is ≤ 1.2 W/kg, SAR measurement is not required for HSDPA / HSUPA / DC-HSDPA, and according to the following RF output power, the output power results of the secondary modes (HSUPA, HSDPA, DC-HSDPA, DC-HSDPA) are less than $1/4$ dB higher than the primary modes; therefore, SAR measurement is not required for HSDPA / HSUPA / DC-HSDPA.

LTE Note:

1. Per KDB 941225 D05v02r05, start with the largest channel bandwidth and measure SAR for QPSK with 1 RB allocation, using the RB offset and required test channel combination with the highest maximum output power for RB offsets at the upper edge, middle and lower edge of each required test channel.
2. Per KDB 941225 D05v02r05, 50% RB allocation for QPSK SAR testing follows 1RB QPSK allocation procedure.
3. Per KDB 941225 D05v02r05, for QPSK with 100% RB allocation, SAR is not required when the highest maximum output power for 100 % RB allocation is less than the highest maximum output power in 50% and 1 RB allocations and the highest reported SAR for 1 RB and 50% RB allocation are ≤ 0.8 W/kg. Otherwise, SAR is measured for the highest output power channel; and if the reported SAR is > 1.45 W/kg, the remaining required test channels must also be tested.
4. Per KDB 941225 D05v02r05, 16QAM output power for each RB allocation configuration is $> 1/2$ dB higher than the same configuration in QPSK and the reported SAR for the QPSK configuration is ≤ 1.45 W/kg; Per KDB 941225 D05v02r05, 16QAM SAR testing is not required.
5. Per KDB 941225 D05v02r05, smaller bandwidth output power for each RB allocation configuration is $> 1/2$ dB higher than the same configuration in the largest supported bandwidth, and the reported SAR for the largest supported bandwidth is ≤ 1.45 W/kg; Per KDB 941225 D05v02r05, smaller bandwidth SAR testing is not required.
6. For LTE B4 / B5 / B12 the maximum bandwidth does not support three non-overlapping channels, per KDB 941225 D05v02r05, when a device supports overlapping channel assignment in a channel bandwidth configuration, the middle channel of the group of overlapping channels should be selected for testing.
7. LTE band 17 SAR test was covered by Band 12; according to TCB workshop, SAR test for overlapping LTE bands can be reduced if
 - a. The maximum output power, including tolerance, for the smaller band is \leq the larger band to qualify for the SAR test exclusion.
 - b. The channel bandwidth and other operating parameters for the smaller band are fully supported by the larger band.



WLAN Note:

1. Per KDB 248227 D01v02r02, for 2.4GHz 802.11g/n SAR testing is not required when the highest reported SAR for DSSS is adjusted by the ratio of OFDM to DSSS specified maximum output power and the adjusted SAR is ≤ 1.2 W/kg.
2. When the reported SAR of the test position is > 0.4 W/kg, SAR is repeated for the 802.11 transmission mode configuration tested in the initial test position to measure the subsequent next closet/smallest test separation distance and maximum coupling test position on the highest maximum output power channel, until the report SAR is ≤ 0.8 W/kg or all required test position are tested.
3. For all positions / configurations, when the reported SAR is > 0.8 W/kg, SAR is measured for these test positions / configurations on the subsequent next highest measured output power channel(s) until the reported SAR is ≤ 1.2 W/kg or all required channels are tested.
4. During SAR testing the WLAN transmission was verified using a spectrum analyzer.



14.1 Body SAR

<WCDMA SAR>

Plot No.	Band	Mode	Test Position	Gap (mm)	Ch.	Freq. (MHz)	Average Power (dBm)	Tune-Up Limit (dBm)	Tune-up Scaling Factor	Power Drift (dB)	Measured 1g SAR (W/kg)	Reported 1g SAR (W/kg)
	WCDMA Band V	RMC 12.2Kbps	Front	0	4182	836.4	23.69	24.00	1.074	-0.03	0.623	0.669
	WCDMA Band V	RMC 12.2Kbps	Back	0	4182	836.4	23.69	24.00	1.074	0.05	0.154	0.165
01	WCDMA Band V	RMC 12.2Kbps	Front	0	4132	826.4	23.50	24.00	1.122	0.03	0.667	0.748
	WCDMA Band V	RMC 12.2Kbps	Front	0	4233	846.6	23.57	24.00	1.104	0.01	0.550	0.607
02	WCDMA Band IV	RMC 12.2Kbps	Front	0	1312	1712.4	21.89	22.00	1.026	-0.06	0.225	0.231
	WCDMA Band IV	RMC 12.2Kbps	Back	0	1312	1712.4	21.89	22.00	1.026	0.01	0.073	0.074
	WCDMA Band IV	RMC 12.2Kbps	Front	0	1413	1732.6	21.83	22.00	1.040	0.05	0.201	0.209
	WCDMA Band IV	RMC 12.2Kbps	Front	0	1513	1752.6	21.85	22.00	1.035	-0.1	0.193	0.200
03	WCDMA Band II	RMC 12.2Kbps	Front	0	9262	1852.4	22.67	23.00	1.079	-0.01	0.175	0.189
	WCDMA Band II	RMC 12.2Kbps	Back	0	9262	1852.4	22.67	23.00	1.079	0.08	0.061	0.065
	WCDMA Band II	RMC 12.2Kbps	Front	0	9400	1880	22.55	23.00	1.109	-0.05	0.166	0.184
	WCDMA Band II	RMC 12.2Kbps	Front	0	9538	1907.6	22.61	23.00	1.094	0.07	0.159	0.174



<LTE SAR>

Plot No.	Band	BW (MHz)	Modulation	RB Size	RB Offset	Test Position	Gap (mm)	Ch.	Freq. (MHz)	Average Power (dBm)	Tune-Up Limit (dBm)	Tune-up Scaling Factor	Power Drift (dB)	Measured 1g SAR (W/kg)	Reported 1g SAR (W/kg)
04	LTE Band 5	10M	QPSK	1	25	Front	0	20525	836.5	24.10	24.50	1.096	-0.17	0.609	0.668
	LTE Band 5	10M	QPSK	1	25	Back	0	20525	836.5	24.10	24.50	1.096	-0.1	0.135	0.148
	LTE Band 5	10M	QPSK	25	0	Front	0	20525	836.5	22.97	23.50	1.130	0.01	0.541	0.611
	LTE Band 5	10M	QPSK	25	0	Back	0	20525	836.5	22.97	23.50	1.130	-0.15	0.129	0.146
05	LTE Band 12	10M	QPSK	1	25	Front	0	23095	707.5	23.20	24.00	1.202	0.05	1.030	1.238
	LTE Band 12	10M	QPSK	1	25	Back	0	23095	707.5	23.20	24.00	1.202	0.01	0.331	0.398
	LTE Band 12	10M	QPSK	25	0	Front	0	23095	707.5	22.50	23.00	1.122	-0.1	0.884	0.992
	LTE Band 12	10M	QPSK	25	0	Back	0	23095	707.5	22.50	23.00	1.122	0.03	0.279	0.313
	LTE Band 12	10M	QPSK	50	0	Front	0	23095	707.5	22.45	23.00	1.135	0.04	0.776	0.881
06	LTE Band 13	10M	QPSK	1	0	Front	0	23230	782	23.62	24.00	1.091	0.19	1.050	1.146
	LTE Band 13	10M	QPSK	1	0	Back	0	23230	782	23.62	24.00	1.091	0.15	0.255	0.278
	LTE Band 13	10M	QPSK	25	0	Front	0	23230	782	22.38	23.00	1.153	-0.11	0.925	1.067
	LTE Band 13	10M	QPSK	25	0	Back	0	23230	782	22.38	23.00	1.153	0.07	0.205	0.236
	LTE Band 13	10M	QPSK	50	0	Front	0	23230	782	22.28	23.00	1.180	-0.03	0.865	1.021
07	LTE Band 4	20M	QPSK	1	49	Front	0	20175	1732.5	22.47	23.00	1.130	-0.01	0.219	0.247
	LTE Band 4	20M	QPSK	1	49	Back	0	20175	1732.5	22.47	23.00	1.130	0.03	0.063	0.071
	LTE Band 4	20M	QPSK	50	0	Front	0	20175	1732.5	21.34	22.00	1.164	0.05	0.179	0.208
	LTE Band 4	20M	QPSK	50	0	Back	0	20175	1732.5	21.34	22.00	1.164	0.01	0.052	0.060
	LTE Band 2	20M	QPSK	1	0	Front	0	18900	1880	22.82	23.00	1.042	0.06	0.175	0.182
	LTE Band 2	20M	QPSK	1	0	Back	0	18900	1880	22.82	23.00	1.042	0.05	0.056	0.058
	LTE Band 2	20M	QPSK	1	0	Front	0	18700	1860	22.70	23.00	1.072	0.04	0.170	0.182
08	LTE Band 2	20M	QPSK	1	0	Front	0	19100	1900	22.71	23.00	1.069	0.05	0.181	0.193
	LTE Band 2	20M	QPSK	50	0	Front	0	18900	1880	21.58	22.00	1.102	0.03	0.141	0.155
	LTE Band 2	20M	QPSK	50	0	Back	0	18900	1880	21.58	22.00	1.102	-0.01	0.046	0.050
	LTE Band 2	20M	QPSK	50	0	Front	0	18700	1860	21.57	22.00	1.104	0.07	0.142	0.157
	LTE Band 2	20M	QPSK	50	0	Front	0	19100	1900	21.51	22.00	1.119	0.13	0.140	0.157
09	LTE Band 7	20M	QPSK	1	0	Front	0	21100	2535	23.10	24.00	1.230	-0.05	0.220	0.271
	LTE Band 7	20M	QPSK	1	0	Back	0	21100	2535	23.10	24.00	1.230	0.01	0.062	0.077
	LTE Band 7	20M	QPSK	1	0	Front	0	20850	2510	23.04	24.00	1.247	-0.05	0.213	0.266
	LTE Band 7	20M	QPSK	1	0	Front	0	21350	2560	22.95	24.00	1.274	0.03	0.212	0.270
	LTE Band 7	20M	QPSK	50	0	Front	0	21100	2535	22.02	23.00	1.253	0.07	0.163	0.204
	LTE Band 7	20M	QPSK	50	0	Back	0	21100	2535	22.02	23.00	1.253	-0.02	0.053	0.067
	LTE Band 7	20M	QPSK	50	0	Front	0	20850	2510	22.00	23.00	1.259	0.13	0.167	0.210
	LTE Band 7	20M	QPSK	50	0	Front	0	21350	2560	21.79	23.00	1.321	-0.11	0.156	0.206

<WLAN2.4GHz SAR>

Plot No.	Band	Mode	Test Position	Gap (mm)	Ch.	Freq. (MHz)	Average Power (dBm)	Tune-Up Limit (dBm)	Tune-up Scaling Factor	Duty Cycle %	Duty Cycle Scaling Factor	Power Drift (dB)	Measured 1g SAR (W/kg)	Reported 1g SAR (W/kg)
	WLAN2.4GHz	802.11b 1Mbps	Front	0	11	2462	16.14	16.50	1.086	97.93	1.021	0.06	0.173	0.192
	WLAN2.4GHz	802.11b 1Mbps	Back	0	11	2462	16.14	16.50	1.086	97.93	1.021	-0.05	0.098	0.109
10	WLAN2.4GHz	802.11b 1Mbps	Front	0	1	2412	15.89	16.50	1.151	97.93	1.021	-0.01	0.168	0.197
	WLAN2.4GHz	802.11b 1Mbps	Front	0	6	2437	15.97	16.50	1.130	97.93	1.021	0.13	0.160	0.185

<WLAN5GHz SAR>

Plot No.	Band	Mode	Test Position	Gap (mm)	Ch.	Freq. (MHz)	Average Power (dBm)	Tune-Up Limit (dBm)	Tune-up Scaling Factor	Duty Cycle %	Duty Cycle Scaling Factor	Power Drift (dB)	Measured 1g SAR (W/kg)	Reported 1g SAR (W/kg)
	WLAN5.2GHz	802.11a 6Mbps	Front	0	36	5180	15.03	15.50	1.114	87.44	1.144	0.11	0.027	0.034
	WLAN5.2GHz	802.11a 6Mbps	Back	0	36	5180	15.03	15.50	1.114	87.44	1.144	0.15	0.015	0.019
	WLAN5.2GHz	802.11a 6Mbps	Front	0	40	5200	15.00	15.50	1.122	87.44	1.144	0.07	0.025	0.032
	WLAN5.2GHz	802.11a 6Mbps	Front	0	44	5220	14.92	15.50	1.143	87.44	1.144	-0.09	0.031	0.041
11	WLAN5.2GHz	802.11a 6Mbps	Front	0	48	5240	14.79	15.50	1.178	87.44	1.144	-0.02	0.032	0.043
	WLAN5.8GHz	802.11a 6Mbps	Front	0	149	5745	14.92	15.50	1.143	87.44	1.144	0.01	0.102	0.133
	WLAN5.8GHz	802.11a 6Mbps	Back	0	149	5745	14.92	15.50	1.143	87.44	1.144	0.03	0.042	0.055
12	WLAN5.8GHz	802.11a 6Mbps	Front	0	157	5785	14.74	15.50	1.191	87.44	1.144	-0.05	0.116	0.158
	WLAN5.8GHz	802.11a 6Mbps	Front	0	165	5825	14.59	15.50	1.233	87.44	1.144	-0.09	0.097	0.137

<Bluetooth SAR>

Plot No.	Band	Mode	Test Position	Gap (mm)	Ch.	Freq. (MHz)	Average Power (dBm)	Tune-Up Limit (dBm)	Tune-up Scaling Factor	Duty Cycle %	Duty Cycle Scaling Factor	Power Drift (dB)	Measured 1g SAR (W/kg)	Reported 1g SAR (W/kg)
	Bluetooth	1Mbps	Front	0	39	2441	10.77	11.00	1.054	76.83	1.084	0.02	0.025	0.029
	Bluetooth	1Mbps	Back	0	39	2441	10.77	11.00	1.054	76.83	1.084	0.14	0.011	0.013
13	Bluetooth	1Mbps	Front	0	0	2402	9.23	11.00	1.503	76.83	1.084	-0.07	0.022	0.036
	Bluetooth	1Mbps	Front	0	78	2480	9.46	11.00	1.426	76.83	1.084	-0.05	0.022	0.034

14.2 Repeated SAR Measurement

No.	Band	BW (MHz)	Modulation	RB Size	RB offset	Test Position	Gap (mm)	Ch.	Freq. (MHz)	Average Power (dBm)	Tune-Up Limit (dBm)	Tune-up Scaling Factor	Power Drift (dB)	Measured 1g SAR (W/kg)	Ratio	Reported 1g SAR (W/kg)
1st	LTE Band 13	10M	QPSK	1	0	Front	0	23230	782	23.62	24.00	1.091	0.19	1.050	1	1.146
2nd	LTE Band 13	10M	QPSK	1	0	Front	0	23230	782	23.62	24.00	1.091	0.09	0.976	1.076	1.065

General Note:

1. Per KDB 865664 D01v01r04, for each frequency band, repeated SAR measurement is required only when the measured SAR is $\geq 0.8W/kg$.
2. Per KDB 865664 D01v01r04, if the ratio among the repeated measurement is ≤ 1.2 and the measured SAR $< 1.45W/kg$, only one repeated measurement is required.
3. The ratio is the difference in percentage between original and repeated *measured SAR*.
4. All measurement SAR result is scaled-up to account for tune-up tolerance and is compliant.

15. Simultaneous Transmission Analysis

NO.	Simultaneous Transmission Configurations	Body
1.	WCDMA + WLAN2.4GHz	Yes
2.	LTE + WLAN2.4GHz	Yes
3.	WCDMA + WLAN5GHz	Yes
4.	LTE + WLAN5GHz	Yes
5.	WCDMA+ Bluetooth	Yes
6.	LTE + Bluetooth	Yes

General Note:

1. EUT will choose either WCDMA or LTE according to the network signal condition; therefore, they will not operate simultaneously at any moment.
2. WLAN and Bluetooth share the same antenna, and cannot transmit simultaneously.
3. EUT will choose either WLAN 2.4GHz or WLAN 5GHz according to the network signal condition; therefore, 2.4GHz WLAN and 5GHz WLAN will not operate simultaneously at any moment.
4. According to the character of the EUT, WLAN 5GHz and Bluetooth can't transmit simultaneously.
5. Selected the maximum SAR of all WLAN5G to do co-located analysis with WWAN.
6. The reported SAR summation is calculated based on the same configuration and test position.
7. Per KDB 447498 D01v06, simultaneous transmission SAR is compliant if,
 - i) Scalar SAR summation < 1.6W/kg.
 - ii) $SPLSR = (SAR1 + SAR2)^{1.5} / (\text{min. separation distance, mm})$, and the peak separation distance is determined from the square root of $[(x1-x2)^2 + (y1-y2)^2 + (z1-z2)^2]$, where (x1, y1, z1) and (x2, y2, z2) are the coordinates of the extrapolated peak SAR locations in the zoom scan.
 - iii) If $SPLSR \leq 0.04$, simultaneously transmission SAR measurement is not necessary.
 - iv) Simultaneously transmission SAR measurement, and the reported multi-band SAR < 1.6W/kg.

15.1 Body Exposure Conditions

WWAN Band		Exposure Position	1	2	3	4	1+2 Summed 1g SAR (W/kg)	1+3 Summed 1g SAR (W/kg)	1+4 Summed 1g SAR (W/kg)
			WWAN 1g SAR (W/kg)	2.4GHz WLAN 1g SAR (W/kg)	5GHz WLAN 1g SAR (W/kg)	Bluetooth 1g SAR (W/kg)			
WCDMA	Band V	Front	0.748	0.197	0.158	0.036	0.95	0.91	0.78
		Back	0.165	0.109	0.055	0.013	0.27	0.22	0.18
	Band IV	Front	0.231	0.197	0.158	0.036	0.43	0.39	0.27
		Back	0.074	0.109	0.055	0.013	0.18	0.13	0.09
	Band II	Front	0.189	0.197	0.158	0.036	0.39	0.35	0.23
		Back	0.065	0.109	0.055	0.013	0.17	0.12	0.08
LTE	Band 5	Front	0.668	0.197	0.158	0.036	0.87	0.83	0.70
		Back	0.148	0.109	0.055	0.013	0.26	0.20	0.16
	Band 12	Front	1.238	0.197	0.158	0.036	1.44	1.40	1.27
		Back	0.398	0.109	0.055	0.013	0.51	0.45	0.41
	Band 13	Front	1.146	0.197	0.158	0.036	1.34	1.30	1.18
		Back	0.278	0.109	0.055	0.013	0.39	0.33	0.29
	Band 4	Front	0.247	0.197	0.158	0.036	0.44	0.41	0.28
		Back	0.071	0.109	0.055	0.013	0.18	0.13	0.08
	Band 2	Front	0.193	0.197	0.158	0.036	0.39	0.35	0.23
		Back	0.058	0.109	0.055	0.013	0.17	0.11	0.07
	Band 7	Front	0.271	0.197	0.158	0.036	0.47	0.43	0.31
		Back	0.077	0.109	0.055	0.013	0.19	0.13	0.09

Test Engineer : Johnny Chen



16. Uncertainty Assessment

Per KDB 865664 D01 SAR measurement 100MHz to 6GHz, when the highest measured 1-g SAR within a frequency band is < 1.5 W/kg. The expanded SAR measurement uncertainty must be $\leq 30\%$, for a confidence interval of $k = 2$. If these conditions are met, extensive SAR measurement uncertainty analysis described in IEEE Std 1528-2013 is not required in SAR reports submitted for equipment approval. For this device, the highest measured 1-g SAR is less 1.5W/kg. Therefore, the measurement uncertainty table is not required in this report.



17. References

- [1] FCC 47 CFR Part 2 “Frequency Allocations and Radio Treaty Matters; General Rules and Regulations”
- [2] ANSI/IEEE Std. C95.1-1992, “IEEE Standard for Safety Levels with Respect to Human Exposure to Radio Frequency Electromagnetic Fields, 3 kHz to 300 GHz”, September 1992
- [3] IEEE Std. 1528-2013, “IEEE Recommended Practice for Determining the Peak Spatial-Average Specific Absorption Rate (SAR) in the Human Head from Wireless Communications Devices: Measurement Techniques”, Sep 2013
- [4] SPEAG DASY System Handbook
- [5] FCC KDB 248227 D01 v02r02, “SAR Guidance for IEEE 802.11 (WiFi) Transmitters”, Oct 2015.
- [6] FCC KDB 447498 D01 v06, “Mobile and Portable Device RF Exposure Procedures and Equipment Authorization Policies”, Oct 2015
- [7] FCC KDB 941225 D01 v03r01, “3G SAR MEAUREMENT PROCEDURES”, Oct 2015
- [8] FCC KDB 941225 D05 v02r05, “SAR Evaluation Considerations for LTE Devices”, Dec 2015
- [9] FCC KDB 865664 D01 v01r04, "SAR Measurement Requirements for 100 MHz to 6 GHz", Aug 2015.
- [10] FCC KDB 865664 D02 v01r02, “RF Exposure Compliance Reporting and Documentation Considerations” Oct 2015.



Appendix A. Plots of System Performance Check

The plots are shown as follows.

System Check_Body_750MHz

DUT: D750V3-SN:1099

Communication System: UID 0, CW (0); Frequency: 750 MHz; Duty Cycle: 1:1

Medium: MSL_750_190119 Medium parameters used: $f = 750$ MHz; $\sigma = 0.963$ S/m; $\epsilon_r = 54.228$; $\rho = 1000$ kg/m³

Ambient Temperature : 23.4 °C; Liquid Temperature : 22.4 °C

DASY5 Configuration:

- Probe: EX3DV4 - SN3753; ConvF(9.58, 9.58, 9.58); Calibrated: 2018.05.29;
- Sensor-Surface: 2mm (Mechanical Surface Detection)
- Electronics: DAE4 Sn1437; Calibrated: 2018.10.15
- Phantom: ELI v4.0; Type: QDOVA002AA; Serial: TP:1149
- Measurement SW: DASY52, Version 52.8 (8); SEMCAD X Version 14.6.10 (7331)

Pin=250mW/Area Scan (61x61x1): Interpolated grid: dx=15mm, dy=15mm

Maximum value of SAR (interpolated) = 2.79 W/kg

Pin=250mW/Zoom Scan (5x5x7)/Cube 0: Measurement grid: dx=8mm, dy=8mm, dz=5mm

Reference Value = 55.15 V/m; Power Drift = -0.02 dB

Peak SAR (extrapolated) = 3.24 W/kg

SAR(1 g) = 2.23 W/kg; SAR(10 g) = 1.5 W/kg

Maximum value of SAR (measured) = 2.79 W/kg

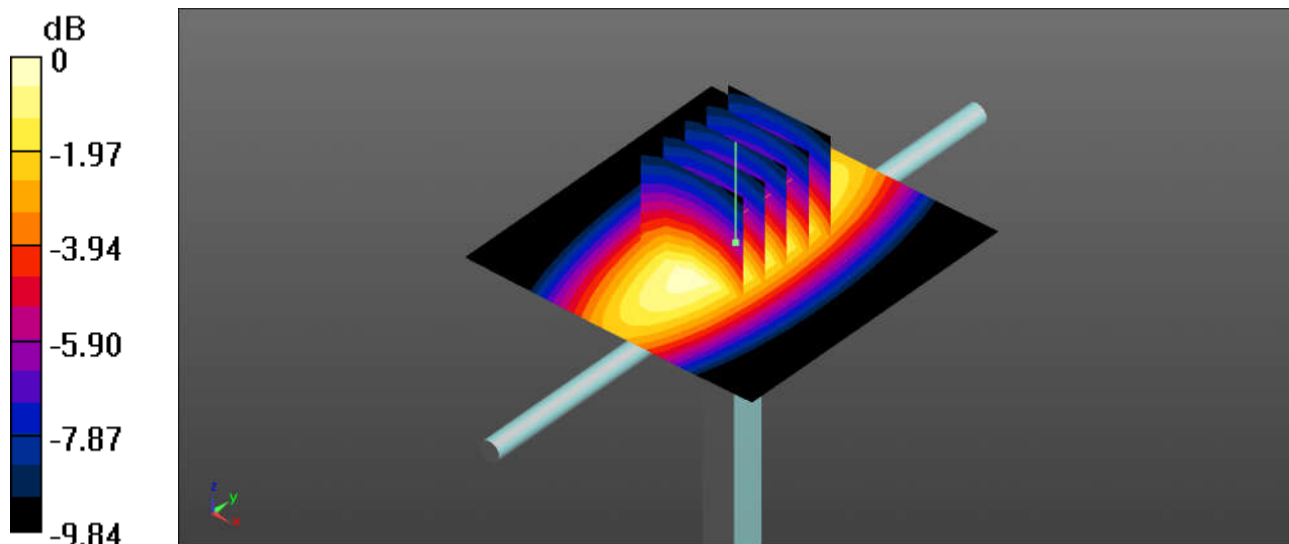

0 dB = 2.79 W/kg

System Check_Body_835MHz

DUT: D835V2-SN:4d162

Communication System: UID 0, CW (0); Frequency: 835 MHz; Duty Cycle: 1:1

Medium: MSL_835_190119 Medium parameters used: $f = 835 \text{ MHz}$; $\sigma = 0.972 \text{ S/m}$; $\epsilon_r = 53.975$; $\rho = 1000 \text{ kg/m}^3$

Ambient Temperature : 23.5 °C; Liquid Temperature : 22.5 °C

DASY5 Configuration:

- Probe: EX3DV4 - SN3753; ConvF(9.24, 9.24, 9.24); Calibrated: 2018.05.29;
- Sensor-Surface: 2mm (Mechanical Surface Detection)
- Electronics: DAE4 Sn1437; Calibrated: 2018.10.15
- Phantom: ELI v4.0; Type: QDOVA002AA; Serial: TP:1149
- Measurement SW: DASY52, Version 52.8 (8); SEMCAD X Version 14.6.10 (7331)

Pin=250mW/Area Scan (61x61x1): Interpolated grid: dx=15mm, dy=15mm

Maximum value of SAR (interpolated) = 2.71 W/kg

Pin=250mW/Zoom Scan (5x5x7)/Cube 0: Measurement grid: dx=8mm, dy=8mm, dz=5mm

Reference Value = 53.53 V/m; Power Drift = 0.07 dB

Peak SAR (extrapolated) = 3.29 W/kg

SAR(1 g) = 2.25 W/kg; SAR(10 g) = 1.54 W/kg

Maximum value of SAR (measured) = 2.79 W/kg

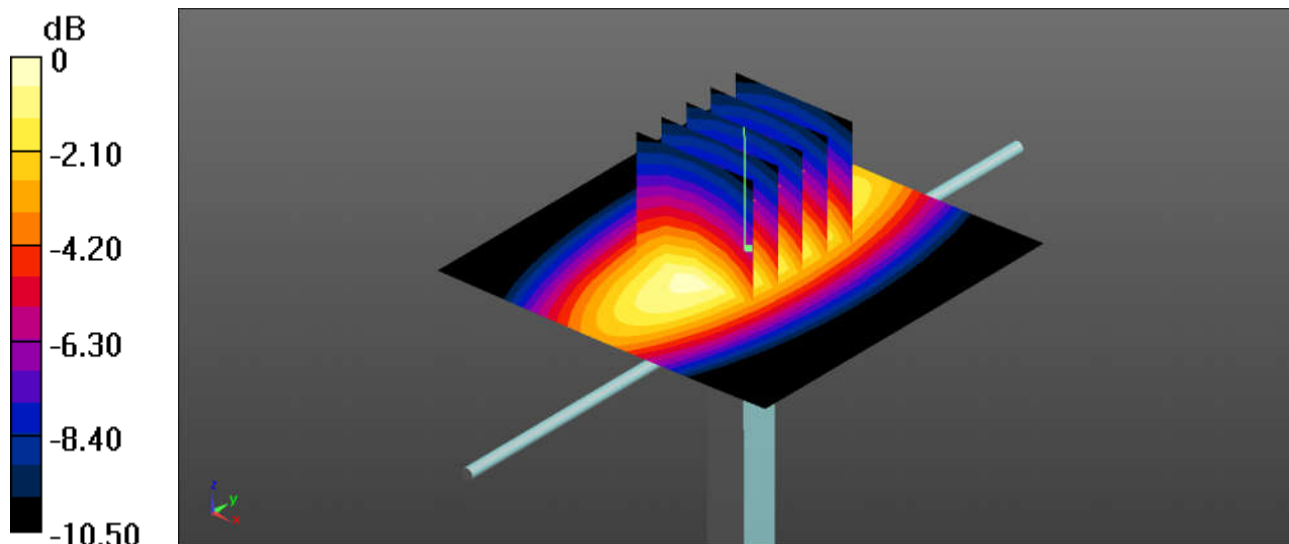

0 dB = 2.79 W/kg

System Check_Body_1750MHz

DUT: D1750V2-SN:1137

Communication System: UID 0, CW; Frequency: 1750 MHz; Duty Cycle: 1:1

Medium: MSL_1750_190118 Medium parameters used: $f = 1750$ MHz; $\sigma = 1.511$ S/m; $\epsilon_r = 51.994$; $\rho = 1000$ kg/m³

Ambient Temperature : 23.4 °C; Liquid Temperature : 22.5 °C

DASY5 Configuration:

- Probe: EX3DV4 - SN3753; ConvF(7.76, 7.76, 7.76); Calibrated: 2018.05.29;
- Sensor-Surface: 2mm (Mechanical Surface Detection)
- Electronics: DAE4 Sn1437; Calibrated: 2018.10.15
- Phantom: ELI v4.0; Type: QDOVA002AA; Serial: TP:1149
- Measurement SW: DASY52, Version 52.8 (8); SEMCAD X Version 14.6.10 (7331)

Pin=250mW/Area Scan (61x61x1): Interpolated grid: dx=15mm, dy=15mm

Maximum value of SAR (interpolated) = 13.3 W/kg

Pin=250mW/Zoom Scan (5x5x7)/Cube 0: Measurement grid: dx=8mm, dy=8mm, dz=5mm

Reference Value = 93.65 V/m; Power Drift = 0.02 dB

Peak SAR (extrapolated) = 16.5 W/kg

SAR(1 g) = 9.29 W/kg; SAR(10 g) = 4.92 W/kg

Maximum value of SAR (measured) = 13.0 W/kg

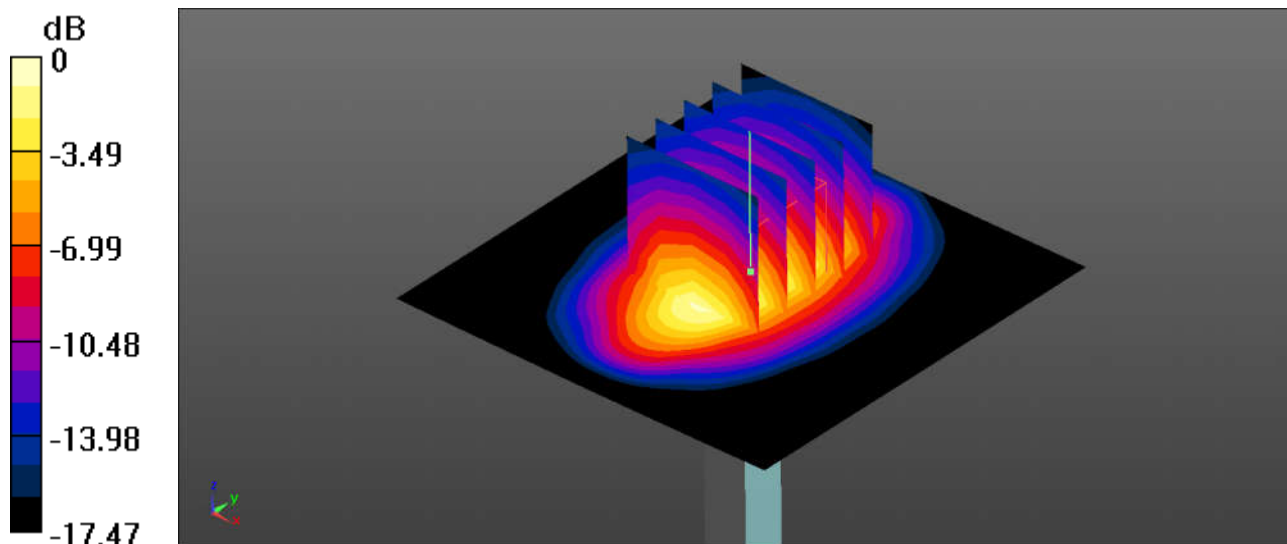

0 dB = 13.0 W/kg

System Check_Body_1900MHz

DUT: D1900V2-SN:5d182

Communication System: UID 0, CW; Frequency: 1900 MHz; Duty Cycle: 1:1

Medium: MSL_1900_190118 Medium parameters used: $f = 1900$ MHz; $\sigma = 1.512$ S/m; $\epsilon_r = 53.903$; $\rho = 1000$ kg/m³

Ambient Temperature : 23.4 °C; Liquid Temperature : 22.6 °C

DASY5 Configuration:

- Probe: EX3DV4 - SN3753; ConvF(7.52, 7.52, 7.52); Calibrated: 2018.05.29;
- Sensor-Surface: 2mm (Mechanical Surface Detection)
- Electronics: DAE4 Sn1437; Calibrated: 2018.10.15
- Phantom: ELI v4.0; Type: QDOVA002AA; Serial: TP:1149
- Measurement SW: DASY52, Version 52.8 (8); SEMCAD X Version 14.6.10 (7331)

Pin=250mW/Area Scan (61x61x1): Interpolated grid: dx=15mm, dy=15mm

Maximum value of SAR (interpolated) = 14.1 W/kg

Pin=250mW/Zoom Scan (5x5x7)/Cube 0: Measurement grid: dx=8mm, dy=8mm, dz=5mm

Reference Value = 84.32 V/m; Power Drift = 0.07 dB

Peak SAR (extrapolated) = 17.7 W/kg

SAR(1 g) = 9.71 W/kg; SAR(10 g) = 4.98 W/kg

Maximum value of SAR (measured) = 13.9 W/kg

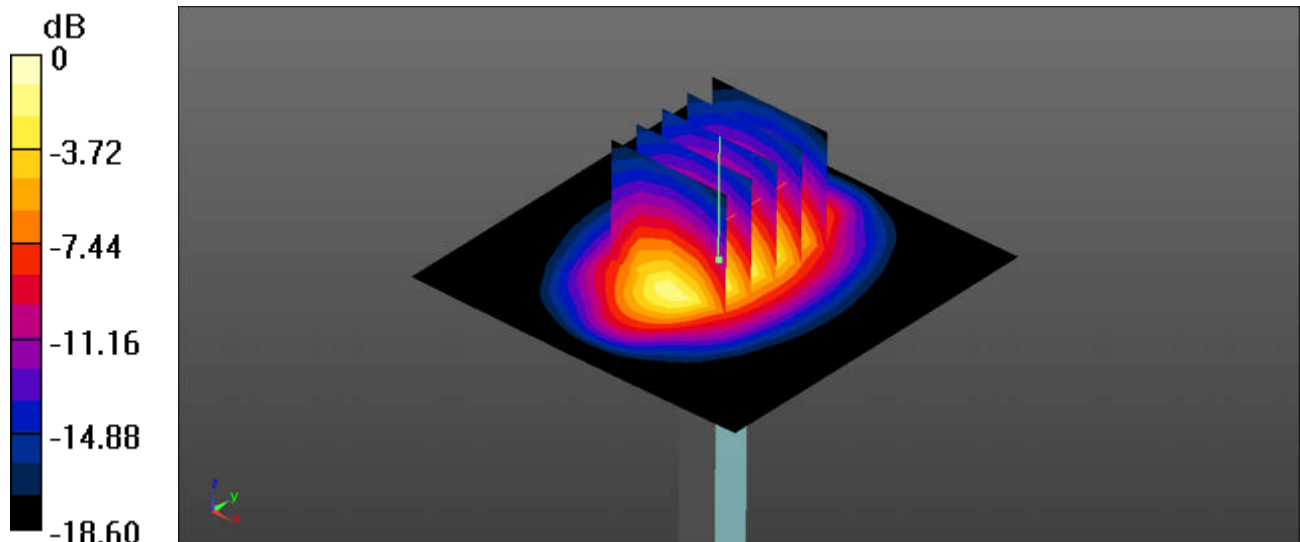

0 dB = 13.9 W/kg

System Check_Body_2450MHz

DUT: D2450V2-SN:924

Communication System: UID 0, CW; Frequency: 2450 MHz; Duty Cycle: 1:1

Medium: MSL_2450_190114 Medium parameters used: $f = 2450$ MHz; $\sigma = 1.938$ S/m; $\epsilon_r = 51.276$; $\rho = 1000$ kg/m³

Ambient Temperature : 23.4 °C ; Liquid Temperature : 22.5 °C

DASY5 Configuration:

- Probe: EX3DV4 - SN3753; ConvF(7.36, 7.36, 7.36); Calibrated: 2018.05.29;
- Sensor-Surface: 2mm (Mechanical Surface Detection)
- Electronics: DAE4 Sn1437; Calibrated: 2018.10.15
- Phantom: ELI v4.0; Type: QDOVA002AA; Serial: TP:1149
- Measurement SW: DASY52, Version 52.8 (8); SEMCAD X Version 14.6.10 (7331)

Pin=250mW/Area Scan (81x81x1): Interpolated grid: dx=12mm, dy=12mm

Maximum value of SAR (interpolated) = 19.1 W/kg

Pin=250mW/Zoom Scan (7x7x7)/Cube 0: Measurement grid: dx=5mm, dy=5mm, dz=5mm

Reference Value = 82.02 V/m; Power Drift = 0.03 dB

Peak SAR (extrapolated) = 26.1 W/kg

SAR(1 g) = 12.5 W/kg; SAR(10 g) = 5.72 W/kg

Maximum value of SAR (measured) = 19.4 W/kg

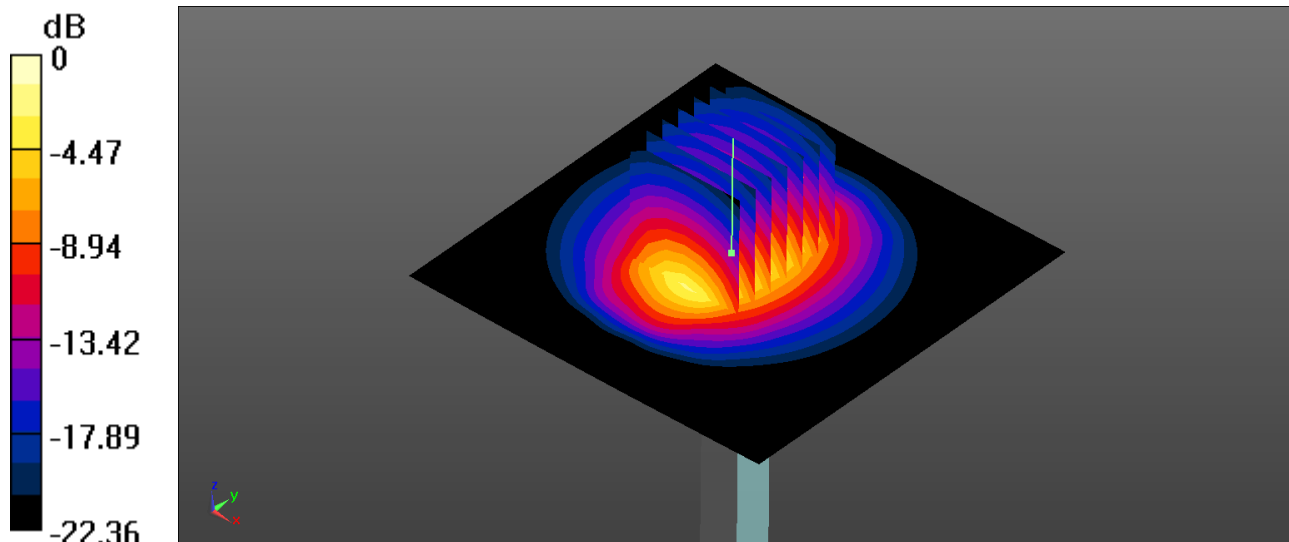

0 dB = 19.4 W/kg

System Check_Body_2600MHz

DUT: D2600V2-SN:1070

Communication System: UID 0, CW; Frequency: 2600 MHz; Duty Cycle: 1:1

Medium: MSL_2600_190115 Medium parameters used: $f = 2600$ MHz; $\sigma = 2.192$ S/m; $\epsilon_r = 50.732$; $\rho = 1000$ kg/m³

Ambient Temperature : 23.4 °C; Liquid Temperature : 22.6 °C

DASY5 Configuration:

- Probe: EX3DV4 - SN3753; ConvF(7.03, 7.03, 7.03); Calibrated: 2018.05.29;
- Sensor-Surface: 2mm (Mechanical Surface Detection)
- Electronics: DAE4 Sn1437; Calibrated: 2018.10.15
- Phantom: ELI v4.0; Type: QDOVA002AA; Serial: TP:1149
- Measurement SW: DASY52, Version 52.8 (8); SEMCAD X Version 14.6.10 (7331)

Pin=250mW/Area Scan (71x71x1): Interpolated grid: dx=12mm, dy=12mm

Maximum value of SAR (interpolated) = 22.1 W/kg

Pin=250mW/Zoom Scan (7x7x7)/Cube 0: Measurement grid: dx=5mm, dy=5mm, dz=5mm

Reference Value = 95.69 V/m; Power Drift = 0.07 dB

Peak SAR (extrapolated) = 30.7 W/kg

SAR(1 g) = 13.9 W/kg; SAR(10 g) = 6.03 W/kg

Maximum value of SAR (measured) = 22.1 W/kg

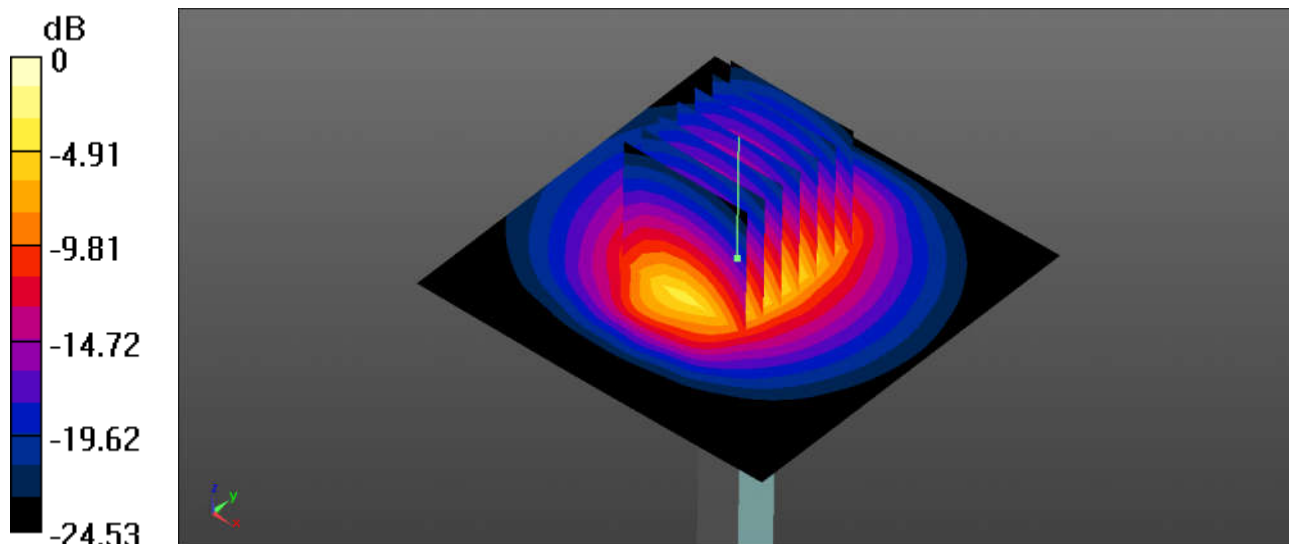

0 dB = 22.1 W/kg

System Check_Body_5250MHz

DUT: D5GHzV2-SN:1167

Communication System: UID 0, CW (0); Frequency: 5250 MHz; Duty Cycle: 1:1

Medium: MSL_5250_190114 Medium parameters used: $f = 5250$ MHz; $\sigma = 5.29$ S/m; $\epsilon_r = 50.979$; $\rho = 1000$ kg/m³

Ambient Temperature : 23.4 °C; Liquid Temperature : 22.5 °C

DASY5 Configuration:

- Probe: EX3DV4 - SN3753; ConvF(4.88, 4.88, 4.88); Calibrated: 2018.05.29;
- Sensor-Surface: 1.4mm (Mechanical Surface Detection)
- Electronics: DAE4 Sn1437; Calibrated: 2018.10.15
- Phantom: ELI v4.0; Type: QDOVA002AA; Serial: TP:1149
- Measurement SW: DASY52, Version 52.8 (8); SEMCAD X Version 14.6.10 (7331)

Pin=100mW/Area Scan (71x71x1): Interpolated grid: dx=10mm, dy=10mm

Maximum value of SAR (interpolated) = 17.7 W/kg

Pin=100mW/Zoom Scan (7x7x7)/Cube 0: Measurement grid: dx=4mm, dy=4mm, dz=1.4mm

Reference Value = 45.87 V/m; Power Drift = 0.07 dB

Peak SAR (extrapolated) = 33.0 W/kg

SAR(1 g) = 7.5 W/kg; SAR(10 g) = 2.01 W/kg

Maximum value of SAR (measured) = 18.8 W/kg

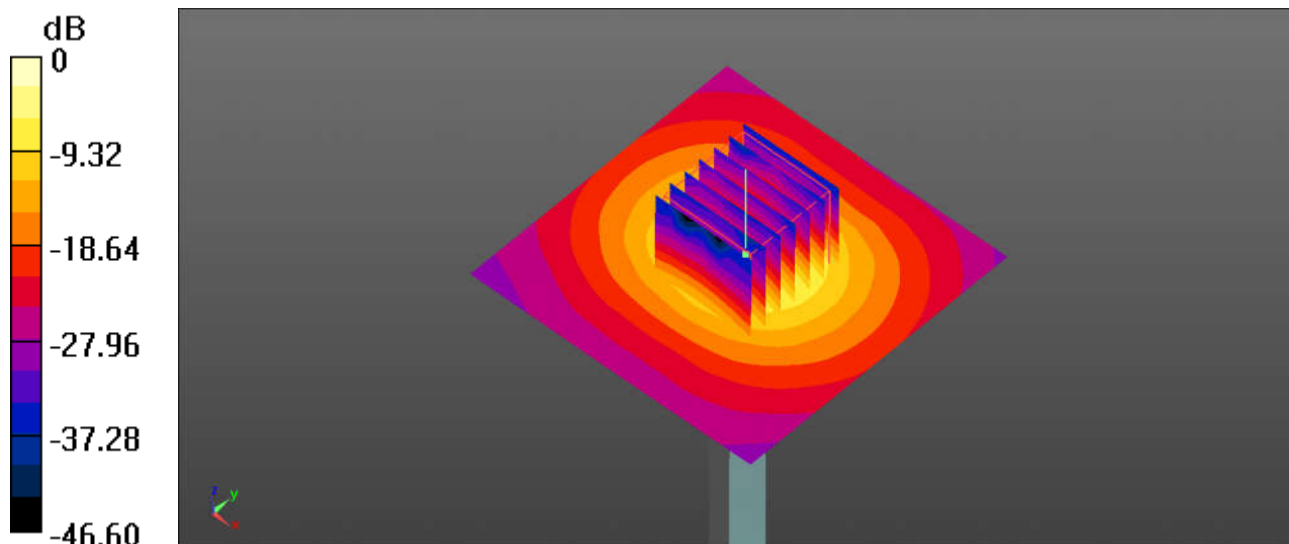

0 dB = 18.8 W/kg

System Check_Body_5750MHz

DUT: D5GHzV2-SN:1167

Communication System: UID 0, CW (0); Frequency: 5750 MHz;Duty Cycle: 1:1

Medium: MSL_5750_190114 Medium parameters used: $f = 5750$ MHz; $\sigma = 6.115$ S/m; $\epsilon_r = 50.005$; $\rho = 1000$ kg/m³

Ambient Temperature : 23.4 °C; Liquid Temperature : 22.7 °C

DASY5 Configuration:

- Probe: EX3DV4 - SN3753; ConvF(4.53, 4.53, 4.53); Calibrated: 2018.05.29;
- Sensor-Surface: 1.4mm (Mechanical Surface Detection)
- Electronics: DAE4 Sn1437; Calibrated: 2018.10.15
- Phantom: ELI v4.0; Type: QDOVA002AA; Serial: TP:1149
- Measurement SW: DASY52, Version 52.8 (8); SEMCAD X Version 14.6.10 (7331)

Pin=100mW/Area Scan (71x71x1): Interpolated grid: dx=10mm, dy=10mm

Maximum value of SAR (interpolated) = 19.6 W/kg

Pin=100mW/Zoom Scan (7x7x7)/Cube 0: Measurement grid: dx=4mm, dy=4mm, dz=1.4mm

Reference Value = 40.33 V/m; Power Drift = 0.08 dB

Peak SAR (extrapolated) = 35.2 W/kg

SAR(1 g) = 7.48 W/kg; SAR(10 g) = 2.03 W/kg

Maximum value of SAR (measured) = 18.7 W/kg

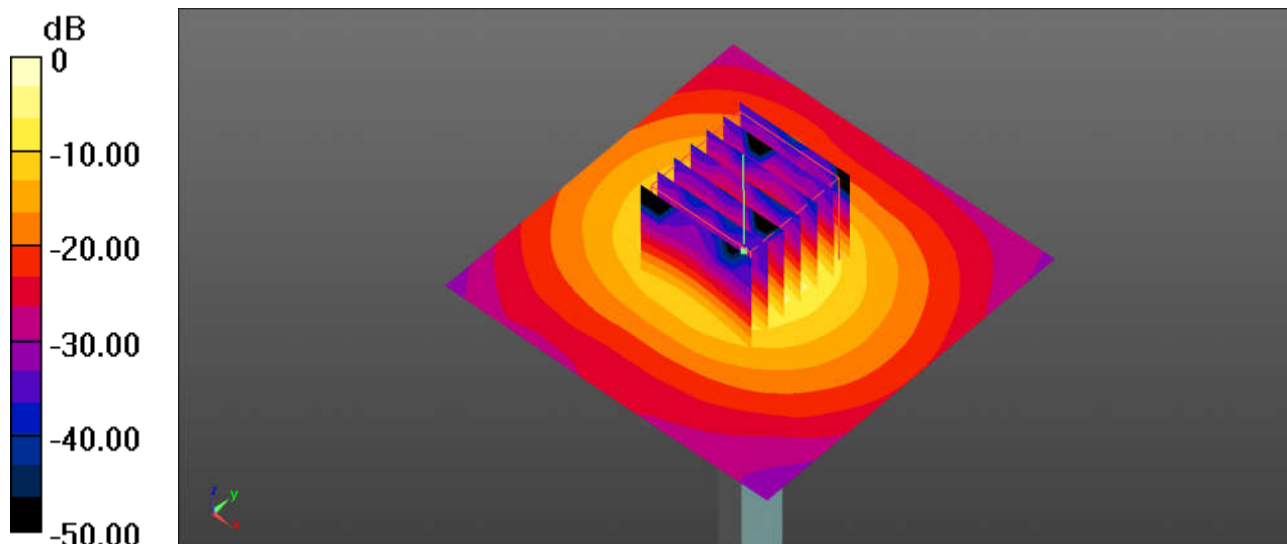

0 dB = 18.7 W/kg



Appendix B. Plots of High SAR Measurement

The plots are shown as follows.

01_WCDMA Band V_RMC 12.2Kbps_Front_0mm_Ch4132

Communication System: UID 0, UMTS (0); Frequency: 826.4 MHz; Duty Cycle: 1:1
 Medium: MSL_835_190119 Medium parameters used: $f = 826.4$ MHz; $\sigma = 0.963$ S/m; $\epsilon_r = 54.051$; $\rho = 1000$ kg/m³
 Ambient Temperature : 23.5 °C; Liquid Temperature : 22.5 °C

DASY5 Configuration:

- Probe: EX3DV4 - SN3753; ConvF(9.24, 9.24, 9.24); Calibrated: 2018.05.29;
- Sensor-Surface: 2mm (Mechanical Surface Detection)
- Electronics: DAE4 Sn1437; Calibrated: 2018.10.15
- Phantom: ELI v4.0; Type: QDOVA002AA; Serial: TP:1149
- Measurement SW: DASY52, Version 52.8 (8); SEMCAD X Version 14.6.10 (7331)

Ch4132/Area Scan (71x141x1): Interpolated grid: dx=15mm, dy=15mm
 Maximum value of SAR (interpolated) = 0.901 W/kg

Ch4132/Zoom Scan (5x5x7)/Cube 0: Measurement grid: dx=8mm, dy=8mm, dz=5mm
 Reference Value = 1.212 V/m; Power Drift = 0.03 dB
 Peak SAR (extrapolated) = 1.09 W/kg
SAR(1 g) = 0.667 W/kg; SAR(10 g) = 0.396 W/kg
 Maximum value of SAR (measured) = 0.893 W/kg

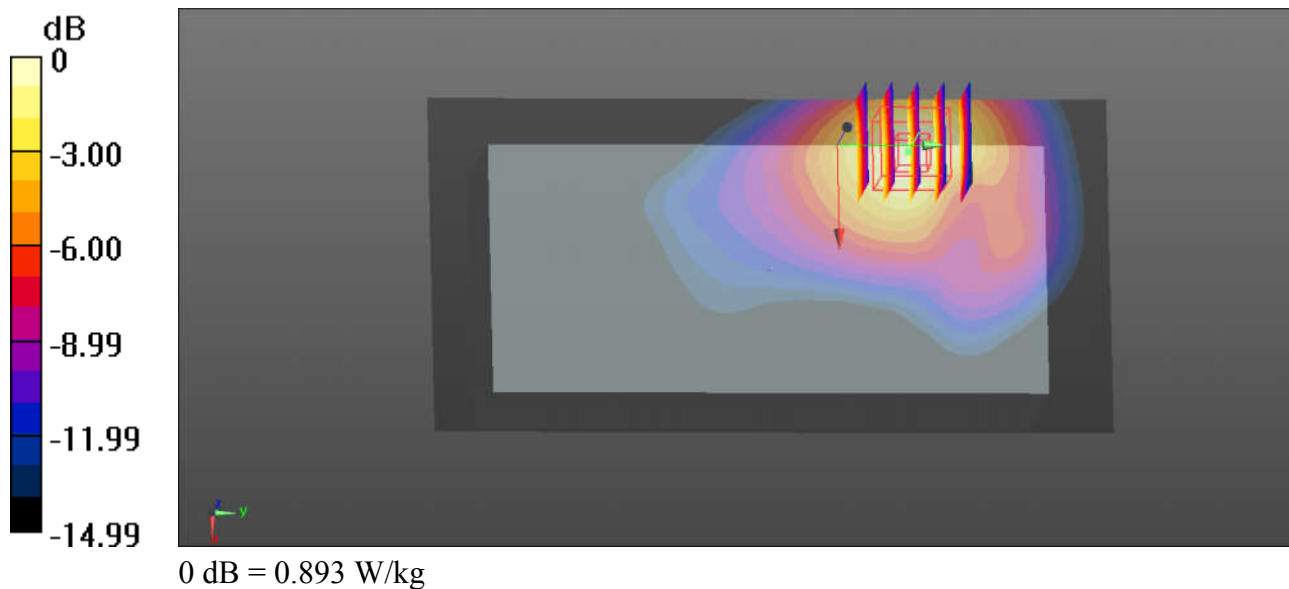

02_WCDMA Band IV_RMC 12.2Kbps_Front_0mm_Ch1312

Communication System: UID 0, UMTS (0); Frequency: 1712.4 MHz; Duty Cycle: 1:1
 Medium: MSL_1750_190118 Medium parameters used: $f = 1712.4$ MHz; $\sigma = 1.47$ S/m; $\epsilon_r = 52.06$; $\rho = 1000$ kg/m³
 Ambient Temperature : 23.4 °C; Liquid Temperature : 22.5 °C

DASY5 Configuration:

- Probe: EX3DV4 - SN3753; ConvF(7.76, 7.76, 7.76); Calibrated: 2018.05.29;
- Sensor-Surface: 2mm (Mechanical Surface Detection)
- Electronics: DAE4 Sn1437; Calibrated: 2018.10.15
- Phantom: ELI v4.0; Type: QDOVA002AA; Serial: TP:1149
- Measurement SW: DASY52, Version 52.8 (8); SEMCAD X Version 14.6.10 (7331)

Ch1312/Area Scan (131x71x1): Interpolated grid: dx=15mm, dy=15mm
 Maximum value of SAR (interpolated) = 0.299 W/kg

Ch1312/Zoom Scan (5x5x7)/Cube 0: Measurement grid: dx=8mm, dy=8mm, dz=5mm
 Reference Value = 3.028 V/m; Power Drift = -0.06 dB
 Peak SAR (extrapolated) = 0.422 W/kg
SAR(1 g) = 0.225 W/kg; SAR(10 g) = 0.115 W/kg
 Maximum value of SAR (measured) = 0.325 W/kg

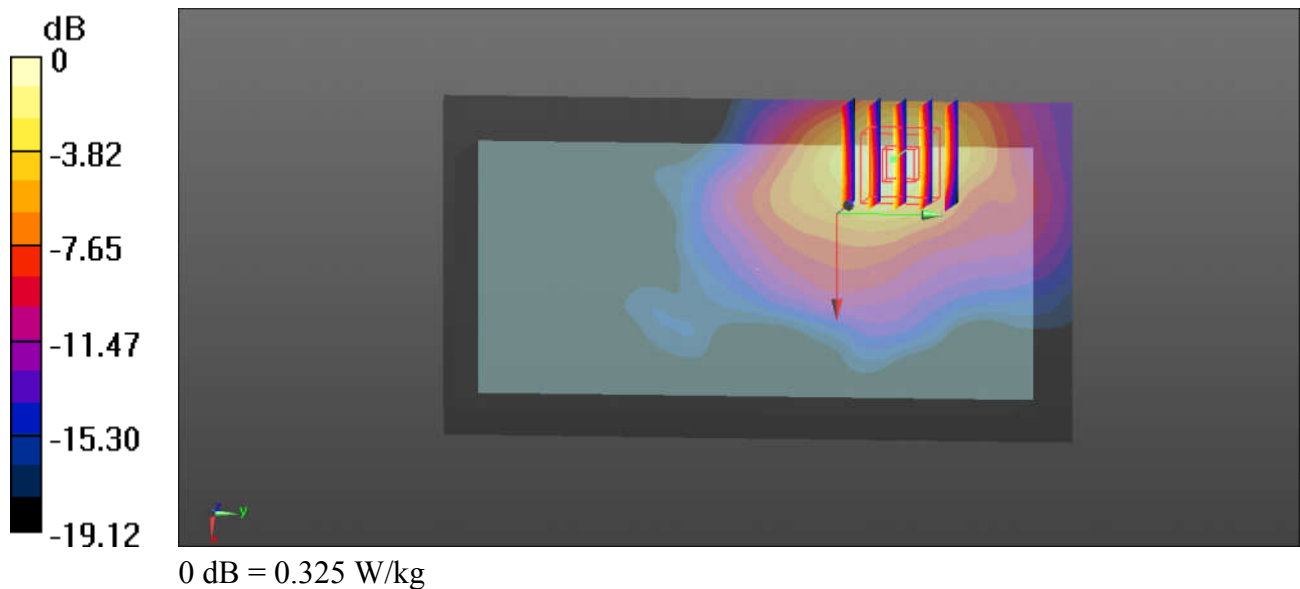

03_WCDMA Band II_RMC 12.2Kbps_Front_0mm_Ch9262

Communication System: UID 0, UMTS (0); Frequency: 1852.4 MHz; Duty Cycle: 1:1
 Medium: MSL_1900_190118 Medium parameters used: $f = 1852.4 \text{ MHz}$; $\sigma = 1.458 \text{ S/m}$; $\epsilon_r = 54.025$;
 $\rho = 1000 \text{ kg/m}^3$
 Ambient Temperature : $23.4 \text{ }^\circ\text{C}$; Liquid Temperature : $22.6 \text{ }^\circ\text{C}$

DASY5 Configuration:

- Probe: EX3DV4 - SN3753; ConvF(7.52, 7.52, 7.52); Calibrated: 2018.05.29;
- Sensor-Surface: 2mm (Mechanical Surface Detection)
- Electronics: DAE4 Sn1437; Calibrated: 2018.10.15
- Phantom: ELI v4.0; Type: QDOVA002AA; Serial: TP:1149
- Measurement SW: DASY52, Version 52.8 (8); SEMCAD X Version 14.6.10 (7331)

Ch9262/Area Scan (131x71x1): Interpolated grid: $dx=15\text{mm}$, $dy=15\text{mm}$
 Maximum value of SAR (interpolated) = 0.241 W/kg

Ch9262/Zoom Scan (5x5x7)/Cube 0: Measurement grid: $dx=8\text{mm}$, $dy=8\text{mm}$, $dz=5\text{mm}$
 Reference Value = 2.915 V/m ; Power Drift = -0.01 dB
 Peak SAR (extrapolated) = 0.333 W/kg
SAR(1 g) = 0.175 W/kg ; SAR(10 g) = 0.087 W/kg
 Maximum value of SAR (measured) = 0.257 W/kg

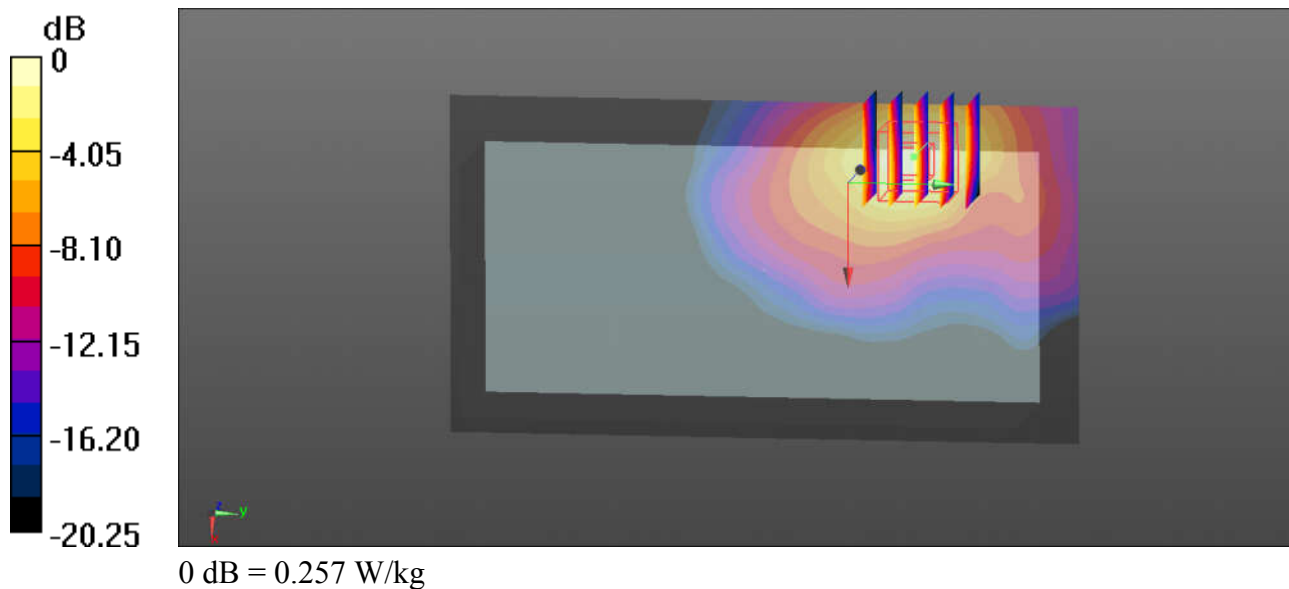

04_LTE Band 5_10M_QPSK_1RB_25Offset_Front_0mm_Ch20525

Communication System: UID 0, LTE (0); Frequency: 836.5 MHz; Duty Cycle: 1:1
Medium: MSL_835_190119 Medium parameters used: $f = 836.5$ MHz; $\sigma = 0.974$ S/m; $\epsilon_r = 53.961$; $\rho = 1000$ kg/m³
Ambient Temperature : 23.5 °C; Liquid Temperature : 22.5 °C

DASY5 Configuration:

- Probe: EX3DV4 - SN3753; ConvF(9.24, 9.24, 9.24); Calibrated: 2018.05.29;
- Sensor-Surface: 2mm (Mechanical Surface Detection)
- Electronics: DAE4 Sn1437; Calibrated: 2018.10.15
- Phantom: ELI v4.0; Type: QDOVA002AA; Serial: TP:1149
- Measurement SW: DASY52, Version 52.8 (8); SEMCAD X Version 14.6.10 (7331)

Ch20525/Area Scan (71x141x1): Interpolated grid: dx=15mm, dy=15mm
Maximum value of SAR (interpolated) = 0.820 W/kg

Ch20525/Zoom Scan (5x5x7)/Cube 0: Measurement grid: dx=8mm, dy=8mm, dz=5mm
Reference Value = 1.405 V/m; Power Drift = -0.17 dB
Peak SAR (extrapolated) = 1.00 W/kg
SAR(1 g) = 0.609 W/kg; SAR(10 g) = 0.359 W/kg
Maximum value of SAR (measured) = 0.827 W/kg

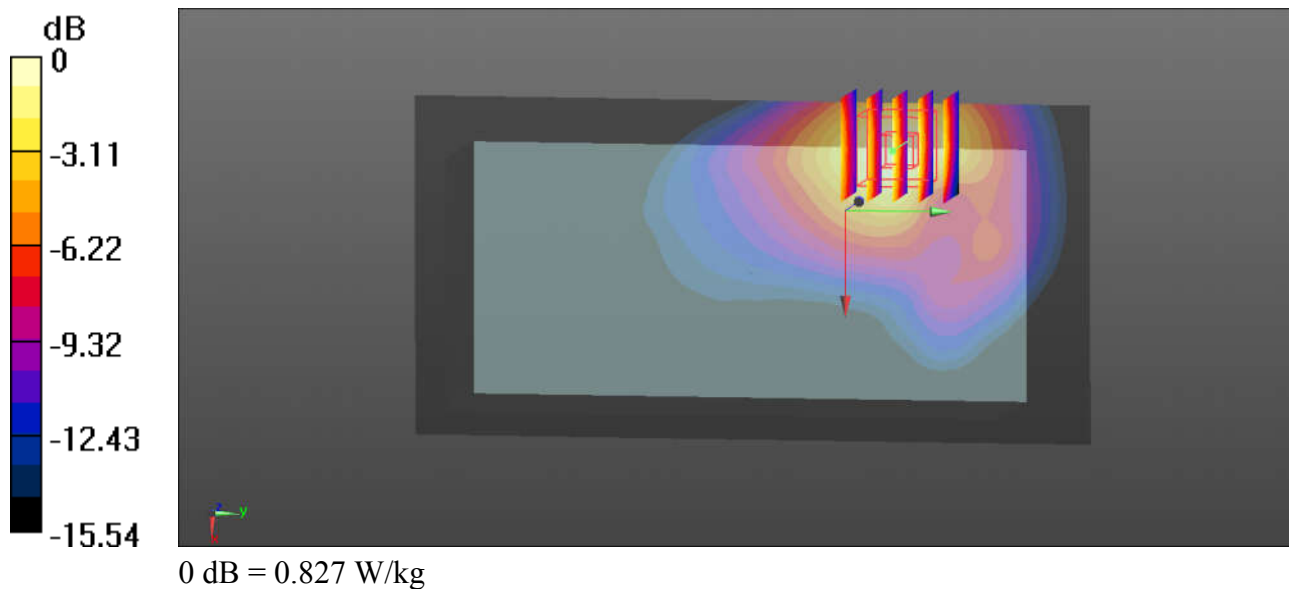

05_LTE Band 12_10M_QPSK_1RB_25Offset_Front_0mm_Ch23095

Communication System: UID 0, LTE (0); Frequency: 707.5 MHz; Duty Cycle: 1:1
Medium: MSL_750_190119 Medium parameters used : $f = 707.5$ MHz; $\sigma = 0.933$ S/m; $\epsilon_r = 55.183$; $\rho = 1000$ kg/m³
Ambient Temperature : 23.4 °C; Liquid Temperature : 22.4 °C

DASY5 Configuration:

- Probe: EX3DV4 - SN3753; ConvF(9.58, 9.58, 9.58); Calibrated: 2018.05.29;
- Sensor-Surface: 2mm (Mechanical Surface Detection)
- Electronics: DAE4 Sn1437; Calibrated: 2018.10.15
- Phantom: ELI v4.0; Type: QDOVA002AA; Serial: TP:1149
- Measurement SW: DASY52, Version 52.8 (8); SEMCAD X Version 14.6.10 (7331)

Ch23095/Area Scan (71x141x1): Interpolated grid: dx=15mm, dy=15mm
Maximum value of SAR (interpolated) = 1.40 W/kg

Ch23095/Zoom Scan (5x5x7)/Cube 0: Measurement grid: dx=8mm, dy=8mm, dz=5mm
Reference Value = 1.183 V/m; Power Drift = 0.05 dB
Peak SAR (extrapolated) = 1.73 W/kg
SAR(1 g) = 1.03 W/kg; SAR(10 g) = 0.606 W/kg
Maximum value of SAR (measured) = 1.40 W/kg

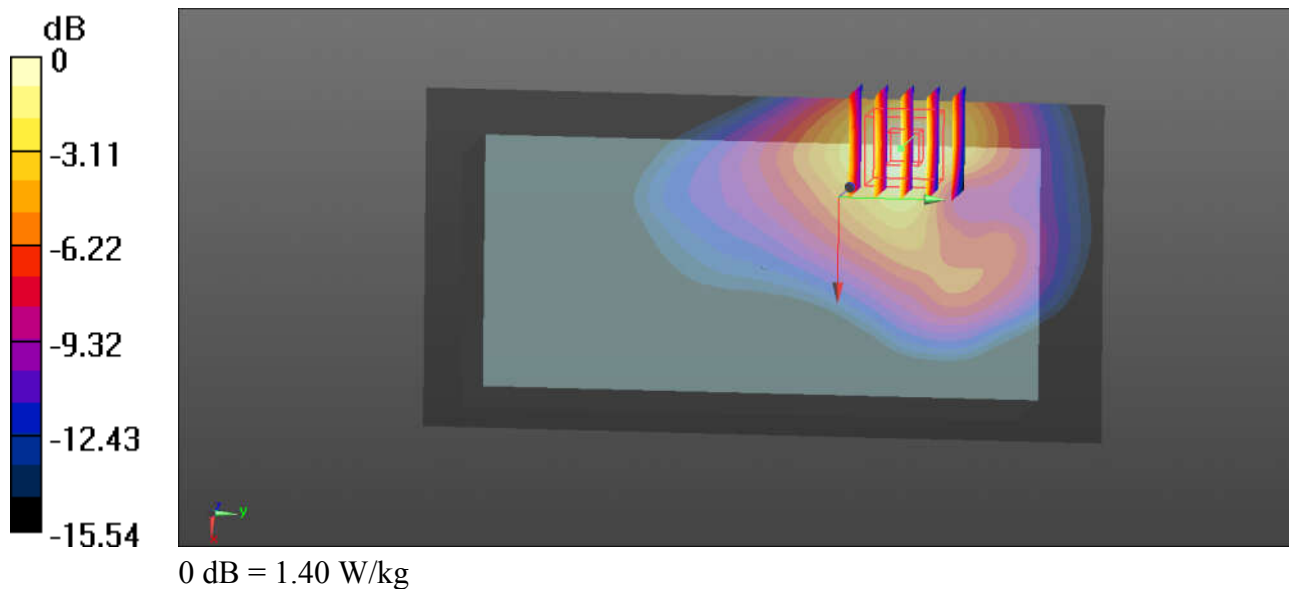

06_LTE Band 13_10M_QPSK_1RB_0Offset_Front_0mm_Ch23230

Communication System: UID 0, LTE (0); Frequency: 782 MHz; Duty Cycle: 1:1
Medium: MSL_750_190119 Medium parameters used: $f = 782 \text{ MHz}$; $\sigma = 0.988 \text{ S/m}$; $\epsilon_r = 53.555$; $\rho = 1000 \text{ kg/m}^3$
Ambient Temperature : $23.4 \text{ }^\circ\text{C}$; Liquid Temperature : $22.4 \text{ }^\circ\text{C}$

DASY5 Configuration:

- Probe: EX3DV4 - SN3753; ConvF(9.58, 9.58, 9.58); Calibrated: 2018.05.29;
- Sensor-Surface: 2mm (Mechanical Surface Detection)
- Electronics: DAE4 Sn1437; Calibrated: 2018.10.15
- Phantom: ELI v4.0; Type: QDOVA002AA; Serial: TP:1149
- Measurement SW: DASY52, Version 52.8 (8); SEMCAD X Version 14.6.10 (7331)

Ch23230/Area Scan (71x141x1): Interpolated grid: $dx=15\text{mm}$, $dy=15\text{mm}$
Maximum value of SAR (interpolated) = 1.43 W/kg

Ch23230/Zoom Scan (5x5x7)/Cube 0: Measurement grid: $dx=8\text{mm}$, $dy=8\text{mm}$, $dz=5\text{mm}$
Reference Value = 1.351 V/m ; Power Drift = 0.19 dB
Peak SAR (extrapolated) = 1.78 W/kg
SAR(1 g) = 1.05 W/kg ; SAR(10 g) = 0.614 W/kg
Maximum value of SAR (measured) = 1.47 W/kg

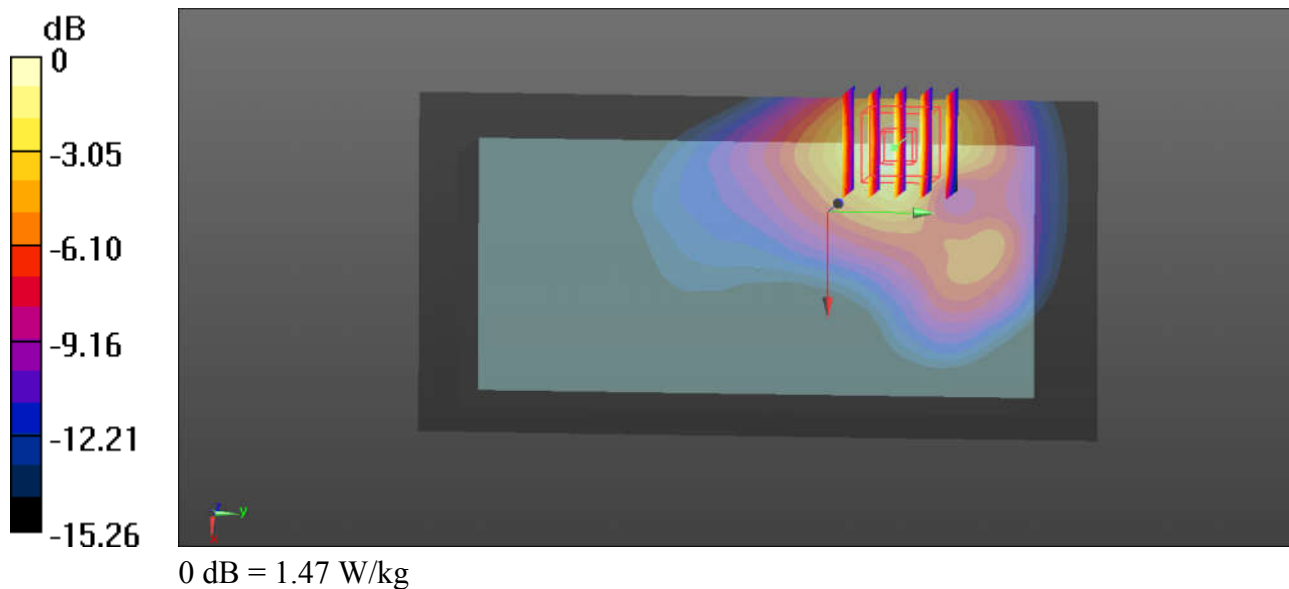

07_LTE Band 4_20M_QPSK_1RB_49Offset_Front_0mm_Ch20175

Communication System: UID 0, LTE (0); Frequency: 1732.5 MHz; Duty Cycle: 1:1
Medium: MSL_1750_190118 Medium parameters used: $f = 1732.5$ MHz; $\sigma = 1.492$ S/m; $\epsilon_r = 52.022$;
 $\rho = 1000$ kg/m³
Ambient Temperature : 23.4 °C; Liquid Temperature : 22.5 °C

DASY5 Configuration:

- Probe: EX3DV4 - SN3753; ConvF(7.76, 7.76, 7.76); Calibrated: 2018.05.29;
- Sensor-Surface: 2mm (Mechanical Surface Detection)
- Electronics: DAE4 Sn1437; Calibrated: 2018.10.15
- Phantom: ELI v4.0; Type: QDOVA002AA; Serial: TP:1149
- Measurement SW: DASY52, Version 52.8 (8); SEMCAD X Version 14.6.10 (7331)

Ch20175/Area Scan (131x71x1): Interpolated grid: dx=15mm, dy=15mm
Maximum value of SAR (interpolated) = 0.308 W/kg

Ch20175/Zoom Scan (5x5x7)/Cube 0: Measurement grid: dx=8mm, dy=8mm, dz=5mm
Reference Value = 3.272 V/m; Power Drift = -0.01 dB
Peak SAR (extrapolated) = 0.414 W/kg
SAR(1 g) = 0.219 W/kg; SAR(10 g) = 0.111 W/kg
Maximum value of SAR (measured) = 0.324 W/kg

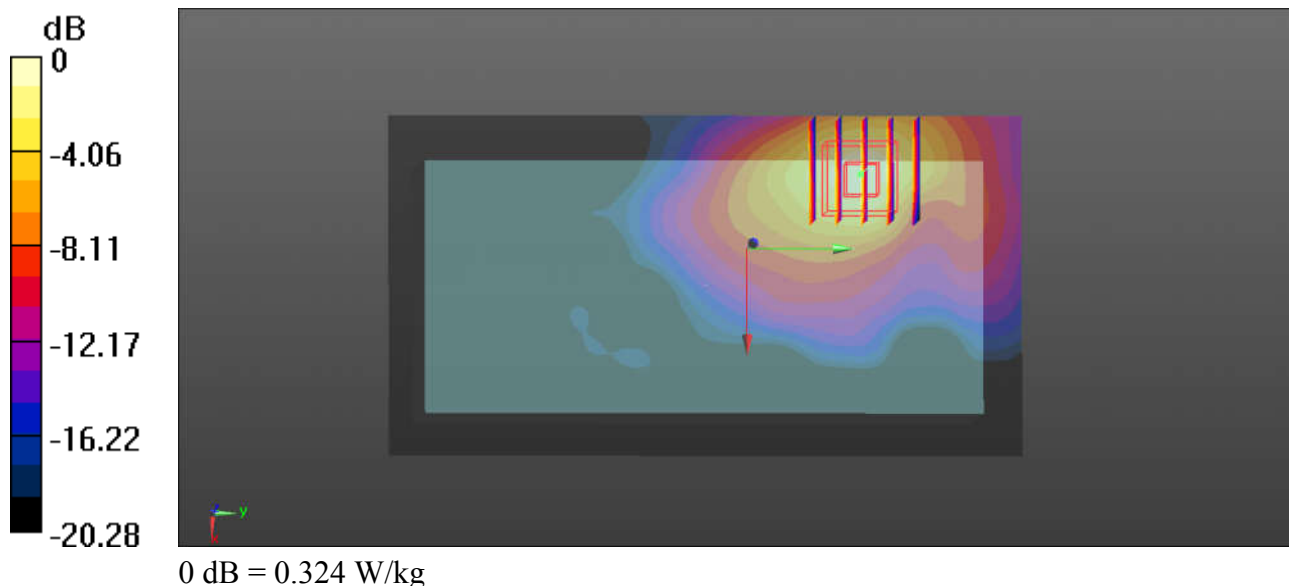

08_LTE Band 2_20M_QPSK_1RB_0Offset_Front_0mm_Ch19100

Communication System: UID 0, LTE (0); Frequency: 1900 MHz; Duty Cycle: 1:1
Medium: MSL_1900_190118 Medium parameters used: $f = 1900$ MHz; $\sigma = 1.512$ S/m; $\epsilon_r = 53.903$; $\rho = 1000$ kg/m³
Ambient Temperature : 23.4 °C; Liquid Temperature : 22.6 °C

DASY5 Configuration:

- Probe: EX3DV4 - SN3753; ConvF(7.52, 7.52, 7.52); Calibrated: 2018.05.29;
- Sensor-Surface: 2mm (Mechanical Surface Detection)
- Electronics: DAE4 Sn1437; Calibrated: 2018.10.15
- Phantom: ELI v4.0; Type: QDOVA002AA; Serial: TP:1149
- Measurement SW: DASY52, Version 52.8 (8); SEMCAD X Version 14.6.10 (7331)

Ch19100/Area Scan (131x71x1): Interpolated grid: dx=15mm, dy=15mm
Maximum value of SAR (interpolated) = 0.254 W/kg

Ch19100/Zoom Scan (5x5x7)/Cube 0: Measurement grid: dx=8mm, dy=8mm, dz=5mm
Reference Value = 3.335 V/m; Power Drift = 0.05 dB
Peak SAR (extrapolated) = 0.346 W/kg
SAR(1 g) = 0.181 W/kg; SAR(10 g) = 0.090 W/kg
Maximum value of SAR (measured) = 0.266 W/kg

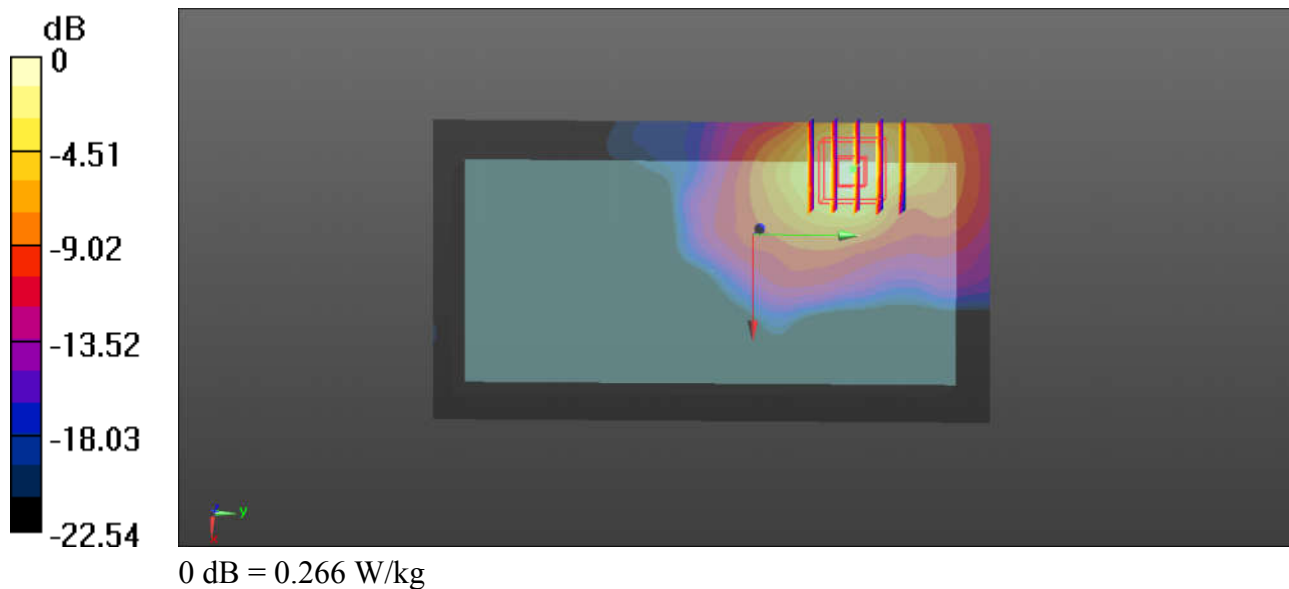

09_LTE Band 7_20M_QPSK_1RB_0Offset_Front_0mm_Ch21100

Communication System: UID 0, LTE (0); Frequency: 2535 MHz; Duty Cycle: 1:1
Medium: MSL_2600_190115 Medium parameters used: $f = 2535$ MHz; $\sigma = 2.11$ S/m; $\epsilon_r = 51.275$; $\rho = 1000$ kg/m³
Ambient Temperature : 23.4 °C; Liquid Temperature : 22.6 °C

DASY5 Configuration:

- Probe: EX3DV4 - SN3753; ConvF(7.03, 7.03, 7.03); Calibrated: 2018.05.29;
- Sensor-Surface: 2mm (Mechanical Surface Detection)
- Electronics: DAE4 Sn1437; Calibrated: 2018.10.15
- Phantom: ELI v4.0; Type: QDOVA002AA; Serial: TP:1149
- Measurement SW: DASY52, Version 52.8 (8); SEMCAD X Version 14.6.10 (7331)

Ch21100/Area Scan (81x161x1): Interpolated grid: dx=12mm, dy=12mm
Maximum value of SAR (interpolated) = 0.305 W/kg

Ch21100/Zoom Scan (7x7x7)/Cube 0: Measurement grid: dx=5mm, dy=5mm, dz=5mm
Reference Value = 3.809 V/m; Power Drift = -0.05 dB
Peak SAR (extrapolated) = 0.439 W/kg
SAR(1 g) = 0.220 W/kg; SAR(10 g) = 0.109 W/kg
Maximum value of SAR (measured) = 0.323 W/kg

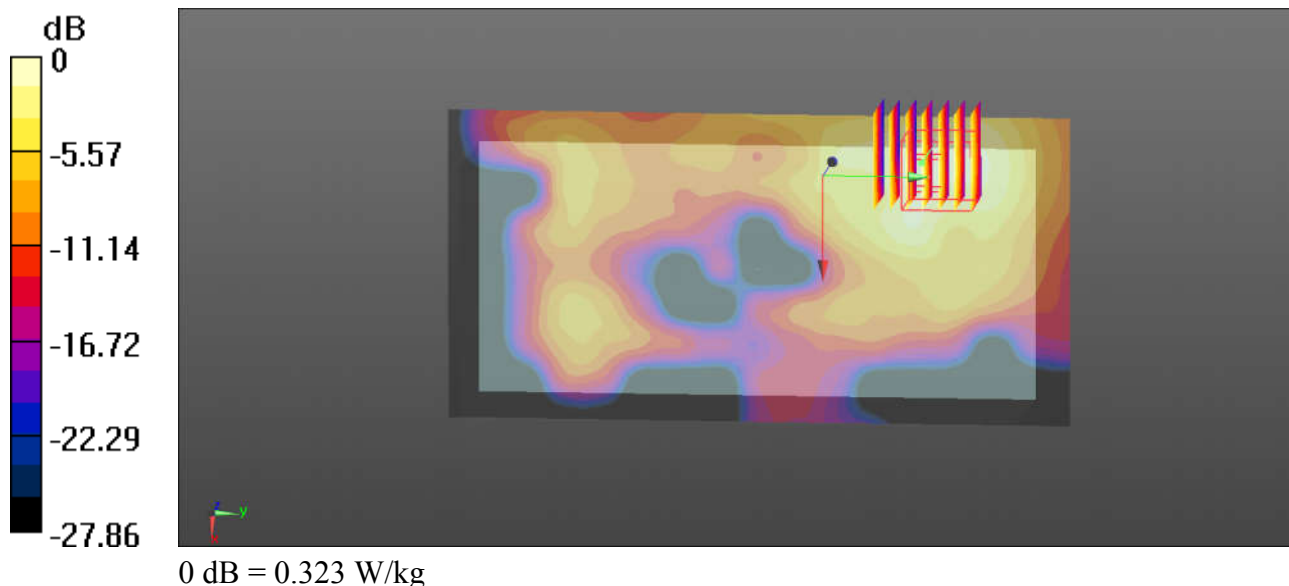

10_WLAN2.4GHz_802.11b 1Mbps_Front_0mm_Ch1

Communication System: UID 0, WIFI (0); Frequency: 2412 MHz; Duty Cycle: 1:1.021
Medium: MSL_2450_190114 Medium parameters used: $f = 2412$ MHz; $\sigma = 1.892$ S/m; $\epsilon_r = 51.346$; $\rho = 1000$ kg/m³
Ambient Temperature : 23.4 °C; Liquid Temperature : 22.5 °C

DASY5 Configuration:

- Probe: EX3DV4 - SN3753; ConvF(7.36, 7.36, 7.36); Calibrated: 2018.05.29;
- Sensor-Surface: 2mm (Mechanical Surface Detection)
- Electronics: DAE4 Sn1437; Calibrated: 2018.10.15
- Phantom: ELI v4.0; Type: QDOVA002AA; Serial: TP:1149
- Measurement SW: DASY52, Version 52.8 (8); SEMCAD X Version 14.6.10 (7331)

Ch1/Area Scan (161x81x1): Interpolated grid: dx=12mm, dy=12mm

Maximum value of SAR (interpolated) = 0.234 W/kg

Ch1/Zoom Scan (7x7x7)/Cube 0: Measurement grid: dx=5mm, dy=5mm, dz=5mm

Reference Value = 1.348 V/m; Power Drift = -0.01 dB

Peak SAR (extrapolated) = 0.375 W/kg

SAR(1 g) = 0.168 W/kg; SAR(10 g) = 0.076 W/kg

Maximum value of SAR (measured) = 0.264 W/kg

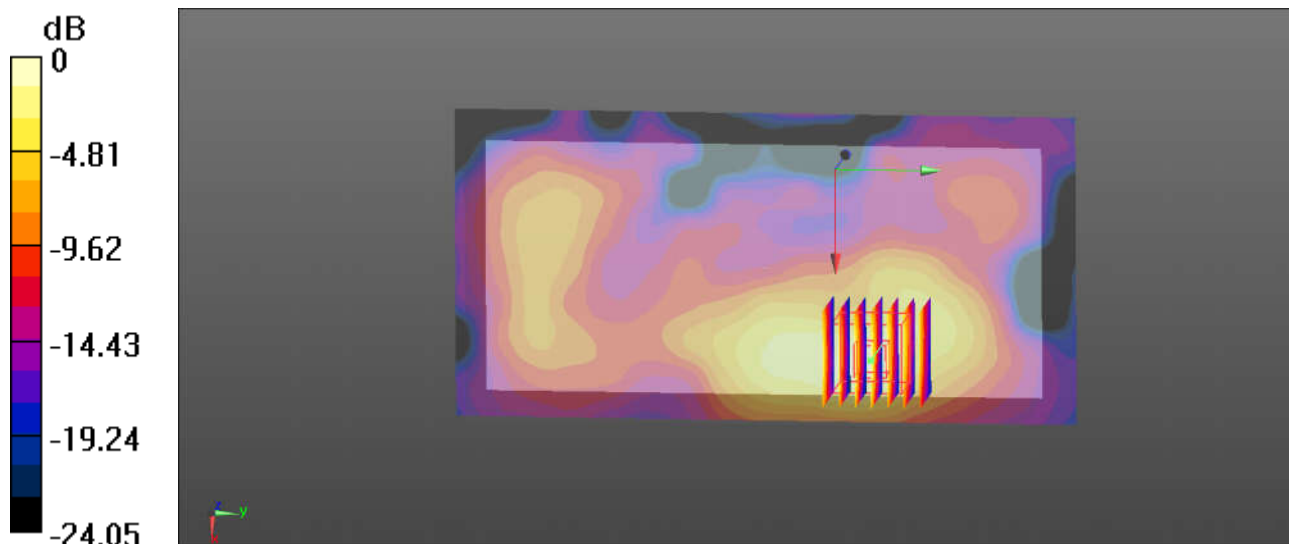

0 dB = 0.264 W/kg

11_WLAN5.2GHz_802.11a 6Mbps_Front_0mm_Ch48

Communication System: UID 0, WIFI (0); Frequency: 5240 MHz; Duty Cycle: 1:1.144
 Medium: MSL_5250_190114 Medium parameters used: $f = 5240$ MHz; $\sigma = 5.271$ S/m; $\epsilon_r = 50.988$; $\rho = 1000$ kg/m³
 Ambient Temperature : 23.4 °C; Liquid Temperature : 22.5 °C

DASY5 Configuration:

- Probe: EX3DV4 - SN3753; ConvF(4.88, 4.88, 4.88); Calibrated: 2018.05.29;
- Sensor-Surface: 1.4mm (Mechanical Surface Detection)
- Electronics: DAE4 Sn1437; Calibrated: 2018.10.15
- Phantom: ELI v4.0; Type: QDOVA002AA; Serial: TP:1149
- Measurement SW: DASY52, Version 52.8 (8); SEMCAD X Version 14.6.10 (7331)

Ch48/Area Scan (101x201x1): Interpolated grid: dx=10mm, dy=10mm
 Maximum value of SAR (interpolated) = 0.159 W/kg

Ch48/Zoom Scan (7x7x7)/Cube 0: Measurement grid: dx=4mm, dy=4mm, dz=1.4mm
 Reference Value = 1.196 V/m; Power Drift = -0.02 dB
 Peak SAR (extrapolated) = 0.137 W/kg
SAR(1 g) = 0.032 W/kg; SAR(10 g) = 0.012 W/kg
 Maximum value of SAR (measured) = 0.0892 W/kg

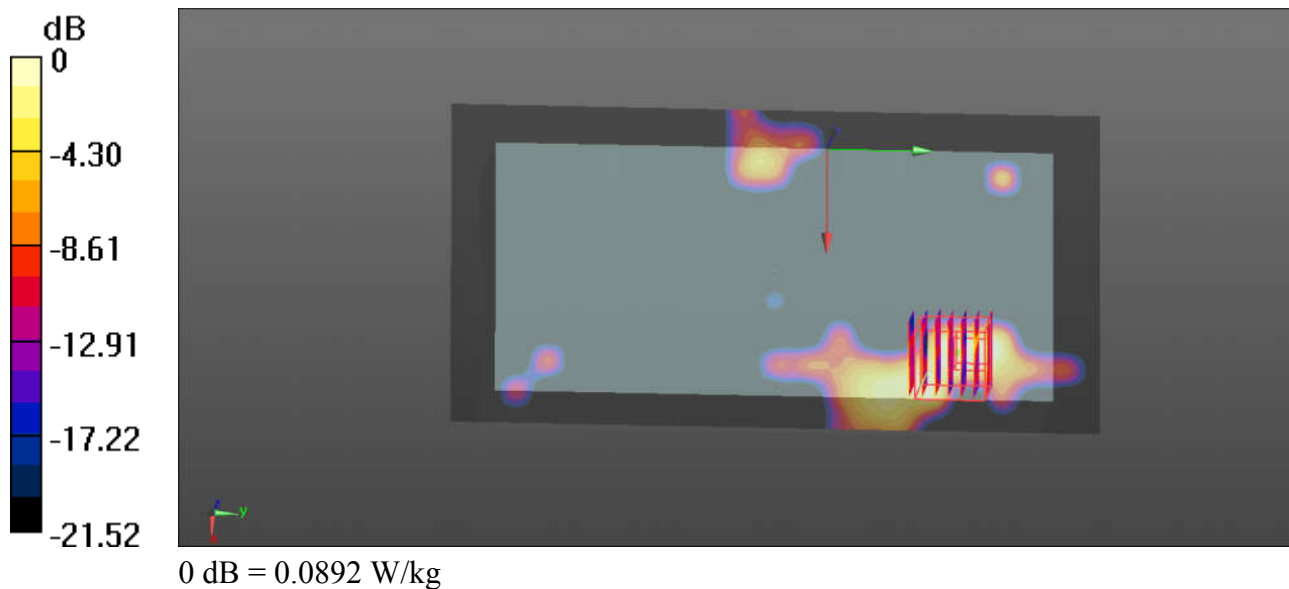

12_WLAN5.8GHz_802.11a 6Mbps_Front_0mm_Ch157

Communication System: UID 0, WIFI (0); Frequency: 5785 MHz; Duty Cycle: 1:1.144
 Medium: MSL_5750_190114 Medium parameters used: $f = 5785$ MHz; $\sigma = 6.161$ S/m; $\epsilon_r = 49.898$; $\rho = 1000$ kg/m³
 Ambient Temperature : 23.4 °C; Liquid Temperature : 22.7 °C

DASY5 Configuration:

- Probe: EX3DV4 - SN3753; ConvF(4.53, 4.53, 4.53); Calibrated: 2018.05.29;
- Sensor-Surface: 1.4mm (Mechanical Surface Detection)
- Electronics: DAE4 Sn1437; Calibrated: 2018.10.15
- Phantom: ELI v4.0; Type: QDOVA002AA; Serial: TP:1149
- Measurement SW: DASY52, Version 52.8 (8); SEMCAD X Version 14.6.10 (7331)

Ch157/Area Scan (101x201x1): Interpolated grid: dx=10mm, dy=10mm
 Maximum value of SAR (interpolated) = 0.304 W/kg

Ch157/Zoom Scan (7x7x7)/Cube 0: Measurement grid: dx=4mm, dy=4mm, dz=1.4mm
 Reference Value = 1.388 V/m; Power Drift = -0.05 dB
 Peak SAR (extrapolated) = 0.576 W/kg
SAR(1 g) = 0.116 W/kg; SAR(10 g) = 0.031 W/kg
 Maximum value of SAR (measured) = 0.342 W/kg

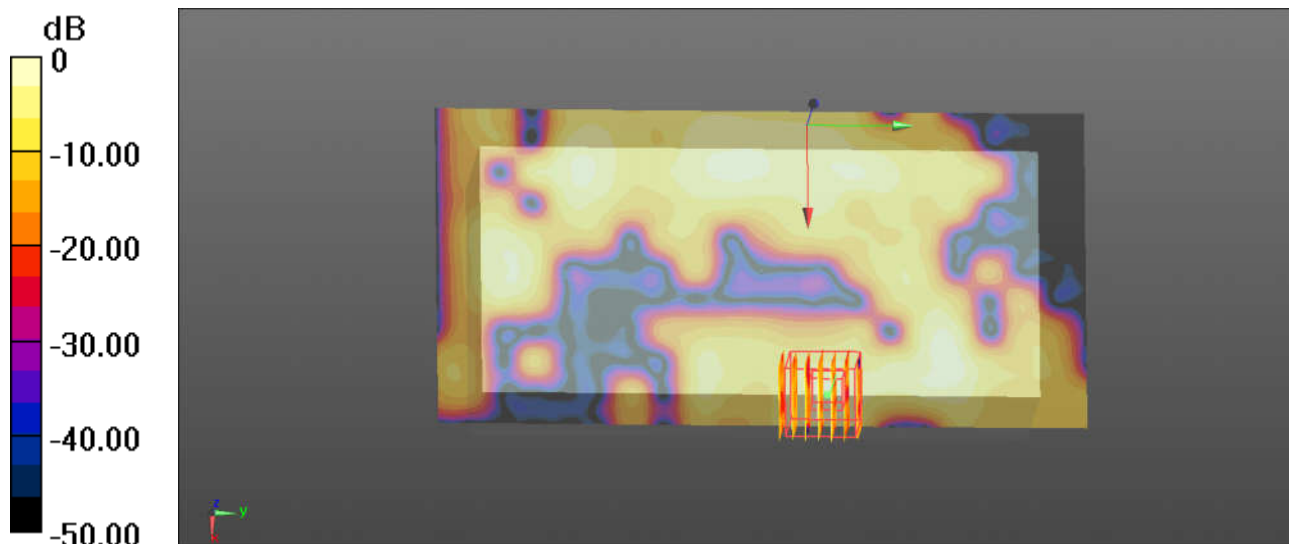

0 dB = 0.342 W/kg

13_Bluetooth_DH5 1Mbps_Front_5mm_Ch0

Communication System: UID 0, Bluetooth (0); Frequency: 2402 MHz; Duty Cycle: 1:1.302
 Medium: MSL_2450_190114 Medium parameters used: $f = 2402$ MHz; $\sigma = 1.878$ S/m; $\epsilon_r = 51.383$; $\rho = 1000$ kg/m³
 Ambient Temperature : 23.4 °C; Liquid Temperature : 22.5 °C

DASY5 Configuration:

- Probe: EX3DV4 - SN3753; ConvF(7.36, 7.36, 7.36); Calibrated: 2018.05.29;
- Sensor-Surface: 2mm (Mechanical Surface Detection)
- Electronics: DAE4 Sn1437; Calibrated: 2018.10.15
- Phantom: ELI v4.0; Type: QDOVA002AA; Serial: TP:1149
- Measurement SW: DASY52, Version 52.8 (8); SEMCAD X Version 14.6.10 (7331)

Ch0/Area Scan (161x81x1): Interpolated grid: dx=12mm, dy=12mm

Maximum value of SAR (interpolated) = 0.0327 W/kg

Ch0/Zoom Scan (7x7x7)/Cube 0: Measurement grid: dx=5mm, dy=5mm, dz=5mm

Reference Value = 1.202 V/m; Power Drift = -0.07 dB

Peak SAR (extrapolated) = 0.0500 W/kg

SAR(1 g) = 0.022 W/kg; SAR(10 g) = 0.00993 W/kg

Maximum value of SAR (measured) = 0.0335 W/kg

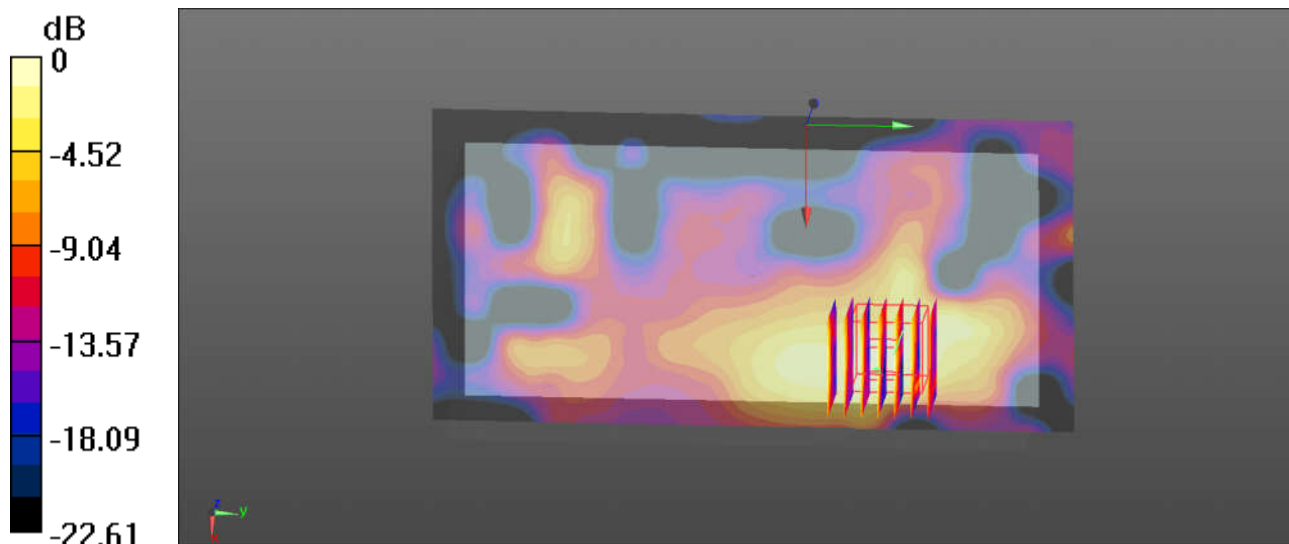

0 dB = 0.0335 W/kg



Appendix C. DASYS Calibration Certificate

The DASYS calibration certificates are shown as follows.



Add: No.51 Xueyuan Road, Haidian District, Beijing, 100191, China
Tel: +86-10-62304633-2079 Fax: +86-10-62304633-2504
E-mail: cttl@chinattl.com http://www.chinattl.cn

Client **Sporton**

Certificate No: **Z18-60532**

CALIBRATION CERTIFICATE

Object **D750V3 - SN: 1099**

Calibration Procedure(s) **FF-Z11-003-01**
Calibration Procedures for dipole validation kits

Calibration date: **December 6, 2018**

This calibration Certificate documents the traceability to national standards, which realize the physical units of measurements(SI). The measurements and the uncertainties with confidence probability are given on the following pages and are part of the certificate.

All calibrations have been conducted in the closed laboratory facility: environment temperature(22±3)°C and humidity<70%.

Calibration Equipment used (M&TE critical for calibration)

Primary Standards	ID #	Cal Date(Calibrated by, Certificate No.)	Scheduled Calibration
Power Meter NRVD	102196	07-Mar-18 (CTTL, No.J18X01510)	Mar-19
Power sensor NRV-Z5	100596	07-Mar-18 (CTTL, No.J18X01510)	Mar-19
Reference Probe EX3DV4	SN 7514	27-Aug-18(SPEAG,No.EX3-7514_Aug18)	Aug-19
DAE4	SN 1555	20-Aug-18(SPEAG,No.DAE4-1555_Aug18)	Aug-19
Secondary Standards	ID #	Cal Date(Calibrated by, Certificate No.)	Scheduled Calibration
Signal Generator E4438C	MY49071430	23-Jan-18 (CTTL, No.J18X00560)	Jan-19
NetworkAnalyzer E5071C	MY46110673	24-Jan-18 (CTTL, No.J18X00561)	Jan-19

	Name	Function
Calibrated by:	Zhao Jing	SAR Test Engineer
Reviewed by:	Lin Hao	SAR Test Engineer
Approved by:	Qi Dianyuan	SAR Project Leader

Signature

Issued: December 9, 2018

This calibration certificate shall not be reproduced except in full without written approval of the laboratory.



In Collaboration with

s p e a g
CALIBRATION LABORATORY

Add: No.51 Xueyuan Road, Haidian District, Beijing, 100191, China
Tel: +86-10-62304633-2079 Fax: +86-10-62304633-2504
E-mail: cttl@chinattl.com http://www.chinattl.cn

Glossary:

TSL	tissue simulating liquid
ConvF	sensitivity in TSL / NORM _{x,y,z}
N/A	not applicable or not measured

Calibration is Performed According to the Following Standards:

- IEEE Std 1528-2013, "IEEE Recommended Practice for Determining the Peak Spatial-Averaged Specific Absorption Rate (SAR) in the Human Head from Wireless Communications Devices: Measurement Techniques", June 2013
- IEC 62209-1, "Measurement procedure for assessment of specific absorption rate of human exposure to radio frequency fields from hand-held and body-mounted wireless communication devices- Part 1: Device used next to the ear (Frequency range of 300MHz to 6GHz)", July 2016
- IEC 62209-2, "Procedure to measure the Specific Absorption Rate (SAR) For wireless communication devices used in close proximity to the human body (frequency range of 30MHz to 6GHz)", March 2010
- KDB865664, SAR Measurement Requirements for 100 MHz to 6 GHz

Additional Documentation:

- DASY4/5 System Handbook

Methods Applied and Interpretation of Parameters:

- Measurement Conditions:** Further details are available from the Validation Report at the end of the certificate. All figures stated in the certificate are valid at the frequency indicated.
- Antenna Parameters with TSL:** The dipole is mounted with the spacer to position its feed point exactly below the center marking of the flat phantom section, with the arms oriented parallel to the body axis.
- Feed Point Impedance and Return Loss:** These parameters are measured with the dipole positioned under the liquid filled phantom. The impedance stated is transformed from the measurement at the SMA connector to the feed point. The Return Loss ensures low reflected power. No uncertainty required.
- Electrical Delay:** One-way delay between the SMA connector and the antenna feed point. No uncertainty required.
- SAR measured:** SAR measured at the stated antenna input power.
- SAR normalized:** SAR as measured, normalized to an input power of 1 W at the antenna connector.
- SAR for nominal TSL parameters:** The measured TSL parameters are used to calculate the nominal SAR result.

The reported uncertainty of measurement is stated as the standard uncertainty of Measurement multiplied by the coverage factor $k=2$, which for a normal distribution Corresponds to a coverage probability of approximately 95%.



Add: No.51 Xueyuan Road, Haidian District, Beijing, 100191, China
 Tel: +86-10-62304633-2079 Fax: +86-10-62304633-2504
 E-mail: cttl@chinattl.com http://www.chinattl.cn

Measurement Conditions

DASY system configuration, as far as not given on page 1.

DASY Version	DASY52	52.10.2.1495
Extrapolation	Advanced Extrapolation	
Phantom	Triple Flat Phantom 5.1C	
Distance Dipole Center - TSL	15 mm	with Spacer
Zoom Scan Resolution	dx, dy, dz = 5 mm	
Frequency	750 MHz ± 1 MHz	

Head TSL parameters

The following parameters and calculations were applied.

	Temperature	Permittivity	Conductivity
Nominal Head TSL parameters	22.0 °C	41.9	0.89 mho/m
Measured Head TSL parameters	(22.0 ± 0.2) °C	43.1 ± 6 %	0.87 mho/m ± 6 %
Head TSL temperature change during test	<1.0 °C	---	---

SAR result with Head TSL

SAR averaged over 1 cm ³ (1 g) of Head TSL	Condition	
SAR measured	250 mW input power	2.07 mW / g
SAR for nominal Head TSL parameters	normalized to 1W	8.52 mW / g ± 18.8 % (k=2)
SAR averaged over 10 cm ³ (10 g) of Head TSL	Condition	
SAR measured	250 mW input power	1.38 mW / g
SAR for nominal Head TSL parameters	normalized to 1W	5.64 mW / g ± 18.7 % (k=2)

Body TSL parameters

The following parameters and calculations were applied.

	Temperature	Permittivity	Conductivity
Nominal Body TSL parameters	22.0 °C	55.5	0.96 mho/m
Measured Body TSL parameters	(22.0 ± 0.2) °C	54.0 ± 6 %	0.95 mho/m ± 6 %
Body TSL temperature change during test	<1.0 °C	---	---

SAR result with Body TSL

SAR averaged over 1 cm ³ (1 g) of Body TSL	Condition	
SAR measured	250 mW input power	2.15 mW / g
SAR for nominal Body TSL parameters	normalized to 1W	8.61 mW / g ± 18.8 % (k=2)
SAR averaged over 10 cm ³ (10 g) of Body TSL	Condition	
SAR measured	250 mW input power	1.44 mW / g
SAR for nominal Body TSL parameters	normalized to 1W	5.77 mW / g ± 18.7 % (k=2)



Add: No.51 Xueyuan Road, Haidian District, Beijing, 100191, China
Tel: +86-10-62304633-2079 Fax: +86-10-62304633-2504
E-mail: cttl@chinattl.com http://www.chinattl.cn

Appendix (Additional assessments outside the scope of CNAS L0570)

Antenna Parameters with Head TSL

Impedance, transformed to feed point	54.2 Ω - 1.12j Ω
Return Loss	- 27.7dB

Antenna Parameters with Body TSL

Impedance, transformed to feed point	49.8 Ω - 3.37j Ω
Return Loss	- 29.4dB

General Antenna Parameters and Design

Electrical Delay (one direction)	0.900 ns
----------------------------------	----------

After long term use with 100W radiated power, only a slight warming of the dipole near the feedpoint can be measured.

The dipole is made of standard semirigid coaxial cable. The center conductor of the feeding line is directly connected to the second arm of the dipole. The antenna is therefore short-circuited for DC-signals. On some of the dipoles, small end caps are added to the dipole arms in order to improve matching when loaded according to the position as explained in the "Measurement Conditions" paragraph. The SAR data are not affected by this change. The overall dipole length is still according to the Standard. No excessive force must be applied to the dipole arms, because they might bend or the soldered connections near the feedpoint may be damaged.

Additional EUT Data

Manufactured by	SPEAG
-----------------	-------



In Collaboration with

s p e a g
CALIBRATION LABORATORY

Add: No.51 Xueyuan Road, Haidian District, Beijing, 100191, China
Tel: +86-10-62304633-2079 Fax: +86-10-62304633-2504
E-mail: cttl@chinattl.com http://www.chinattl.cn

DASY5 Validation Report for Head TSL

Date: 12.05.2018

Test Laboratory: CTTL, Beijing, China

DUT: Dipole 750 MHz; Type: D750V3; Serial: D750V3 - SN: 1099

Communication System: UID 0, CW; Frequency: 750 MHz; Duty Cycle: 1:1

Medium parameters used: $f = 750$ MHz; $\sigma = 0.865$ S/m; $\epsilon_r = 43.13$; $\rho = 1000$ kg/m³

Phantom section: Right Section

DASY5 Configuration:

- Probe: EX3DV4 - SN7514; ConvF(9.47, 9.47, 9.47) @ 750 MHz; Calibrated: 8/27/2018
- Sensor-Surface: 1.4mm (Mechanical Surface Detection)
- Electronics: DAE4 Sn1555; Calibrated: 8/20/2018
- Phantom: MFP_V5.1C ; Type: QD 000 P51CA; Serial: 1062
- Measurement SW: DASY52, Version 52.10 (2); SEMCAD X Version 14.6.12 (7450)

Dipole Calibration/Zoom Scan (7x7x7) (7x7x7)/Cube 0: Measurement grid: dx=5mm, dy=5mm, dz=5mm

Reference Value = 53.37 V/m; Power Drift = 0.00 dB

Peak SAR (extrapolated) = 3.12 W/kg

SAR(1 g) = 2.07 W/kg; SAR(10 g) = 1.38 W/kg

Maximum value of SAR (measured) = 2.75 W/kg

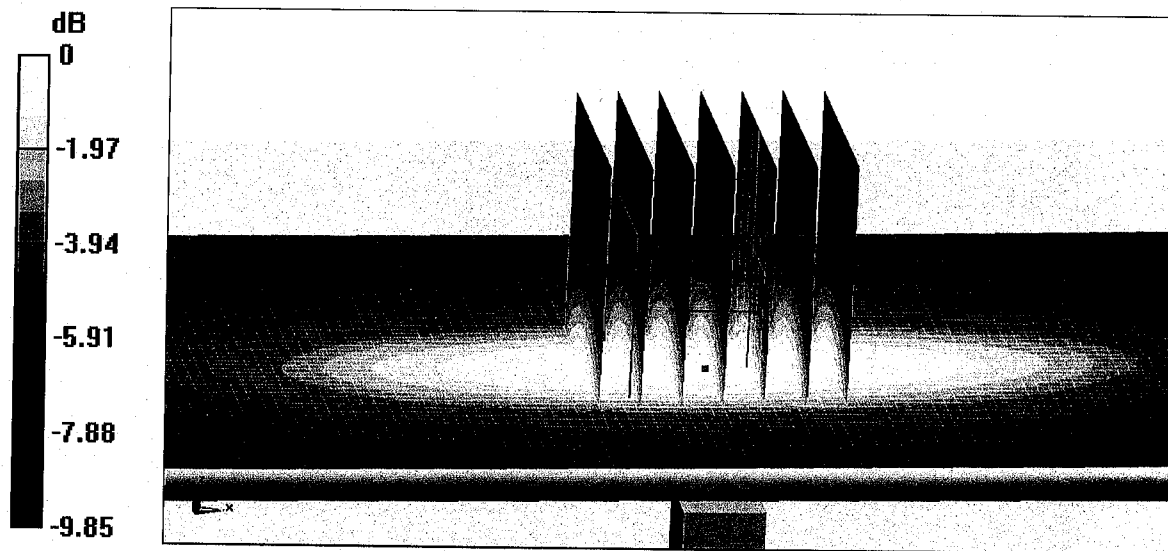

0 dB = 2.75 W/kg = 4.39 dBW/kg



Add: No.51 Xueyuan Road, Haidian District, Beijing, 100191, China
Tel: +86-10-62304633-2079 Fax: +86-10-62304633-2504
E-mail: cttl@chinattl.com http://www.chinattl.cn

Impedance Measurement Plot for Head TSL

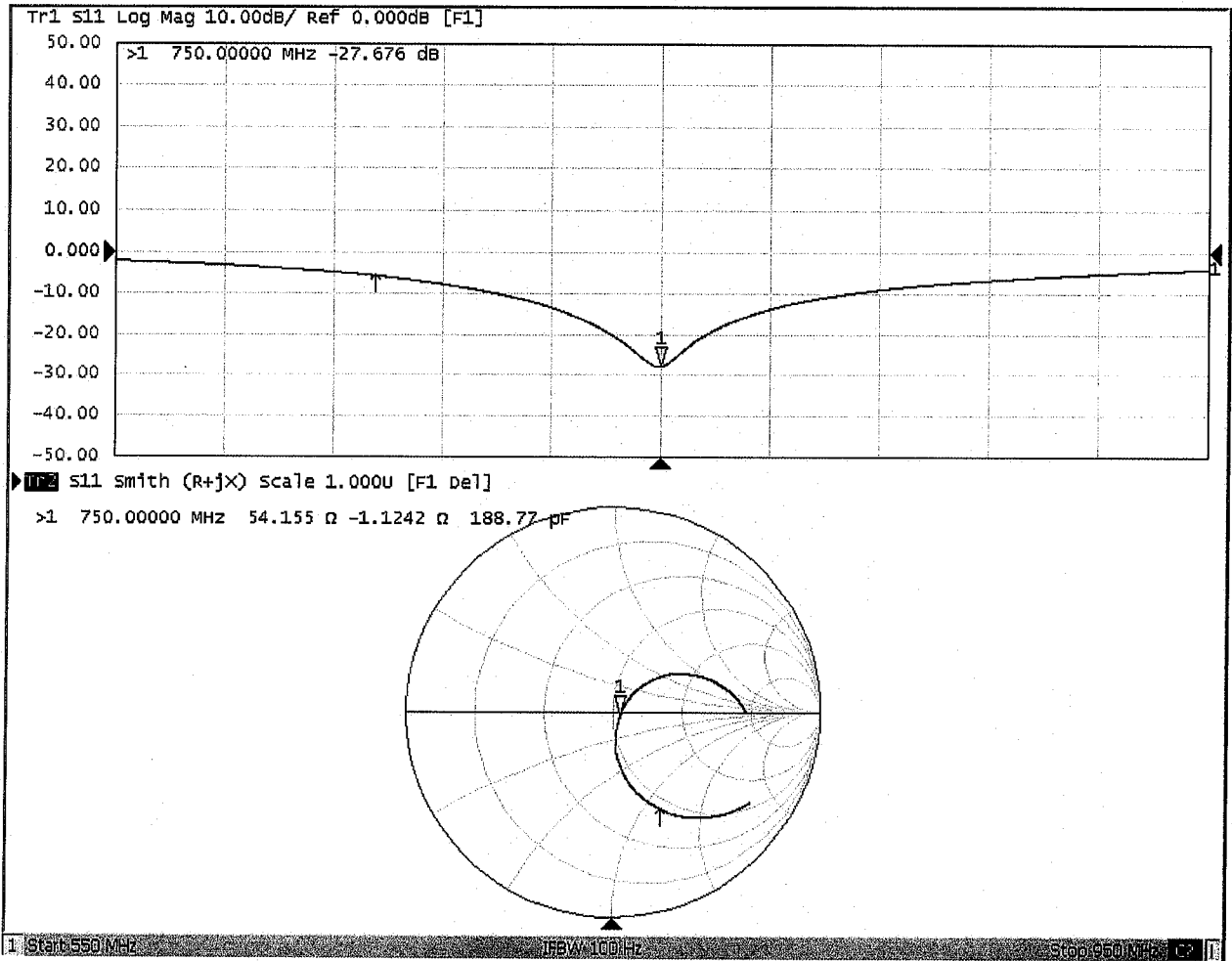



Add: No.51 Xueyuan Road, Haidian District, Beijing, 100191, China
Tel: +86-10-62304633-2079 Fax: +86-10-62304633-2504
E-mail: cttl@chinattl.com http://www.chinattl.cn

DASY5 Validation Report for Body TSL

Date: 12.05.2018

Test Laboratory: CTTL, Beijing, China

DUT: Dipole 750 MHz; Type: D750V3; Serial: D750V3 - SN: 1099

Communication System: UID 0, CW; Frequency: 750 MHz; Duty Cycle: 1:1

Medium parameters used: $f = 750$ MHz; $\sigma = 0.951$ S/m; $\epsilon_r = 54.02$; $\rho = 1000$ kg/m³

Phantom section: Center Section

DASY5 Configuration:

- Probe: EX3DV4 - SN7514; ConvF(9.68, 9.68, 9.68) @ 750 MHz; Calibrated: 8/27/2018
- Sensor-Surface: 1.4mm (Mechanical Surface Detection)
- Electronics: DAE4 Sn1555; Calibrated: 8/20/2018
- Phantom: MFP_V5.1C ; Type: QD 000 P51CA; Serial: 1062
- Measurement SW: DASY52, Version 52.10 (2); SEMCAD X Version 14.6.12 (7450)

Dipole Calibration/Zoom Scan (7x7x7) (7x7x7)/Cube 0: Measurement grid: dx=5mm, dy=5mm, dz=5mm

Reference Value = 51.51 V/m; Power Drift = -0.07 dB

Peak SAR (extrapolated) = 3.29 W/kg

SAR(1 g) = 2.15 W/kg; SAR(10 g) = 1.44 W/kg

Maximum value of SAR (measured) = 2.88 W/kg

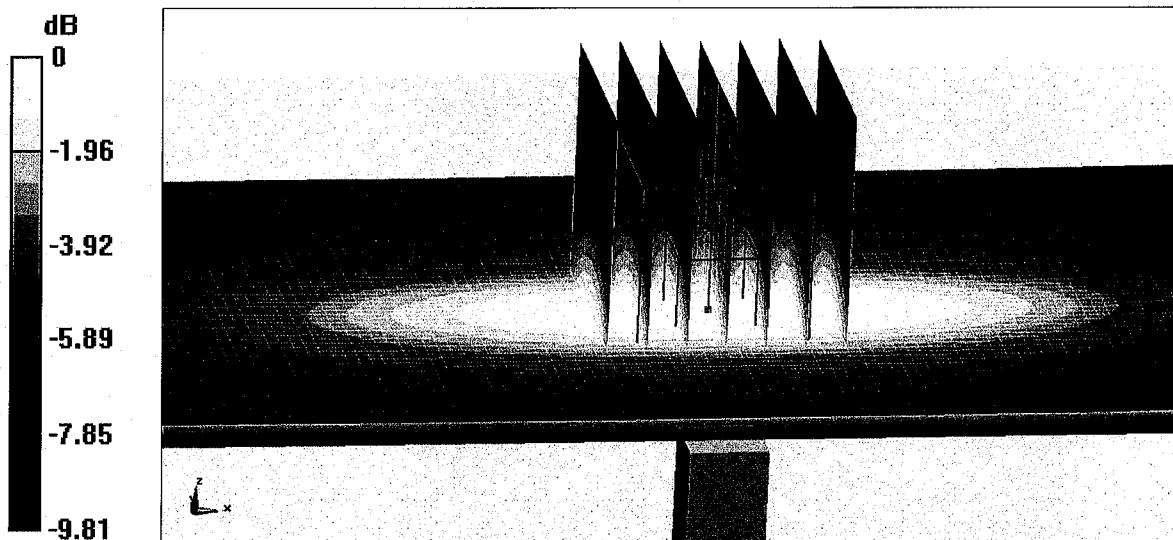

0 dB = 2.88 W/kg = 4.59 dBW/kg



Add: No.51 Xueyuan Road, Haidian District, Beijing, 100191, China
Tel: +86-10-62304633-2079 Fax: +86-10-62304633-2504
E-mail: cttl@chinattl.com http://www.chinattl.cn

Impedance Measurement Plot for Body TSL

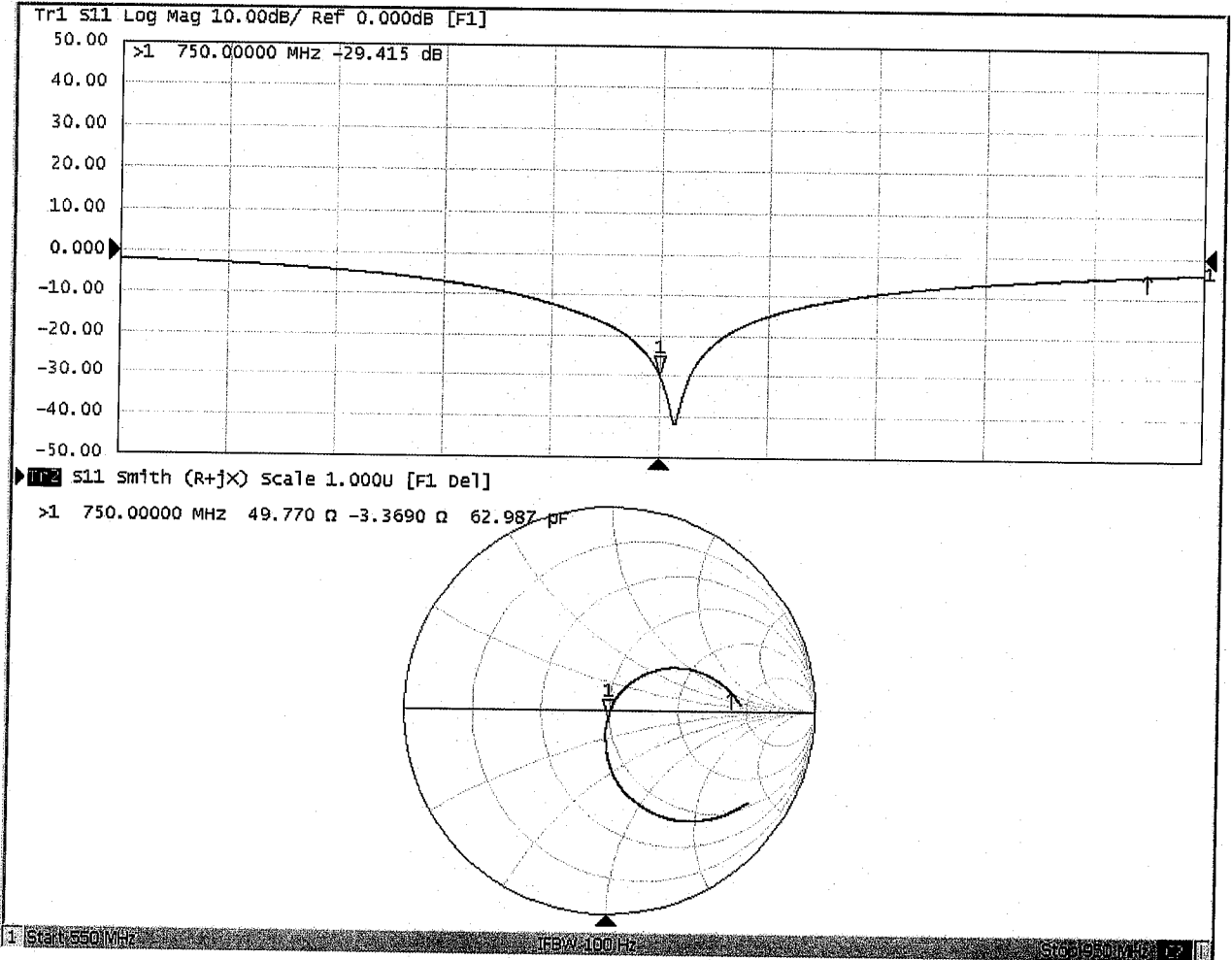



In Collaboration with
s p e a g
 CALIBRATION LABORATORY



中国认可
 国际互认
 校准
 CALIBRATION
 CNAS L0570

Add: No.51 Xueyuan Road, Haidian District, Beijing, 100191, China
 Tel: +86-10-62304633-2079 Fax: +86-10-62304633-2504
 E-mail: cttl@chinattl.com http://www.chinattl.cn

Client **Sporton**

Certificate No: **Z18-60533**

CALIBRATION CERTIFICATE

Object **D835V2 - SN: 4d162**

Calibration Procedure(s) **FF-Z11-003-01**
Calibration Procedures for dipole validation kits

Calibration date: **December 5, 2018**

This calibration Certificate documents the traceability to national standards, which realize the physical units of measurements(SI). The measurements and the uncertainties with confidence probability are given on the following pages and are part of the certificate.

All calibrations have been conducted in the closed laboratory facility: environment temperature(22±3)°C and humidity<70%.

Calibration Equipment used (M&TE critical for calibration)

Primary Standards	ID #	Cal Date(Calibrated by, Certificate No.)	Scheduled Calibration
Power Meter NRVD	102196	07-Mar-18 (CTTL, No.J18X01510)	Mar-19
Power sensor NRV-Z5	100596	07-Mar-18 (CTTL, No.J18X01510)	Mar-19
Reference Probe EX3DV4	SN 7514	27-Aug-18(SPEAG,No.EX3-7514_Aug18)	Aug-19
DAE4	SN 1555	20-Aug-18(SPEAG,No.DAE4-1555_Aug18)	Aug-19
Secondary Standards	ID #	Cal Date(Calibrated by, Certificate No.)	Scheduled Calibration
Signal Generator E4438C	MY49071430	23-Jan-18 (CTTL, No.J18X00560)	Jan-19
NetworkAnalyzer E5071C	MY46110673	24-Jan-18 (CTTL, No.J18X00561)	Jan-19

	Name	Function	Signature
Calibrated by:	Zhao Jing	SAR Test Engineer	
Reviewed by:	Lin Hao	SAR Test Engineer	
Approved by:	Qi Dianyuan	SAR Project Leader	

Issued: December 8, 2018

This calibration certificate shall not be reproduced except in full without written approval of the laboratory.



Add: No.51 Xueyuan Road, Haidian District, Beijing, 100191, China
Tel: +86-10-62304633-2079 Fax: +86-10-62304633-2504
E-mail: cttl@chinattl.com http://www.chinattl.cn

Glossary:

TSL	tissue simulating liquid
ConvF	sensitivity in TSL / NORM _{x,y,z}
N/A	not applicable or not measured

Calibration is Performed According to the Following Standards:

- a) IEEE Std 1528-2013, "IEEE Recommended Practice for Determining the Peak Spatial-Averaged Specific Absorption Rate (SAR) in the Human Head from Wireless Communications Devices: Measurement Techniques", June 2013
- b) IEC 62209-1, "Measurement procedure for assessment of specific absorption rate of human exposure to radio frequency fields from hand-held and body-mounted wireless communication devices- Part 1: Device used next to the ear (Frequency range of 300MHz to 6GHz)", July 2016
- c) IEC 62209-2, "Procedure to measure the Specific Absorption Rate (SAR) For wireless communication devices used in close proximity to the human body (frequency range of 30MHz to 6GHz)", March 2010
- d) KDB865664, SAR Measurement Requirements for 100 MHz to 6 GHz

Additional Documentation:

- e) DASY4/5 System Handbook

Methods Applied and Interpretation of Parameters:

- *Measurement Conditions:* Further details are available from the Validation Report at the end of the certificate. All figures stated in the certificate are valid at the frequency indicated.
- *Antenna Parameters with TSL:* The dipole is mounted with the spacer to position its feed point exactly below the center marking of the flat phantom section, with the arms oriented parallel to the body axis.
- *Feed Point Impedance and Return Loss:* These parameters are measured with the dipole positioned under the liquid filled phantom. The impedance stated is transformed from the measurement at the SMA connector to the feed point. The Return Loss ensures low reflected power. No uncertainty required.
- *Electrical Delay:* One-way delay between the SMA connector and the antenna feed point. No uncertainty required.
- *SAR measured:* SAR measured at the stated antenna input power.
- *SAR normalized:* SAR as measured, normalized to an input power of 1 W at the antenna connector.
- *SAR for nominal TSL parameters:* The measured TSL parameters are used to calculate the nominal SAR result.

The reported uncertainty of measurement is stated as the standard uncertainty of Measurement multiplied by the coverage factor $k=2$, which for a normal distribution Corresponds to a coverage probability of approximately 95%.