

**CFR 47 FCC PART 15 SUBPART C
ISED RSS-247 ISSUE 2**

TEST REPORT

For

Smart Mobile Payment Terminal

MODEL NUMBER: A910S

REPORT NUMBER: 4790824205-1-RF-2

ISSUE DATE: June 9, 2023

FCC ID: V5PA910S

IC: 11689A-A910S

Prepared for

**PAX Technology Limited
Room 2416, 24/F., Sun Hung Kai Centre, 30 Harbour Road, Wanchai, Hong Kong**

Prepared by

UL Verification Services (Guangzhou) Co., Ltd, Song Shan Lake Branch

Building 10, Innovation Technology Park, No. 1, Li Bin Road, Song Shan Lake Hi-Tech Development Zone Dongguan, 523808, People's Republic of China

Tel: +86 769 22038881

Fax: +86 769 33244054

Website: www.ul.com

Revision History

Rev.	Issue Date	Revisions	Revised By
V0	June 9, 2023	Initial Issue	

Summary of Test Results

Test Item	Clause	Limit/Requirement	Result
Antenna Requirement	N/A	FCC 15.203 RSS-GEN Clause 6.8	Pass
AC Power Line Conducted Emission	ANSI C63.10-2013 Clause 6.2	FCC Part 15.207	Pass
Conducted Output Power	ANSI C63.10-2013 Clause 7.8.5	FCC 15.247 (b) (1) RSS-247 Clause 5.1 (b)	Pass
20 dB Bandwidth and 99% Occupied Bandwidth	ANSI C63.10-2013 Clause 6.9.2	FCC 15.247 (a) (1) RSS-247 Clause 5.1 (a) RSS-Gen Clause 6.7	Pass
Carrier Hopping Channel Separation	ANSI C63.10-2013 Clause 7.8.2	FCC 15.247 (a) (1) RSS-247 Clause 5.1 (b)	Pass
Number of Hopping Frequency	ANSI C63.10-2013 Clause 7.8.3	15.247 (a) (1) III RSS-247 Clause 5.1 (d)	Pass
Time of Occupancy (Dwell Time)	ANSI C63.10-2013 Clause 7.8.4	15.247 (a) (1) III RSS-247 Clause 5.1 (d)	Pass
Conducted Bandedge and Spurious Emission	ANSI C63.10-2013 Clause 6.10.4 & Clause 7.8.8	FCC 15.247 (d) RSS-247 Clause 5.5	Pass
Radiated Band edge and Spurious Emission	ANSI C63.10-2013 Clause 6.3 & 6.5 & 6.6	FCC 15.247 (d) FCC 15.209 FCC 15.205 RSS-247 Clause 5.5 RSS-GEN Clause 8.9 RSS-GEN Clause 8.10	Pass
Duty Cycle	ANSI C63.10-2013, Clause 11.6	None; for reporting purposes only.	Pass

*This test report is only published to and used by the applicant, and it is not for evidence purpose in China.

*The measurement result for the sample received is <Pass> according to <CFR 47 FCC PART 15 SUBPART C ISED RSS-247 ISSUE 2> when <Accuracy Method> decision rule is applied.

CONTENTS

1. ATTESTATION OF TEST RESULTS	6
2. TEST METHODOLOGY	7
3. FACILITIES AND ACCREDITATION	7
4. CALIBRATION AND UNCERTAINTY	8
4.1. <i>MEASURING INSTRUMENT CALIBRATION</i>	8
4.2. <i>MEASUREMENT UNCERTAINTY</i>	8
5. EQUIPMENT UNDER TEST	9
5.1. <i>DESCRIPTION OF EUT</i>	9
5.2. <i>CHANNEL LIST</i>	10
5.3. <i>MAXIMUM POWER</i>	10
5.4. <i>TEST CHANNEL CONFIGURATION</i>	11
5.5. <i>PACKET TYPE CONFIGURATION</i>	11
5.6. <i>THE WORSE CASE POWER SETTING PARAMETER</i>	11
5.7. <i>DESCRIPTION OF AVAILABLE ANTENNAS</i>	12
5.8. <i>SUPPORT UNITS FOR SYSTEM TEST</i>	13
6. MEASURING EQUIPMENT AND SOFTWARE USED	15
7. ANTENNA PORT TEST RESULTS	18
7.1. <i>CONDUCTED OUTPUT POWER</i>	18
7.2. <i>20 DB BANDWIDTH AND 99% OCCUPIED BANDWIDTH</i>	19
7.3. <i>CARRIER HOPPING CHANNEL SEPARATION</i>	21
7.4. <i>NUMBER OF HOPPING FREQUENCY</i>	23
7.5. <i>TIME OF OCCUPANCY (DWELL TIME)</i>	25
7.6. <i>CONDUCTED BANDEDGE AND SPURIOUS EMISSION</i>	27
7.7. <i>DUTY CYCLE</i>	29
8. RADIATED TEST RESULTS	30
8.1. <i>RESTRICTED BANDEDGE</i>	38
8.2. <i>SPURIOUS EMISSIONS(1 GHZ~3 GHZ)</i>	43
8.3. <i>SPURIOUS EMISSIONS(3 GHZ~18 GHZ)</i>	49
8.4. <i>SPURIOUS EMISSIONS(9 KHZ~30 MHZ)</i>	61
8.5. <i>SPURIOUS EMISSIONS(18 GHZ~26 GHZ)</i>	64
8.6. <i>SPURIOUS EMISSIONS(30 MHZ~1 GHZ)</i>	66

9.	ANTENNA REQUIREMENT	68
10.	AC POWER LINE CONDUCTED EMISSION	69
11.	TEST DATA	73
11.1.	<i>APPENDIX A: 20DB EMISSION BANDWIDTH</i>	73
11.1.1.	Test Result	73
11.1.2.	Test Graphs	74
11.2.	<i>APPENDIX B: OCCUPIED CHANNEL BANDWIDTH</i>	76
11.2.1.	Test Result	76
11.2.2.	Test Graphs	77
11.3.	<i>APPENDIX C: MAXIMUM CONDUCTED OUTPUT POWER</i>	79
11.3.1.	Test Result	79
11.4.	<i>APPENDIX D: CARRIER FREQUENCY SEPARATION</i>	80
11.4.1.	Test Result	80
11.4.2.	Test Graphs	81
11.5.	<i>APPENDIX E: TIME OF OCCUPANCY</i>	82
11.5.1.	Test Result	82
11.5.2.	Test Graphs	83
11.6.	<i>APPENDIX F: NUMBER OF HOPPING CHANNELS</i>	85
11.6.1.	Test Result	85
11.6.2.	Test Graphs	86
11.7.	<i>APPENDIX G: BAND EDGE MEASUREMENTS</i>	87
11.7.1.	Test Result	87
11.7.2.	Test Graphs	88
11.8.	<i>APPENDIX H: CONDUCTED SPURIOUS EMISSION</i>	91
11.8.1.	Test Result	91
11.8.2.	Test Graphs	92
11.9.	<i>APPENDIX I: DUTY CYCLE</i>	98
11.9.1.	Test Result	98
11.9.2.	Test Graphs	99

1. ATTESTATION OF TEST RESULTS

Applicant Information

Company Name: PAX Technology Limited
Address: Room 2416, 24/F., Sun Hung Kai Centre, 30 Harbour Road, Wanchai, Hong Kong

Manufacturer Information

Company Name: PAX Computer Technology (Shenzhen) Co., Ltd.
Address: 401 and 402, Building 3, Shenzhen Software Park, Nanshan District, Shenzhen City, Guangdong Province, P.R.C

EUT Information

EUT Name: Smart Mobile Payment Terminal
Model: A910S
Sample Received Date: April 23, 2023
Sample Status: Normal
Sample ID: 6024466
Date of Tested: May 5, 2023 to June 7, 2023

APPLICABLE STANDARDS	
STANDARD	TEST RESULTS
CFR 47 FCC PART 15 SUBPART C ISED RSS-247 ISSUE 2	Pass

Prepared By:

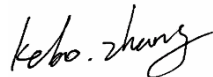

Kebo Zhang
Senior Project Engineer

Checked By:

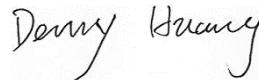

Denny Huang
Senior Project Engineer

Approved By:



Stephen Guo
Operations Manager

2. TEST METHODOLOGY

All tests were performed in accordance with the standard CFR 47 FCC PART 15 SUBPART C ISED RSS-247 ISSUE 2, KDB 558074 D01 15.247 Meas Guidance v05r02, 414788 D01 Radiated Test Site v01r01, CFR 47 FCC Part 2, ANSI C63.10-2013 and ISED RSS-GEN Issue 5.

3. FACILITIES AND ACCREDITATION

Accreditation Certificate	<p>A2LA (Certificate No.: 4102.01) UL Verification Services (Guangzhou) Co., Ltd. Song Shan Lake Branch. has been assessed and proved to be in compliance with A2LA.</p> <p>FCC (FCC Designation No.: CN1187) UL Verification Services (Guangzhou) Co., Ltd. Song Shan Lake Branch. Has been recognized to perform compliance testing on equipment subject to the Commission's Declaration of Conformity (DoC) and Certification rules</p> <p>ISED (Company No.: 21320) UL Verification Services (Guangzhou) Co., Ltd. Song Shan Lake Branch. has been registered and fully described in a report filed with ISED. The Company Number is 21320 and the test lab Conformity Assessment Body Identifier (CABID) is CN0046.</p> <p>VCCI (Registration No.: G-20019, R-20004, C-20012 and T-20011) UL Verification Services (Guangzhou) Co., Ltd. Song Shan Lake Branch. has been assessed and proved to be in compliance with VCCI, the Membership No. is 3793. Facility Name: Chamber D, the VCCI registration No. is G-20019 and R-20004 Shielding Room B , the VCCI registration No. is C-20012 and T-20011</p>
---------------------------	--

Note 1:

All tests measurement facilities use to collect the measurement data are located at Building 10, Innovation Technology Park, No. 1, Li Bin Road, Song Shan Lake Hi-Tech Development Zone Dongguan, 523808, People's Republic of China.

Note 2:

The test anechoic chamber in UL Verification Services (Guangzhou) Co., Ltd. Song Shan Lake Branch had been calibrated and compared to the open field sites and the test anechoic chamber is shown to be equivalent to or worst case from the open field site.

Note 3:

For below 30 MHz, lab had performed measurements at test anechoic chamber and comparing to measurements obtained on an open field site. And these measurements below 30 MHz had been correlated to measurements performed on an OFS.

4. CALIBRATION AND UNCERTAINTY

4.1. MEASURING INSTRUMENT CALIBRATION

The measuring equipment utilized to perform the tests documented in this report has been calibrated in accordance with the manufacturer's recommendations and is traceable to recognized national standards.

4.2. MEASUREMENT UNCERTAINTY

Where relevant, the following measurement uncertainty levels have been estimated for tests performed on the apparatus:

Test Item	Uncertainty
Conduction emission	3.62 dB
Radiated Emission (Included Fundamental Emission) (9 kHz ~ 30 MHz)	2.2 dB
Radiated Emission (Included Fundamental Emission) (30 MHz ~ 1 GHz)	4.00 dB
Radiated Emission (Included Fundamental Emission) (1 GHz to 26 GHz)	5.78 dB (1 GHz ~ 18 GHz)
	5.23 dB (18 GHz ~ 26 GHz)
Duty Cycle	±0.028%
20dB Emission Bandwidth and 99% Occupied Bandwidth	±0.0196%
Carrier Frequency Separation	±1.9%
Maximum Conducted Output Power	±0.743 dB
Number of Hopping Channel	±1.9%
Time of Occupancy	±0.028%
Conducted Band-edge Compliance	±1.328 dB
Conducted Unwanted Emissions In Non-restricted Frequency Bands	±0.746 dB (9 kHz ~ 1 GHz)
	±1.328dB (1 GHz ~ 26 GHz)
Note: This uncertainty represents an expanded uncertainty expressed at approximately the 95% confidence level using a coverage factor of k=2.	

5. EQUIPMENT UNDER TEST

5.1. DESCRIPTION OF EUT

EUT Name	Smart Mobile Payment Terminal
Model	A910S

Technology	Bluetooth – BR & EDR		
Transmit Frequency Range	2402 MHz ~ 2480 MHz		
Mode	Basic Rate	Enhanced Data Rate	
Modulation	GFSK	π/4-DQPSK	8DPSK
Packet Type (Maximum Payload):	DH5	2DH5	3DH5
Data Rate	1 Mbps	2 Mbps	3 Mbps
Rated Input	DC 5 V, 2 A		
Battery	7.2 Vdc		

5.2. CHANNEL LIST

Channel	Frequency (MHz)	Channel	Frequency (MHz)	Channel	Frequency (MHz)	Channel	Frequency (MHz)
00	2402	20	2422	40	2442	60	2462
01	2403	21	2423	41	2443	61	2463
02	2404	22	2424	42	2444	62	2464
03	2405	23	2425	43	2445	63	2465
04	2406	24	2426	44	2446	64	2466
05	2407	25	2427	45	2447	65	2467
06	2408	26	2428	46	2448	66	2468
07	2409	27	2429	47	2449	67	2469
08	2410	28	2430	48	2450	68	2470
09	2411	29	2431	49	2451	69	2471
10	2412	30	2432	50	2452	70	2472
11	2413	31	2433	51	2453	71	2473
12	2414	32	2434	52	2454	72	2474
13	2415	33	2435	53	2455	73	2475
14	2416	34	2436	54	2456	74	2476
15	2417	35	2437	55	2457	75	2477
16	2418	36	2438	56	2458	76	2478
17	2419	37	2439	57	2459	77	2479
18	2420	38	2440	58	2460	78	2480
19	2421	39	2441	59	2461	/	/

5.3. MAXIMUM POWER

Test Mode	Frequency (MHz)	Channel Number	Maximum Peak Output Power (dBm)
GFSK	2402 ~ 2480	0-78[79]	5.73
8DPSK	2402 ~ 2480	0-78[79]	7.31

5.4. TEST CHANNEL CONFIGURATION

Test Mode	Test Channel	Frequency
GFSK-DH5	CH 00(Low Channel), CH 39(MID Channel), CH 78(High Channel)	2402 MHz, 2441 MHz, 2480 MHz
8DPSK-3DH5	CH 00(Low Channel), CH 39(MID Channel), CH 78(High Channel)	2402 MHz, 2441 MHz, 2480 MHz
GFSK-DH5	Hopping	
8DPSK-3DH5	Hopping	

5.5. PACKET TYPE CONFIGURATION

Test Mode	Packet Type	Setting (Packet Length)
GFSK	DH1	27
	DH3	183
	DH5	339
π/4-DQPSK	2-DH1	54
	2-DH3	367
	2-DH5	679
8DPSK	3-DH1	83
	3-DH3	552
	3-DH5	1021

5.6. THE WORSE CASE POWER SETTING PARAMETER

Bluetooth Mode	Modulation Technology	Modulation Type	Data Rate (Mbps)
BR	FHSS	GFSK	1Mbit/s
EDR	FHSS	8DPSK	3Mbit/s

Note: Pre-Scan has been conducted to determine the worst-case mode from all possible combinations between available modulations, data rates.

The Worst Case Power Setting Parameter under 2400 ~ 2483.5MHz Band				
Test Software		Pandora		
Modulation Type	Transmit Antenna Number	Test Software setting value		
		CH 00	CH 39	CH 78
GFSK	1	default	default	default
8DPSK	1	default	default	default

5.7. DESCRIPTION OF AVAILABLE ANTENNAS

Antenna	Frequency (MHz)	Antenna Type	MAX Antenna Gain (dBi)
1	2402-2480	FPC	2.3

Test Mode	Transmit and Receive Mode	Description
GFSK	<input checked="" type="checkbox"/> 1TX, 1RX	Antenna 1 can be used as transmitting/receiving antenna.
8DPSK	<input checked="" type="checkbox"/> 1TX, 1RX	Antenna 1 can be used as transmitting/receiving antenna.
Note: 1.BT&WLAN 2.4G, BT & WLAN 5G, WLAN 2.4G & WLAN 5G can't transmit simultaneously. (declared by client)		

Note: The value of the antenna gain was declared by customer.

5.8. SUPPORT UNITS FOR SYSTEM TEST

SUPPORT EQUIPMENT

Item	Equipment	Brand Name	Model Name	Remarks
1	Laptop	Lenovo	E14	/
2	Adapter	N/A	GLH50E2000HW	Input: 100-240V~, 50/60Hz, 0.40A Output: DC 5V2A, 10W

I/O CABLES

Cable No	Port	Connector Type	Cable Type	Cable Length(m)	Remarks
1	USB	Type C	/	1.0	/

ACCESSORIES

Battery	
Model No.:	YW-001C
Rated Voltage:	7.2 Vdc
Limited Charge Voltage:	8.4 Vdc
Rated Capacity:	2600 mAh/18.72Wh

Battery	
Model No.:	YW-003C
Rated Voltage:	7.2 Vdc
Limited Charge Voltage:	8.4 Vdc
Rated Capacity:	3350 mAh/24.12Wh

Note: the product have two battery(YW-001C and YW-003C), both battery have been tested, but only the worst battery data(YW-001C) recorded in the report.

TEST SETUP

The EUT can work in engineering mode with a software through a Laptop.

SETUP DIAGRAM FOR TESTS

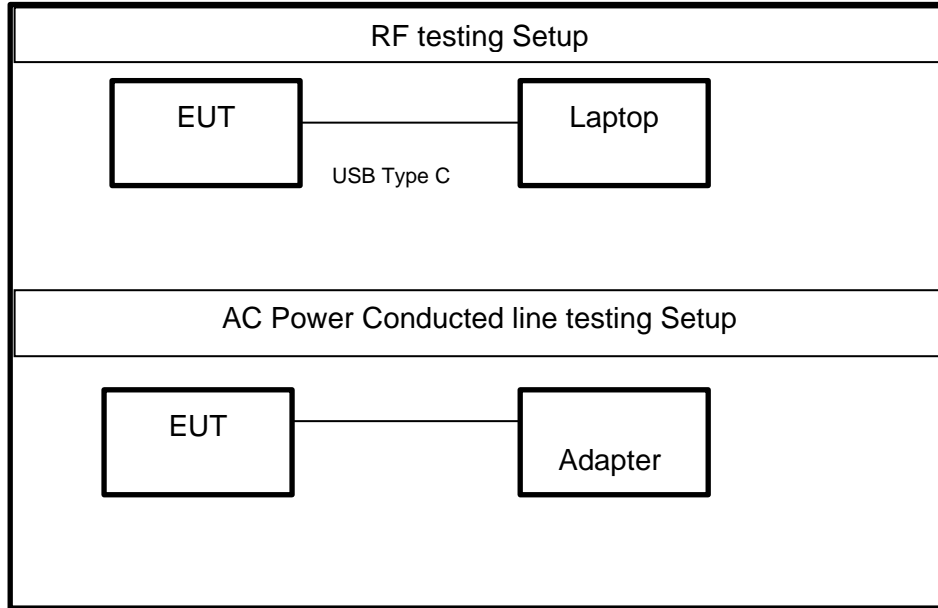

6. MEASURING EQUIPMENT AND SOFTWARE USED

R&S TS 8997 Test System					
Equipment	Manufacturer	Model No.	Serial No.	Last Cal.	Due. Date
Power sensor, Power Meter	R&S	OSP120	100921	Mar.31,2023	Mar.30,2024
Vector Signal Generator	R&S	SMBV100A	261637	Oct.17, 2022	Oct.16, 2023
Signal Generator	R&S	SMB100A	178553	Oct.17, 2022	Oct.16, 2023
Signal Analyzer	R&S	FSV40	101118	Oct.17, 2022	Oct.16, 2023
Software					
Description	Manufacturer	Name		Version	
For R&S TS 8997 Test System	Rohde & Schwarz	EMC 32		10.60.10	
Tonsend RF Test System					
Equipment	Manufacturer	Model No.	Serial No.	Last Cal.	Due. Date
Wideband Radio Communication Tester	R&S	CMW500	155523	Oct.17, 2022	Oct.16, 2023
Wireless Connectivity Tester	R&S	CMW270	1201.0002N75-102	Sep.28, 2022	Sep.27, 2023
PXA Signal Analyzer	Keysight	N9030A	MY55410512	Oct.17, 2022	Oct.16, 2023
MXG Vector Signal Generator	Keysight	N5182B	MY56200284	Oct.17, 2022	Oct.16, 2023
MXG Vector Signal Generator	Keysight	N5172B	MY56200301	Oct.17, 2022	Oct.16, 2023
DC power supply	Keysight	E3642A	MY55159130	Oct.17, 2022	Oct.16, 2023
Temperature & Humidity Chamber	SANMOOD	SG-80-CC-2	2088	Oct.17, 2022	Oct.16, 2023
Attenuator	Aglient	8495B	2814a12853	Oct.18, 2022	Oct.17, 2023
RF Control Unit	Tonscend	JS0806-2	23B80620666	April 18,2023	April 17,2024
Software					
Description	Manufacturer	Name		Version	
Tonsend SRD Test System	Tonsend	JS1120-3 RF Test System		V3.2.22	

Conducted Emissions					
Equipment	Manufacturer	Model No.	Serial No.	Last Cal.	Due Date
EMI Test Receiver	R&S	ESR3	101961	Oct.17, 2022	Oct.16, 2023
Two-Line V-Network	R&S	ENV216	101983	Oct.17, 2022	Oct.16, 2023
Artificial Mains Networks	Schwarzbeck	NSLK 8126	8126465	Oct.17, 2022	Oct.16, 2023
Software					
Description			Manufacturer	Name	Version
Test Software for Conducted Emissions			Farad	EZ-EMC	Ver. UL-3A1

Radiated Emissions					
Equipment	Manufacturer	Model No.	Serial No.	Last Cal.	Due Date
MXE EMI Receiver	KESIGHT	N9038A	MY56400036	Oct.17, 2022	Oct.16, 2023
Hybrid Log Periodic Antenna	TDK	HLP-3003C	130959	Aug.02, 2021	Aug.01, 2024
Preamplifier	HP	8447D	2944A09099	Oct.17, 2022	Oct.16, 2023
EMI Measurement Receiver	R&S	ESR26	101377	Oct.17, 2022	Oct.16, 2023
Horn Antenna	TDK	HRN-0118	130940	July 20, 2021	July 19, 2024
Preamplifier	TDK	PA-02-0118	TRS-305-00067	Oct.17, 2022	Oct.16, 2023
Horn Antenna	Schwarzbeck	BBHA9170	697	July 20, 2021	July 19, 2024
Preamplifier	TDK	PA-02-2	TRS-307-00003	Oct.17, 2022	Oct.16, 2023
Preamplifier	TDK	PA-02-3	TRS-308-00002	Oct.17, 2022	Oct.16, 2023
Loop antenna	Schwarzbeck	1519B	00008	Dec.14, 2021	Dec.13, 2024
Preamplifier	TDK	PA-02-001-3000	TRS-302-00050	Oct.17, 2022	Oct.16, 2023
Preamplifier	Mini-Circuits	ZX60-83LN-S+	SUP01202035	Oct.17, 2022	Oct.16, 2023
High Pass Filter	Wi	WHKX10-2700-3000-18000-40SS	23	Oct.17, 2022	Oct.16, 2023
Highpass Filter	Wainwright	WHKX10-5850-6500-1800-40SS	4	Oct.17, 2022	Oct.16, 2023
Band Reject Filter	Wainwright	WRCJV12-5695-5725-5850-5880-40SS	4	Oct.17, 2022	Oct.16, 2023

Band Reject Filter	Wainwright	WRCJV20-5120-5150-5350-5380-60SS	2	Oct.17, 2022	Oct.16, 2023
Band Reject Filter	Wainwright	WRCJV20-5440-5470-5725-5755-60SS	1	Oct.17, 2022	Oct.16, 2023
Band Reject Filter	Wainwright	WRCJV8-2350-2400-2483.5-2533.5-40SS	4	Oct.17, 2022	Oct.16, 2023
Band Reject Filter	Wainwright	WRCD5-1879-1879.85-1880.15-1881-40SS	1	Oct.17, 2022	Oct.16, 2023
Notch Filter	Wainwright	WHJ10-882-980-7000-40SS	1	Oct.17, 2022	Oct.16, 2023
Software					
Description			Manufacturer	Name	Version
Test Software for Radiated Emissions			Farad	EZ-EMC	Ver. UL-3A1

Other Instrument					
Equipment	Manufacturer	Model No.	Serial No.	Last Cal.	Due Date
Temperature humidity probe	OMEGA	ITHX-SD-5	18470007	Oct.22, 2022	Oct.21, 2023
Barometer	Yiyi	Baro	N/A	Oct.24, 2022	Oct.23, 2023
Attenuator	Agilent	8495B	2814a12853	Oct.18, 2022	Oct.17, 2023

7. ANTENNA PORT TEST RESULTS

7.1. CONDUCTED OUTPUT POWER

LIMITS

CFR 47 FCC Part15 (15.247), Subpart C ISED RSS-247 ISSUE 2			
Section	Test Item	Limit	Frequency Range (MHz)
CFR 47 FCC 15.247 (b) (1) ISED RSS-247 Clause 5.4 (b)	Peak Conducted Output Power	Hopping channel carrier frequencies separated by a minimum of 25 kHz or the 20 dB bandwidth of the hopping channel: 1 watt or 30 dBm; Hopping channel carrier frequencies that are separated by 25 kHz or two-thirds of the 20 dB bandwidth of the hopping channel: 125 mW or 21 dBm	2400-2483.5

TEST PROCEDURE

Connect the EUT to a low loss RF cable from the antenna port to the power sensor (video bandwidth is greater than the occupied bandwidth).

Measure peak emission level, the indicated level is the peak output power, after any corrections for external attenuators and cables.

TEST SETUP

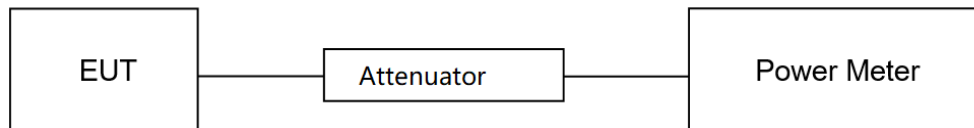

TEST ENVIRONMENT

Temperature	26.7°C	Relative Humidity	57.9%
Atmosphere Pressure	101kPa	Test Voltage	DC 5V

TEST DATE / ENGINEER

Test Date	May 8, 2023	Test By	Johnson Liu
-----------	-------------	---------	-------------

TEST RESULTS

Please refer to section "Test Data" - Appendix C

7.2. 20 DB BANDWIDTH AND 99% OCCUPIED BANDWIDTH

LIMITS

CFR 47FCC Part15 (15.247) Subpart C ISED RSS-247 ISSUE 2			
Section	Test Item	Limit	Frequency Range (MHz)
CFR 47 FCC 15.247 (a) (1) RSS-247 Clause 5.1 (a)	20 dB Bandwidth	None; for reporting purposes only.	2400-2483.5
ISED RSS-Gen Clause 6.7	99 % Occupied Bandwidth	None; for reporting purposes only.	2400-2483.5

TEST PROCEDURE

Refer to ANSI C63.10-2013 clause 6.9.2.

Connect the EUT to the spectrum analyser and use the following settings:

Center Frequency	The center frequency of the channel under test
Detector	Peak
RBW	For 20 dB Bandwidth: 1 % to 5 % of the 20 dB bandwidth For 99 % Occupied Bandwidth: 1 % to 5 % of the occupied bandwidth
VBW	For 20 dB Bandwidth: approximately 3×RBW For 99 % Occupied Bandwidth: ≥ 3×RBW
Span	Approximately 2 to 3 times the 20dB bandwidth
Trace	Max hold
Sweep	Auto couple

a) Use the occupied bandwidth function of the instrument, allow the trace to stabilize and report the measured 99 % occupied bandwidth and 20 dB Bandwidth.

TEST SETUP

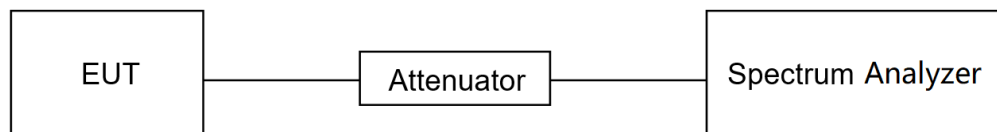

TEST ENVIRONMENT

Temperature	26.7°C	Relative Humidity	57.9%
Atmosphere Pressure	101kPa	Test Voltage	DC 5V

TEST DATE / ENGINEER

Test Date	May 8, 2023	Test By	Johnson Liu
-----------	-------------	---------	-------------

TEST RESULTS

Please refer to section "Test Data" - Appendix A&B

7.3. CARRIER HOPPING CHANNEL SEPARATION

LIMITS

CFR 47 FCC Part15 (15.247), Subpart C ISSED RSS-247 ISSUE 2			
Section	Test Item	Limit	Frequency Range (MHz)
CFR 47 FCC 15.247 (a) (1) ISED RSS-247 Clause 5.1 (b)	Carrier Frequency Separation	Frequency hopping systems shall have hopping channel carrier frequencies separated by a minimum of 25 kHz or the 20 dB bandwidth of the hopping channel, whichever is greater. Alternatively, frequency hopping systems operating in the 2400-2483.5 MHz band may have hopping channel carrier frequencies that are separated by 25 kHz or two-thirds of the 20 dB bandwidth of the hopping channel.	2400-2483.5

TEST PROCEDURE

Refer to ANSI C63.10-2013 clause 7.8.2.

Connect the EUT to the spectrum analyzer and use the following settings:

Center Frequency	The center frequency of the channel under test
Span	wide enough to capture the peaks of two adjacent channels
Detector	Peak
RBW	Start with the RBW set to approximately 30 % of the channel spacing; adjust as necessary to best identify the center of each individual channel.
VBW	≥RBW
Trace	Max hold
Sweep time	Auto couple

Allow the trace to stabilize and use the marker-delta function to determine the separation between the peaks of the adjacent channels.

Compliance of an EUT with the appropriate regulatory limit shall be determined.

TEST SETUP

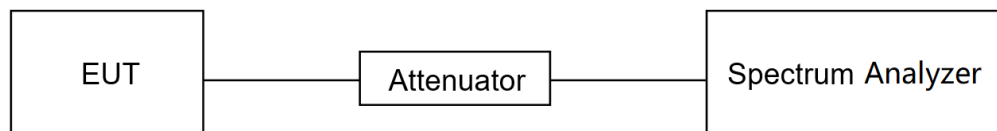

TEST ENVIRONMENT

Temperature	26.7°C	Relative Humidity	57.9%
Atmosphere Pressure	101kPa	Test Voltage	DC 5V

TEST DATE / ENGINEER

Test Date	May 11, 2023	Test By	Johnson Liu
-----------	--------------	---------	-------------

TEST RESULTS

Please refer to section "Test Data" - Appendix D

7.4. NUMBER OF HOPPING FREQUENCY

LIMITS

CFR 47 FCC Part15 (15.247), Subpart C ISED RSS-247 ISSUE 2		
Section	Test Item	Limit
CFR 47 15.247 (a) (1) III ISED RSS-247 Clause 5.1 (d)	Number of Hopping Frequency	at least 15 hopping channels

TEST PROCEDURE

Refer to ANSI C63.10-2013 clause 7.8.3.

Connect the EUT to the spectrum Analyzer and use the following settings:

Detector	Peak
RBW	To identify clearly the individual channels, set the RBW to less than 30% of the channel spacing or the 20 dB bandwidth, whichever is smaller.
VBW	≥RBW
Span	The frequency band of operation. Depending on the number of channels the device supports, it may be necessary to divide the frequency range of operation across multiple spans, to allow the individual channels to be clearly seen.
Trace	Max hold
Sweep time	Auto couple

Set EUT to transmit maximum output power and switch on frequency hopping function. then set enough count time (larger than 5000 times) to get all the hopping frequency channel displayed on the screen of spectrum analyzer, count the quantity of peaks to get the number of hopping channels.

TEST SETUP

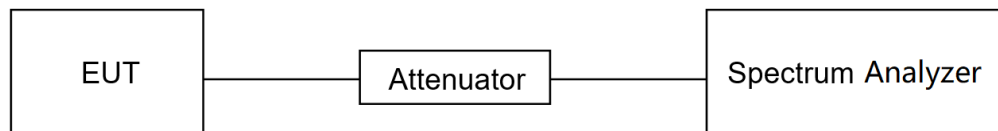

TEST ENVIRONMENT

Temperature	26.7°C	Relative Humidity	57.9%
Atmosphere Pressure	101kPa	Test Voltage	DC 5V

TEST DATE / ENGINEER

Test Date	May 11, 2023	Test By	Johnson Liu
-----------	--------------	---------	-------------

TEST RESULTS

Please refer to section "Test Data" - Appendix F

7.5. TIME OF OCCUPANCY (DWELL TIME)

LIMITS

CFR 47 FCC Part15 (15.247), Subpart C ISED RSS-247 ISSUE 2		
Section	Test Item	Limit
CFR 47 15.247 (a) (1) III ISED RSS-247 Clause 5.1 (d)	Time of Occupancy (Dwell Time)	The average time of occupancy on any channel shall not be greater than 0.4 seconds within a period of 0.4 seconds, multiplied by the number of hopping channels employed.

TEST PROCEDURE

Refer to ANSI C63.10-2013 clause 7.8.4.

Connect the EUT to the spectrum Analyzer and use the following settings:

Center Frequency	The center frequency of the channel under test
Detector	Peak
RBW	1 MHz
VBW	≥RBW
Span	Zero span, centered on a hopping channel
Trace	Max hold
Sweep time	As necessary to capture the entire dwell time per hopping channel; where possible use a video trigger and trigger delay so that the transmitted signal starts a little to the right of the start of the plot. The trigger level might need slight adjustment to prevent triggering when the system hops on an adjacent channel

Use the marker-delta function to determine the transmit time per hop (Burst Width). If this value varies with different modes of operation (data rate, modulation format, number of hopping channels, etc.), then repeat this test for each variation in transmit time.

For FHSS Mode (79 Channel):

DH1/3DH1 Dwell Time: $\text{Burst Width} * (1600/2) * 31.6 / (\text{channel number})$

DH3/3DH3 Dwell Time: $\text{Burst Width} * (1600/4) * 31.6 / (\text{channel number})$

DH5/3DH5 Dwell Time: $\text{Burst Width} * (1600/6) * 31.6 / (\text{channel number})$

For AFHSS Mode (20 Channel):

DH1/3DH1 Dwell Time: $\text{Burst Width} * (800/2) * 8 / (\text{channel number})$

DH3/3DH3 Dwell Time: $\text{Burst Width} * (800/4) * 8 / (\text{channel number})$

DH5/3DH5 Dwell Time: $\text{Burst Width} * (800/6) * 8 / (\text{channel number})$

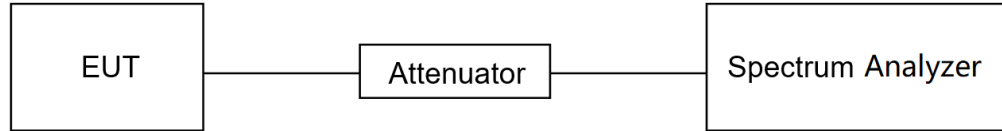
TEST SETUP**TEST ENVIRONMENT**

Temperature	26.7°C	Relative Humidity	57.9%
Atmosphere Pressure	101kPa	Test Voltage	DC 5V

TEST DATE / ENGINEER

Test Date	May 11, 2023	Test By	Johnson Liu
-----------	--------------	---------	-------------

TEST RESULTS

Please refer to section "Test Data" - Appendix E

7.6. CONDUCTED BANDEGE AND SPURIOUS EMISSION

LIMITS

CFR 47 FCC Part15 (15.247), Subpart C ISED RSS-247 ISSUE 2		
Section	Test Item	Limit
CFR 47 FCC §15.247 (d) ISED RSS-247 5.5	Conducted Spurious Emission	at least 20 dB below that in the 100 kHz bandwidth within the band that contains the highest level of the desired power

TEST PROCEDURE

Refer to ANSI C63.10-2013 clause 7.8.6 and 7.8.8.

Connect the EUT to the spectrum analyser and use the following settings for reference level measurement:

Center Frequency	The center frequency of the channel under test
Detector	Peak
RBW	100 kHz
VBW	$\geq 3 \times \text{RBW}$
Span	1.5 x DTS bandwidth
Trace	Max hold
Sweep time	Auto couple.

Allow trace to fully stabilize and use the peak marker function to determine the maximum PSD level.

Change the settings for emission level measurement:

Span	Set the center frequency and span to encompass frequency range to be measured
Detector	Peak
RBW	100 kHz
VBW	$\geq 3 \times \text{RBW}$
measurement points	$\geq \text{span}/\text{RBW}$
Trace	Max hold
Sweep time	Auto couple.

Allow trace to fully stabilize and use the peak marker function to determine the maximum PSD level. Ensure that the amplitude of all unwanted emissions outside of the authorized frequency band (excluding restricted frequency bands) is attenuated by at least the minimum

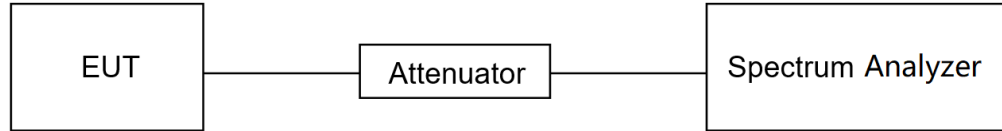
TEST SETUP**TEST ENVIRONMENT**

Temperature	26.7°C	Relative Humidity	57.9%
Atmosphere Pressure	101kPa	Test Voltage	DC 5V

TEST DATE / ENGINEER

Test Date	May 8, 2023	Test By	Johnson Liu
-----------	-------------	---------	-------------

TEST RESULTS

Please refer to section "Test Data" - Appendix G&H

7.7. DUTY CYCLE

LIMITS

None; for reporting purposes only.

TEST PROCEDURE

Refer to ANSI C63.10-2013 Zero – Span Spectrum Analyzer method.

TEST SETUP

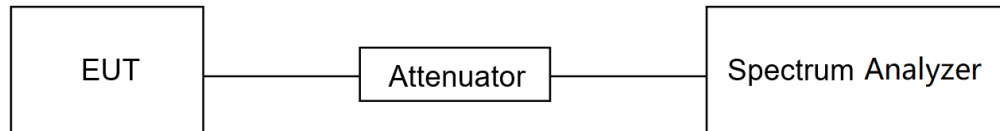

TEST ENVIRONMENT

Temperature	26.7°C	Relative Humidity	57.9%
Atmosphere Pressure	101kPa	Test Voltage	DC 5V

TEST DATE / ENGINEER

Test Date	May 8, 2023	Test By	Johnson Liu
-----------	-------------	---------	-------------

TEST RESULTS

Please refer to section "Test Data" - Appendix I

8. RADIATED TEST RESULTS

LIMITS

Please refer to CFR 47 FCC §15.205 and §15.209.

Please refer to ISED RSS-GEN Clause 8.9 and Clause 8.10.

Radiation Disturbance Test Limit for FCC (Class B) (9 kHz-1 GHz)

Emissions radiated outside of the specified frequency bands above 30 MHz			
Frequency Range (MHz)	Field Strength Limit (uV/m) at 3 m	Field Strength Limit (dBuV/m) at 3 m	
		Quasi-Peak	
30 - 88	100	40	
88 - 216	150	43.5	
216 - 960	200	46	
Above 960	500	54	
Above 1000	500	Peak	Average
		74	54

FCC Emissions radiated outside of the specified frequency bands below 30 MHz		
Frequency (MHz)	Field strength (microvolts/meter)	Measurement distance (meters)
0.009-0.490	2400/F(kHz)	300
0.490-1.705	24000/F(kHz)	30
1.705-30.0	30	30

ISED General field strength limits at frequencies below 30 MHz

Table 6 – General field strength limits at frequencies below 30 MHz		
Frequency	Magnetic field strength (H-Field) (uA/m)	Measurement distance (m)
9 - 490 kHz ^{Note 1}	6.37/F (F in kHz)	300
490 - 1705 kHz	63.7/F (F in kHz)	30
1.705 - 30 MHz	0.08	30

Note 1: The emission limits for the ranges 9-90 kHz and 110-490 kHz are based on measurements employing a linear average detector.

ISED Restricted bands please refer to ISED RSS-GEN Clause 8.10

Table 7 – Restricted frequency bands ^{Note 1}		
MHz	MHz	GHz
0.090 - 0.110	149.9 - 150.05	9.0 - 9.2
0.495 - 0.505	156.52475 - 156.52525	9.3 - 9.5
2.1735 - 2.1905	158.7 - 158.9	10.6 - 12.7
3.020 - 3.028	162.0125 - 167.17	13.25 - 13.4
4.125 - 4.128	167.72 - 173.2	14.47 - 14.5
4.17725 - 4.17775	240 - 285	15.35 - 16.2
4.20725 - 4.20775	322 - 335.4	17.7 - 21.4
5.877 - 5.883	399.9 - 410	22.01 - 23.12
6.215 - 6.218	608 - 614	23.6 - 24.0
6.26775 - 6.26825	960 - 1427	31.2 - 31.8
6.31175 - 6.31225	1435 - 1626.5	36.43 - 36.5
8.291 - 8.294	1645.5 - 1646.5	Above 38.6
8.362 - 8.366	1660 - 1710	
8.37625 - 8.38675	1718.8 - 1722.2	
8.41425 - 8.41475	2200 - 2300	
12.29 - 12.293	2310 - 2390	
12.51975 - 12.52025	2483.5 - 2500	
12.57675 - 12.57725	2695 - 2900	
13.36 - 13.41	3260 - 3267	
16.42 - 16.423	3332 - 3339	
16.69475 - 16.69525	3345.8 - 3358	
16.80425 - 16.80475	3500 - 4400	
25.5 - 25.67	4500 - 5150	
37.5 - 38.25	5350 - 5490	
73 - 74.6	7250 - 7750	
74.8 - 75.2	8025 - 8500	
108 - 138		

Note 1: Certain frequency bands listed in table 7 and in bands above 38.6 GHz are designated for licence-exempt applications. These frequency bands and the requirements that apply to related devices are set out in the 200 and 300 series of RSSs.

FCC Restricted bands of operation refer to FCC §15.205 (a):

MHz	MHz	MHz	GHz
0.090-0.110	16.42-16.423	399.9-410	4.5-5.15
¹ 0.495-0.505	16.69475-16.69525	608-614	5.35-5.46
2.1735-2.1905	16.80425-16.80475	960-1240	7.25-7.75
4.125-4.128	25.5-25.67	1300-1427	8.025-8.5
4.17725-4.17775	37.5-38.25	1435-1626.5	9.0-9.2
4.20725-4.20775	73-74.6	1645.5-1646.5	9.3-9.5
6.215-6.218	74.8-75.2	1660-1710	10.6-12.7
6.26775-6.26825	108-121.94	1718.8-1722.2	13.25-13.4
6.31175-6.31225	123-138	2200-2300	14.47-14.5
8.291-8.294	149.9-150.05	2310-2390	15.35-16.2
8.362-8.366	156.52475-156.52525	2483.5-2500	17.7-21.4
8.37625-8.38675	156.7-156.9	2690-2900	22.01-23.12
8.41425-8.41475	162.0125-167.17	3260-3267	23.6-24.0
12.29-12.293	167.72-173.2	3332-3339	31.2-31.8
12.51975-12.52025	240-285	3345.8-3358	36.43-36.5
12.57675-12.57725	322-335.4	3600-4400	(²)
13.36-13.41			

Note: ¹Until February 1, 1999, this restricted band shall be 0.490-0.510 MHz.

²Above 38.6c

TEST PROCEDURE

Below 30 MHz

The setting of the spectrum analyser

RBW	200 Hz (From 9 kHz to 0.15 MHz)/ 9 kHz (From 0.15 MHz to 30 MHz)
VBW	200 Hz (From 9 kHz to 0.15 MHz)/ 9 kHz (From 0.15 MHz to 30 MHz)
Sweep	Auto

1. The testing follows the guidelines in ANSI C63.10-2013 clause 6.4.
2. The EUT was arranged to its worst case and then turntable (from 0 degree to 360 degrees) to find the maximum reading. A pre-amp and a high pass filter are used for the test in order to get better signal level. Both Horizontal, Face-on and Face-off polarizations of the antenna are set to make the measurement.
3. The EUT was placed on a turntable with 80 cm above ground.
4. The EUT was set 3 meters from the interference receiving antenna, which was mounted on the top of a 1 m height antenna tower.
5. The radiated emission limits are based on measurements employing a CISPR quasi-peak detector except for the frequency bands 9-90 kHz, 110-490 kHz and above 1000 MHz Radiated emission limits in these three bands are based on measurements employing an average detector.
6. For measurement below 1 GHz, the initial step in collecting conducted emission data is a spectrum analyzer peak detector mode pre-scanning the measurement frequency range. Significant peaks are then marked and then Quasi Peak and average detector mode re-measured. If the emission level of the EUT measured by the peak detector is 3 dB lower than the applicable limit, the peak emission level will be reported. Otherwise, the emission measurement will be repeated using the quasi-peak and average detector and reported.
7. Although these tests were performed other than open field site, adequate comparison measurements were confirmed against 30m open field site. Therefore sufficient tests were made to demonstrate that the alternative site produces results that correlate with the ones of tests made in an open field site based on KDB 414788.
8. The limits in CFR 47, Part 15, Subpart C, paragraph 15.209 (a), are identical to those in RSS-GEN Section 8.9, Table 6, since the measurements are performed in terms of magnetic field strength and converted to electric field strength levels (as reported in the table) using the free space impedance of 377Ω . For example, the measurement frequency X KHz resulted in a level of Y dBuV/m, which is equivalent to $Y-51.5 = Z$ dBuA/m, which has the same margin, W dB, to the corresponding RSS-GEN Table 6 limit as it has to be 15.209(a) limit.

Below 1 GHz and above 30 MHz

The setting of the spectrum analyser

RBW	120 kHz
VBW	300 kHz
Sweep	Auto
Detector	Peak/QP
Trace	Max hold

1. The testing follows the guidelines in ANSI C63.10-2013 clause 6.5.
2. The EUT was arranged to its worst case and then tune the antenna tower (from 1 m to 4 m) and turntable (from 0 degree to 360 degrees) to find the maximum reading. A pre-amp and a high pass filter are used for the test in order to get better signal level. Both horizontal and vertical polarizations of the antenna are set to make the measurement.
3. The EUT was placed on a turntable with 80 cm above ground.
4. The EUT was set 3 meters from the interference receiving antenna, which was mounted on the top of a variable height antenna tower.
5. For measurement below 1 GHz, the initial step in collecting conducted emission data is a spectrum analyzer peak detector mode pre-scanning the measurement frequency range. Significant peaks are then marked and then Quasi Peak detector mode re-measured. If the emission level of the EUT measured by the peak detector is 3 dB lower than the applicable limit, the peak emission level will be reported. Otherwise, the emission measurement will be repeated using the quasi-peak detector and reported.

Above 1 GHz

The setting of the spectrum analyser

RBW	1 MHz
VBW	PEAK: 3 MHz AVG: see note 6
Sweep	Auto
Detector	Peak
Trace	Max hold

1. The testing follows the guidelines in ANSI C63.10-2013 clause 6.6.
2. The EUT was arranged to its worst case and then tune the antenna tower (from 1 m to 4 m) and turntable (from 0 degree to 360 degrees) to find the maximum reading. A pre-amp and a high pass filter are used for the test in order to get better signal level. Both horizontal and vertical polarizations of the antenna are set to make the measurement.
3. The EUT was placed on a turntable with 1.5 m above ground.
4. The EUT was set 3 meters from the interference receiving antenna, which was mounted on the top of a variable height antenna tower.
5. For measurement above 1 GHz, the emission measurement will be measured by the peak detector. This peak level, once corrected, must comply with the limit specified in Section 15.209.
6. For measurements above 1 GHz the resolution bandwidth is set to 1 MHz, then the video bandwidth is set to 3 MHz for peak measurements and 1 MHz resolution bandwidth with 1/T video bandwidth with peak detector for average measurements. For the Duty Cycle please refer to clause 7.7.ON TIME AND DUTY CYCLE.

X axis, Y axis, Z axis positions:

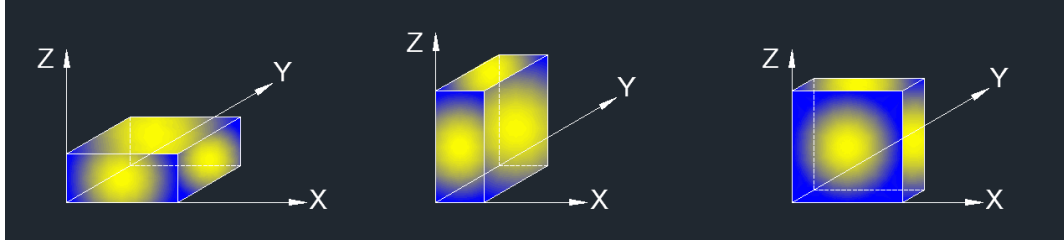

Note 1: For all radiated test, EUT in each of three orthogonal axis emissions had been tested, but only the worst case (X axis) data recorded in the report.

Note 2: The EUT was fully exercised with external accessories during the test. In the case of multiple accessory external ports, an external accessory shall be connected to one of each type of port.

For Band edge:

Note:

1. Measurement = Reading Level + Correct Factor.
2. If the peak values are less than the average limit of 54 dBuV/m, the average result is deemed to comply with average limit.
3. Peak: Peak detector.
4. AVG: $VBW=1/Ton$, where: Ton is the transmitting duration.
5. For the transmitting duration, please refer to clause 7.7.
6. Only the worst data was recorded, if it complies with the limit, the other emissions deemed to comply with the limit.
7. Horizontal and Vertical have been tested, only the worst data was recorded in the report.
8. All modes and channels have been tested, only the worst data was recorded in the report.

For Radiate Spurious emission 1 GHz-3 GHz:

Note:

1. Measurement = Reading Level + Correct Factor.
2. If the peak values are less than the average limit of 54 dBuV/m, the average result is deemed to comply with average limit.
3. Peak: Peak detector.
4. AVG: $VBW=1/Ton$, where: Ton is the transmitting duration.
5. For the transmitting duration, please refer to clause 7.7.
6. Filter losses were only considered in the spurious frequency bands and the authorized band was not corrected for Band reject filter losses.
7. Proper operation of the transmitter prior to adding the filter to the measurement chain.
8. All modes and channels have been tested, only the worst data was recorded in the report.

For Radiate Spurious emission 3 GHz-18 GHz :

Note:

1. Peak Result = Reading Level + Correct Factor.
2. If the peak values are less than the average limit of 54 dBuV/m, the average result is deemed to comply with average limit.
3. Peak: Peak detector.
4. AVG: $VBW=1/Ton$, where: Ton is the transmitting duration.
5. For the transmitting duration, please refer to clause 7.7.

6. Filter losses were only considered in the spurious frequency bands and the authorized band was not corrected for High Pass Filter losses.
7. Proper operation of the transmitter prior to adding the filter to the measurement chain.
8. All modes and channels have been tested, only the worst data was recorded in the report.

For Radiate Spurious emission 9 kHz-30 MHz:

Note:

1. Measurement = Reading Level + Correct Factor.
(dBuA/m = dBuV/m - 20Log10[120π] = dBuV/m - 51.5).
2. If the Peak values are less than the QP limit, the QP result is deemed to comply with QP limit.
3. All 3 polarizations (Horizontal, Face-on and Face-off) of the loop antenna had been tested, but only the worst data recorded in the report.
4. All modes and channels have been tested, only the worst data was recorded in the report.

For Radiate Spurious emission 18 GHz-26 GHz:

Note:

1. Measurement = Reading Level + Correct Factor.
2. If the peak values are less than the average limit of 54 dBuV/m, the average result is deemed to comply with average limit.
3. Peak: Peak detector.
4. All modes and channels have been tested, only the worst data was recorded in the report.

For Radiate Spurious emission 30MHz-1GHz:

Note:

1. Result Level = Read Level + Correct Factor.
2. If the Peak values are less than the QP limit, the QP result is deemed to comply with QP limit.
3. Test setup: RBW: 120 kHz, VBW: 300 kHz, Sweep time: auto.
4. All modes and channels have been tested, only the worst data was recorded in the report.

TEST SETUP

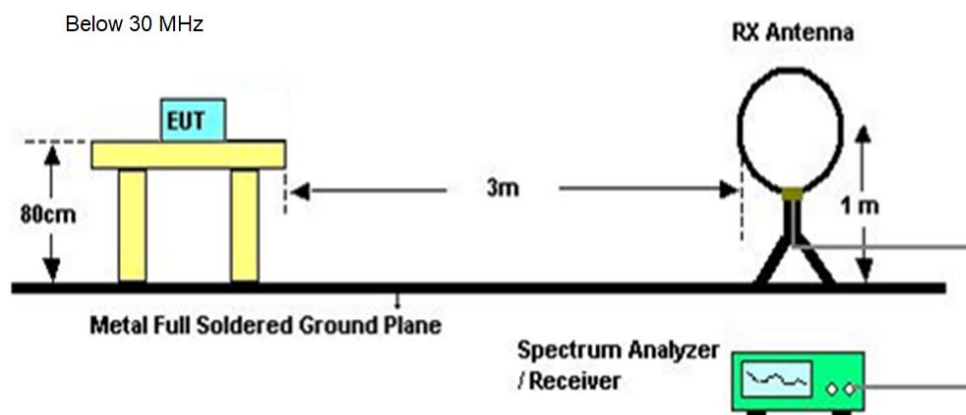

Below 1 GHz and above 30 MHz

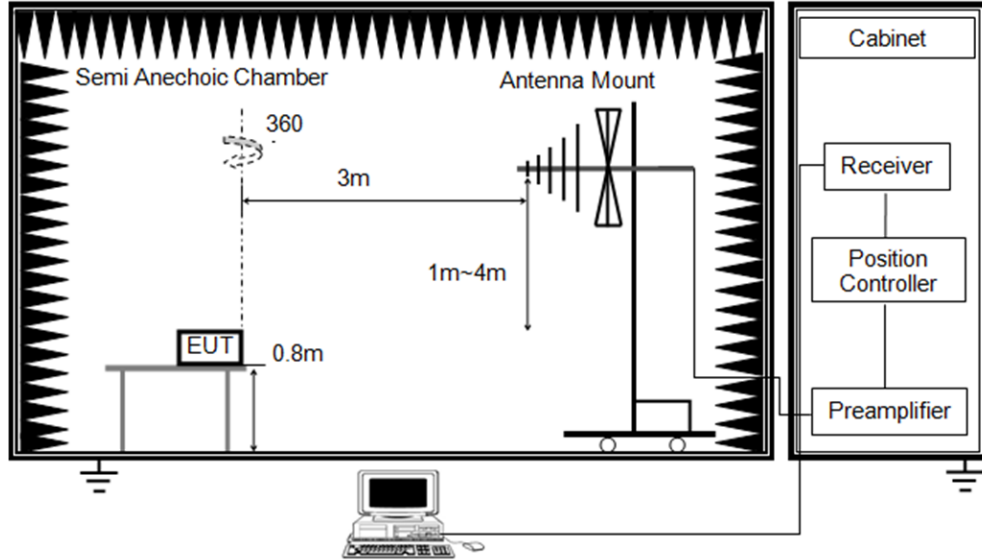

Above 1 GHz

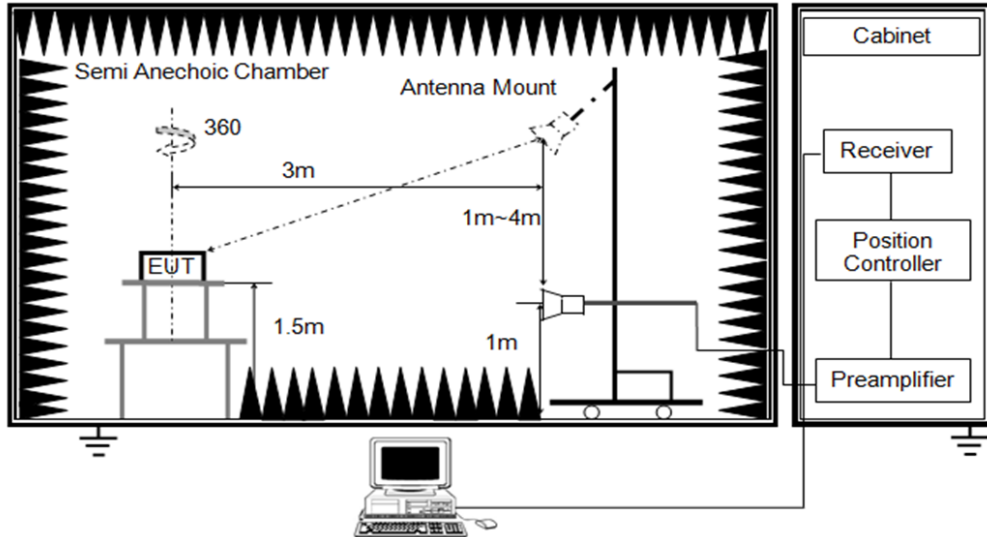

TEST ENVIRONMENT

Temperature	25.1°C	Relative Humidity	63%
Atmosphere Pressure	101kPa	Test Voltage	DC 5V

TEST DATE / ENGINEER

Test Date	June 6, 2023	Test By	Rex Huang
-----------	--------------	---------	-----------

TEST RESULTS

8.1. RESTRICTED BANDEDGE

Test Mode:	GFSK PK	Channel:	2402
Polarity:	Horizontal	Test Voltage:	DC 5V

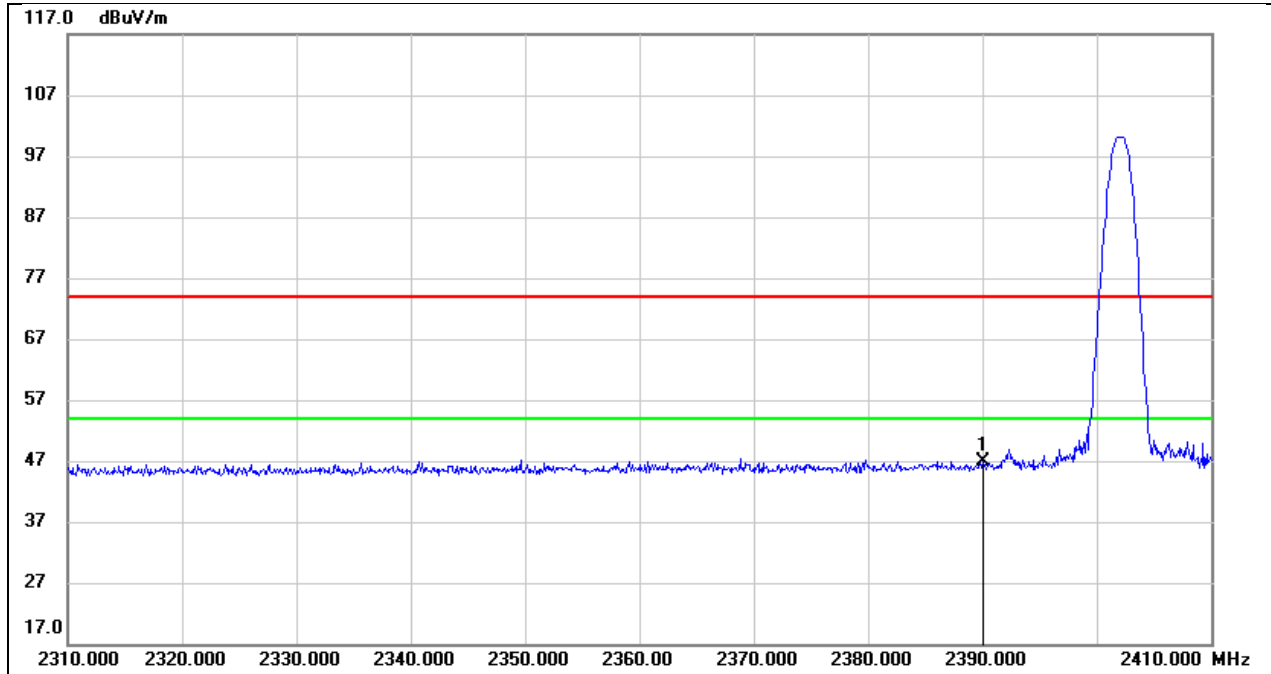

No.	Frequency (MHz)	Reading (dBuV)	Correct (dB/m)	Result (dBuV/m)	Limit (dBuV/m)	Margin (dB)	Remark
1	2390.000	14.81	32.16	46.97	74.00	-27.03	peak

Test Mode:	GFSK PK	Channel:	2402
Polarity:	Vertical	Test Voltage:	DC 5V

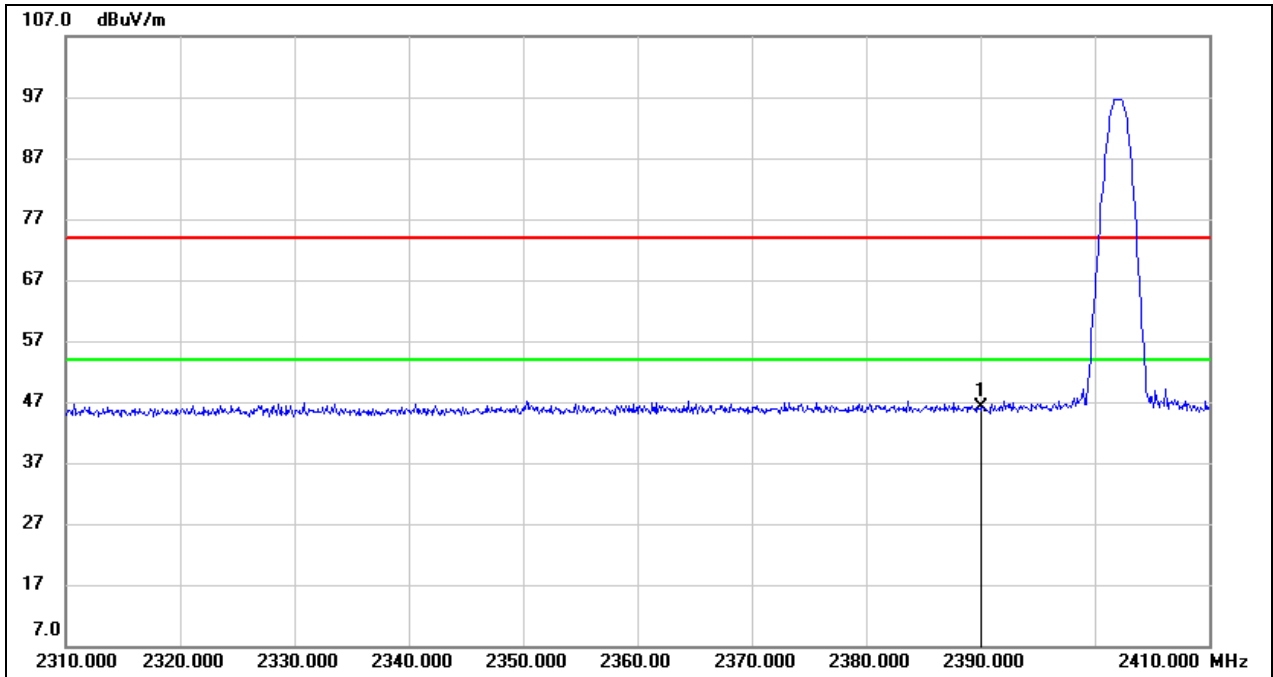

No.	Frequency (MHz)	Reading (dBuV)	Correct (dB/m)	Result (dBuV/m)	Limit (dBuV/m)	Margin (dB)	Remark
1	2390.000	13.97	32.16	46.13	74.00	-27.87	peak

Test Mode:	GFSK PK	Channel:	2480
Polarity:	Horizontal	Test Voltage:	DC 5V

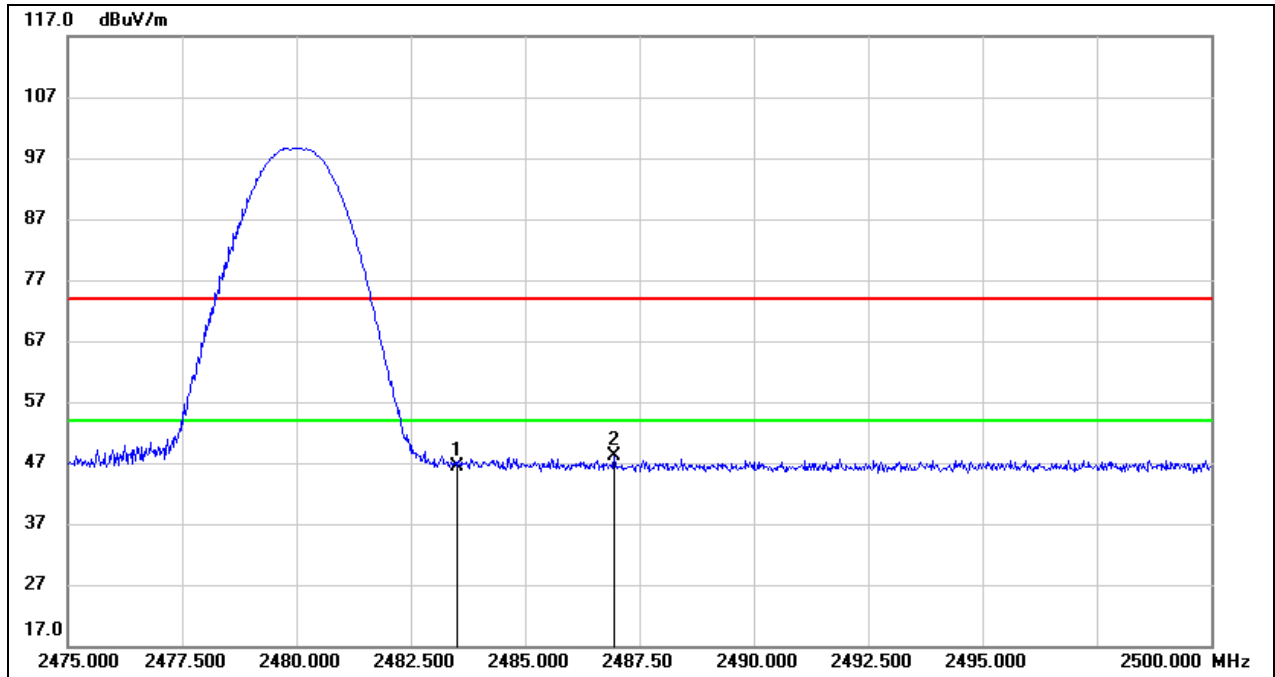

No.	Frequency (MHz)	Reading (dBuV)	Correct (dB/m)	Result (dBuV/m)	Limit (dBuV/m)	Margin (dB)	Remark
1	2483.500	14.04	32.44	46.48	74.00	-27.52	peak
2	2486.950	15.61	32.45	48.06	74.00	-25.94	peak

Test Mode:	8DPSK PK	Channel:	2402
Polarity:	Horizontal	Test Voltage:	DC 5V

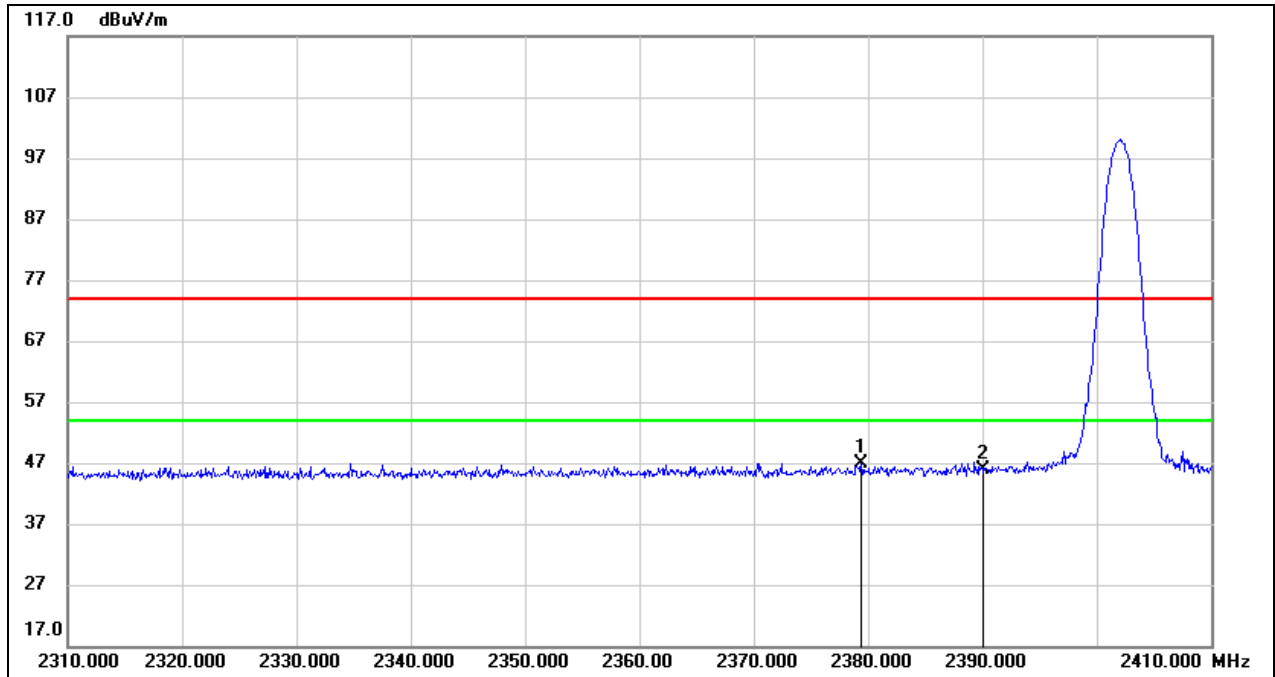

No.	Frequency (MHz)	Reading (dBuV)	Correct (dB/m)	Result (dBuV/m)	Limit (dBuV/m)	Margin (dB)	Remark
1	2379.400	14.63	32.13	46.76	74.00	-27.24	peak
2	2390.000	13.61	32.16	45.77	74.00	-28.23	peak

Test Mode:	8DPSK PK	Channel:	2480
Polarity:	Horizontal	Test Voltage:	DC 5V

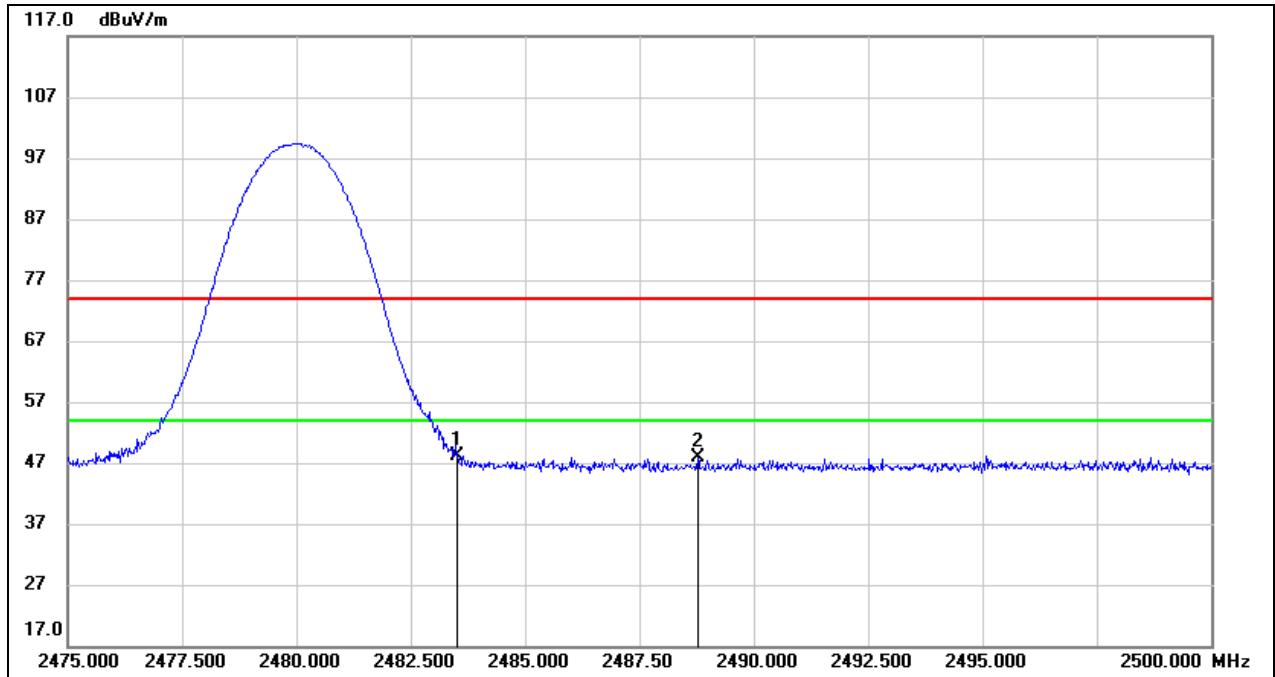

No.	Frequency (MHz)	Reading (dBuV)	Correct (dB/m)	Result (dBuV/m)	Limit (dBuV/m)	Margin (dB)	Remark
1	2483.500	15.72	32.44	48.16	74.00	-25.84	peak
2	2488.775	15.32	32.46	47.78	74.00	-26.22	peak

8.2. SPURIOUS EMISSIONS(1 GHZ~3 GHZ)

Test Mode:	GFSK	Channel:	2402
Polarity:	Horizontal	Test Voltage:	DC 5V

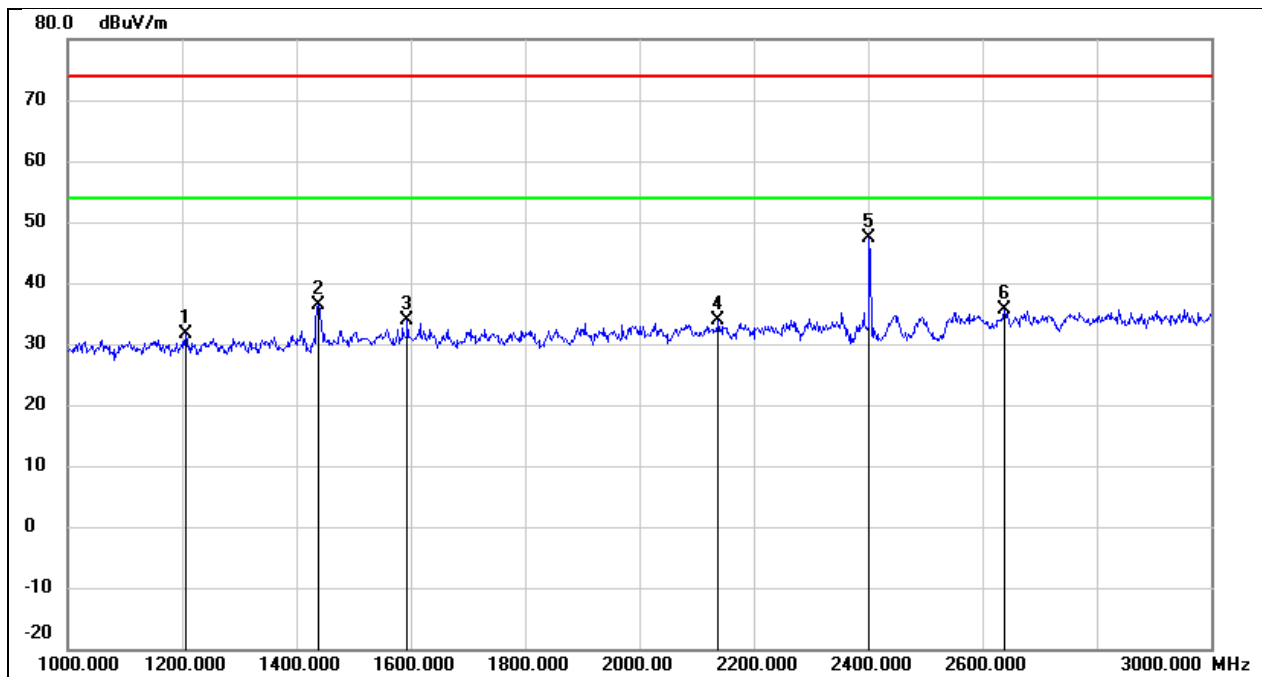

No.	Frequency (MHz)	Reading (dBuV)	Correct (dB/m)	Result (dBuV/m)	Limit (dBuV/m)	Margin (dB)	Remark
1	1206.000	45.58	-14.07	31.51	74.00	-42.49	peak
2	1438.000	49.46	-13.00	36.46	74.00	-37.54	peak
3	1594.000	46.19	-12.40	33.79	74.00	-40.21	peak
4	2138.000	44.15	-10.35	33.80	74.00	-40.20	peak
5	2402.000	56.43	-8.99	47.44	/	/	Fundamental
6	2638.000	43.59	-8.07	35.52	74.00	-38.48	peak

Test Mode:	GFSK	Channel:	2402
Polarity:	Vertical	Test Voltage:	DC 5V

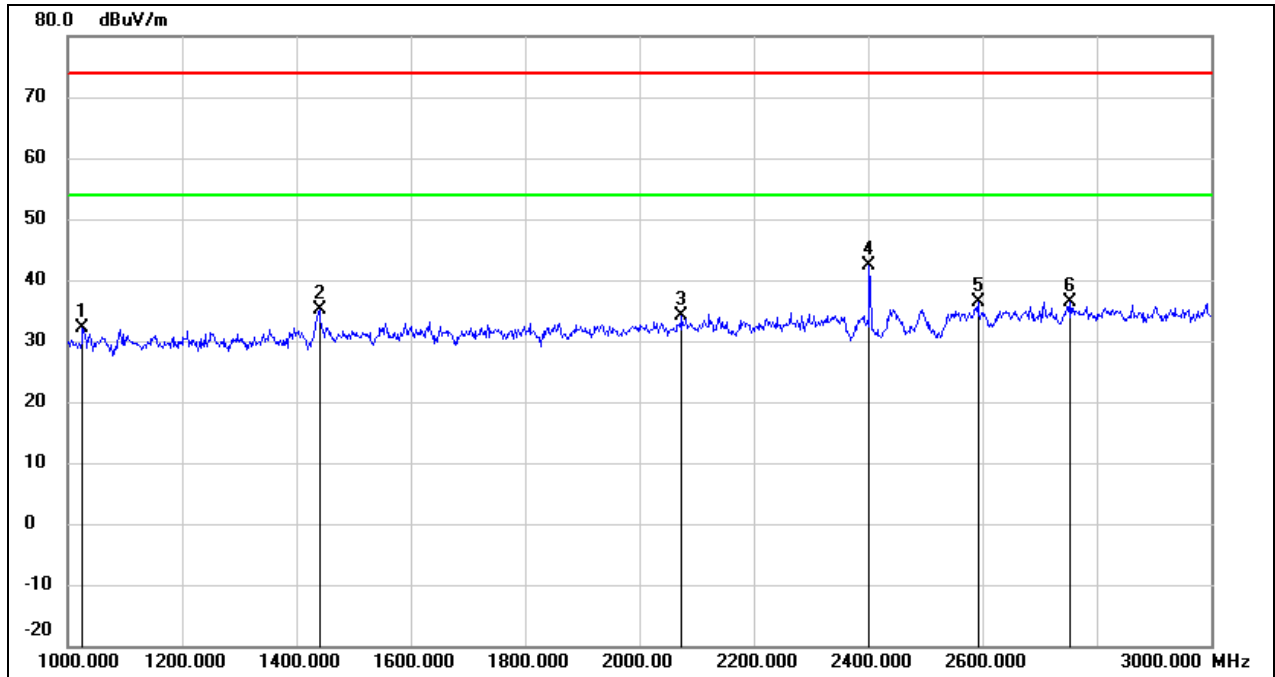

No.	Frequency (MHz)	Reading (dBuV)	Correct (dB/m)	Result (dBuV/m)	Limit (dBuV/m)	Margin (dB)	Remark
1	1026.000	46.92	-14.91	32.01	74.00	-41.99	peak
2	1440.000	48.01	-12.98	35.03	74.00	-38.97	peak
3	2074.000	44.74	-10.68	34.06	74.00	-39.94	peak
4	2402.000	51.31	-8.99	42.32	/	/	Fundamental
5	2592.000	44.47	-8.21	36.26	74.00	-37.74	peak
6	2754.000	44.12	-7.72	36.40	74.00	-37.60	peak

Test Mode:	GFSK	Channel:	2441
Polarity:	Horizontal	Test Voltage:	DC 5V

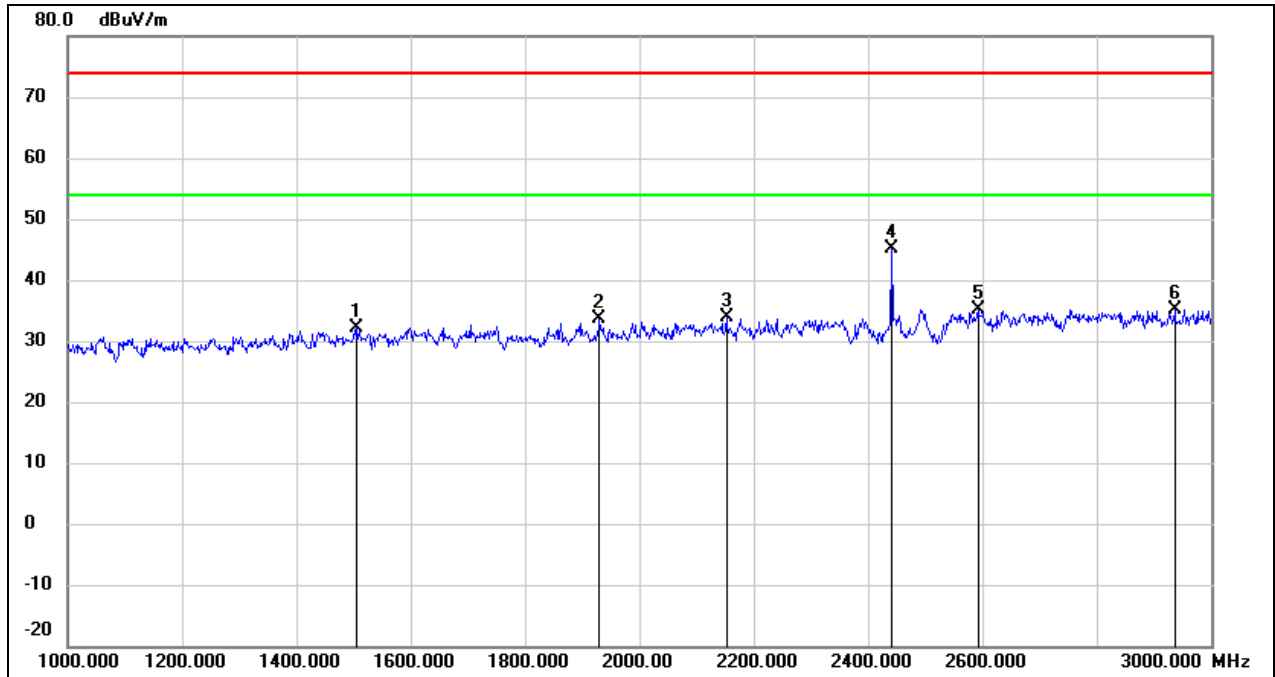

No.	Frequency (MHz)	Reading (dBuV)	Correct (dB/m)	Result (dBuV/m)	Limit (dBuV/m)	Margin (dB)	Remark
1	1506.000	44.75	-12.69	32.06	74.00	-41.94	peak
2	1930.000	44.94	-11.29	33.65	74.00	-40.35	peak
3	2152.000	44.05	-10.27	33.78	74.00	-40.22	peak
4	2441.000	53.94	-8.79	45.15	/	/	Fundamental
5	2592.000	43.43	-8.21	35.22	74.00	-38.78	peak
6	2936.000	42.35	-7.17	35.18	74.00	-38.82	peak

Test Mode:	GFSK	Channel:	2441
Polarity:	Vertical	Test Voltage:	DC 5V

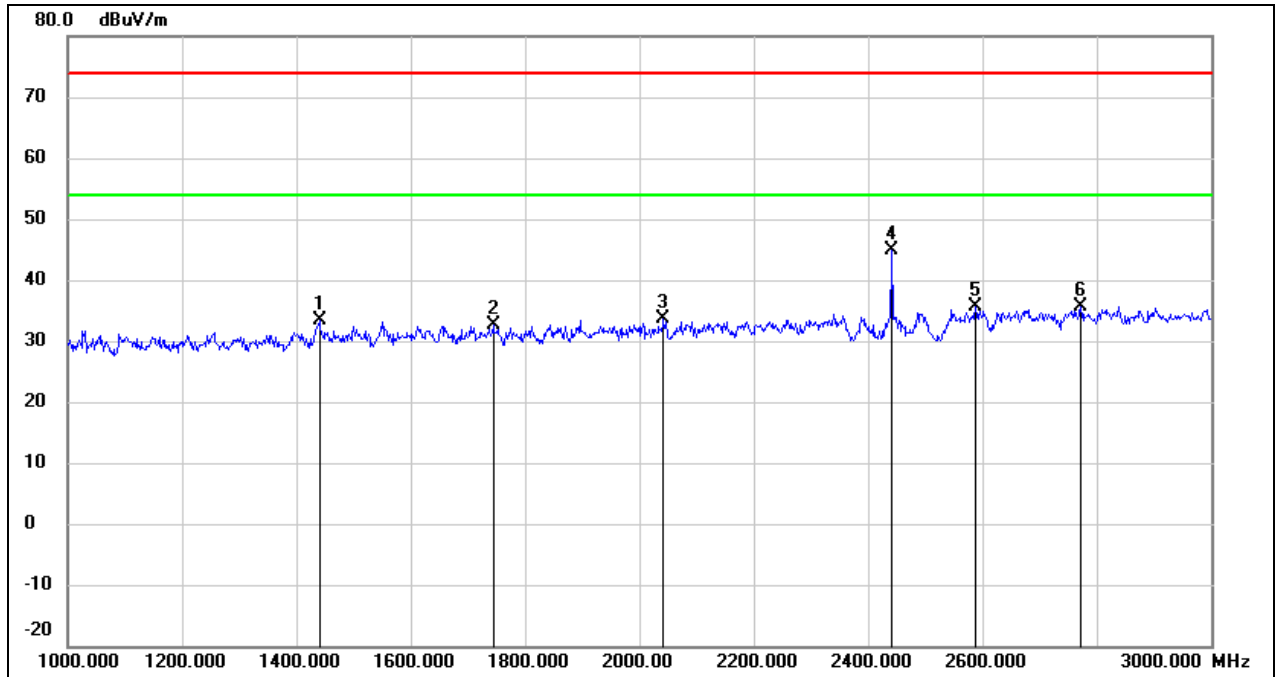

No.	Frequency (MHz)	Reading (dBuV)	Correct (dB/m)	Result (dBuV/m)	Limit (dBuV/m)	Margin (dB)	Remark
1	1440.000	46.32	-12.98	33.34	74.00	-40.66	peak
2	1744.000	44.61	-11.90	32.71	74.00	-41.29	peak
3	2042.000	44.37	-10.84	33.53	74.00	-40.47	peak
4	2441.000	53.56	-8.79	44.77	/	/	Fundamental
5	2588.000	43.73	-8.22	35.51	74.00	-38.49	peak
6	2772.000	43.37	-7.67	35.70	74.00	-38.30	peak

Test Mode:	GFSK	Channel:	2480
Polarity:	Horizontal	Test Voltage:	DC 5V

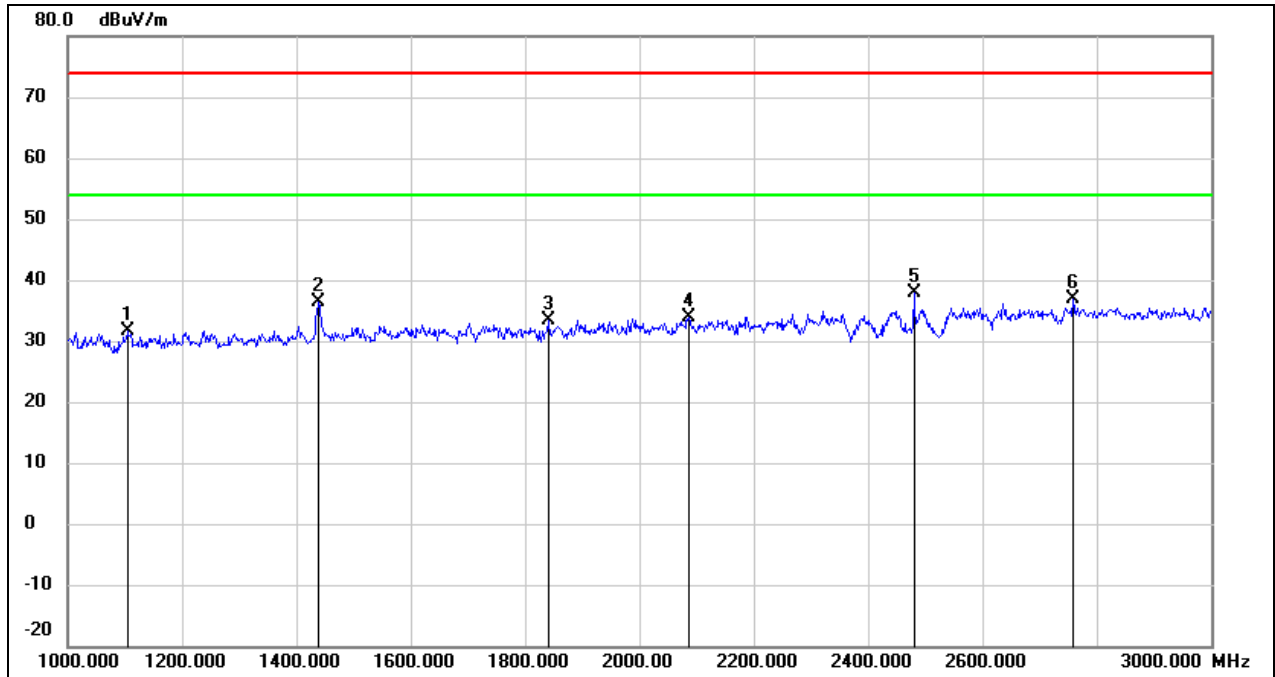

No.	Frequency (MHz)	Reading (dBuV)	Correct (dB/m)	Result (dBuV/m)	Limit (dBuV/m)	Margin (dB)	Remark
1	1104.000	46.14	-14.55	31.59	74.00	-42.41	peak
2	1438.000	49.26	-13.00	36.26	74.00	-37.74	peak
3	1840.000	44.99	-11.58	33.41	74.00	-40.59	peak
4	2086.000	44.52	-10.62	33.90	74.00	-40.10	peak
5	2480.000	46.58	-8.59	37.99	/	/	Fundamental
6	2758.000	44.51	-7.72	36.79	74.00	-37.21	peak

Test Mode:	GFSK	Channel:	2480
Polarity:	Vertical	Test Voltage:	DC 5V

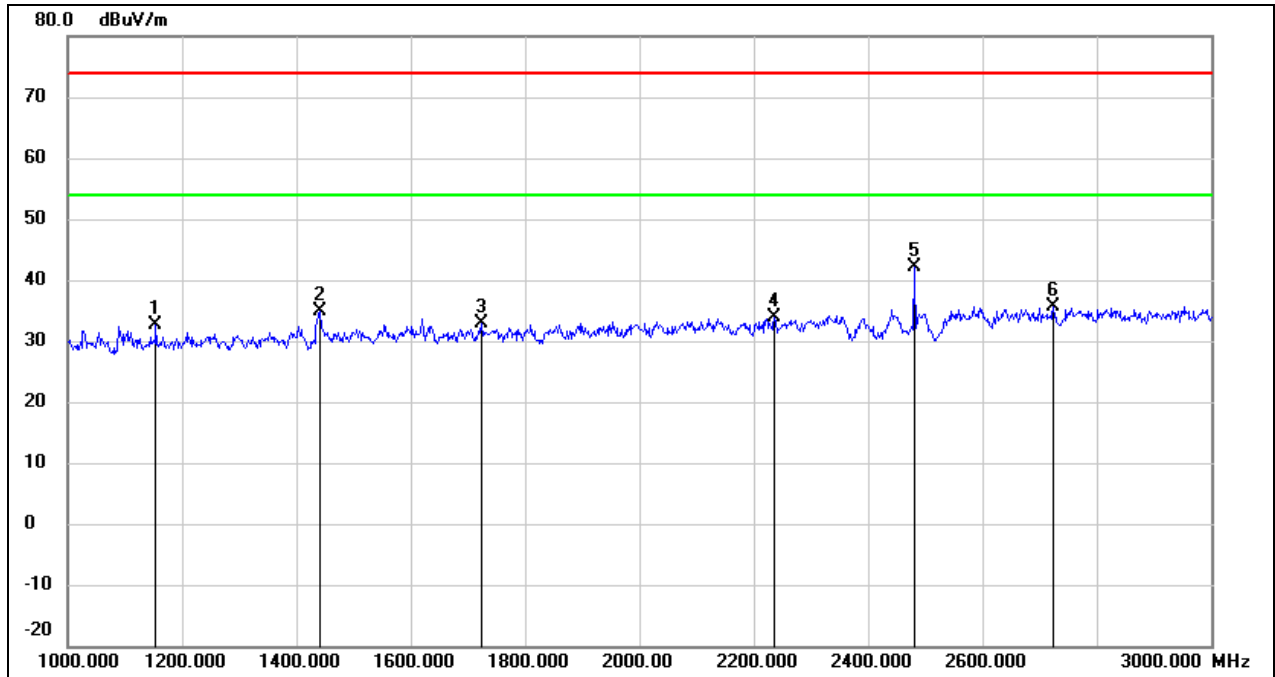

No.	Frequency (MHz)	Reading (dBuV)	Correct (dB/m)	Result (dBuV/m)	Limit (dBuV/m)	Margin (dB)	Remark
1	1154.000	46.90	-14.32	32.58	74.00	-41.42	peak
2	1440.000	47.87	-12.98	34.89	74.00	-39.11	peak
3	1724.000	44.92	-11.97	32.95	74.00	-41.05	peak
4	2236.000	43.61	-9.85	33.76	74.00	-40.24	peak
5	2480.000	50.62	-8.59	42.03	/	/	Fundamental
6	2724.000	43.40	-7.81	35.59	74.00	-38.41	peak

8.3. SPURIOUS EMISSIONS(3 GHZ~18 GHZ)

Test Mode:	GFSK	Channel:	2402
Polarity:	Horizontal	Test Voltage:	DC 5V

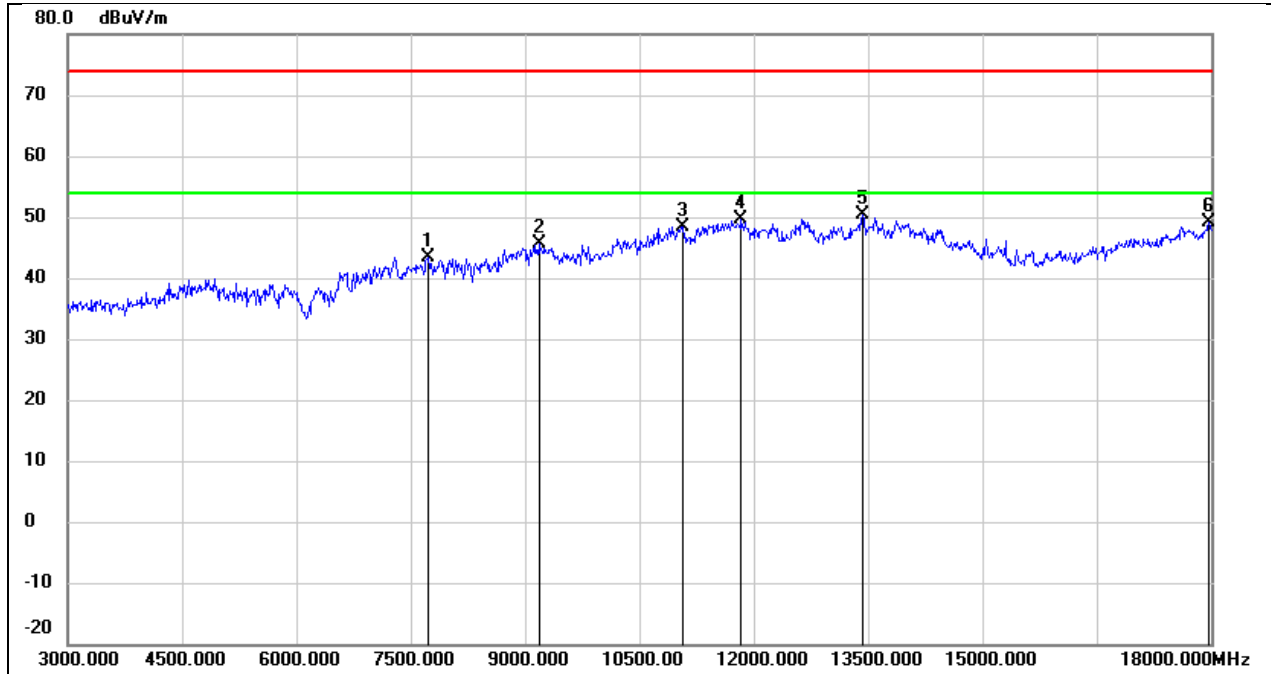

No.	Frequency (MHz)	Reading (dBuV)	Correct (dB/m)	Result (dBuV/m)	Limit (dBuV/m)	Margin (dB)	Remark
1	7725.000	37.12	6.32	43.44	74.00	-30.56	peak
2	9180.000	35.00	10.56	45.56	74.00	-28.44	peak
3	11070.000	33.46	15.03	48.49	74.00	-25.51	peak
4	11835.000	32.00	17.51	49.51	74.00	-24.49	peak
5	13425.000	29.76	20.58	50.34	74.00	-23.66	peak
6	17970.000	23.65	25.51	49.16	74.00	-24.84	peak

Test Mode:	GFSK	Channel:	2402
Polarity:	Vertical	Test Voltage:	DC 5V

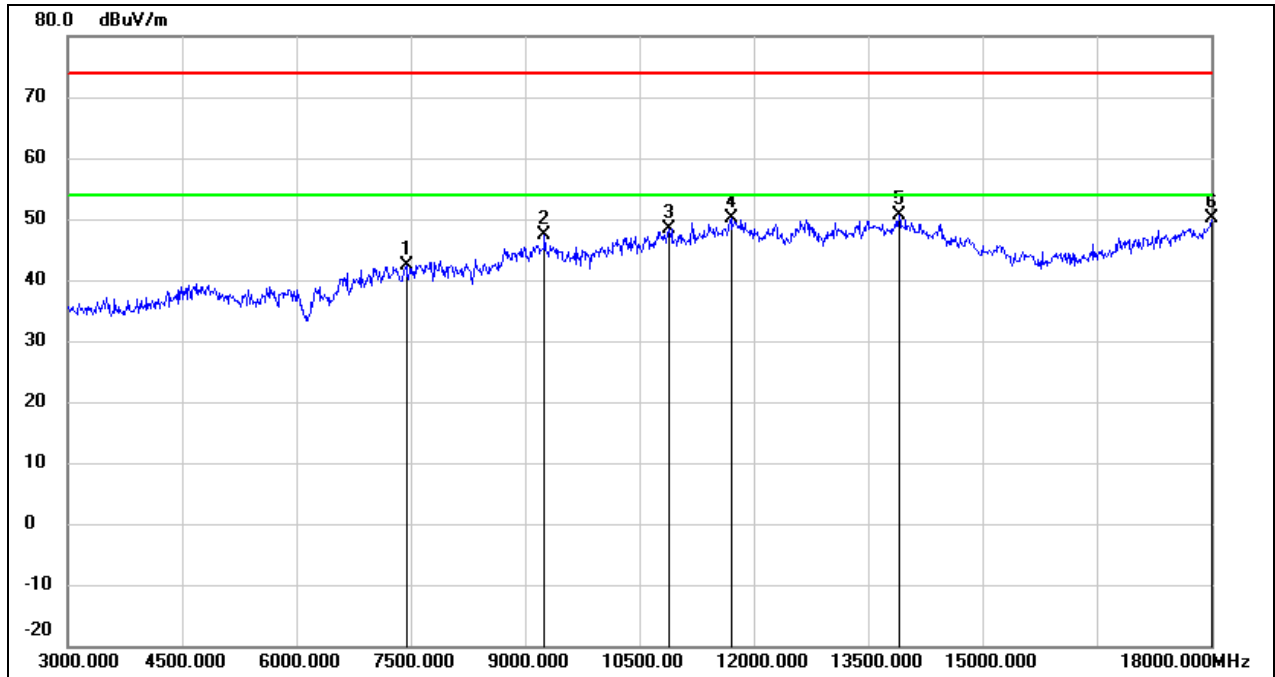

No.	Frequency (MHz)	Reading (dBuV)	Correct (dB/m)	Result (dBuV/m)	Limit (dBuV/m)	Margin (dB)	Remark
1	7440.000	35.97	6.38	42.35	74.00	-31.65	peak
2	9255.000	36.91	10.59	47.50	74.00	-26.50	peak
3	10890.000	34.11	14.39	48.50	74.00	-25.50	peak
4	11700.000	32.97	17.14	50.11	74.00	-23.89	peak
5	13905.000	28.99	21.76	50.75	74.00	-23.25	peak
6	18000.000	24.43	25.69	50.12	74.00	-23.88	peak

Test Mode:	GFSK	Channel:	2441
Polarity:	Horizontal	Test Voltage:	DC 5V

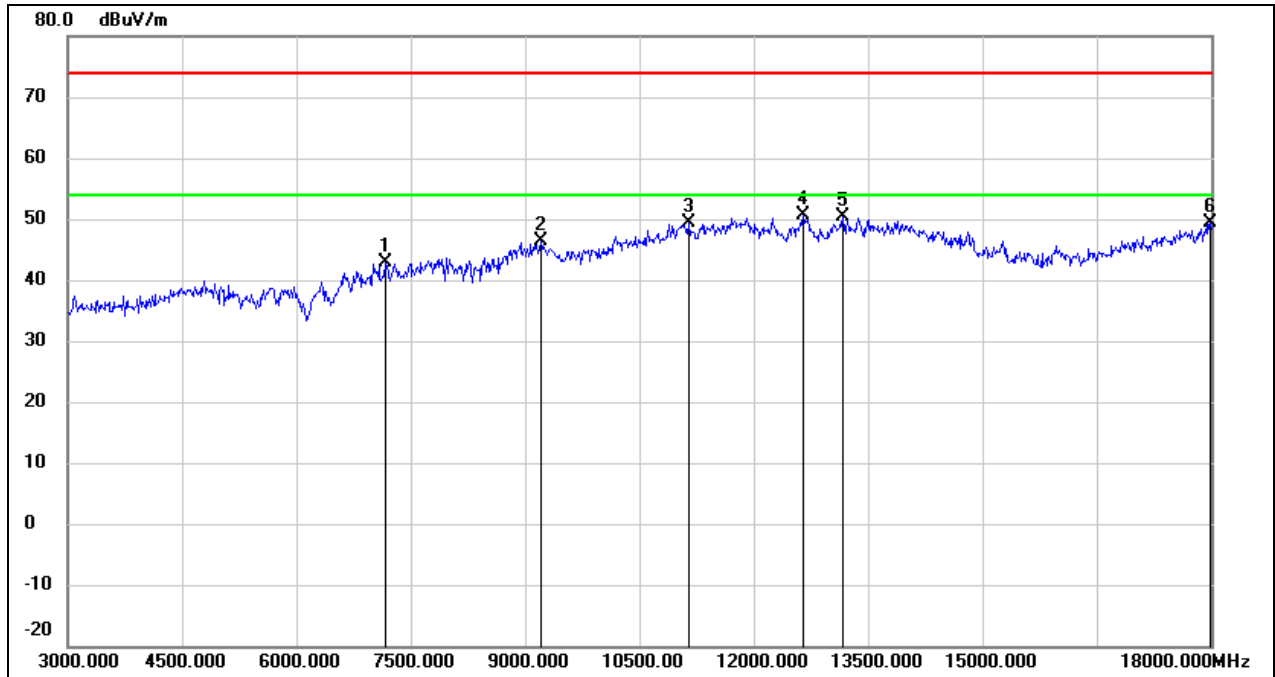

No.	Frequency (MHz)	Reading (dBuV)	Correct (dB/m)	Result (dBuV/m)	Limit (dBuV/m)	Margin (dB)	Remark
1	7170.000	36.44	6.56	43.00	74.00	-31.00	peak
2	9210.000	35.77	10.57	46.34	74.00	-27.66	peak
3	11145.000	34.00	15.31	49.31	74.00	-24.69	peak
4	12645.000	32.71	17.92	50.63	74.00	-23.37	peak
5	13170.000	30.84	19.46	50.30	74.00	-23.70	peak
6	17985.000	23.74	25.60	49.34	74.00	-24.66	peak

Test Mode:	GFSK	Channel:	2441
Polarity:	Vertical	Test Voltage:	DC 5V

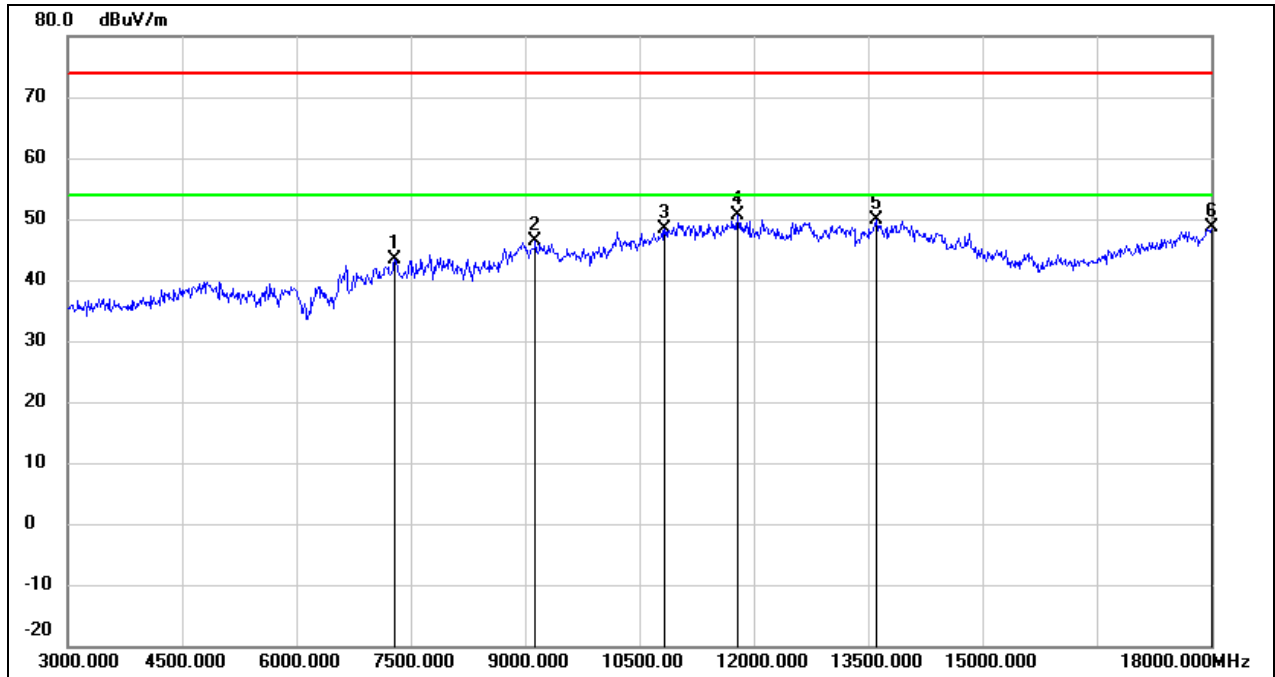

No.	Frequency (MHz)	Reading (dBuV)	Correct (dB/m)	Result (dBuV/m)	Limit (dBuV/m)	Margin (dB)	Remark
1	7290.000	36.92	6.48	43.40	74.00	-30.60	peak
2	9135.000	35.80	10.55	46.35	74.00	-27.65	peak
3	10830.000	34.19	14.16	48.35	74.00	-25.65	peak
4	11790.000	33.18	17.38	50.56	74.00	-23.44	peak
5	13605.000	28.80	21.12	49.92	74.00	-24.08	peak
6	18000.000	22.95	25.69	48.64	74.00	-25.36	peak

Test Mode:	GFSK	Channel:	2480
Polarity:	Horizontal	Test Voltage:	DC 5V

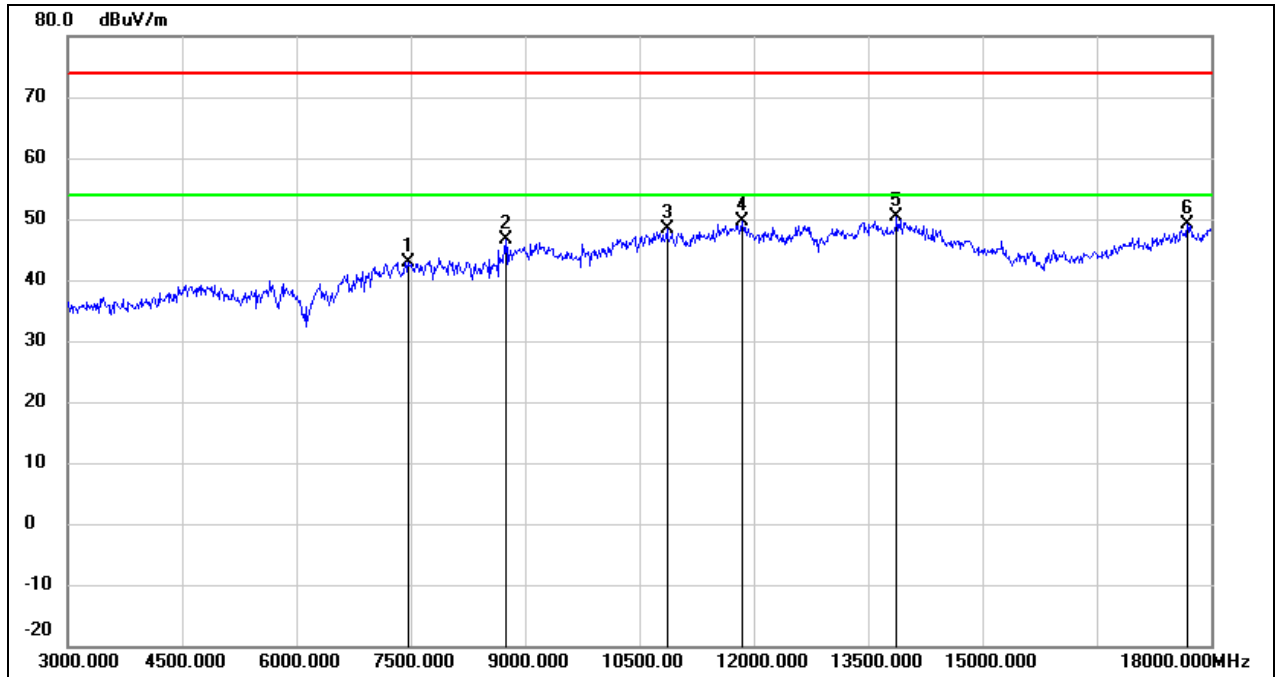

No.	Frequency (MHz)	Reading (dBuV)	Correct (dB/m)	Result (dBuV/m)	Limit (dBuV/m)	Margin (dB)	Remark
1	7470.000	36.60	6.34	42.94	74.00	-31.06	peak
2	8745.000	38.01	8.62	46.63	74.00	-27.37	peak
3	10860.000	34.05	14.27	48.32	74.00	-25.68	peak
4	11850.000	32.15	17.56	49.71	74.00	-24.29	peak
5	13875.000	28.73	21.70	50.43	74.00	-23.57	peak
6	17685.000	25.24	23.82	49.06	74.00	-24.94	peak

Test Mode:	GFSK	Channel:	2480
Polarity:	Vertical	Test Voltage:	DC 5V

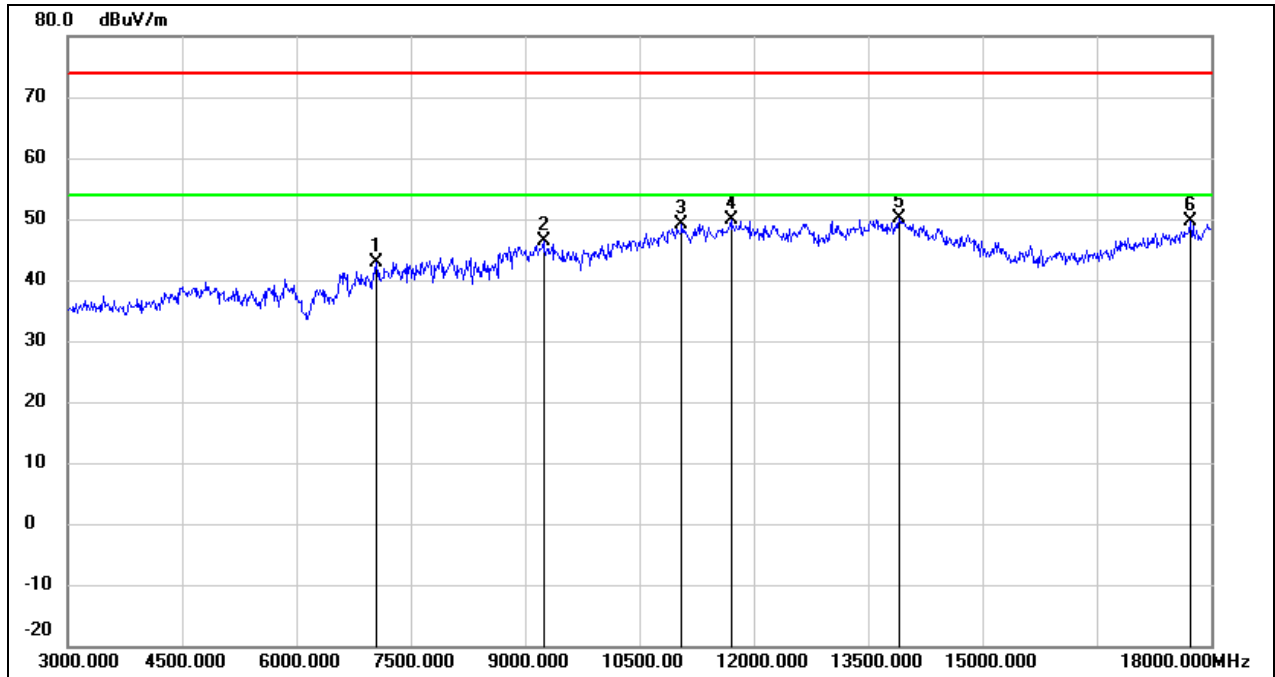

No.	Frequency (MHz)	Reading (dBuV)	Correct (dB/m)	Result (dBuV/m)	Limit (dBuV/m)	Margin (dB)	Remark
1	7050.000	36.11	6.66	42.77	74.00	-31.23	peak
2	9240.000	35.69	10.58	46.27	74.00	-27.73	peak
3	11055.000	34.11	14.96	49.07	74.00	-24.93	peak
4	11700.000	32.62	17.14	49.76	74.00	-24.24	peak
5	13905.000	28.27	21.76	50.03	74.00	-23.97	peak
6	17730.000	25.66	24.09	49.75	74.00	-24.25	peak

Test Mode:	8DPSK	Channel:	2402
Polarity:	Horizontal	Test Voltage:	DC 5V

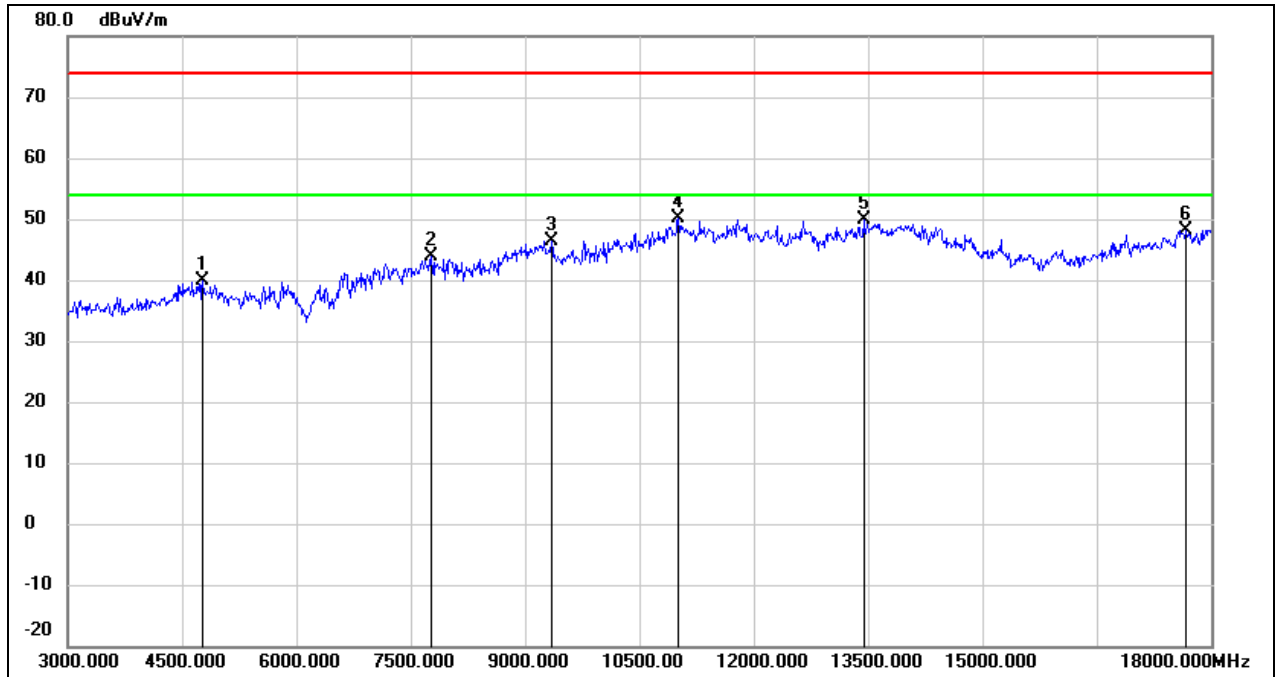

No.	Frequency (MHz)	Reading (dBuV)	Correct (dB/m)	Result (dBuV/m)	Limit (dBuV/m)	Margin (dB)	Remark
1	4770.000	40.27	-0.43	39.84	74.00	-34.16	peak
2	7770.000	37.56	6.31	43.87	74.00	-30.13	peak
3	9345.000	35.76	10.63	46.39	74.00	-27.61	peak
4	11010.000	35.20	14.81	50.01	74.00	-23.99	peak
5	13440.000	29.18	20.64	49.82	74.00	-24.18	peak
6	17670.000	24.28	23.73	48.01	74.00	-25.99	peak

Test Mode:	8DPSK	Channel:	2402
Polarity:	Vertical	Test Voltage:	DC 5V

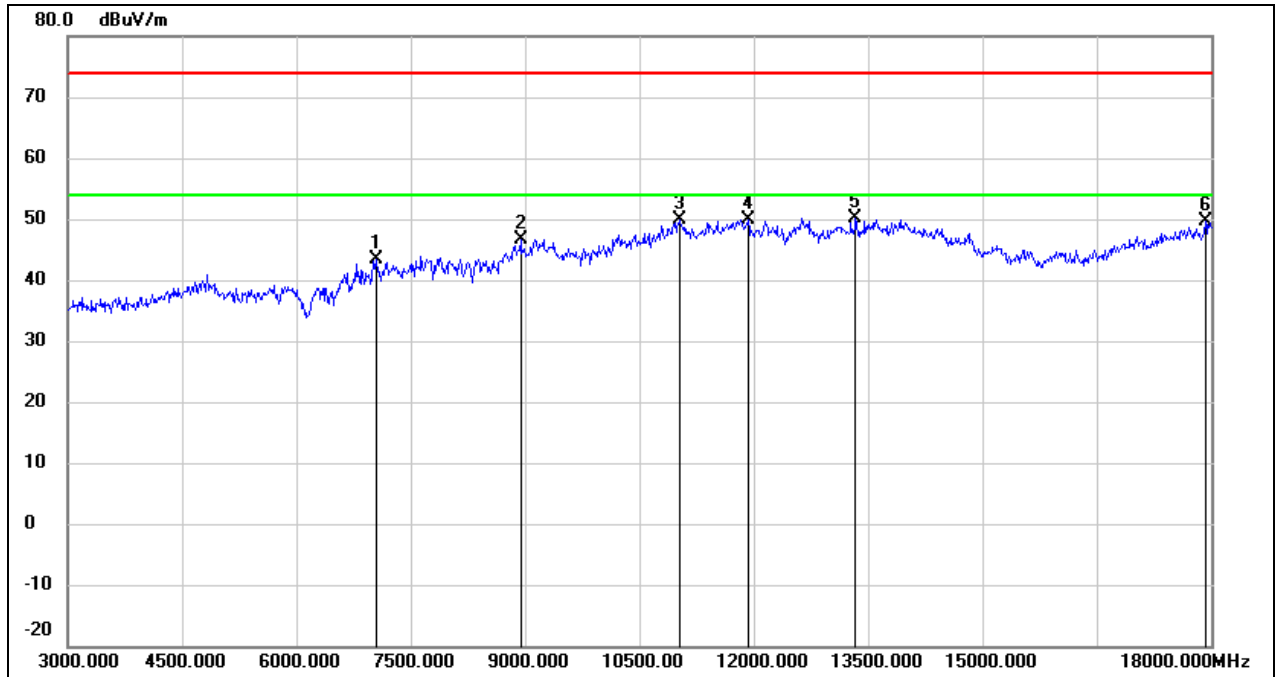

No.	Frequency (MHz)	Reading (dBuV)	Correct (dB/m)	Result (dBuV/m)	Limit (dBuV/m)	Margin (dB)	Remark
1	7050.000	36.80	6.66	43.46	74.00	-30.54	peak
2	8940.000	36.61	10.04	46.65	74.00	-27.35	peak
3	11025.000	34.94	14.85	49.79	74.00	-24.21	peak
4	11925.000	32.16	17.75	49.91	74.00	-24.09	peak
5	13335.000	29.97	20.18	50.15	74.00	-23.85	peak
6	17925.000	24.50	25.25	49.75	74.00	-24.25	peak

Test Mode:	8DPSK	Channel:	2441
Polarity:	Horizontal	Test Voltage:	DC 5V

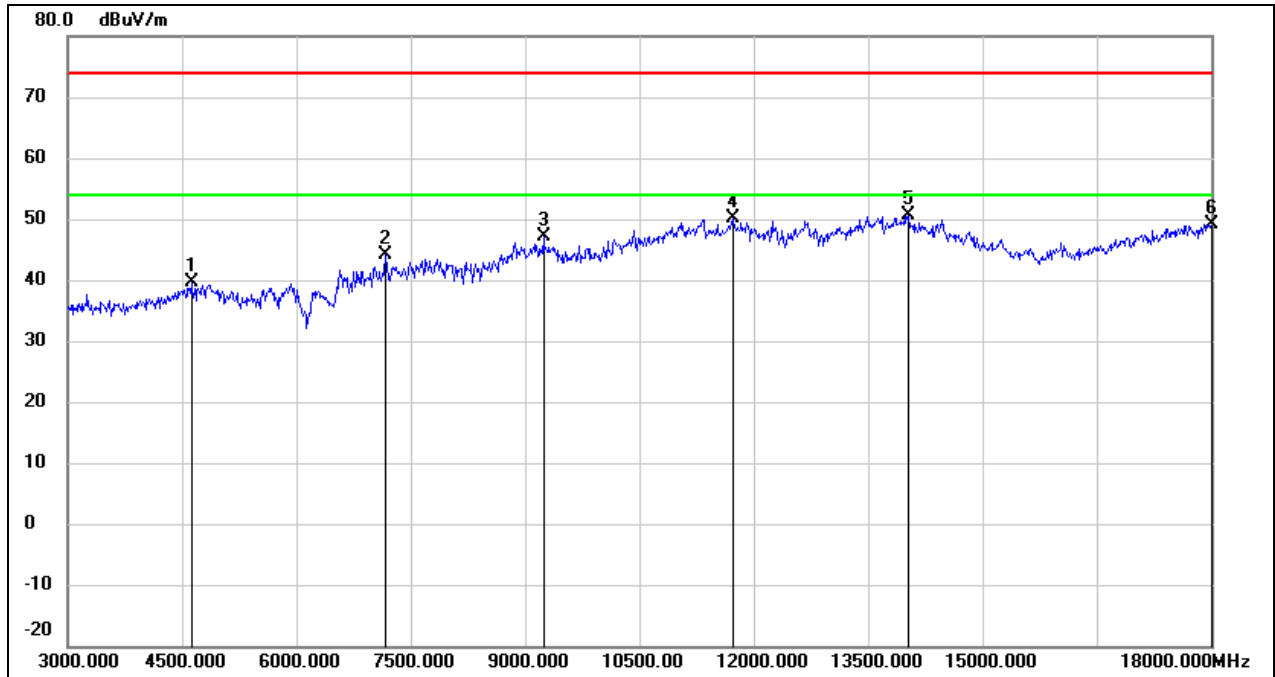

No.	Frequency (MHz)	Reading (dBuV)	Correct (dB/m)	Result (dBuV/m)	Limit (dBuV/m)	Margin (dB)	Remark
1	4620.000	40.51	-1.00	39.51	74.00	-34.49	peak
2	7170.000	37.59	6.56	44.15	74.00	-29.85	peak
3	9240.000	36.57	10.58	47.15	74.00	-26.85	peak
4	11730.000	32.88	17.22	50.10	74.00	-23.90	peak
5	14025.000	28.74	21.86	50.60	74.00	-23.40	peak
6	18000.000	23.40	25.69	49.09	74.00	-24.91	peak

Test Mode:	8DPSK	Channel:	2441
Polarity:	Vertical	Test Voltage:	DC 5V

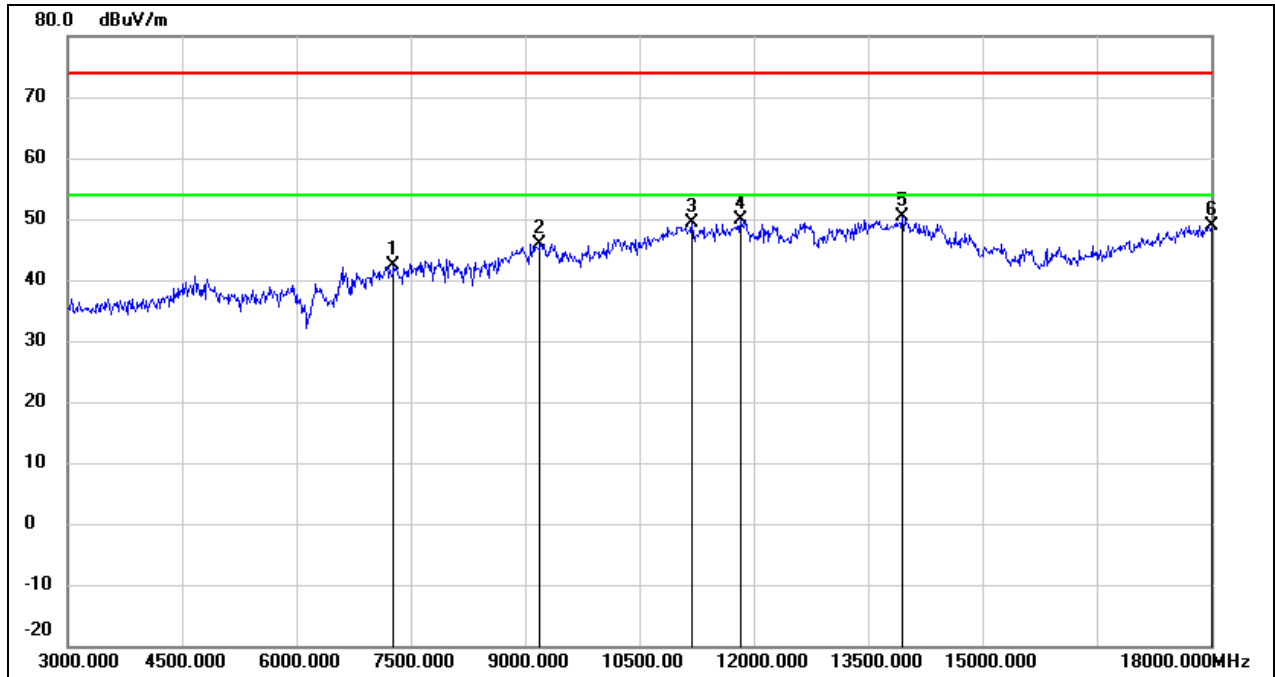

No.	Frequency (MHz)	Reading (dBuV)	Correct (dB/m)	Result (dBuV/m)	Limit (dBuV/m)	Margin (dB)	Remark
1	7275.000	35.94	6.49	42.43	74.00	-31.57	peak
2	9195.000	35.31	10.56	45.87	74.00	-28.13	peak
3	11190.000	33.82	15.46	49.28	74.00	-24.72	peak
4	11820.000	32.32	17.47	49.79	74.00	-24.21	peak
5	13950.000	28.63	21.86	50.49	74.00	-23.51	peak
6	18000.000	23.31	25.69	49.00	74.00	-25.00	peak

Test Mode:	8DPSK	Channel:	2480
Polarity:	Horizontal	Test Voltage:	DC 5V

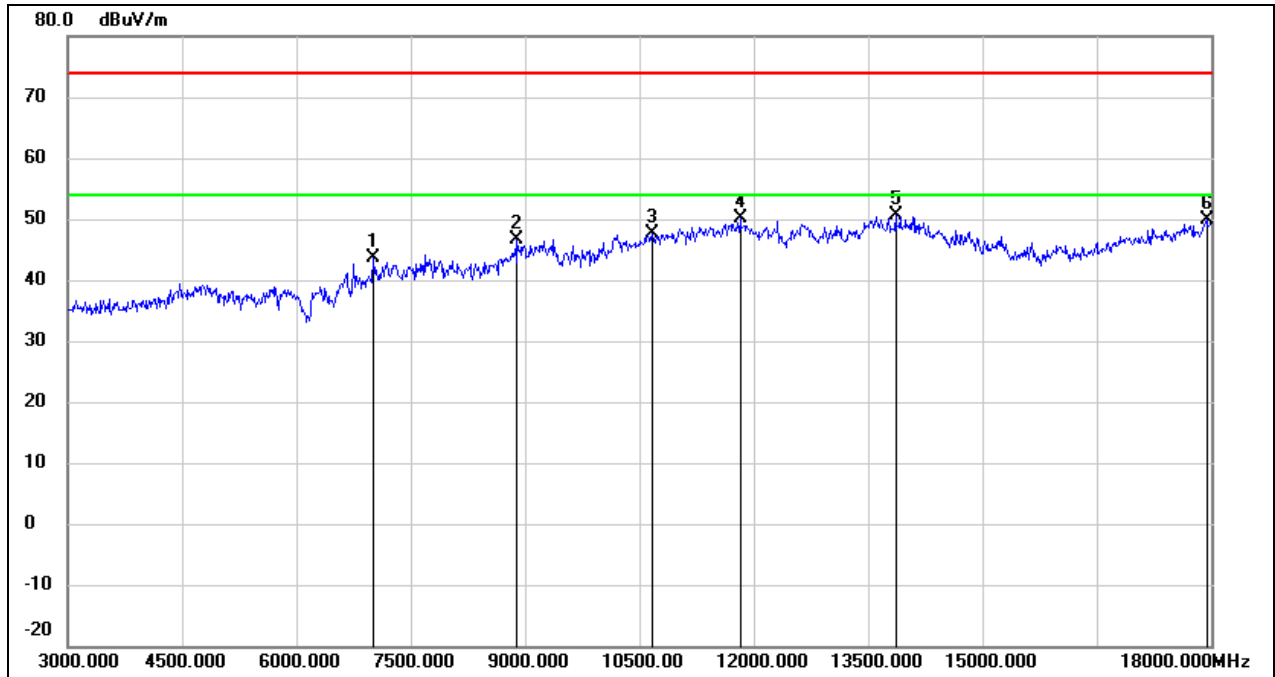

No.	Frequency (MHz)	Reading (dBuV)	Correct (dB/m)	Result (dBuV/m)	Limit (dBuV/m)	Margin (dB)	Remark
1	7005.000	36.85	6.69	43.54	74.00	-30.46	peak
2	8895.000	36.97	9.71	46.68	74.00	-27.32	peak
3	10665.000	33.94	13.58	47.52	74.00	-26.48	peak
4	11820.000	32.55	17.47	50.02	74.00	-23.98	peak
5	13860.000	29.02	21.67	50.69	74.00	-23.31	peak
6	17940.000	24.54	25.34	49.88	74.00	-24.12	peak

Test Mode:	8DPSK	Channel:	2480
Polarity:	Vertical	Test Voltage:	DC 5V

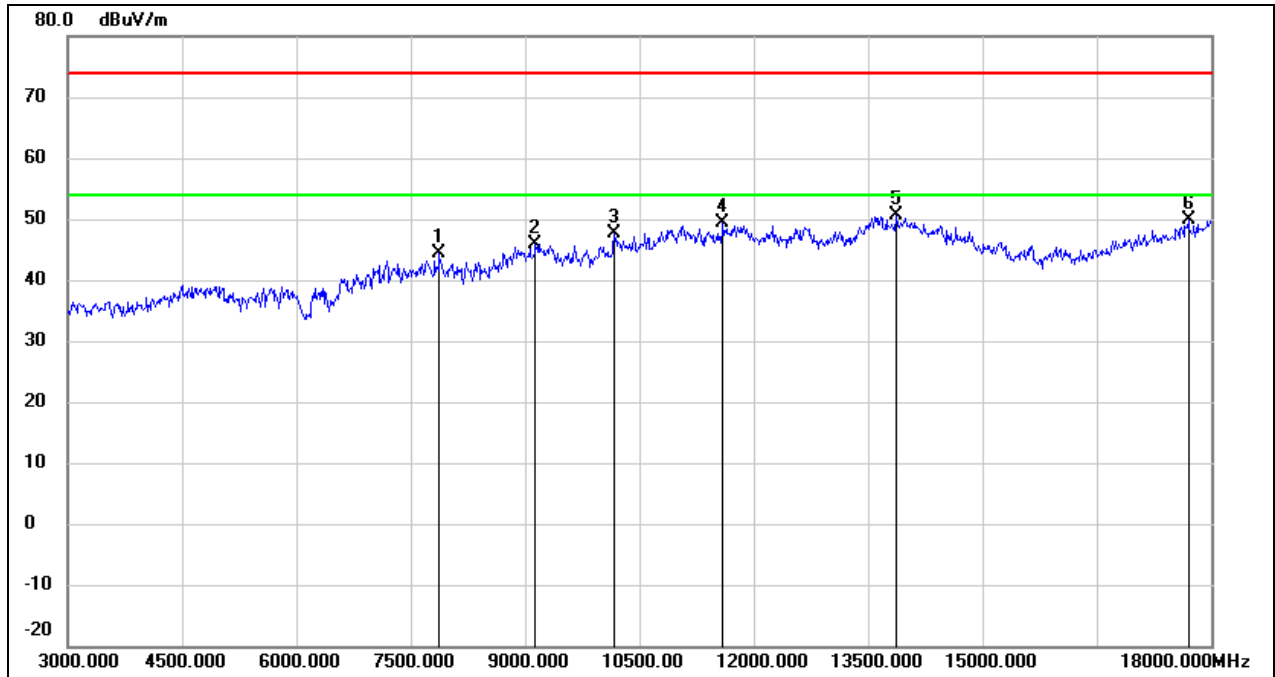

No.	Frequency (MHz)	Reading (dBuV)	Correct (dB/m)	Result (dBuV/m)	Limit (dBuV/m)	Margin (dB)	Remark
1	7875.000	38.10	6.31	44.41	74.00	-29.59	peak
2	9135.000	35.33	10.55	45.88	74.00	-28.12	peak
3	10170.000	35.29	12.34	47.63	74.00	-26.37	peak
4	11595.000	32.61	16.86	49.47	74.00	-24.53	peak
5	13875.000	28.91	21.70	50.61	74.00	-23.39	peak
6	17700.000	26.00	23.91	49.91	74.00	-24.09	peak

8.4. SPURIOUS EMISSIONS(9 KHZ~30 MHZ)

Test Mode:	GFSK	Channel:	2402
Polarity:	Horizontal	Test Voltage:	DC 5V

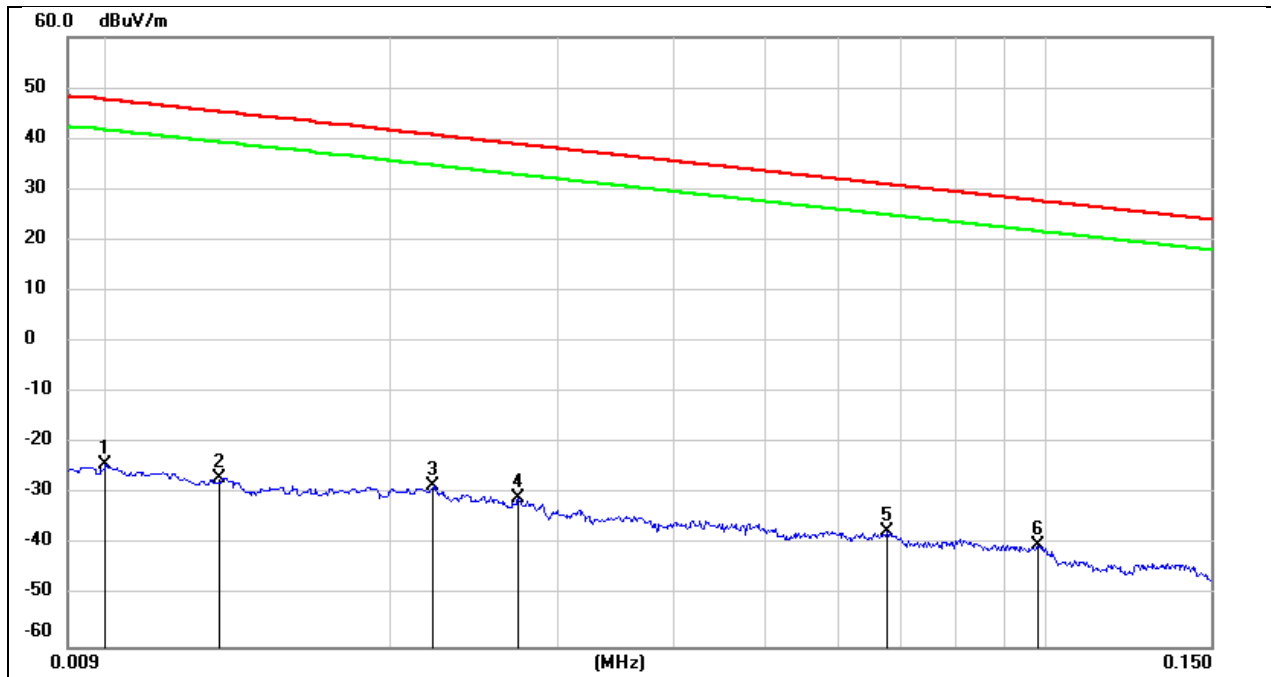

No.	Frequency (MHz)	Reading (dBuV)	Correct (dB/m)	FCC Result (dBuV/m)	FCC Limit (dBuV/m)	ISED Result (dBuA/m)	ISED Limit (dBuA/m)	Margin (dB)	Remark
1	0.01	77.22	-101.4	-24.18	47.6	-75.68	-3.9	-71.78	peak
2	0.0131	74.47	-101.38	-26.91	45.25	-78.41	-6.25	-72.16	peak
3	0.0221	73.13	-101.35	-28.22	40.71	-79.72	-10.79	-68.93	peak
4	0.0273	70.49	-101.38	-30.89	38.88	-82.39	-12.62	-69.77	peak
5	0.0675	64.14	-101.56	-37.42	31.02	-88.92	-20.48	-68.44	peak
6	0.0981	61.77	-101.78	-40.01	27.77	-91.51	-23.73	-67.78	peak

Test Mode:	GFSK	Channel:	2402
Polarity:	Horizontal	Test Voltage:	DC 5V

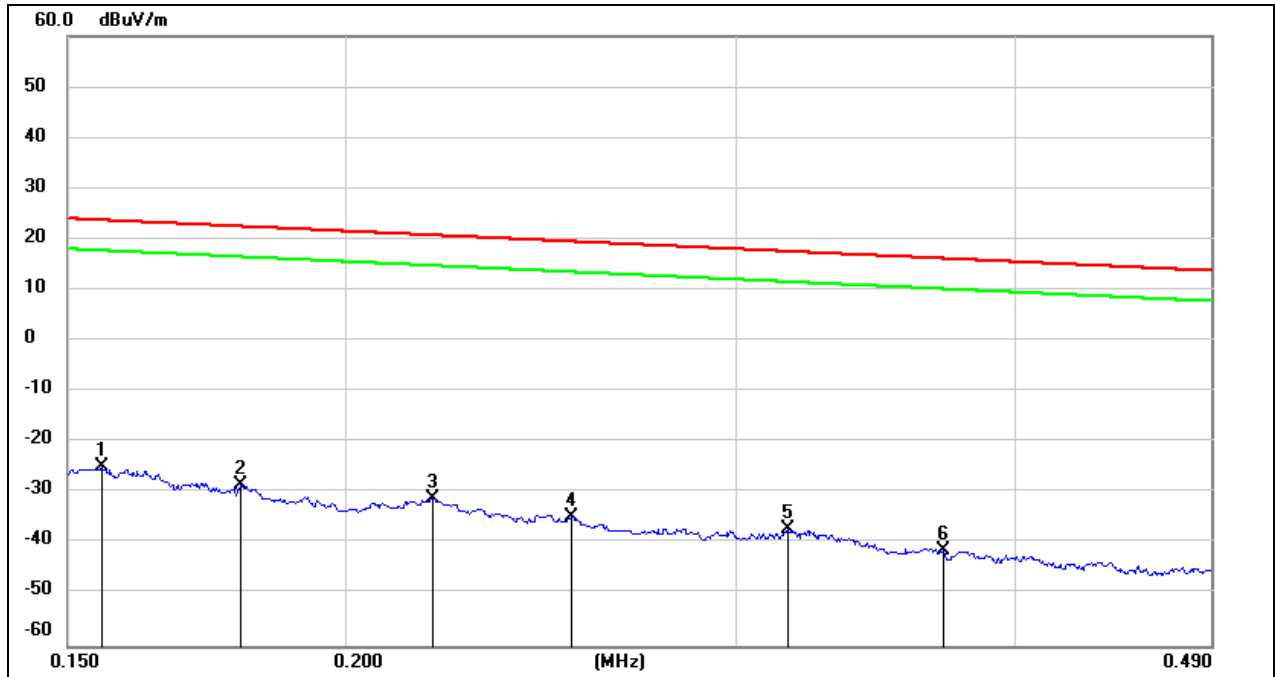

No.	Frequency (MHz)	Reading (dBuV)	Correct (dB/m)	FCC Result (dBuV/m)	FCC Limit (dBuV/m)	ISED Result (dBuA/m)	ISED Limit (dBuA/m)	Margin (dB)	Remark
1	0.1554	76.77	-101.65	-24.88	23.77	-76.38	-27.73	-48.65	peak
2	0.1794	73.27	-101.68	-28.41	22.53	-79.91	-28.97	-50.94	peak
3	0.219	70.77	-101.75	-30.98	20.79	-82.48	-30.71	-51.77	peak
4	0.253	67.14	-101.8	-34.66	19.54	-86.16	-31.96	-54.2	peak
5	0.3163	64.7	-101.87	-37.17	17.6	-88.67	-33.9	-54.77	peak
6	0.3714	60.78	-101.93	-41.15	16.2	-92.65	-35.3	-57.35	peak

Test Mode:	GFSK	Channel:	2402
Polarity:	Horizontal	Test Voltage:	DC 5V

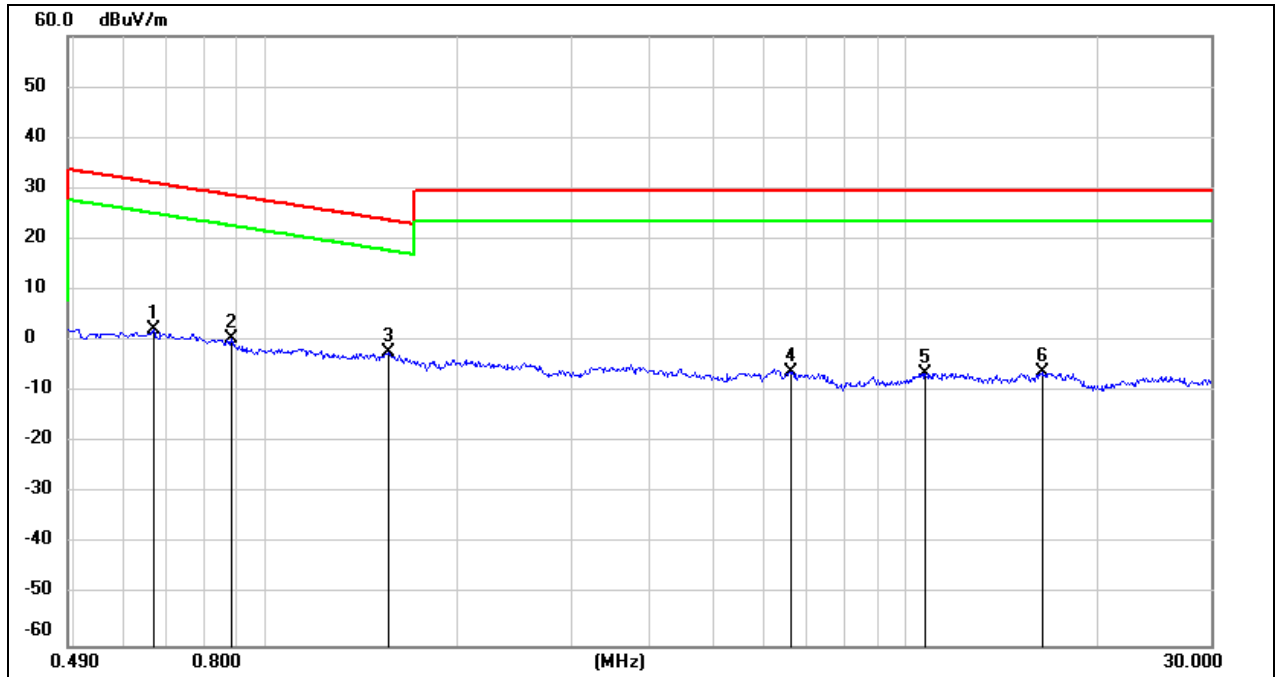

No.	Frequency (MHz)	Reading (dBuV)	Correct (dB/m)	FCC Result (dBuV/m)	FCC Limit (dBuV/m)	ISED Result (dBuA/m)	ISED Limit (dBuA/m)	Margin (dB)	Remark
1	0.6671	64.25	-62.1	2.15	31.12	29.54	-20.38	-28.97	peak
2	0.882	62.69	-62.19	0.5	28.69	29.54	-22.81	-28.19	peak
3	1.5564	59.68	-62.02	-2.34	23.76	29.54	-27.74	-26.1	peak
4	6.5998	55.12	-61.27	-6.15	29.54	29.54	-21.96	-35.69	peak
5	10.7299	54.48	-60.83	-6.35	29.54	29.54	-21.96	-35.89	peak
6	16.3959	54.67	-60.96	-6.29	29.54	29.54	-21.96	-35.83	peak

8.5. SPURIOUS EMISSIONS(18 GHZ~26 GHZ)

Test Mode:	GFSK	Channel:	2402
Polarity:	Horizontal	Test Voltage:	DC 5V

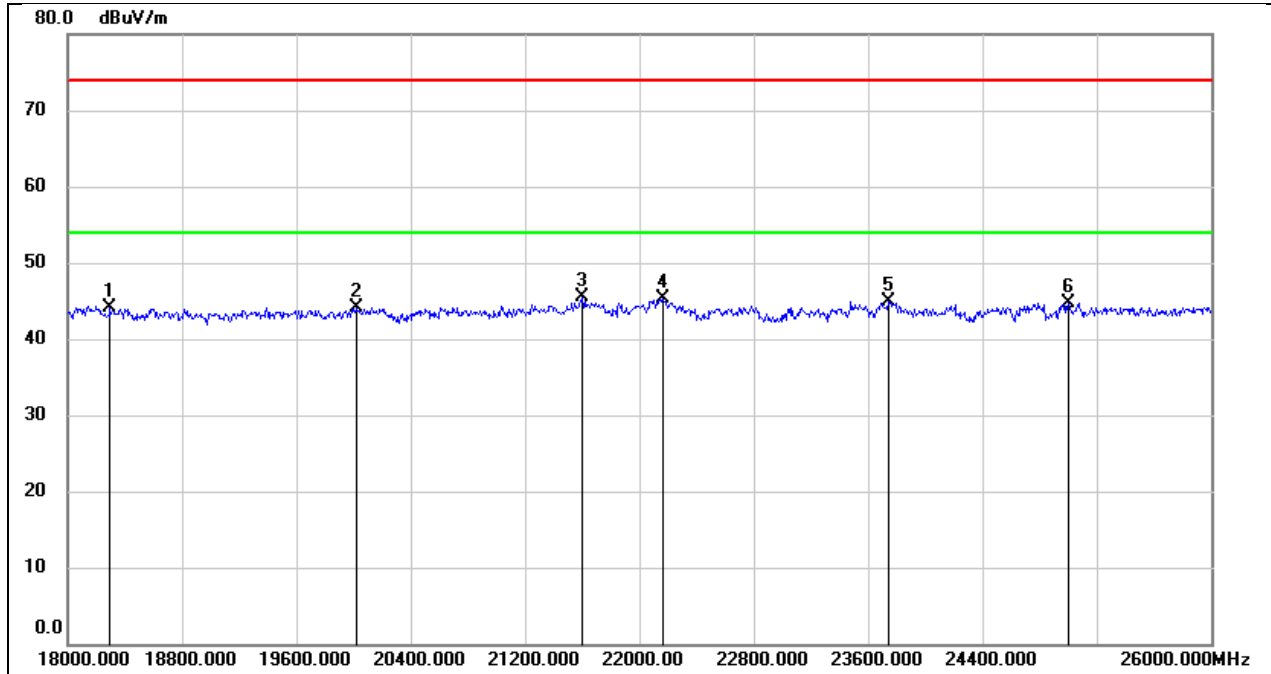

No.	Frequency (MHz)	Reading (dBuV)	Correct (dB/m)	Result (dBuV/m)	Limit (dBuV/m)	Margin (dB)	Remark
1	18296.000	49.63	-5.50	44.13	74.00	-29.87	peak
2	20016.000	49.56	-5.47	44.09	74.00	-29.91	peak
3	21600.000	50.02	-4.54	45.48	74.00	-28.52	peak
4	22160.000	49.58	-4.31	45.27	74.00	-28.73	peak
5	23744.000	48.15	-3.20	44.95	74.00	-29.05	peak
6	25000.000	46.86	-2.10	44.76	74.00	-29.24	peak

Test Mode:	GFSK	Channel:	2402
Polarity:	Vertical	Test Voltage:	DC 5V

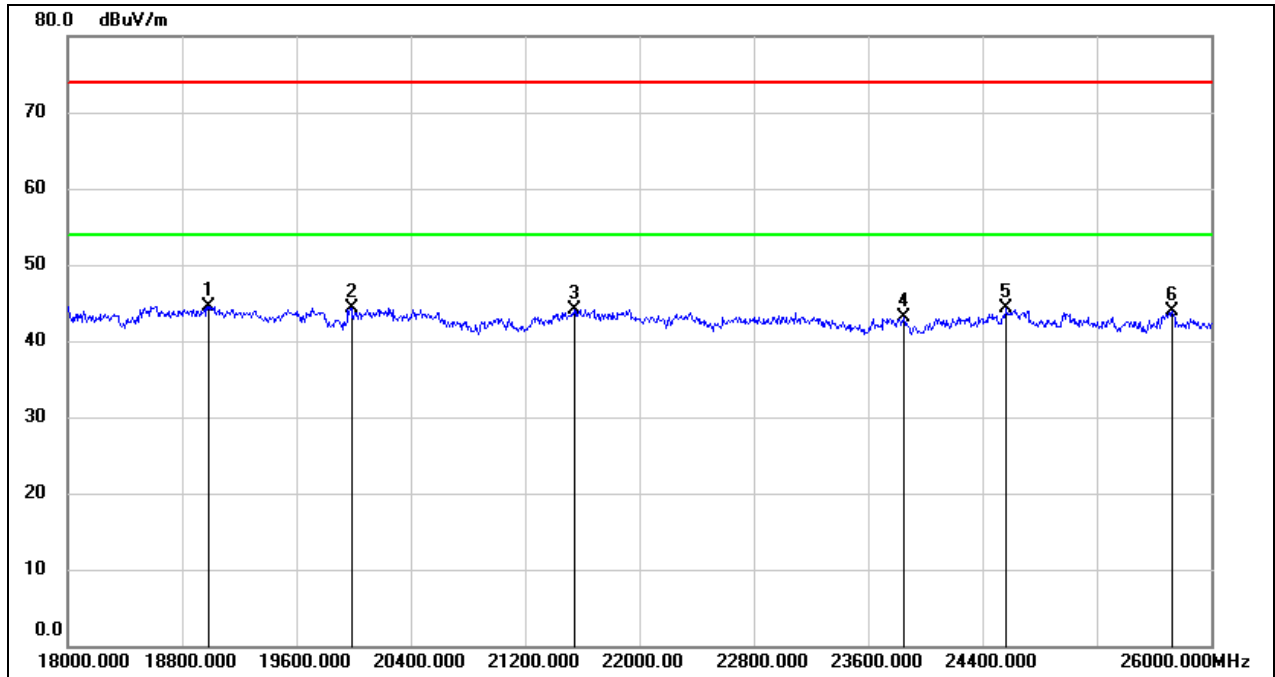

No.	Frequency (MHz)	Reading (dBuV)	Correct (dB/m)	Result (dBuV/m)	Limit (dBuV/m)	Margin (dB)	Remark
1	18984.000	49.79	-5.23	44.56	74.00	-29.44	peak
2	19984.000	49.71	-5.44	44.27	74.00	-29.73	peak
3	21544.000	48.76	-4.63	44.13	74.00	-29.87	peak
4	23848.000	46.18	-3.03	43.15	74.00	-30.85	peak
5	24568.000	46.60	-2.33	44.27	74.00	-29.73	peak
6	25728.000	44.61	-0.72	43.89	74.00	-30.11	peak

8.6. SPURIOUS EMISSIONS(30 MHZ~1 GHZ)

Test Mode:	GFSK	Channel:	2402
Polarity:	Horizontal	Test Voltage:	DC 5V

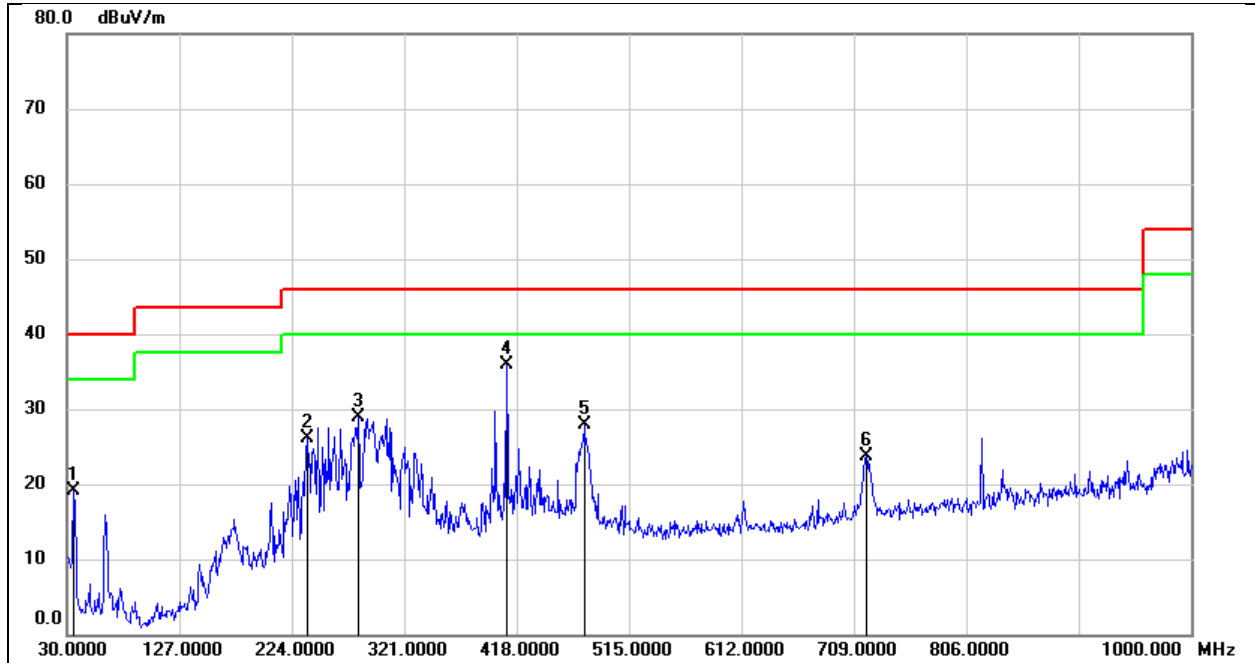

No.	Frequency (MHz)	Reading (dBuV)	Correct (dB/m)	Result (dBuV/m)	Limit (dBuV/m)	Margin (dB)	Remark
1	35.8200	38.29	-19.15	19.14	40.00	-20.86	QP
2	237.5800	44.35	-18.30	26.05	46.00	-19.95	QP
3	281.2300	45.34	-16.52	28.82	46.00	-17.18	QP
4	409.2700	48.56	-12.70	35.86	46.00	-10.14	QP
5	476.2000	39.11	-11.15	27.96	46.00	-18.04	QP
6	719.6700	31.14	-7.52	23.62	46.00	-22.38	QP

Test Mode:	GFSK	Channel:	2402
Polarity:	Vertical	Test Voltage:	DC 5V

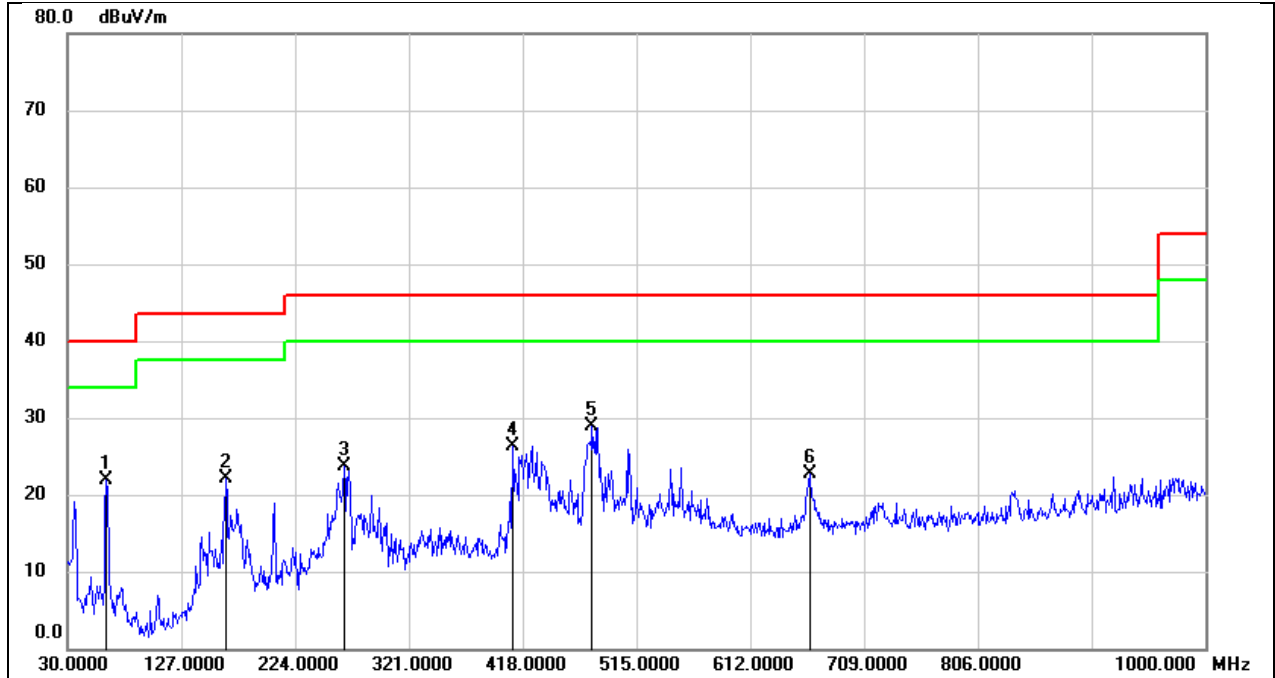

No.	Frequency (MHz)	Reading (dBuV)	Correct (dB/m)	Result (dBuV/m)	Limit (dBuV/m)	Margin (dB)	Remark
1	62.9800	42.25	-20.44	21.81	40.00	-18.19	QP
2	164.8300	39.45	-17.25	22.20	43.50	-21.30	QP
3	265.7100	41.43	-17.81	23.62	46.00	-22.38	QP
4	409.2700	39.07	-12.70	26.37	46.00	-19.63	QP
5	477.1700	40.06	-11.13	28.93	46.00	-17.07	QP
6	662.4400	31.69	-8.99	22.70	46.00	-23.30	QP

9. ANTENNA REQUIREMENT

REQUIREMENT

Please refer to FCC part 15.203

An intentional radiator shall be designed to ensure that no antenna other than that furnished by the responsible party shall be used with the device. The use of a permanently attached antenna or of an antenna that uses a unique coupling to the intentional radiator shall be considered sufficient to comply with the provisions of this section. The manufacturer may design the unit so that a broken antenna can be replaced by the user, but the use of a standard antenna jack or electrical connector is prohibited.

Please refer to FCC part 15.247(b)(4)

The conducted output power limit specified in paragraph (b) of this section is based on the use of antennas with directional gains that do not exceed 6 dBi. Except as shown in paragraph (c) of this section, if transmitting antennas of directional gain greater than 6 dBi are used, the conducted output power from the intentional radiator shall be reduced below the stated values in paragraphs (b)(1), (b)(2), and (b)(3) of this section, as appropriate, by the amount in dB that the directional gain of the antenna exceeds 6 dBi.

DESCRIPTION

Pass

10. AC POWER LINE CONDUCTED EMISSION

LIMITS

Please refer to CFR 47 FCC §15.207 (a) and ISED RSS-Gen Clause 8.8

FREQUENCY (MHz)	Quasi-peak	Average
0.15 -0.5	66 - 56 *	56 - 46 *
0.50 -5.0	56.00	46.00
5.0 -30.0	60.00	50.00

TEST PROCEDURE

TEST SETUP AND PROCEDURE

Refer to ANSI C63.10-2013 clause 6.2.

The EUT is put on a table of non-conducting material that is 80 cm high. The vertical conducting wall of shielding is located 40 cm to the rear of the EUT. The power line of the EUT is connected to the AC mains through a Artificial Mains Network (A.M.N.). A EMI Measurement Receiver (R&S Test Receiver ESR3) is used to test the emissions from both sides of AC line. According to the requirements in Section 6.2 of ANSI C63.10-2013. Conducted emissions from the EUT measured in the frequency range between 0.15 MHz and 30 MHz using CISPR Quasi-Peak and average detector mode. The bandwidth of EMI test receiver is set at 9 kHz.

The arrangement of the equipment is installed to meet the standards and operating in a manner, which tends to maximize its emission characteristics in a normal application.

TEST SETUP

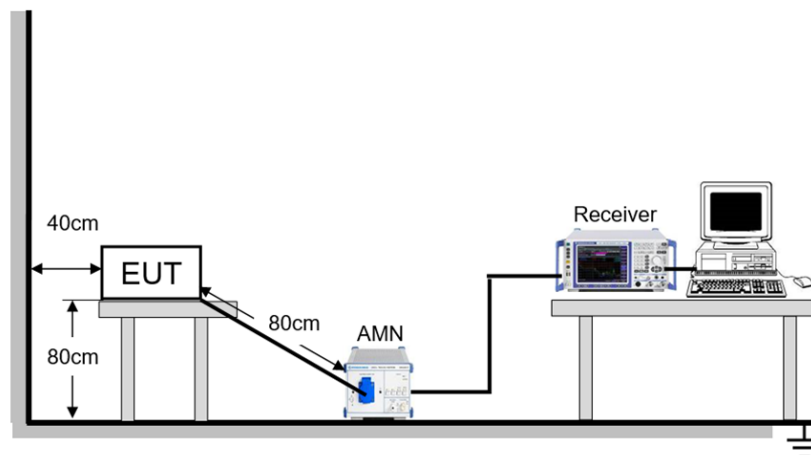

TEST ENVIRONMENT

Temperature	25.8°C	Relative Humidity	61.9%
Atmosphere Pressure	101kPa	Test Voltage	AC 120 V, 60 Hz

TEST DATE / ENGINEER

Test Date	June 6, 2023	Test By	Wite Chen
-----------	--------------	---------	-----------

TEST RESULTS

Test Mode:	BT GFSK	Channel:	2402
Line:	Line		

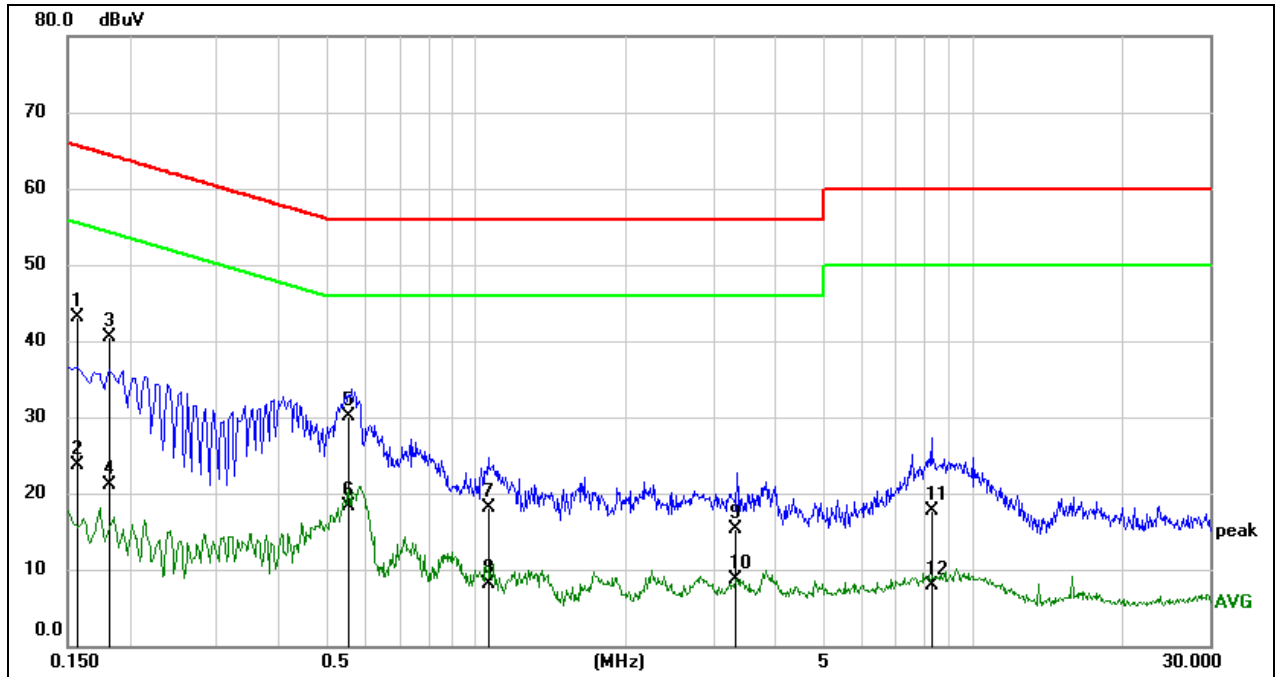

No.	Frequency (MHz)	Reading (dBuV)	Correct (dB)	Result (dBuV)	Limit (dBuV)	Margin (dB)	Remark
1	0.1563	33.45	9.59	43.04	65.66	-22.62	QP
2	0.1563	14.19	9.59	23.78	55.66	-31.88	AVG
3	0.1829	30.87	9.59	40.46	64.35	-23.89	QP
4	0.1829	11.45	9.59	21.04	54.35	-33.31	AVG
5	0.5574	20.50	9.60	30.10	56.00	-25.90	QP
6	0.5574	8.62	9.60	18.22	46.00	-27.78	AVG
7	1.0623	8.55	9.61	18.16	56.00	-37.84	QP
8	1.0623	-1.43	9.61	8.18	46.00	-37.82	AVG
9	3.3287	5.59	9.68	15.27	56.00	-40.73	QP
10	3.3287	-0.95	9.68	8.73	46.00	-37.27	AVG
11	8.2342	8.06	9.71	17.77	60.00	-42.23	QP
12	8.2342	-1.71	9.71	8.00	50.00	-42.00	AVG

Note:

1. Result = Reading + Correct Factor.
2. If QP Result complies with AV limit, AV Result is deemed to comply with AV limit.
3. Test setup: RBW: 200 Hz (9 kHz ~ 150 kHz), 9 kHz (150 kHz ~ 30 MHz).
4. Step size: 80 Hz (0.009 MHz ~ 0.15 MHz), 4 kHz (0.15 MHz ~ 30 MHz), Scan time: auto.

Note: All the modes have been tested, only the worst data was recorded in the report.

Test Mode:	BT GFSK	Channel:	2402
Line:	Neutral		

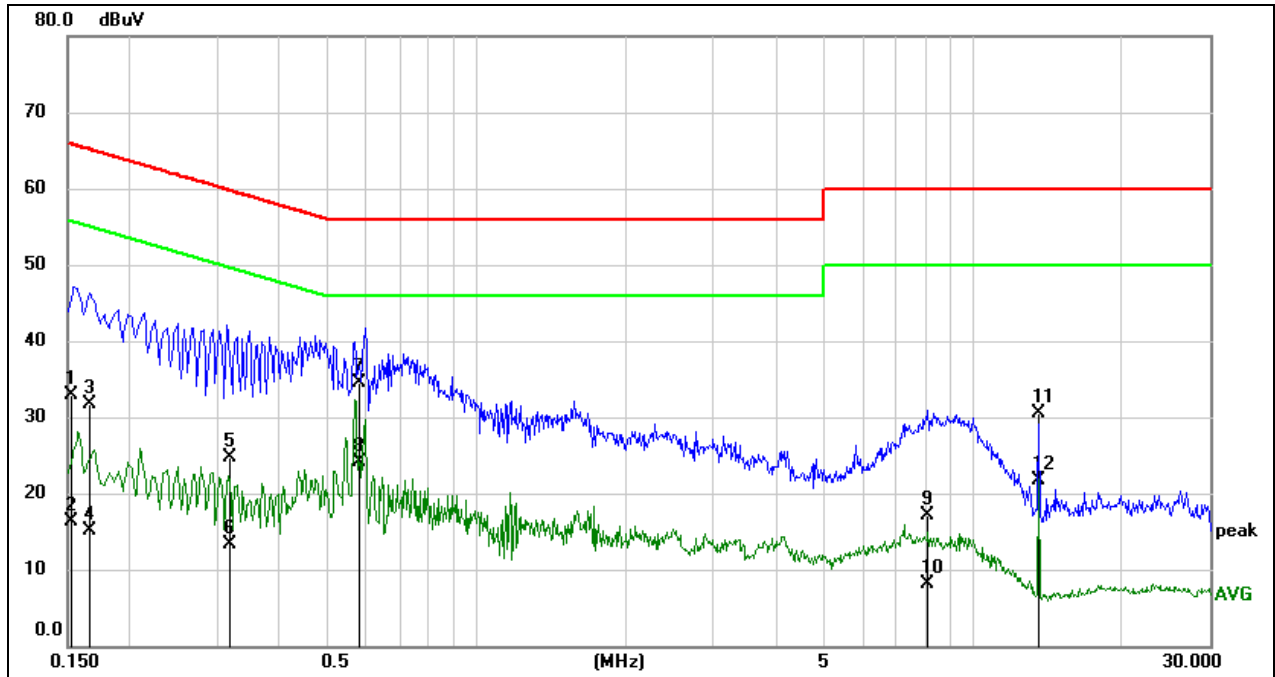

No.	Frequency (MHz)	Reading (dBuV)	Correct (dB)	Result (dBuV)	Limit (dBuV)	Margin (dB)	Remark
1	0.1521	23.42	9.49	32.91	65.88	-32.97	QP
2	0.1521	6.86	9.49	16.35	55.88	-39.53	AVG
3	0.1664	22.18	9.52	31.70	65.14	-33.44	QP
4	0.1664	5.63	9.52	15.15	55.14	-39.99	AVG
5	0.3184	15.07	9.55	24.62	59.75	-35.13	QP
6	0.3184	3.80	9.55	13.35	49.75	-36.40	AVG
7	0.5792	24.94	9.50	34.44	56.00	-21.56	QP
8	0.5792	14.69	9.50	24.19	46.00	-21.81	AVG
9	8.0685	7.55	9.61	17.16	60.00	-42.84	QP
10	8.0685	-1.41	9.61	8.20	50.00	-41.80	AVG
11	13.5588	20.76	9.66	30.42	60.00	-29.58	QP
12	13.5588	12.05	9.66	21.71	50.00	-28.29	AVG

Note:

1. Result = Reading + Correct Factor.
2. If QP Result complies with AV limit, AV Result is deemed to comply with AV limit.
3. Test setup: RBW: 200 Hz (9 kHz ~ 150 kHz), 9 kHz (150 kHz ~ 30 MHz).
4. Step size: 80 Hz (0.009 MHz ~ 0.15 MHz), 4 kHz (0.15 MHz ~ 30 MHz), Scan time: auto.

Note: All the modes have been tested, only the worst data was recorded in the report.

11. TEST DATA

11.1. APPENDIX A: 20DB EMISSION BANDWIDTH

11.1.1. Test Result

Test Mode	Antenna	Channel	20db EBW[MHz]	FL[MHz]	FH[MHz]	Verdict
DH5	Ant1	2402	0.94	2401.54	2402.48	PASS
		2441	0.94	2440.54	2441.48	PASS
		2480	0.94	2479.54	2480.48	PASS
3DH5	Ant1	2402	1.28	2401.36	2402.64	PASS
		2441	1.28	2440.36	2441.63	PASS
		2480	1.28	2479.36	2480.63	PASS

11.1.2. Test Graphs

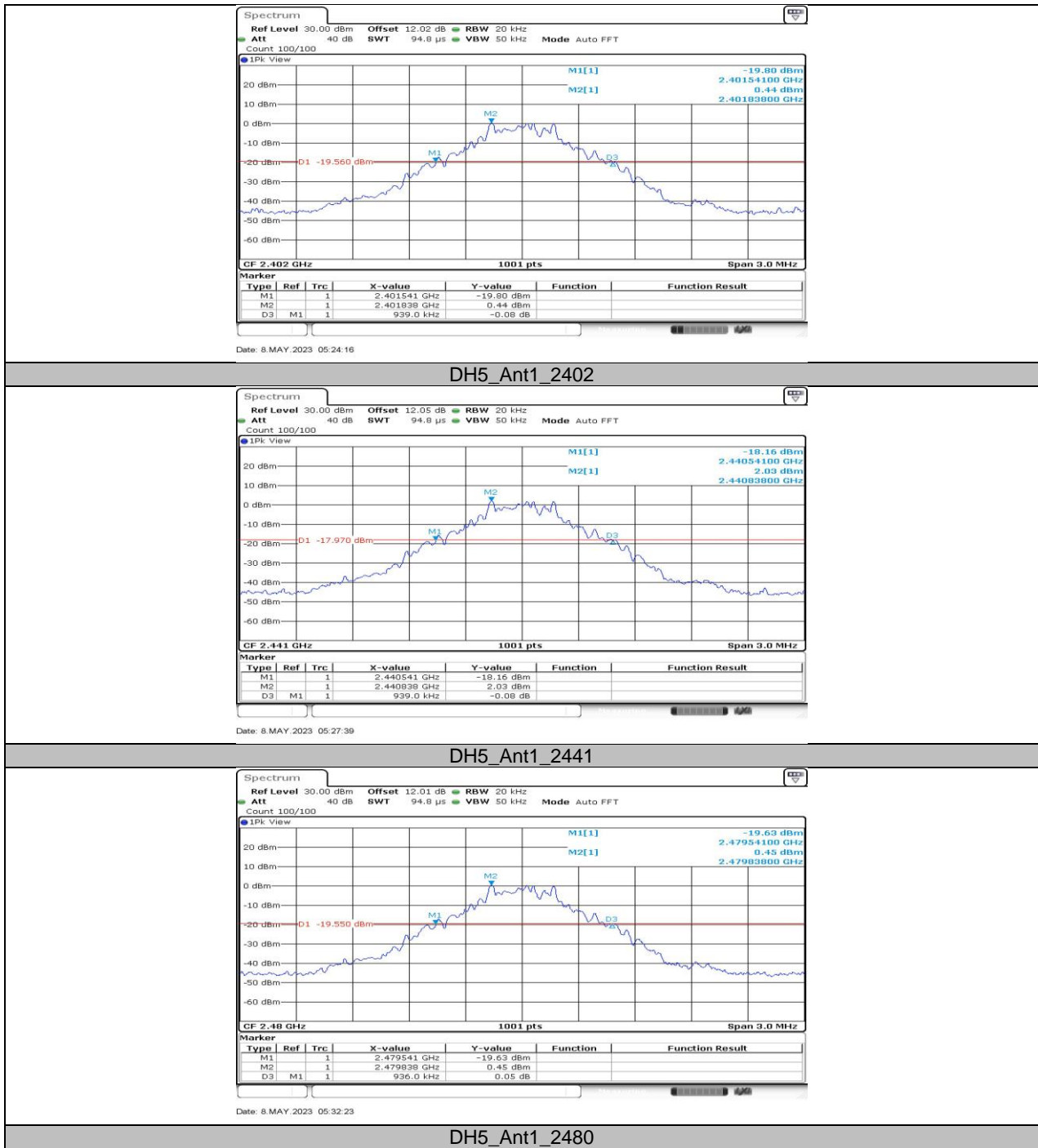

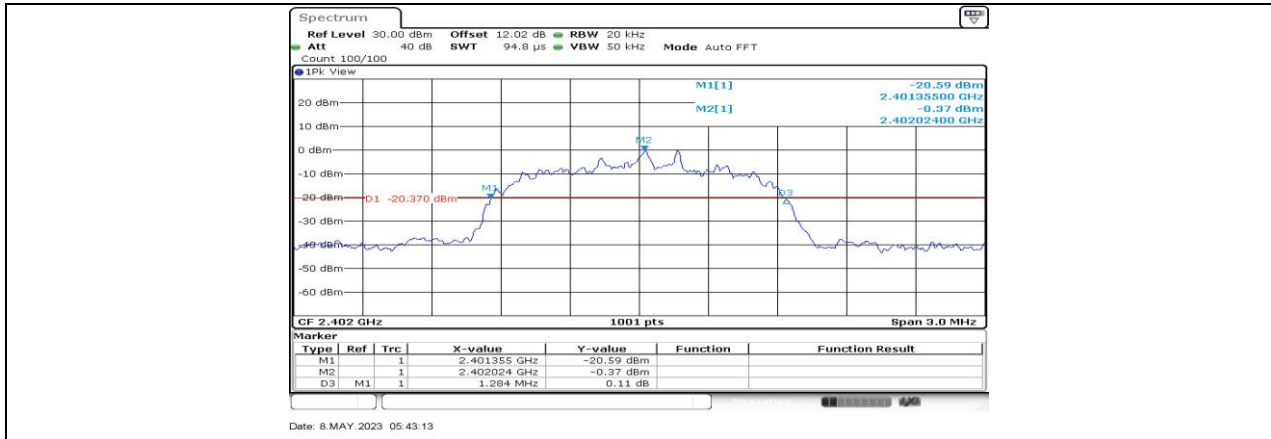

3DH5_Ant1_2402

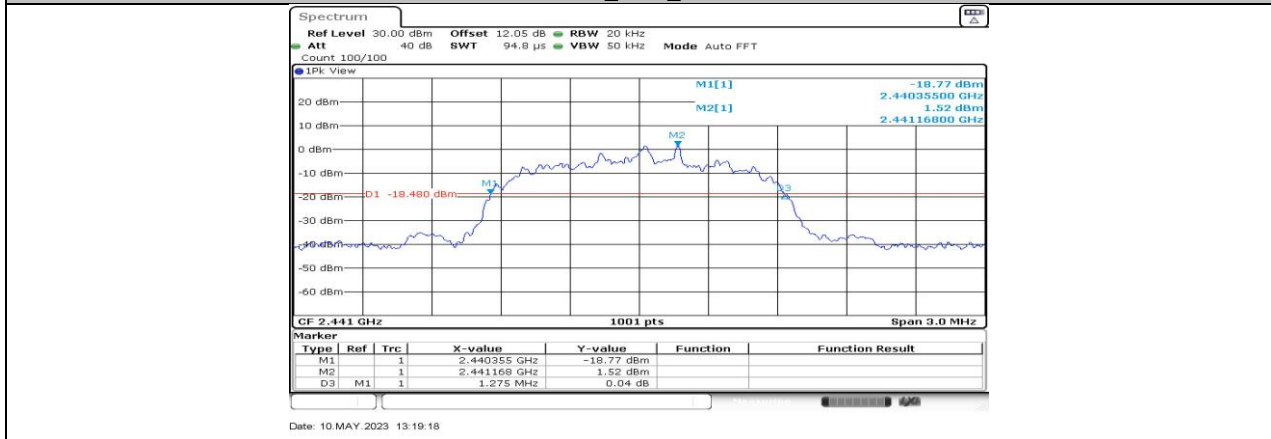

3DH5_Ant1_2441

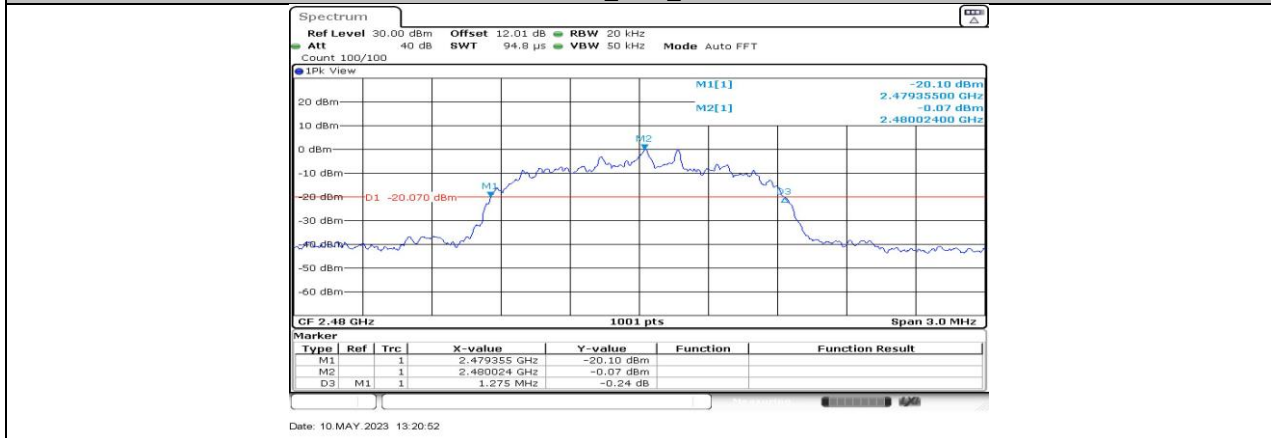

3DH5_Ant1_2480

11.2. APPENDIX B: OCCUPIED CHANNEL BANDWIDTH

11.2.1. Test Result

Test Mode	Antenna	Channel	OCB [MHz]	FL[MHz]	FH[MHz]	Verdict
DH5	Ant1	2402	0.866	2401.5654	2402.4316	PASS
		2441	0.863	2440.5654	2441.4286	PASS
		2480	0.863	2479.5624	2480.4256	PASS
3DH5	Ant1	2402	1.187	2401.4036	2402.5904	PASS
		2441	1.184	2440.4066	2441.5904	PASS
		2480	1.184	2479.4036	2480.5874	PASS

11.2.2. Test Graphs

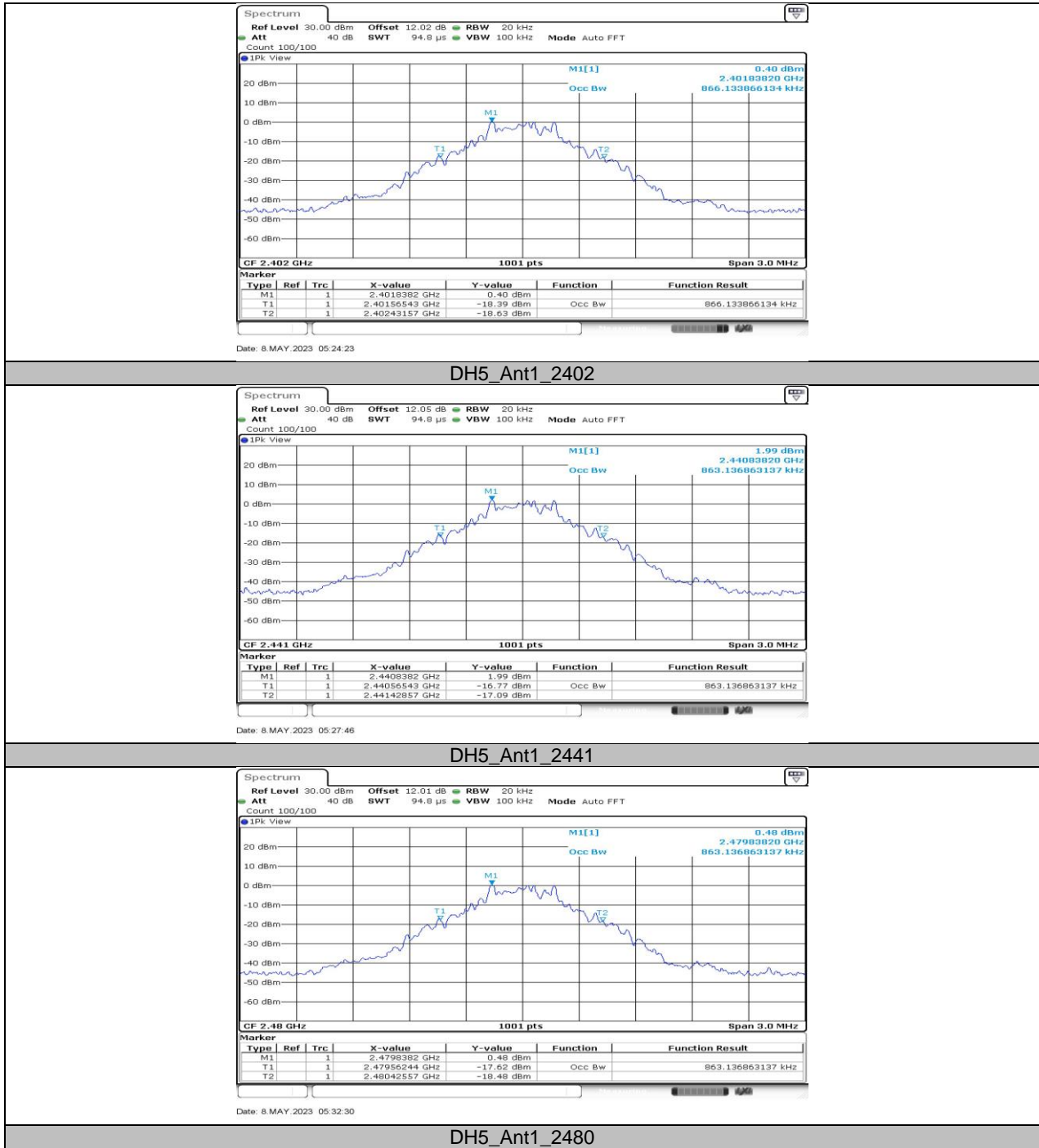

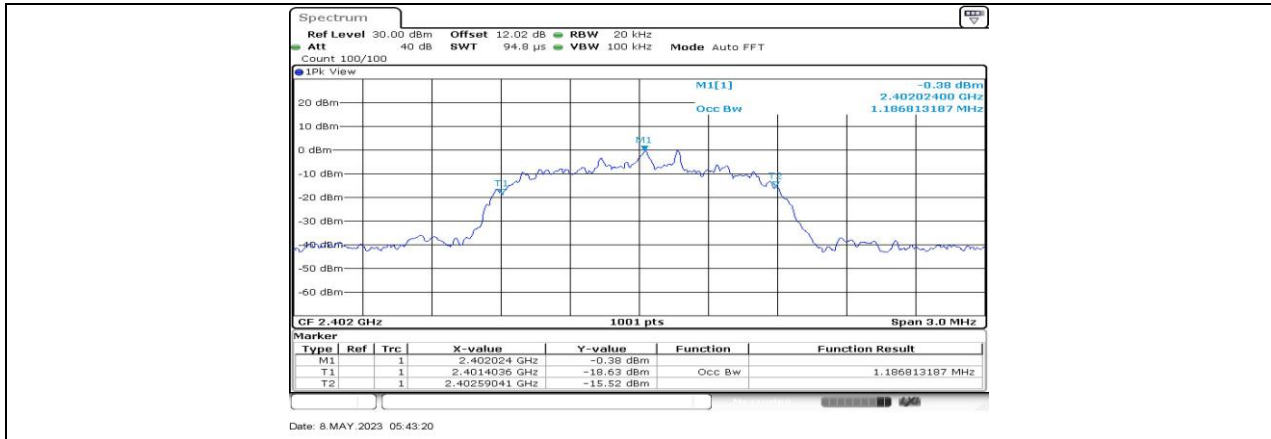

3DH5_Ant1_2402

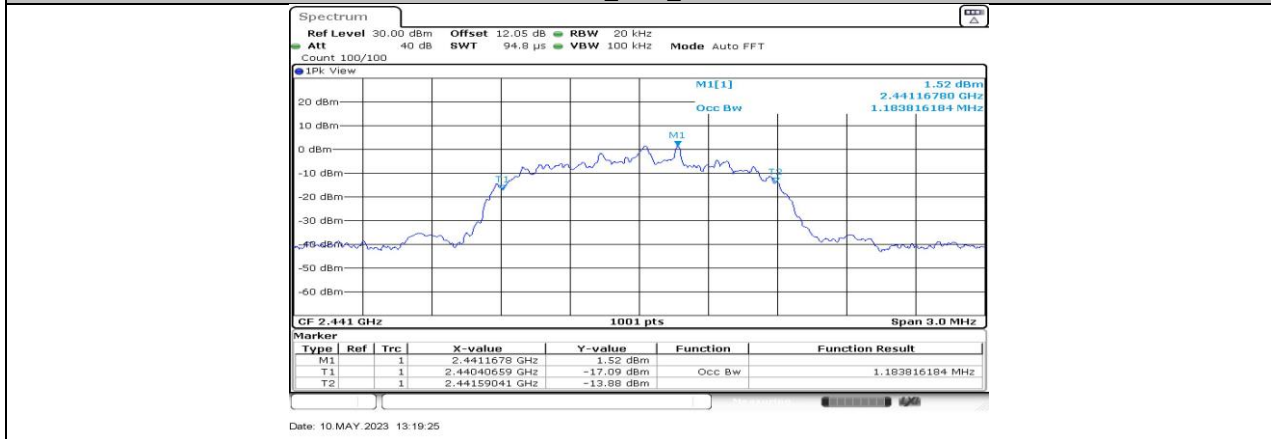

3DH5_Ant1_2441

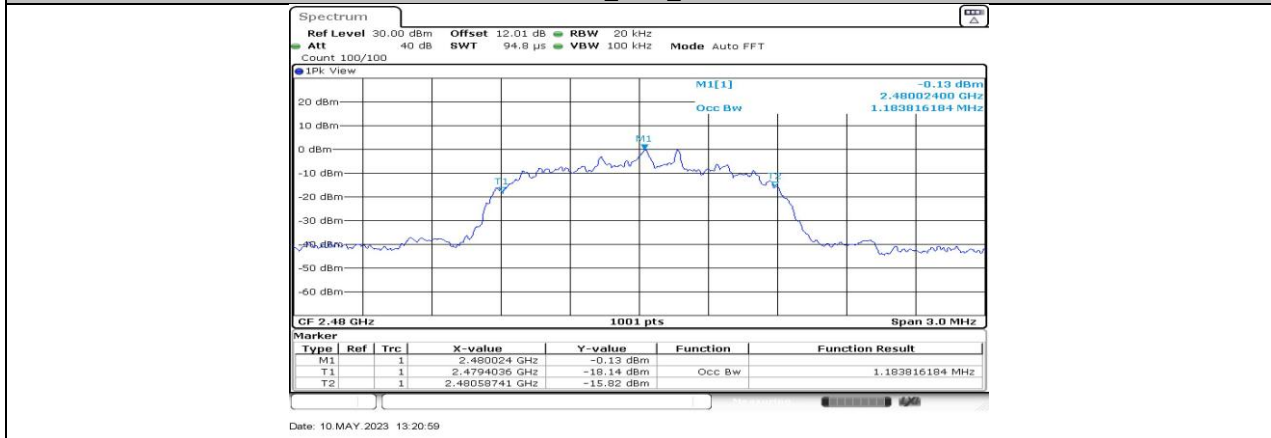

3DH5_Ant1_2480

11.3. APPENDIX C: MAXIMUM CONDUCTED OUTPUT POWER

11.3.1. Test Result

PEAK POWER					
Test Mode	Antenna	Channel	Result[dBm]	Limit[dBm]	Verdict
DH5	Ant1	2402	4.16	≤30	PASS
		2441	5.73	≤30	PASS
		2480	4.17	≤30	PASS
3DH5	Ant1	2402	6.9	≤20.97	PASS
		2441	7.31	≤20.97	PASS
		2480	6.8	≤20.97	PASS

AVG POWER					
Test Mode	Antenna	Channel	Result[dBm]	Limit[dBm]	Verdict
DH5	Ant1	2402	3.56	None; for reporting purposes only.	
		2441	4.17		
		2480	3.25		
3DH5	Ant1	2402	2.31		
		2441	2.87		
		2480	2.66		

11.4. APPENDIX D: CARRIER FREQUENCY SEPARATION

11.4.1. Test Result

Test Mode	Antenna	Channel	Result[MHz]	Limit[MHz]	Verdict
DH5	Ant1	Hop	1.003	≥ 0.940	PASS
3DH5	Ant1	Hop	1.003	≥ 0.853	PASS

11.4.2. Test Graphs



11.5. APPENDIX E: TIME OF OCCUPANCY

11.5.1. Test Result

FHSS Mode						
TestMode	Antenna	Channel	BurstWidth [ms]	Result[s]	Limit[s]	Verdict
DH1	Ant1	Hop	0.4	0.128	<=0.4	PASS
DH3	Ant1	Hop	1.648	0.264	<=0.4	PASS
DH5	Ant1	Hop	2.888	0.308	<=0.4	PASS
3DH1	Ant1	Hop	0.39	0.125	<=0.4	PASS
3DH3	Ant1	Hop	1.633	0.261	<=0.4	PASS
3DH5	Ant1	Hop	2.877	0.307	<=0.4	PASS

AFHSS Mode						
TestMode	Antenna	Channel	BurstWidth [ms]	Result[s]	Limit[s]	Verdict
DH1	Ant1	Hop	0.4	0.064	<=0.4	PASS
DH3	Ant1	Hop	1.648	0.132	<=0.4	PASS
DH5	Ant1	Hop	2.888	0.154	<=0.4	PASS
3DH1	Ant1	Hop	0.39	0.062	<=0.4	PASS
3DH3	Ant1	Hop	1.633	0.131	<=0.4	PASS
3DH5	Ant1	Hop	2.877	0.153	<=0.4	PASS

11.5.2. Test Graphs

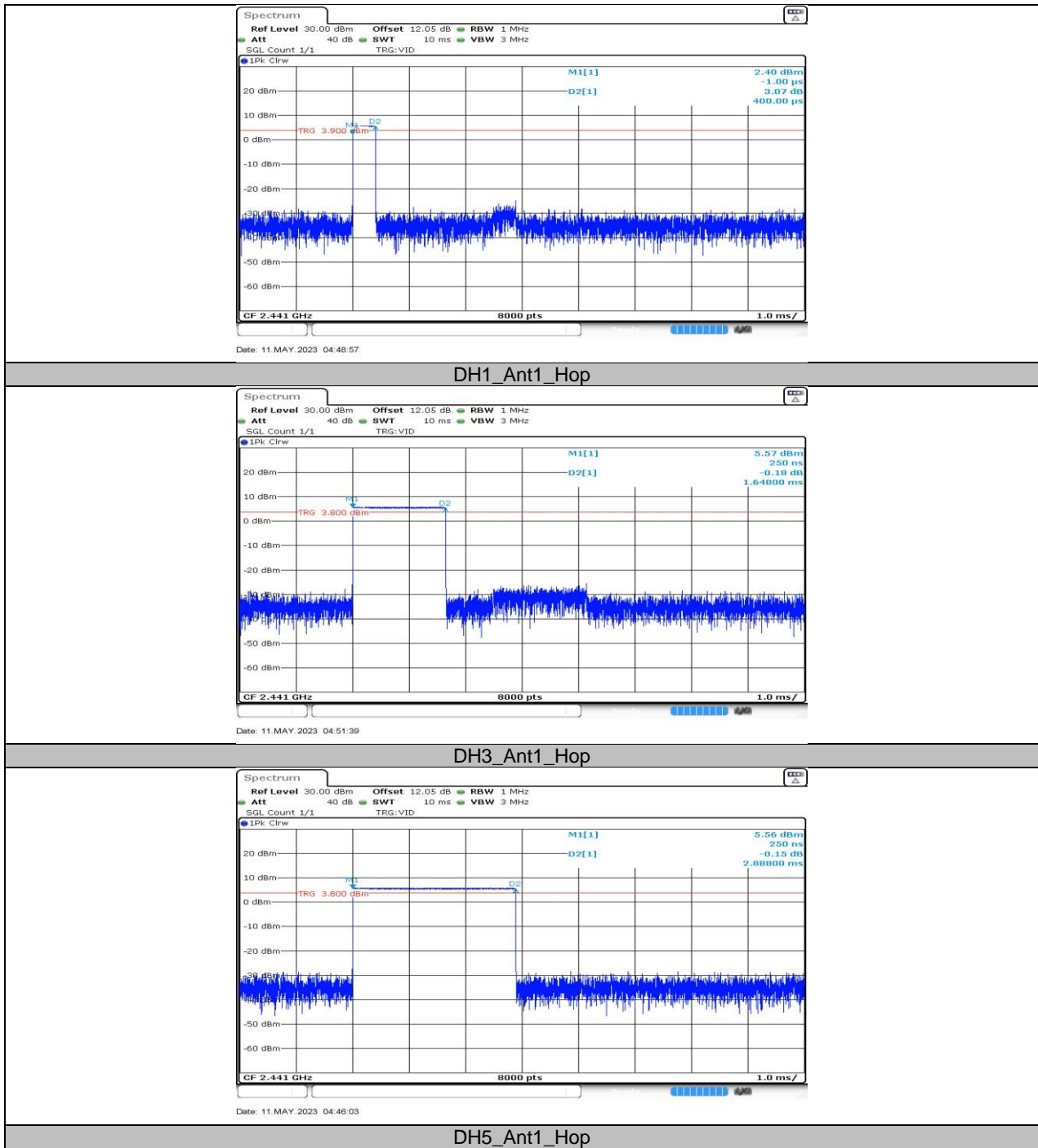

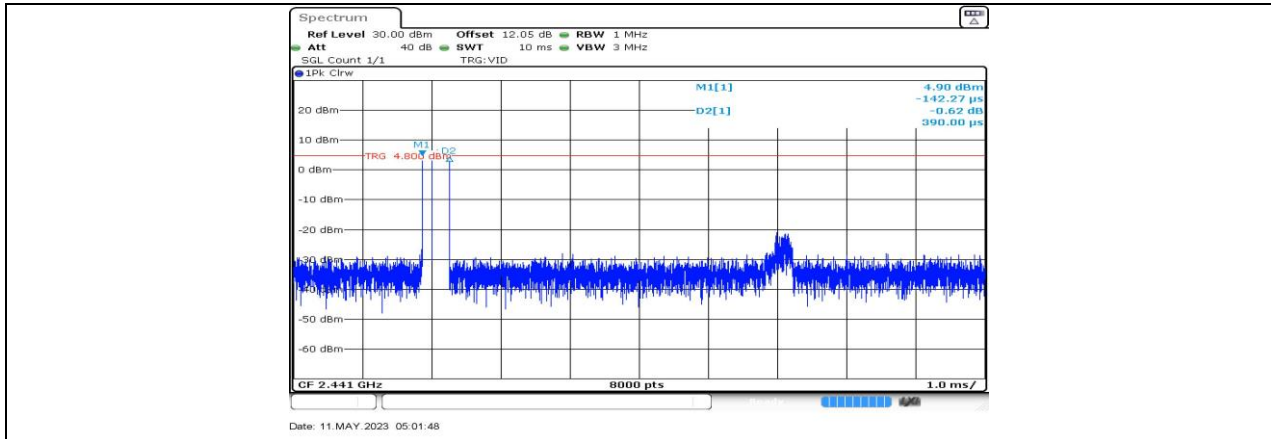

3DH1_Ant1_Hop

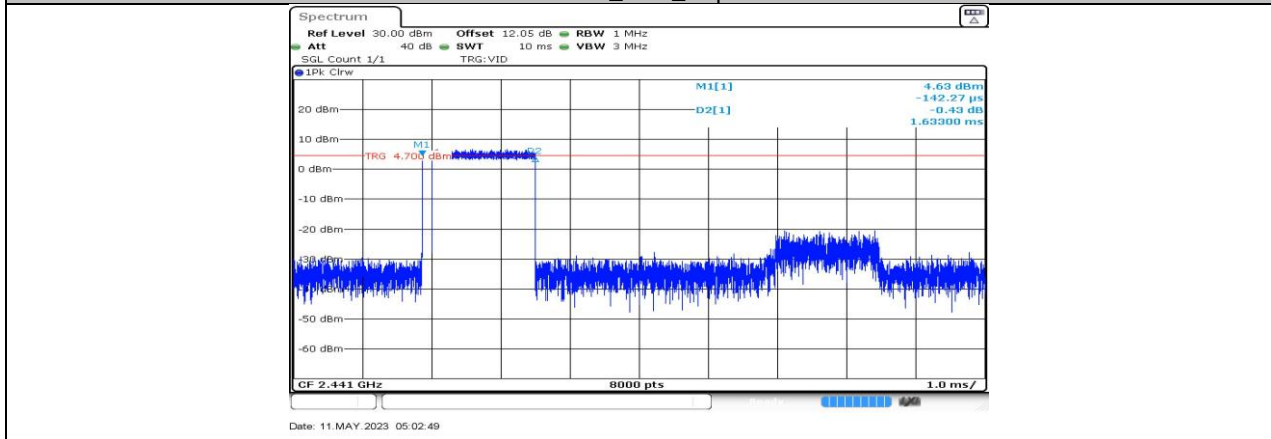

3DH3_Ant1_Hop

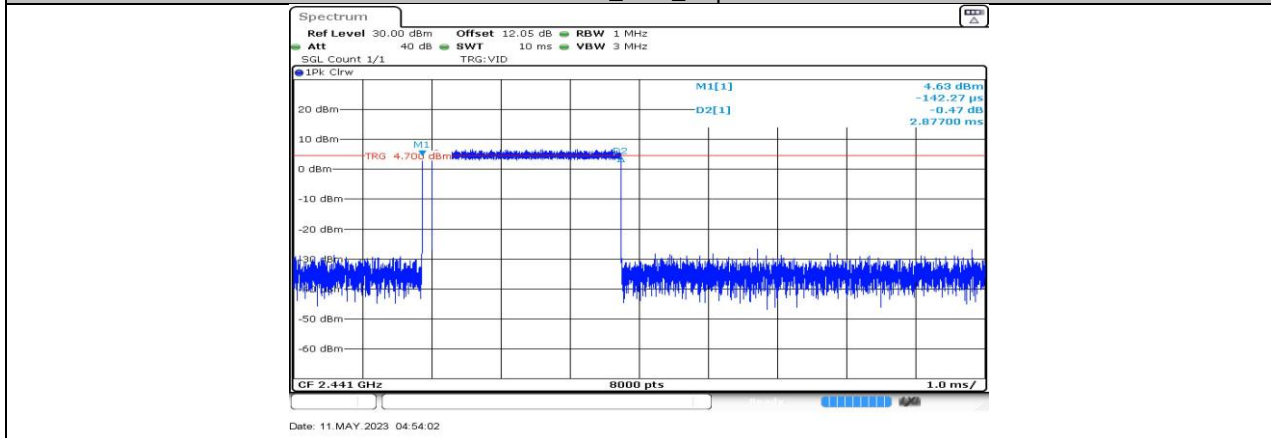

3DH5_Ant1_Hop

11.6. APPENDIX F: NUMBER OF HOPPING CHANNELS

11.6.1. Test Result

Test Mode	Antenna	Channel	Result[Num]	Limit[Num]	Verdict
DH5	Ant1	Hop	79	≥ 15	PASS
3DH5	Ant1	Hop	79	≥ 15	PASS

11.6.2. Test Graphs

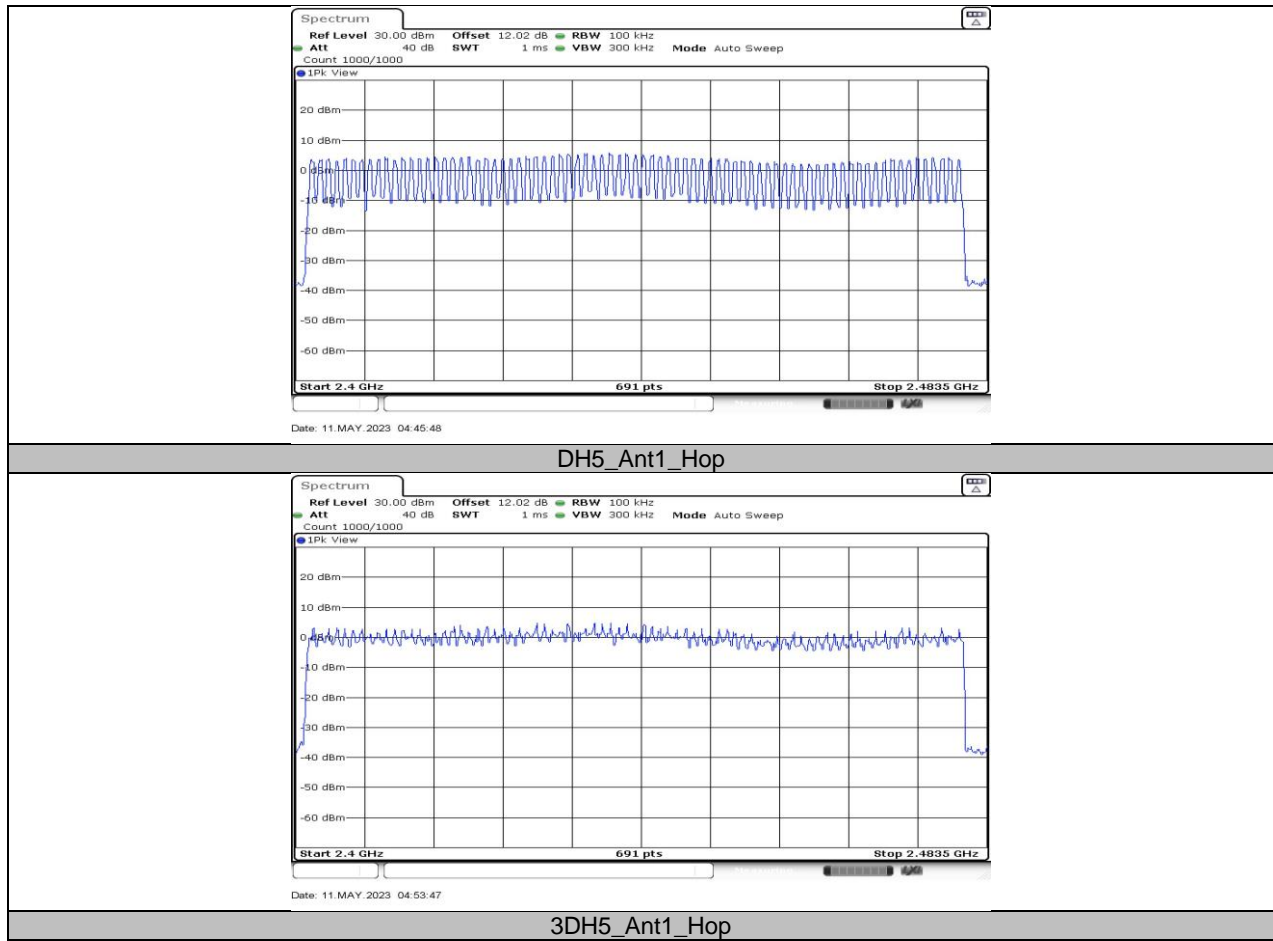

11.7. APPENDIX G: BAND EDGE MEASUREMENTS

11.7.1. Test Result

Test Mode	Antenna	ChName	Channel	RefLevel [dBm]	Result [dBm]	Limit [dBm]	Verdict
DH5	Ant1	Low	2402	3.52	-47.28	≤-16.48	PASS
		High	2480	3.54	-45.73	≤-16.46	PASS
		Low	Hop_2402	3.47	-46.79	≤-16.53	PASS
		High	Hop_2480	4.03	-45.63	≤-15.97	PASS
3DH5	Ant1	Low	2402	3.02	-44.09	≤-16.98	PASS
		High	2480	3.24	-45.68	≤-16.76	PASS
		Low	Hop_2402	1.01	-47.01	≤-18.99	PASS
		High	Hop_2480	2.98	-45.3	≤-17.02	PASS

11.7.2. Test Graphs



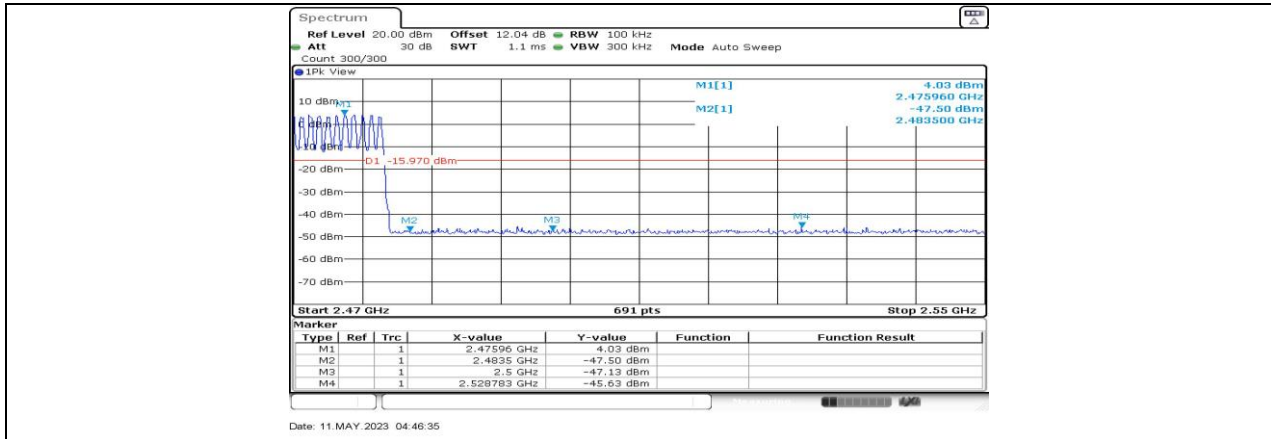

DH5_Ant1_High_Hop_2480

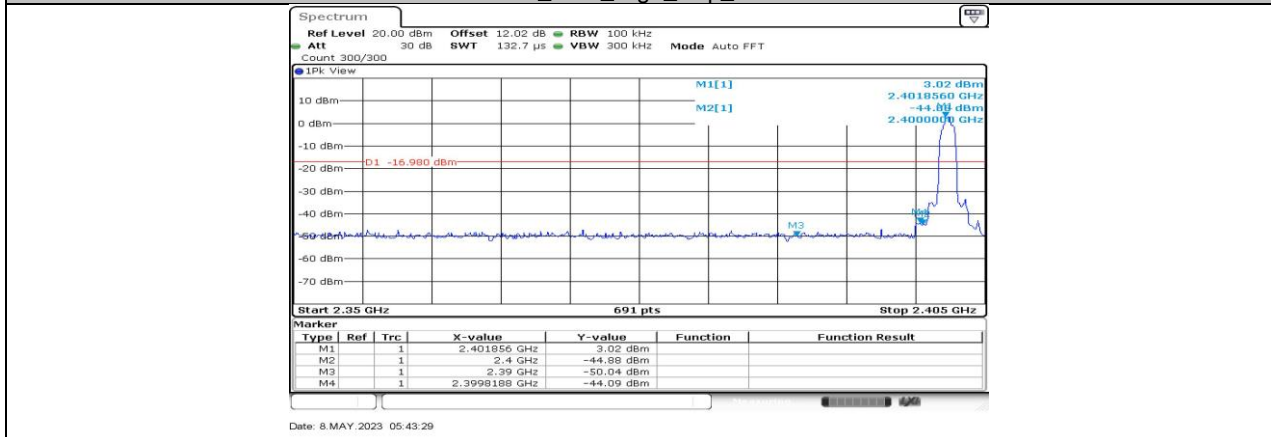

3DH5_Ant1_Low_2402

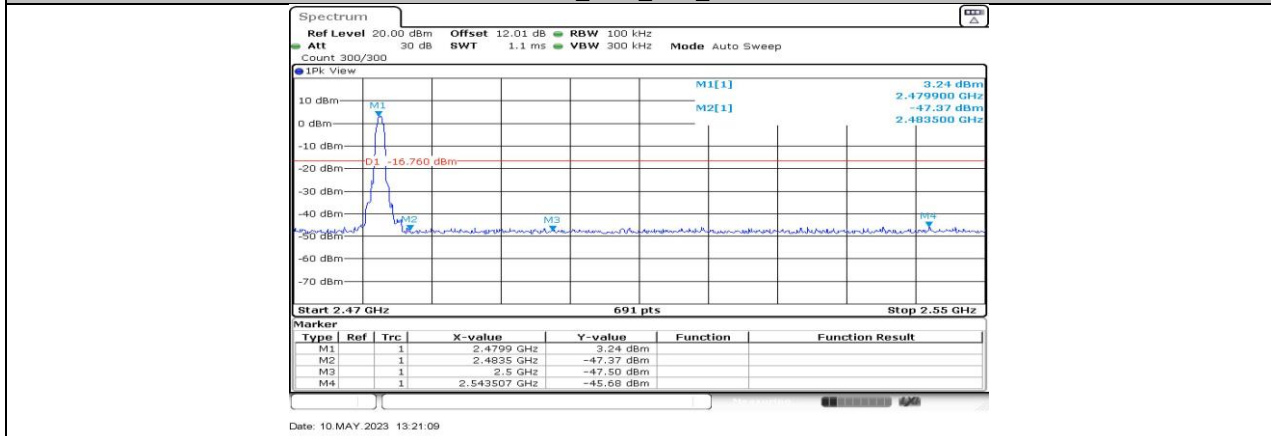

3DH5_Ant1_High_2480

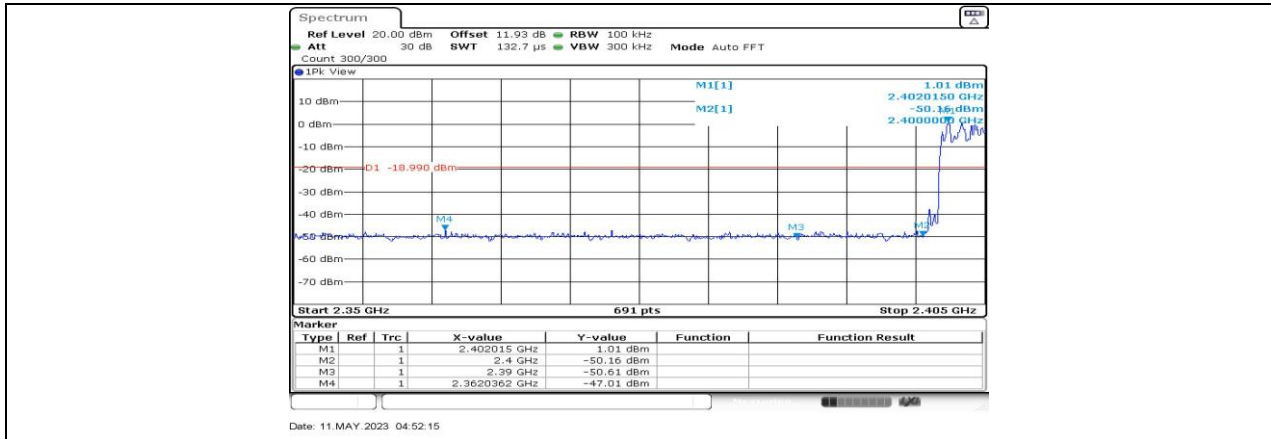

3DH5_Ant1_Low_Hop_2402

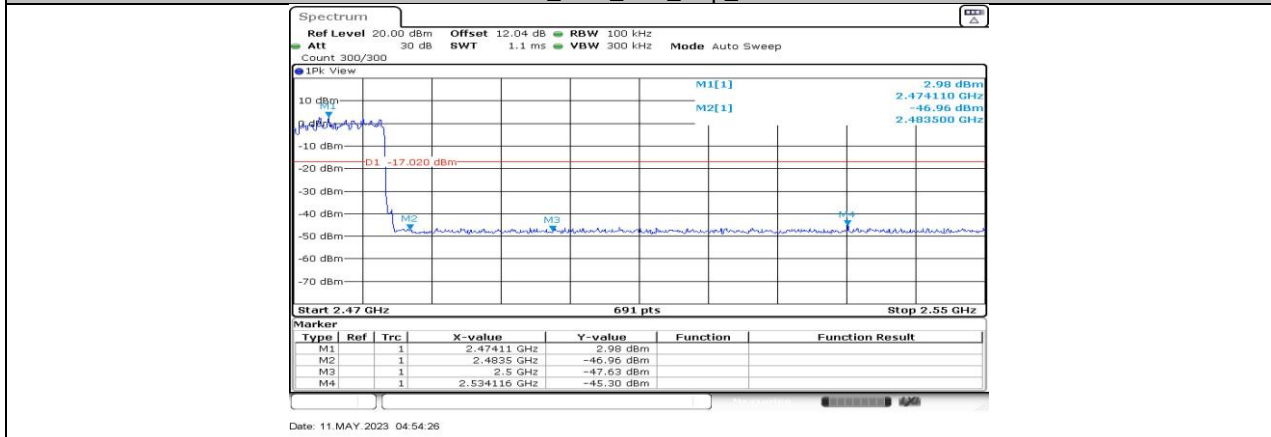

3DH5_Ant1_High_Hop_2480

11.8. APPENDIX H: CONDUCTED SPURIOUS EMISSION

11.8.1. Test Result

Test Mode	Antenna	Channel	FreqRange [MHz]	Result [dBm]	Limit [dBm]	Verdict
DH5	Ant1	2402	Reference	3.58	---	PASS
			30~1000	-55.76	≤-16.42	PASS
			1000~26500	-40.48	≤-16.42	PASS
		2441	Reference	5.18	---	PASS
			30~1000	-55.19	≤-14.82	PASS
			1000~26500	-40.68	≤-14.82	PASS
		2480	Reference	3.55	---	PASS
			30~1000	-55.69	≤-16.45	PASS
			1000~26500	-40.7	≤-16.45	PASS
3DH5	Ant1	2402	Reference	3.04	---	PASS
			30~1000	-55.61	≤-16.96	PASS
			1000~26500	-40.31	≤-16.96	PASS
		2441	Reference	4.83	---	PASS
			30~1000	-55.95	≤-15.17	PASS
			1000~26500	-40.19	≤-15.17	PASS
		2480	Reference	3.26	---	PASS
			30~1000	-55.48	≤-16.74	PASS
			1000~26500	-41	≤-16.74	PASS

11.8.2. Test Graphs

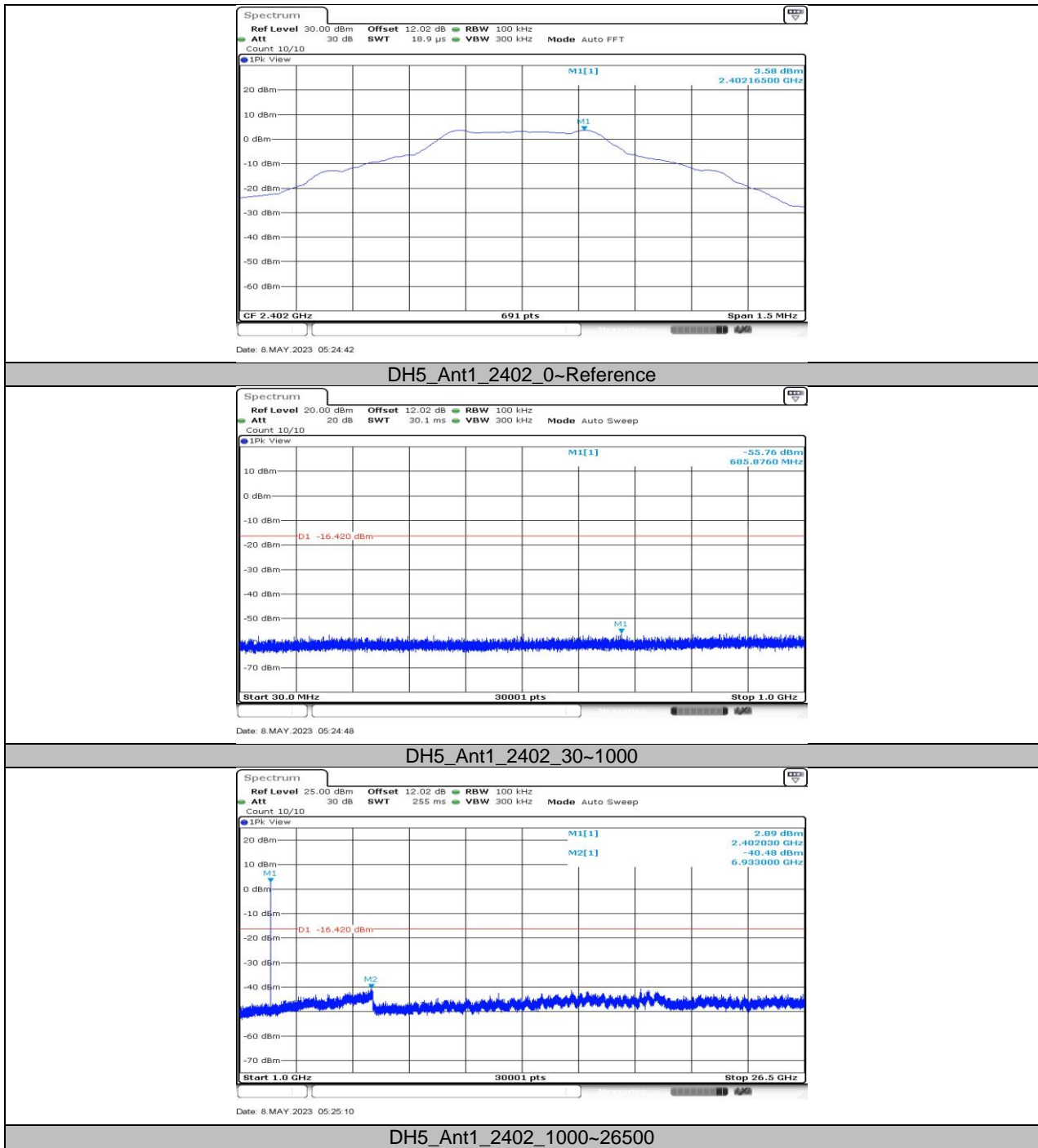



DH5_Ant1_2441_0~Reference

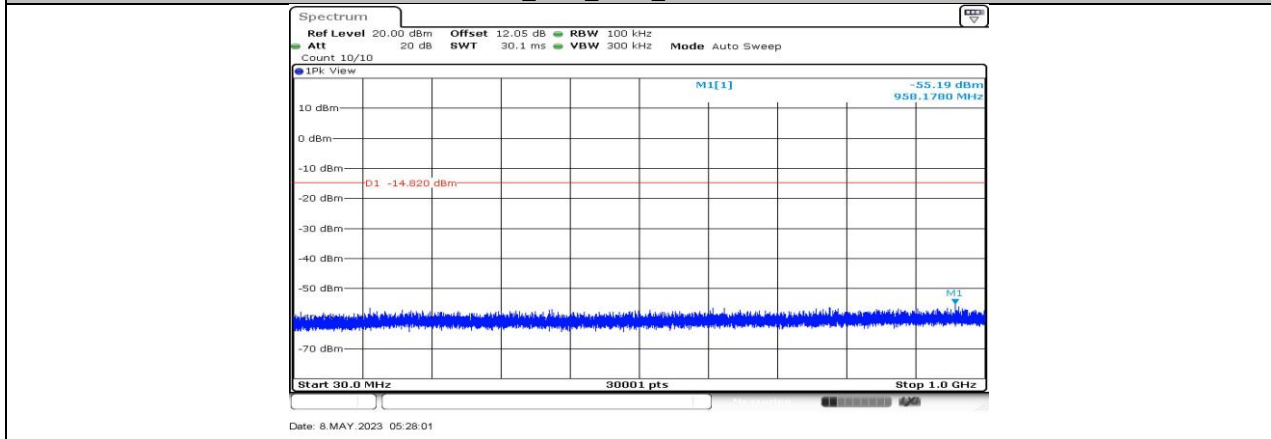

DH5_Ant1_2441_30~1000

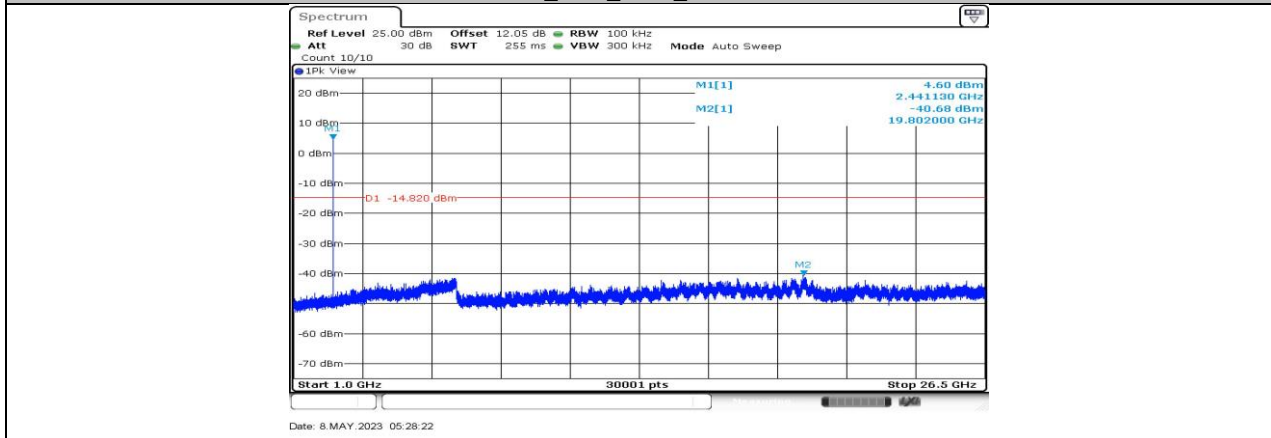

DH5_Ant1_2441_1000~26500

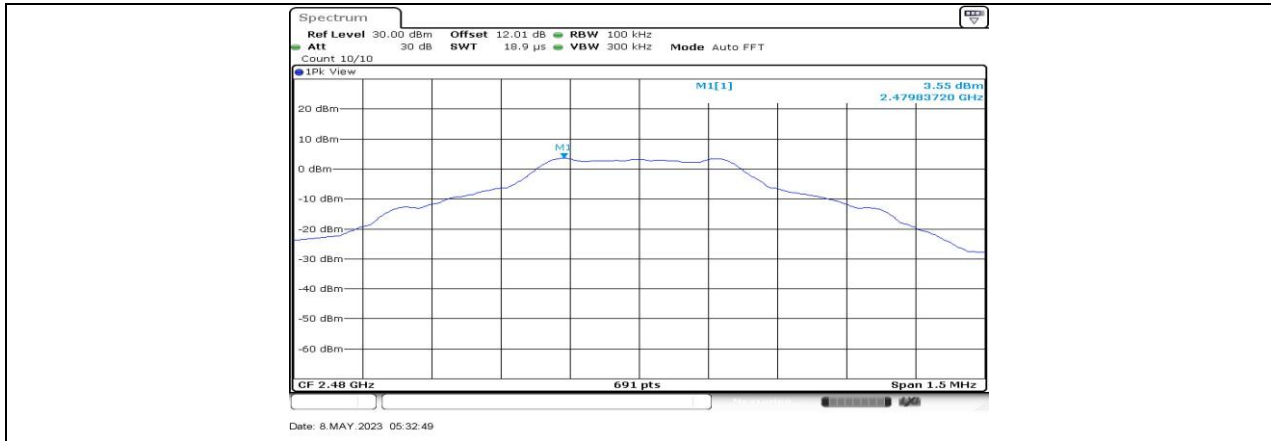

DH5_Ant1_2480_0~Reference

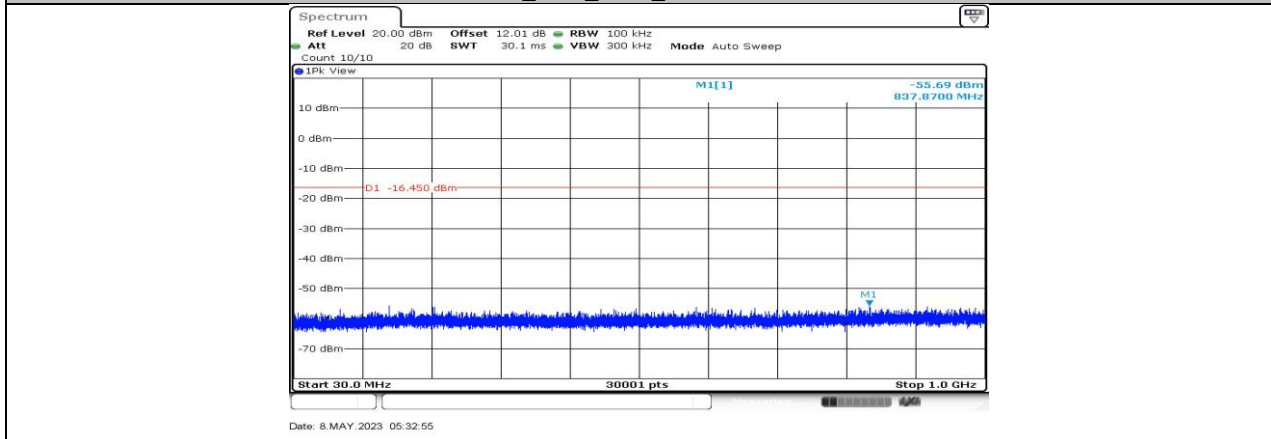

DH5_Ant1_2480_30~1000

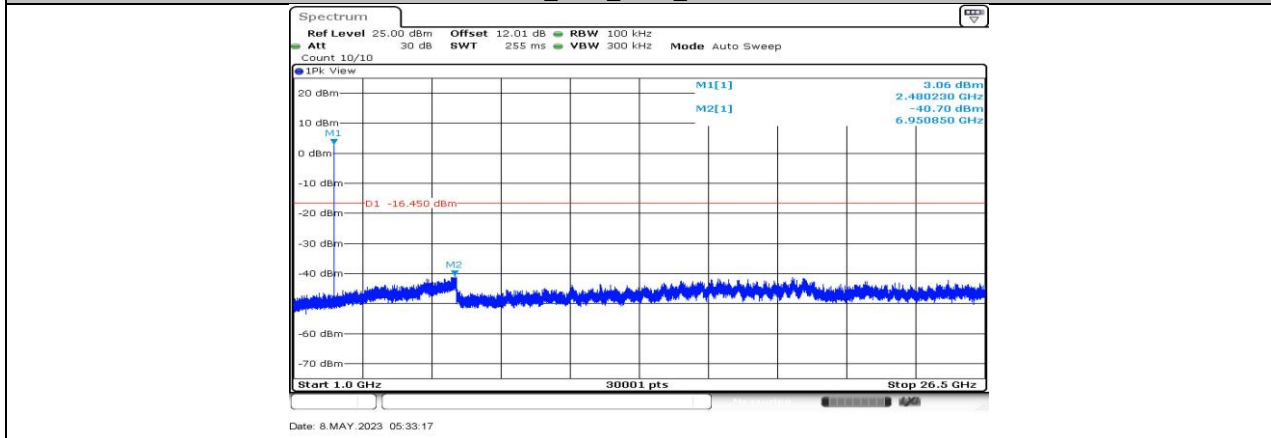

DH5_Ant1_2480_1000~26500

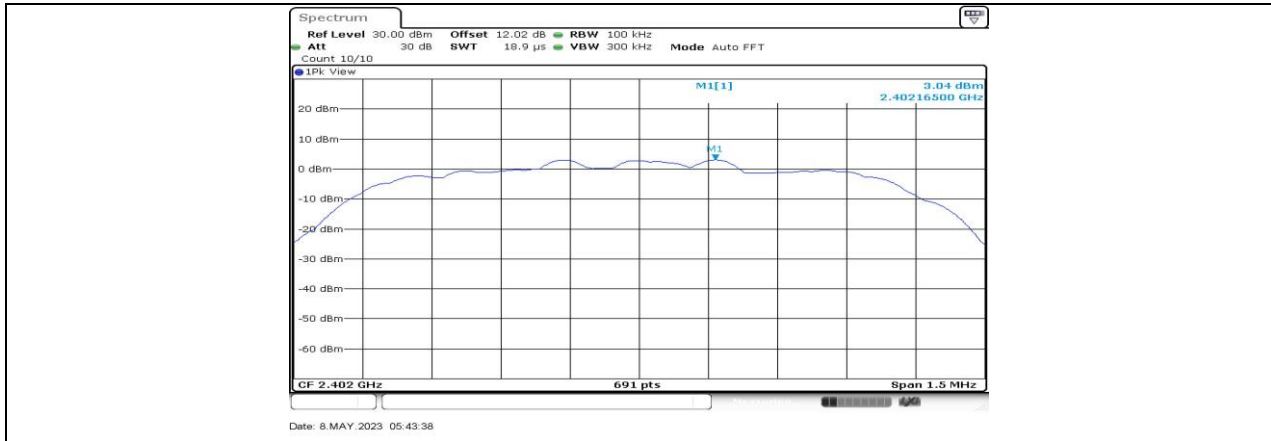

3DH5_Ant1_2402_0~Reference

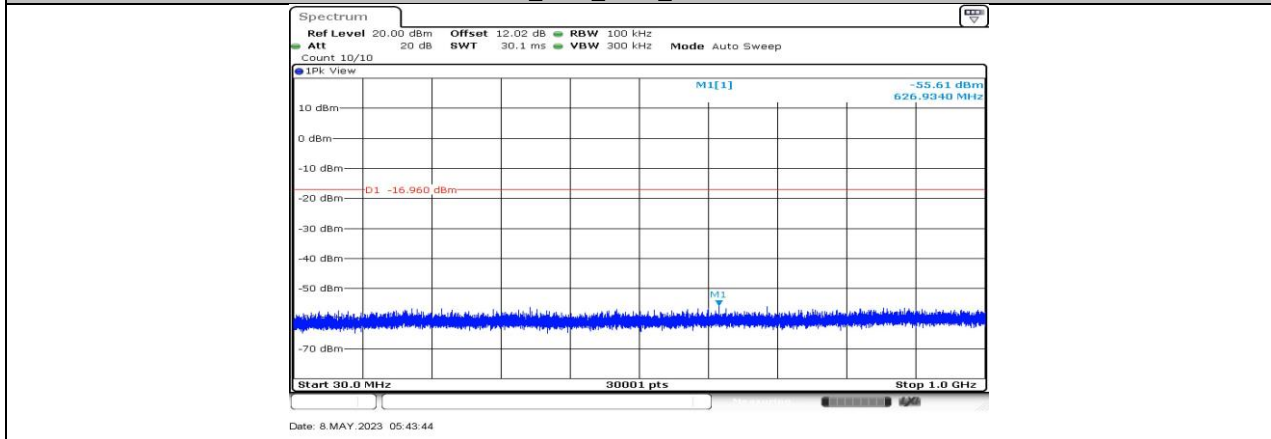

3DH5_Ant1_2402_30~1000

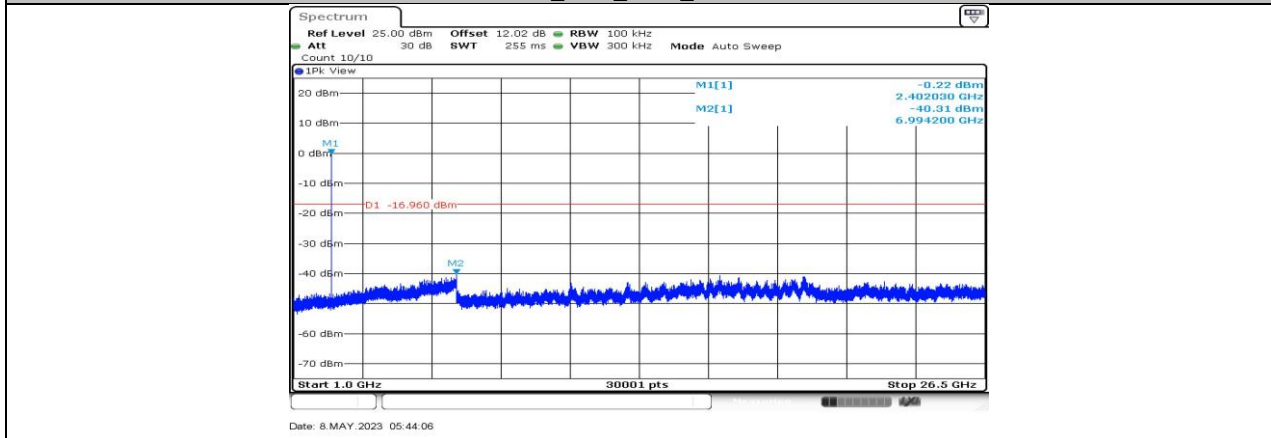

3DH5_Ant1_2402_1000~26500

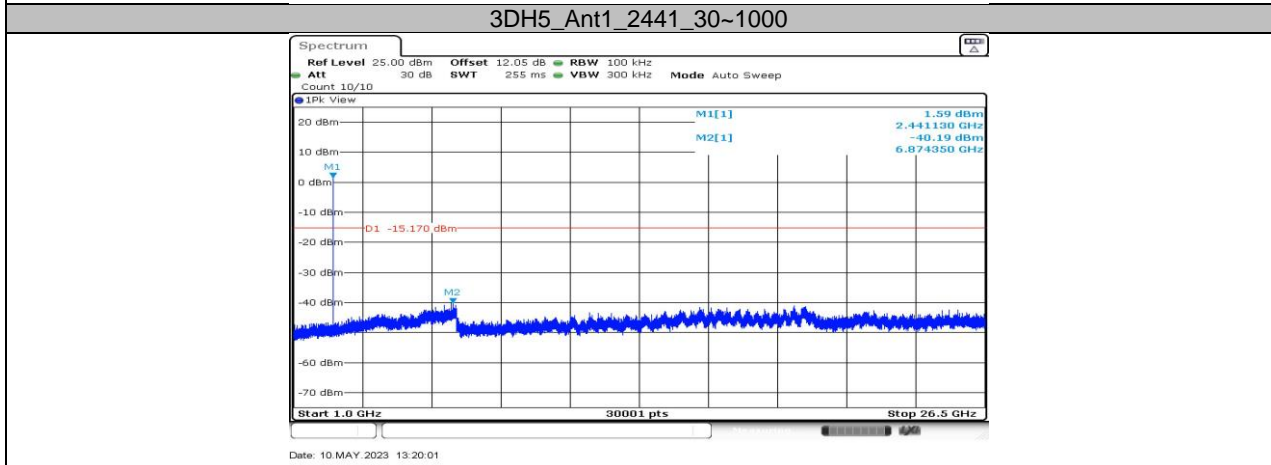
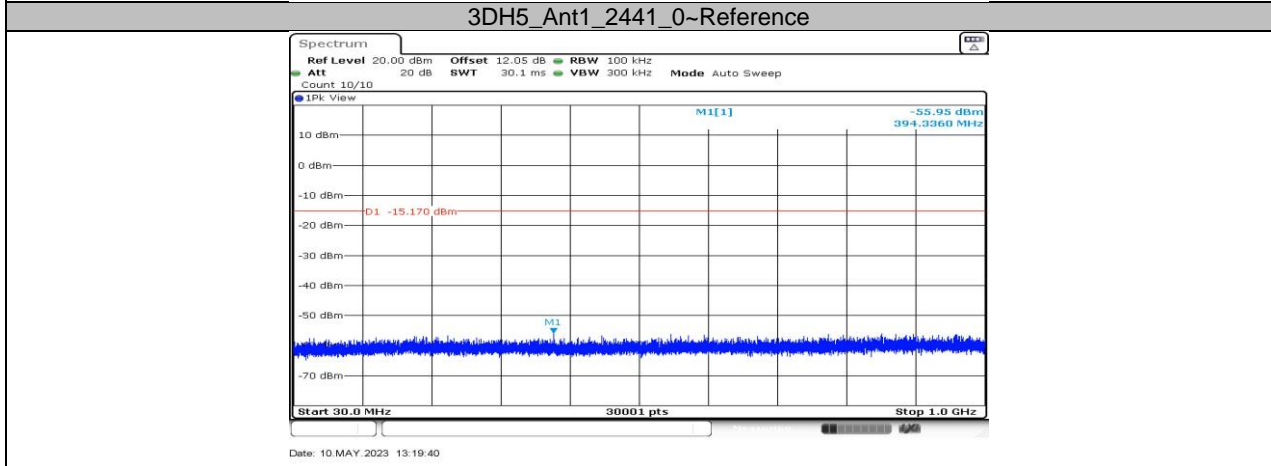
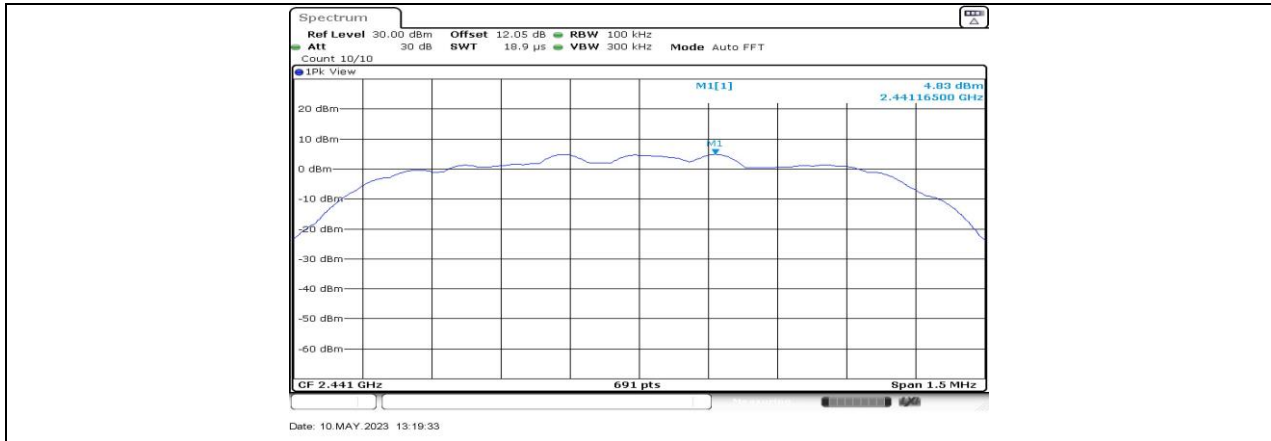

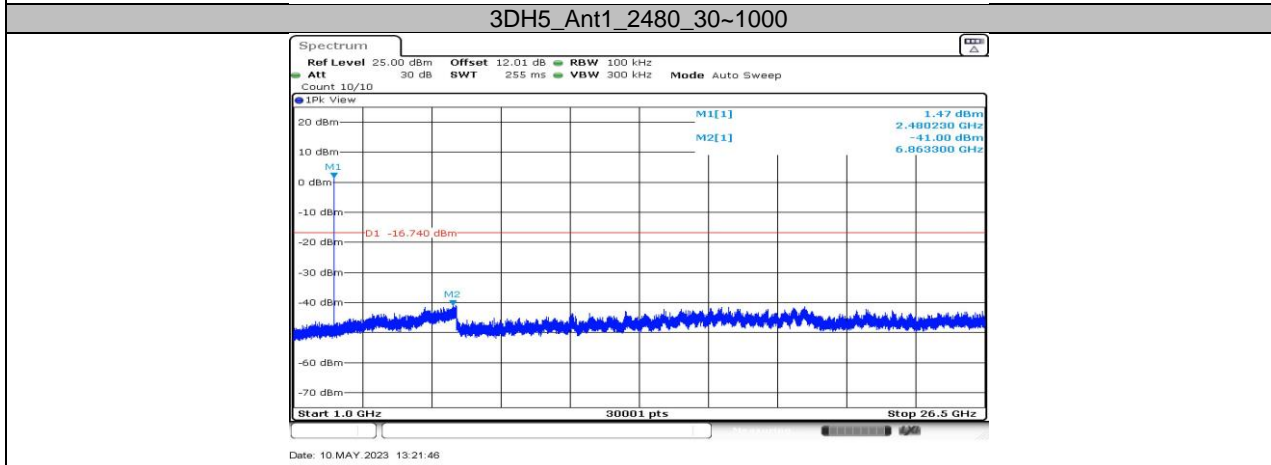
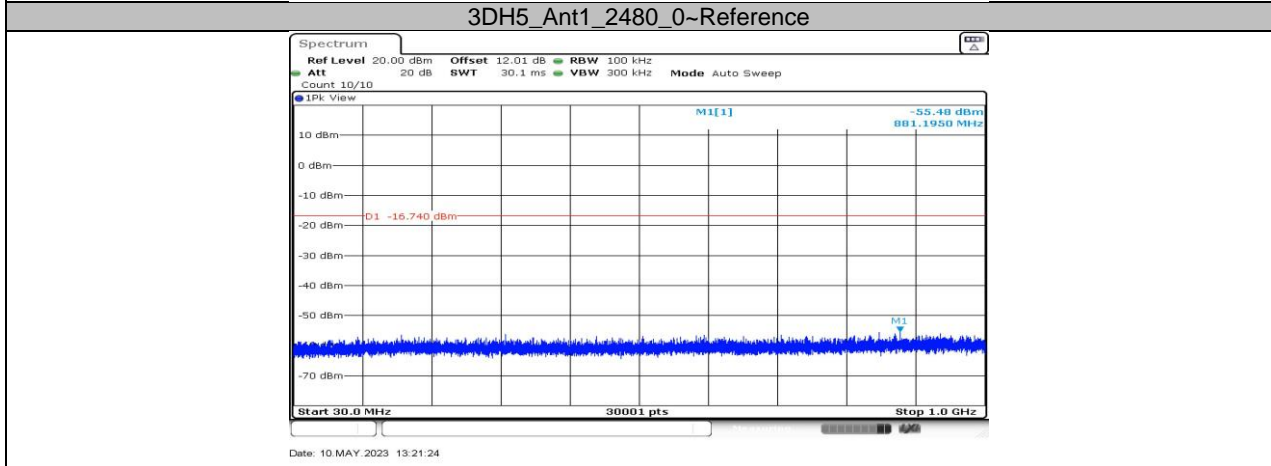
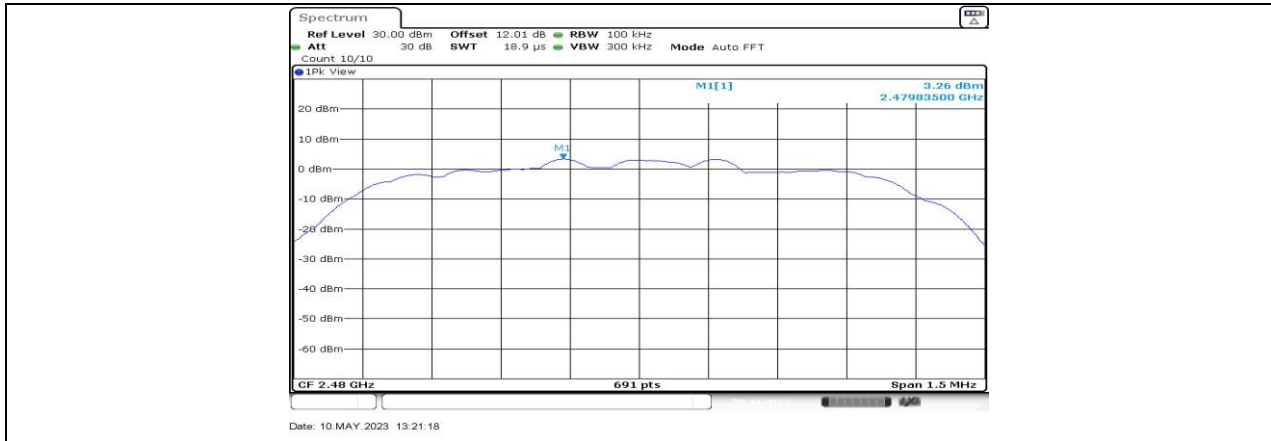

11.9. APPENDIX I: DUTY CYCLE

11.9.1. Test Result

Test Mode	On Time (msec)	Period (msec)	Duty Cycle x (Linear)	Duty Cycle (%)	Duty Cycle Correction Factor (dB)	1/T Minimum VBW (kHz)	Final setting For VBW (kHz)
DH5	2.90	3.74	0.7754	77.54	1.10	0.34	0.5
3DH5	2.89	3.73	0.7748	77.48	1.11	0.35	0.5

Note:

Duty Cycle Correction Factor=10log (1/x).

Where: x is Duty Cycle (Linear)

Where: T is On Time

If that calculated VBW is not available on the analyzer then the next higher value should be used.

11.9.2. Test Graphs

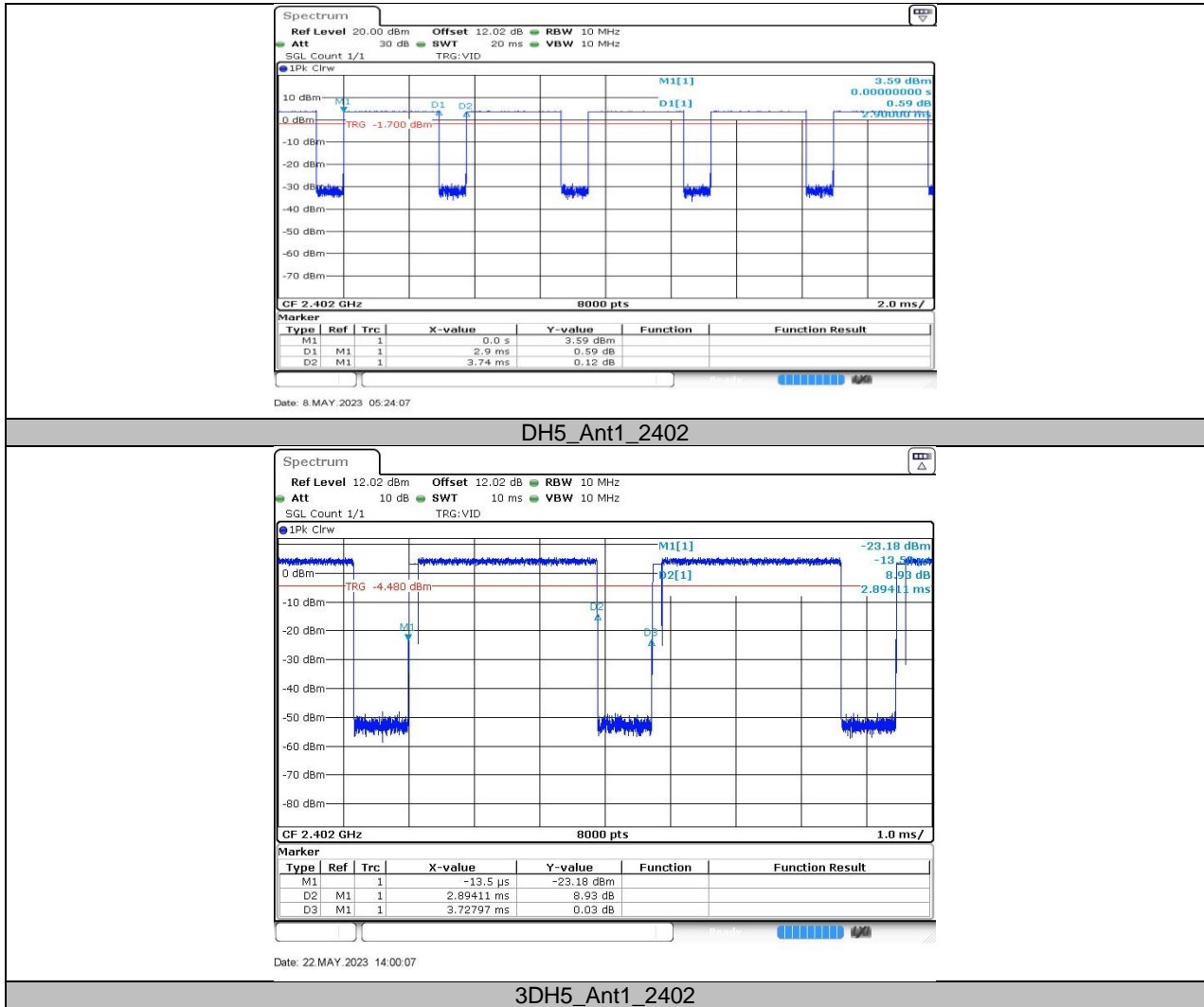

END OF REPORT