



**CFR 47 FCC PART 15 SUBPART C  
ISED RSS-247 ISSUE 2**

**CERTIFICATION TEST REPORT**

*For*

**Smart Mini Payment Terminal**

**MODEL NUMBER: A77**

**FCC ID: V5PA77GT**

**IC: 11689A-A77GT**

**REPORT NUMBER: 4790087823-4**

**ISSUE DATE: April 21, 2022**

*Prepared for*

**PAX Technology Limited  
Room 2416, 24/F., Sun Hung Kai Centre, 30 Harbour Road, Wanchai, Hong Kong**

*Prepared by*

**UL Verification Services (Guangzhou) Co., Ltd, Song Shan Lake Branch  
Building 10, Innovation Technology Park, No. 1, Li Bin Road, Song Shan Lake Hi-Tech Development Zone Dongguan, 523808, People's Republic of China**

**Tel: +86 769 22038881**

**Fax: +86 769 33244054**

**Website: [www.ul.com](http://www.ul.com)**



Revision History

<u>Rev.</u>	<u>Issue Date</u>	<u>Revisions</u>	<u>Revised By</u>
V0	4/21/2022	Initial Issue	



Summary of Test Results			
CI ause	Test Items	FCC/ISED Rules	Test Results
1	6dB Bandwidth and 99% Occupied Bandwidth	FCC Part 15.247 (a) (2) RSS-247 Clause 5.2 (a) ISED RSS-Gen Clause 6.7	Pass
2	Conducted Output Power	FCC Part 15.247 (b) (3) RSS-247 Clause 5.4 (d)	Pass
3	Power Spectral Density	FCC Part 15.247 (e) RSS-247 Clause 5.2 (b)	Pass
4	Conducted Bandedge and Spurious Emission	FCC Part 15.247 (d) RSS-247 Clause 5.5	Pass
5	Radiated Bandedge and Spurious Emission	FCC Part 15.247 (d) FCC Part 15.209 FCC Part 15.205 RSS-247 Clause 5.5 RSS-GEN Clause 8.9	Pass
6	Conducted Emission Test for AC Power Port	FCC Part 15.207 RSS-GEN Clause 8.8	Pass
7	Antenna Requirement	FCC Part 15.203 RSS-GEN Clause 6.8	Pass

Note:

1. This test report is only published to and used by the applicant, and it is not for evidence purpose in China.
2. The measurement result for the sample received is <Pass> according to < CFR 47 FCC PART 15 SUBPART C >< ISED RSS-247 > when <Accuracy Method> decision rule is applied.



## TABLE OF CONTENTS

<b>1. ATTESTATION OF TEST RESULTS .....</b>	<b>6</b>
<b>2. TEST METHODOLOGY .....</b>	<b>7</b>
<b>3. FACILITIES AND ACCREDITATION .....</b>	<b>7</b>
<b>4. CALIBRATION AND UNCERTAINTY .....</b>	<b>8</b>
4.1. <i>MEASURING INSTRUMENT CALIBRATION .....</i>	<i>8</i>
4.2. <i>MEASUREMENT UNCERTAINTY.....</i>	<i>8</i>
<b>5. EQUIPMENT UNDER TEST .....</b>	<b>9</b>
5.1. <i>DESCRIPTION OF EUT .....</i>	<i>9</i>
5.2. <i>CHANNEL LIST.....</i>	<i>9</i>
5.3. <i>MAXIMUM OUTPUT POWER.....</i>	<i>10</i>
5.4. <i>TEST CHANNEL CONFIGURATION.....</i>	<i>10</i>
5.5. <i>THE WORSE CASE POWER SETTING PARAMETER.....</i>	<i>10</i>
5.6. <i>THE WORSE CASE CONFIGURATIONS .....</i>	<i>11</i>
5.7. <i>DESCRIPTION OF AVAILABLE ANTENNAS .....</i>	<i>12</i>
5.8. <i>DESCRIPTION OF TEST SETUP.....</i>	<i>13</i>
<b>6. MEASURING INSTRUMENT AND SOFTWARE USED .....</b>	<b>14</b>
<b>7. ANTENNA PORT TEST RESULTS .....</b>	<b>16</b>
7.1. <i>ON TIME AND DUTY CYCLE.....</i>	<i>16</i>
7.2. <i>6 dB DTS BANDWIDTH AND 99 % OCCUPIED BANDWIDTH .....</i>	<i>17</i>
7.3. <i>CONDUCTED OUTPUT POWER.....</i>	<i>19</i>
7.4. <i>POWER SPECTRAL DENSITY .....</i>	<i>21</i>
7.5. <i>CONDUCTED BANDEDGE AND SPURIOUS EMISSIONS.....</i>	<i>23</i>
<b>8. RADIATED TEST RESULTS.....</b>	<b>25</b>
8.1. <i>RESTRICTED BANDEDGE .....</i>	<i>31</i>
8.1.1. <i>802.11b MODE .....</i>	<i>31</i>
8.1.2. <i>802.11g MODE .....</i>	<i>34</i>
8.1.3. <i>802.11n HT20 MODE .....</i>	<i>38</i>
8.1.4. <i>802.11n HT40 MODE .....</i>	<i>42</i>
8.2. <i>SPURIOUS EMISSIONS (1 GHz ~ 3 GHz).....</i>	<i>46</i>
8.2.1. <i>802.11b MODE .....</i>	<i>46</i>
8.3. <i>SPURIOUS EMISSIONS (3 GHz ~ 18 GHz).....</i>	<i>52</i>
8.3.1. <i>802.11b MODE .....</i>	<i>52</i>
8.3.2. <i>802.11g MODE .....</i>	<i>58</i>
8.3.3. <i>802.11n HT20 MODE .....</i>	<i>64</i>
8.3.4. <i>802.11n HT40 MODE .....</i>	<i>70</i>



8.4. SPURIOUS EMISSIONS (18 GHz ~ 26 GHz) .....76  
8.4.1. 802.11g MODE .....76

8.5. SPURIOUS EMISSIONS (30 MHz ~ 1 GHz).....78  
8.5.1. 802.11g MODE .....78

8.6. SPURIOUS EMISSIONS BELOW 30 MHz .....80  
8.6.1. 802.11g MODE .....80

**9. AC POWER LINE CONDUCTED EMISSIONS .....83**  
9.1. 802.11g MODE .....84

**10. ANTENNA REQUIREMENTS .....86**

**11. Appendix.....87**

11.1. Appendix A: DTS Bandwidth .....87  
11.1.1. Test Result .....87  
11.1.2. Test Graphs .....88

11.2. Appendix B: Occupied Channel Bandwidth .....92  
11.2.1. Test Result .....92  
11.2.2. Test Graphs .....93

11.3. Appendix C: Maximum conducted output power.....97  
11.3.1. Test Result .....97

11.4. Appendix D: Maximum power spectral density .....98  
11.4.1. Test Result .....98  
11.4.2. Test Graphs .....99

11.5. Appendix E: Band edge measurements ..... 103  
11.5.1. Test Result .....103  
11.5.2. Test Graphs .....104

11.6. Appendix F: Conducted Spurious Emission..... 107  
11.6.1. Test Result .....107  
11.6.2. Test Graphs .....108

11.7. Appendix G: Duty Cycle ..... 120  
11.7.1. Test Result .....120  
11.7.2. Test Graphs .....121



# 1. ATTESTATION OF TEST RESULTS

## Applicant Information

Company Name: PAX Technology Limited  
Address: Room 2416, 24/F., Sun Hung Kai Centre, 30 Harbour Road, Wanchai, Hong Kong

## Manufacturer Information

Company Name: PAX Computer Technology (Shenzhen) C),Ltd.  
Address: 4/F,No.3 Building, Software Park, Second Central Science-TechRoad, High-Tech Industrial Park, Shenzhen, Guangdong, P.R.C.

## EUT Information

EUT Name: Smart Mini Payment Terminal  
Model: A77  
Brand: PAX  
Sample Received Date: Jan 17, 2022  
Sample Status: Normal  
Sample ID: 4562698  
Date of Tested: January 26 ~ April 21, 2022

APPLICABLE STANDARDS	
STANDARD	TEST RESULTS
CFR 47 FCC PART 15 SUBPART C	PASS
ISED RSS-247 Issue 2	PASS
ISED RSS-GEN Issue 5	PASS

Prepared By:

Checked By:

Kebo Zhang  
Project Engineer  
Approved By:

Shawn Wen  
Laboratory Leader

Stephen Guo  
Laboratory Manager



## 2. TEST METHODOLOGY

The tests documented in this report were performed in accordance with KDB 558074 D01 15.247 Meas Guidance v05r02, KDB 414788 D01 Radiated Test Site v01r01, CFR 47 FCC Part 2, CFR 47 FCC Part 15, ANSI C63.10-2013, ISED RSS-247 Issue 2 and ISED RSS-GEN Issue 5.

## 3. FACILITIES AND ACCREDITATION

Accreditation Certificate	<p><b>A2LA (Certificate No.: 4102.01)</b> UL Verification Services (Guangzhou) Co., Ltd. Song Shan Lake Branch. has been assessed and proved to be in compliance with A2LA.</p> <p><b>FCC (FCC Designation No.: CN1187)</b> UL Verification Services (Guangzhou) Co., Ltd. Song Shan Lake Branch. Has been recognized to perform compliance testing on equipment subject to the Commission's Declaration of Conformity (DoC) and Certification rules</p> <p><b>ISED (Company No.: 21320)</b> UL Verification Services (Guangzhou) Co., Ltd. Song Shan Lake Branch. has been registered and fully described in a report filed with ISED. The Company Number is 21320 and the test lab Conformity Assessment Body Identifier (CABID) is CN0046.</p> <p><b>VCCI (Registration No.: G-20019, R-20004, C-20012 and T-20011)</b> UL Verification Services (Guangzhou) Co., Ltd. Song Shan Lake Branch. has been assessed and proved to be in compliance with VCCI, the Membership No. is 3793. Facility Name: Chamber D, the VCCI registration No. is G-20019 and R-20004 Shielding Room B , the VCCI registration No. is C-20012 and T-20011</p>
---------------------------	---

Note 1: All tests measurement facilities use to collect the measurement data are located at Building 10, Innovation Technology Park, Song Shan Lake Hi tech Development Zone, Dongguan, 523808, China

Note 2: The test anechoic chamber in UL Verification Services (Guangzhou) Co., Ltd. Song Shan Lake Branch had been calibrated and compared to the open field sites and the test anechoic chamber is shown to be equivalent to or worst case from the open field site.

Note 3: For below 30 MHz, lab had performed measurements at test anechoic chamber and comparing to measurements obtained on an open field site. And these measurements below 30 MHz had been correlated to measurements performed on an OFS.

## 4. CALIBRATION AND UNCERTAINTY

### 4.1. MEASURING INSTRUMENT CALIBRATION

The measuring equipment utilized to perform the tests documented in this report has been calibrated in accordance with the manufacturer's recommendations and is traceable to recognize national standards.

### 4.2. MEASUREMENT UNCERTAINTY

Where relevant, the following measurement uncertainty levels have been estimated for tests performed on the apparatus:

Test Item	Uncertainty
Conduction emission	3.62 dB
Radiated Emission (Included Fundamental Emission) (9 kHz ~ 30 MHz)	2.2 dB
Radiated Emission (Included Fundamental Emission) (30 MHz ~ 1 GHz)	4.00 dB
Radiated Emission (Included Fundamental Emission) (1 GHz to 26 GHz)	5.78 dB (1 GHz ~ 18 GHz)
	5.23 dB (18 GHz ~ 26 GHz)
Duty Cycle	±0.028%
DTS and 99% Occupied Bandwidth	±0.0196%
Maximum Conducted Output Power	±0.686 dB
Maximum Power Spectral Density Level	±0.743 dB
Conducted Band-edge Compliance	±1.328 dB
Conducted Unwanted Emissions In Non-restricted Frequency Bands	±0.746 dB (9 kHz ~ 1 GHz)
	±1.328dB (1 GHz ~ 26 GHz)
Note: This uncertainty represents an expanded uncertainty expressed at approximately the 95% confidence level using a coverage factor of k=2.	





## 5. EQUIPMENT UNDER TEST

### 5.1. DESCRIPTION OF EUT

EUT Name:	Smart Mini Payment Terminal
Model Name:	A77
Radio Technology	IEEE802.11b/g/n HT20/HT40
Operation frequency	IEEE 802.11b: 2412MHz ~ 2462MHz IEEE 802.11g: 2412MHz ~ 2462MHz IEEE 802.11n HT20: 2412MHz ~ 2462MHz IEEE 802.11n HT40: 2422MHz ~ 2452MHz
Modulation	IEEE 802.11b: DSSS (CCK) IEEE 802.11g: OFDM (64QAM, 16QAM, QPSK, BPSK) IEEE 802.11n HT20: OFDM (64QAM, 16QAM, QPSK, BPSK) IEEE 802.11n HT40: OFDM (64QAM, 16QAM, QPSK, BPSK)
Rated Input	DC 5 V, 2 A
Battery	3.8 Vdc, 5150 mAh

### 5.2. CHANNEL LIST

Channel List for 802.11b/g/n/ax (20 MHz)							
Channel	Frequency (MHz)	Channel	Frequency (MHz)	Channel	Frequency (MHz)	Channel	Frequency (MHz)
1	2412	4	2427	7	2442	10	2457
2	2417	5	2432	8	2447	11	2462
3	2422	6	2437	9	2452	/	/

Channel List for 802.11n/ax (40 MHz)							
Channel	Frequency (MHz)	Channel	Frequency (MHz)	Channel	Frequency (MHz)	Channel	Frequency (MHz)
3	2422	5	2432	7	2442	9	2452
4	2427	6	2437	8	2447	/	/



### 5.3. MAXIMUM OUTPUT POWER

IEEE Std. 802.11	Frequency (MHz)	Channel Number	Maximum Conducted AVG Output Power (dBm)
b	2412 ~ 2462	1-11[11]	16.37
g	2412 ~ 2462	1-11[11]	16.13
n HT20	2412 ~ 2462	1-11[11]	13.61
n HT40	2422 ~ 2452	3-9[7]	14.43

### 5.4. TEST CHANNEL CONFIGURATION

IEEE Std. 802.11	Test Channel Number	Frequency
b	CH 1(Low Channel), CH 6(MID Channel), CH 11(High Channel)	2412 MHz, 2437 MHz, 2462 MHz
g	CH 1(Low Channel), CH 6(MID Channel), CH 11(High Channel)	2412 MHz, 2437 MHz, 2462 MHz
n HT20	CH 1(Low Channel), CH 6(MID Channel), CH 11(High Channel)	2412 MHz, 2437 MHz, 2462 MHz
n HT40	CH 3(Low Channel), CH 6(MID Channel), CH 9(High Channel)	2422 MHz, 2437 MHz, 2452 MHz

### 5.5. THE WORSE CASE POWER SETTING PARAMETER

The Worst Case Power Setting Parameter under 2400 ~ 2483.5MHz Band							
Test Software		QRCT3					
Modulation Mode	Transmit Antenna Number	Test Channel					
		NCB: 20MHz			NCB: 40MHz		
		CH 1	CH 6	CH 11	CH 3	CH 6	CH 9
802.11b	1	17	17	17	/		
802.11g	1	16	17	18			
802.11n HT20	1	16	16	16			
802.11n HT40	1	/			16	16	16



## 5.6. THE WORSE CASE CONFIGURATIONS

The EUT was tested in the following configuration(s):

Controlled in test mode using a software application on the EUT supplied by customer. The application was used to enable a continuous transmission and to select the mode, test channels, bandwidth, data rates as required.

Test channels referring to section 5.4.

Maximum power setting referring to section 5.5.

Worst-case data rates as provided by the client were:

802.11b mode: 1 Mbps

802.11g mode: 6 Mbps

802.11n HT20 mode: MCS0

802.11n HT40 mode: MCS0

The measured additional path loss was included in any path loss calculations for all RF cable used during tested.



### 5.7. DESCRIPTION OF AVAILABLE ANTENNAS

Antenna	Frequency (MHz)	Antenna Type	MAX Antenna Gain (dBi)
1	2412-2462	PIFA	0.18

Test Mode	Transmit and Receive Mode	Description
IEEE 802.11b	<input checked="" type="checkbox"/> 1TX, 1RX	ANT 1 can be used as transmitting/receiving antenna.
IEEE 802.11g	<input checked="" type="checkbox"/> 1TX, 1RX	ANT 1 can be used as transmitting/receiving antenna.
IEEE 802.11n HT20	<input checked="" type="checkbox"/> 1TX, 1RX	ANT 1 can be used as transmitting/receiving antenna.
IEEE 802.11n HT40	<input checked="" type="checkbox"/> 1TX, 1RX	ANT 1 can be used as transmitting/receiving antenna.

Note: The value of the antenna gain was declared by customer.

## 5.8. DESCRIPTION OF TEST SETUP

### SUPPORT EQUIPMENT

Item	Equipment	Brand Name	Model Name	Remarks
1	Laptop	Lenovo	E14	/
2	Adapter	PAX	GLH50D2000HW	Input: AC 100~240V, 50/60Hz, 0.4A Output: 5Vdc, 2000mA

### I/O CABLES

Cable No	Port	Connector Type	Cable Type	Cable Length(m)	Remarks
1	USB	Type C	/	1.0	/

### ACCESSORIES

Item	Accessory	Brand Name	Model Name	Description
/	/	/	/	/

### TEST SETUP

The EUT can work in engineering mode with a software through a Laptop.

### SETUP DIAGRAM FOR TESTS

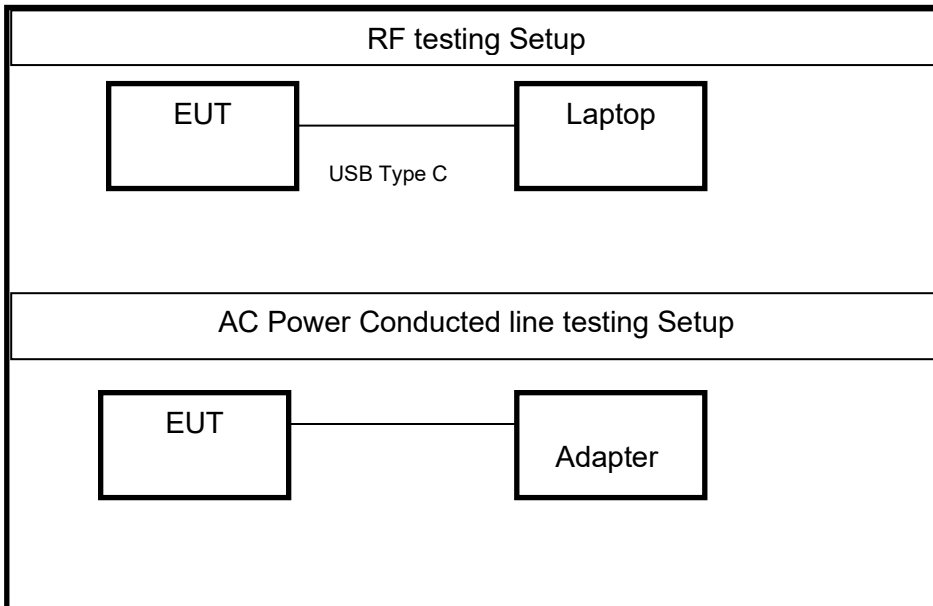

**6. MEASURING INSTRUMENT AND SOFTWARE USED**

Conducted Emissions					
Equipment	Manufacturer	Model No.	Serial No.	Last Cal.	Due Date
EMI Test Receiver	R&S	ESR3	101961	Oct.30, 2021	Oct.29, 2022
Two-Line V-Network	R&S	ENV216	101983	Oct.30, 2021	Oct.29, 2022
Software					
Description		Manufacturer	Name	Version	
Test Software for Conducted Emissions		Farad	EZ-EMC	Ver. UL-3A1	

Radiated Emissions					
Equipment	Manufacturer	Model No.	Serial No.	Last Cal.	Due Date
MXE EMI Receiver	KESIGHT	N9038A	MY56400036	Oct.30, 2021	Oct.29, 2022
Hybrid Log Periodic Antenna	TDK	HLP-3003C	130959	Aug.02, 2021	Aug.01, 2024
Preamplifier	HP	8447D	2944A09099	Oct.30, 2021	Oct.29, 2022
EMI Measurement Receiver	R&S	ESR26	101377	Oct.30, 2021	Oct.29, 2022
Horn Antenna	TDK	HRN-0118	130940	July 20, 2021	July 19, 2024
Preamplifier	TDK	PA-02-0118	TRS-305-00067	Oct.30, 2021	Oct.29, 2022
Horn Antenna	Schwarzbeck	BBHA9170	697	July 20, 2021	July 19, 2024
Preamplifier	TDK	PA-02-2	TRS-307-00003	Oct.31, 2021	Oct.30, 2022
Preamplifier	TDK	PA-02-3	TRS-308-00002	Oct.31, 2021	Oct.30, 2022
Loop antenna	Schwarzbeck	1519B	00008	Jan.17, 2019	Jan.17,2022
Preamplifier	TDK	PA-02-001-3000	TRS-302-00050	Oct.31, 2021	Oct.30, 2022
Preamplifier	Mini-Circuits	ZX60-83LN-S+	SUP01201941	Oct.31, 2021	Oct.30, 2022
High Pass Filter	Wi	WHKX10-2700-3000-18000-40SS	23	Oct.31, 2021	Oct.30, 2022
Band Reject Filter	Wainwright	WRCJV8-2350-2400-2483.5-2533.5-40SS	4	Oct.31, 2021	Oct.30, 2022
Software					
Description		Manufacturer	Name	Version	



Test Software for Radiated Emissions	Farad	EZ-EMC	Ver. UL-3A1
--------------------------------------	-------	--------	-------------

Tonsend RF Test System					
Equipment	Manufacturer	Model No.	Serial No.	Last Cal.	Due. Date
PXA Signal Analyzer	Keysight	N9030A	MY55410512	Oct.30, 2021	Oct.29, 2022
MXG Vector Signal Generator	Keysight	N5182B	MY56200284	Oct.30, 2021	Oct.29, 2022
MXG Vector Signal Generator	Keysight	N5172B	MY56200301	Oct.30, 2021	Oct.29, 2022
Software					
Description	Manufacturer	Name		Version	
Tonsend SRD Test System	Tonsend	JS1120-3 RF Test System		2.6.77.0518	

Other Instruments					
Equipment	Manufacturer	Model No.	Serial No.	Last Cal.	Next Cal.
Dual Channel Power Meter	Keysight	N1912A	MY55416024	Oct.30, 2021	Oct.29, 2022
Power Sensor	Keysight	USB Wideband Power Sensor	MY5100022	Oct.30, 2021	Oct.29, 2022
Signal Analyzer	R&S	FSV40	101118	Oct.30, 2021	Oct.29, 2022

## 7. ANTENNA PORT TEST RESULTS

### 7.1. ON TIME AND DUTY CYCLE

#### LIMITS

None; for reporting purposes only

#### PROCEDURE

Refer to ANSI C63.10-2013 clause 11.6 Zero – Span Spectrum Analyzer method.

#### TEST SETUP

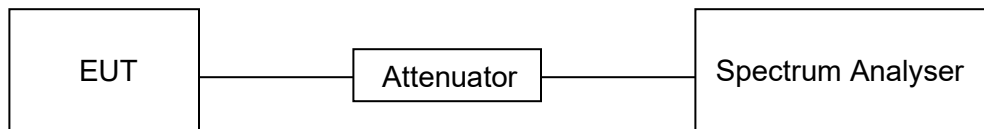

#### TEST ENVIRONMENT

Temperature	25.7 °C	Relative Humidity	61.5 %
Atmosphere Pressure	101 kPa	Test Voltage	DC 3.8 V

#### RESULTS

Please refer to appendix G.



## 7.2. 6 dB DTS BANDWIDTH AND 99 % OCCUPIED BANDWIDTH

### LIMITS

CFR 47 FCC Part15 (15.247) Subpart C			
Section	Test Item	Limit	Frequency Range (MHz)
CFR 47 FCC 15.247(a)(2) ISED RSS-247 5.2 (a)	6 dB Bandwidth	≥ 500 kHz	2400-2483.5
ISED RSS-Gen Clause 6.7	99 % Occupied Bandwidth	For reporting purposes only.	2400-2483.5

### TEST PROCEDURE

Connect the EUT to the spectrum analyser and use the following settings:

Center Frequency	The center frequency of the channel under test
Frequency Span	Between 1.5 times and 5.0 times the OBW
Detector	Peak
RBW	For 6 dB Bandwidth: 100 kHz For 99 % Occupied Bandwidth: 1 % to 5 % of the occupied bandwidth
VBW	For 6 dB Bandwidth: ≥3 × RBW For 99 % Occupied Bandwidth: ≥3 × RBW
Trace	Max hold
Sweep	Auto couple

- a) Use the 99 % power bandwidth function of the instrument, allow the trace to stabilize and report the measured bandwidth.
- b) Allow the trace to stabilize and measure the maximum width of the emission that is constrained by the frequencies associated with the two outermost amplitude points (upper and lower frequencies) that are attenuated by 6 dB relative to the maximum level measured in the fundamental emission.

### TEST SETUP

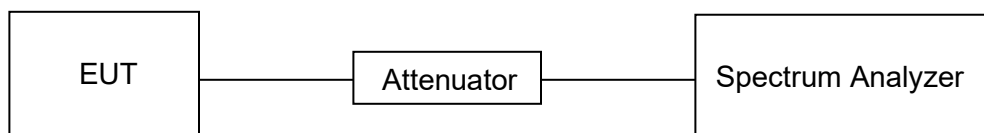



**TEST ENVIRONMENT**

Temperature	25.7 °C	Relative Humidity	61.5 %
Atmosphere Pressure	101 kPa	Test Voltage	DC 3.8 V

**RESULTS**

Please refer to appendix A & B.

### 7.3. CONDUCTED OUTPUT POWER

#### LIMITS

CFR 47 FCC Part15 (15.247) Subpart C ISED RSS-247 ISSUE 2			
Section	Test Item	Limit	Frequency Range (MHz)
CFR 47 FCC 15.247(b)(3) ISED RSS-247 5.4 (d)	AVG Output Power	1 watt or 30 dBm	2400-2483.5

#### TEST PROCEDURE

For Peak Power:

Connect the EUT to the spectrum analyser and use the following settings:

- a) Set the RBW = 1 MHz.
- b) Set the VBW  $\geq [3 \times \text{RBW}]$ .
- c) Set the span  $\geq [1.5 \times \text{DTS bandwidth}]$ .
- d) Detector = peak.
- e) Sweep time = auto couple.
- f) Trace mode = max hold.
- g) Allow trace to fully stabilize.
- h) Use the instrument's band/channel power measurement function with the band limits set equal to the DTS bandwidth edges (for some instruments, this may require a manual override to select the peak detector). If the instrument does not have a band power function, then sum the spectrum levels (in linear power units) at intervals equal to the RBW extending across the DTS channel bandwidth.

Measure peak emission level, the indicated level is the peak output power, after any corrections for external attenuators and cables.

For Average Power:

Connect the EUT to a low loss RF cable from the antenna port to the power sensor (video bandwidth is greater than the occupied bandwidth).

Measure peak emission level, the indicated level is the average output power, after any corrections for external attenuators and cables.

#### TEST SETUP

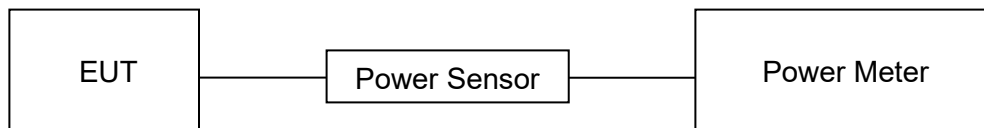



**TEST ENVIRONMENT**

Temperature	25.7 °C	Relative Humidity	61.5 %
Atmosphere Pressure	101 kPa	Test Voltage	DC 3.8 V

**RESULTS**

Please refer to appendix C.

## 7.4. POWER SPECTRAL DENSITY

### LIMITS

CFR 47 FCC Part15 (15.247) Subpart C ISED RSS-247 ISSUE 2			
Section	Test Item	Limit	Frequency Range (MHz)
CFR 47 FCC §15.247 (e) ISED RSS-247 5.2 (b)	Power Spectral Density	8 dBm/3 kHz	2400-2483.5

### TEST PROCEDURE

Refer to ANSI C63.10-2013 clause 11.10.

Connect the EUT to the spectrum analyser and use the following settings:

Center Frequency	The center frequency of the channel under test
Detector	AVG
RBW	$3 \text{ kHz} \leq \text{RBW} \leq 100 \text{ kHz}$
VBW	$\geq 3 \times \text{RBW}$
Span	1.5 x DTS bandwidth
Trace	Trace averager at least 100 traces
Sweep time	Auto couple

Allow trace to fully stabilize and use the peak marker function to determine the maximum amplitude level within the RBW.

If measured value exceeds limit, reduce RBW (no less than 3 kHz) and repeat.

### TEST SETUP

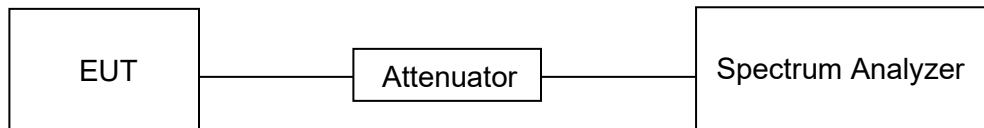

### TEST ENVIRONMENT

Temperature	25.7 °C	Relative Humidity	61.5 %
Atmosphere Pressure	101 kPa	Test Voltage	DC 3.8 V



**RESULTS**

Please refer to appendix D.



## 7.5. CONDUCTED BANDEGE AND SPURIOUS EMISSIONS

### LIMITS

CFR 47 FCC Part15 (15.247) Subpart C ISED RSS-247 ISSUE 2		
Section	Test Item	Limit
CFR 47 FCC §15.247 (d) ISED RSS-247 5.5	Conducted Bandedge and Spurious Emissions	at least 30 dB below that in the 100 kHz bandwidth within the band that contains the highest level of the desired power

### TEST PROCEDURE

Refer to ANSI C63.10-2013 clause 11.11 and 11.13.

Connect the EUT to the spectrum analyser and use the following settings for reference level measurement:

Center Frequency	The center frequency of the channel under test
Detector	Peak
RBW	100 kHz
VBW	$\geq 3 \times \text{RBW}$
Span	1.5 x DTS bandwidth
Trace	Max hold
Sweep time	Auto couple.

Allow trace to fully stabilize and use the peak marker function to determine the maximum PSD level.

Change the settings for emission level measurement:

Span	Set the center frequency and span to encompass frequency range to be measured
Detector	Peak
RBW	100 kHz
VBW	$\geq 3 \times \text{RBW}$
measurement points	$\geq \text{span}/\text{RBW}$
Trace	Max hold
Sweep time	Auto couple.

Allow trace to fully stabilize and use the peak marker function to determine the maximum PSD level. Ensure that the amplitude of all unwanted emissions outside of the authorized frequency band (excluding restricted frequency bands) is attenuated by at least the minimum requirements specified in 11.11.



**TEST SETUP**

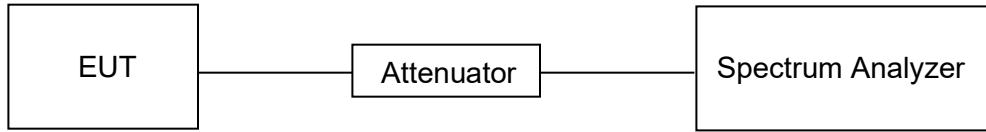

**TEST ENVIRONMENT**

Temperature	25.7 °C	Relative Humidity	61.5 %
Atmosphere Pressure	101 kPa	Test Voltage	DC 3.8 V

**RESULTS**

Please refer to appendix E & F.



## 8. RADIATED TEST RESULTS

Please refer to CFR 47 FCC §15.205 and §15.209.

Please refer to ISED RSS-GEN Clause 8.9 and Clause 8.10.

Radiation Disturbance Test Limit for FCC (Class B) (9 kHz ~ 1 GHz)

Emissions radiated outside of the specified frequency bands above 30 MHz			
Frequency Range (MHz)	Field Strength Limit (uV/m) at 3 m	Field Strength Limit (dBuV/m) at 3 m	
		Quasi-Peak	
30 - 88	100	40	
88 - 216	150	43.5	
216 - 960	200	46	
Above 960	500	54	
Above 1000	500	Peak	Average
		74	54

FCC Emissions radiated outside of the specified frequency bands below 30 MHz		
Frequency (MHz)	Field strength (microvolts/meter)	Measurement distance (meters)
0.009-0.490	2400/F(kHz)	300
0.490-1.705	24000/F(kHz)	30
1.705-30.0	30	30

ISED General field strength limits at frequencies below 30 MHz

Table 6 – General field strength limits at frequencies below 30 MHz		
Frequency	Magnetic field strength (H-Field) (µA/m)	Measurement distance (m)
9 - 490 kHz <sup>Note 1</sup>	6.37/F (F in kHz)	300
490 - 1705 kHz	63.7/F (F in kHz)	30
1.705 - 30 MHz	0.08	30

**Note 1:** The emission limits for the ranges 9-90 kHz and 110-490 kHz are based on measurements employing a linear average detector.



ISED Restricted bands please refer to ISED RSS-GEN Clause 8.10

**Table 7 – Restricted frequency bands<sup>1</sup>**

MHz	MHz	GHz
0.090 - 0.110	149.9 - 150.05	9.0 - 9.2
0.495 - 0.505	166.52475 - 166.52525	9.3 - 9.5
2.1735 - 2.1905	166.7 - 166.9	10.6 - 12.7
3.020 - 3.028	162.0125 - 167.17	13.25 - 13.4
4.125 - 4.128	167.72 - 173.2	14.47 - 14.5
4.17725 - 4.17775	240 - 285	15.35 - 16.2
4.20725 - 4.20775	322 - 335.4	17.7 - 21.4
5.677 - 5.683	399.9 - 410	22.01 - 23.12
6.215 - 6.218	608 - 614	23.6 - 24.0
6.26775 - 6.26825	960 - 1427	31.2 - 31.8
6.31175 - 6.31225	1435 - 1626.5	36.43 - 36.5
8.291 - 8.294	1045.5 - 1646.5	Above 38.6
8.362 - 8.366	1660 - 1710	
8.37625 - 8.38675	1718.8 - 1722.2	
8.41425 - 8.41475	2200 - 2300	
12.29 - 12.293	2310 - 2390	
12.51975 - 12.52025	2483.5 - 2500	
12.57675 - 12.57725	2655 - 2900	
13.36 - 13.41	3260 - 3267	
16.42 - 16.423	3332 - 3339	
16.69475 - 16.69525	3345.8 - 3358	
16.80425 - 16.80475	3500 - 4400	
25.5 - 25.67	4500 - 5150	
37.5 - 38.25	5350 - 5460	
73 - 74.6	7250 - 7750	
74.8 - 75.2	8025 - 8500	
108 - 138		

**Note 1:** Certain frequency bands listed in table 7 and in bands above 38.6 GHz are designated for licence-exempt applications. These frequency bands and the requirements that apply to related devices are set out in the 200 and 300 series of RSSs.

FCC Restricted bands of operation refer to FCC §15.205 (a):

MHz	MHz	MHz	GHz
0.090-0.110	16.42-16.423	399.9-410	4.5-5.15
<sup>1</sup> 0.495-0.505	16.69475-16.69525	608-614	5.35-5.46
2.1735-2.1905	16.80425-16.80475	960-1240	7.25-7.75
4.125-4.128	25.5-25.67	1300-1427	8.025-8.5
4.17725-4.17775	37.5-38.25	1435-1626.5	9.0-9.2
4.20725-4.20775	73-74.6	1645.5-1646.5	9.3-9.5
6.215-6.218	74.8-75.2	1660-1710	10.6-12.7
6.26775-6.26825	108-121.94	1718.8-1722.2	13.25-13.4
6.31175-6.31225	123-138	2200-2300	14.47-14.5
8.291-8.294	149.9-150.05	2310-2390	15.35-16.2
8.362-8.366	156.52475-156.52525	2483.5-2500	17.7-21.4
8.37625-8.38675	156.7-156.9	2690-2900	22.01-23.12
8.41425-8.41475	162.0125-167.17	3260-3267	23.6-24.0
12.29-12.293	167.72-173.2	3332-3339	31.2-31.8
12.51975-12.52025	240-285	3345.8-3358	36.43-36.5
12.57675-12.57725	322-335.4	3600-4400	( <sup>2</sup> )
13.36-13.41			

Note: <sup>1</sup>Until February 1, 1999, this restricted band shall be 0.490-0.510 MHz.

<sup>2</sup>Above 38.6c

**TEST SETUP AND PROCEDURE**

Below 30 MHz

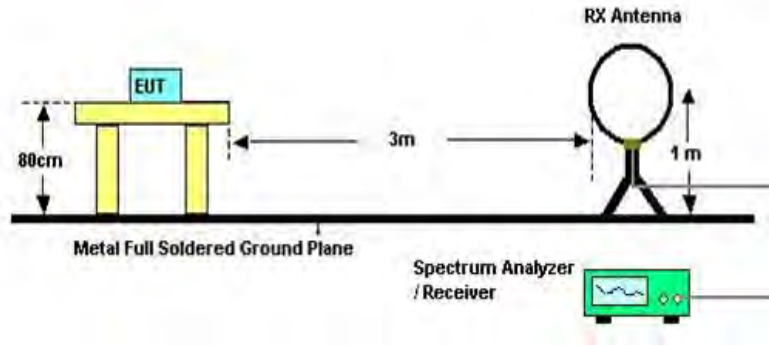

The setting of the spectrum analyser

RBW	200 Hz (From 9 kHz to 0.15 MHz)/ 9 kHz (From 0.15 MHz to 30 MHz)
VBW	200 Hz (From 9 kHz to 0.15 MHz)/ 9 kHz (From 0.15 MHz to 30 MHz)
Sweep	Auto
Trace	Max hold

1. The testing follows the guidelines in ANSI C63.10-2013 clause 11.11 and 11.12.
2. The EUT was arranged to its worst case and then turntable (from 0 degree to 360 degrees) to find the maximum reading. A pre-amp and a high pass filter are used for the test in order to get better signal level. Both Horizontal, Face-on and Face-off polarizations of the antenna are set to make the measurement.
3. The EUT was placed on a turntable with 80 cm above ground.
4. The EUT was set 3 meters from the interference receiving antenna, which was mounted on the top of a 1 m height antenna tower.
5. The radiated emission limits are based on measurements employing a CISPR quasi-peak detector except for the frequency bands 9-90 kHz, 110-490 kHz and above 1000 MHz. Radiated emission limits in these three bands are based on measurements employing an average detector.
6. For measurement below 1 GHz, the initial step in collecting conducted emission data is a spectrum analyzer peak detector mode pre-scanning the measurement frequency range. Significant peaks are then marked and then Quasi Peak and average detector mode re-measured. If the emission level of the EUT measured by the peak detector is 3 dB lower than the applicable limit, the peak emission level will be reported. Otherwise, the emission measurement will be repeated using the quasi-peak and average detector and reported.
7. Although these tests were performed other than open field site, adequate comparison measurements were confirmed against 30m open field site. Therefore sufficient tests were made to demonstrate that the alternative site produces results that correlate with the ones of tests made in an open field site based on KDB 414788.
8. The limits in CFR 47, Part 15, Subpart C, paragraph 15.209 (a), are identical to those in RSS-GEN Section 8.9, Table 6, since the measurements are performed in terms of magnetic field strength and converted to electric field strength levels (as reported in the table) using the free space impedance of  $377 \Omega$ ; For example, the measurement frequency X kHz resulted in a level of Y dBuV/m, which is equivalent to  $Y-51.5 = Z$  dBuA/m, which has the same margin, W dB, to the corresponding RSS-GEN Table 6 limit as it has to be 15.209(a) limit.

Below 1 GHz and above 30 MHz

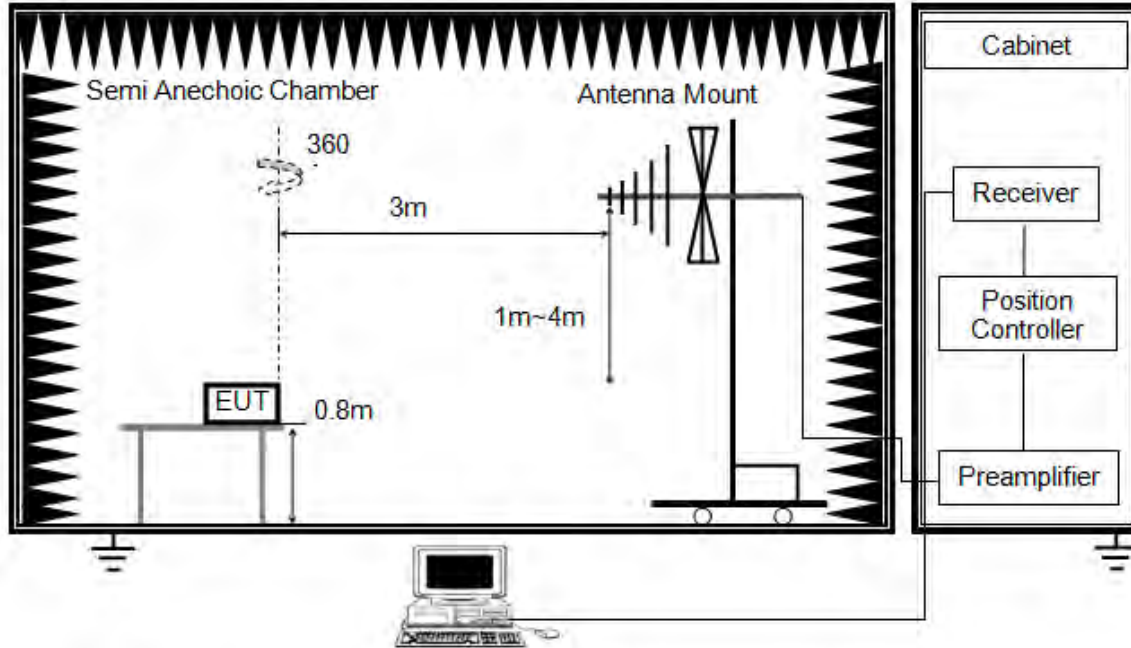

The setting of the spectrum analyzer

RBW	120 kHz
VBW	300 kHz
Sweep	Auto
Detector	Peak/QP
Trace	Max hold

1. The testing follows the guidelines in ANSI C63.10-2013 clause 6.5.
2. The EUT was arranged to its worst case and then tune the antenna tower (from 1 m to 4 m) and turntable (from 0 degree to 360 degrees) to find the maximum reading. A pre-amp and a high pass filter are used for the test in order to get better signal level. Both horizontal and vertical polarizations of the antenna are set to make the measurement.
3. The EUT was placed on a turntable with 80 cm above ground.
4. The EUT was set 3 meters from the interference receiving antenna, which was mounted on the top of a variable height antenna tower.
5. For measurement below 1 GHz, the initial step in collecting conducted emission data is a spectrum analyzer peak detector mode pre-scanning the measurement frequency range. Significant peaks are then marked and then Quasi Peak detector mode re-measured. If the emission level of the EUT measured by the peak detector is 3 dB lower than the applicable limit, the peak emission level will be reported. Otherwise, the emission measurement will be repeated using the quasi-peak detector and reported.

Above 1 GHz

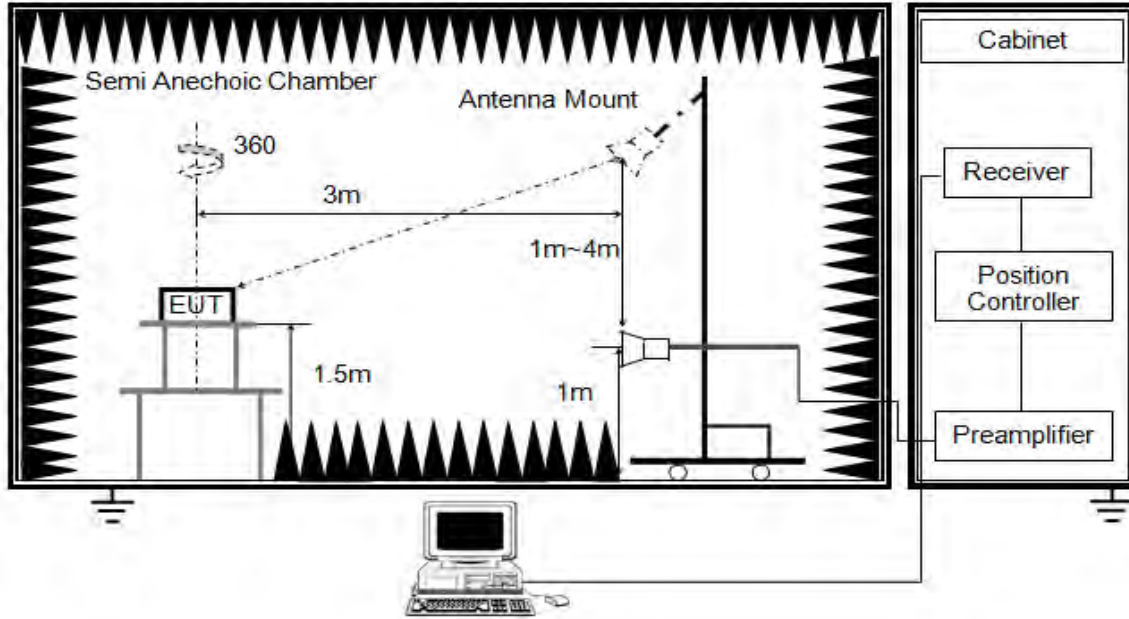

The setting of the spectrum analyser

RBW	1 MHz
VBW	PEAK: 3 MHz AVG: see note 6
Sweep	Auto
Detector	Peak
Trace	Max hold

1. The testing follows the guidelines in ANSI C63.10-2013 clause 6.6.
2. The EUT was arranged to its worst case and then tune the antenna tower (from 1 m to 4 m) and turntable (from 0 degree to 360 degrees) to find the maximum reading. A pre-amp and a high pass filter are used for the test in order to get better signal level. Both horizontal and vertical polarizations of the antenna are set to make the measurement.
3. The EUT was placed on a turntable with 1.5 m above ground.
4. The EUT was set 3 meters from the interference receiving antenna, which was mounted on the top of a variable height antenna tower.
5. For measurement above 1 GHz, the emission measurement will be measured by the peak detector. This peak level, once corrected, must comply with the limit specified in Section 15.209.
6. For measurements above 1 GHz the resolution bandwidth is set to 1 MHz, then the video bandwidth is set to 3 MHz for peak measurements and 1 MHz resolution bandwidth with 1/T video bandwidth with peak detector for average measurements. For the Duty Cycle please refer to clause 7.1.ON TIME AND DUTY CYCLE.

X axis, Y axis, Z axis positions:

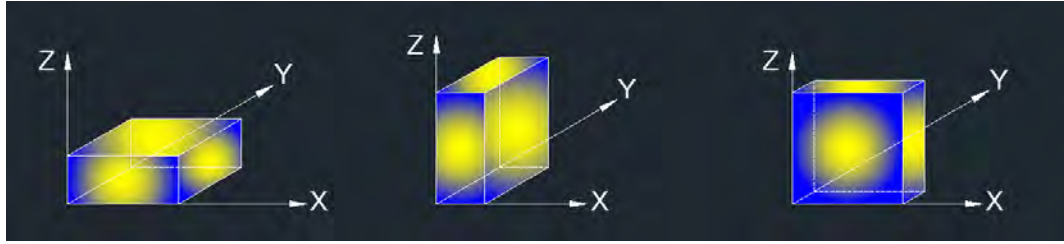

Note 1: For all radiated test, EUT in each of three orthogonal axis emissions had been tested, but only the worst case (X axis) data recorded in the report.

Note 2: The EUT was fully exercised with external accessories during the test. In the case of multiple accessory external ports, an external accessory shall be connected to one of each type of port.

**TEST ENVIRONMENT**

Temperature	18.6 °C	Relative Humidity	35.6 %
Atmosphere Pressure	101 kPa	Test Voltage	DC 3.8 V

**RESULTS**



## 8.1. RESTRICTED BANDEDGE

### 8.1.1. 802.11b MODE

#### RESTRICTED BANDEDGE (LOW CHANNEL, HORIZONTAL)

#### PEAK

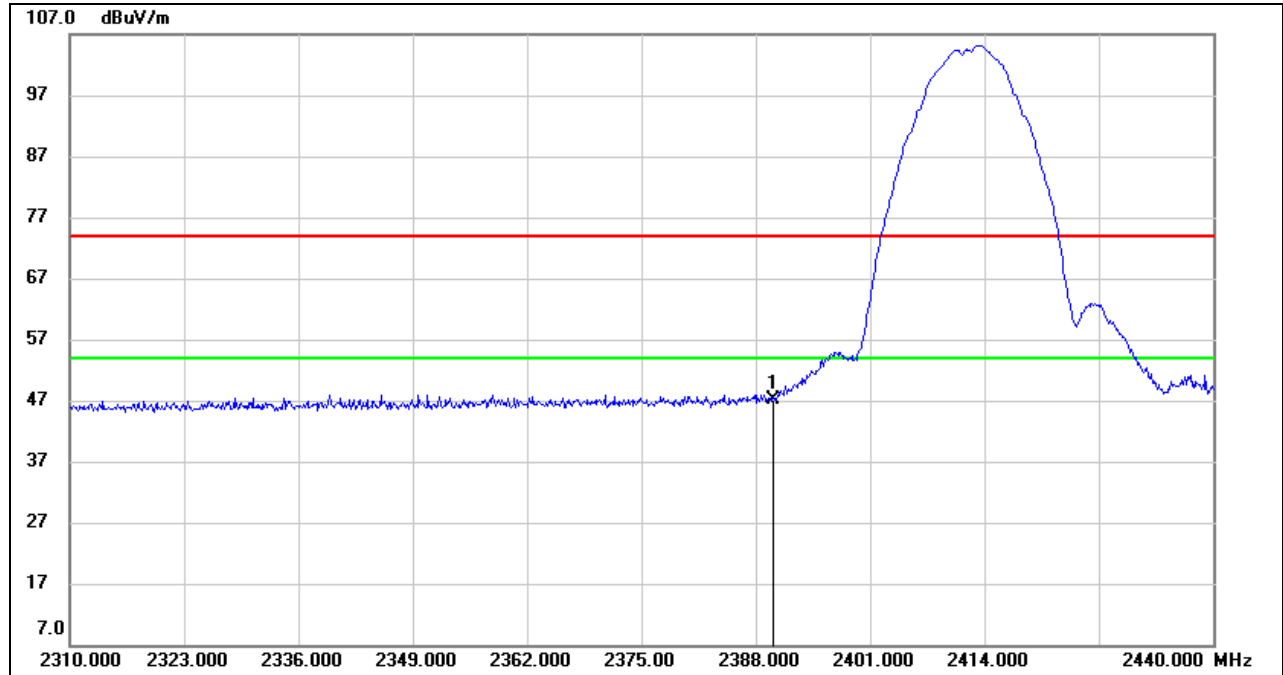

No.	Frequency (MHz)	Reading (dBuV)	Correct (dB/m)	Result (dBuV/m)	Limit (dBuV/m)	Margin (dB)	Remark
1	2390.000	14.41	32.66	47.07	74.00	-26.93	peak

Note: 1. Measurement = Reading Level + Correct Factor.

2. Peak: Peak detector.

3. Only the worst data was recorded, if it complies with the limit, the other emissions deemed to comply with the limit.

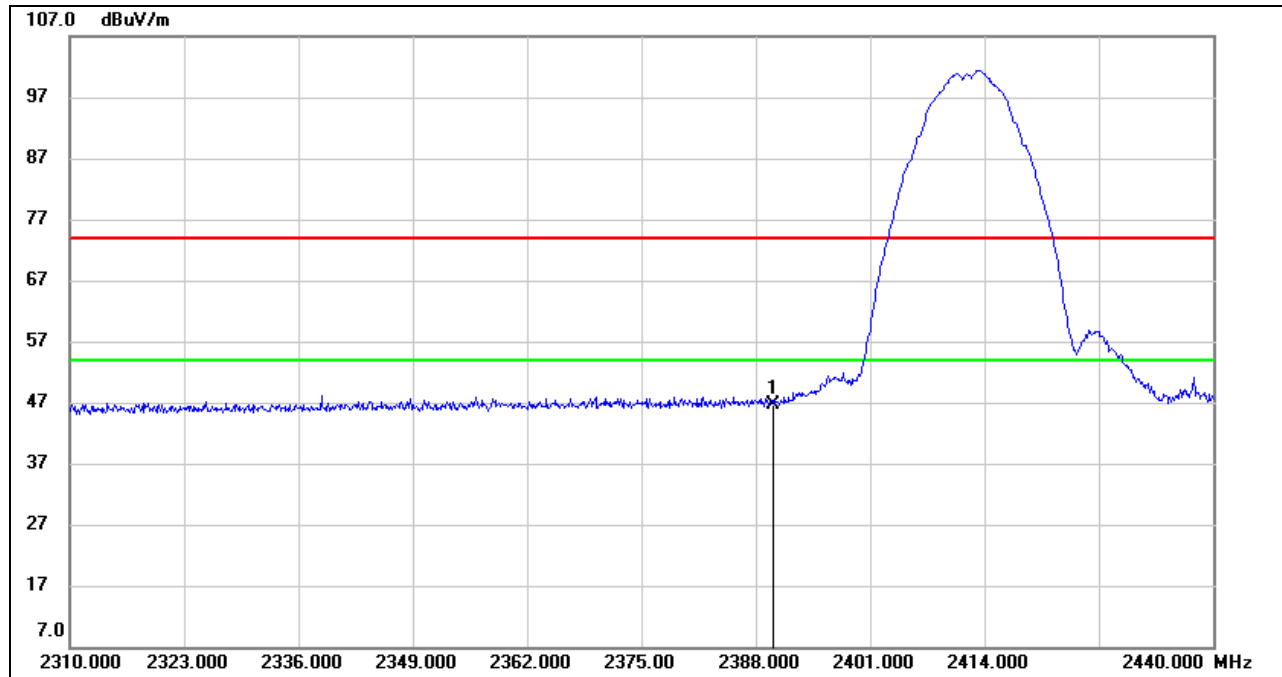
**RESTRICTED BANDEDGE (LOW CHANNEL, VERTICAL)****PEAK**

No.	Frequency (MHz)	Reading (dBuV)	Correct (dB/m)	Result (dBuV/m)	Limit (dBuV/m)	Margin (dB)	Remark
1	2390.000	14.02	32.66	46.68	74.00	-27.32	peak

Note: 1. Measurement = Reading Level + Correct Factor.

2. Peak: Peak detector.

3. Only the worst data was recorded, if it complies with the limit, the other emissions deemed to comply with the limit.



**RESTRICTED BANDEDGE (HIGH CHANNEL, HORIZONTAL)**

**PEAK**

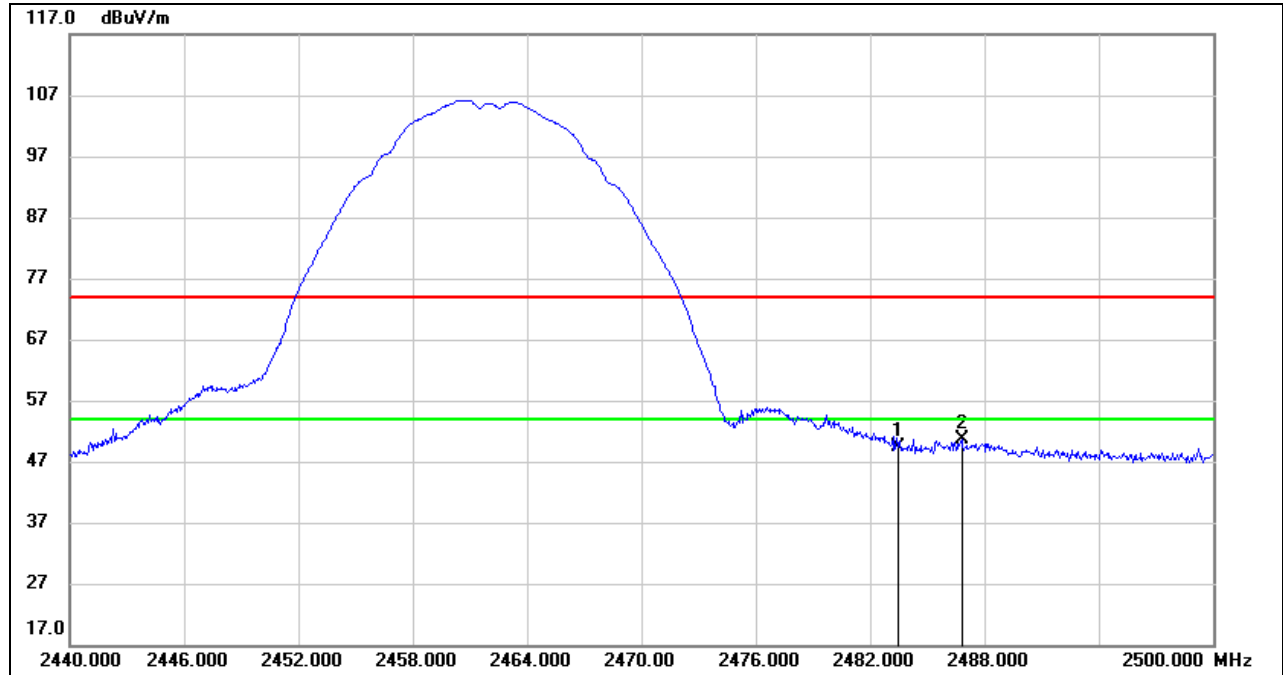

No.	Frequency (MHz)	Reading (dBuV)	Correct (dB/m)	Result (dBuV/m)	Limit (dBuV/m)	Margin (dB)	Remark
1	2483.500	16.17	33.10	49.27	74.00	-24.73	peak
2	2486.800	17.46	33.11	50.57	74.00	-23.43	peak

Note: 1. Measurement = Reading Level + Correct Factor.  
 2. Peak: Peak detector.  
 3. Only the worst data was recorded, if it complies with the limit, the other emissions deemed to comply with the limit.

Note: All the polarities (Vertical & Horizontal) had been tested, only the worst data was recorded in the report.

8.1.2. 802.11g MODE

RESTRICTED BANDEDGE (LOW CHANNEL, HORIZONTAL)

PEAK

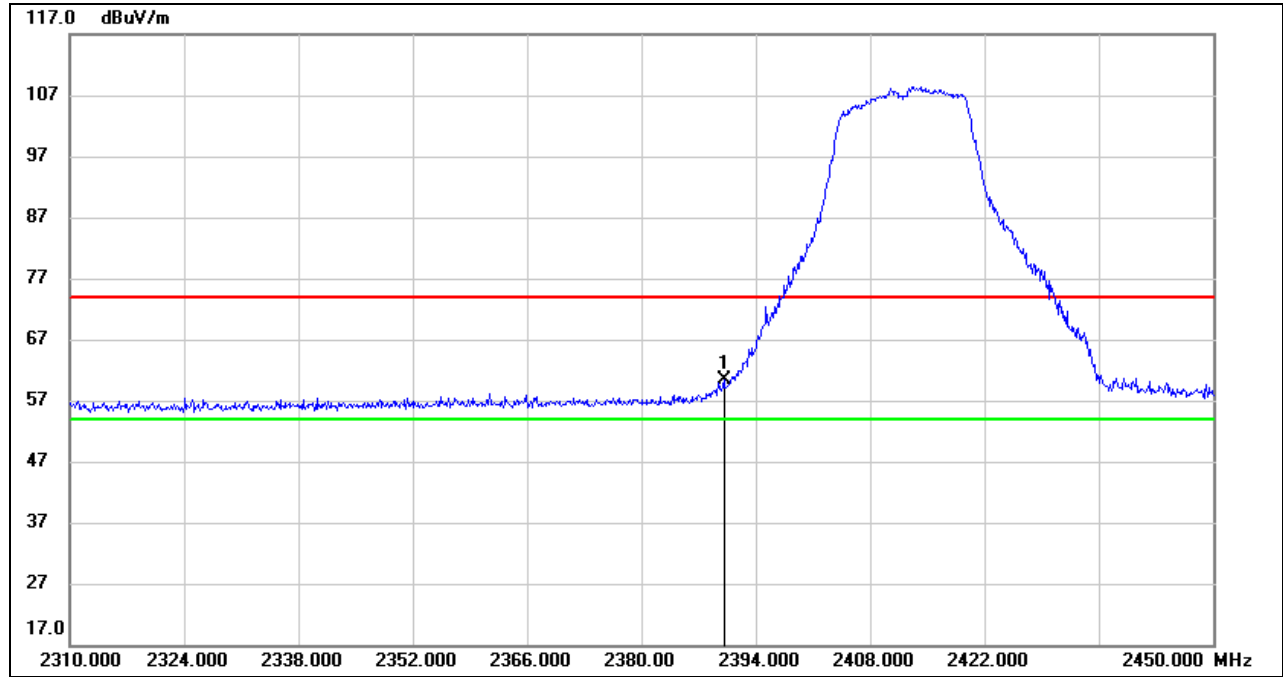

No.	Frequency (MHz)	Reading (dBuV)	Correct (dB/m)	Result (dBuV/m)	Limit (dBuV/m)	Margin (dB)	Remark
1	2390.000	27.84	32.66	60.50	74.00	-13.50	peak

Note: 1. Measurement = Reading Level + Correct Factor.  
 2. Peak: Peak detector.  
 3. Only the worst data was recorded, if it complies with the limit, the other emissions deemed to comply with the limit.

**AVG**

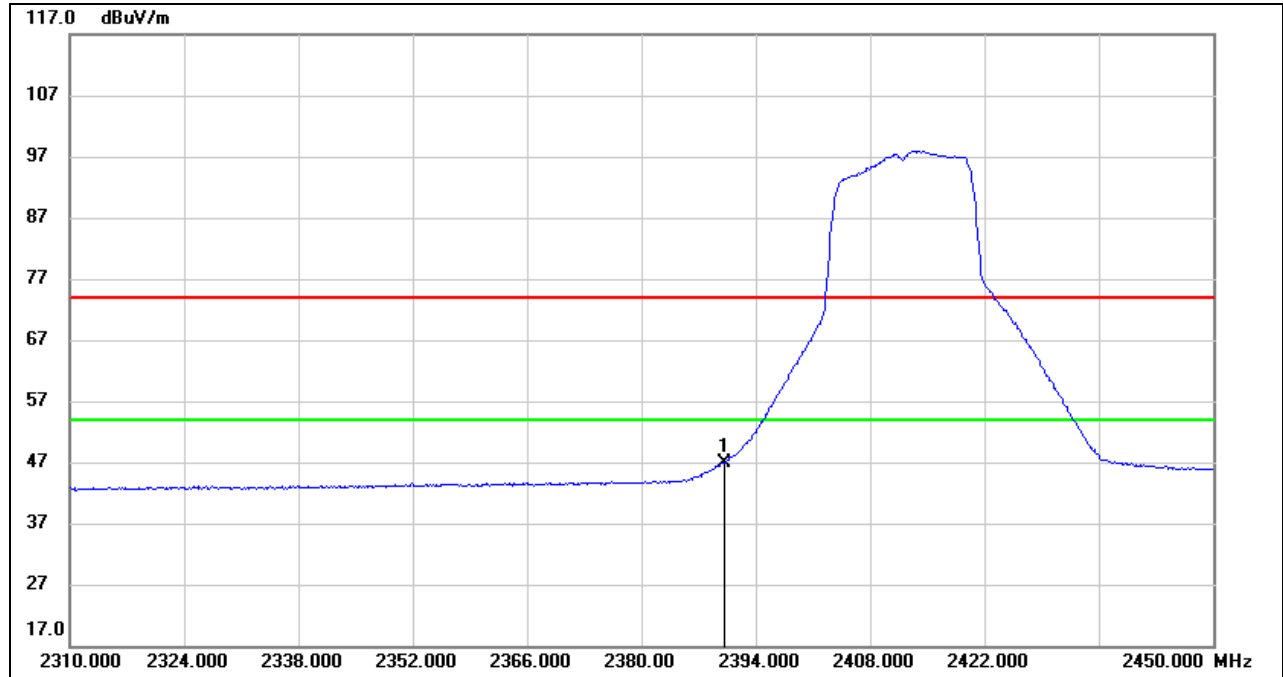

No.	Frequency (MHz)	Reading (dBuV)	Correct (dB/m)	Result (dBuV/m)	Limit (dBuV/m)	Margin (dB)	Remark
1	2390.000	14.27	32.66	46.93	54.00	-7.07	AVG

- Note:
1. Measurement = Reading Level + Correct Factor.
  2. AVG:  $VBW=1/T_{on}$ , where:  $T_{on}$  is the transmitting duration.
  3. For the transmitting duration, please refer to clause 7.1.
  4. Only the worst data was recorded, if it complies with the limit, the other emissions deemed to comply with the limit.



**RESTRICTED BANDEDGE (HIGH CHANNEL, HORIZONTAL)**

**PEAK**

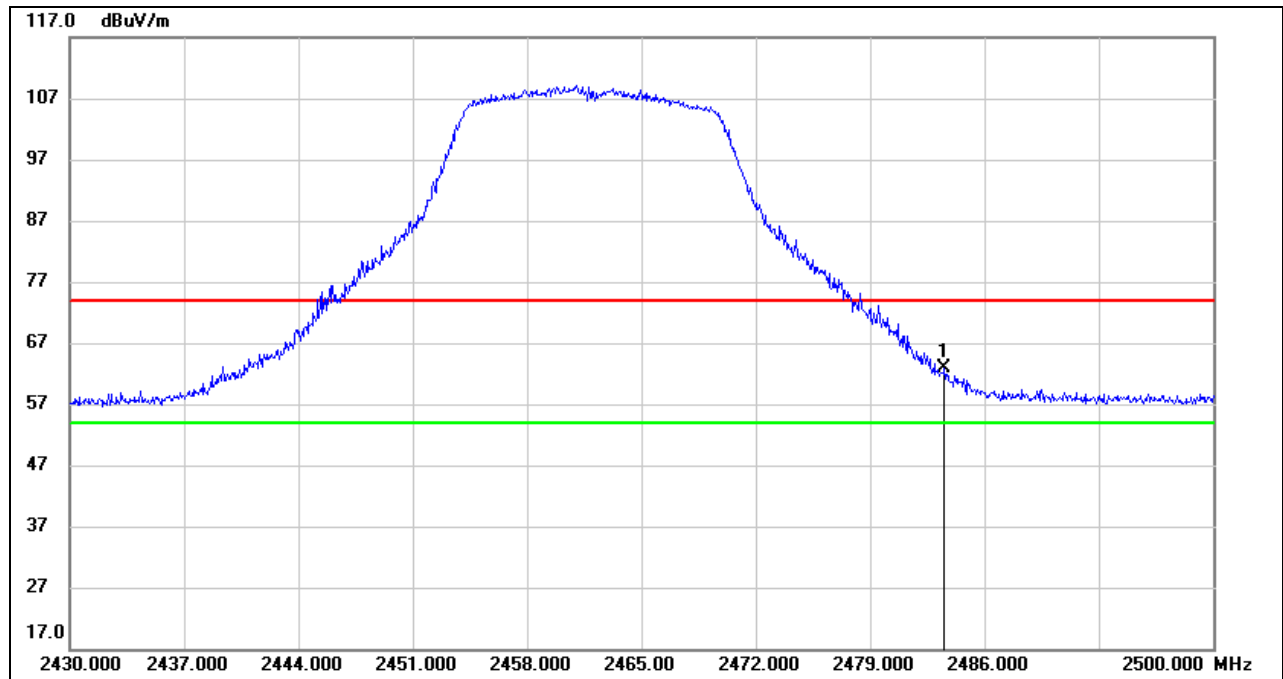

No.	Frequency (MHz)	Reading (dBuV)	Correct (dB/m)	Result (dBuV/m)	Limit (dBuV/m)	Margin (dB)	Remark
1	2483.500	29.77	33.10	62.87	74.00	-11.13	peak

Note: 1. Measurement = Reading Level + Correct Factor.

2. Peak: Peak detector.

3. Only the worst data was recorded, if it complies with the limit, the other emissions deemed to comply with the limit.

**AVG**

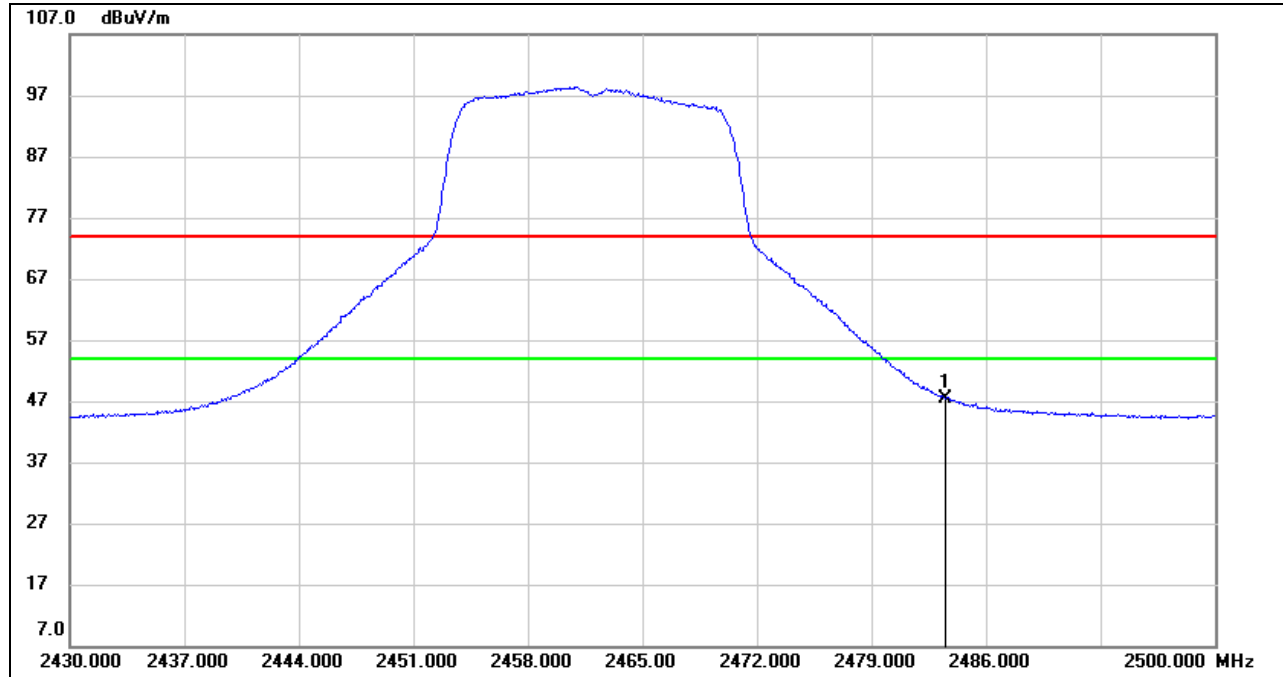

No.	Frequency (MHz)	Reading (dBuV)	Correct (dB/m)	Result (dBuV/m)	Limit (dBuV/m)	Margin (dB)	Remark
1	2483.500	14.35	33.10	47.45	54.00	-6.55	AVG

- Note: 1. Measurement = Reading Level + Correct Factor.  
 2. AVG:  $VBW=1/Ton$ , where: Ton is the transmitting duration.  
 3. For the transmitting duration, please refer to clause 7.1.  
 4. Only the worst data was recorded, if it complies with the limit, the other emissions deemed to comply with the limit.

Note: All the polarities (Vertical & Horizontal) had been tested, only the worst data was recorded in the report.

8.1.3. 802.11n HT20 MODE

RESTRICTED BANDEDGE (LOW CHANNEL, HORIZONTAL)

PEAK

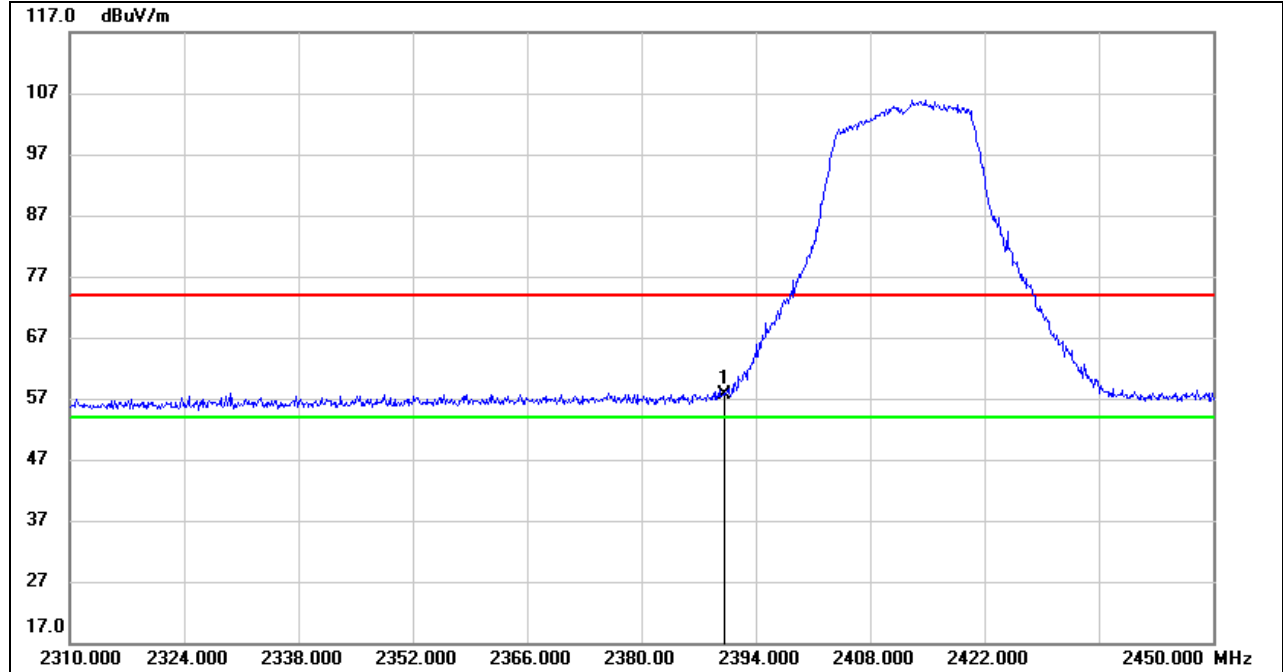

No.	Frequency (MHz)	Reading (dBuV)	Correct (dB/m)	Result (dBuV/m)	Limit (dBuV/m)	Margin (dB)	Remark
1	2390.000	25.08	32.66	57.74	74.00	-16.26	peak

Note: 1. Measurement = Reading Level + Correct Factor.  
 2. Peak: Peak detector.  
 3. Only the worst data was recorded, if it complies with the limit, the other emissions deemed to comply with the limit.

**AVG**

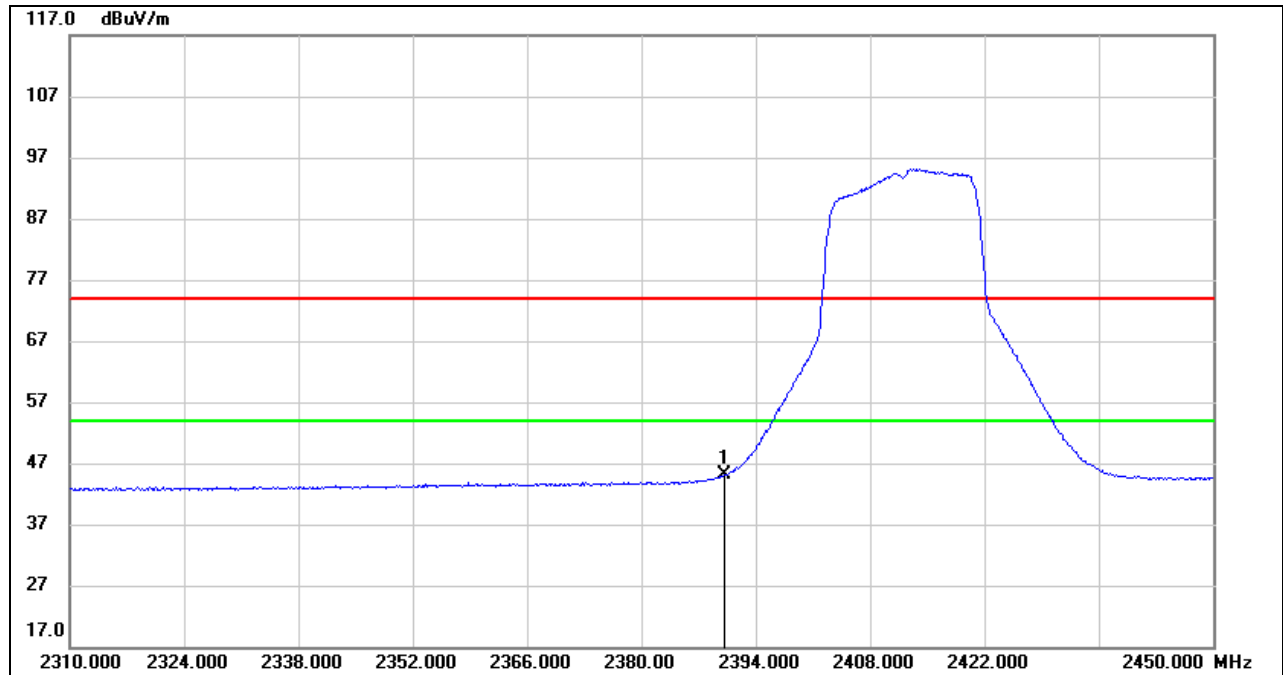

No.	Frequency (MHz)	Reading (dBuV)	Correct (dB/m)	Result (dBuV/m)	Limit (dBuV/m)	Margin (dB)	Remark
1	2390.000	12.47	32.66	45.13	54.00	-8.87	AVG

- Note: 1. Measurement = Reading Level + Correct Factor.  
 2. AVG:  $VBW=1/Ton$ , where:  $Ton$  is the transmitting duration.  
 3. For the transmitting duration, please refer to clause 7.1.  
 4. Only the worst data was recorded, if it complies with the limit, the other emissions deemed to comply with the limit.

**RESTRICTED BANDEDGE (HIGH CHANNEL, HORIZONTAL)**

**PEAK**

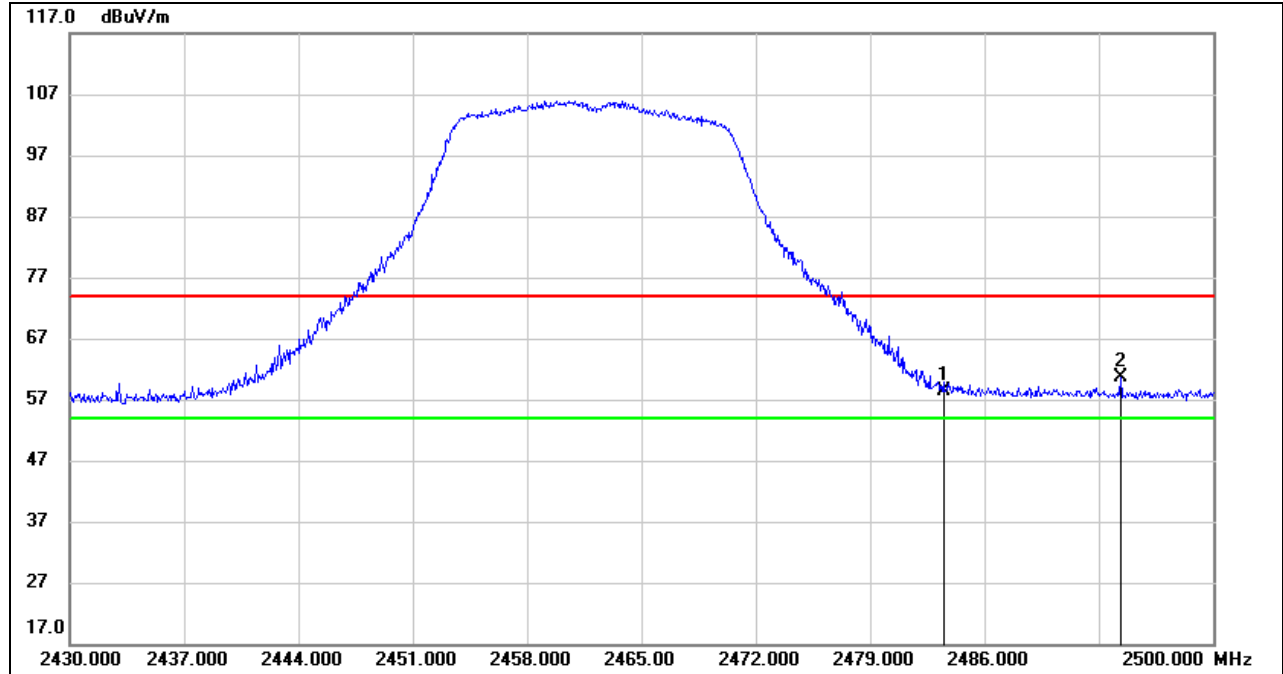

No.	Frequency (MHz)	Reading (dBuV)	Correct (dB/m)	Result (dBuV/m)	Limit (dBuV/m)	Margin (dB)	Remark
1	2483.500	25.19	33.10	58.29	74.00	-15.71	peak
2	2494.330	27.59	33.14	60.73	74.00	-13.27	peak

Note: 1. Measurement = Reading Level + Correct Factor.

2. Peak: Peak detector.

3. Only the worst data was recorded, if it complies with the limit, the other emissions deemed to comply with the limit.



**AVG**

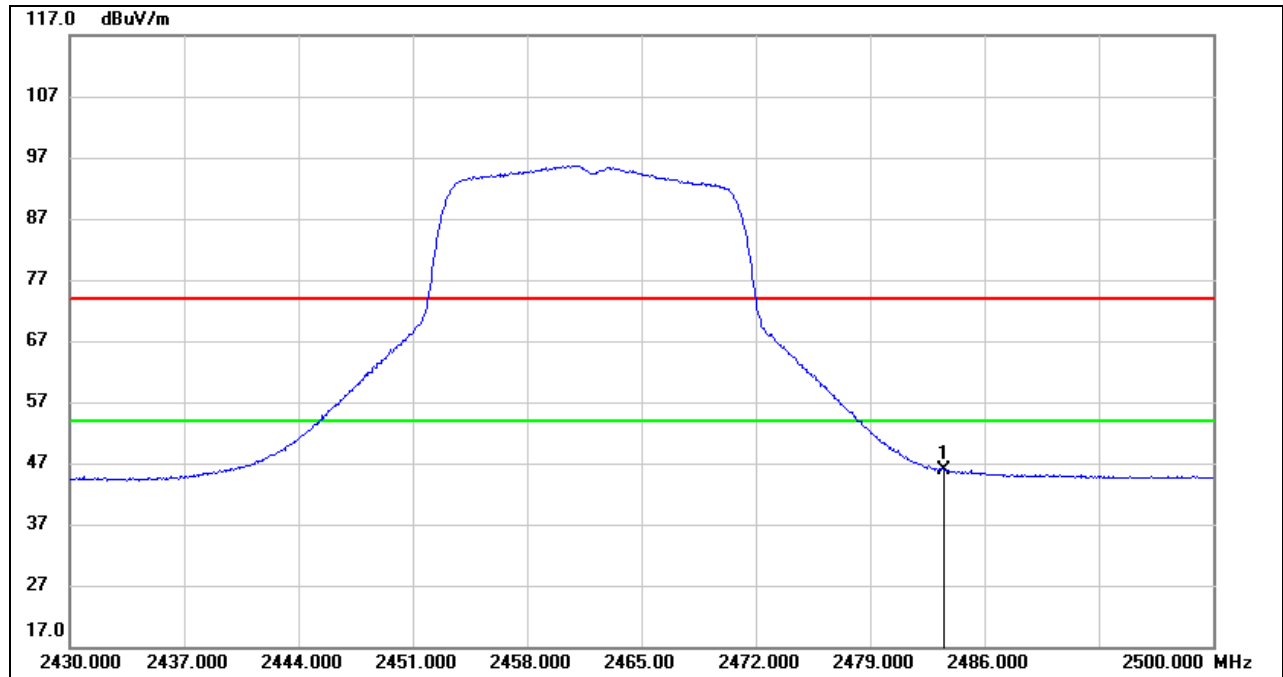

No.	Frequency (MHz)	Reading (dBuV)	Correct (dB/m)	Result (dBuV/m)	Limit (dBuV/m)	Margin (dB)	Remark
1	2483.500	12.83	33.10	45.93	54.00	-8.07	AVG

- Note: 1. Measurement = Reading Level + Correct Factor.  
 2. AVG:  $VBW=1/Ton$ , where: Ton is the transmitting duration.  
 3. For the transmitting duration, please refer to clause 7.1.  
 4. Only the worst data was recorded, if it complies with the limit, the other emissions deemed to comply with the limit.

Note: All the polarities (Vertical & Horizontal) had been tested, only the worst data was recorded in the report.

8.1.4. 802.11n HT40 MODE

RESTRICTED BANDEDGE (LOW CHANNEL, HORIZONTAL)

PEAK

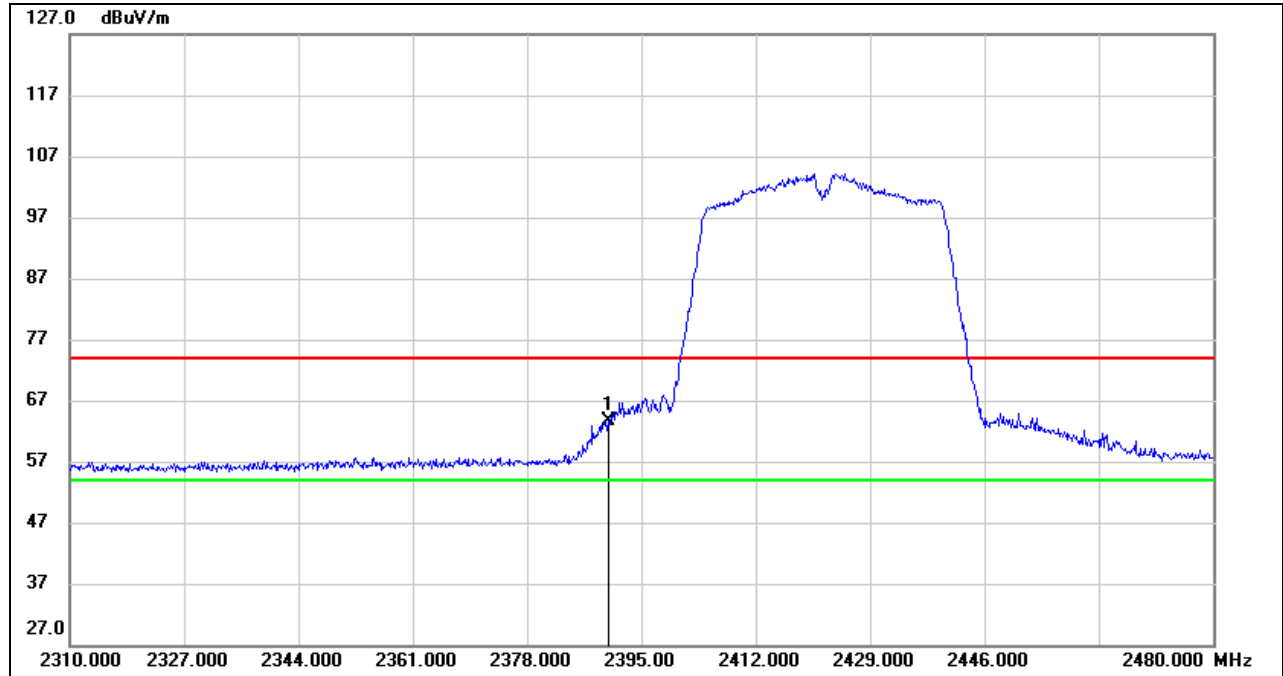

No.	Frequency (MHz)	Reading (dBuV)	Correct (dB/m)	Result (dBuV/m)	Limit (dBuV/m)	Margin (dB)	Remark
1	2390.000	30.93	32.66	63.59	74.00	-10.41	peak

Note: 1. Measurement = Reading Level + Correct Factor.  
 2. Peak: Peak detector.  
 3. Only the worst data was recorded, if it complies with the limit, the other emissions deemed to comply with the limit.

**AVG**

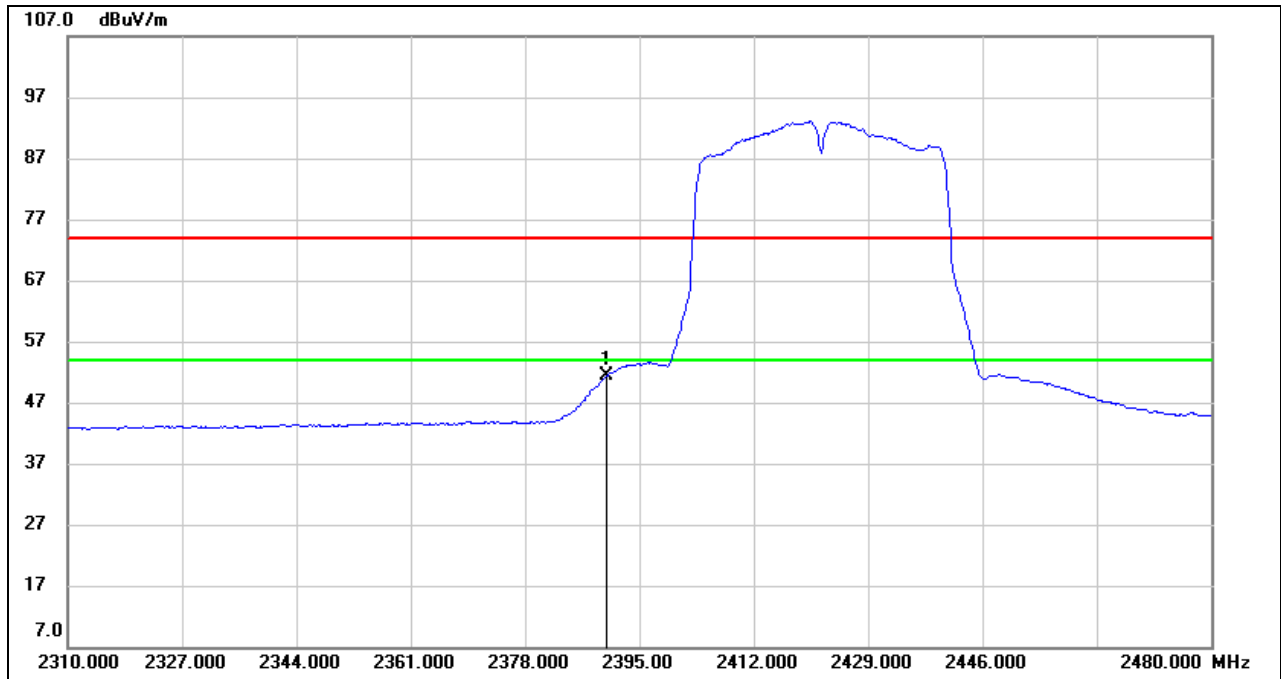

No.	Frequency (MHz)	Reading (dBuV)	Correct (dB/m)	Result (dBuV/m)	Limit (dBuV/m)	Margin (dB)	Remark
1	2390.000	18.70	32.66	51.36	54.00	-2.64	AVG

- Note:
1. Measurement = Reading Level + Correct Factor.
  2. AVG:  $VBW=1/Ton$ , where:  $Ton$  is the transmitting duration.
  3. For the transmitting duration, please refer to clause 7.1.
  4. Only the worst data was recorded, if it complies with the limit, the other emissions deemed to comply with the limit.



**RESTRICTED BANDEDGE (HIGH CHANNEL, HORIZONTAL)**

**PEAK**

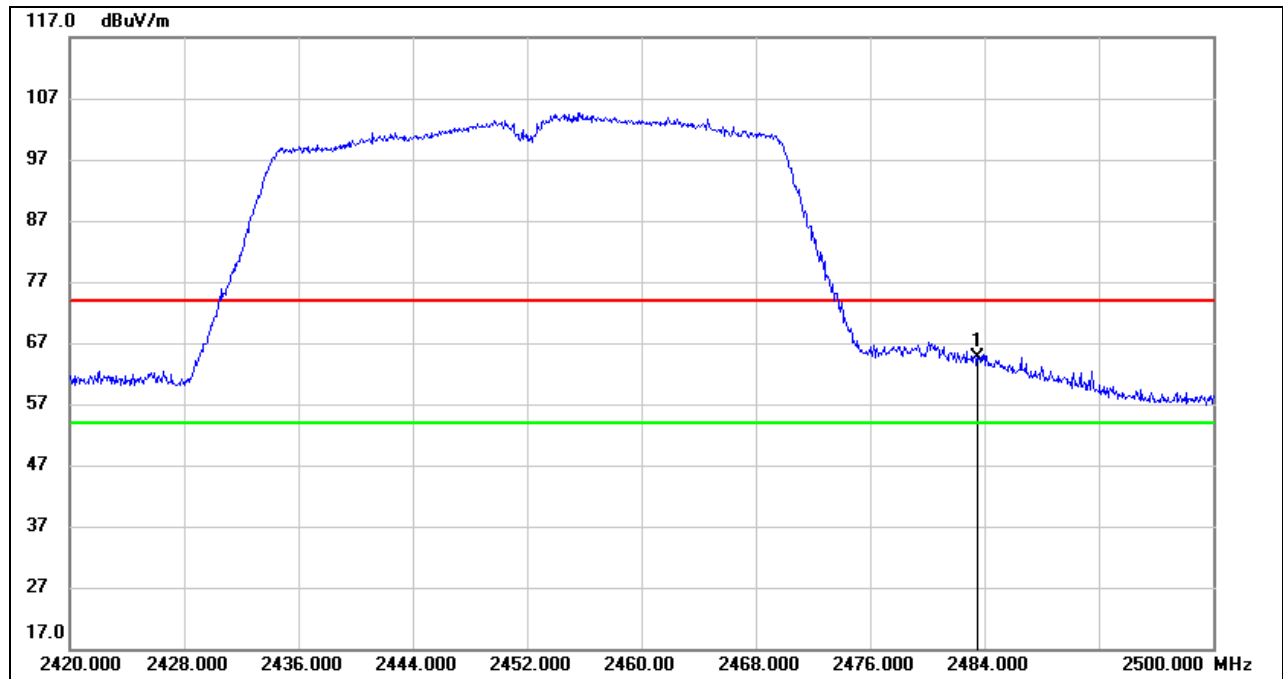

No.	Frequency (MHz)	Reading (dBuV)	Correct (dB/m)	Result (dBuV/m)	Limit (dBuV/m)	Margin (dB)	Remark
1	2483.500	31.50	33.10	64.60	74.00	-9.40	peak

Note: 1. Measurement = Reading Level + Correct Factor.  
 2. Peak: Peak detector.  
 3. Only the worst data was recorded, if it complies with the limit, the other emissions deemed to comply with the limit.



**AVG**

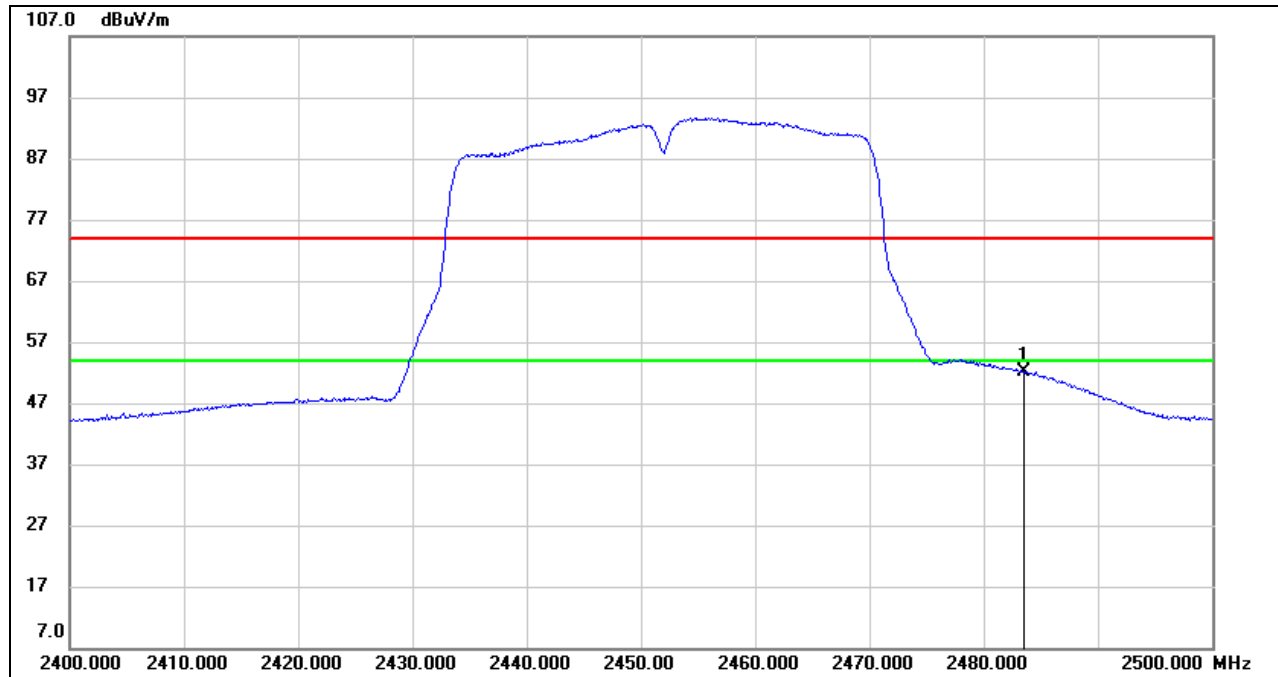

No.	Frequency (MHz)	Reading (dBuV)	Correct (dB/m)	Result (dBuV/m)	Limit (dBuV/m)	Margin (dB)	Remark
1	2483.500	18.98	33.10	52.08	54.00	-1.92	AVG

- Note: 1. Measurement = Reading Level + Correct Factor.  
 2. AVG:  $VBW=1/T_{on}$ , where:  $T_{on}$  is the transmitting duration.  
 3. For the transmitting duration, please refer to clause 7.1.  
 4. Only the worst data was recorded, if it complies with the limit, the other emissions deemed to comply with the limit.

Note: All the polarities (Vertical & Horizontal) had been tested, only the worst data was recorded in the report.

## 8.2. SPURIOUS EMISSIONS (1 GHz ~ 3 GHz)

### 8.2.1. 802.11b MODE

#### HARMONICS AND SPURIOUS EMISSIONS (LOW CHANNEL, HORIZONTAL)

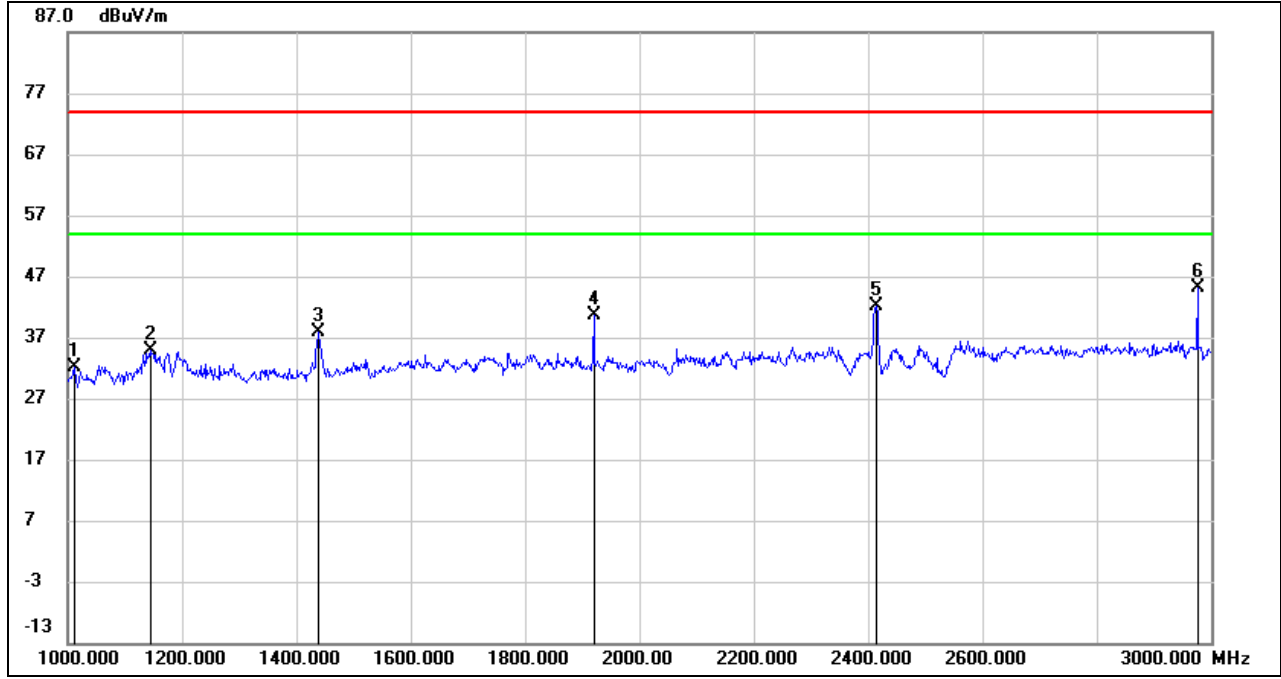

No.	Frequency (MHz)	Reading (dBuV)	Correct (dB/m)	Result (dBuV/m)	Limit (dBuV/m)	Margin (dB)	Remark
1	1012.000	47.18	-14.98	32.20	74.00	-41.80	peak
2	1144.000	48.99	-14.09	34.90	74.00	-39.10	peak
3	1438.000	50.76	-12.81	37.95	74.00	-36.05	peak
4	1920.000	51.49	-10.81	40.68	74.00	-33.32	peak
5	2412.000	51.05	-8.91	42.14	/	/	Fundamental
6	2976.000	52.24	-7.19	45.05	74.00	-28.95	peak

- Note: 1. Measurement = Reading Level + Correct Factor.  
 2. If Peak Result complies with AV limit, AV Result is deemed to comply with AV limit.  
 3. Peak: Peak detector.  
 4. Filter losses were only considered in the spurious frequency bands and the authorized band was not corrected for Band reject filter losses.  
 5. Proper operation of the transmitter prior to adding the filter to the measurement chain.



**HARMONICS AND SPURIOUS EMISSIONS (LOW CHANNEL, VERTICAL)**

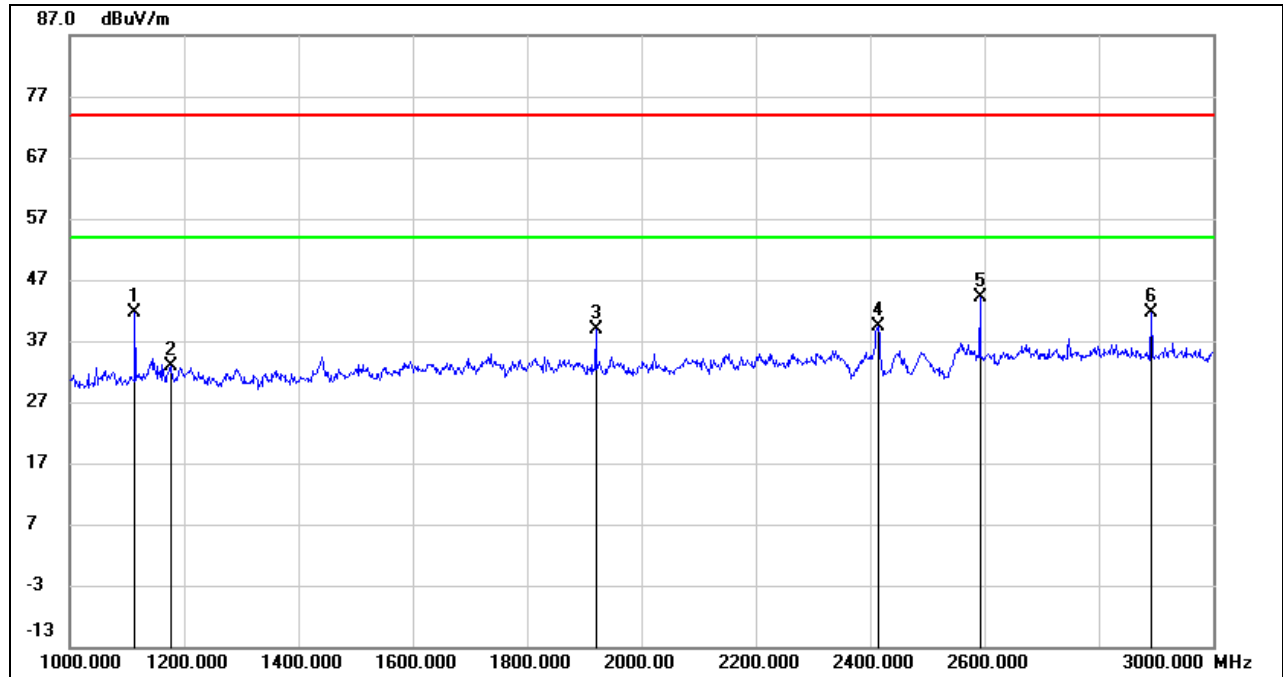

No.	Frequency (MHz)	Reading (dBuV)	Correct (dB/m)	Result (dBuV/m)	Limit (dBuV/m)	Margin (dB)	Remark
1	1114.000	55.82	-14.29	41.53	74.00	-32.47	peak
2	1176.000	46.69	-13.87	32.82	74.00	-41.18	peak
3	1920.000	49.59	-10.81	38.78	74.00	-35.22	peak
4	2412.000	48.23	-8.91	39.32	/	/	Fundamental
5	2592.000	52.79	-8.58	44.21	74.00	-29.79	peak
6	2892.000	49.05	-7.42	41.63	74.00	-32.37	peak

- Note: 1. Measurement = Reading Level + Correct Factor.  
 2. If Peak Result complies with AV limit, AV Result is deemed to comply with AV limit.  
 3. Peak: Peak detector.  
 4. Filter losses were only considered in the spurious frequency bands and the authorized band was not corrected for Band reject filter losses.  
 5. Proper operation of the transmitter prior to adding the filter to the measurement chain.



**HARMONICS AND SPURIOUS EMISSIONS (MID CHANNEL, HORIZONTAL)**

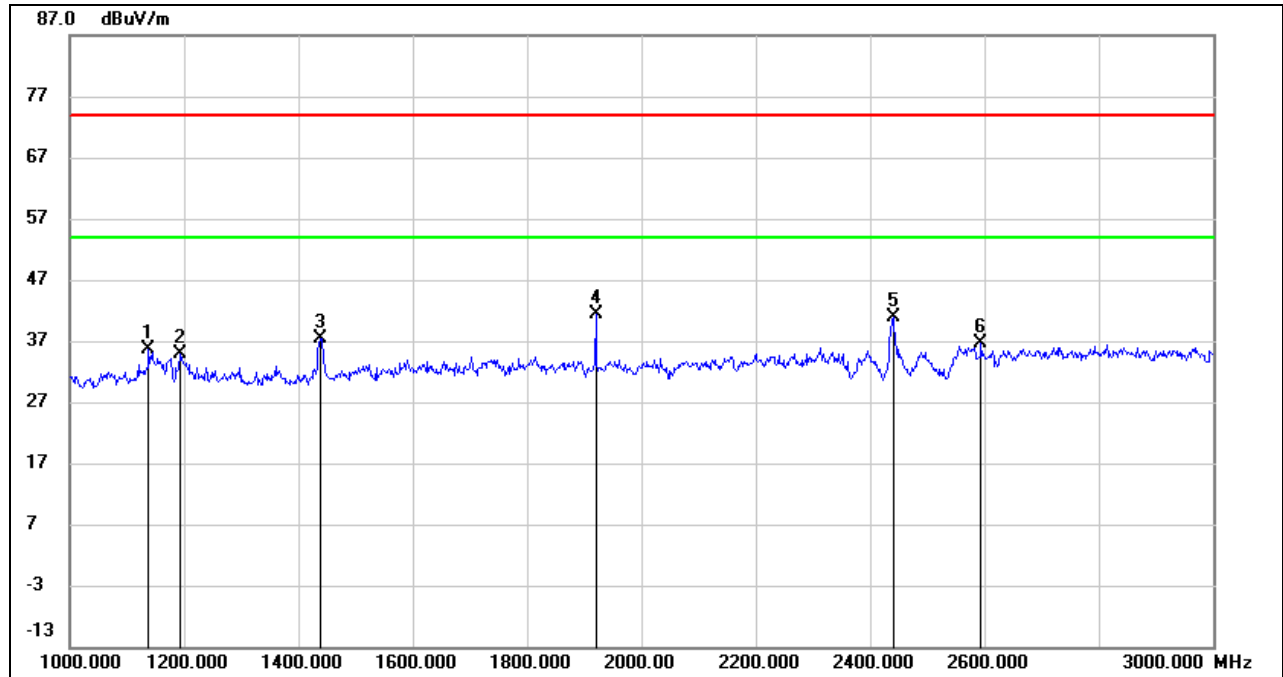

No.	Frequency (MHz)	Reading (dBuV)	Correct (dB/m)	Result (dBuV/m)	Limit (dBuV/m)	Margin (dB)	Remark
1	1138.000	49.64	-14.13	35.51	74.00	-38.49	peak
2	1194.000	48.56	-13.75	34.81	74.00	-39.19	peak
3	1438.000	50.20	-12.81	37.39	74.00	-36.61	peak
4	1920.000	52.14	-10.81	41.33	74.00	-32.67	peak
5	2437.000	49.70	-8.86	40.84	/	/	Fundamental
6	2594.000	45.16	-8.57	36.59	74.00	-37.41	peak

- Note: 1. Measurement = Reading Level + Correct Factor.  
 2. If Peak Result complies with AV limit, AV Result is deemed to comply with AV limit.  
 3. Peak: Peak detector.  
 4. Filter losses were only considered in the spurious frequency bands and the authorized band was not corrected for Band reject filter losses.  
 5. Proper operation of the transmitter prior to adding the filter to the measurement chain.





**HARMONICS AND SPURIOUS EMISSIONS (MID CHANNEL, VERTICAL)**

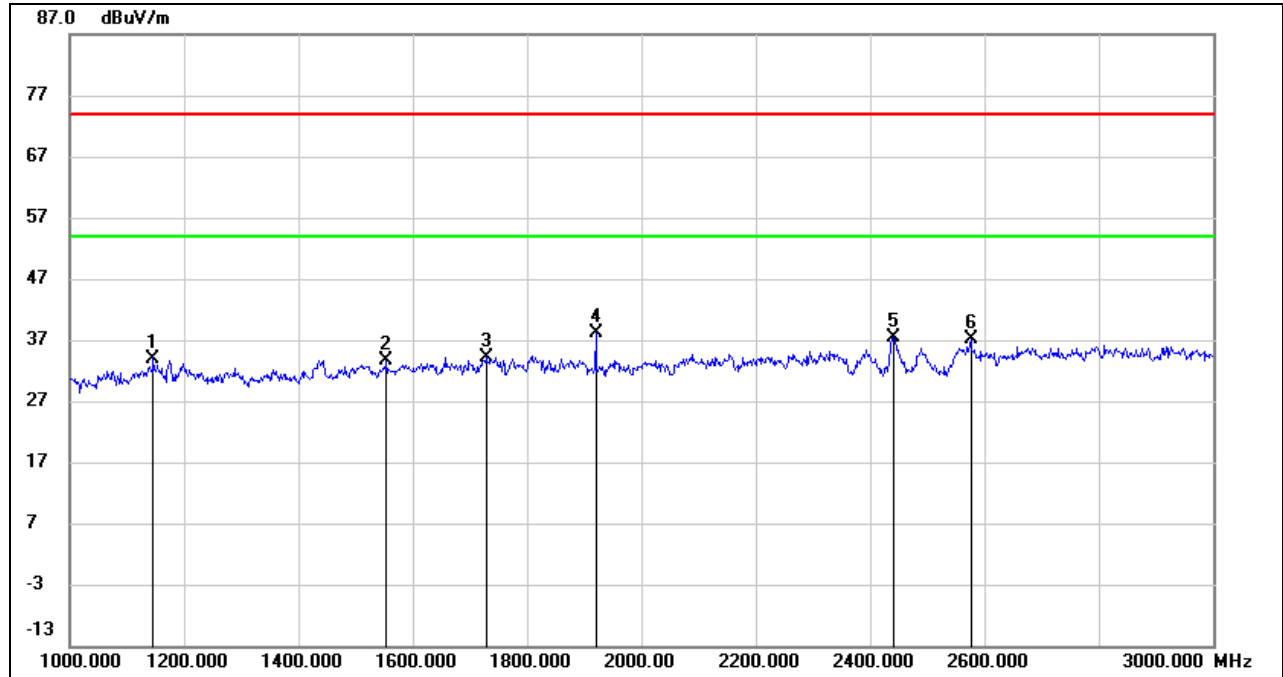

No.	Frequency (MHz)	Reading (dBuV)	Correct (dB/m)	Result (dBuV/m)	Limit (dBuV/m)	Margin (dB)	Remark
1	1146.000	48.07	-14.07	34.00	74.00	-40.00	peak
2	1554.000	45.75	-12.10	33.65	74.00	-40.35	peak
3	1728.000	45.26	-11.03	34.23	74.00	-39.77	peak
4	1920.000	48.99	-10.81	38.18	74.00	-35.82	peak
5	2437.000	46.34	-8.85	37.49	/	/	Fundamental
6	2576.000	45.62	-8.61	37.01	74.00	-36.99	peak

- Note: 1. Measurement = Reading Level + Correct Factor.  
 2. If Peak Result complies with AV limit, AV Result is deemed to comply with AV limit.  
 3. Peak: Peak detector.  
 4. Filter losses were only considered in the spurious frequency bands and the authorized band was not corrected for Band reject filter losses.  
 5. Proper operation of the transmitter prior to adding the filter to the measurement chain.

**HARMONICS AND SPURIOUS EMISSIONS (HIGH CHANNEL, HORIZONTAL)**

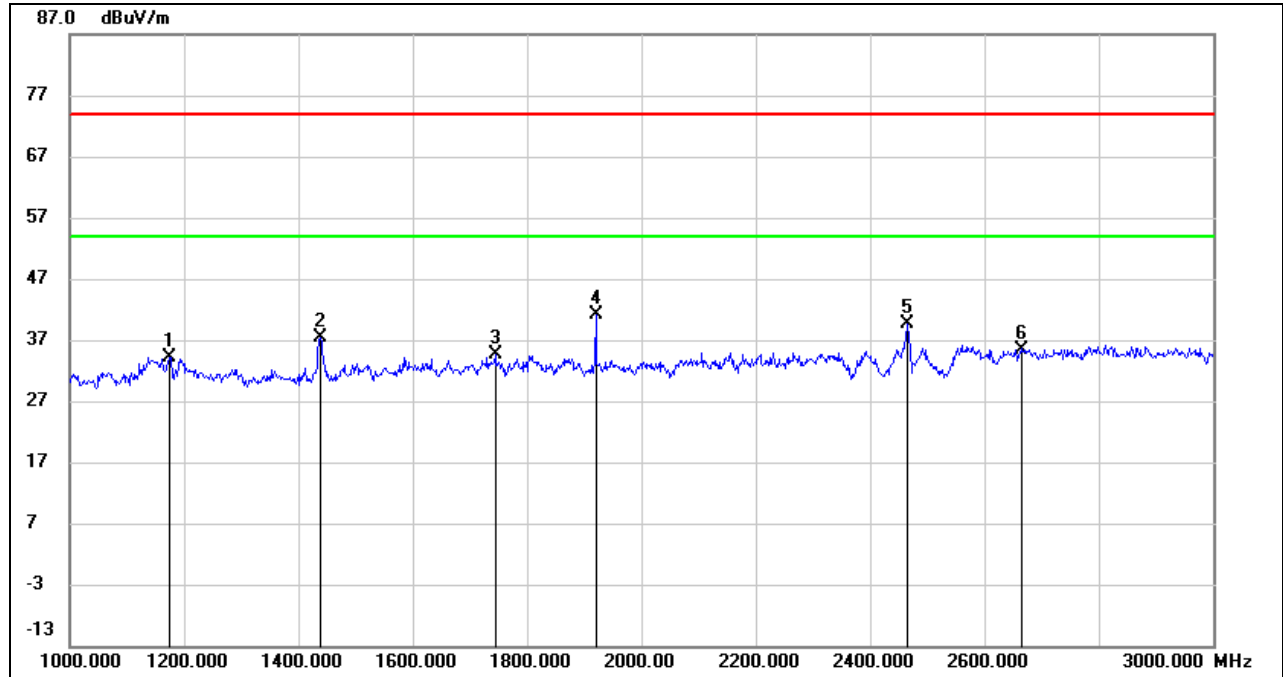

No.	Frequency (MHz)	Reading (dBuV)	Correct (dB/m)	Result (dBuV/m)	Limit (dBuV/m)	Margin (dB)	Remark
1	1174.000	47.94	-13.89	34.05	74.00	-39.95	peak
2	1438.000	50.29	-12.81	37.48	74.00	-36.52	peak
3	1744.000	45.59	-10.93	34.66	74.00	-39.34	peak
4	1920.000	52.06	-10.81	41.25	74.00	-32.75	peak
5	2462.000	48.42	-8.80	39.62	/	/	Fundamental
6	2664.000	43.78	-8.28	35.50	74.00	-38.50	peak

- Note: 1. Measurement = Reading Level + Correct Factor.  
 2. If Peak Result complies with AV limit, AV Result is deemed to comply with AV limit.  
 3. Peak: Peak detector.  
 4. Filter losses were only considered in the spurious frequency bands and the authorized band was not corrected for Band reject filter losses.  
 5. Proper operation of the transmitter prior to adding the filter to the measurement chain.



**HARMONICS AND SPURIOUS EMISSIONS (HIGH CHANNEL, VERTICAL)**

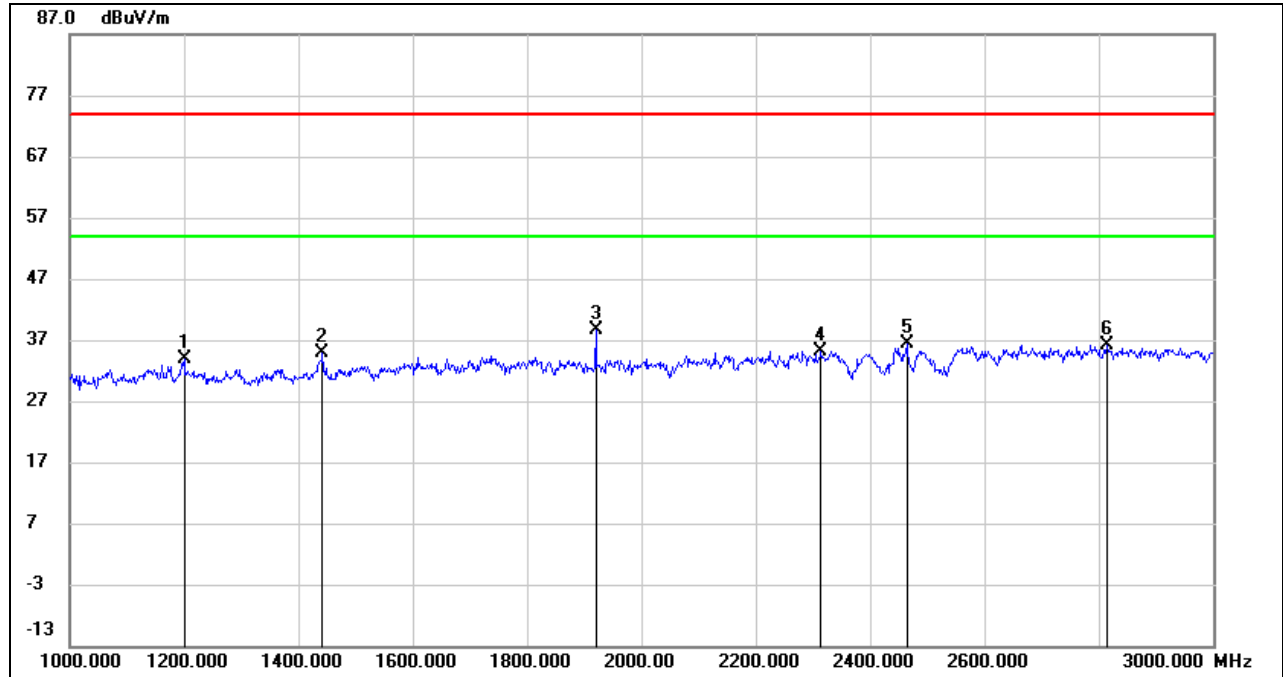

No.	Frequency (MHz)	Reading (dBuV)	Correct (dB/m)	Result (dBuV/m)	Limit (dBuV/m)	Margin (dB)	Remark
1	1200.000	47.63	-13.71	33.92	74.00	-40.08	peak
2	1442.000	47.55	-12.79	34.76	74.00	-39.24	peak
3	1920.000	49.56	-10.81	38.75	74.00	-35.25	peak
4	2314.000	44.46	-9.27	35.19	74.00	-38.81	peak
5	2462.000	45.06	-8.80	36.26	/	/	Fundamental
6	2814.000	43.76	-7.63	36.13	74.00	-37.87	peak

- Note: 1. Measurement = Reading Level + Correct Factor.  
 2. If Peak Result complies with AV limit, AV Result is deemed to comply with AV limit.  
 3. Peak: Peak detector.  
 4. Filter losses were only considered in the spurious frequency bands and the authorized band was not corrected for Band reject filter losses.  
 5. Proper operation of the transmitter prior to adding the filter to the measurement chain.

Note: All the modes and channels had been tested, but only the worst data was recorded in the report.

### 8.3. SPURIOUS EMISSIONS (3 GHz ~ 18 GHz)

#### 8.3.1. 802.11b MODE

##### HARMONICS AND SPURIOUS EMISSIONS (LOW CHANNEL, HORIZONTAL)

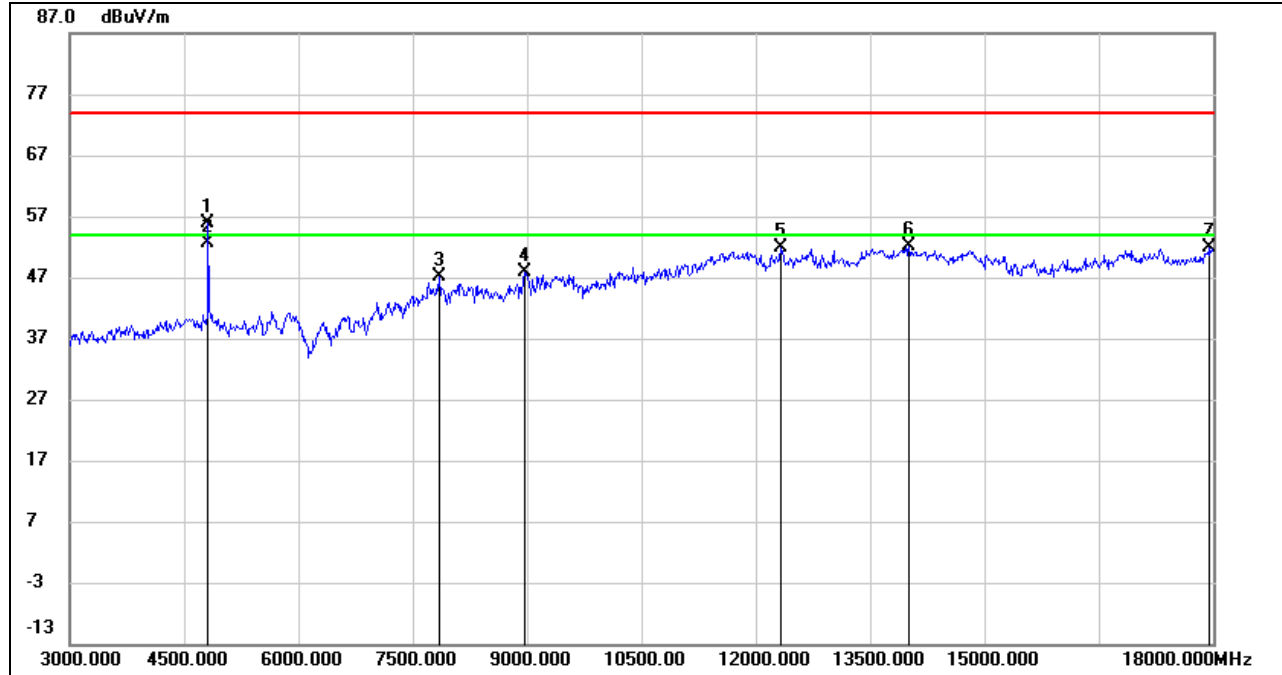

No.	Frequency (MHz)	Reading (dBuV)	Correct (dB/m)	Result (dBuV/m)	Limit (dBuV/m)	Margin (dB)	Remark
1	4815.000	56.31	-0.37	55.94	74.00	-18.06	peak
2	4815.000	53.02	-0.37	52.65	54.00	-1.35	AVG
3	7845.000	40.18	6.94	47.12	74.00	-26.88	peak
4	8970.000	38.24	9.55	47.79	74.00	-26.21	peak
5	12330.000	34.23	17.62	51.85	74.00	-22.15	peak
6	14010.000	30.62	21.40	52.02	74.00	-21.98	peak
7	17955.000	26.80	24.98	51.78	74.00	-22.22	peak

Note: 1. Peak Result = Reading Level + Correct Factor.

2. If Peak Result complies with AV limit, AV Result is deemed to comply with AV limit.

3. Peak: Peak detector.

4. AVG:  $VBW=1/Ton$ , where: Ton is the transmitting duration.

5. For the transmitting duration, please refer to clause 7.1.

6. Filter losses were only considered in the spurious frequency bands and the authorized band was not corrected for High Pass Filter losses.

7. Proper operation of the transmitter prior to adding the filter to the measurement chain.

**HARMONICS AND SPURIOUS EMISSIONS (LOW CHANNEL, VERTICAL)**

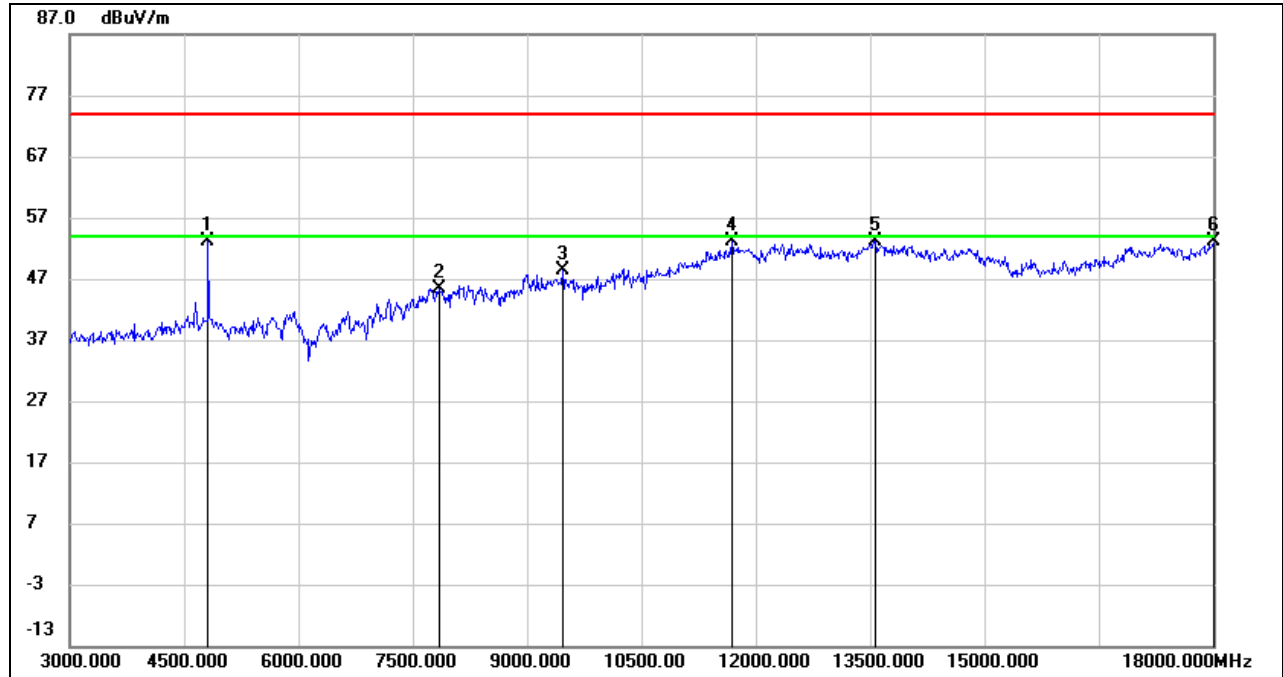

No.	Frequency (MHz)	Reading (dBuV)	Correct (dB/m)	Result (dBuV/m)	Limit (dBuV/m)	Margin (dB)	Remark
1	4815.000	53.48	-0.37	53.11	74.00	-20.89	peak
2	7845.000	38.49	6.94	45.43	74.00	-28.57	peak
3	9465.000	38.25	10.13	48.38	74.00	-25.62	peak
4	11685.000	36.28	16.76	53.04	74.00	-20.96	peak
5	13560.000	32.83	20.40	53.23	74.00	-20.77	peak
6	18000.000	27.79	25.28	53.07	74.00	-20.93	peak

- Note: 1. Peak Result = Reading Level + Correct Factor.  
 2. If Peak Result complies with AV limit, AV Result is deemed to comply with AV limit.  
 3. Peak: Peak detector.  
 4. Filter losses were only considered in the spurious frequency bands and the authorized band was not corrected for High Pass Filter losses.  
 5. Proper operation of the transmitter prior to adding the filter to the measurement chain.

**HARMONICS AND SPURIOUS EMISSIONS (MID CHANNEL, HORIZONTAL)**

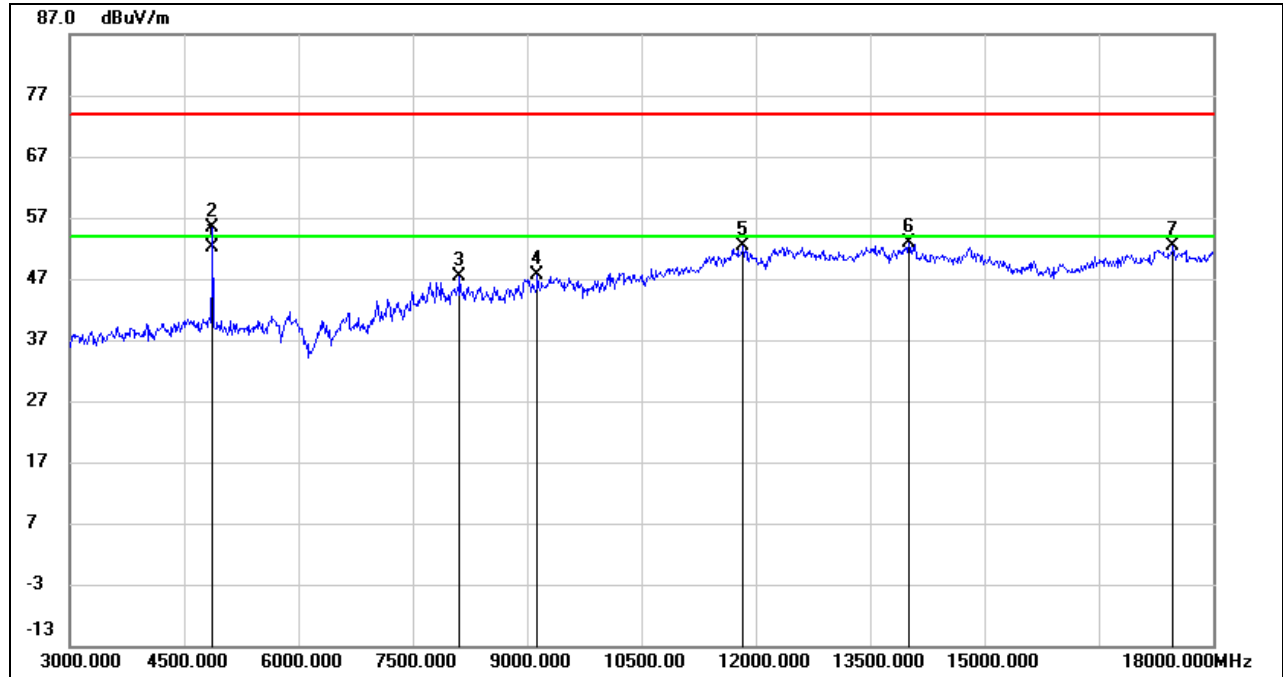

No.	Frequency (MHz)	Reading (dBuV)	Correct (dB/m)	Result (dBuV/m)	Limit (dBuV/m)	Margin (dB)	Remark
1	4875.000	52.75	-0.52	52.23	54.00	-1.77	AVG
2	4875.000	55.79	-0.52	55.27	74.00	-18.73	peak
3	8115.000	39.52	7.92	47.44	74.00	-26.56	peak
4	9135.000	38.46	9.13	47.59	74.00	-26.41	peak
5	11835.000	35.30	16.98	52.28	74.00	-21.72	peak
6	14010.000	31.42	21.40	52.82	74.00	-21.18	peak
7	17475.000	30.69	21.62	52.31	74.00	-21.69	peak

- Note: 1. Peak Result = Reading Level + Correct Factor.  
 2. If Peak Result complies with AV limit, AV Result is deemed to comply with AV limit.  
 3. Peak: Peak detector.  
 4. AVG:  $VBW=1/Ton$ , where: Ton is the transmitting duration.  
 5. For the transmitting duration, please refer to clause 7.1.  
 6. Filter losses were only considered in the spurious frequency bands and the authorized band was not corrected for High Pass Filter losses.  
 7. Proper operation of the transmitter prior to adding the filter to the measurement chain.



**HARMONICS AND SPURIOUS EMISSIONS (MID CHANNEL, VERTICAL)**

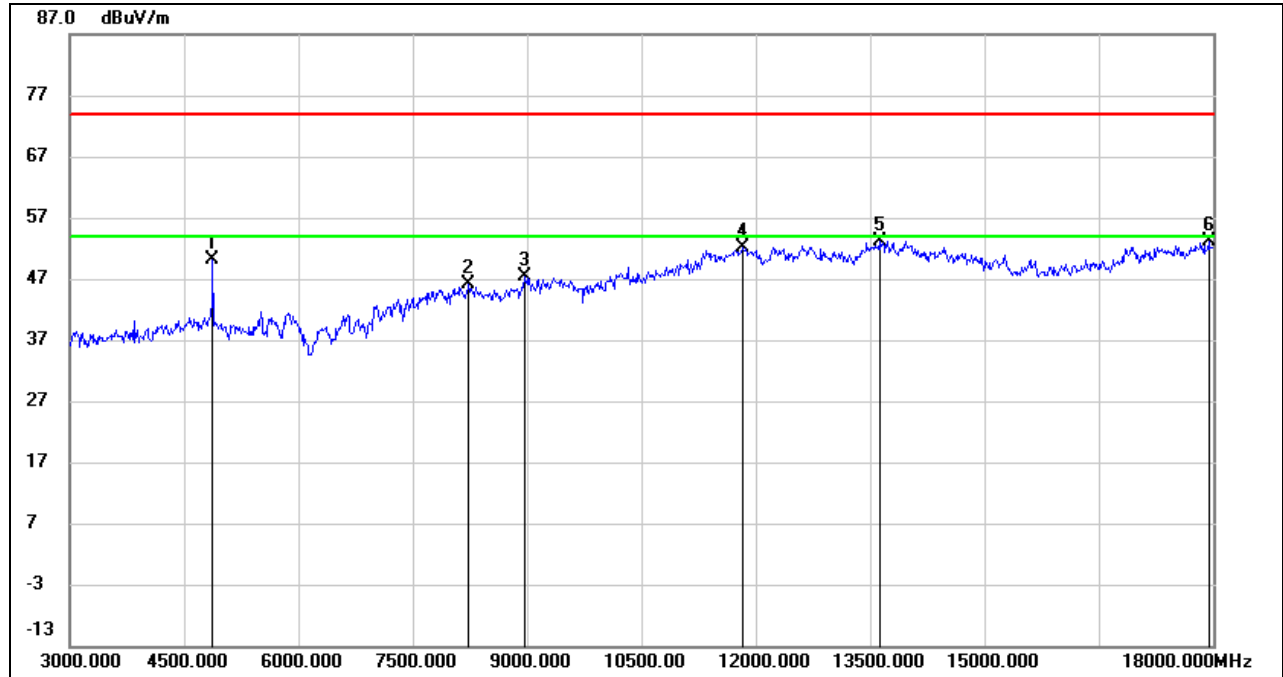

No.	Frequency (MHz)	Reading (dBuV)	Correct (dB/m)	Result (dBuV/m)	Limit (dBuV/m)	Margin (dB)	Remark
1	4875.000	50.56	-0.52	50.04	74.00	-23.96	peak
2	8235.000	38.35	7.67	46.02	74.00	-27.98	peak
3	8970.000	37.73	9.55	47.28	74.00	-26.72	peak
4	11820.000	35.27	16.92	52.19	74.00	-21.81	peak
5	13620.000	32.72	20.51	53.23	74.00	-20.77	peak
6	17940.000	28.17	24.89	53.06	74.00	-20.94	peak

- Note: 1. Peak Result = Reading Level + Correct Factor.  
 2. If Peak Result complies with AV limit, AV Result is deemed to comply with AV limit.  
 3. Peak: Peak detector.  
 4. Filter losses were only considered in the spurious frequency bands and the authorized band was not corrected for High Pass Filter losses.  
 5. Proper operation of the transmitter prior to adding the filter to the measurement chain.

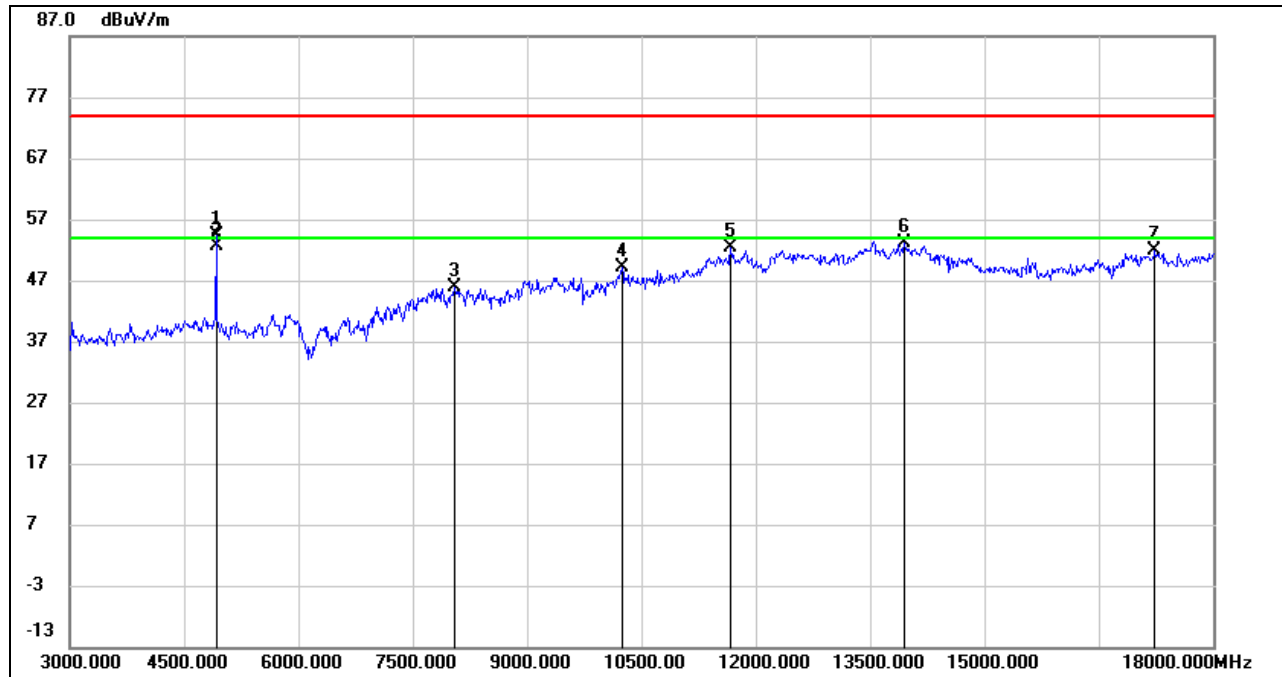
**HARMONICS AND SPURIOUS EMISSIONS (HIGH CHANNEL, HORIZONTAL)**

No.	Frequency (MHz)	Reading (dBuV)	Correct (dB/m)	Result (dBuV/m)	Limit (dBuV/m)	Margin (dB)	Remark
1	4920.000	54.85	-0.45	54.40	74.00	-19.60	peak
2	4920.000	52.98	-0.45	52.53	54.00	-1.47	AVG
3	8040.000	38.89	6.97	45.86	74.00	-28.14	peak
4	10245.000	37.36	11.76	49.12	74.00	-24.88	peak
5	11670.000	35.60	16.66	52.26	74.00	-21.74	peak
6	13950.000	31.78	21.33	53.11	74.00	-20.89	peak
7	17235.000	30.50	21.39	51.89	74.00	-22.11	peak

- Note: 1. Peak Result = Reading Level + Correct Factor.  
 2. If Peak Result complies with AV limit, AV Result is deemed to comply with AV limit.  
 3. Peak: Peak detector.  
 4. AVG:  $VBW=1/Ton$ , where: Ton is the transmitting duration.  
 5. For the transmitting duration, please refer to clause 7.1.  
 6. Filter losses were only considered in the spurious frequency bands and the authorized band was not corrected for High Pass Filter losses.  
 7. Proper operation of the transmitter prior to adding the filter to the measurement chain.



**HARMONICS AND SPURIOUS EMISSIONS (HIGH CHANNEL, VERTICAL)**

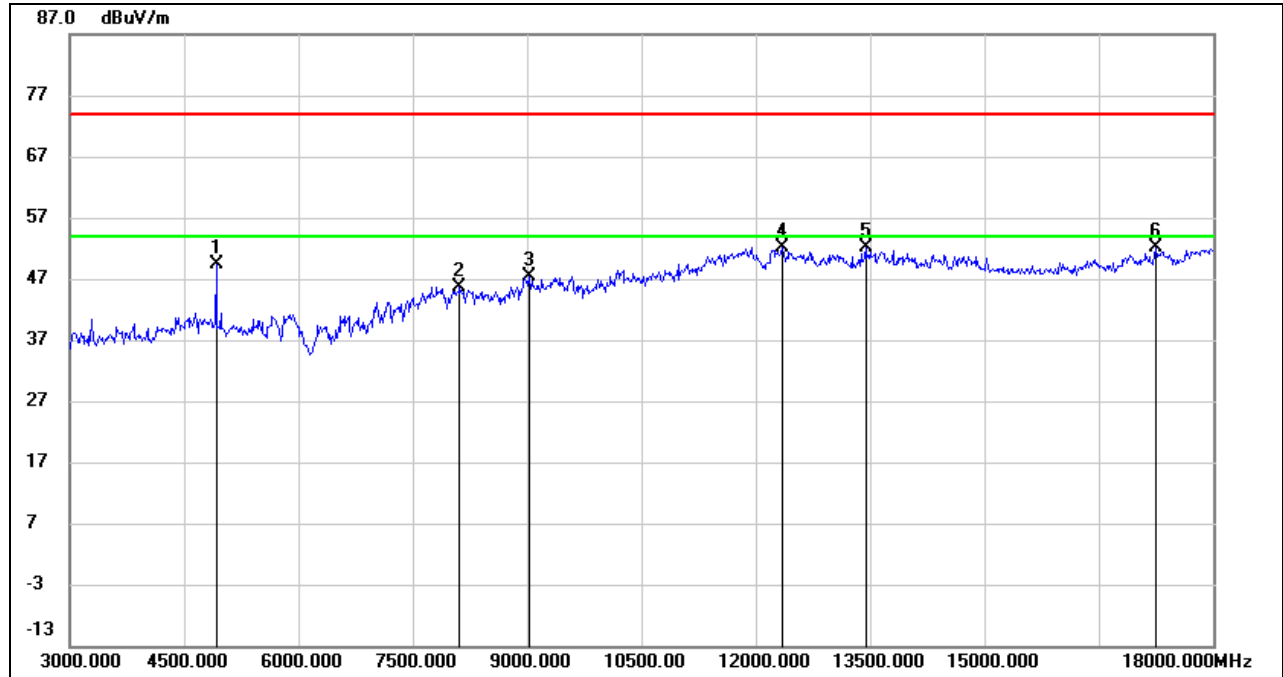

No.	Frequency (MHz)	Reading (dBuV)	Correct (dB/m)	Result (dBuV/m)	Limit (dBuV/m)	Margin (dB)	Remark
1	4920.000	49.77	-0.45	49.32	74.00	-24.68	peak
2	8115.000	37.77	7.92	45.69	74.00	-28.31	peak
3	9030.000	37.50	9.87	47.37	74.00	-26.63	peak
4	12345.000	34.52	17.59	52.11	74.00	-21.89	peak
5	13440.000	32.13	20.10	52.23	74.00	-21.77	peak
6	17250.000	30.54	21.50	52.04	74.00	-21.96	peak

- Note: 1. Peak Result = Reading Level + Correct Factor.  
 2. If Peak Result complies with AV limit, AV Result is deemed to comply with AV limit.  
 3. Peak: Peak detector.  
 4. Filter losses were only considered in the spurious frequency bands and the authorized band was not corrected for High Pass Filter losses.  
 5. Proper operation of the transmitter prior to adding the filter to the measurement chain.

### 8.3.2. 802.11g MODE

#### HARMONICS AND SPURIOUS EMISSIONS (LOW CHANNEL, HORIZONTAL)

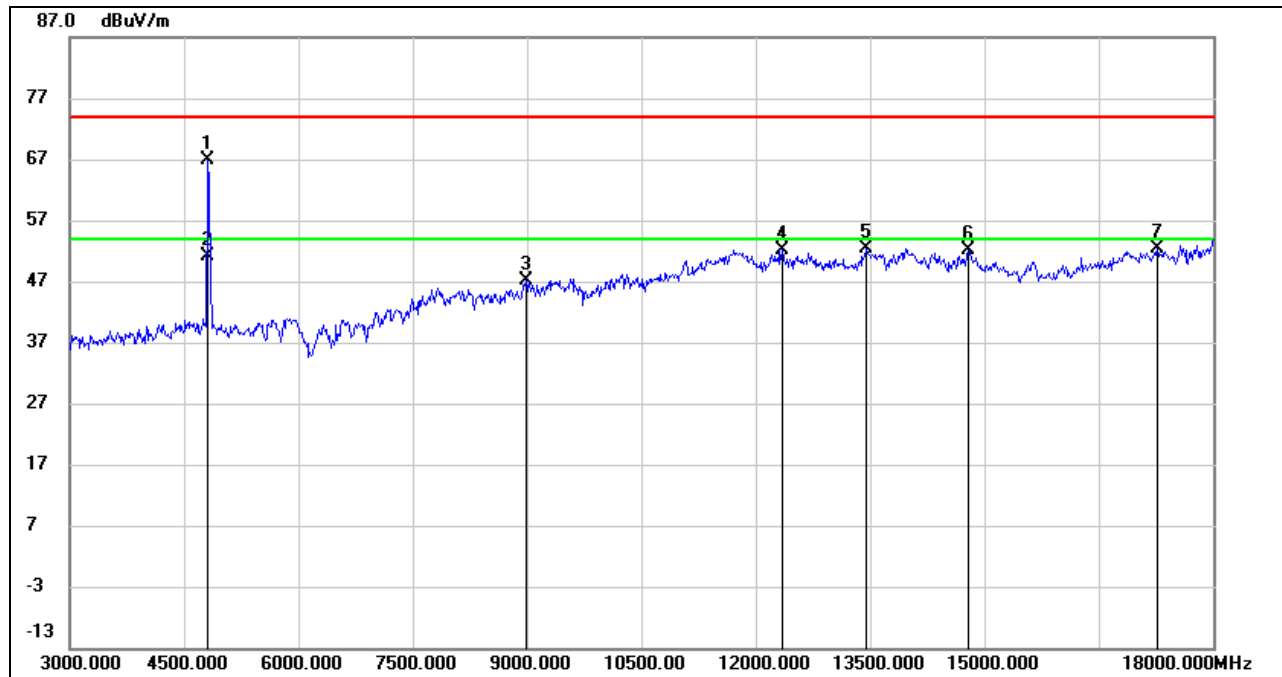

No.	Frequency (MHz)	Reading (dBuV)	Correct (dB/m)	Result (dBuV/m)	Limit (dBuV/m)	Margin (dB)	Remark
1	4815.000	67.37	-0.37	67.00	74.00	-7.00	peak
2	4815.000	51.60	-0.37	51.23	54.00	-2.77	AVG
3	8992.500	37.12	10.01	47.13	74.00	-26.87	peak
4	12345.000	34.61	17.59	52.20	74.00	-21.80	peak
5	13462.500	32.17	20.21	52.38	74.00	-21.62	peak
6	14790.000	33.70	18.52	52.22	74.00	-21.78	peak
7	17272.500	30.60	21.67	52.27	74.00	-21.73	peak

Note: 1. Peak Result = Reading Level + Correct Factor.

2. If Peak Result complies with AV limit, AV Result is deemed to comply with AV limit.

3. Peak: Peak detector.

4. AVG:  $VBW=1/Ton$ , where: Ton is the transmitting duration.

5. For the transmitting duration, please refer to clause 7.1.

6. Filter losses were only considered in the spurious frequency bands and the authorized band was not corrected for High Pass Filter losses.

7. Proper operation of the transmitter prior to adding the filter to the measurement chain.

**HARMONICS AND SPURIOUS EMISSIONS (LOW CHANNEL, VERTICAL)**

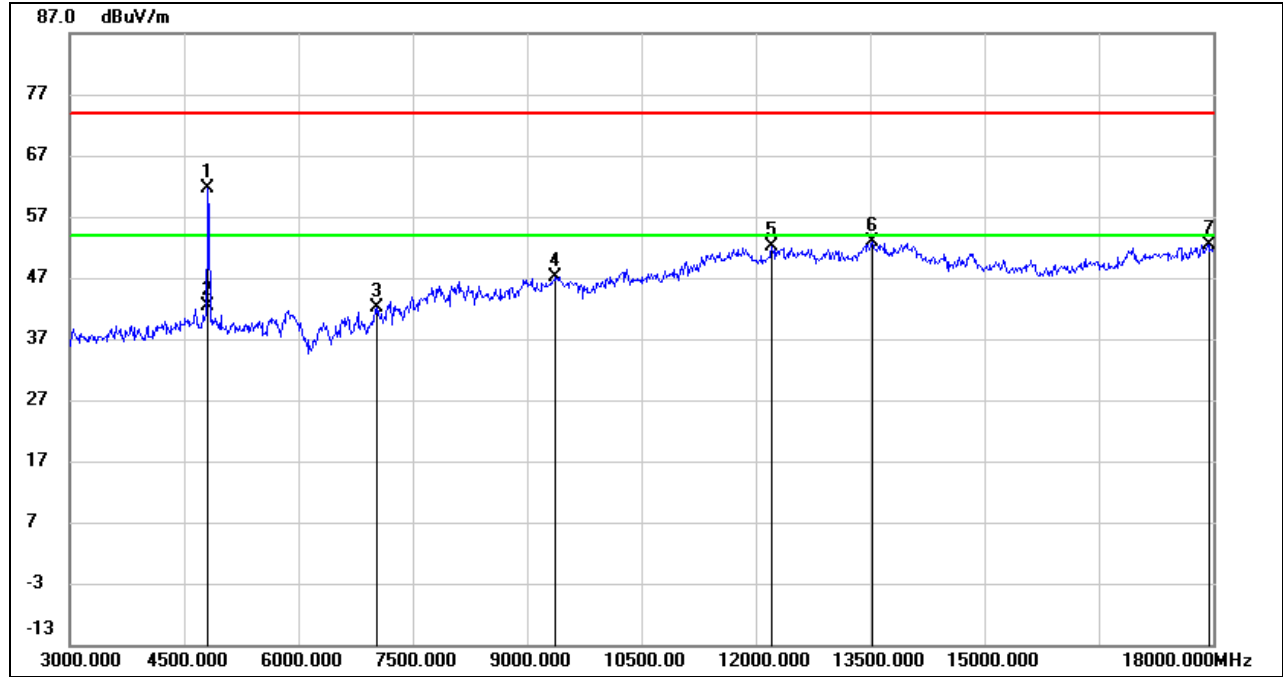

No.	Frequency (MHz)	Reading (dBuV)	Correct (dB/m)	Result (dBuV/m)	Limit (dBuV/m)	Margin (dB)	Remark
1	4815.000	61.89	-0.37	61.52	74.00	-12.48	peak
2	4815.000	42.69	-0.37	42.32	54.00	-11.68	AVG
3	7035.000	36.22	5.80	42.02	74.00	-31.98	peak
4	9375.000	36.88	10.17	47.05	74.00	-26.95	peak
5	12217.500	34.40	17.62	52.02	74.00	-21.98	peak
6	13530.000	32.50	20.39	52.89	74.00	-21.11	peak
7	17947.500	27.44	24.95	52.39	74.00	-21.61	peak

- Note: 1. Peak Result = Reading Level + Correct Factor.  
 2. If Peak Result complies with AV limit, AV Result is deemed to comply with AV limit.  
 3. Peak: Peak detector.  
 4. AVG: VBW=1/Ton, where: Ton is the transmitting duration.  
 5. For the transmitting duration, please refer to clause 7.1.  
 6. Filter losses were only considered in the spurious frequency bands and the authorized band was not corrected for High Pass Filter losses.  
 7. Proper operation of the transmitter prior to adding the filter to the measurement chain.



**HARMONICS AND SPURIOUS EMISSIONS (MID CHANNEL, HORIZONTAL)**

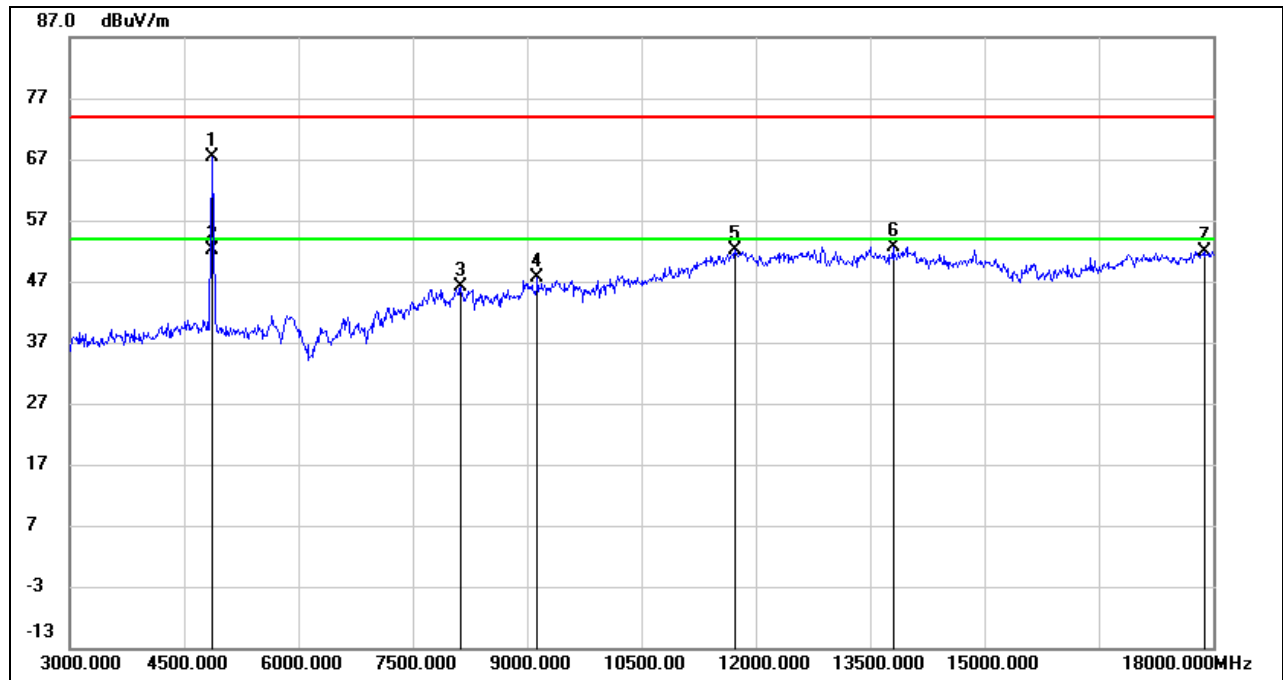

No.	Frequency (MHz)	Reading (dBuV)	Correct (dB/m)	Result (dBuV/m)	Limit (dBuV/m)	Margin (dB)	Remark
1	4875.000	67.96	-0.52	67.44	74.00	-6.56	peak
2	4875.000	52.75	-0.52	52.23	54.00	-1.77	AVG
3	8130.000	38.18	7.87	46.05	74.00	-27.95	peak
4	9135.000	38.45	9.13	47.58	74.00	-26.42	peak
5	11737.500	35.31	16.86	52.17	74.00	-21.83	peak
6	13800.000	31.50	21.15	52.65	74.00	-21.35	peak
7	17887.500	27.35	24.62	51.97	74.00	-22.03	peak

- Note: 1. Peak Result = Reading Level + Correct Factor.  
 2. If Peak Result complies with AV limit, AV Result is deemed to comply with AV limit.  
 3. Peak: Peak detector.  
 4. AVG:  $VBW=1/Ton$ , where: Ton is the transmitting duration.  
 5. For the transmitting duration, please refer to clause 7.1.  
 6. Filter losses were only considered in the spurious frequency bands and the authorized band was not corrected for High Pass Filter losses.  
 7. Proper operation of the transmitter prior to adding the filter to the measurement chain.

**HARMONICS AND SPURIOUS EMISSIONS (MID CHANNEL, VERTICAL)**

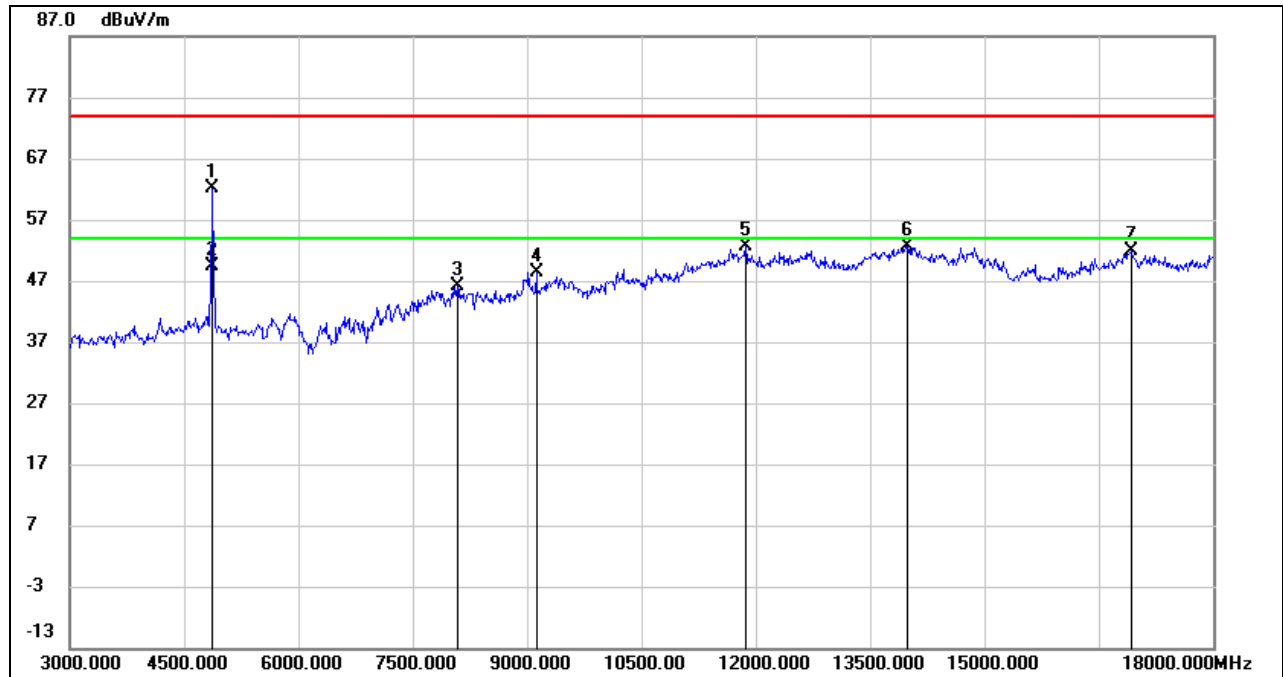

No.	Frequency (MHz)	Reading (dBuV)	Correct (dB/m)	Result (dBuV/m)	Limit (dBuV/m)	Margin (dB)	Remark
1	4875.000	62.65	-0.52	62.13	74.00	-11.87	peak
2	4875.000	49.87	-0.52	49.35	54.00	-4.65	AVG
3	8085.000	38.37	7.71	46.08	74.00	-27.92	peak
4	9127.500	39.24	9.13	48.37	74.00	-25.63	peak
5	11872.500	35.57	17.11	52.68	74.00	-21.32	peak
6	13995.000	31.26	21.44	52.70	74.00	-21.30	peak
7	16935.000	31.69	20.12	51.81	74.00	-22.19	peak

- Note: 1. Peak Result = Reading Level + Correct Factor.  
 2. If Peak Result complies with AV limit, AV Result is deemed to comply with AV limit.  
 3. Peak: Peak detector.  
 4. AVG:  $VBW=1/Ton$ , where: Ton is the transmitting duration.  
 5. For the transmitting duration, please refer to clause 7.1.  
 6. Filter losses were only considered in the spurious frequency bands and the authorized band was not corrected for High Pass Filter losses.  
 7. Proper operation of the transmitter prior to adding the filter to the measurement chain.

### HARMONICS AND SPURIOUS EMISSIONS (HIGH CHANNEL, HORIZONTAL)

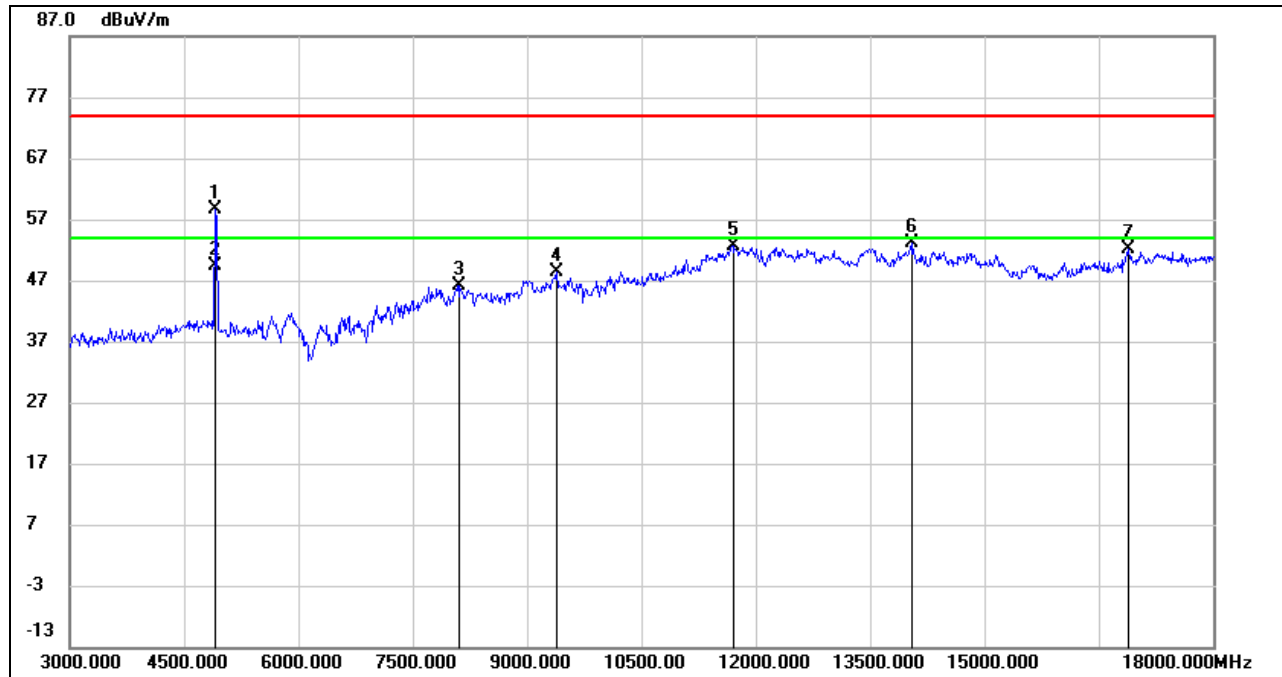

No.	Frequency (MHz)	Reading (dBuV)	Correct (dB/m)	Result (dBuV/m)	Limit (dBuV/m)	Margin (dB)	Remark
1	4912.500	59.19	-0.50	58.69	74.00	-15.31	peak
2	4912.500	49.85	-0.50	49.35	54.00	-4.65	AVG
3	8115.000	38.17	7.92	46.09	74.00	-27.91	peak
4	9397.500	37.95	10.33	48.28	74.00	-25.72	peak
5	11707.500	35.74	16.87	52.61	74.00	-21.39	peak
6	14055.000	31.95	21.11	53.06	74.00	-20.94	peak
7	16897.500	31.84	20.17	52.01	74.00	-21.99	peak

- Note: 1. Peak Result = Reading Level + Correct Factor.  
 2. If Peak Result complies with AV limit, AV Result is deemed to comply with AV limit.  
 3. Peak: Peak detector.  
 4. AVG:  $VBW=1/Ton$ , where: Ton is the transmitting duration.  
 5. For the transmitting duration, please refer to clause 7.1.  
 6. Filter losses were only considered in the spurious frequency bands and the authorized band was not corrected for High Pass Filter losses.  
 7. Proper operation of the transmitter prior to adding the filter to the measurement chain.



**HARMONICS AND SPURIOUS EMISSIONS (HIGH CHANNEL, VERTICAL)**

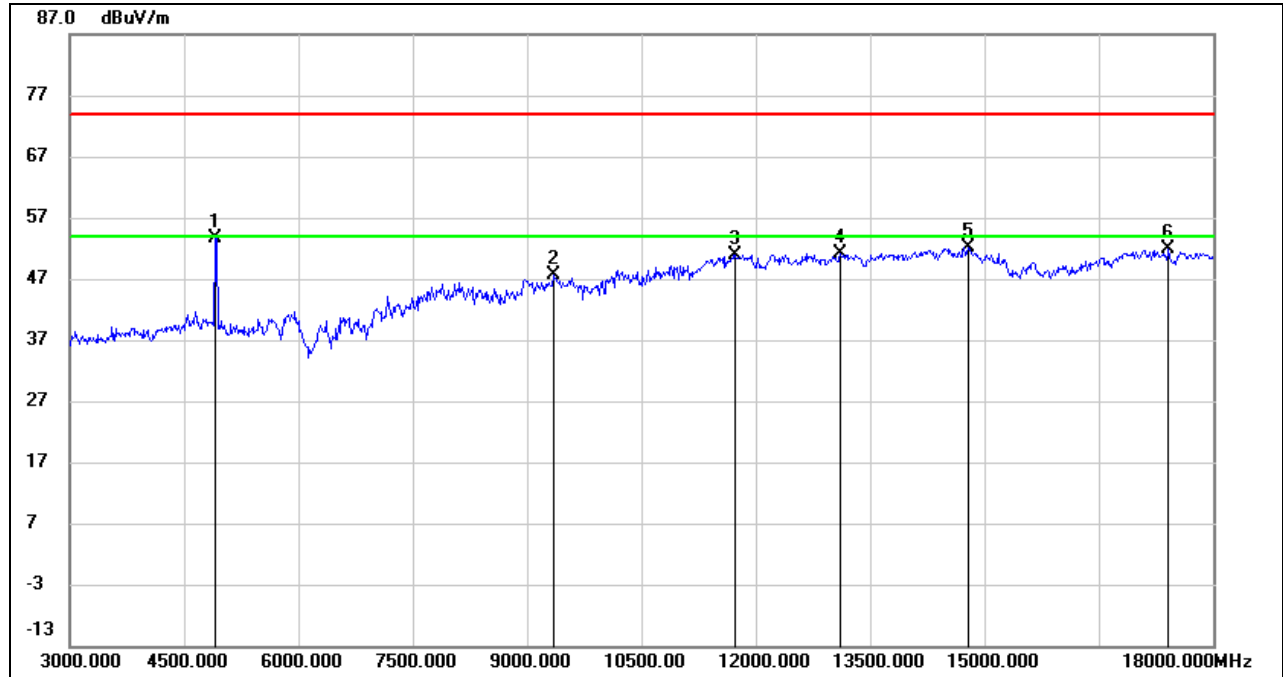

No.	Frequency (MHz)	Reading (dBuV)	Correct (dB/m)	Result (dBuV/m)	Limit (dBuV/m)	Margin (dB)	Remark
1	4912.500	54.20	-0.50	53.70	74.00	-20.30	peak
2	9345.000	37.58	9.96	47.54	74.00	-26.46	peak
3	11737.500	34.09	16.86	50.95	74.00	-23.05	peak
4	13117.500	33.04	18.12	51.16	74.00	-22.84	peak
5	14790.000	33.54	18.52	52.06	74.00	-21.94	peak
6	17422.500	30.40	21.43	51.83	74.00	-22.17	peak

- Note: 1. Peak Result = Reading Level + Correct Factor.  
 2. If Peak Result complies with AV limit, AV Result is deemed to comply with AV limit.  
 3. Peak: Peak detector.  
 4. Filter losses were only considered in the spurious frequency bands and the authorized band was not corrected for High Pass Filter losses.  
 5. Proper operation of the transmitter prior to adding the filter to the measurement chain.

### 8.3.3. 802.11n HT20 MODE

#### HARMONICS AND SPURIOUS EMISSIONS (LOW CHANNEL, HORIZONTAL)

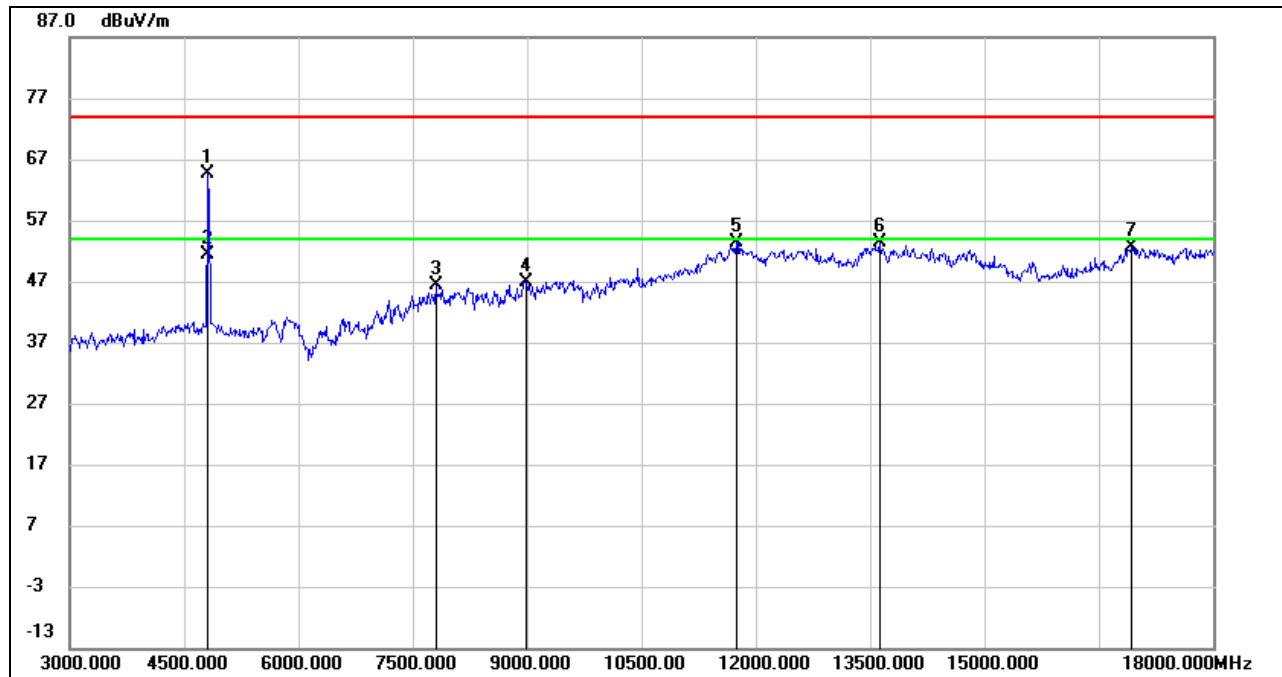

No.	Frequency (MHz)	Reading (dBuV)	Correct (dB/m)	Result (dBuV/m)	Limit (dBuV/m)	Margin (dB)	Remark
1	4822.500	64.94	-0.39	64.55	74.00	-9.45	peak
2	4822.500	51.71	-0.39	51.32	54.00	-2.68	AVG
3	7807.500	39.31	7.13	46.44	74.00	-27.56	peak
4	8992.500	36.97	10.01	46.98	74.00	-27.02	peak
5	11752.500	36.49	16.86	53.35	74.00	-20.65	peak
6	13627.500	32.70	20.57	53.27	74.00	-20.73	peak
7	16927.500	32.51	20.13	52.64	74.00	-21.36	peak

Note: 1. Peak Result = Reading Level + Correct Factor.

2. If Peak Result complies with AV limit, AV Result is deemed to comply with AV limit.

3. Peak: Peak detector.

4. AVG:  $VBW=1/Ton$ , where: Ton is the transmitting duration.

5. For the transmitting duration, please refer to clause 7.1.

6. Filter losses were only considered in the spurious frequency bands and the authorized band was not corrected for High Pass Filter losses.

7. Proper operation of the transmitter prior to adding the filter to the measurement chain.



**HARMONICS AND SPURIOUS EMISSIONS (LOW CHANNEL, VERTICAL)**

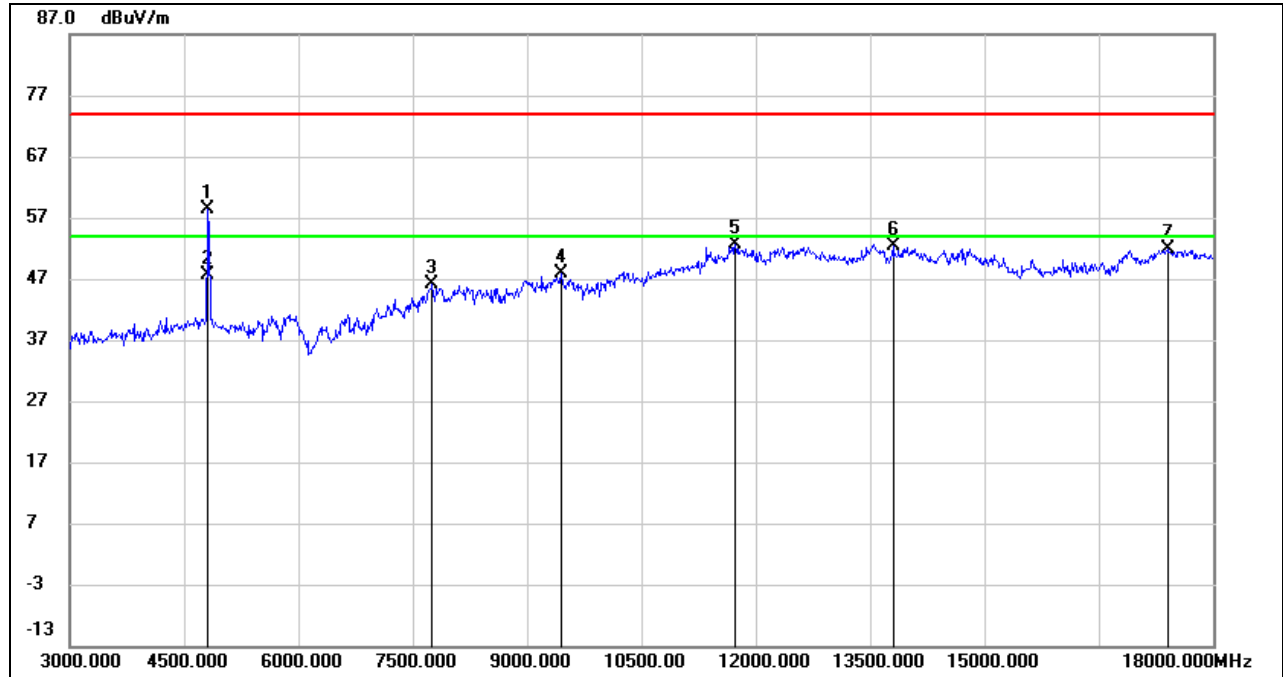

No.	Frequency (MHz)	Reading (dBuV)	Correct (dB/m)	Result (dBuV/m)	Limit (dBuV/m)	Margin (dB)	Remark
1	4815.000	58.74	-0.37	58.37	74.00	-15.63	peak
2	4815.000	48.06	-0.37	47.69	54.00	-6.31	AVG
3	7755.000	39.35	6.80	46.15	74.00	-27.85	peak
4	9457.500	37.79	10.15	47.94	74.00	-26.06	peak
5	11730.000	35.70	16.86	52.56	74.00	-21.44	peak
6	13800.000	31.13	21.15	52.28	74.00	-21.72	peak
7	17400.000	30.46	21.35	51.81	74.00	-22.19	peak

- Note: 1. Peak Result = Reading Level + Correct Factor.  
 2. If Peak Result complies with AV limit, AV Result is deemed to comply with AV limit.  
 3. Peak: Peak detector.  
 4. AVG:  $VBW=1/Ton$ , where: Ton is the transmitting duration.  
 5. For the transmitting duration, please refer to clause 7.1.  
 6. Filter losses were only considered in the spurious frequency bands and the authorized band was not corrected for High Pass Filter losses.  
 7. Proper operation of the transmitter prior to adding the filter to the measurement chain.

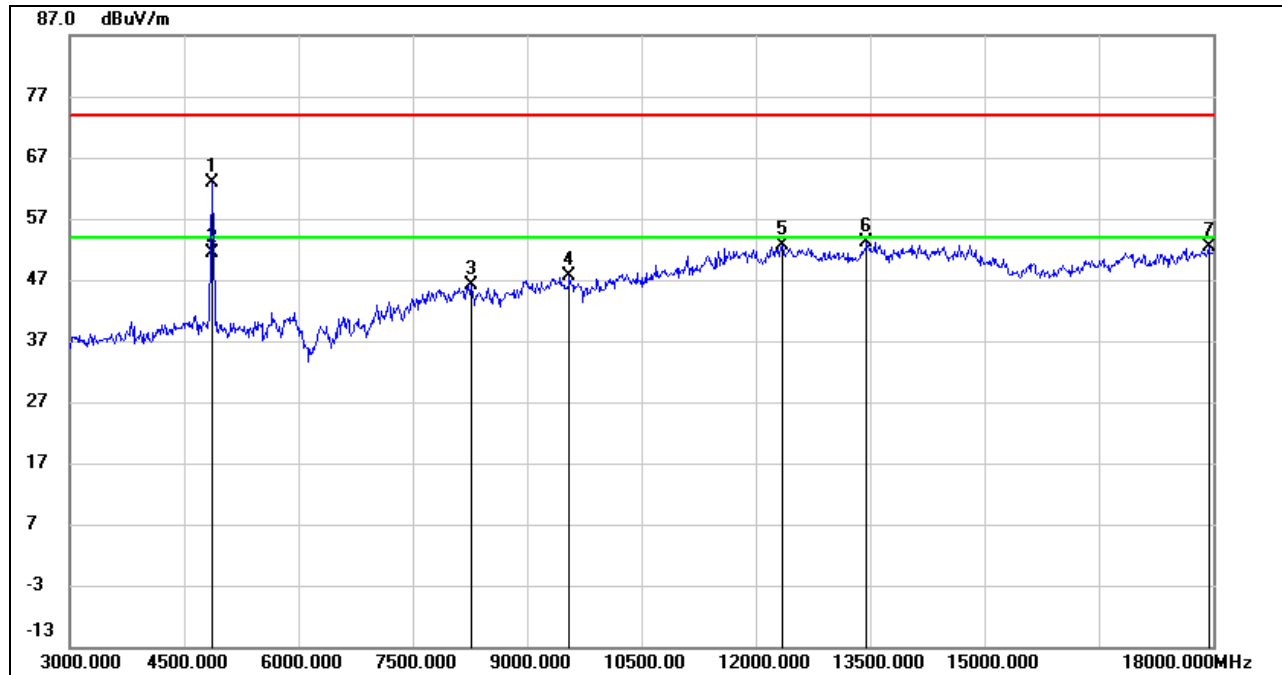
**HARMONICS AND SPURIOUS EMISSIONS (MID CHANNEL, HORIZONTAL)**

No.	Frequency (MHz)	Reading (dBuV)	Correct (dB/m)	Result (dBuV/m)	Limit (dBuV/m)	Margin (dB)	Remark
1	4867.500	63.34	-0.51	62.83	74.00	-11.17	peak
2	4867.500	51.83	-0.51	51.32	54.00	-2.68	AVG
3	8272.500	38.58	7.66	46.24	74.00	-27.76	peak
4	9562.500	37.31	10.43	47.74	74.00	-26.26	peak
5	12345.000	35.03	17.59	52.62	74.00	-21.38	peak
6	13462.500	32.99	20.21	53.20	74.00	-20.80	peak
7	17940.000	27.41	24.89	52.30	74.00	-21.70	peak

Note: 1. Peak Result = Reading Level + Correct Factor.

2. If Peak Result complies with AV limit, AV Result is deemed to comply with AV limit.

3. Peak: Peak detector.

4. AVG:  $VBW=1/Ton$ , where: Ton is the transmitting duration.

5. For the transmitting duration, please refer to clause 7.1.

6. Filter losses were only considered in the spurious frequency bands and the authorized band was not corrected for High Pass Filter losses.

7. Proper operation of the transmitter prior to adding the filter to the measurement chain.



**HARMONICS AND SPURIOUS EMISSIONS (MID CHANNEL, VERTICAL)**

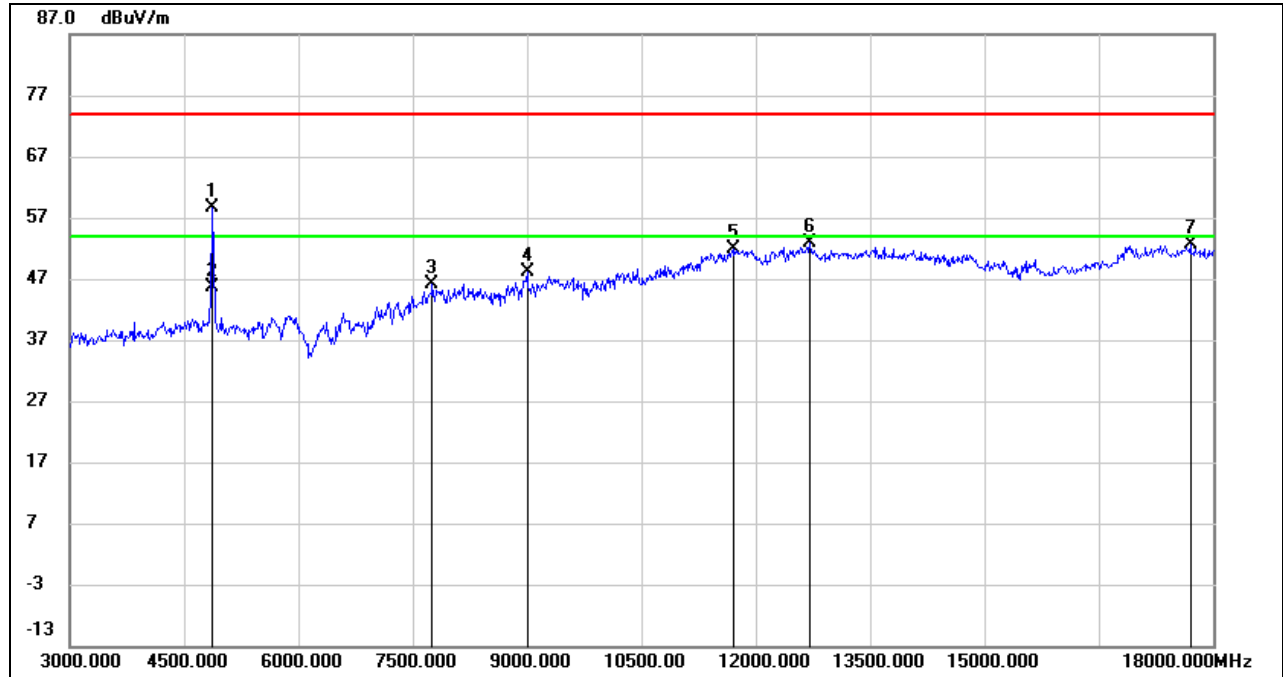

No.	Frequency (MHz)	Reading (dBuV)	Correct (dB/m)	Result (dBuV/m)	Limit (dBuV/m)	Margin (dB)	Remark
1	4875.000	59.26	-0.52	58.74	74.00	-15.26	peak
2	4875.000	46.17	-0.52	45.65	54.00	-8.35	AVG
3	7755.000	39.33	6.80	46.13	74.00	-27.87	peak
4	9000.000	38.02	10.17	48.19	74.00	-25.81	peak
5	11700.000	34.89	16.87	51.76	74.00	-22.24	peak
6	12705.000	35.68	17.23	52.91	74.00	-21.09	peak
7	17700.000	28.96	23.68	52.64	74.00	-21.36	peak

- Note:
1. Peak Result = Reading Level + Correct Factor.
  2. If Peak Result complies with AV limit, AV Result is deemed to comply with AV limit.
  3. Peak: Peak detector.
  4. AVG:  $VBW=1/Ton$ , where: Ton is the transmitting duration.
  5. For the transmitting duration, please refer to clause 7.1.
  6. Filter losses were only considered in the spurious frequency bands and the authorized band was not corrected for High Pass Filter losses.
  7. Proper operation of the transmitter prior to adding the filter to the measurement chain.

**HARMONICS AND SPURIOUS EMISSIONS (HIGH CHANNEL, HORIZONTAL)**

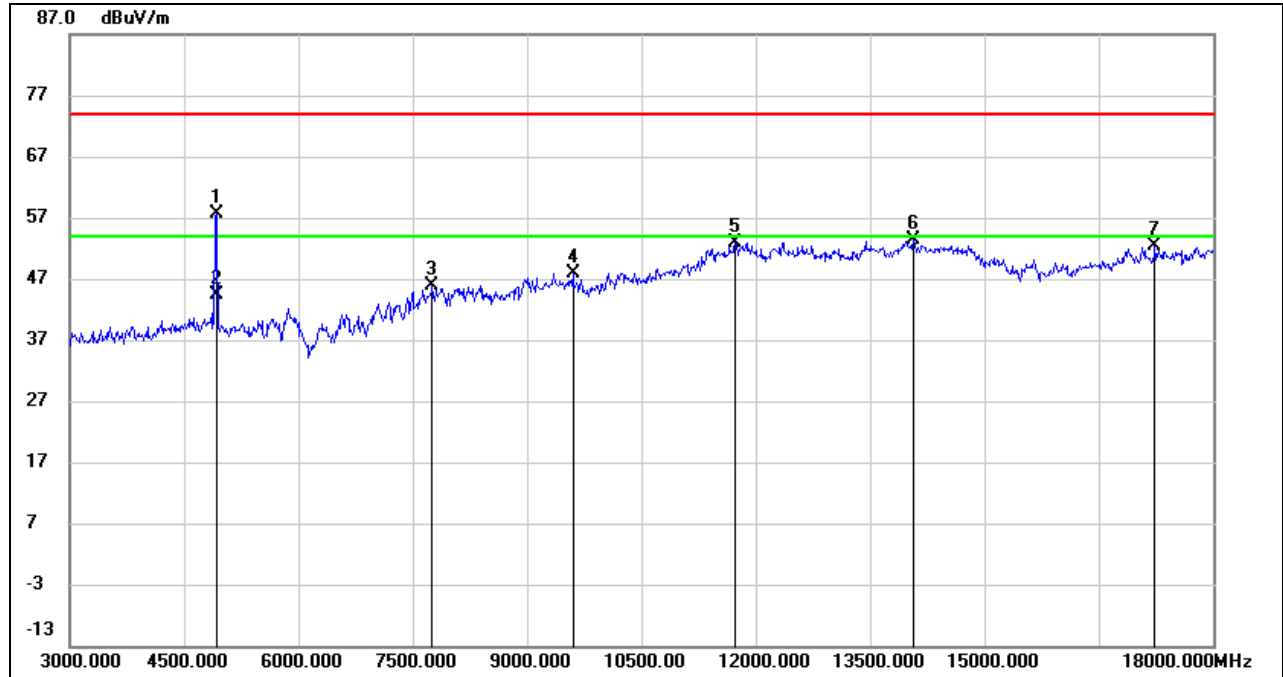

No.	Frequency (MHz)	Reading (dBuV)	Correct (dB/m)	Result (dBuV/m)	Limit (dBuV/m)	Margin (dB)	Remark
1	4920.000	58.10	-0.45	57.65	74.00	-16.35	peak
2	4920.000	44.81	-0.45	44.36	54.00	-9.64	AVG
3	7755.000	39.02	6.80	45.82	74.00	-28.18	peak
4	9600.000	37.10	10.69	47.79	74.00	-26.21	peak
5	11730.000	36.12	16.86	52.98	74.00	-21.02	peak
6	14070.000	32.38	21.01	53.39	74.00	-20.61	peak
7	17235.000	30.89	21.39	52.28	74.00	-21.72	peak

- Note: 1. Peak Result = Reading Level + Correct Factor.  
 2. If Peak Result complies with AV limit, AV Result is deemed to comply with AV limit.  
 3. Peak: Peak detector.  
 4. AVG:  $VBW=1/Ton$ , where: Ton is the transmitting duration.  
 5. For the transmitting duration, please refer to clause 7.1.  
 6. Filter losses were only considered in the spurious frequency bands and the authorized band was not corrected for High Pass Filter losses.  
 7. Proper operation of the transmitter prior to adding the filter to the measurement chain.

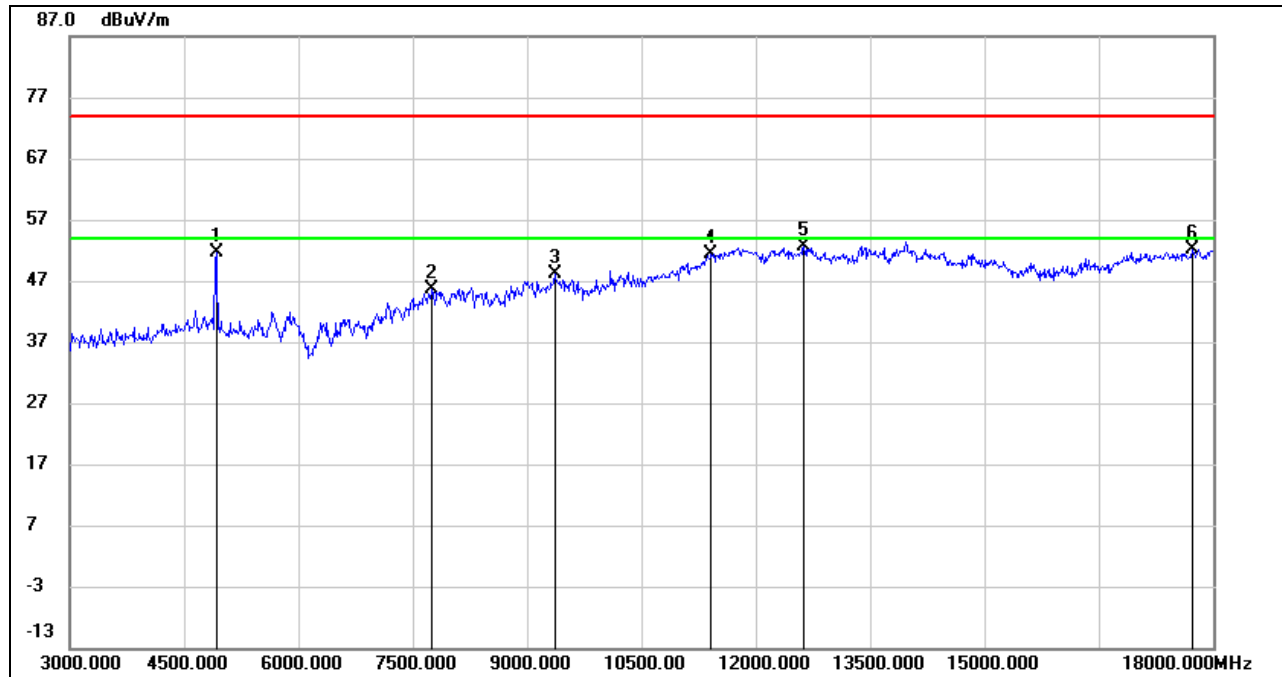
**HARMONICS AND SPURIOUS EMISSIONS (HIGH CHANNEL, VERTICAL)**

No.	Frequency (MHz)	Reading (dBuV)	Correct (dB/m)	Result (dBuV/m)	Limit (dBuV/m)	Margin (dB)	Remark
1	4920.000	52.05	-0.45	51.60	74.00	-22.40	peak
2	7755.000	38.77	6.80	45.57	74.00	-28.43	peak
3	9360.000	37.95	10.07	48.02	74.00	-25.98	peak
4	11415.000	35.61	15.85	51.46	74.00	-22.54	peak
5	12630.000	35.27	17.27	52.54	74.00	-21.46	peak
6	17730.000	28.29	23.93	52.22	74.00	-21.78	peak

Note: 1. Peak Result = Reading Level + Correct Factor.

2. If Peak Result complies with AV limit, AV Result is deemed to comply with AV limit.

3. Peak: Peak detector.

4. Filter losses were only considered in the spurious frequency bands and the authorized band was not corrected for High Pass Filter losses.

5. Proper operation of the transmitter prior to adding the filter to the measurement chain.

### 8.3.4. 802.11n HT40 MODE

#### HARMONICS AND SPURIOUS EMISSIONS (LOW CHANNEL, HORIZONTAL)

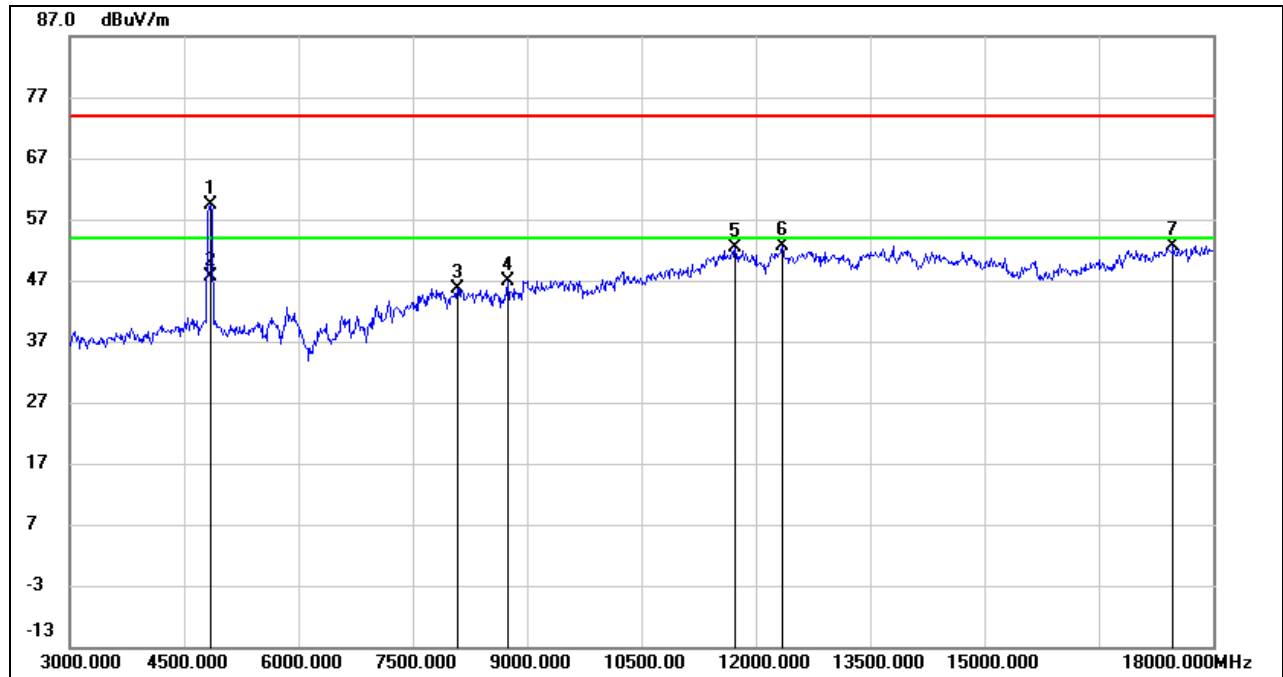

No.	Frequency (MHz)	Reading (dBuV)	Correct (dB/m)	Result (dBuV/m)	Limit (dBuV/m)	Margin (dB)	Remark
1	4845.000	59.72	-0.45	59.27	74.00	-14.73	peak
2	4845.000	48.10	-0.45	47.65	54.00	-6.35	AVG
3	8085.000	38.01	7.71	45.72	74.00	-28.28	peak
4	8745.000	39.17	7.64	46.81	74.00	-27.19	peak
5	11730.000	35.49	16.86	52.35	74.00	-21.65	peak
6	12345.000	35.15	17.59	52.74	74.00	-21.26	peak
7	17475.000	31.03	21.62	52.65	74.00	-21.35	peak

- Note:
1. Peak Result = Reading Level + Correct Factor.
  2. If Peak Result complies with AV limit, AV Result is deemed to comply with AV limit.
  3. Peak: Peak detector.
  4. AVG:  $VBW=1/Ton$ , where:  $Ton$  is the transmitting duration.
  5. For the transmitting duration, please refer to clause 7.1.
  6. Filter losses were only considered in the spurious frequency bands and the authorized band was not corrected for High Pass Filter losses.
  7. Proper operation of the transmitter prior to adding the filter to the measurement chain.



**HARMONICS AND SPURIOUS EMISSIONS (LOW CHANNEL, VERTICAL)**

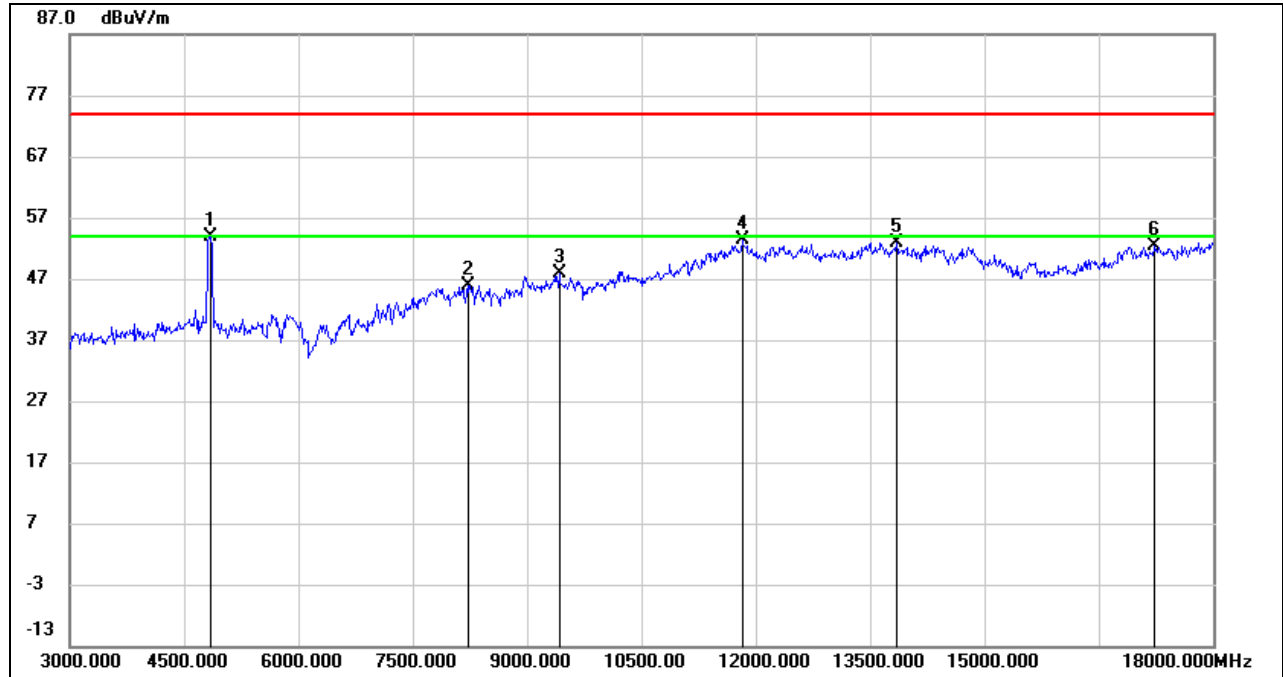

No.	Frequency (MHz)	Reading (dBuV)	Correct (dB/m)	Result (dBuV/m)	Limit (dBuV/m)	Margin (dB)	Remark
1	4845.000	54.29	-0.45	53.84	74.00	-20.16	peak
2	8220.000	38.31	7.67	45.98	74.00	-28.02	peak
3	9420.000	37.67	10.27	47.94	74.00	-26.06	peak
4	11820.000	36.45	16.92	53.37	74.00	-20.63	peak
5	13845.000	31.72	21.16	52.88	74.00	-21.12	peak
6	17235.000	30.89	21.39	52.28	74.00	-21.72	peak

- Note: 1. Peak Result = Reading Level + Correct Factor.  
 2. If Peak Result complies with AV limit, AV Result is deemed to comply with AV limit.  
 3. Peak: Peak detector.  
 4. Filter losses were only considered in the spurious frequency bands and the authorized band was not corrected for High Pass Filter losses.  
 5. Proper operation of the transmitter prior to adding the filter to the measurement chain.

**HARMONICS AND SPURIOUS EMISSIONS (MID CHANNEL, HORIZONTAL)**

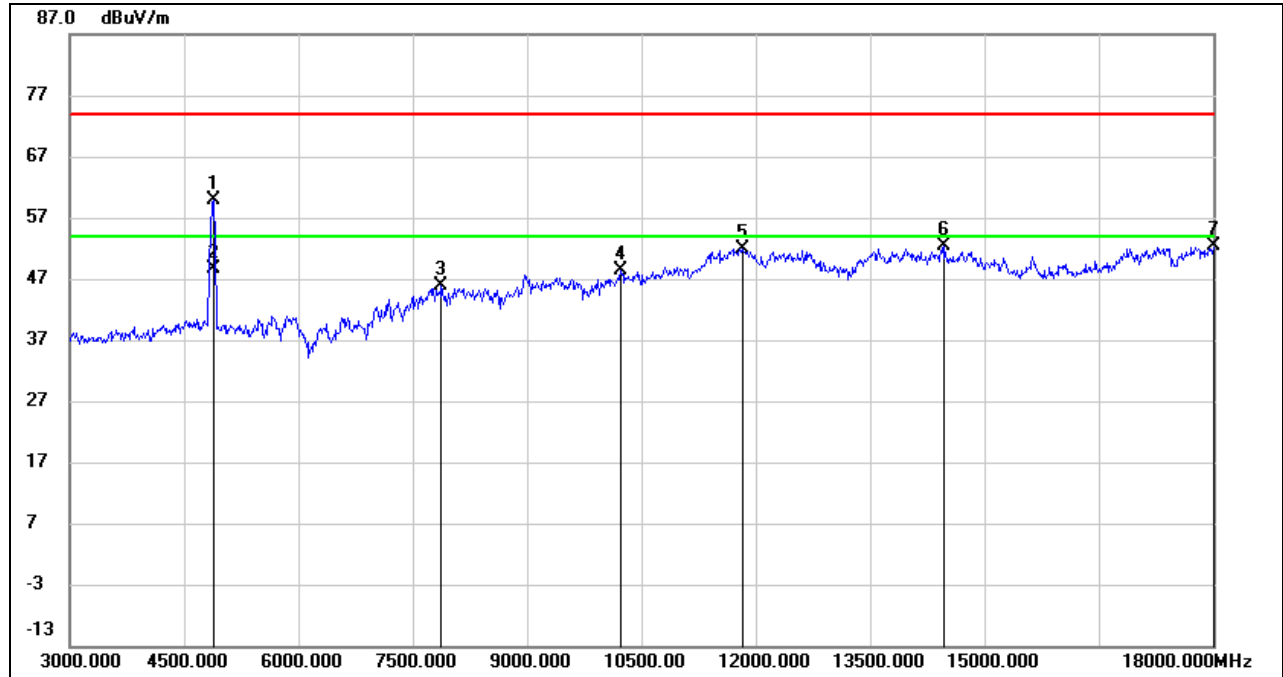

No.	Frequency (MHz)	Reading (dBuV)	Correct (dB/m)	Result (dBuV/m)	Limit (dBuV/m)	Margin (dB)	Remark
1	4890.000	60.53	-0.56	59.97	74.00	-14.03	peak
2	4890.000	49.21	-0.56	48.65	54.00	-5.35	AVG
3	7875.000	39.09	6.75	45.84	74.00	-28.16	peak
4	10230.000	36.64	11.73	48.37	74.00	-25.63	peak
5	11820.000	35.06	16.92	51.98	74.00	-22.02	peak
6	14475.000	33.36	19.04	52.40	74.00	-21.60	peak
7	18000.000	26.98	25.28	52.26	74.00	-21.74	peak

- Note: 1. Peak Result = Reading Level + Correct Factor.  
 2. If Peak Result complies with AV limit, AV Result is deemed to comply with AV limit.  
 3. Peak: Peak detector.  
 4. AVG:  $VBW=1/Ton$ , where: Ton is the transmitting duration.  
 5. For the transmitting duration, please refer to clause 7.1.  
 6. Filter losses were only considered in the spurious frequency bands and the authorized band was not corrected for High Pass Filter losses.  
 7. Proper operation of the transmitter prior to adding the filter to the measurement chain.



**HARMONICS AND SPURIOUS EMISSIONS (MID CHANNEL, VERTICAL)**

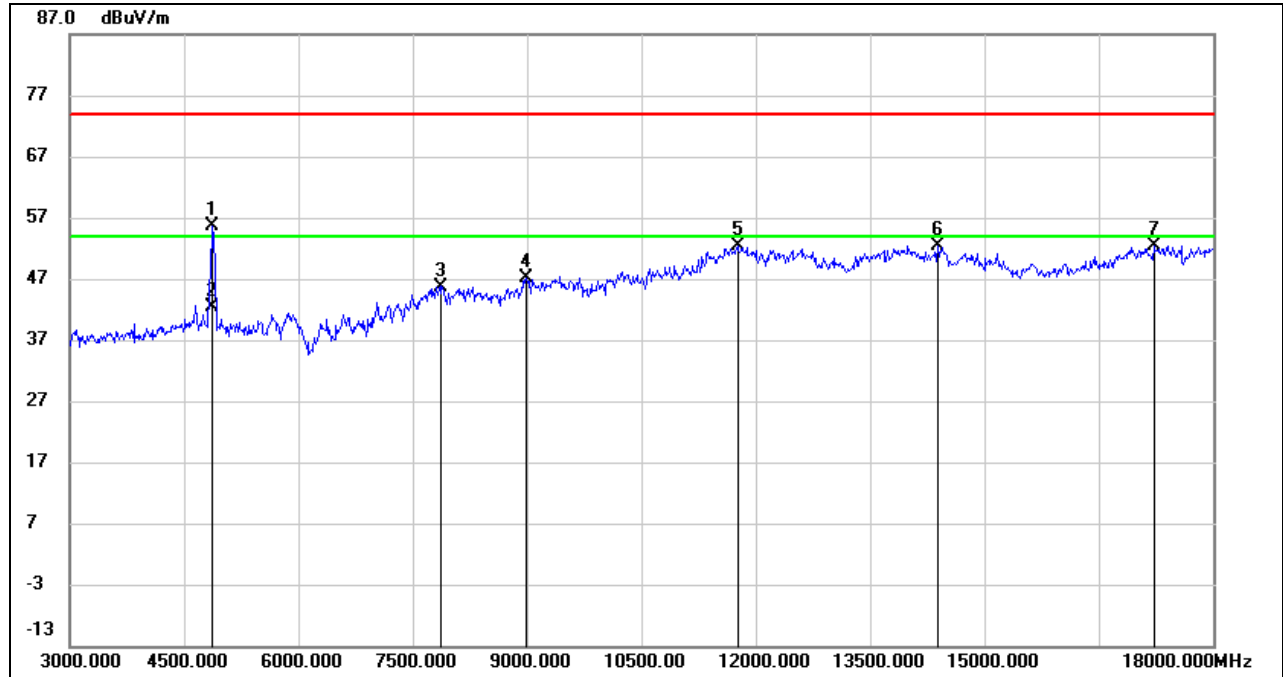

No.	Frequency (MHz)	Reading (dBuV)	Correct (dB/m)	Result (dBuV/m)	Limit (dBuV/m)	Margin (dB)	Remark
1	4875.000	56.24	-0.52	55.72	74.00	-18.28	peak
2	4875.000	42.84	-0.52	42.32	54.00	-11.68	AVG
3	7875.000	39.00	6.75	45.75	74.00	-28.25	peak
4	8985.000	37.27	9.86	47.13	74.00	-26.87	peak
5	11760.000	35.57	16.86	52.43	74.00	-21.57	peak
6	14385.000	32.70	19.66	52.36	74.00	-21.64	peak
7	17220.000	31.22	21.27	52.49	74.00	-21.51	peak

- Note:
1. Peak Result = Reading Level + Correct Factor.
  2. If Peak Result complies with AV limit, AV Result is deemed to comply with AV limit.
  3. Peak: Peak detector.
  4. AVG:  $VBW=1/Ton$ , where: Ton is the transmitting duration.
  5. For the transmitting duration, please refer to clause 7.1.
  6. Filter losses were only considered in the spurious frequency bands and the authorized band was not corrected for High Pass Filter losses.
  7. Proper operation of the transmitter prior to adding the filter to the measurement chain.

**HARMONICS AND SPURIOUS EMISSIONS (HIGH CHANNEL, HORIZONTAL)**

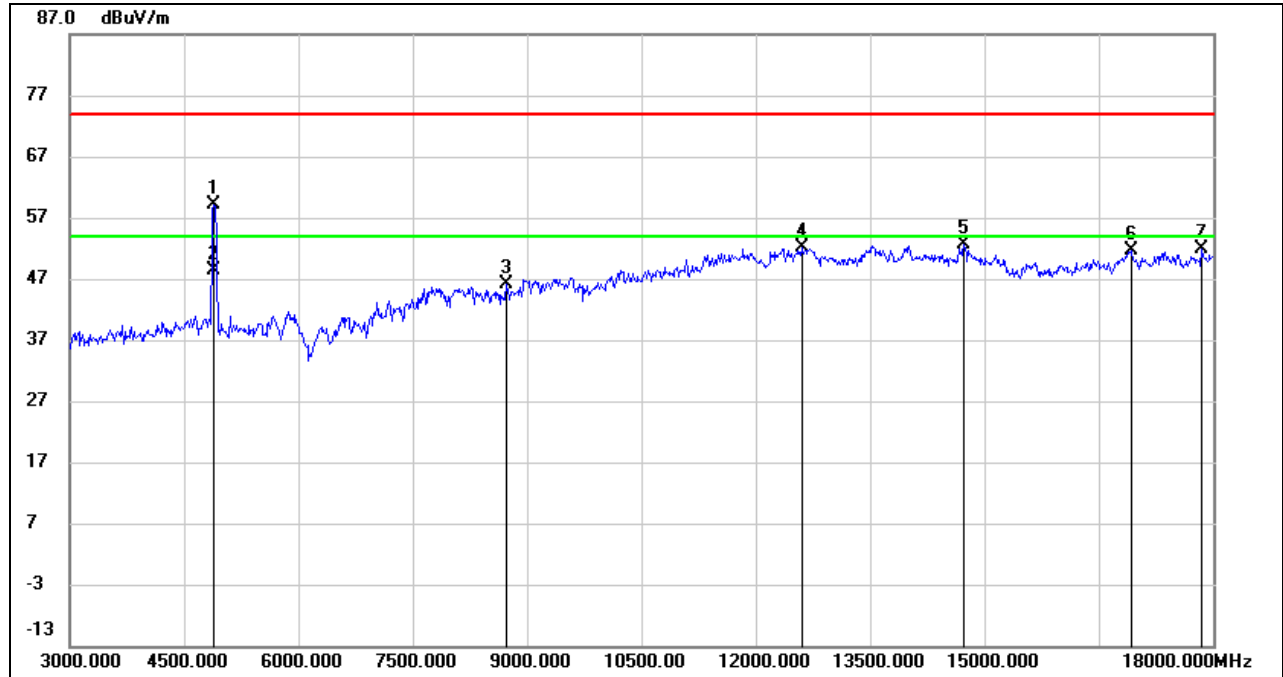

No.	Frequency (MHz)	Reading (dBuV)	Correct (dB/m)	Result (dBuV/m)	Limit (dBuV/m)	Margin (dB)	Remark
1	4890.000	59.80	-0.56	59.24	74.00	-14.76	peak
2	4890.000	48.92	-0.56	48.36	54.00	-5.64	AVG
3	8730.000	38.50	7.59	46.09	74.00	-27.91	peak
4	12600.000	34.72	17.30	52.02	74.00	-21.98	peak
5	14730.000	33.98	18.55	52.53	74.00	-21.47	peak
6	16920.000	31.45	20.16	51.61	74.00	-22.39	peak
7	17850.000	27.33	24.58	51.91	74.00	-22.09	peak

- Note: 1. Peak Result = Reading Level + Correct Factor.  
 2. If Peak Result complies with AV limit, AV Result is deemed to comply with AV limit.  
 3. Peak: Peak detector.  
 4. AVG:  $VBW=1/Ton$ , where: Ton is the transmitting duration.  
 5. For the transmitting duration, please refer to clause 7.1.  
 6. Filter losses were only considered in the spurious frequency bands and the authorized band was not corrected for High Pass Filter losses.  
 7. Proper operation of the transmitter prior to adding the filter to the measurement chain.



**HARMONICS AND SPURIOUS EMISSIONS (HIGH CHANNEL, VERTICAL)**

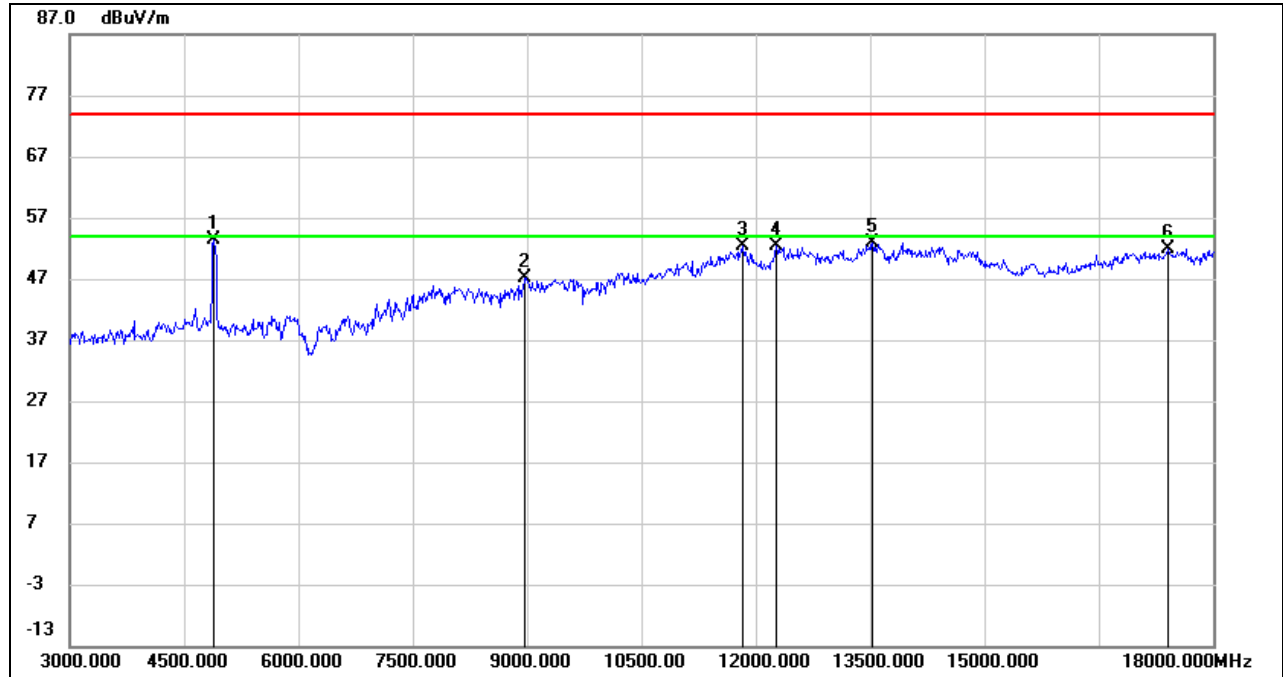

No.	Frequency (MHz)	Reading (dBuV)	Correct (dB/m)	Result (dBuV/m)	Limit (dBuV/m)	Margin (dB)	Remark
1	4890.000	54.01	-0.56	53.45	74.00	-20.55	peak
2	8970.000	37.51	9.55	47.06	74.00	-26.94	peak
3	11820.000	35.45	16.92	52.37	74.00	-21.63	peak
4	12270.000	34.79	17.66	52.45	74.00	-21.55	peak
5	13530.000	32.53	20.39	52.92	74.00	-21.08	peak
6	17400.000	30.55	21.35	51.90	74.00	-22.10	peak

- Note: 1. Peak Result = Reading Level + Correct Factor.  
 2. If Peak Result complies with AV limit, AV Result is deemed to comply with AV limit.  
 3. Peak: Peak detector.  
 4. Filter losses were only considered in the spurious frequency bands and the authorized band was not corrected for High Pass Filter losses.  
 5. Proper operation of the transmitter prior to adding the filter to the measurement chain.

### 8.4. SPURIOUS EMISSIONS (18 GHz ~ 26 GHz)

#### 8.4.1. 802.11g MODE

#### SPURIOUS EMISSIONS (HIGH CHANNEL, WORST-CASE CONFIGURATION, HORIZONTAL)

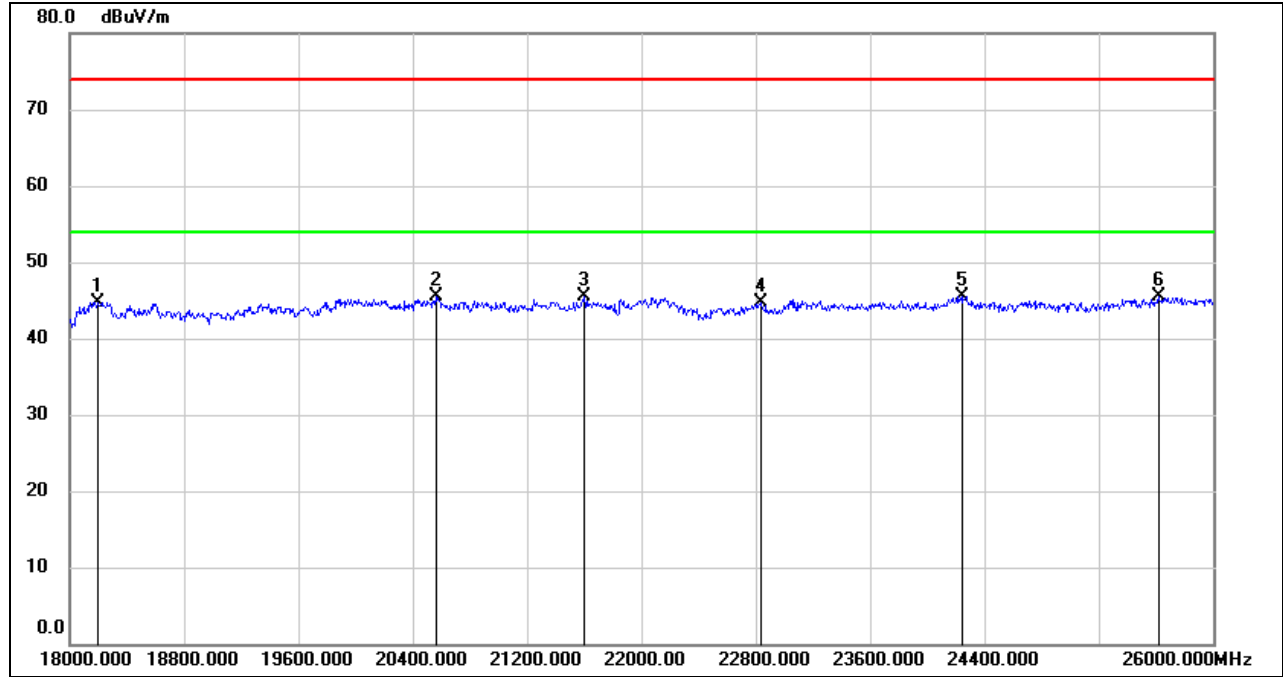

No.	Frequency (MHz)	Reading (dBuV)	Correct (dB/m)	Result (dBuV/m)	Limit (dBuV/m)	Margin (dB)	Remark
1	18200.000	50.29	-5.52	44.77	74.00	-29.23	peak
2	20560.000	50.73	-5.30	45.43	74.00	-28.57	peak
3	21600.000	50.02	-4.54	45.48	74.00	-28.52	peak
4	22840.000	48.26	-3.60	44.66	74.00	-29.34	peak
5	24248.000	48.32	-2.83	45.49	74.00	-28.51	peak
6	25616.000	46.68	-1.24	45.44	74.00	-28.56	peak

- Note: 1. Measurement = Reading Level + Correct Factor.  
 2. If Peak Result complies with AV limit, AV Result is deemed to comply with AV limit.  
 3. Peak: Peak detector.



**SPURIOUS EMISSIONS (HIGH CHANNEL, WORST-CASE CONFIGURATION, VERTICAL)**

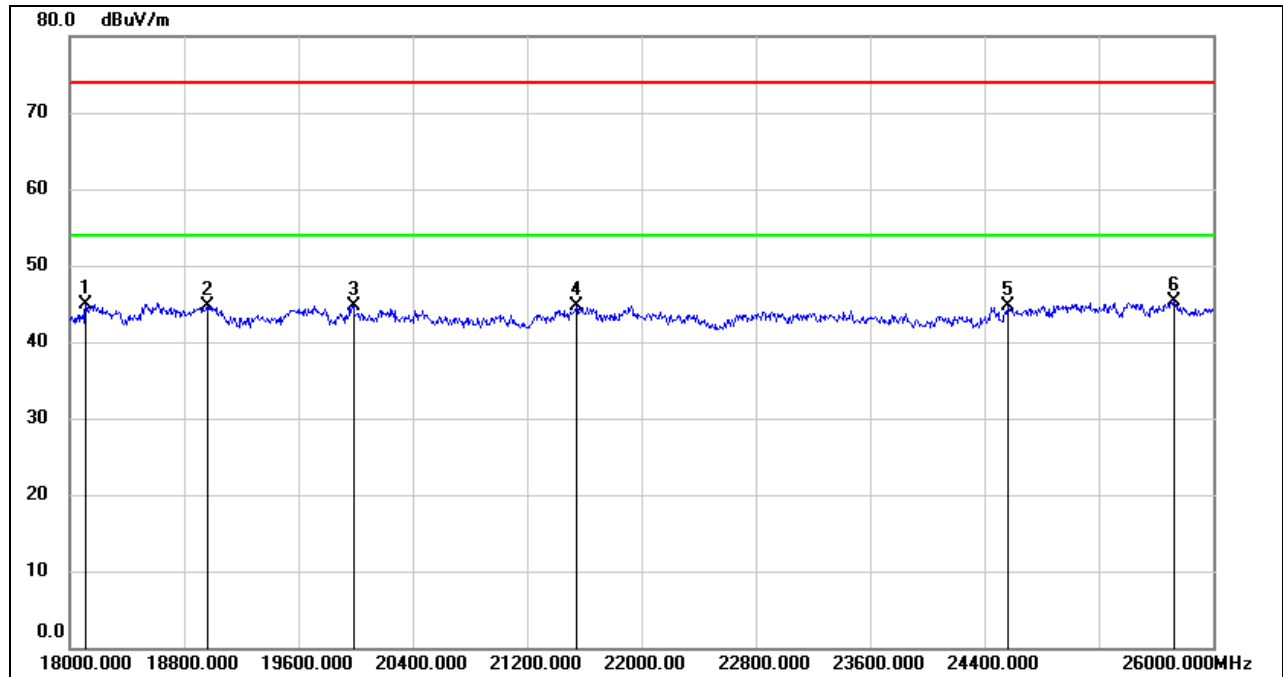

No.	Frequency (MHz)	Reading (dBuV)	Correct (dB/m)	Result (dBuV/m)	Limit (dBuV/m)	Margin (dB)	Remark
1	18112.000	50.46	-5.47	44.99	74.00	-29.01	peak
2	18960.000	50.01	-5.25	44.76	74.00	-29.24	peak
3	19984.000	50.21	-5.44	44.77	74.00	-29.23	peak
4	21544.000	49.26	-4.63	44.63	74.00	-29.37	peak
5	24568.000	47.10	-2.33	44.77	74.00	-29.23	peak
6	25728.000	46.11	-0.72	45.39	74.00	-28.61	peak

- Note: 1. Measurement = Reading Level + Correct Factor.  
 2. If Peak Result complies with AV limit, AV Result is deemed to comply with AV limit.  
 3. Peak: Peak detector.

Note: All the modes had been tested, but only the worst data was recorded in the report.

## 8.5. SPURIOUS EMISSIONS (30 MHz ~ 1 GHz)

### 8.5.1. 802.11g MODE

#### SPURIOUS EMISSIONS (HIGH CHANNEL, WORST-CASE CONFIGURATION, HORIZONTAL)

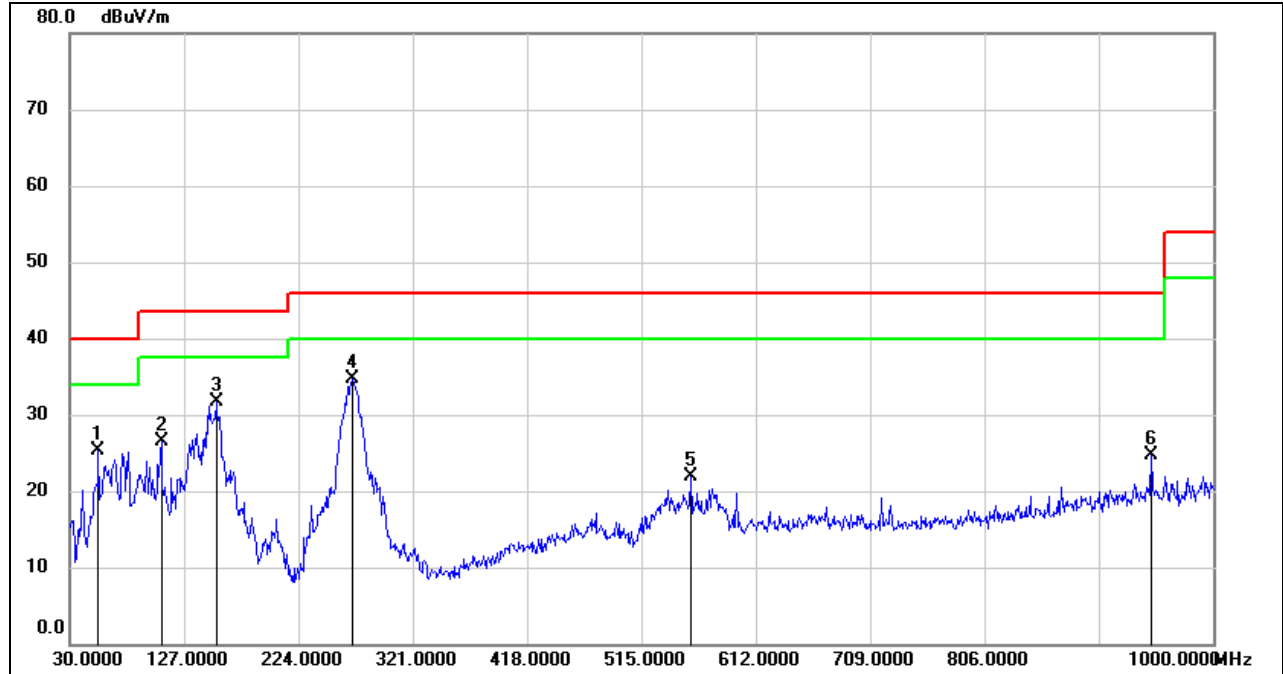

No.	Frequency (MHz)	Reading (dBuV)	Correct (dB/m)	Result (dBuV/m)	Limit (dBuV/m)	Margin (dB)	Remark
1	54.2500	45.95	-20.64	25.31	40.00	-14.69	QP
2	107.6000	47.16	-20.58	26.58	43.50	-16.92	QP
3	154.1600	49.70	-18.06	31.64	43.50	-11.86	QP
4	269.5900	52.44	-17.77	34.67	46.00	-11.33	QP
5	556.7100	32.32	-10.38	21.94	46.00	-24.06	QP
6	947.6200	29.08	-4.43	24.65	46.00	-21.35	QP

- Note: 1. Result Level = Read Level + Correct Factor.  
 2. If Peak Result complies with QP limit, QP Result is deemed to comply with QP limit.  
 3. Test setup: RBW: 120 kHz, VBW: 300 kHz, Sweep time: auto.

**SPURIOUS EMISSIONS (HIGH CHANNEL, WORST-CASE CONFIGURATION, VERTICAL)**

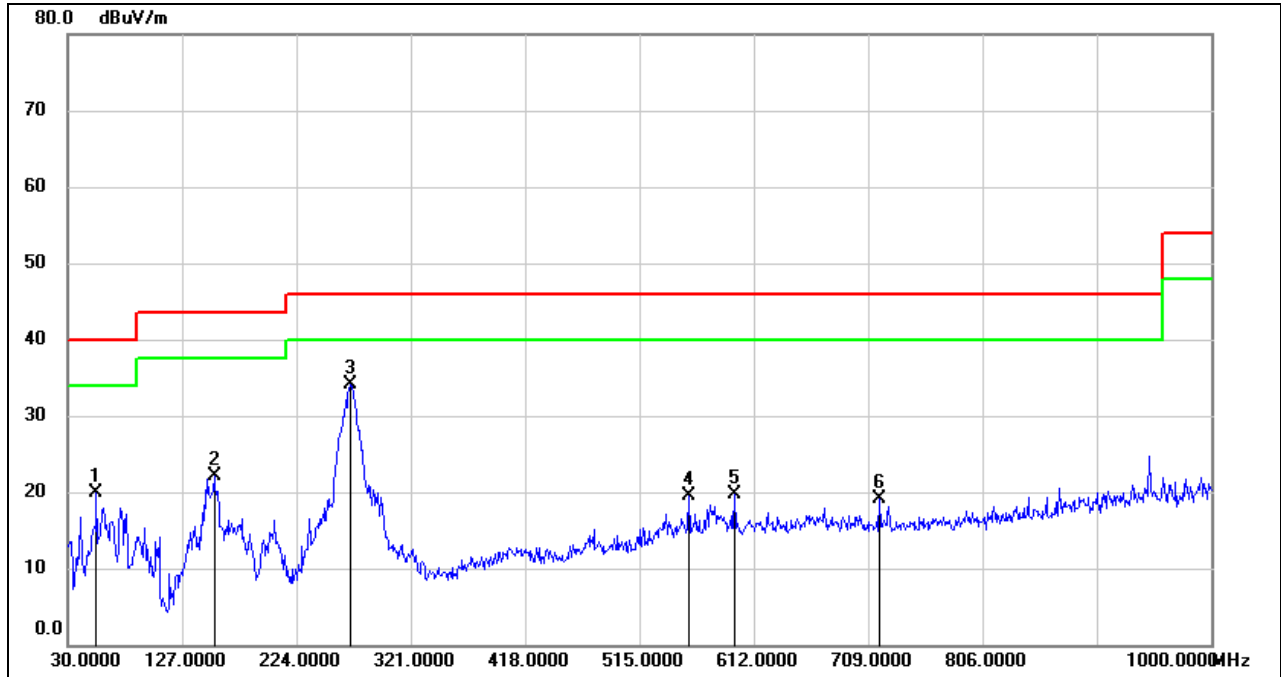

No.	Frequency (MHz)	Reading (dBuV)	Correct (dB/m)	Result (dBuV/m)	Limit (dBuV/m)	Margin (dB)	Remark
1	54.2500	40.45	-20.64	19.81	40.00	-20.19	QP
2	154.1600	40.20	-18.06	22.14	43.50	-21.36	QP
3	269.5900	51.94	-17.77	34.17	46.00	-11.83	QP
4	556.7100	29.82	-10.38	19.44	46.00	-26.56	QP
5	595.5100	29.42	-9.67	19.75	46.00	-26.25	QP
6	718.7000	27.14	-8.10	19.04	46.00	-26.96	QP

- Note: 1. Result Level = Read Level + Correct Factor.  
 2. If Peak Result complies with QP limit, QP Result is deemed to comply with QP limit.  
 3. Test setup: RBW: 120 kHz, VBW: 300 kHz, Sweep time: auto

Note: All the modes had been tested, but only the worst data was recorded in the report.



## 8.6. SPURIOUS EMISSIONS BELOW 30 MHz

### 8.6.1. 802.11g MODE

#### SPURIOUS EMISSIONS (HIGH CHANNEL, LOOP ANTENNA FACE ON TO THE EUT, WORST-CASE CONFIGURATION)

9 kHz ~ 150 kHz

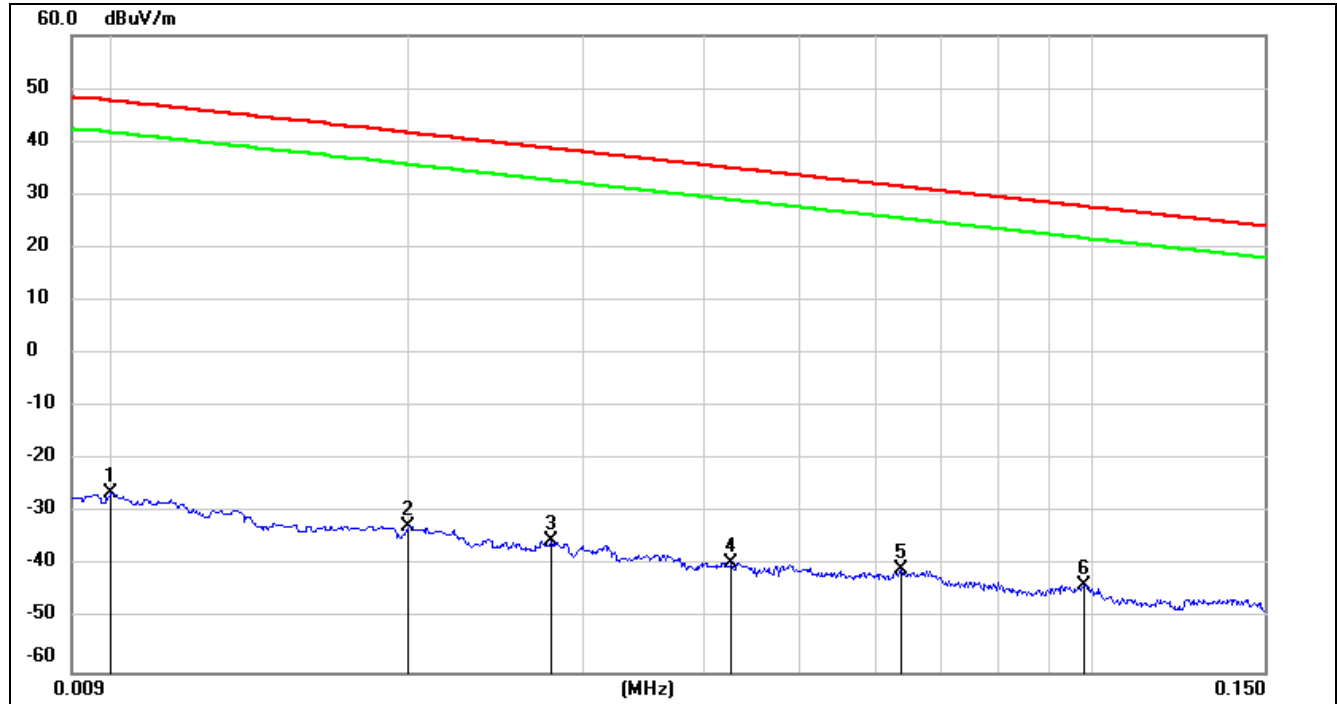

No.	Frequency (MHz)	Reading (dBuV)	Correct (dB/m)	FCC Result (dBuV/m)	FCC Limit (dBuV/m)	ISED Result (dBuA/m)	ISED Limit (dBuA/m)	Margin (dB)	Remark
1	0.0100	75.22	-101.40	-26.18	47.6	-77.68	-3.90	-73.78	peak
2	0.0200	68.86	-101.34	-32.48	41.58	-83.98	-9.92	-74.06	peak
3	0.0279	66.17	-101.38	-35.21	38.69	-86.71	-12.81	-73.90	peak
4	0.0427	62.14	-101.45	-39.31	34.99	-90.81	-16.51	-74.30	peak
5	0.0636	60.81	-101.54	-40.73	31.53	-92.23	-19.97	-72.26	peak
6	0.0981	58.27	-101.78	-43.51	27.77	-95.01	-23.73	-71.28	peak

Note: 1. Measurement = Reading Level + Correct Factor (dBuA/m= dBuV/m- 20Log10[120π] = dBuV/m- 51.5).

2. If Peak Result complies with AV and QP limit, AV and QP Result are deemed to comply with AV limit.

3. All 3 polarizations (Horizontal, Face-on and Face-off) of the loop antenna had been tested, but only the worst data recorded in the report.





**150 kHz ~ 490 kHz**

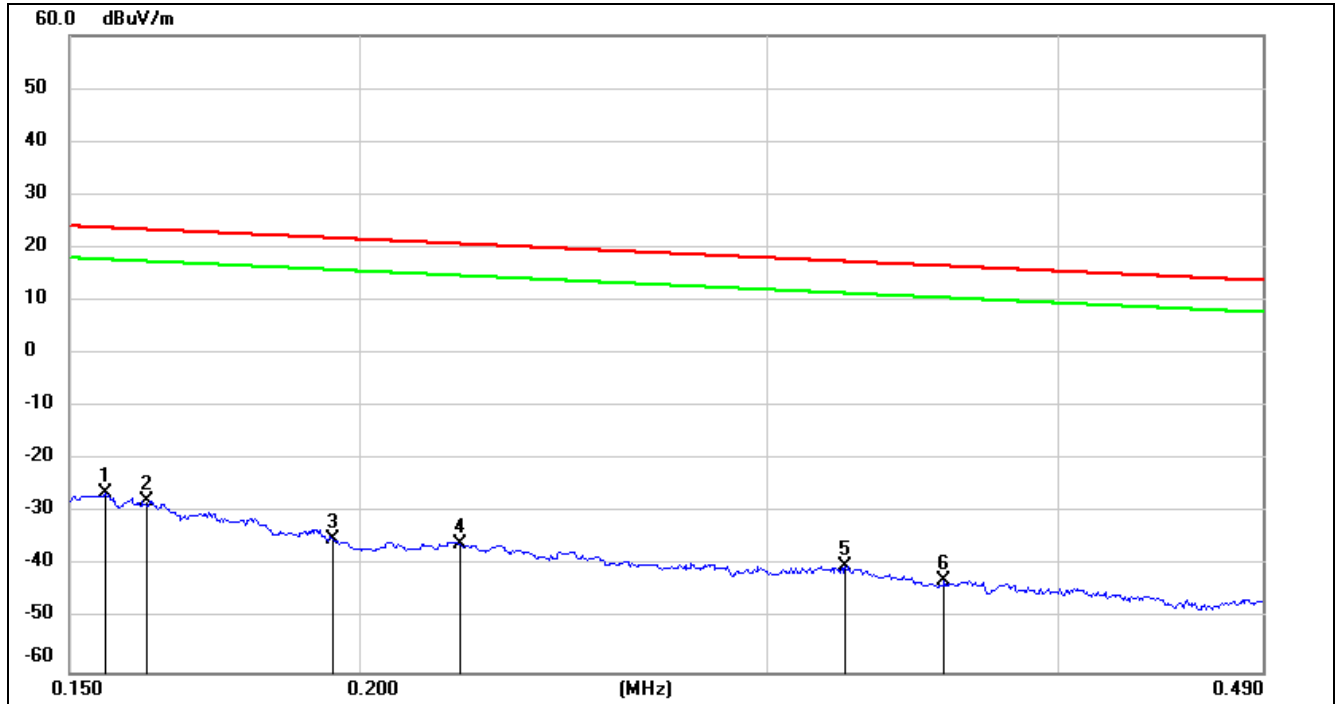

No.	Frequency (MHz)	Reading (dBuV)	Correct (dB/m)	FCC Result (dBuV/m)	FCC Limit (dBuV/m)	ISED Result (dBuA/m)	ISED Limit (dBuA/m)	Margin (dB)	Remark
1	0.1554	75.27	-101.65	-26.38	23.77	-77.88	-27.73	-50.15	peak
2	0.1621	73.92	-101.65	-27.73	23.41	-79.23	-28.09	-51.14	peak
3	0.1948	66.75	-101.71	-34.96	21.81	-86.46	-29.69	-56.77	peak
4	0.2210	65.84	-101.75	-35.91	20.71	-87.41	-30.79	-56.62	peak
5	0.3240	61.87	-101.88	-40.01	17.39	-91.51	-34.11	-57.40	peak
6	0.3573	59.08	-101.91	-42.83	16.54	-94.33	-34.96	-59.37	peak

Note: 1. Measurement = Reading Level + Correct Factor (dBuA/m= dBuV/m- 20Log10[120π] = dBuV/m- 51.5).

2. If Peak Result complies with AV and QP limit, AV and QP Result are deemed to comply with AV limit.

3. All 3 polarizations (Horizontal, Face-on and Face-off) of the loop antenna had been tested, but only the worst data recorded in the report.



**490 kHz ~ 30 MHz**

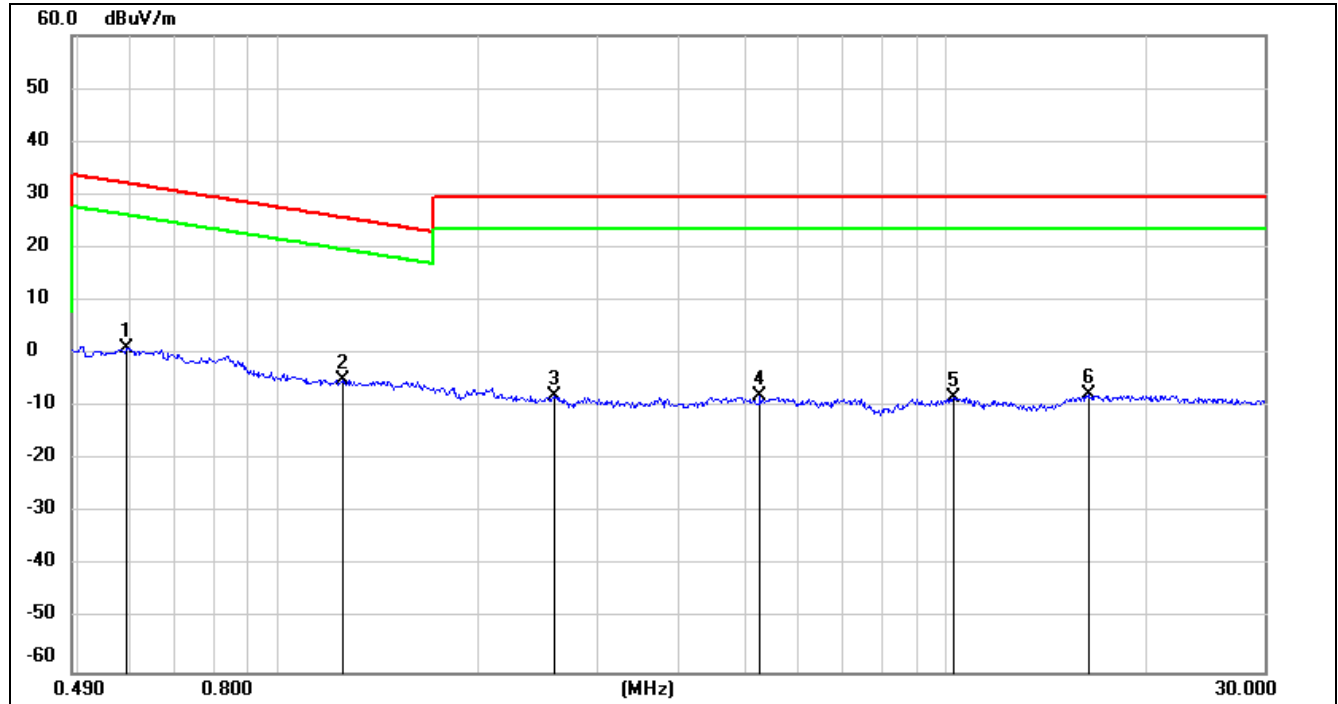

No.	Frequency (MHz)	Reading (dBuV)	Correct (dB/m)	FCC Result (dBuV/m)	FCC Limit (dBuV/m)	ISED Result (dBuA/m)	ISED Limit (dBuA/m)	Margin (dB)	Remark
1	0.5917	63.24	-62.08	1.16	32.16	-50.34	-19.34	-31.00	peak
2	1.2459	57.25	-62.16	-4.91	25.7	-56.41	-25.80	-30.61	peak
3	2.5935	53.61	-61.68	-8.07	29.54	-59.57	-21.96	-37.61	peak
4	5.2705	53.54	-61.45	-7.91	29.54	-59.41	-21.96	-37.45	peak
5	10.2576	52.63	-60.81	-8.18	29.54	-59.68	-21.96	-37.72	peak
6	16.3959	53.17	-60.96	-7.79	29.54	-59.29	-21.96	-37.33	peak

Note: 1. Measurement = Reading Level + Correct Factor (dBuA/m= dBuV/m- 20Log10[120π] = dBuV/m- 51.5).

2. If Peak Result complies with AV and QP limit, AV and QP Result are deemed to comply with AV limit.

3. All 3 polarizations (Horizontal, Face-on and Face-off) of the loop antenna had been tested, but only the worst data recorded in the report.

Note: All the modes had been tested, but only the worst data was recorded in the report.

## 9. AC POWER LINE CONDUCTED EMISSIONS

### LIMITS

Please refer to CFR 47 FCC §15.207 (a).

FREQUENCY (MHz)	Quasi-peak	Average
0.15 -0.5	66 - 56 *	56 - 46 *
0.50 -5.0	56.00	46.00
5.0 -30.0	60.00	50.00

### TEST SETUP AND PROCEDURE

Refer to ANSI C63.10-2013 clause 6.2.

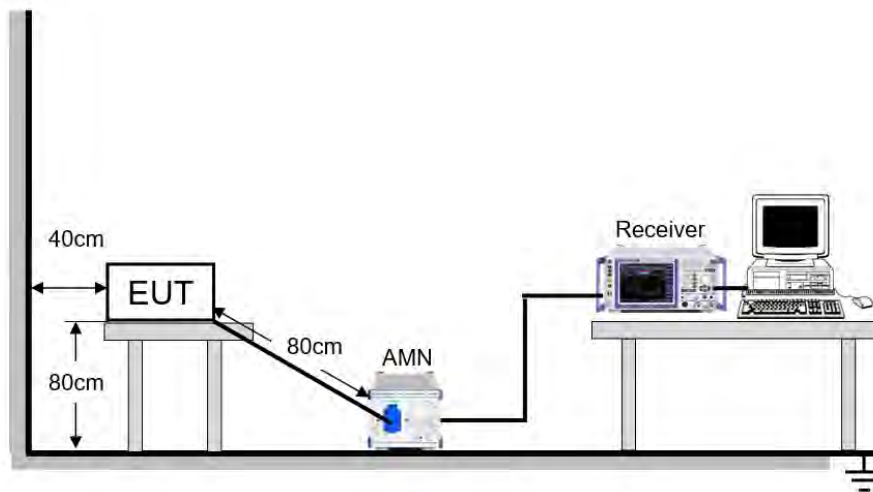

The EUT is put on a table of non-conducting material that is 80 cm high. The vertical conducting wall of shielding is located 40 cm to the rear of the EUT. The power line of the EUT is connected to the AC mains through a Artificial Mains Network (A.M.N.). A EMI Measurement Receiver (R&S Test Receiver ESR3) is used to test the emissions from both sides of AC line. According to the requirements in Section 6.2 of ANSI C63.10-2013. Conducted emissions from the EUT measured in the frequency range between 0.15 MHz and 30 MHz using CISPR Quasi-Peak and average detector mode. The bandwidth of EMI test receiver is set at 9 kHz.

The arrangement of the equipment is installed to meet the standards and operating in a manner, which tends to maximize its emission characteristics in a normal application.

### TEST ENVIRONMENT

Temperature	20.5 °C	Relative Humidity	51.7 %
Atmosphere Pressure	101 kPa	Test Voltage	AC 120 V/60 Hz

**RESULTS**

**9.1. 802.11g MODE**

**LINE L RESULTS (HIGH CHANNEL, WORST-CASE CONFIGURATION)**

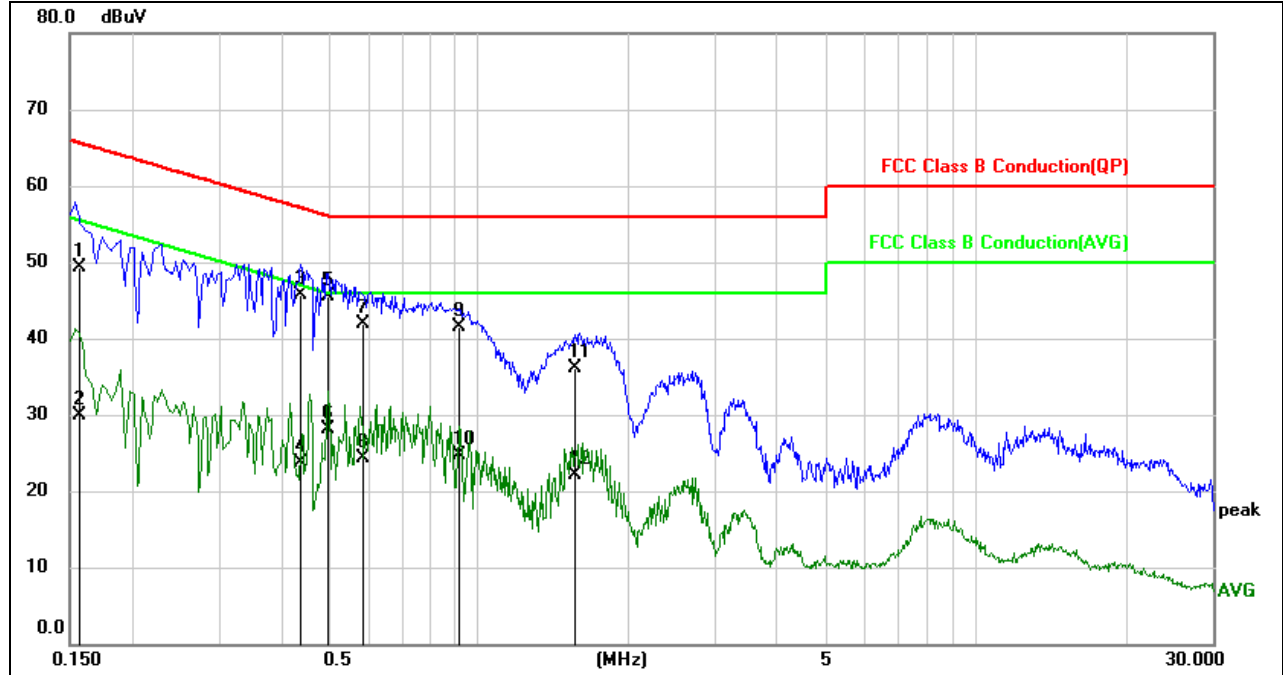

No.	Frequency (MHz)	Reading (dBuV)	Correct (dB)	Result (dBuV)	Limit (dBuV)	Margin (dB)	Remark
1	0.1573	39.66	9.59	49.25	65.61	-16.36	QP
2	0.1573	20.22	9.59	29.81	55.61	-25.80	AVG
3	0.4367	36.42	9.36	45.78	57.12	-11.34	QP
4	0.4367	14.44	9.36	23.80	47.12	-23.32	AVG
5	0.4975	36.13	9.30	45.43	56.04	-10.61	QP
6	0.4975	18.75	9.30	28.05	46.04	-17.99	AVG
7	0.5899	32.47	9.43	41.90	56.00	-14.10	QP
8	0.5899	14.89	9.43	24.32	46.00	-21.68	AVG
9	0.9174	31.91	9.61	41.52	56.00	-14.48	QP
10	0.9174	15.10	9.61	24.71	46.00	-21.29	AVG
11	1.5638	26.57	9.62	36.19	56.00	-19.81	QP
12	1.5638	12.57	9.62	22.19	46.00	-23.81	AVG

- Note: 1. Result = Reading +Correct Factor.  
 2. If QP Result complies with AV limit, AV Result is deemed to comply with AV limit.  
 3. Test setup: RBW: 200 Hz (9 kHz ~ 150 kHz), 9 kHz (150 kHz ~ 30 MHz).  
 4. Step size: 80 Hz (0.009 MHz ~ 0.15 MHz), 4 kHz (0.15 MHz ~ 30 MHz), Scan time: auto.

**LINE N RESULTS (HIGH CHANNEL, WORST-CASE CONFIGURATION)**

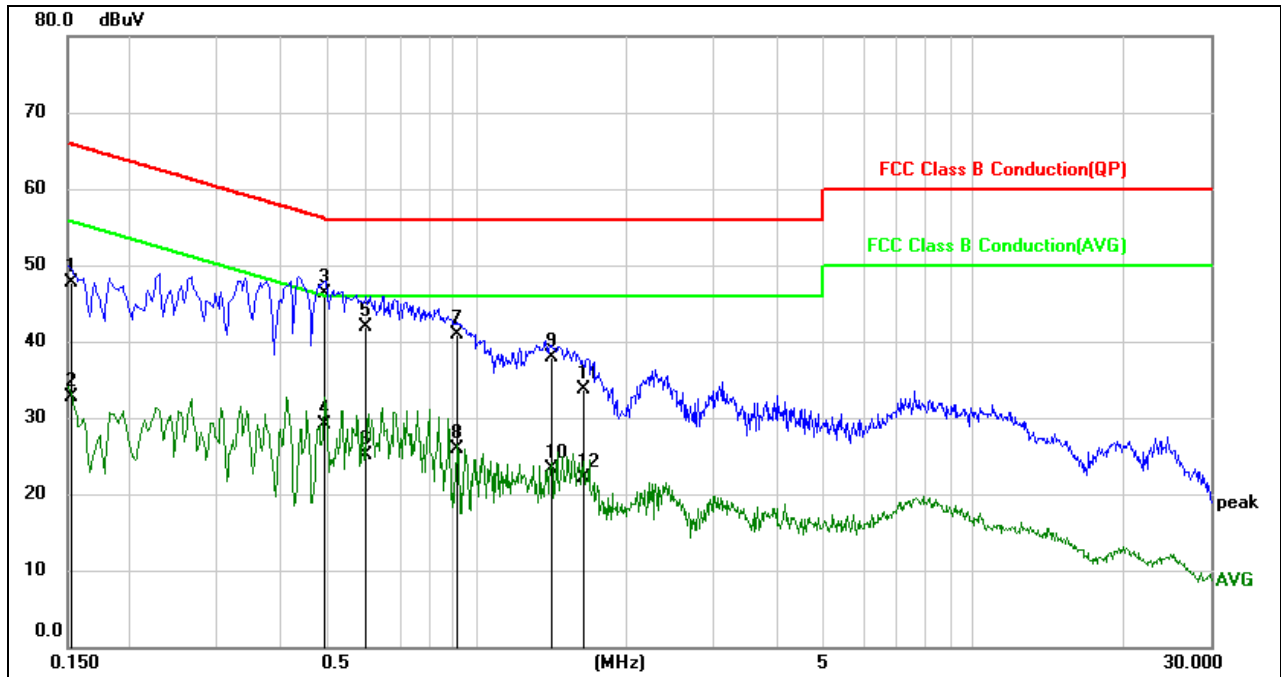

No.	Frequency (MHz)	Reading (dBuV)	Correct (dB)	Result (dBuV)	Limit (dBuV)	Margin (dB)	Remark
1	0.1526	38.14	9.59	47.73	65.86	-18.13	QP
2	0.1526	23.06	9.59	32.65	55.86	-23.21	AVG
3	0.4979	37.08	9.30	46.38	56.03	-9.65	QP
4	0.4979	19.81	9.30	29.11	46.03	-16.92	AVG
5	0.5947	32.54	9.44	41.98	56.00	-14.02	QP
6	0.5947	15.75	9.44	25.19	46.00	-20.81	AVG
7	0.9174	31.38	9.61	40.99	56.00	-15.01	QP
8	0.9174	16.21	9.61	25.82	46.00	-20.18	AVG
9	1.4151	28.35	9.62	37.97	56.00	-18.03	QP
10	1.4151	13.59	9.62	23.21	46.00	-22.79	AVG
11	1.6431	24.18	9.62	33.80	56.00	-22.20	QP
12	1.6431	12.40	9.62	22.02	46.00	-23.98	AVG

Note: 1. Result = Reading +Correct Factor.  
 2. If QP Result complies with AV limit, AV Result is deemed to comply with AV limit.  
 3. Test setup: RBW: 200 Hz (9 kHz ~ 150 kHz), 9 kHz (150 kHz ~ 30 MHz).  
 4. Step size: 80 Hz (0.009 MHz ~ 0.15 MHz), 4 kHz (0.15 MHz ~ 30 MHz), Scan time: auto.

Note: All the modes had been tested, but only the worst data was recorded in the report.



## 10. ANTENNA REQUIREMENTS

### APPLICABLE REQUIREMENTS

Please refer to FCC §15.203

An intentional radiator shall be designed to ensure that no antenna other than that furnished by the responsible party shall be used with the device. The use of a permanently attached antenna or of an antenna that uses a unique coupling to the intentional radiator shall be considered sufficient to comply with the provisions of this section. The manufacturer may design the unit so that a broken antenna can be replaced by the user, but the use of a standard antenna jack or electrical connector is prohibited.

Please refer to FCC §15.247(b)(4)

The conducted output power limit specified in paragraph (b) of this section is based on the use of antennas with directional gains that do not exceed 6 dBi. Except as shown in paragraph (c) of this section, if transmitting antennas of directional gain greater than 6 dBi are used, the conducted output power from the intentional radiator shall be reduced below the stated values in paragraphs (b)(1), (b)(2), and (b)(3) of this section, as appropriate, by the amount in dB that the directional gain of the antenna exceeds 6 dBi.

### RESULTS

Complies



## 11. Appendix

### 11.1. Appendix A: DTS Bandwidth

#### 11.1.1. Test Result

Test Mode	Antenna	Channel	DTS BW [MHz]	FL[MHz]	FH[MHz]	Limit[MHz]	Verdict
11B	Ant1	2412	8.08	2407.96	2416.04	0.5	PASS
		2437	8.08	2432.96	2441.04	0.5	PASS
		2462	8.08	2457.96	2466.04	0.5	PASS
11G	Ant1	2412	15.88	2404.24	2420.12	0.5	PASS
		2437	16.32	2428.84	2445.16	0.5	PASS
		2462	16.36	2453.80	2470.16	0.5	PASS
11N20SISO	Ant1	2412	17.60	2403.20	2420.80	0.5	PASS
		2437	17.16	2428.60	2445.76	0.5	PASS
		2462	17.56	2453.20	2470.76	0.5	PASS
11N40SISO	Ant1	2422	35.12	2404.48	2439.60	0.5	PASS
		2437	35.92	2419.24	2455.16	0.5	PASS
		2452	35.12	2434.48	2469.60	0.5	PASS

### 11.1.2. Test Graphs

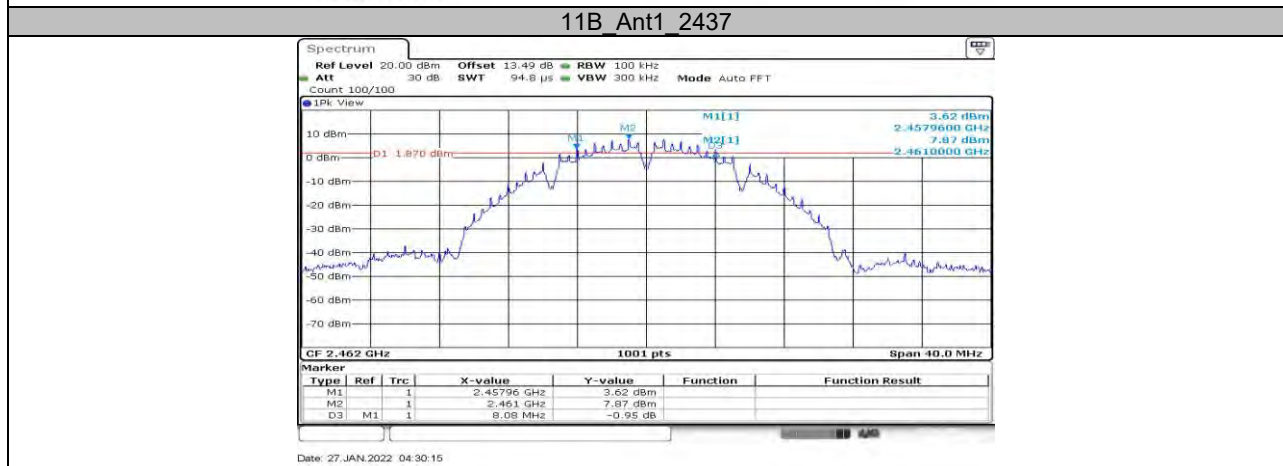
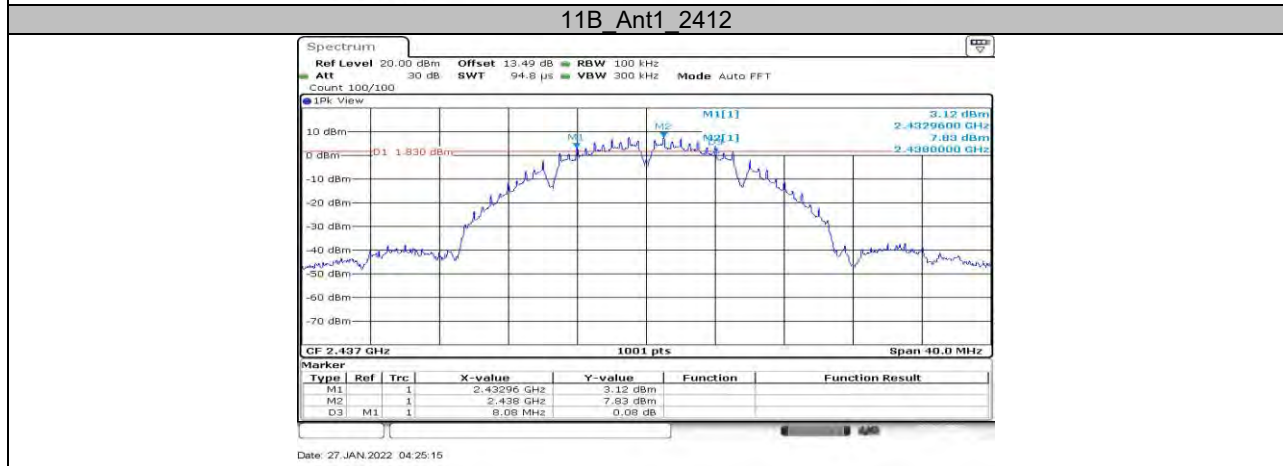
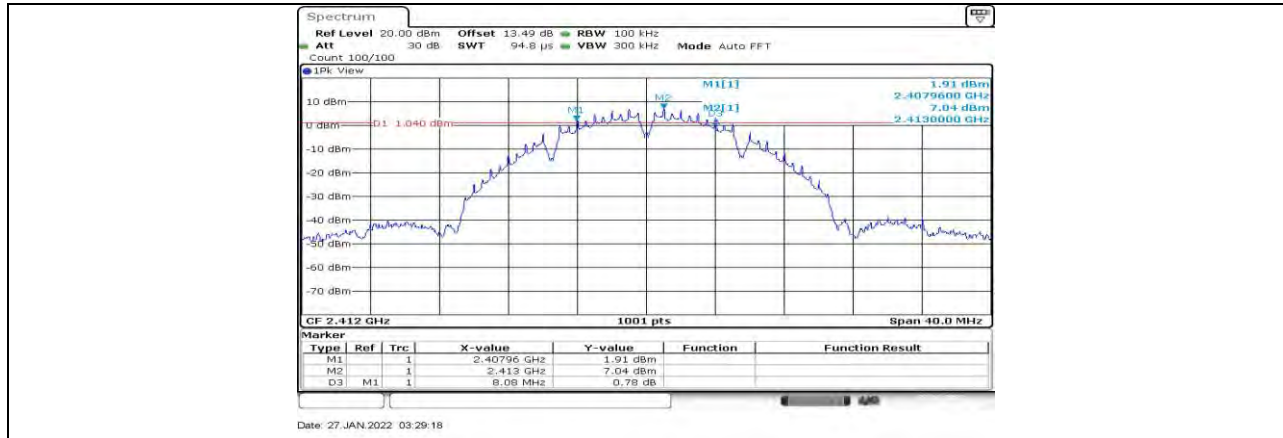

**11B Ant1 2462**



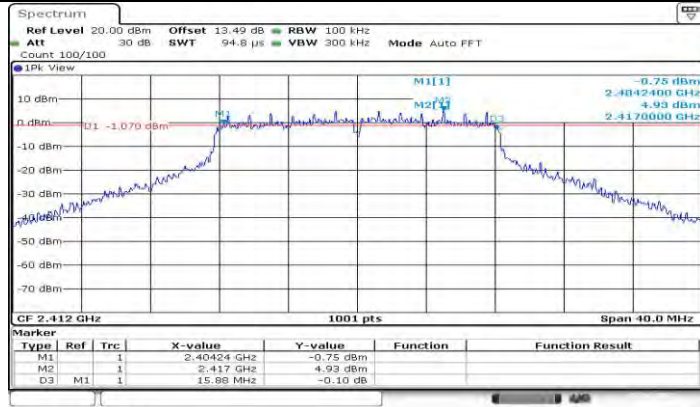

Date: 27 JAN 2022 04:39:55

11G Ant1 2412

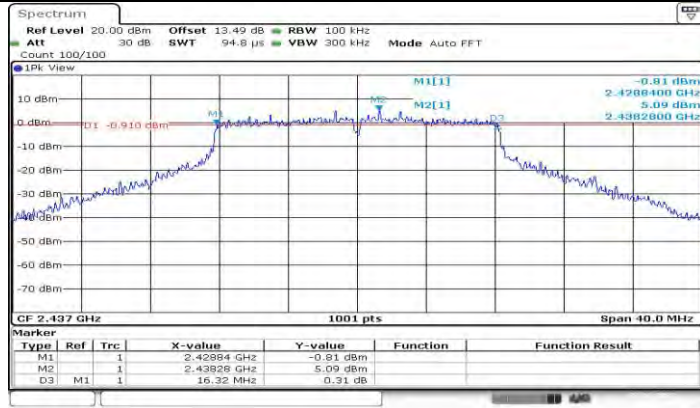

Date: 27 JAN 2022 04:39:48

11G Ant1 2437

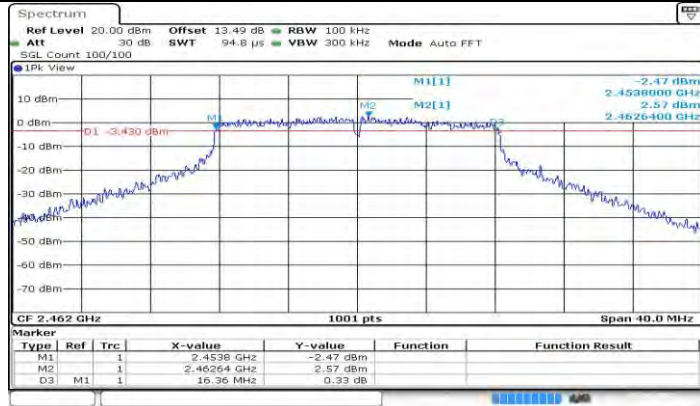

Date: 27 JAN 2022 04:42:16

11G Ant1 2462



11N20SISO Ant1\_2412

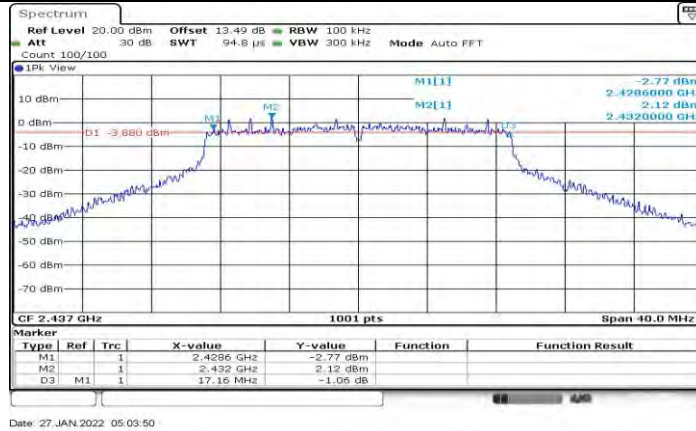

11N20SISO Ant1\_2437

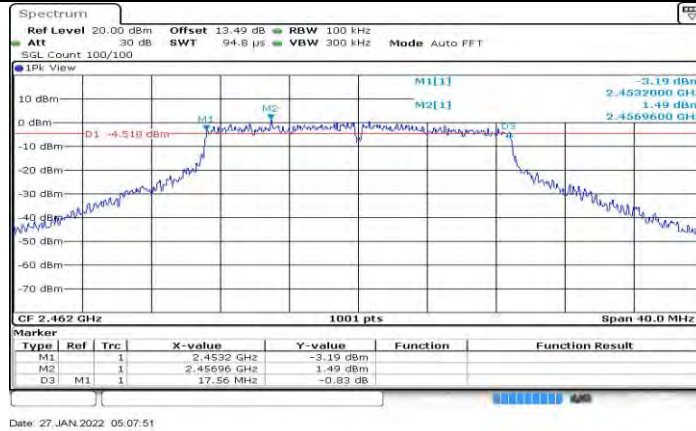

11N20SISO Ant1\_2462

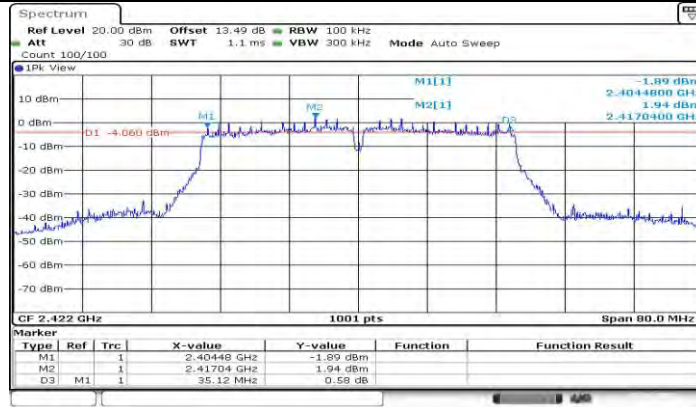

Date: 27 JAN 2022 05:11:44

11N40SISO Ant1\_2422

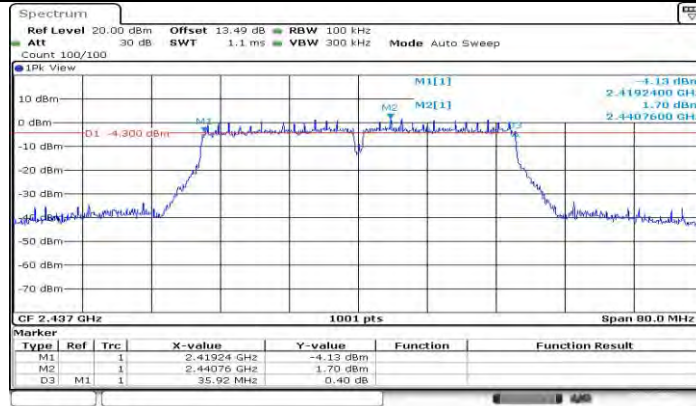

Date: 27 JAN 2022 05:16:28

11N40SISO Ant1\_2437

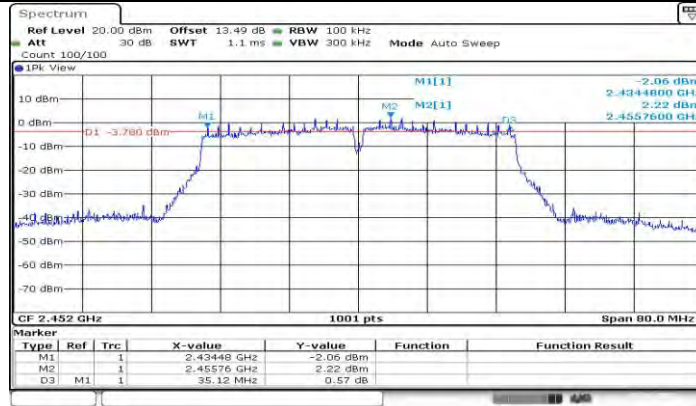

Date: 27 JAN 2022 05:19:48

11N40SISO Ant1\_2452



## 11.2. Appendix B: Occupied Channel Bandwidth

### 11.2.1. Test Result

Test Mode	Antenna	Channel	OCB [MHz]	FL[MHz]	FH[MHz]	Verdict
11B	Ant1	2412	13.866	2405.207	2419.073	PASS
		2437	13.986	2430.087	2444.073	PASS
		2462	13.786	2455.047	2468.833	PASS
11G	Ant1	2412	17.223	2403.489	2420.711	PASS
		2437	17.303	2428.409	2445.711	PASS
		2462	17.223	2453.329	2470.551	PASS
11N20SISO	Ant1	2412	18.302	2402.969	2421.271	PASS
		2437	18.422	2427.889	2446.311	PASS
		2462	18.262	2452.849	2471.111	PASS
11N40SISO	Ant1	2422	36.523	2403.938	2440.462	PASS
		2437	36.763	2418.778	2455.541	PASS
		2452	36.444	2433.938	2470.382	PASS



### 11.2.2. Test Graphs

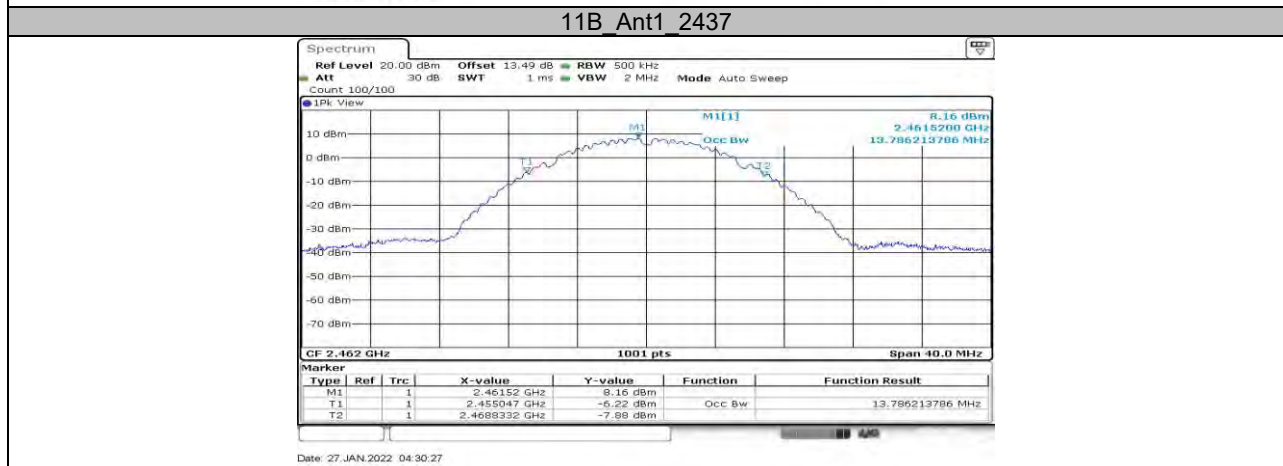
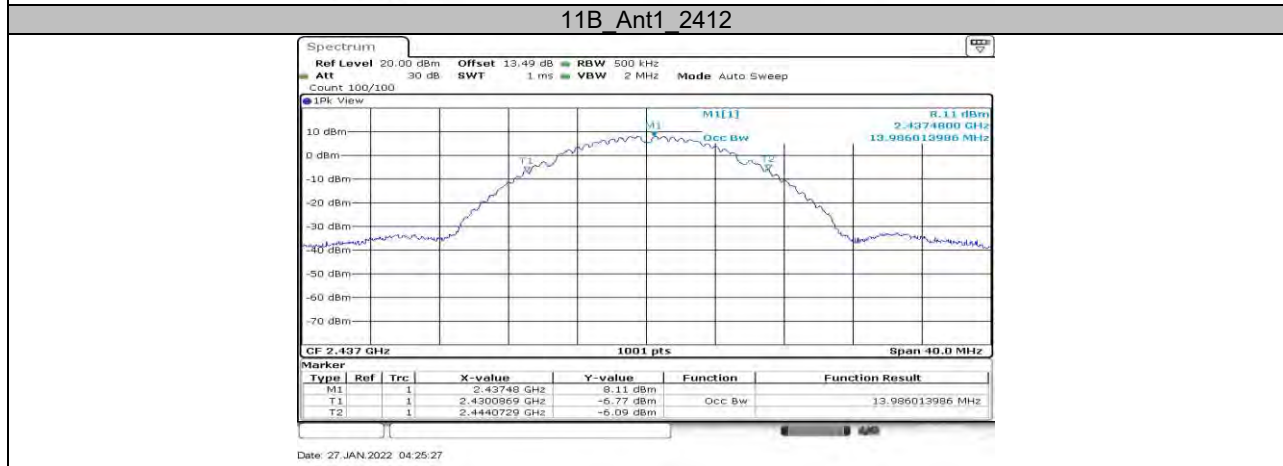
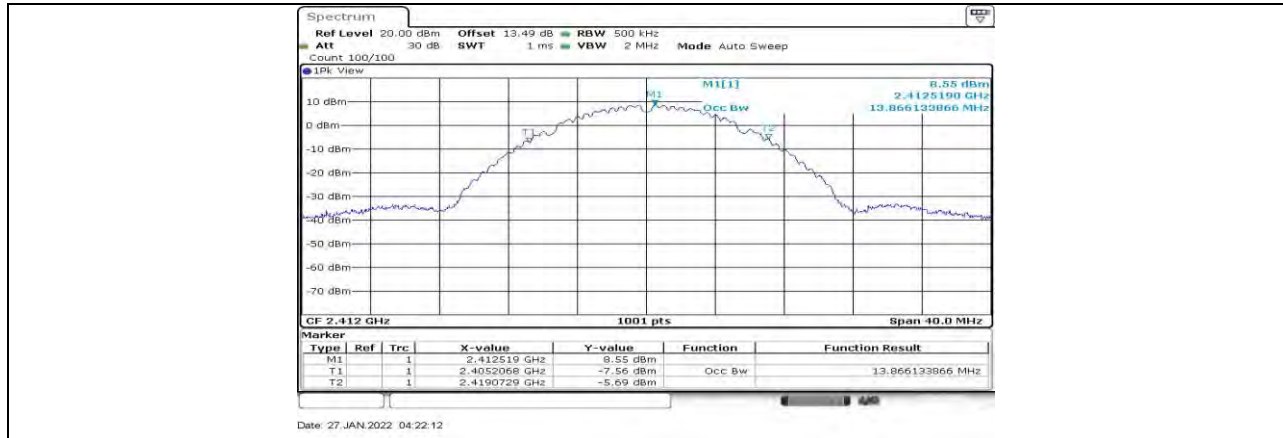

**11B Ant1 2462**



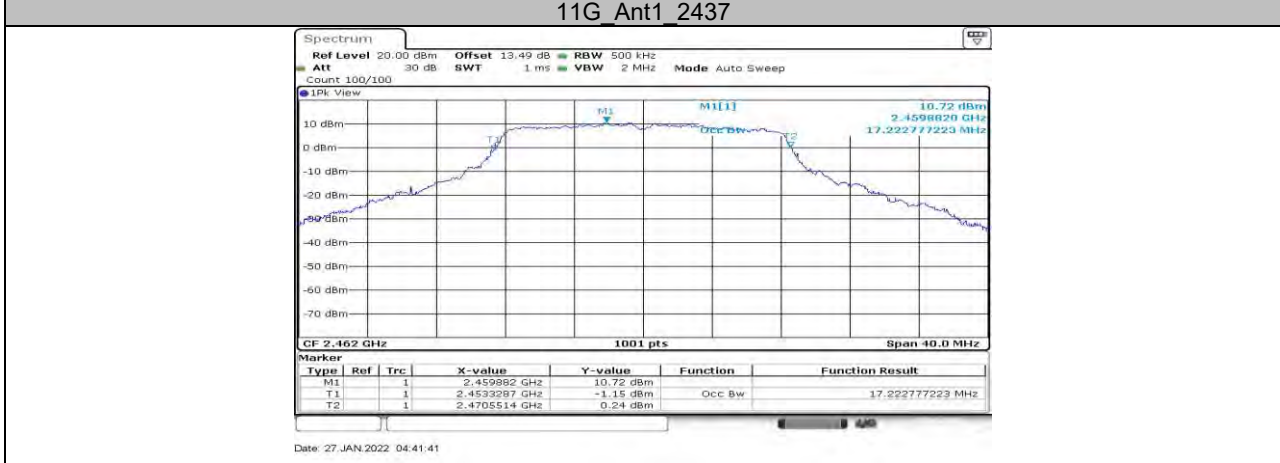
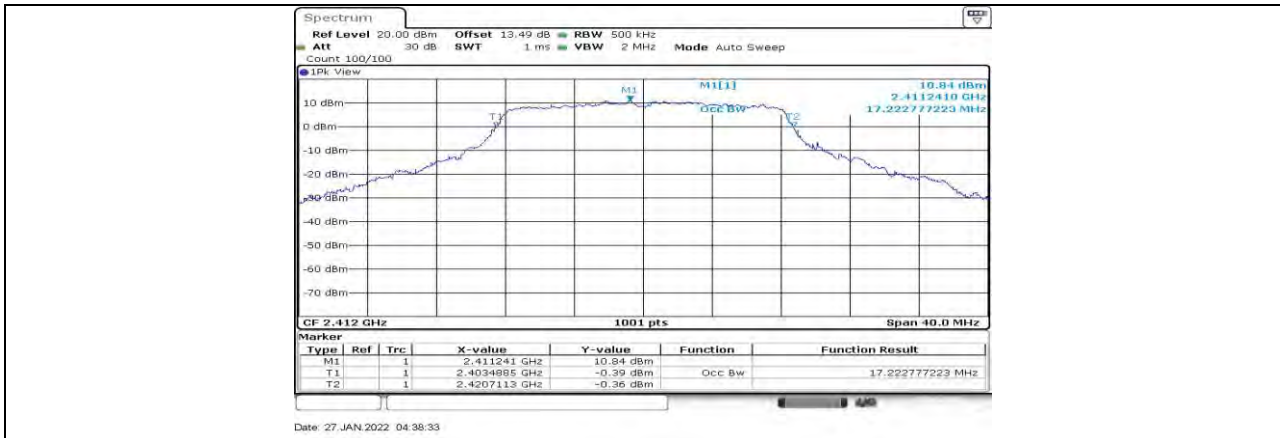

**11G Ant1 2462**



11N20SISO Ant1\_2412



11N20SISO Ant1\_2437

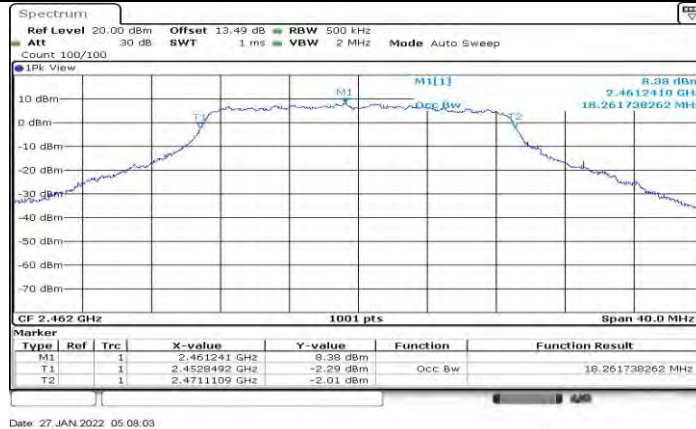

11N20SISO Ant1\_2462



11N40SISO Ant1\_2422

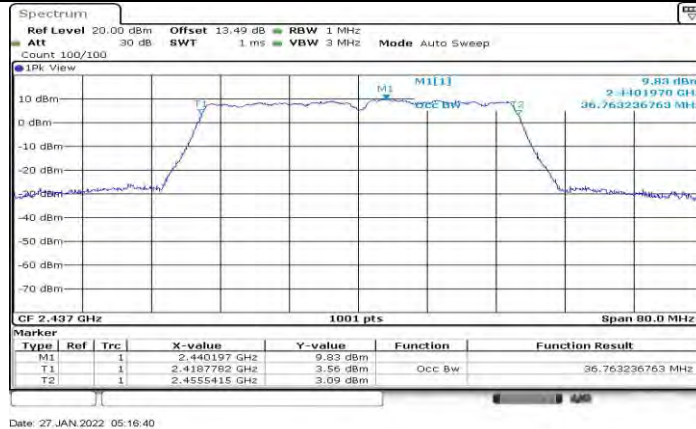

11N40SISO Ant1\_2437

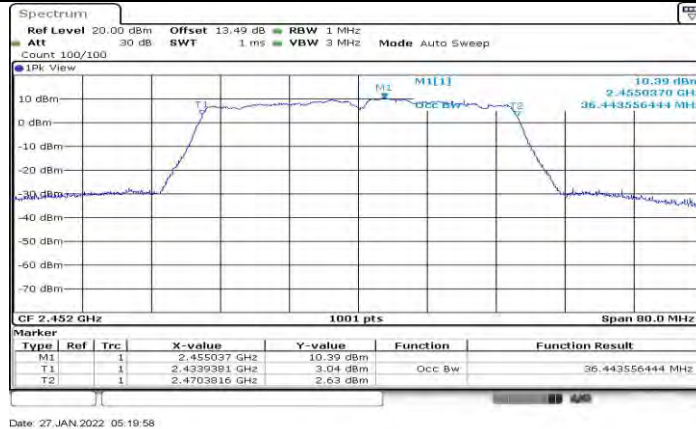

11N40SISO Ant1\_2452





### 11.3. Appendix C: Maximum conducted output power

#### 11.3.1. Test Result

Test Mode	Antenna	Channel	Result[dBm]	Limit [dBm]	Verdict
11B	Ant1	2412	16.37	≤30.00	PASS
		2437	15.93	≤30.00	PASS
		2462	15.99	≤30.00	PASS
11G	Ant1	2412	14.28	≤30.00	PASS
		2437	15.23	≤30.00	PASS
		2462	16.13	≤30.00	PASS
11N20SISO	Ant1	2412	13.61	≤30.00	PASS
		2437	13.25	≤30.00	PASS
		2462	13.23	≤30.00	PASS
11N40SISO	Ant1	2422	14.30	≤30.00	PASS
		2437	14.43	≤30.00	PASS
		2452	14.28	≤30.00	PASS

Note: 1. Conducted Power=Meas. Level+ Correction Factor

2. The Duty Cycle Factor (refer to section 7.1) had already compensated to the test data.



**11.4. Appendix D: Maximum power spectral density**  
**11.4.1. Test Result**

Test Mode	Antenna	Channel	Result[dBm/3kHz]	Limit[dBm/3kHz]	Verdict
11B	Ant1	2412	-13.26	≤8.00	PASS
		2437	-15.14	≤8.00	PASS
		2462	-14.87	≤8.00	PASS
11G	Ant1	2412	-16.67	≤8.00	PASS
		2437	-16.95	≤8.00	PASS
		2462	-15.2	≤8.00	PASS
11N20SISO	Ant1	2412	-17.28	≤8.00	PASS
		2437	-17.77	≤8.00	PASS
		2462	-17.06	≤8.00	PASS
11N40SISO	Ant1	2422	-17.65	≤8.00	PASS
		2437	-18.26	≤8.00	PASS
		2452	-18.63	≤8.00	PASS

### 11.4.2. Test Graphs

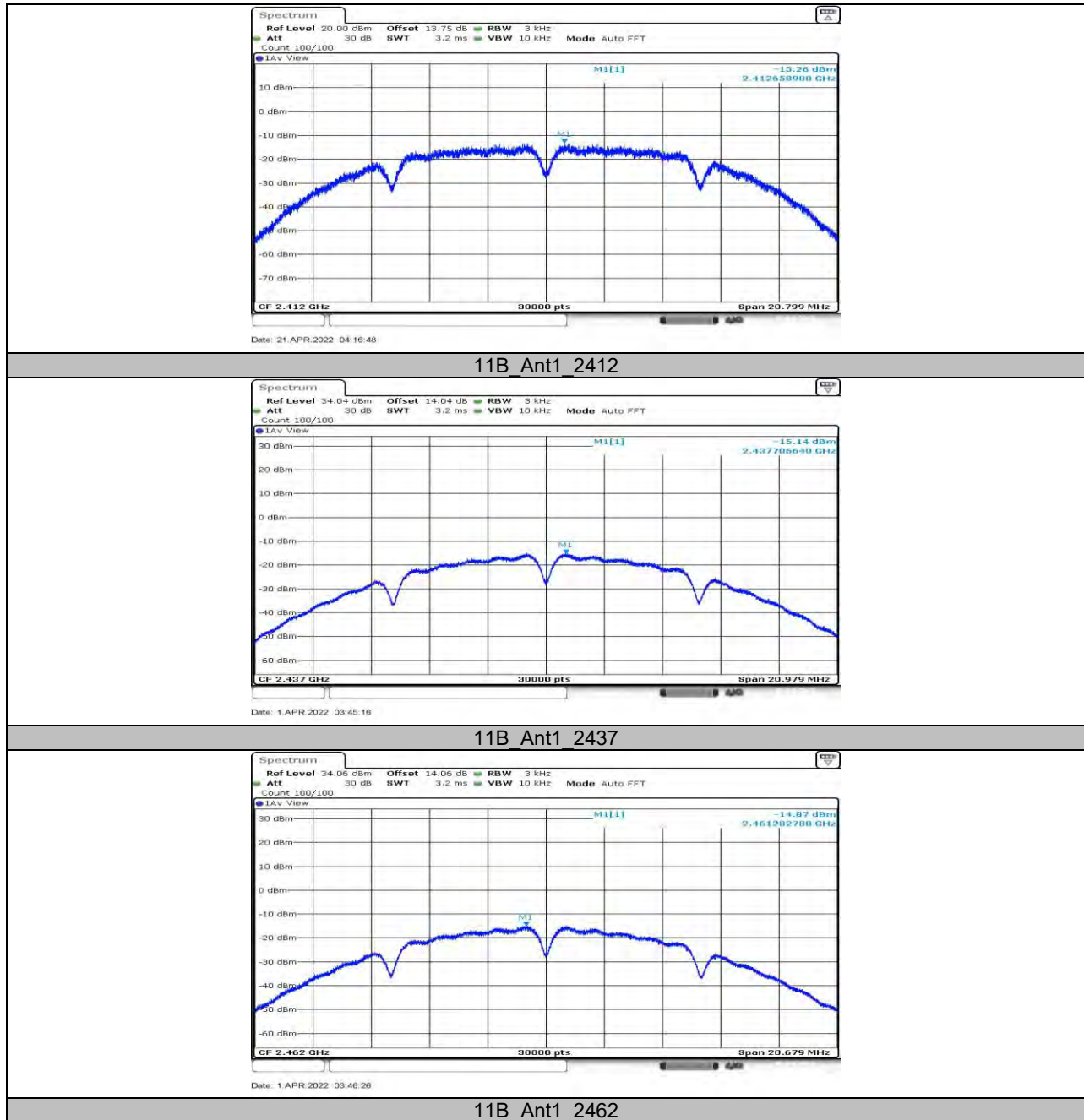

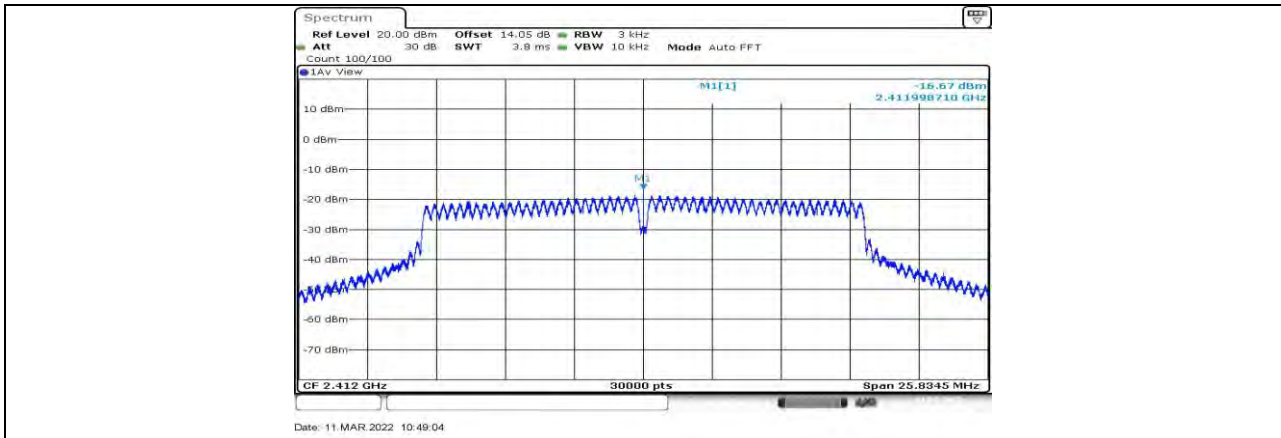

11G Ant1\_2412

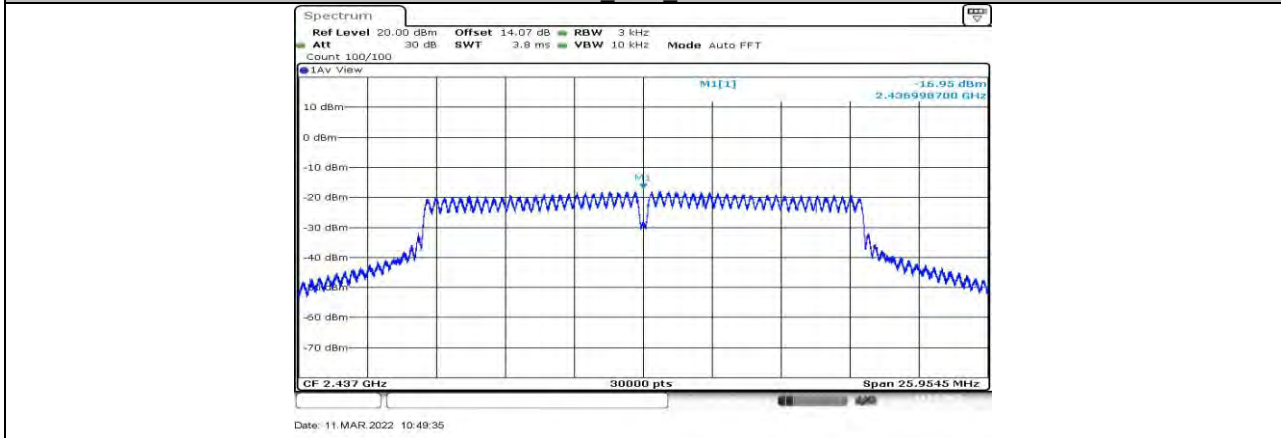

11G Ant1\_2437

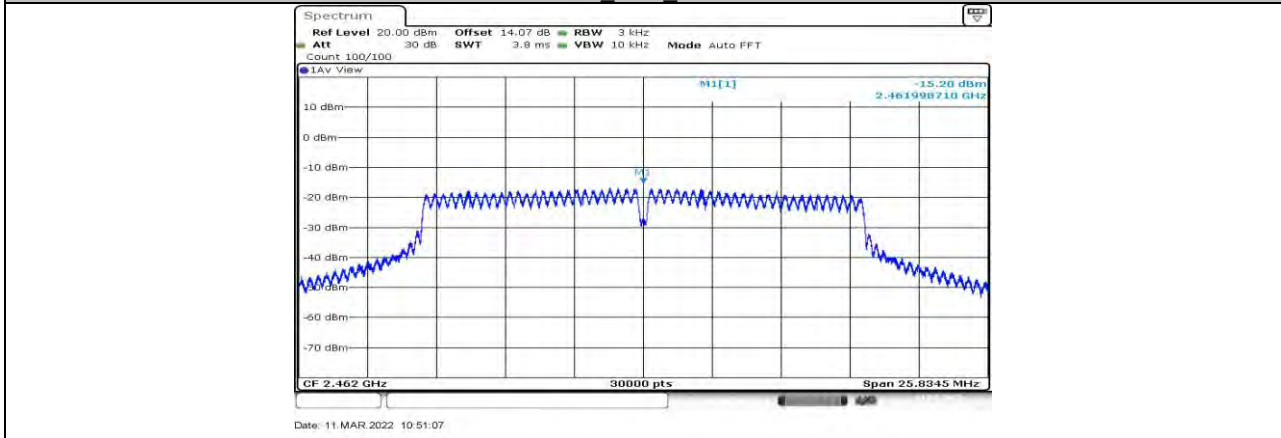

11G Ant1\_2462

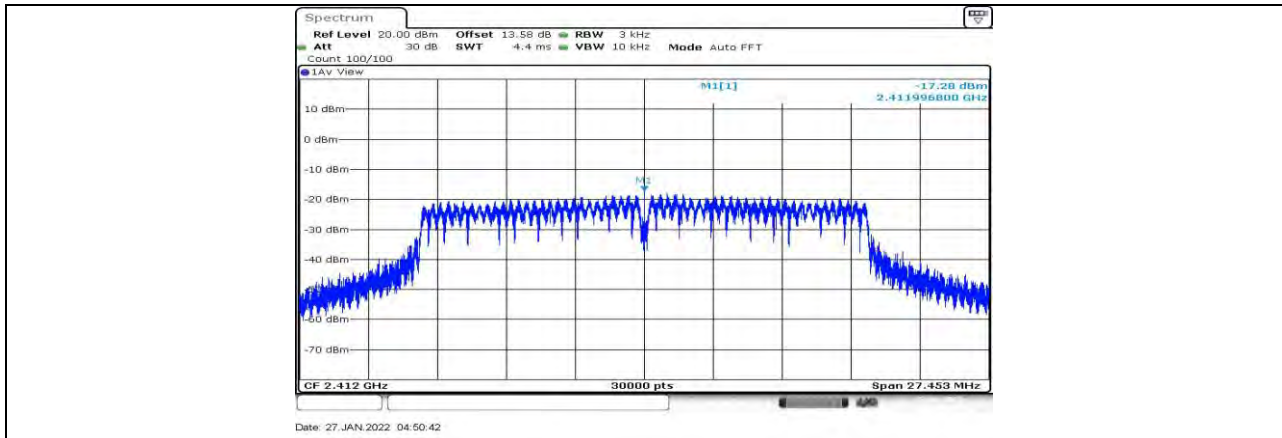

11N20SISO Ant1\_2412

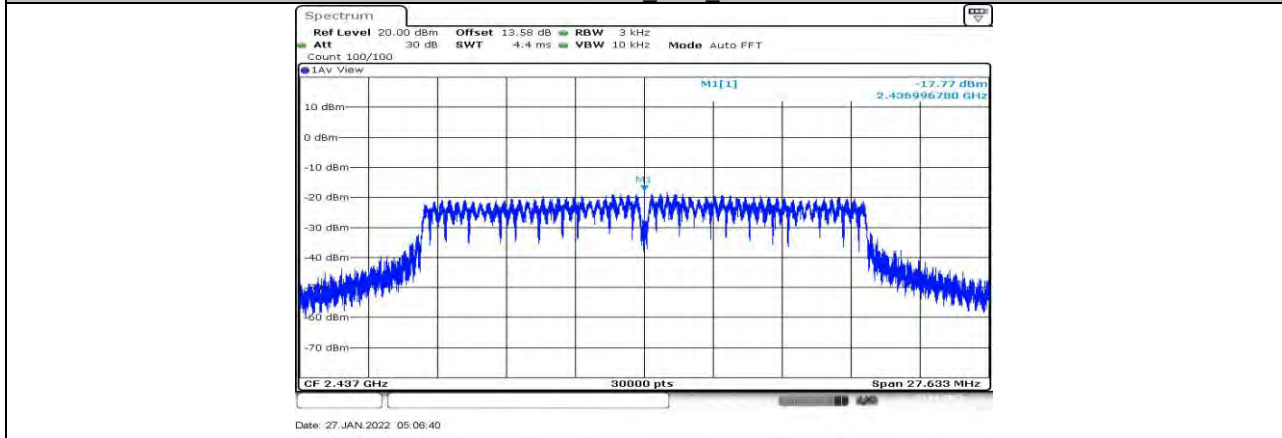

11N20SISO Ant1\_2437

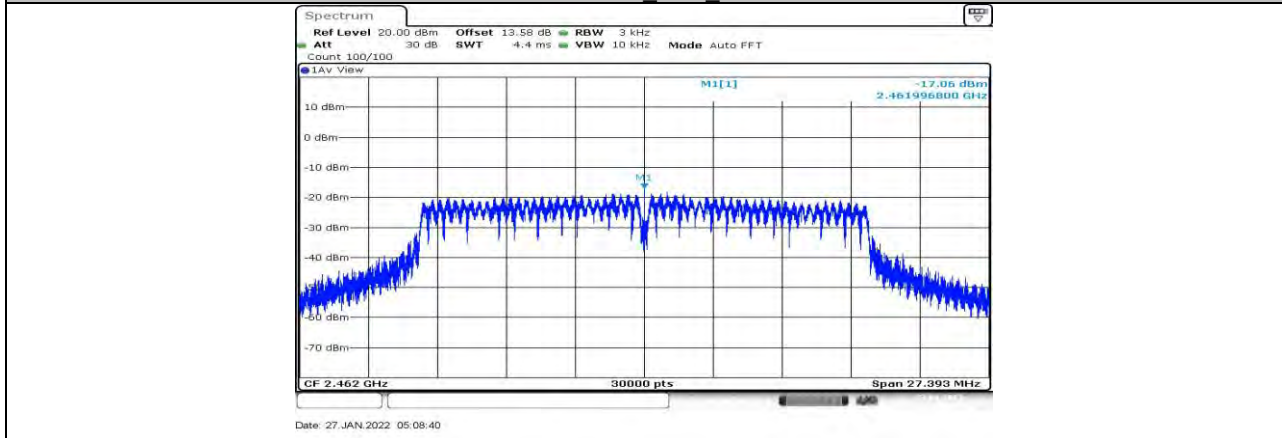

11N20SISO Ant1\_2462

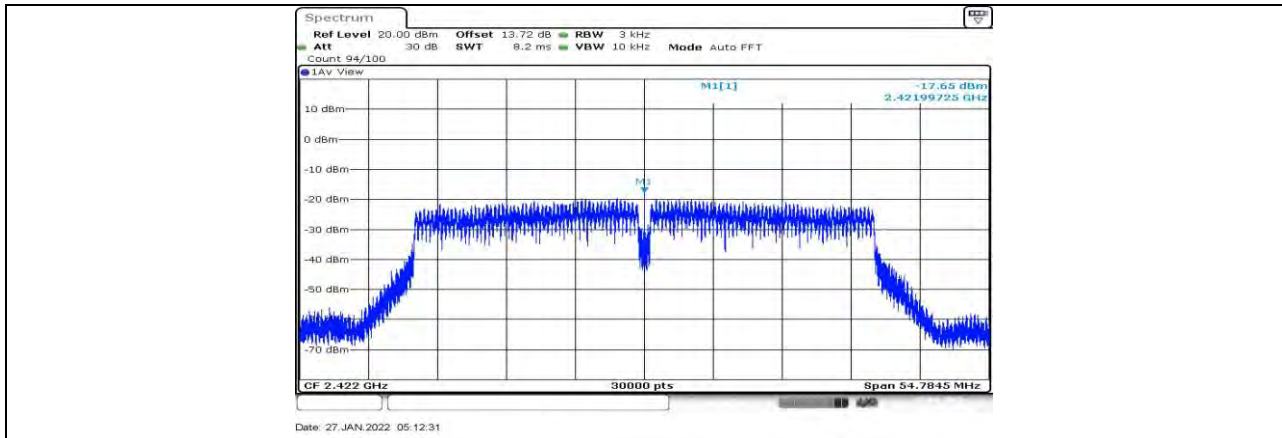

11N40SISO Ant1\_2422

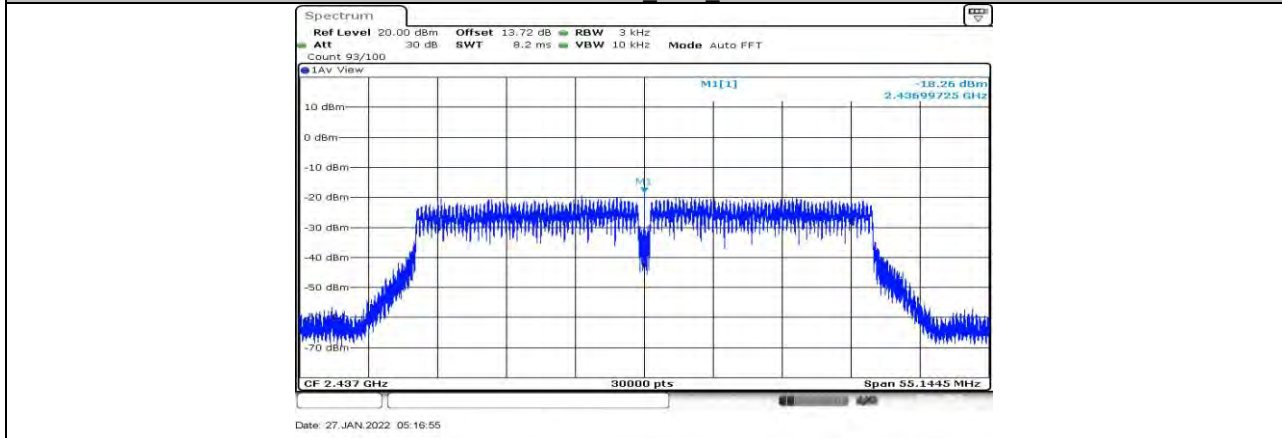

11N40SISO Ant1\_2437

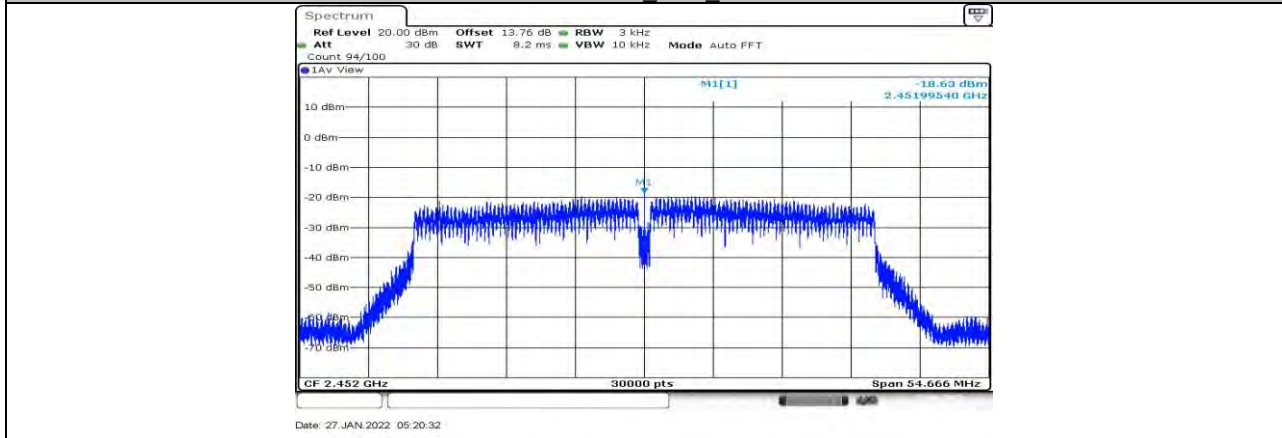

11N40SISO Ant1\_2452



## 11.5. Appendix E: Band edge measurements

### 11.5.1. Test Result

Test Mode	Antenna	ChName	Channel	RefLevel[dBm]	Result[dBm]	Limit[dBm]	Verdict
11B	Ant1	Low	2412	6.90	-41.29	≤-23.1	PASS
		High	2462	7.82	-46.12	≤-22.18	PASS
11G	Ant1	Low	2412	5.07	-25.49	≤-24.93	PASS
		High	2462	3.52	-44.59	≤-26.48	PASS
11N20SISO	Ant1	Low	2412	3.91	-26.1	≤-26.09	PASS
		High	2462	3.47	-44.97	≤-26.53	PASS
11N40SISO	Ant1	Low	2422	1.03	-33.96	≤-28.97	PASS
		High	2452	0.14	-41.46	≤-29.86	PASS



### 11.5.2. Test Graphs

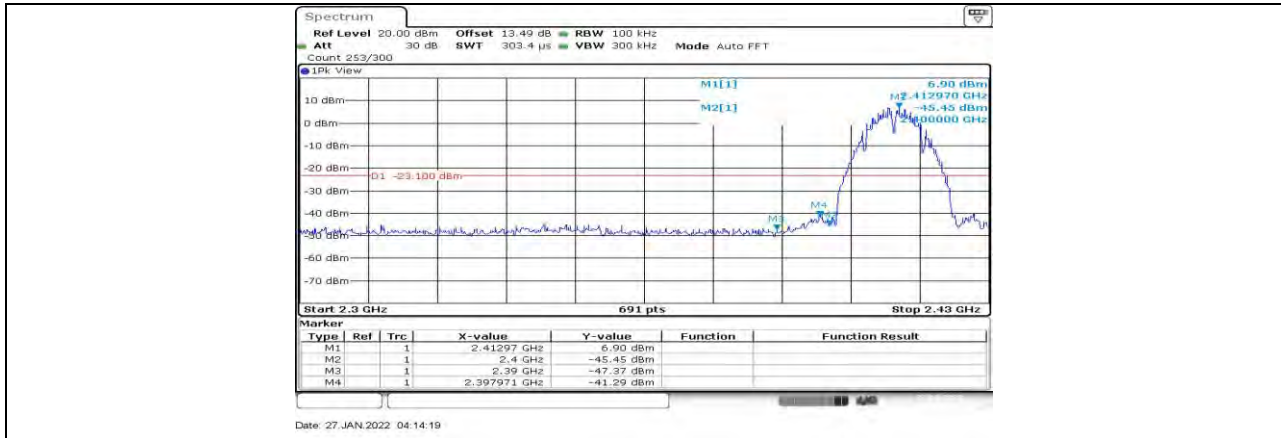

11B Ant1 Low 2412



11B Ant1 High 2462

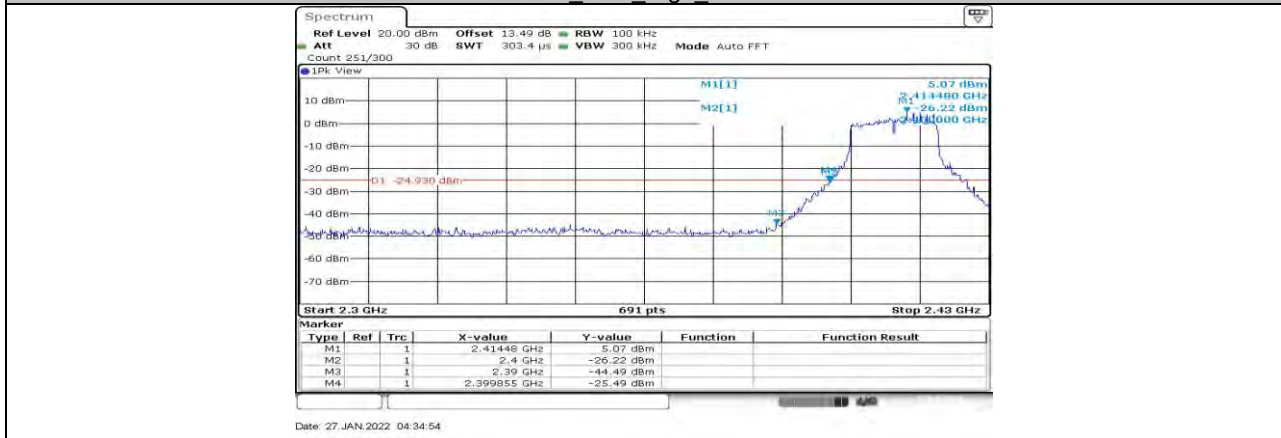

11G Ant1 Low 2412



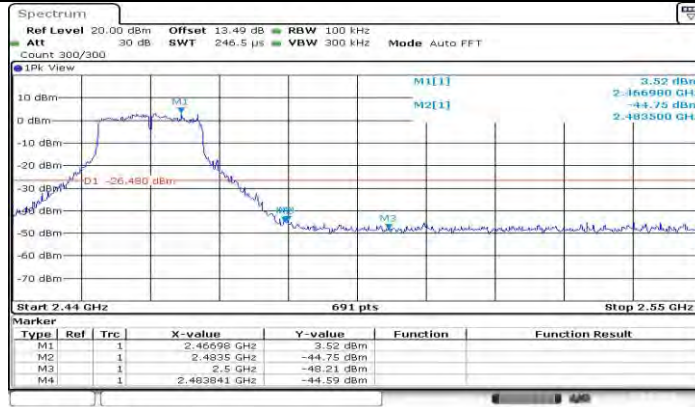

11G Ant1 High 2462



11N20SISO Ant1 Low 2412

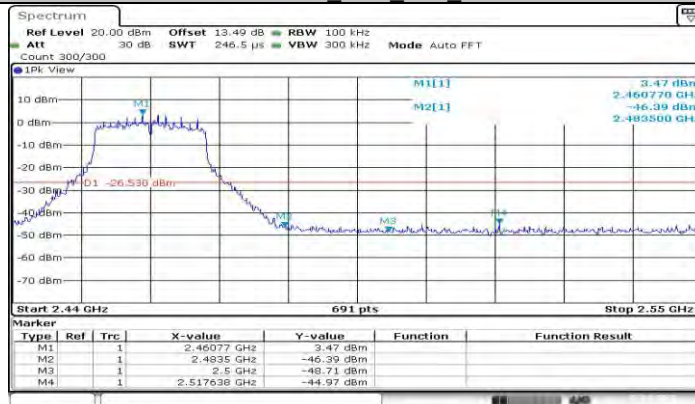

11N20SISO Ant1 High 2462

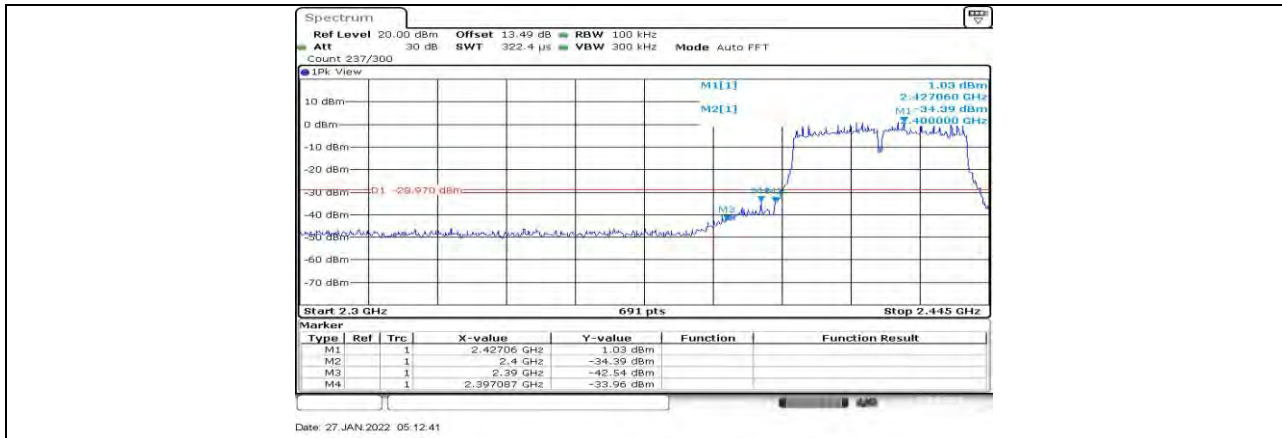

11N40SISO Ant1 Low 2422

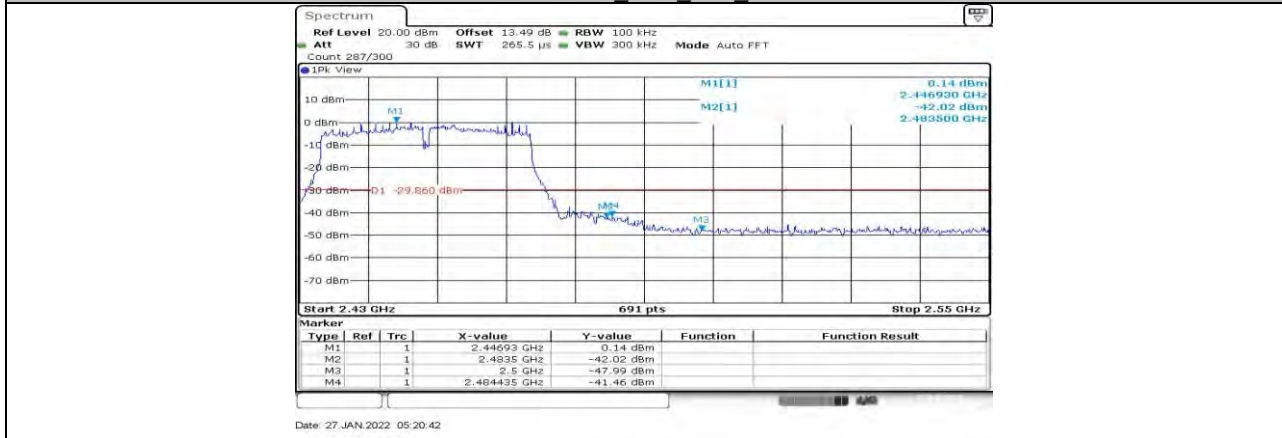

11N40SISO Ant1 High 2452

## 11.6. Appendix F: Conducted Spurious Emission

### 11.6.1. Test Result

Test Mode	Antenna	Channel	FreqRange [Mhz]	Result [dBm]	Limit [dBm]	Verdict
11B	Ant1	2412	Reference	6.95	---	PASS
			30~1000	-54.53	≤-23.05	PASS
			1000~26500	-49.55	≤-23.05	PASS
		2437	Reference	7.69	---	PASS
			30~1000	-54.76	≤-22.31	PASS
			1000~26500	-49.54	≤-22.31	PASS
		2462	Reference	7.95	---	PASS
			30~1000	-54.09	≤-22.05	PASS
			1000~26500	-48.63	≤-22.05	PASS
11G	Ant1	2412	Reference	6.01	---	PASS
			30~1000	-54.58	≤-23.99	PASS
			1000~26500	-48.65	≤-23.99	PASS
		2437	Reference	6.44	---	PASS
			30~1000	-54.12	≤-23.56	PASS
			1000~26500	-49.26	≤-23.56	PASS
		2462	Reference	6.27	---	PASS
			30~1000	-53.19	≤-23.73	PASS
			1000~26500	-48.51	≤-23.73	PASS
11N20SISO	Ant1	2412	Reference	4.77	---	PASS
			30~1000	-54.3	≤-25.23	PASS
			1000~26500	-49.22	≤-25.23	PASS
		2437	Reference	2.89	---	PASS
			30~1000	-54.69	≤-27.11	PASS
			1000~26500	-49.04	≤-27.11	PASS
		2462	Reference	4.23	---	PASS
			30~1000	-54.98	≤-25.77	PASS
			1000~26500	-49.2	≤-25.77	PASS
11N40SISO	Ant1	2422	Reference	1.92	---	PASS
			30~1000	-53.79	≤-28.08	PASS
			1000~26500	-48.64	≤-28.08	PASS
		2437	Reference	1.73	---	PASS
			30~1000	-54.54	≤-28.27	PASS
			1000~26500	-49.25	≤-28.27	PASS
		2452	Reference	1.90	---	PASS
			30~1000	-54.59	≤-28.1	PASS
			1000~26500	-49.13	≤-28.1	PASS

### 11.6.2. Test Graphs

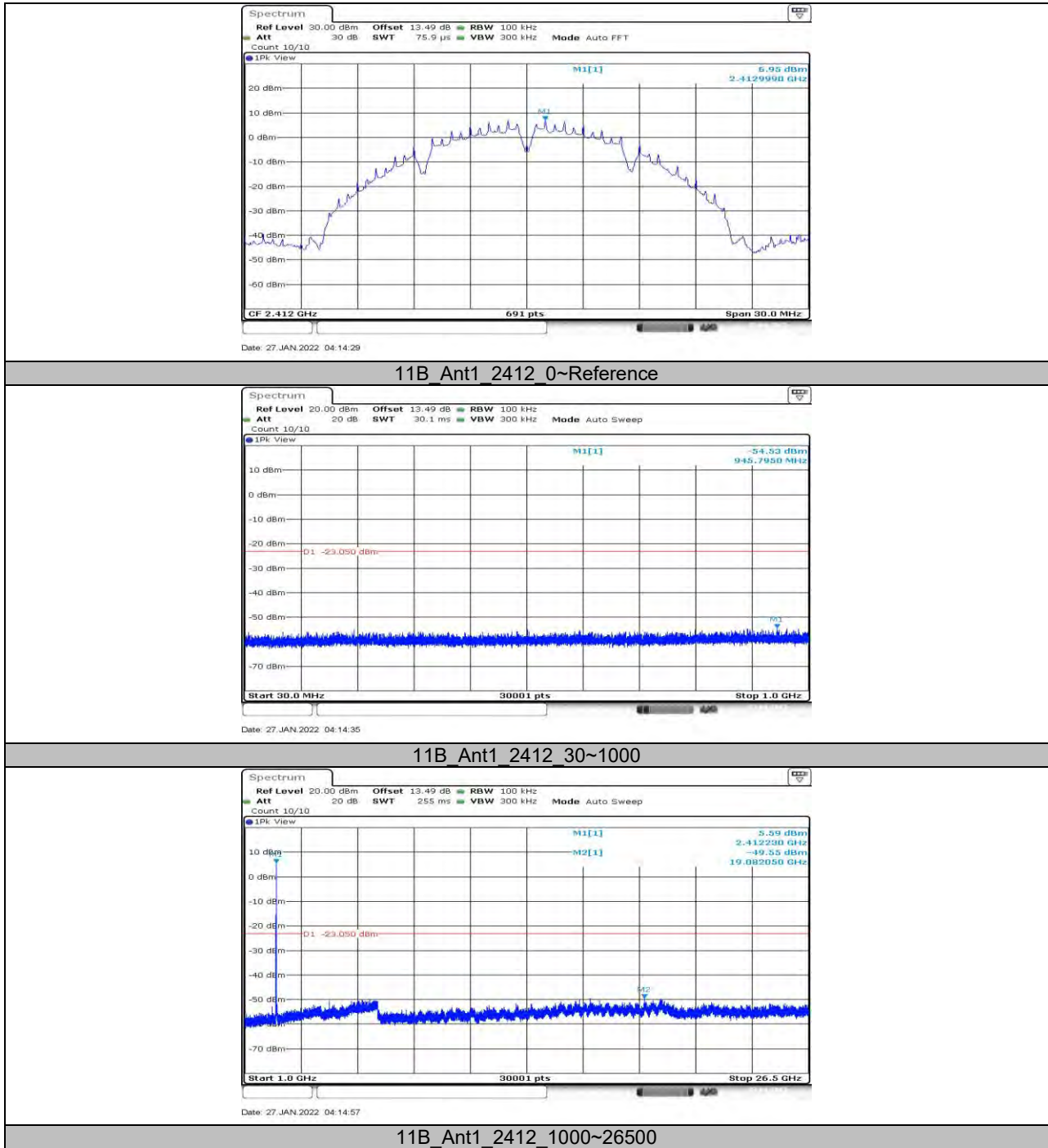

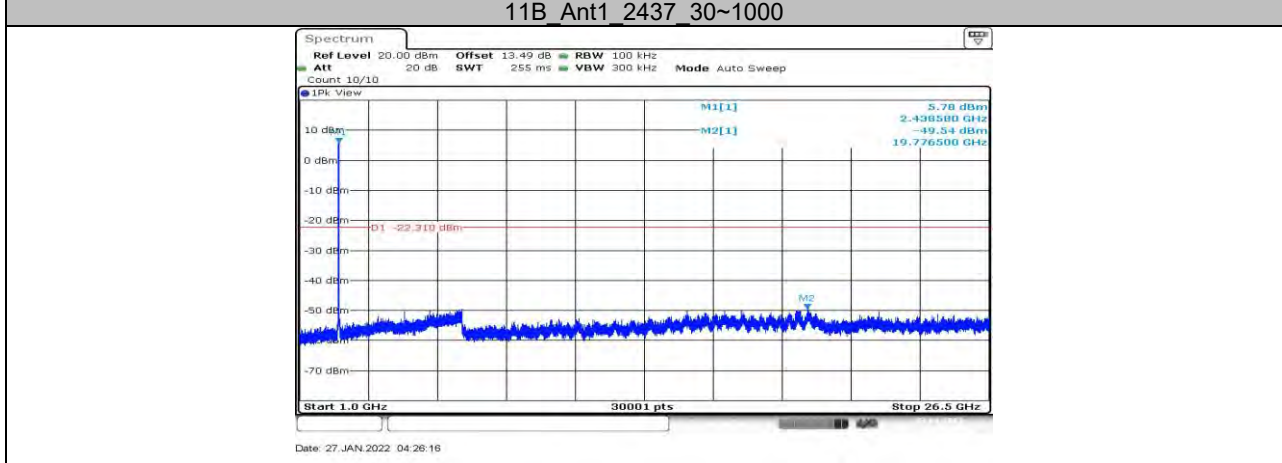
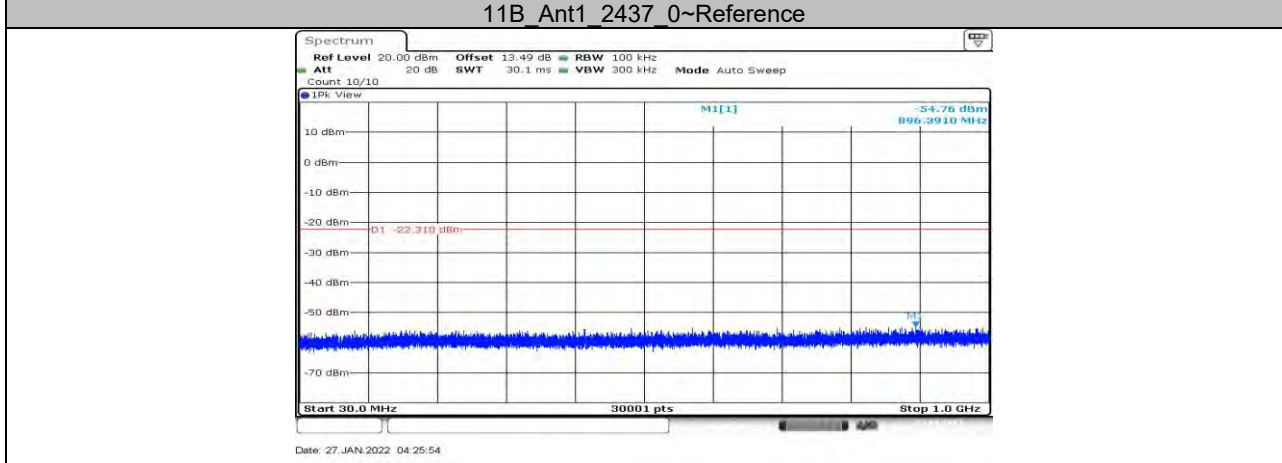
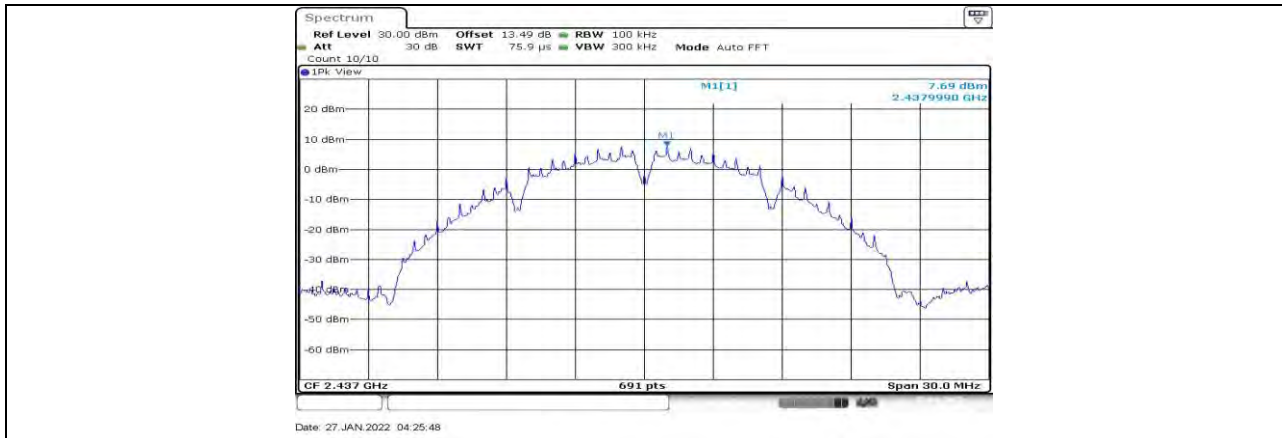



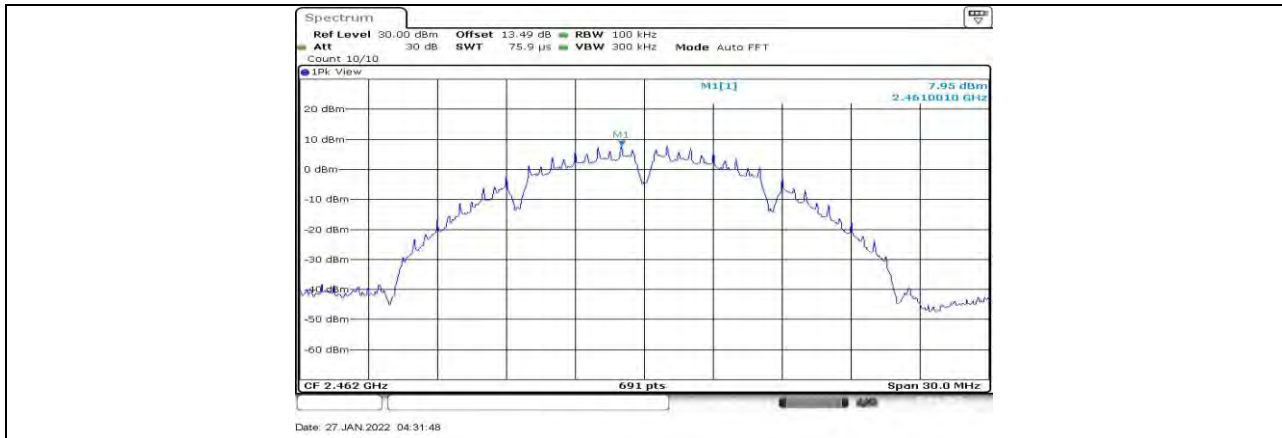

11B\_Ant1\_2462\_0~Reference

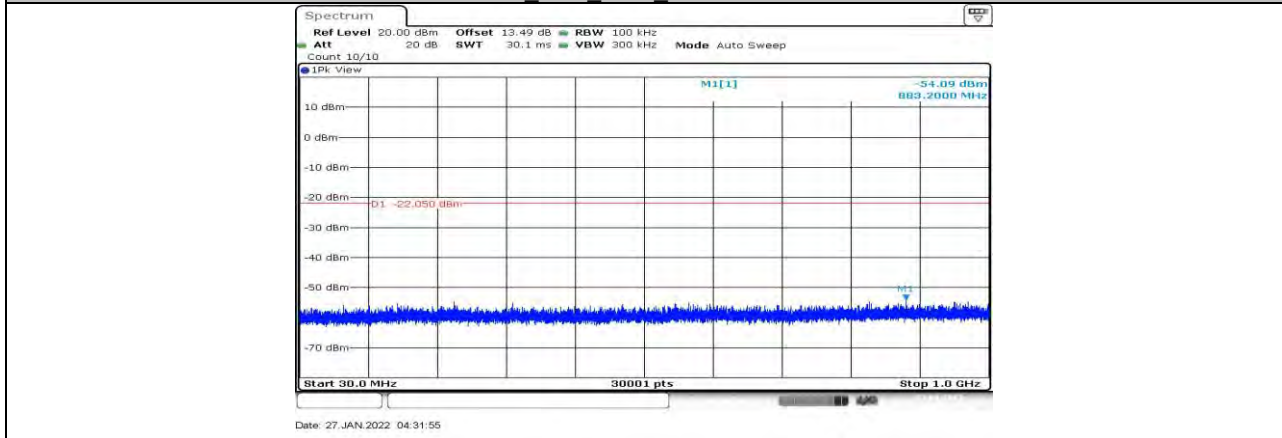

11B\_Ant1\_2462\_30~1000

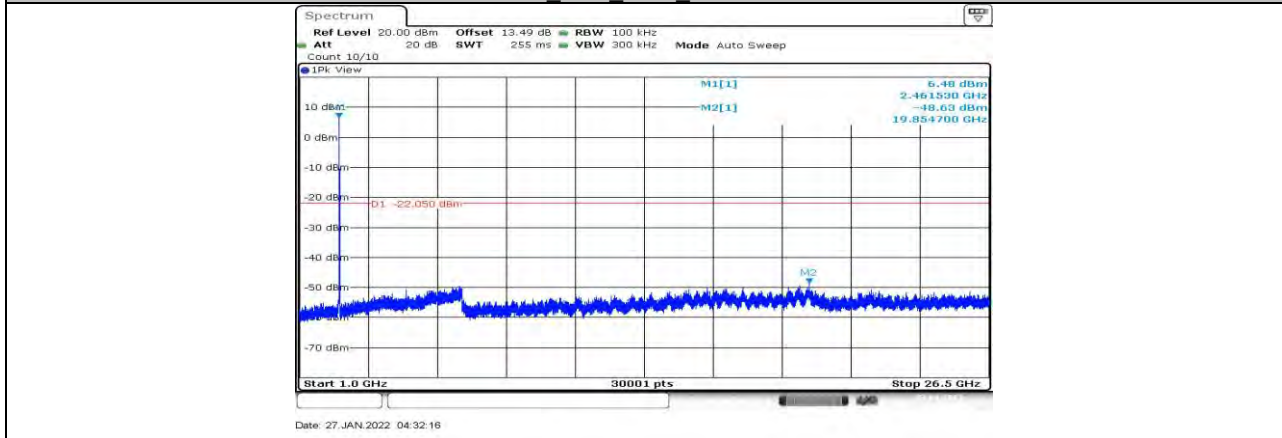

11B\_Ant1\_2462\_1000~26500

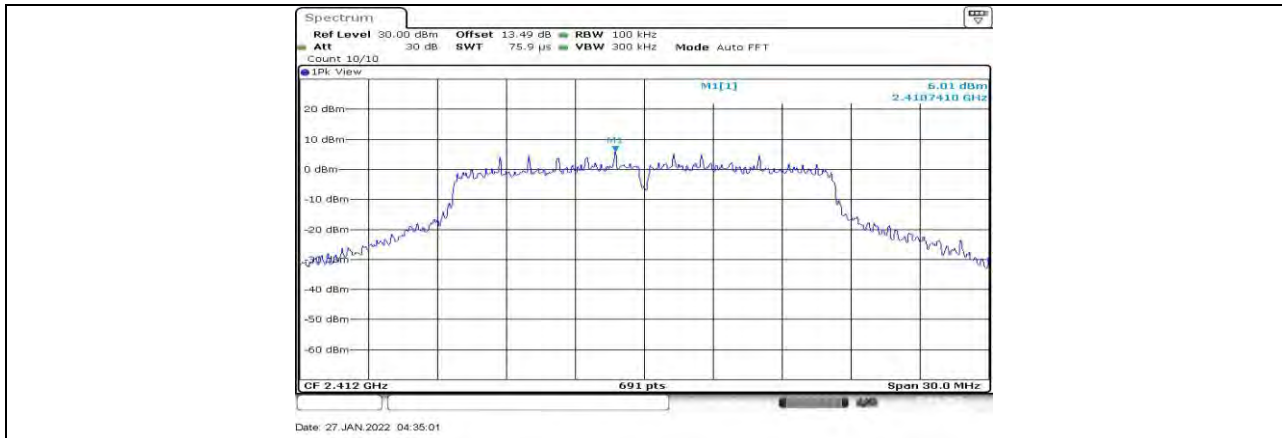

11G\_Ant1\_2412\_0~Reference

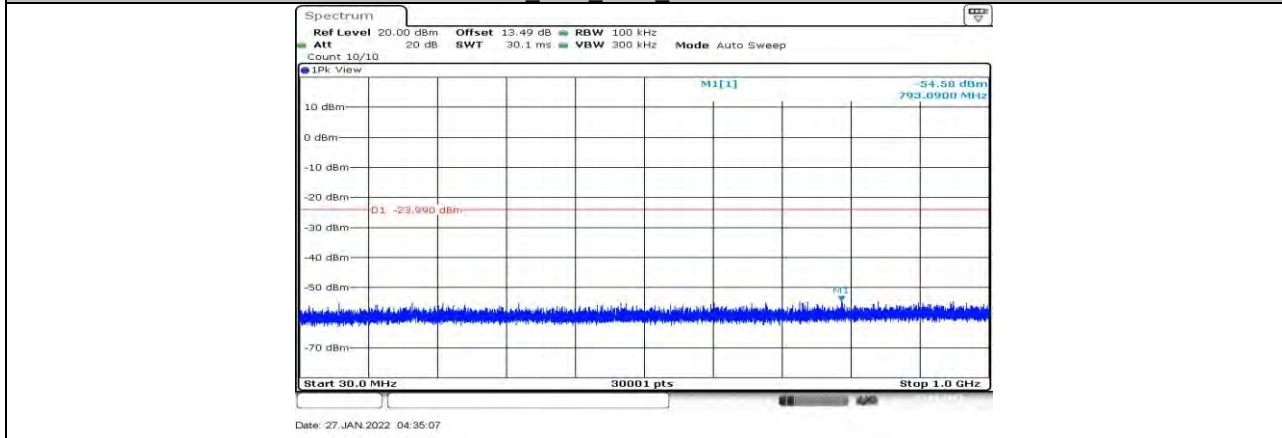

11G\_Ant1\_2412\_30~1000

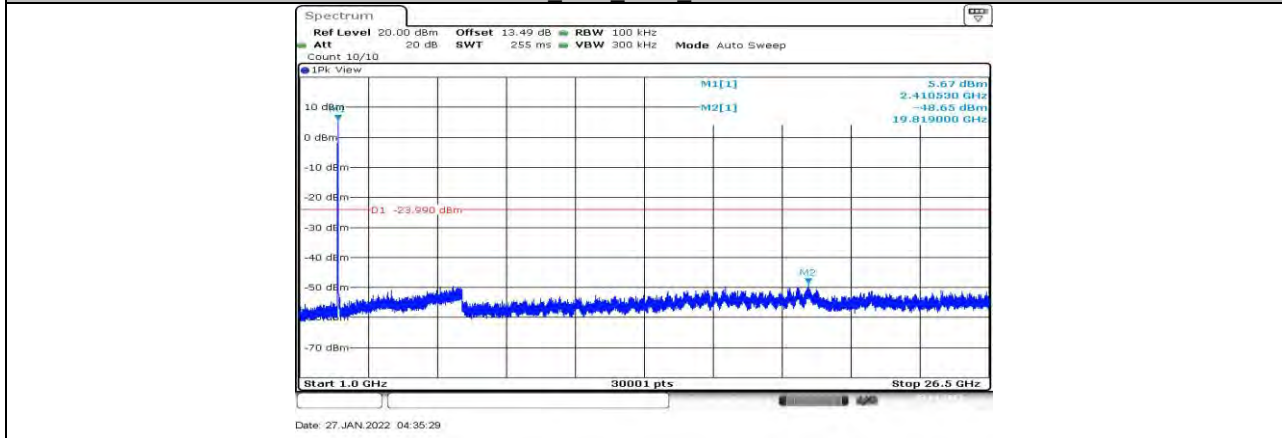

11G\_Ant1\_2412\_1000~26500

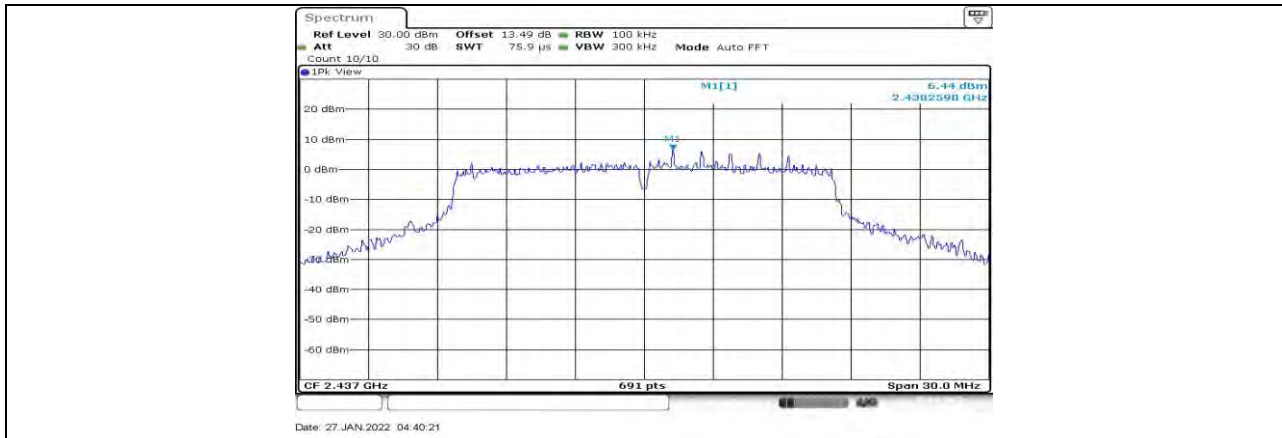

11G\_Ant1\_2437\_0~Reference

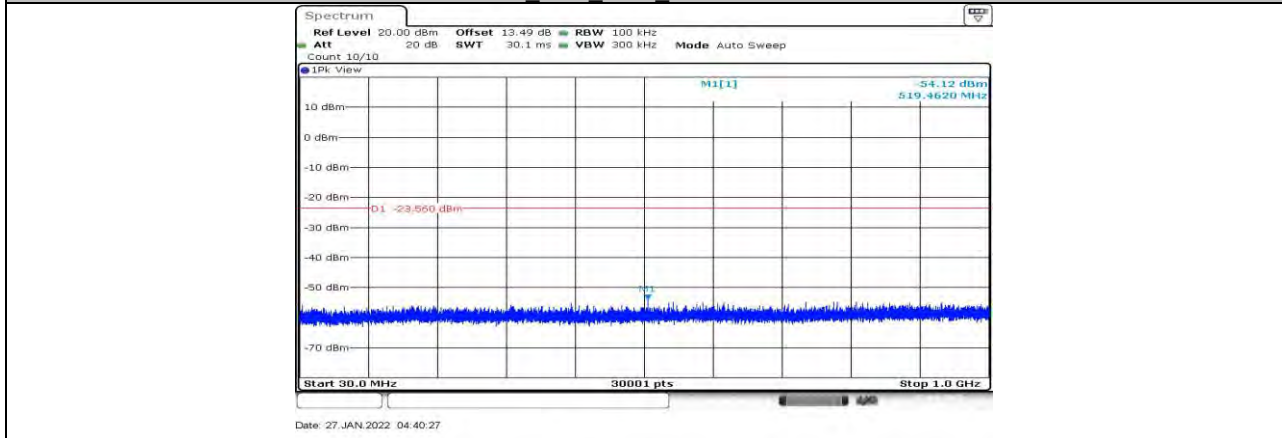

11G\_Ant1\_2437\_30~1000

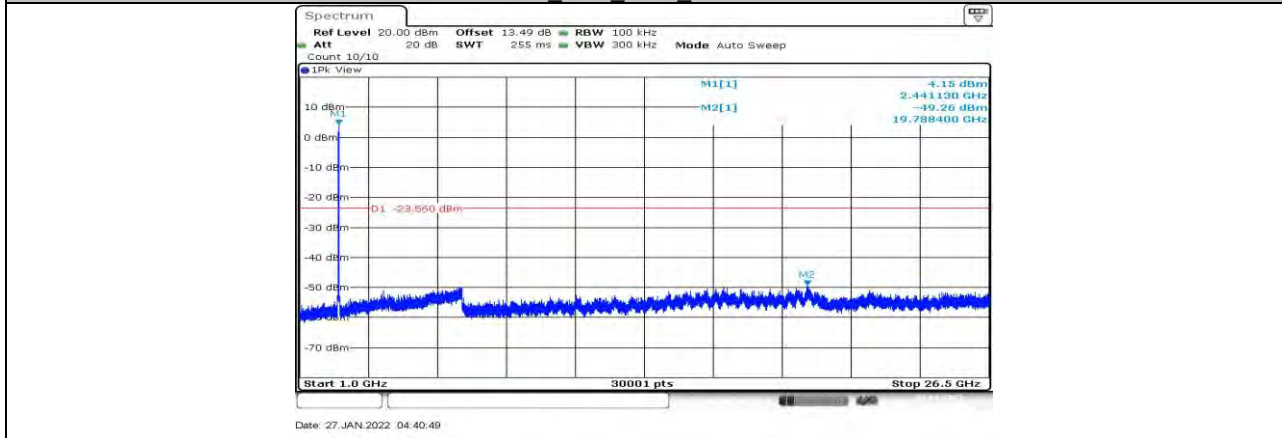

11G\_Ant1\_2437\_1000~26500



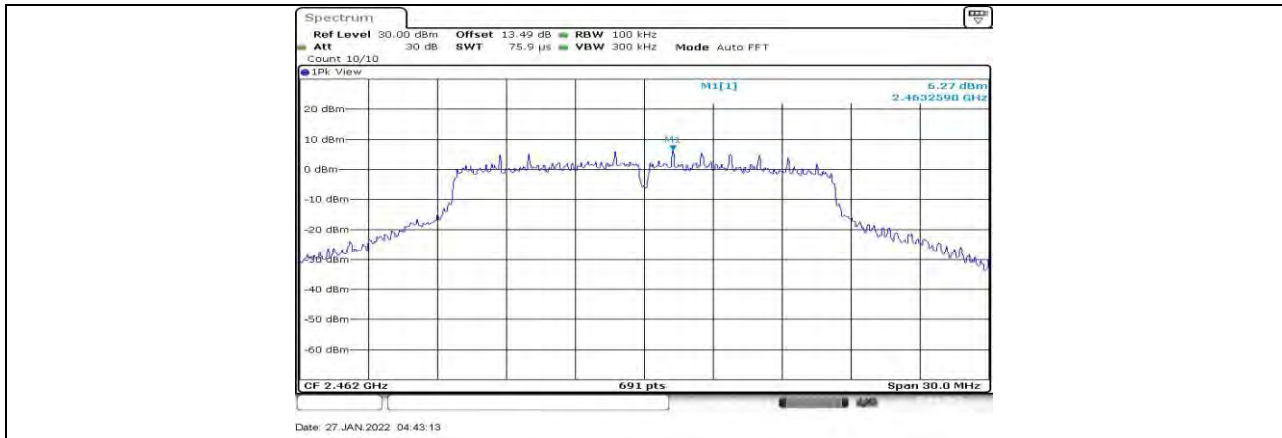

11G\_Ant1\_2462\_0~Reference

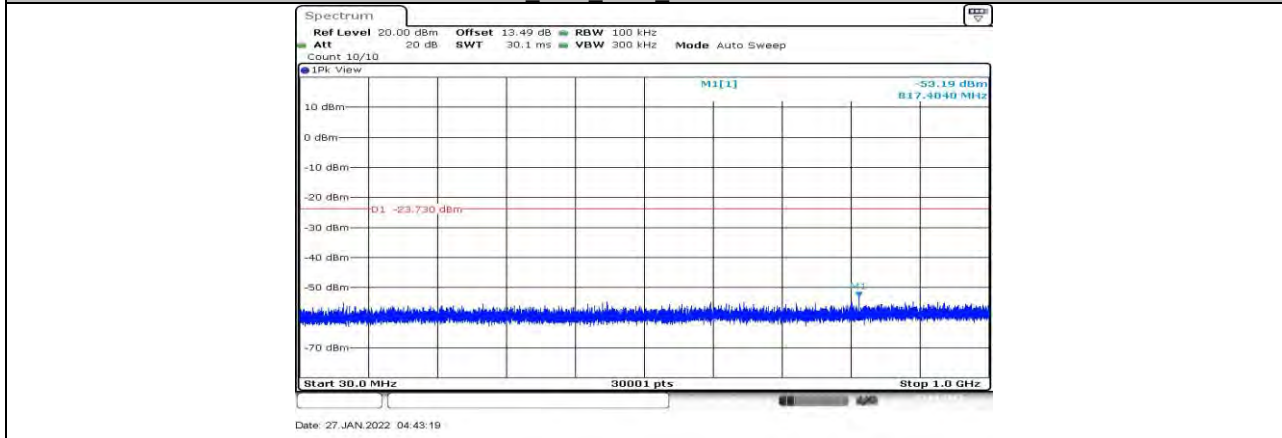

11G\_Ant1\_2462\_30~1000

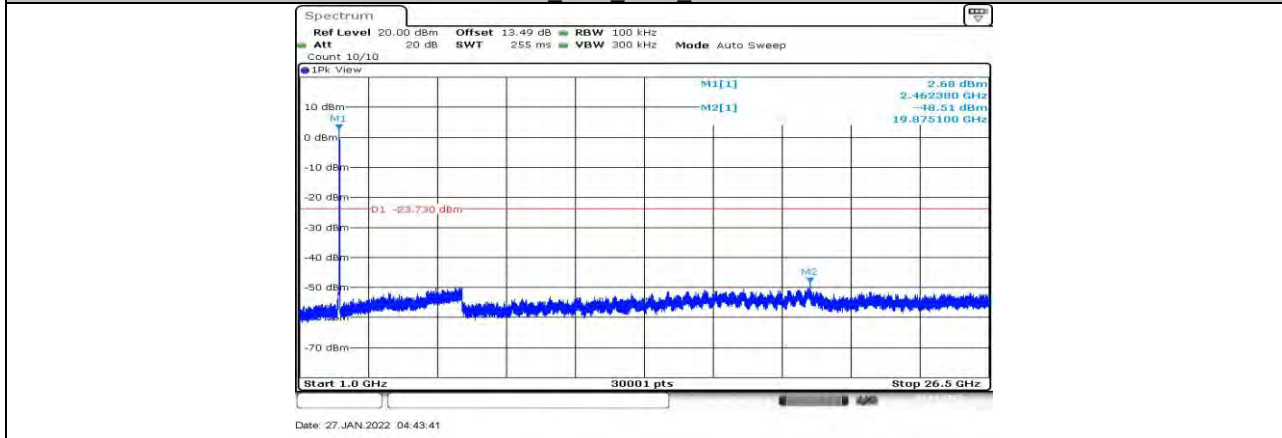

11G\_Ant1\_2462\_1000~26500

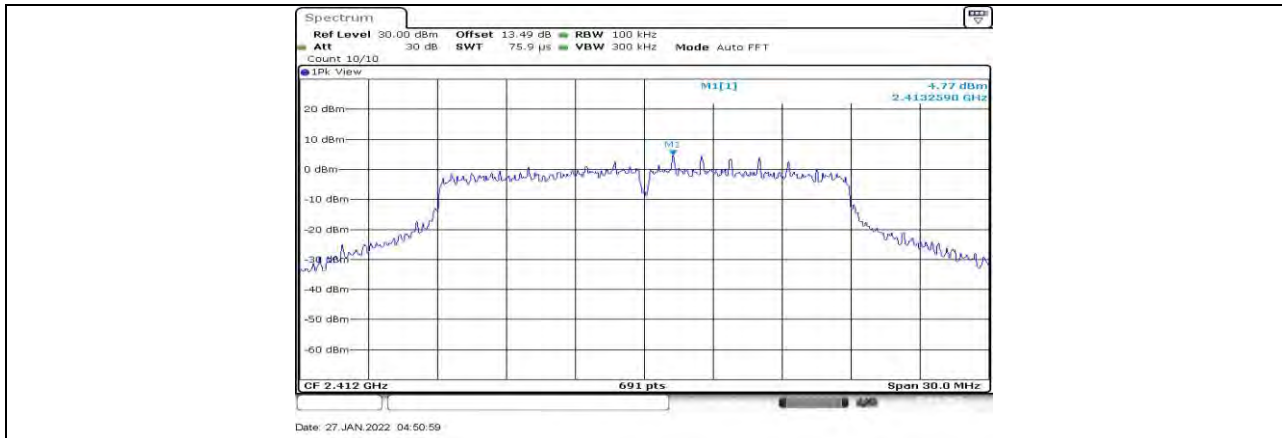

11N20SISO Ant1 2412 0~Reference

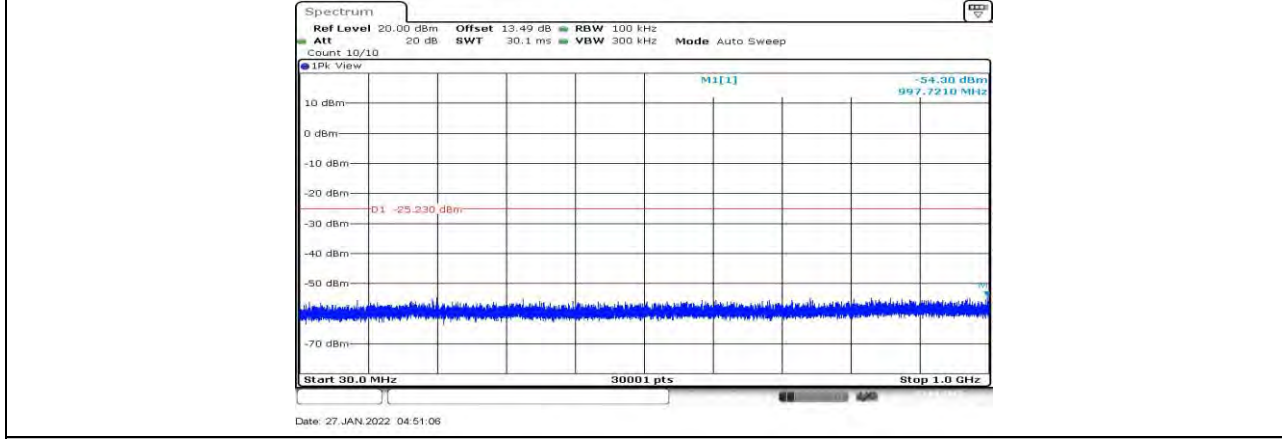

11N20SISO Ant1 2412 30~1000

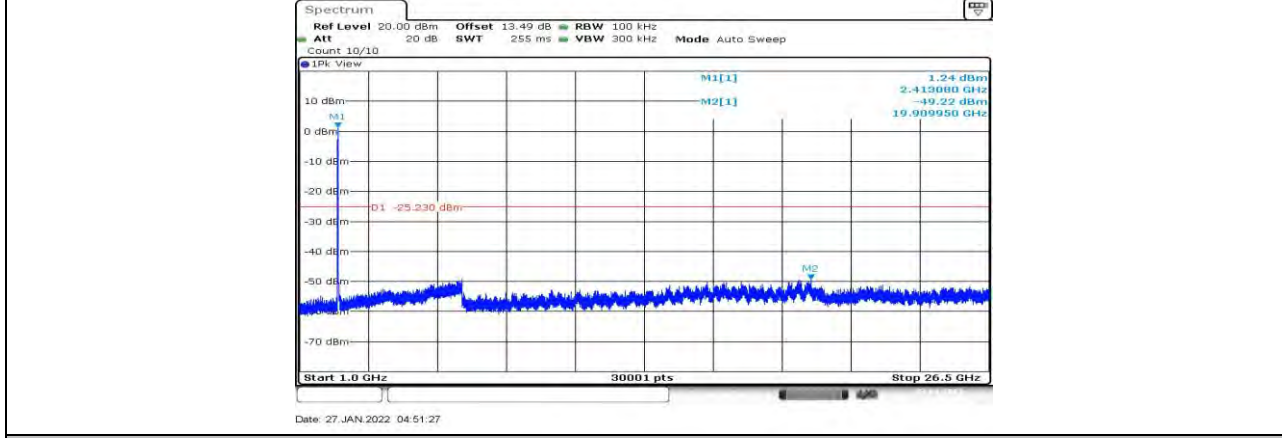

11N20SISO Ant1 2412 1000~26500

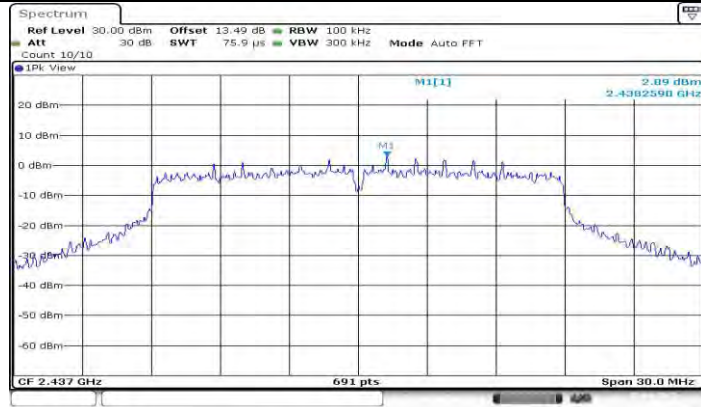

Date: 27 JAN 2022 05:04:48

11N20SISO Ant1 2437 0~Reference

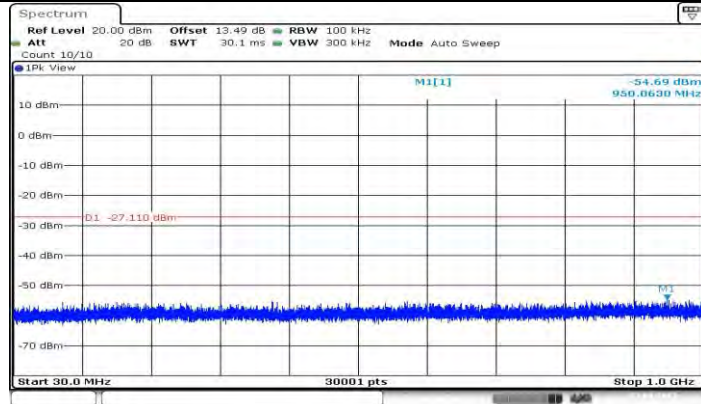

Date: 27 JAN 2022 05:04:52

11N20SISO Ant1 2437 30~1000

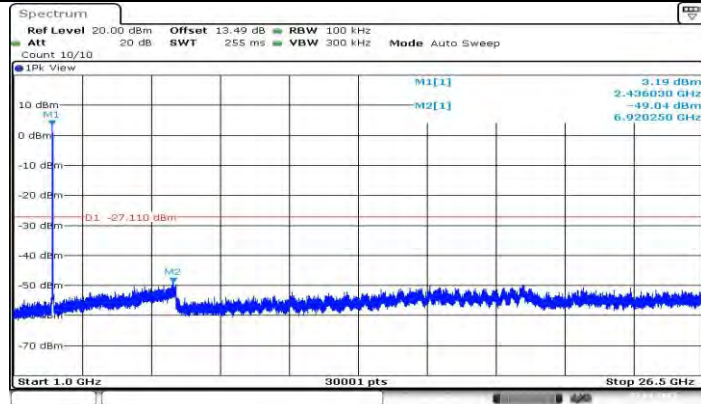

Date: 27 JAN 2022 05:05:14

11N20SISO Ant1 2437 1000~26500

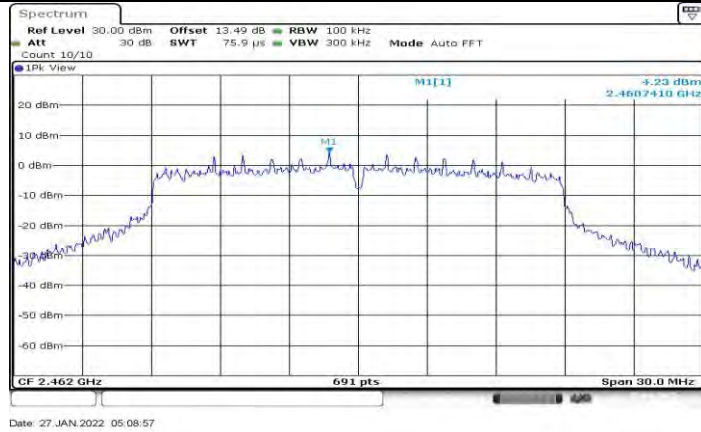

11N20SISO Ant1 2462 0~Reference

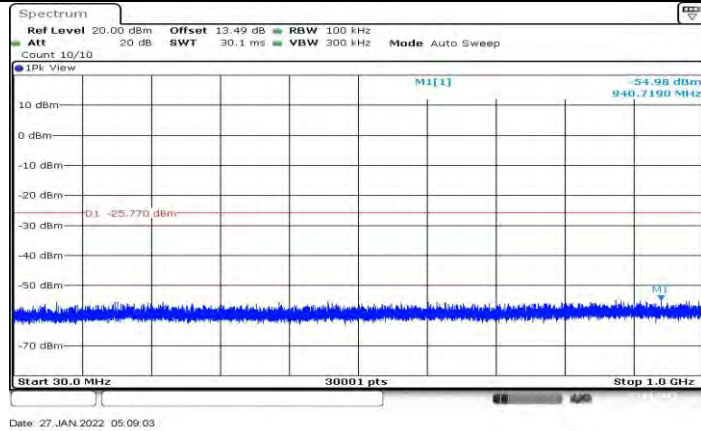

11N20SISO Ant1 2462 30~1000

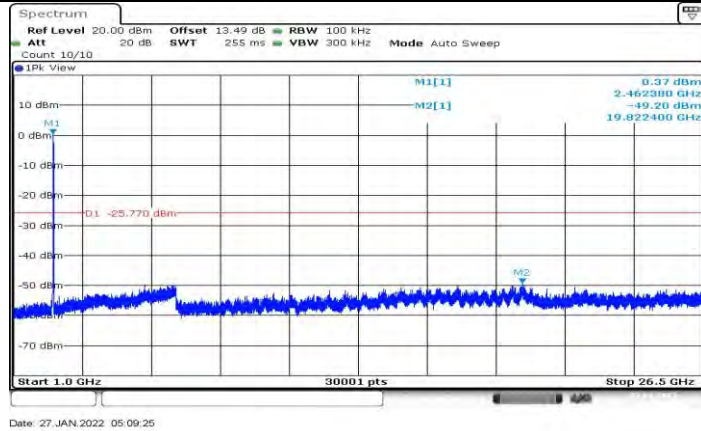

11N20SISO Ant1 2462 1000~26500



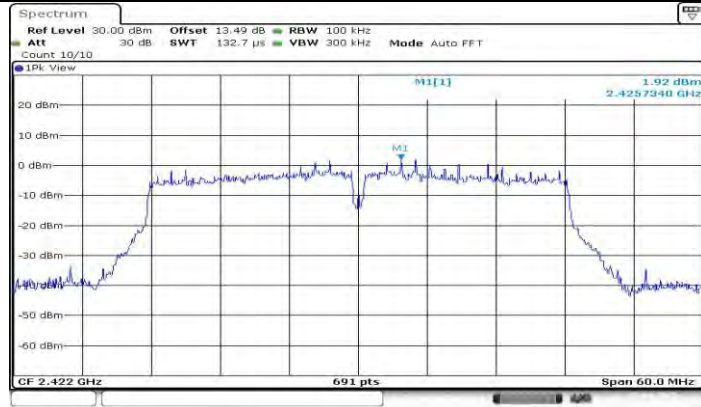

11N40SISO Ant1 2422 0~Reference

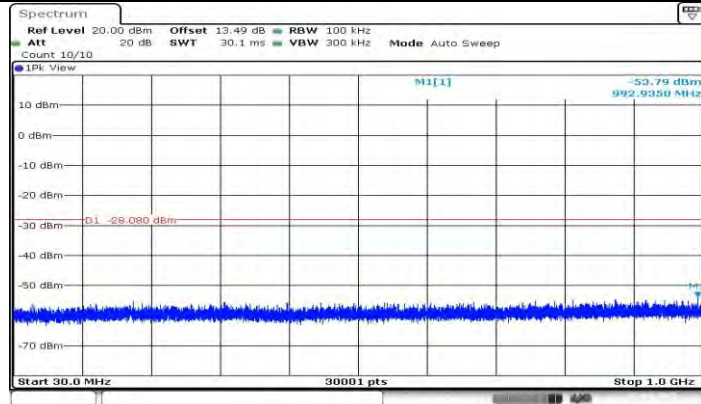

11N40SISO Ant1 2422 30~1000

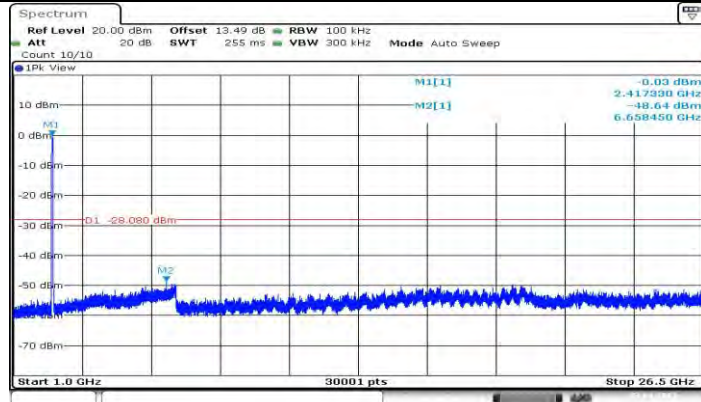

11N40SISO Ant1 2422 1000~26500

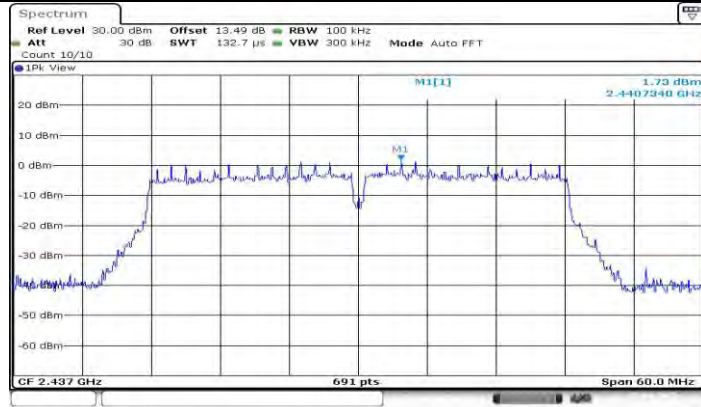

11N40SISO Ant1 2437 0~Reference

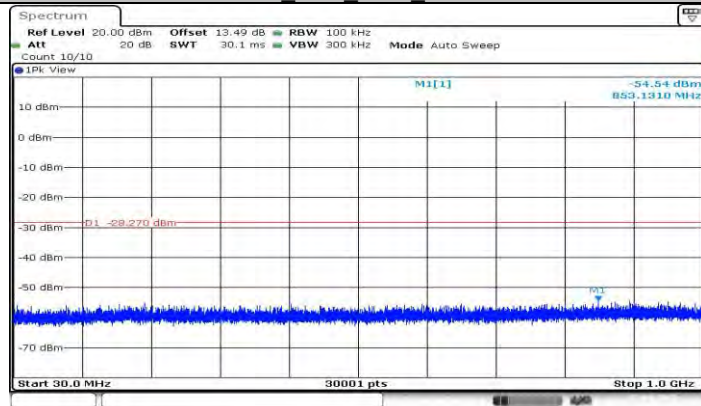

11N40SISO Ant1 2437 30~1000

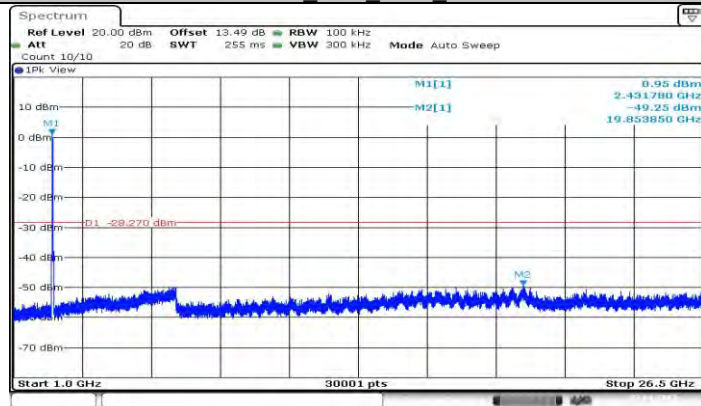

11N40SISO Ant1 2437 1000~26500

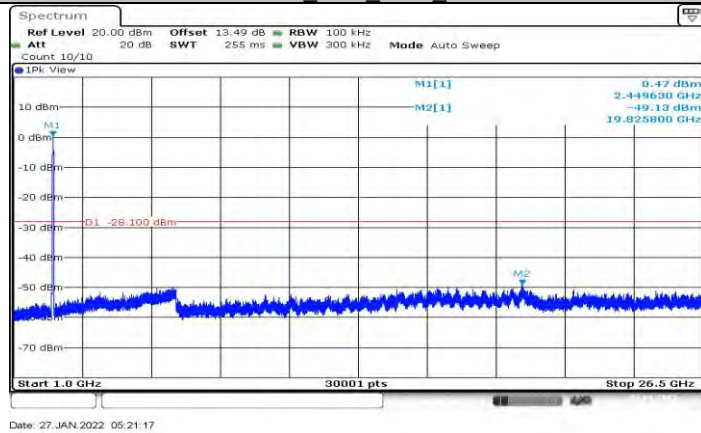
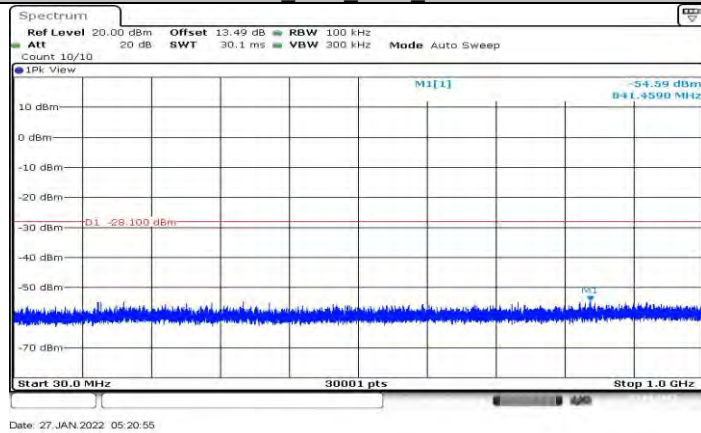



**11.7. Appendix G: Duty Cycle**  
**11.7.1. Test Result**

Test Mode	On Time (msec)	Period (msec)	Duty Cycle x (Linear)	Duty Cycle (%)	Duty Cycle Correction Factor (dB)	1/T Minimum VBW (kHz)	Final setting For VBW (kHz)
11B	12.39	12.53	0.9888	98.88	0.05	0.08	0.01
11G	2.05	2.09	0.9809	98.09	0.08	0.49	1
11N20SISO	1.88	1.93	0.9741	97.41	0.11	0.53	1
11N40SISO	0.94	0.99	0.9495	94.95	0.23	1.06	2

Note:

Duty Cycle Correction Factor=10log (1/x).

Where: x is Duty Cycle (Linear)

Where: T is On Time

If that calculated VBW is not available on the analyzer then the next higher value should be used.



### 11.7.2. Test Graphs

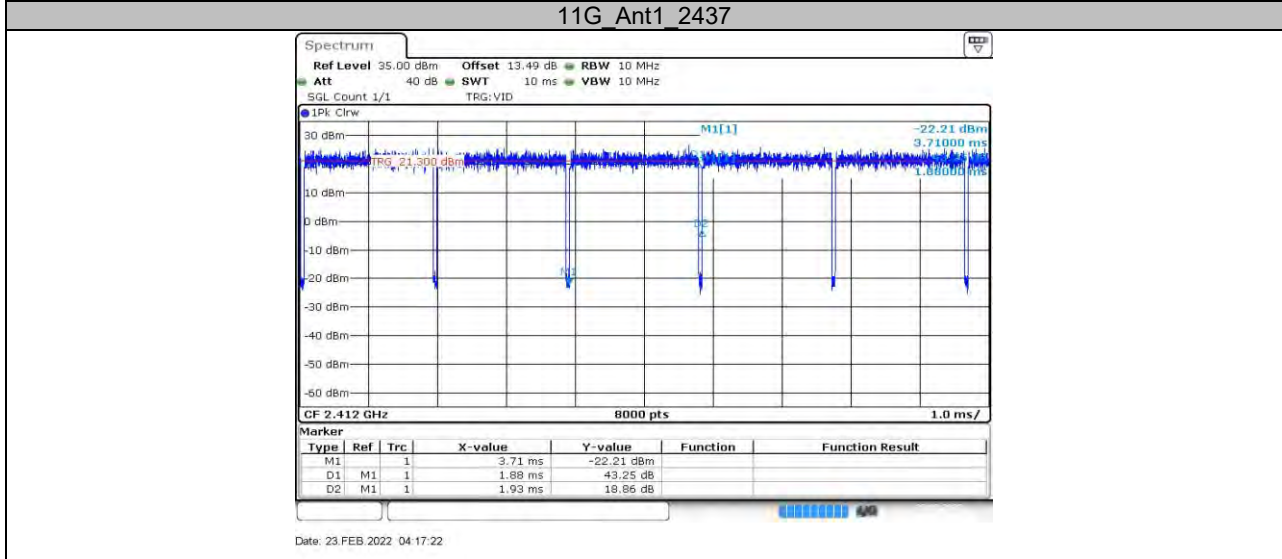
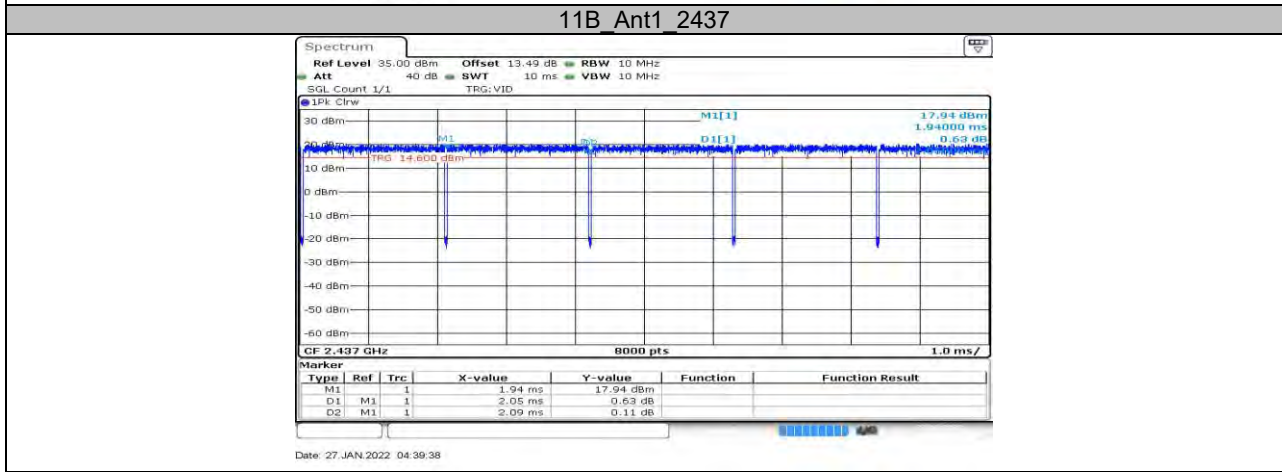
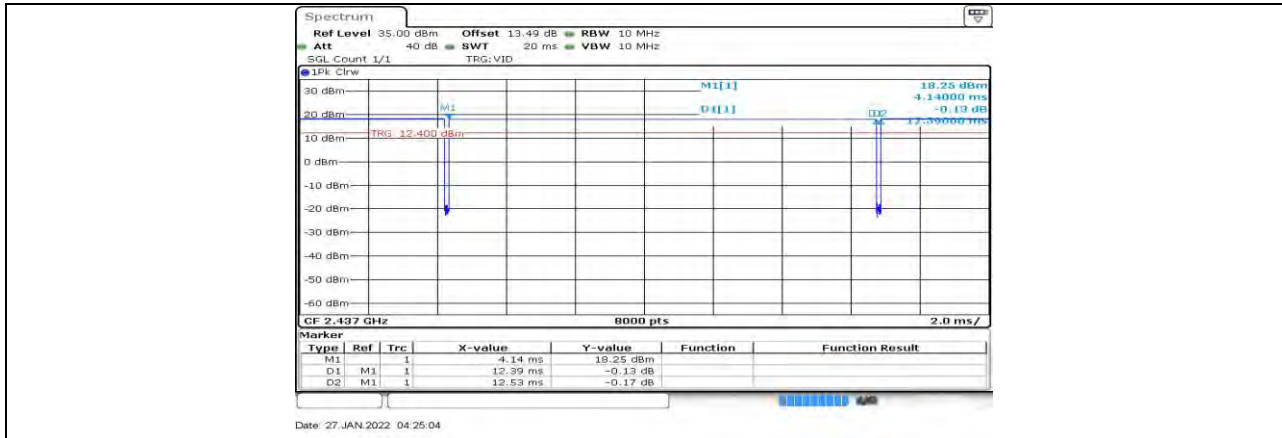

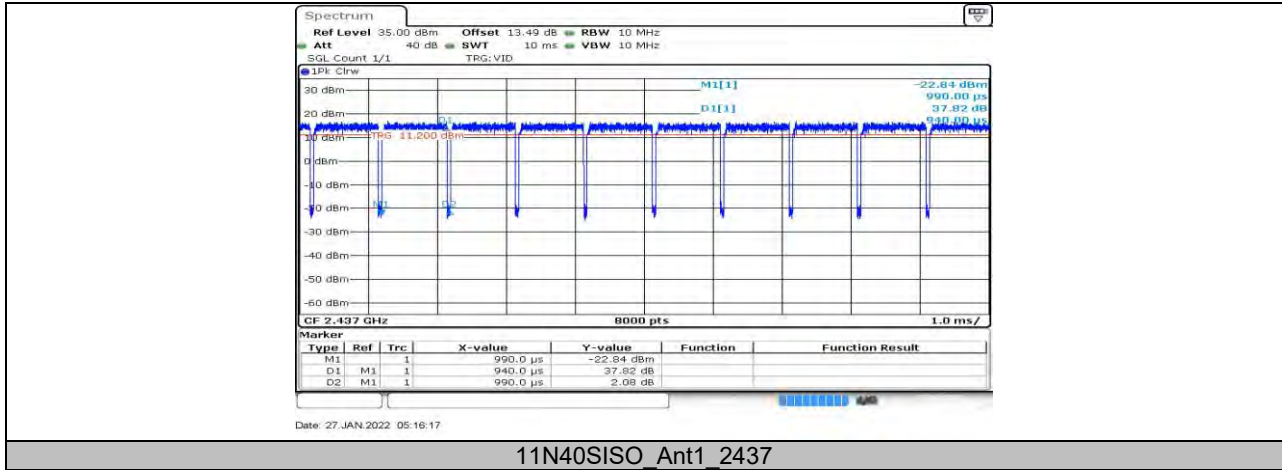

END OF REPORT