



# FCC RF Test Report

**APPLICANT** : PAX Technology Limited  
**EQUIPMENT** : Wireless POS Terminal  
**BRAND NAME** : PAX  
**MODEL NAME** : PAX D220  
**MARKETING NAME** : PAX D220  
**FCC ID** : V5P-D2204GMA  
**STANDARD** : 47 CFR Part 2, 24(E), 27(L), 27(H)  
**CLASSIFICATION** : PCS Licensed Transmitter (PCB)

The product was received on Aug. 22, 2018 and completely tested on Nov. 14, 2018. We, Sporton International (Shenzhen) Inc., would like to declare that the tested sample has been evaluated in accordance with the procedures given in ANSI C63.26-2015 and shown compliance with the applicable technical standards.

The test results in this report apply exclusively to the tested model / sample. Without written approval of Sporton International (Shenzhen) Inc., the test report shall not be reproduced except in full.



Approved by: Eric Shih / Manager

**Sporton International (Shenzhen) Inc.**

**1/F, 2/F, Bldg 5, Shiling Industrial Zone, Xinwei Village, Xili, Nanshan, Shenzhen City, Guangdong Province 518055, China**



TABLE OF CONTENTS

REVISION HISTORY ..... 3
SUMMARY OF TEST RESULT ..... 4
1 GENERAL DESCRIPTION ..... 5
1.1 Applicant ..... 5
1.2 Manufacturer ..... 5
1.3 Product Feature of Equipment Under Test ..... 5
1.4 Product Specification of Equipment Under Test ..... 6
1.5 Modification of EUT ..... 6
1.6 Maximum ERP/EIRP Power, Frequency Tolerance, and Emission Designator ..... 7
1.7 Testing Location ..... 8
1.8 Applicable Standards ..... 8
2 TEST CONFIGURATION OF EQUIPMENT UNDER TEST ..... 9
2.1 Test Mode ..... 9
2.2 Connection Diagram of Test System ..... 10
2.3 Support Unit used in test configuration and system ..... 10
2.4 Measurement Results Explanation Example ..... 10
2.5 Frequency List of Low/Middle/High Channels ..... 11
3 CONDUCTED TEST ITEMS ..... 13
3.1 Measuring Instruments ..... 13
3.2 Test Setup ..... 13
3.3 Test Result of Conducted Test ..... 13
3.4 Conducted Output Power and ERP/EIRP ..... 14
3.5 Peak-to-Average Ratio ..... 15
3.6 Occupied Bandwidth ..... 16
3.7 Conducted Band Edge ..... 17
3.8 Conducted Spurious Emission ..... 19
3.9 Frequency Stability ..... 20
4 RADIATED TEST ITEMS ..... 21
4.1 Measuring Instruments ..... 21
4.2 Test Setup ..... 21
4.3 Test Result of Radiated Test ..... 21
4.4 Radiated Spurious Emission ..... 22
5 LIST OF MEASURING EQUIPMENT ..... 23
6 UNCERTAINTY OF EVALUATION ..... 24
APPENDIX A. TEST RESULTS OF CONDUCTED TEST
APPENDIX B. TEST RESULTS OF RADIATED TEST
APPENDIX C. TEST SETUP PHOTOGRAPHS





### SUMMARY OF TEST RESULT

Report Section	FCC Rule	Description	Limit	Result	Remark
3.4	§2.1046	Conducted Output Power	Reporting Only	PASS	-
	§27.50(b)(10) §27.50(c)(10)	Effective Radiated Power (Band 12)	ERP < 3 Watt		
	§24.232(c) §27.50(h)(2)	Equivalent Isotropic Radiated Power (Band 2)	EIRP < 2Watt		
	§27.50(d)(4)	Equivalent Isotropic Radiated Power (Band 4)	EIRP < 1Watt		
3.5	§24.232(d)	Peak-to-Average Ratio	<13 dB	PASS	-
3.6	§2.1049	Occupied Bandwidth	Reporting Only	PASS	-
3.7	§2.1051 §24.238(a) §27.53(g) §27.53(h)	Conducted Band Edge Measurement (Band 2) (Band 4) (Band 12)	< 43+10log <sub>10</sub> (P[Watts])	PASS	-
3.8	§2.1051 §24.238(a) §27.53(g) §27.53(h)	Conducted Spurious Emission (Band 2) (Band 4) (Band 12)	< 43+10log <sub>10</sub> (P[Watts])	PASS	-
3.9	§2.1055 §24.235 §27.54	Frequency Stability Temperature & Voltage	Within Authorized Band	PASS	-
4.4	§2.1053 §24.238(a) §27.53(g) §27.53(h)	Radiated Spurious Emission (Band 2) (Band 4) (Band 12)	< 43+10log <sub>10</sub> (P[Watts])	PASS	Under limit 26.07 dB at 1406.00 MHz



# 1 General Description

## 1.1 Applicant

**PAX Technology Limited**

Room 2416, 24/F., Sun Hung Kai Centre, 30 Harbour Road, Wanchai, Hong Kong

## 1.2 Manufacturer

**PAX Computer Technology (Shenzhen) Co., Ltd.**

4/F, No.3 Building, Software Park, Second Central Science-Tech Road, High-Tech industrial Park, Shenzhen, Guangdong, P.R.C.

## 1.3 Product Feature of Equipment Under Test

Product Feature	
Equipment	Wireless POS Terminal
Brand Name	PAX
Model Name	PAX D220
FCC ID	V5P-D2204GMA
EUT supports Radios application	LTE/NFC WLAN 2.4GHz 802.11b/g/n HT20 Bluetooth BR/EDR/LE
EUT Stage	Identical Prototype



### 1.4 Product Specification of Equipment Under Test

Standards-related Product Specification	
<b>Tx Frequency</b>	LTE Band 2 : 1850.7 MHz ~ 1909.3 MHz LTE Band 4 : 1710.7 MHz ~ 1754.3 MHz LTE Band 12 : 699.7 MHz ~ 715.3 MHz
<b>Rx Frequency</b>	LTE Band 2 : 1930.7 MHz ~ 1989.3 MHz LTE Band 4 : 2110.7 MHz ~ 2154.3 MHz LTE Band 12 : 729.7 MHz ~ 745.3 MHz
<b>Bandwidth</b>	LTE Band 2 : 1.4MHz / 3MHz / 5MHz / 10MHz / 15MHz / 20MHz LTE Band 4 : 1.4MHz / 3MHz / 5MHz / 10MHz / 15MHz / 20MHz LTE Band 12 : 1.4MHz / 3MHz / 5MHz / 10MHz
<b>Maximum Output Power to Antenna</b>	LTE Band 2 : 23.88 dBm LTE Band 4 : 23.85 dBm LTE Band 12 : 24.07 dBm
<b>Antenna Gain</b>	LTE Band 2 : 1.00 dBi LTE Band 4 : 1.00 dBi LTE Band 12 : 0.80 dBi
<b>Type of Modulation</b>	QPSK / 16QAM

### 1.5 Modification of EUT

No modifications are made to the EUT during all test items.



### 1.6 Maximum ERP/EIRP Power, Frequency Tolerance, and Emission Designator

LTE Band 2		QPSK			16QAM		
BW (MHz)	Frequency Range (MHz)	Emission Designator (99%OBW)	Frequency Tolerance (ppm)	Maximum EIRP(W)	Emission Designator (99%OBW)	Frequency Tolerance (ppm)	Maximum EIRP(W)
1.4	1850.7 ~ 1909.3	1M14G7D	-	0.3048	1M12W7D	-	0.2958
3	1851.5 ~ 1908.5	1M14G7D	-	0.3062	1M12W7D	-	0.3006
5	1852.5 ~ 1907.5	1M14G7D	-	0.3062	1M12W7D	-	0.2979
10	1855.0 ~ 1905.0	1M14G7D	0.0107	0.3062	1M12W7D	-	0.3006
15	1857.5 ~ 1902.5	1M14G7D	-	0.3027	1M12W7D	-	0.2992
20	1860.0 ~ 1900.0	1M14G7D	-	0.3076	1M12W7D	-	0.3013
LTE Band 4		QPSK			16QAM		
BW (MHz)	Frequency Range (MHz)	Emission Designator (99%OBW)	Frequency Tolerance (ppm)	Maximum EIRP(W)	Emission Designator (99%OBW)	Frequency Tolerance (ppm)	Maximum EIRP(W)
1.4	1710.7 ~ 1754.3	1M12G7D	-	0.3006	1M12W7D	-	0.2931
3	1711.5 ~ 1753.5	1M12G7D	-	0.3027	1M12W7D	-	0.2944
5	1712.5 ~ 1752.5	1M12G7D	-	0.3048	1M12W7D	-	0.2944
10	1715.0 ~ 1750.0	1M12G7D	0.0128	0.3013	1M12W7D	-	0.2911
15	1717.5 ~ 1747.5	1M12G7D	-	0.3034	1M12W7D	-	0.2931
20	1720.0 ~ 1745.0	1M12G7D	-	0.3055	1M12W7D	-	0.2951
LTE Band 12		QPSK			16QAM		
BW (MHz)	Frequency Range (MHz)	Emission Designator (99%OBW)	Frequency Tolerance (ppm)	Maximum ERP(W)	Emission Designator (99%OBW)	Frequency Tolerance (ppm)	Maximum ERP(W)
1.4	699.7 ~ 715.3	1M12G7D	-	0.1849	1M12W7D	-	0.1820
3	700.5 ~ 714.5	1M12G7D	-	0.1849	1M12W7D	-	0.1828
5	701.5 ~ 713.5	1M12G7D	-	0.1841	1M12W7D	-	0.1854
10	704.0 ~ 711.0	1M12G7D	0.0276	0.1871	1M12W7D	-	0.1862

**Note:**

For LTE Category M1 that the Maximum UE channel bandwidth is restricted to 1.08MHz (Max 6 RB Size), only 10MHz bandwidth is tested for 99%OBW, and the test results could represent all the other bandwidth.



### 1.7 Testing Location

Sporton International (Shenzhen) Inc. is accredited to ISO 17025 by National Voluntary Laboratory Accreditation Program (NVLAP code: 600156-0).

<b>Test Site</b>	Sporton International (Shenzhen) Inc.		
<b>Test Site Location</b>	1/F, 2/F, Bldg 5, Shiling Industrial Zone, Xinwei Village, Xili, Nanshan, Shenzhen City, Guangdong Province 518055, China TEL: +86-755-8637-9589 FAX: +86-755-8637-9595		
<b>Test Site No.</b>	<b>Sporton Site No.</b>	<b>FCC designation No.</b>	<b>FCC Test Firm Registration No.</b>
	TH01-SZ	CN5018	337463

<b>Test Site</b>	Sporton International (Shenzhen) Inc.		
<b>Test Site Location</b>	No. 3 Bldg the third floor of south, Shahe River west, Fengzeyuan Warehouse, Nanshan District, Shenzhen City, Guangdong Province 518055, China TEL: +86-755- 3320-2398		
<b>Test Site No.</b>	<b>Sporton Site No.</b>	<b>FCC designation No.</b>	<b>FCC Test Firm Registration No.</b>
	03CH02-SZ	CN5019	577730

### 1.8 Applicable Standards

According to the specifications of the manufacturer, the EUT must comply with the requirements of the following standards:

- 47 CFR Part 2, 24(E), 27(L), 27(H)
- ANSI C63.26-2015
- FCC KDB 971168 D01 Power Meas License Digital Systems v03r01
- FCC KDB 412172 D01 Determining ERP and EIRP v01r01

**Remark:**

1. All test items were verified and recorded according to the standards and without any deviation during the test.
2. This EUT has also been tested and complied with the requirements of FCC Part 15, Subpart B, recorded in a separate test report.





## 2 Test Configuration of Equipment Under Test

### 2.1 Test Mode

Antenna port conducted and radiated test items listed below are performed according to KDB 971168 D01 Power Meas License Digital Systems v03r01 with maximum output power. Radiated measurements are performed by rotating the EUT in three different orthogonal test planes to find the maximum emission.

Test Items	Band	Bandwidth (MHz)						Modulation			RB #			Test Channel		
		1.4	3	5	10	15	20	QPSK	16QAM	64QAM	1	Half	Full	L	M	H
Max. Output Power	2	v	v	v	v	v	v	v	v	-	v	v	v	v	v	v
	4	v	v	v	v	v	v	v	v	-	v	v	v	v	v	v
	12	v	v	v	v	-	-	v	v	-	v	v	v	v	v	v
Peak-to-Average Ratio	2						v	v	v	-	v		v	v	v	v
	4						v	v	v	-	v		v	v	v	v
	12				v	-	-	v	v	-	v		v	v	v	v
26dB and 99% Bandwidth	2				v			v	v	-			v	v	v	v
	4				v			v	v	-			v	v	v	v
	12				v	-	-	v	v	-			v	v	v	v
Conducted Band Edge	2				v			v	v	-	v		v	v		v
	4				v			v	v	-	v		v	v		v
	12				v	-	-	v	v	-	v		v	v		v
Conducted Spurious Emission	2				v			v	v	-	v			v	v	v
	4				v			v	v	-	v			v	v	v
	12				v	-	-	v	v	-	v			v	v	v
Frequency Stability	2				v			v		-			v		v	
	4				v			v		-			v		v	
	12				v	-	-	v		-			v		v	
E.R.P / E.I.R.P	2	v	v	v	v	v	v	v	v	-	v			v	v	v
	4	v	v	v	v	v	v	v	v	-	v			v	v	v
	12	v	v	v	v	-	-	v	v	-	v			v	v	v
Radiated Spurious Emission	2	Worst case												v	v	v
	4	Worst case												v	v	v
	12	Worst case												v	v	v
Note	<ol style="list-style-type: none"> <li>The mark "v" means that this configuration is chosen for testing</li> <li>The mark "-" means that this bandwidth is not supported.</li> <li>The device is investigated from 30MHz to 10 times of fundamental signal for radiated spurious emission test under different RB size/offset and modulations in exploratory test. Subsequently, only the worst case emissions are reported.</li> </ol>															

## 2.2 Connection Diagram of Test System

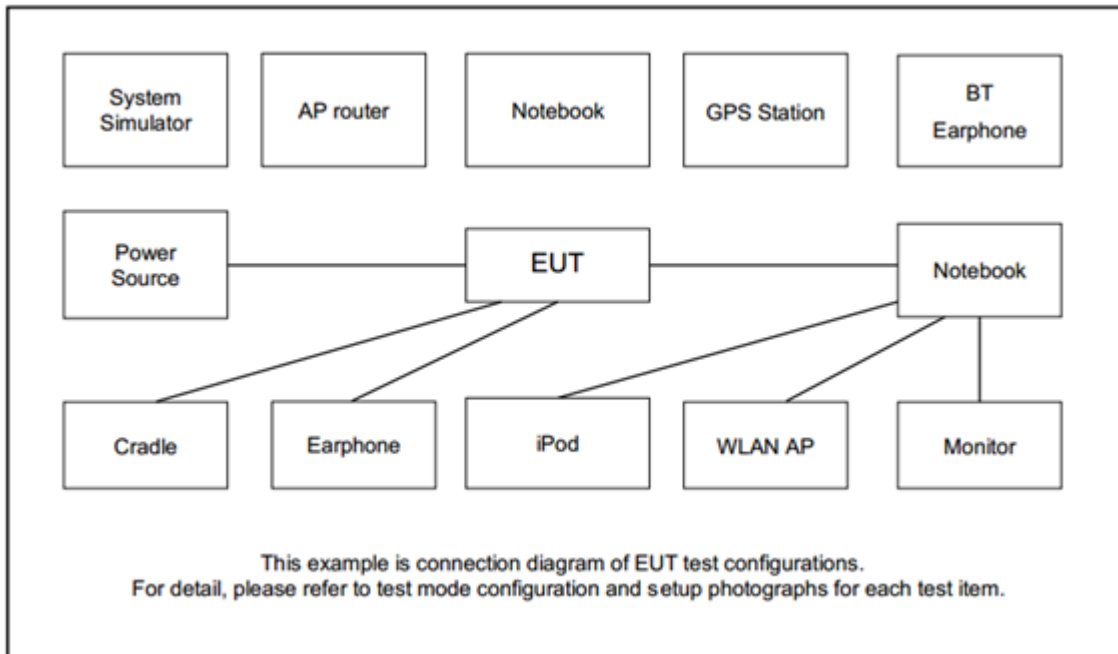

## 2.3 Support Unit used in test configuration and system

Item	Equipment	Trade Name	Model No.	FCC ID	Data Cable	Power Cord
1.	LTE Base Station	Anritsu	MT8820C	N/A	N/A	Unshielded, 1.8 m

## 2.4 Measurement Results Explanation Example

### For all conducted test items:

The offset level is set in the spectrum analyzer to compensate the RF cable loss and attenuator factor between EUT conducted output port and spectrum analyzer. With the offset compensation, the spectrum analyzer reading level is exactly the EUT RF output level.

The spectrum analyzer offset is derived from RF cable loss and attenuator factor.

*Offset = RF cable loss + attenuator factor.*

Following shows an offset computation example with cable loss 1.7 dB and 10dB attenuator.

Example :

*Offset(dB) = RF cable loss(dB) + attenuator factor(dB).*

$$= 1.7 + 10 = 11.7 \text{ (dB)}$$



### 2.5 Frequency List of Low/Middle/High Channels

LTE Band 2 Channel and Frequency List				
BW [MHz]	Channel/Frequency(MHz)	Lowest	Middle	Highest
20	Channel	18700	18900	19100
	Frequency	1860	1880	1900
15	Channel	18675	18900	19125
	Frequency	1857.5	1880	1902.5
10	Channel	18650	18900	19150
	Frequency	1855	1880	1905
5	Channel	18625	18900	19175
	Frequency	1852.5	1880	1907.5
3	Channel	18615	18900	19185
	Frequency	1851.5	1880	1908.5
1.4	Channel	18607	18900	19193
	Frequency	1850.7	1880	1909.3

LTE Band 4 Channel and Frequency List				
BW [MHz]	Channel/Frequency(MHz)	Lowest	Middle	Highest
20	Channel	20050	20175	20300
	Frequency	1720	1732.5	1745
15	Channel	20025	20175	20325
	Frequency	1717.5	1732.5	1747.5
10	Channel	20000	20175	20350
	Frequency	1715	1732.5	1750
5	Channel	19975	20175	20375
	Frequency	1712.5	1732.5	1752.5
3	Channel	19965	20175	20385
	Frequency	1711.5	1732.5	1753.5
1.4	Channel	19957	20175	20393
	Frequency	1710.7	1732.5	1754.3



LTE Band 12 Channel and Frequency List				
BW [MHz]	Channel/Frequency(MHz)	Lowest	Middle	Highest
10	Channel	23060	23095	23130
	Frequency	704	707.5	711
5	Channel	23035	23095	23155
	Frequency	701.5	707.5	713.5
3	Channel	23025	23095	23165
	Frequency	700.5	707.5	714.5
1.4	Channel	23017	23095	23173
	Frequency	699.7	707.5	715.3

### 3 Conducted Test Items

#### 3.1 Measuring Instruments

See list of measuring instruments of this test report.

#### 3.2 Test Setup

##### 3.2.1 Conducted Output Power

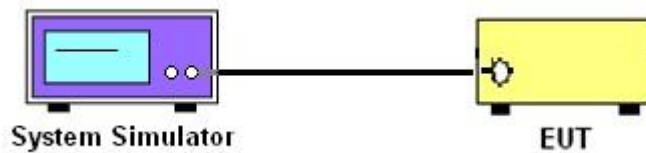

##### 3.2.2 Peak-to-Average Ratio, Occupied Bandwidth ,Conducted Band-Edge and Conducted Spurious Emission

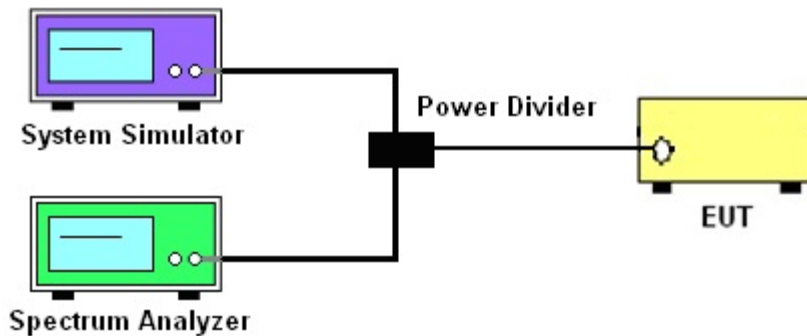

##### 3.2.3 Frequency Stability

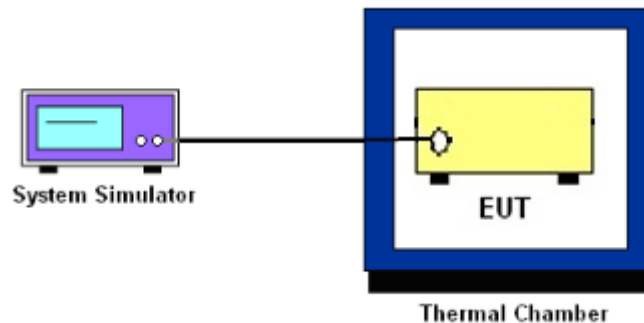

### 3.3 Test Result of Conducted Test

Please refer to Appendix A.



### 3.4 Conducted Output Power and ERP/EIRP

#### 3.4.1 Description of the Conducted Output Power Measurement and ERP/EIRP Measurement

A system simulator was used to establish communication with the EUT. Its parameters were set to force the EUT transmitting at maximum output power. The measured power in the radio frequency on the transmitter output terminals shall be reported.

The ERP of mobile transmitters must not exceed 3 Watts for LTE Band 12

The EIRP of mobile transmitters must not exceed 2 Watts for LTE Band 2

The EIRP of mobile transmitters must not exceed 1 Watts for LTE Band 4

According to KDB 412172 D01 Power Approach,

$EIRP = P_T + G_T - L_C$ ,  $ERP = EIRP - 2.15$ , where

$P_T$  = transmitter output power in dBm

$G_T$  = gain of the transmitting antenna in dBi

$L_C$  = signal attenuation in the connecting cable between the transmitter and antenna in dB

#### 3.4.2 Test Procedures

1. The testing follows ANSI C63.26 Section 5.2
2. The transmitter output port was connected to the system simulator.
3. Set EUT at maximum power through the system simulator.
4. Select lowest, middle, and highest channels for each band and different modulation.
5. Measure and record the power level from the system simulator.



## **3.5 Peak-to-Average Ratio**

### **3.5.1 Description of the PAR Measurement**

Power Complementary Cumulative Distribution Function (CCDF) curves provide a means for characterizing the power peaks of a digitally modulated signal on a statistical basis. A CCDF curve depicts the probability of the peak signal amplitude exceeding the average power level. Most contemporary measurement instrumentation include the capability to produce CCDF curves for an input signal provided that the instrument's resolution bandwidth can be set wide enough to accommodate the entire input signal bandwidth. In measuring transmissions in this band using an average power technique, the peak-to-average ratio (PAR) of the transmission may not exceed 13 dB.

### **3.5.2 Test Procedures**

1. The testing follows ANSI C63.26 Section 5.2.3.4 (CCDF).
2. The EUT was connected to spectrum and system simulator via a power divider.
3. Set the CCDF (Complementary Cumulative Distribution Function) option in spectrum analyzer.
4. The highest RF powers were measured and recorded the maximum PAPR level associated with a probability of 0.1 %.
5. Record the deviation as Peak to Average Ratio.



### 3.6 Occupied Bandwidth

#### 3.6.1 Description of Occupied Bandwidth Measurement

The occupied bandwidth is the width of a frequency band such that, below the lower and above the upper frequency limits, the mean powers emitted are each equal to a specified percentage 0.5% of the total mean transmitted power.

The 26 dB emission bandwidth is defined as the frequency range between two points, one above and one below the carrier frequency, at which the spectral density of the emission is attenuated 26 dB below the maximum in-band spectral density of the modulated signal. Spectral density (power per unit bandwidth) is to be measured with a detector of resolution bandwidth equal to approximately 1.0% of the emission bandwidth.

#### 3.6.2 Test Procedures

1. The testing follows ANSI C63.26 Section 5.4
2. The EUT was connected to spectrum analyzer and system simulator via a power divider.
3. The spectrum analyzer center frequency is set to the nominal EUT channel center frequency. The span range for the spectrum analyzer shall be between two and five times the anticipated OBW.
4. The nominal resolution bandwidth (RBW) shall be in the range of 1 to 5 % of the anticipated OBW, and the VBW shall be at least 3 times the RBW.
5. Set the detection mode to peak, and the trace mode to max hold.
6. Determine the reference value: Set the EUT to transmit a modulated signal. Allow the trace to stabilize. Set the spectrum analyzer marker to the highest level of the displayed trace.  
(this is the reference value)
7. Determine the “-26 dB down amplitude” as equal to (Reference Value – X).
8. Place two markers, one at the lowest and the other at the highest frequency of the envelope of the spectral display such that each marker is at or slightly below the “-X dB down amplitude” determined in step 6. If a marker is below this “-X dB down amplitude” value it shall be placed as close as possible to this value. The OBW is the positive frequency difference between the two markers.
9. Use the 99 % power bandwidth function of the spectrum analyzer and report the measured bandwidth.





## 3.7 Conducted Band Edge

### 3.7.1 Description of Conducted Band Edge Measurement

#### 24.238 (a)

For operations in the 1850-1910 and 1930-1990 MHz band, the FCC limit is  $43 + 10\log_{10}(P[\text{Watts}])$  dB below the transmitter power  $P(\text{Watts})$  in a 1MHz bandwidth. However, in the 1 MHz bands immediately outside and adjacent to the frequency block a resolution bandwidth of at least one percent of the emission bandwidth of the fundamental emission of the transmitter may be employed.

#### 27.53 (g)

For operations in the 600MHz band and 698 -746 MHz band, the FCC limit is  $43 + 10\log_{10}(P[\text{Watts}])$  dB below the transmitter power  $P(\text{Watts})$  in a 100 kHz bandwidth. However, in the 100 kilohertz bands immediately outside and adjacent to a licensee's frequency block, a resolution bandwidth of at least 30 kHz may be employed.

#### 27.53 (h)

For operations in the 1710 – 1755 MHz band, the FCC limit is  $43 + 10\log_{10}(P[\text{Watts}])$  dB below the transmitter power  $P(\text{Watts})$  in a 1 MHz bandwidth. However, in the 1MHz bands immediately outside and adjacent to the licensee's frequency block, a resolution bandwidth of at least one percent of the emission bandwidth of the fundamental emission of the transmitter may be employed.



### 3.7.2 Test Procedures

1. The testing follows ANSI C63.26 section 5.7
2. The EUT was connected to spectrum analyzer and system simulator via a power divider.
3. The band edges of low and high channels for the highest RF powers were measured.
4. Set RBW  $\geq$  1% EBW in the 1MHz band immediately outside and adjacent to the band edge.
5. Beyond the 1 MHz band from the band edge, RBW=1MHz was used or a narrower RBW was used and the measured power was integrated over the full required measurement bandwidth of 1 MHz.
6. Set spectrum analyzer with RMS detector.
7. The RF fundamental frequency should be excluded against the limit line in the operating frequency band.
8. Checked that all the results comply with the emission limit line.

Example:

The limit line is derived from  $43 + 10\log(P)$ dB below the transmitter power P(Watts)  
= P(W)- [43 + 10log(P)] (dB)  
= [30 + 10log(P)] (dBm) - [43 + 10log(P)] (dB) = -13dBm.



### 3.8 Conducted Spurious Emission

#### 3.8.1 Description of Conducted Spurious Emission Measurement

The power of any emission outside of the authorized operating frequency ranges must be lower than the transmitter power (P) by a factor of at least  $43 + 10 \log (P)$  dB.

It is measured by means of a calibrated spectrum analyzer and scanned from 30 MHz up to a frequency including its 10<sup>th</sup> harmonic.

#### 3.8.2 Test Procedures

1. The testing follows ANSI C63.26 section 5.7
2. The EUT was connected to spectrum analyzer and system simulator via a power divider.
3. The RF output of EUT was connected to the spectrum analyzer by RF cable and attenuator. The path loss was compensated to the results for each measurement.
4. The middle channel for the highest RF power within the transmitting frequency was measured.
5. The conducted spurious emission for the whole frequency range was taken.
6. Make the measurement with the spectrum analyzer's RBW = 1MHz, VBW = 3MHz.
7. Set spectrum analyzer with RMS detector.
8. Taking the record of maximum spurious emission.
9. The RF fundamental frequency should be excluded against the limit line in the operating frequency band.
10. The limit line is derived from  $43 + 10\log(P)$ dB below the transmitter power P(Watts)  
=  $P(W) - [43 + 10\log(P)]$  (dB)  
=  $[30 + 10\log(P)]$  (dBm) -  $[43 + 10\log(P)]$  (dB)  
= -13dBm.



## 3.9 Frequency Stability

### 3.9.1 Description of Frequency Stability Measurement

The frequency stability shall be measured by variation of ambient temperature and variation of primary supply voltage to ensure that the fundamental emission stays within the authorized frequency block. The frequency stability of the transmitter shall be maintained within  $\pm 0.00025\%$  ( $\pm 2.5\text{ppm}$ ) of the center frequency.

### 3.9.2 Test Procedures for Temperature Variation

1. The testing follows ANSI C63.26 section 5.6.4
2. The EUT was set up in the thermal chamber and connected with the system simulator.
3. With power OFF, the temperature was decreased to  $-30^{\circ}\text{C}$  and the EUT was stabilized before testing. Power was applied and the maximum change in frequency was recorded within one minute.
4. With power OFF, the temperature was raised in  $10^{\circ}\text{C}$  step up to  $50^{\circ}\text{C}$ . The EUT was stabilized at each step for at least half an hour. Power was applied and the maximum frequency change was recorded within one minute.

### 3.9.3 Test Procedures for Voltage Variation

1. The testing follows ANSI C63.26 section 5.6.5
2. The EUT was placed in a temperature chamber at  $20\pm 5^{\circ}\text{C}$  and connected with the system simulator.
3. The power supply voltage to the EUT was varied from 85% to 115% of the nominal value for other than hand carried battery equipment.
4. For hand carried, battery powered equipment, reduce the primary ac or dc supply voltage to the battery operating end point, which shall be specified by the manufacturer.
5. The variation in frequency was measured for the worst case.

## 4 Radiated Test Items

### 4.1 Measuring Instruments

See list of measuring instruments of this test report.

### 4.2 Test Setup

#### 4.2.1 For radiated test from 30MHz to 1GHz

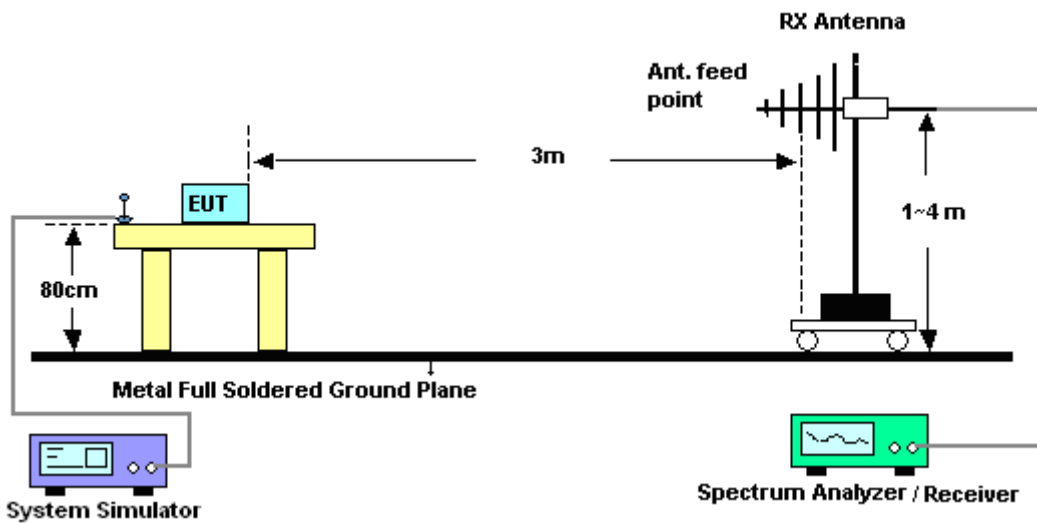

#### 4.2.2 For radiated test above 1GHz

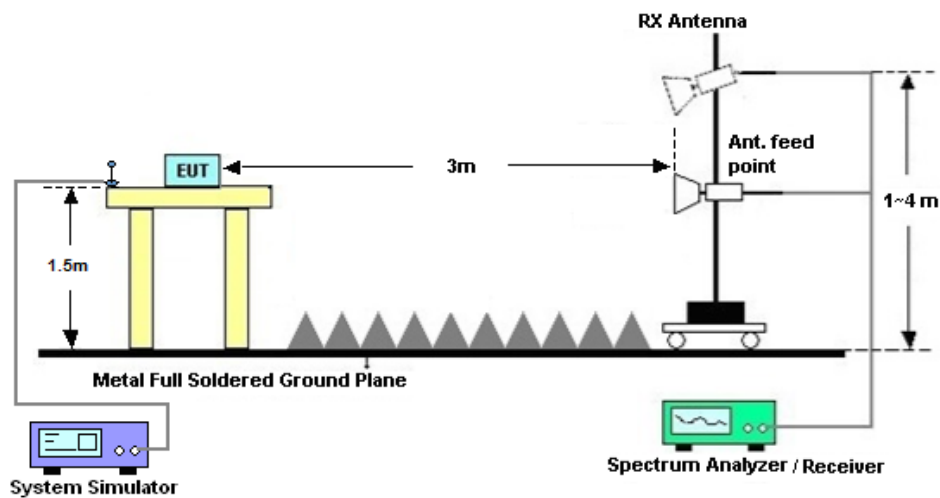

### 4.3 Test Result of Radiated Test

Please refer to Appendix B.



## 4.4 Radiated Spurious Emission

### 4.4.1 Description of Radiated Spurious Emission

The radiated spurious emission was measured by substitution method according to ANSI C63.26. The power of any emission outside of the authorized operating frequency ranges must be attenuated below the transmitter power (P) by a factor of at least  $43 + 10 \log (P)$  dB.

The spectrum is scanned from 30 MHz up to a frequency including its 10th harmonic.

### 4.4.2 Test Procedures

1. The testing follows ANSI C63.26 Section 5.5
2. The EUT was placed on a turntable with 0.8 meter height for frequency below 1GHz and 1.5 meter height for frequency above 1GHz respectively above ground.
3. The EUT was set 3 meters from the receiving antenna mounted on the antenna tower.
4. The table was rotated 360 degrees to determine the position of the highest spurious emission.
5. The height of the receiving antenna is varied between 1m to 4m to search the maximum spurious emission for both horizontal and vertical polarizations.
6. During the measurement, the system simulator parameters were set to force the EUT transmitting at maximum output power.
7. Make the measurement with the spectrum analyzer's RBW = 1MHz, VBW = 3MHz, taking the record of maximum spurious emission.
8. A horn antenna was substituted in place of the EUT and was driven by a signal generator.
9. Tune the output power of signal generator to the same emission level with EUT maximum spurious emission.
10.  $EIRP \text{ (dBm)} = S.G. \text{ Power} - Tx \text{ Cable Loss} + Tx \text{ Antenna Gain}$
11.  $ERP \text{ (dBm)} = EIRP - 2.15$
12. The RF fundamental frequency should be excluded against the limit line in the operating frequency band.

The limit line is derived from  $43 + 10\log(P)$ dB below the transmitter power P(Watts)  
=  $P(W) - [43 + 10\log(P)] \text{ (dB)}$   
=  $[30 + 10\log(P)] \text{ (dBm)} - [43 + 10\log(P)] \text{ (dB)}$   
= -13dBm.



## 5 List of Measuring Equipment

Instrument	Manufacturer	Model No.	Serial No.	Characteristics	Calibration Date	Test Date	Due Date	Remark
Spectrum Analyzer	R&S	FSV40	101078	9kHz~40GHz	Apr.19, 2018	Nov. 13, 2018~ Nov. 14, 2018	Apr. 18, 2019	Conducted (TH01-SZ)
Thermal Chamber	Ten Billion Hongzhangroup	LP-150U	H2014081803	-40~+150°C	Dec. 26, 2017	Nov. 13, 2018~ Nov. 14, 2018	Dec. 25, 2018	Conducted (TH01-SZ)
Spectrum Analyzer	R&S	FSV40	101041	10kHz~40GHz;Ma x 30dBm	Oct. 20, 2017	Oct. 08, 2018	Oct. 19, 2018	Radiation (03CH02-SZ)
Bilog Antenna	TeseQ	CBL6112D	35407	30MHz-2GHz	May 10, 2018	Oct. 08, 2018	May 09, 2019	Radiation (03CH02-SZ)
Double Ridge Horn Antenna	SCHWARZBECK	BBHA 9120D	9120D-1285	1GHz~18GHz	Dec. 13, 2017	Oct. 08, 2018	Dec. 12, 2018	Radiation (03CH02-SZ)
SHF-EHF Horn	com-power	AH-840	101071	18Ghz-40GHz	Mar. 30, 2018	Oct. 08, 2018	Mar. 29, 2019	Radiation (03CH02-SZ)
LF Amplifier	Burgeon	BPA-530	102211	0.01~3000Mhz	Oct. 21, 2017	Oct. 08, 2018	Oct. 20, 2018	Radiation (03CH02-SZ)
HF Amplifier	Agilent	8449B	3008A01023	1GHz~26.5GHz	Oct. 21, 2017	Oct. 08, 2018	Oct. 20, 2018	Radiation (03CH02-SZ)
HF Amplifier	MITEQ	TTA1840-35 -HG	1871923	18GHz~40GHz	Jul. 30, 2018	Oct. 08, 2018	Jul. 29, 2019	Radiation (03CH02-SZ)
AC Power Source	Chroma	61601	616010002470	N/A	NCR	Oct. 08, 2018	NCR	Radiation (03CH02-SZ)
Turn Table	Chaintek	T-200	N/A	0~360 degree	NCR	Oct. 08, 2018	NCR	Radiation (03CH02-SZ)
Antenna Mast	Chaintek	MBS-400	N/A	1 m~4 m	NCR	Oct. 08, 2018	NCR	Radiation (03CH02-SZ)



## 6 Uncertainty of Evaluation

### Uncertainty of Radiated Emission Measurement (30 MHz ~ 1000 MHz)

Measuring Uncertainty for a Level of Confidence of 95% ( $U = 2Uc(y)$ )	2.5 dB
---	--------

### Uncertainty of Radiated Emission Measurement (1 GHz ~ 18 GHz)

Measuring Uncertainty for a Level of Confidence of 95% ( $U = 2Uc(y)$ )	3.3 dB
---	--------

### Uncertainty of Radiated Emission Measurement (18 GHz ~ 40 GHz)

Measuring Uncertainty for a Level of Confidence of 95% ( $U = 2Uc(y)$ )	3.7 dB
---	--------





## Appendix A. Test Results of Conducted Test

### Conducted Output Power(Average power)

LTE Band 2 Maximum Average Power [dBm]									
BW [MHz]	Mod	RB Size	RB Offset	Index			Lowest	Middle	Highest
				L	M	H			
20	QPSK	1	0	0	0	15	23.02	23.24	23.80
20		1	5	0	0	15	23.04	23.30	23.88
20		6	0	0	0	15	23.14	23.34	23.87
20	16-QAM	1	0	0	0	15	22.86	23.11	23.79
20		1	5	0	0	15	22.86	23.12	23.69
20		6	0	0	0	15	22.83	23.06	23.37
15	QPSK	1	0	0	0	11	22.96	23.18	23.71
15		1	5	0	0	11	22.99	23.21	23.81
15		6	0	0	0	11	23.04	23.26	23.81
15	16-QAM	1	0	0	0	11	22.83	23.01	23.76
15		1	5	0	0	11	22.80	23.03	23.64
15		6	0	0	0	11	22.82	23.04	23.32
10	QPSK	1	0	0	0	7	22.93	23.20	23.72
10		1	5	0	0	7	23.03	23.25	23.86
10		6	0	0	0	7	23.04	23.29	23.80
10	16-QAM	1	0	0	0	7	22.81	23.02	23.78
10		1	5	0	0	7	22.76	23.07	23.65
10		6	0	0	0	7	22.83	23.03	23.31
5	QPSK	1	0	0	0	3	22.95	23.24	23.78
5		1	5	0	0	3	22.95	23.22	23.86
5		6	0	0	0	3	23.13	23.28	23.85
5	16-QAM	1	0	0	0	3	22.77	23.06	23.74
5		1	5	0	0	3	22.83	23.08	23.63
5		6	0	0	0	3	22.82	22.97	23.32



LTE Band 2 Maximum Average Power [dBm]									
BW [MHz]	Mod	RB Size	RB Offset	Index			Lowest	Middle	Highest
				L	M	H			
3	QPSK	1	0	0	0	1	23.01	23.24	23.73
3		1	5	0	0	1	22.96	23.27	23.86
3		6	0	0	0	1	23.14	23.26	23.85
3		1	0	0	0	1	22.84	23.05	23.78
3	16-QAM	1	5	0	0	1	22.82	23.04	23.67
3		6	0	0	0	1	22.75	23.06	23.31
1.4	QPSK	1	0	0	0	0	23.02	23.21	23.77
1.4		1	5	0	0	0	22.97	23.30	23.79
1.4		6	0	0	0	0	23.08	23.33	23.84
1.4	16-QAM	1	0	0	0	0	22.77	23.08	23.71
1.4		1	5	0	0	0	22.77	23.06	23.62
1.4		6	0	0	0	0	22.82	23.04	23.30



LTE Band 4 Maximum Average Power [dBm]									
BW [MHz]	Mod	RB Size	RB Offset	Index			Lowest	Middle	Highest
				L	M	H			
20	QPSK	1	0	0	0	15	23.78	23.64	23.15
20		1	5	0	0	15	23.85	23.66	23.25
20		6	0	0	0	15	23.82	23.68	23.38
20		1	0	0	0	15	23.60	23.62	23.20
20	16-QAM	1	5	0	0	15	23.70	23.48	23.12
20		6	0	0	0	15	23.58	23.44	23.27
15	QPSK	1	0	0	0	11	23.72	23.60	23.12
15		1	5	0	0	11	23.74	23.63	23.23
15		6	0	0	0	11	23.82	23.67	23.30
15	16-QAM	1	0	0	0	11	23.58	23.56	23.11
15		1	5	0	0	11	23.67	23.48	23.04
15		6	0	0	0	11	23.53	23.39	23.17
10	QPSK	1	0	0	0	7	23.72	23.54	23.07
10		1	5	0	0	7	23.72	23.62	23.23
10		6	0	0	0	7	23.79	23.60	23.35
10	16-QAM	1	0	0	0	7	23.55	23.56	23.15
10		1	5	0	0	7	23.64	23.45	23.12
10		6	0	0	0	7	23.52	23.38	23.18
5	QPSK	1	0	0	0	3	23.73	23.55	23.06
5		1	5	0	0	3	23.78	23.64	23.18
5		6	0	0	0	3	23.84	23.61	23.37
5	16-QAM	1	0	0	0	3	23.52	23.61	23.18
5		1	5	0	0	3	23.69	23.40	23.04
5		6	0	0	0	3	23.51	23.43	23.17



LTE Band 4 Maximum Average Power [dBm]									
BW [MHz]	Mod	RB Size	RB Offset	Index			Lowest	Middle	Highest
				L	M	H			
3	QPSK	1	0	0	0	1	23.69	23.56	23.07
3		1	5	0	0	1	23.81	23.63	23.15
3		6	0	0	0	1	23.78	23.62	23.35
3		1	0	0	0	1	23.52	23.60	23.18
3	16-QAM	1	5	0	0	1	23.69	23.46	23.03
3		6	0	0	0	1	23.53	23.38	23.21
1.4	QPSK	1	0	0	0	0	23.78	23.56	23.09
1.4		1	5	0	0	0	23.72	23.59	23.22
1.4		6	0	0	0	0	23.77	23.68	23.33
1.4	16-QAM	1	0	0	0	0	23.50	23.61	23.20
1.4		1	5	0	0	0	23.67	23.39	23.08
1.4		6	0	0	0	0	23.51	23.42	23.17



LTE Band 12 Maximum Average Power [dBm]									
BW [MHz]	Mod	RB Size	RB Offset	Index			Lowest	Middle	Highest
				L	M	H			
10	QPSK	1	0	0	0	7	24.01	24.07	24.01
10		1	5	0	0	7	24.04	24.03	23.98
10		6	0	0	0	7	23.16	23.18	23.15
10		1	0	0	0	7	24.01	23.95	23.91
10	16-QAM	1	5	0	0	7	23.92	24.05	23.95
10		6	0	0	0	7	23.87	23.89	23.94
5	QPSK	1	0	0	0	3	23.99	23.99	23.97
5		1	5	0	0	3	24.00	23.96	23.94
5		6	0	0	0	3	23.15	23.17	23.11
5	16-QAM	1	0	0	0	3	23.91	23.87	23.90
5		1	5	0	0	3	23.86	24.03	23.94
5		6	0	0	0	3	23.80	23.86	23.88
3	QPSK	1	0	0	0	1	23.96	24.02	24.01
3		1	5	0	0	1	24.01	23.96	23.91
3		6	0	0	0	1	23.14	23.13	23.09
3	16-QAM	1	0	0	0	1	23.94	23.95	23.85
3		1	5	0	0	1	23.89	23.97	23.88
3		6	0	0	0	1	23.85	23.82	23.84
1.4	QPSK	1	0	0	0	0	24.00	23.97	24.01
1.4		1	5	0	0	0	23.94	24.02	23.89
1.4		6	0	0	0	0	23.11	23.17	23.15
1.4	16-QAM	1	0	0	0	0	23.95	23.95	23.91
1.4		1	5	0	0	0	23.86	23.95	23.91
1.4		6	0	0	0	0	23.82	23.85	23.85



**ERP/EIRP**

LTE Band 2 (GT - LC = 1.00 dB) QPSK									
Bandwidth	1.4M			3M			5M		
Channel	18607	18900	19193	18615	18900	19185	18625	18900	19175
	(Low)	(Mid)	(High)	(Low)	(Mid)	(High)	(Low)	(Mid)	(High)
Frequency	1850.7	1880	1909.3	1851.5	1880	1908.5	1852.5	1880	1907.5
(MHz)									
Conducted Power (dBm)	23.08	23.33	23.84	22.96	23.27	23.86	22.95	23.22	23.86
Conducted Power (Watts)	0.2032	0.2153	0.2421	0.1977	0.2123	0.2432	0.1972	0.2099	0.2432
EIRP(dBm)	24.08	24.33	24.84	23.96	24.27	24.86	23.95	24.22	24.86
EIRP(Watts)	0.2559	0.2710	0.3048	0.2489	0.2673	0.3062	0.2483	0.2642	0.3062

LTE Band 2 (GT - LC = 1.00 dB) QPSK									
Bandwidth	10M			15M			20M		
Channel	18650	18900	19150	18675	18900	19125	18650	18900	19100
	(Low)	(Mid)	(High)	(Low)	(Mid)	(High)	(Low)	(Mid)	(High)
Frequency	1855	1880	1905	1857.5	1880	1902.5	1860	1880	1900
(MHz)									
Conducted Power (dBm)	23.03	23.25	23.86	23.04	23.26	23.81	23.04	23.30	23.88
Conducted Power (Watts)	0.2009	0.2113	0.2432	0.2014	0.2118	0.2404	0.2014	0.2138	0.2443
EIRP(dBm)	24.03	24.25	24.86	24.04	24.26	24.81	24.04	24.30	24.88
EIRP(Watts)	0.2529	0.2661	0.3062	0.2535	0.2667	0.3027	0.2535	0.2692	0.3076



LTE Band 2 (GT - LC = 1.00 dB) 16QAM									
Bandwidth	1.4M			3M			5M		
Channel	18607	18900	19193	18615	18900	19185	18625	18900	19175
	(Low)	(Mid)	(High)	(Low)	(Mid)	(High)	(Low)	(Mid)	(High)
Frequency (MHz)	1850.7	1880	1909.3	1851.5	1880	1908.5	1852.5	1880	1907.5
Conducted Power (dBm)	22.77	23.08	23.71	22.84	23.05	23.78	22.77	23.06	23.74
Conducted Power (Watts)	0.1892	0.2032	0.2350	0.1923	0.2018	0.2388	0.1892	0.2023	0.2366
EIRP(dBm)	23.77	24.08	24.71	23.84	24.05	24.78	23.77	24.06	24.74
EIRP(Watts)	0.2382	0.2559	0.2958	0.2421	0.2541	0.3006	0.2382	0.2547	0.2979

LTE Band 2 (GT - LC = 1.00 dB) 16QAM									
Bandwidth	10M			15M			20M		
Channel	18650	18900	19150	18675	18900	19125	18650	18900	19100
	(Low)	(Mid)	(High)	(Low)	(Mid)	(High)	(Low)	(Mid)	(High)
Frequency (MHz)	1855	1880	1905	1857.5	1880	1902.5	1860	1880	1900
Conducted Power (dBm)	22.81	23.02	23.78	22.83	23.01	23.76	22.86	23.11	23.79
Conducted Power (Watts)	0.1910	0.2004	0.2388	0.1919	0.2000	0.2377	0.1932	0.2046	0.2393
EIRP(dBm)	23.81	24.02	24.78	23.83	24.01	24.76	23.86	24.11	24.79
EIRP(Watts)	0.2404	0.2523	0.3006	0.2415	0.2518	0.2992	0.2432	0.2576	0.3013



LTE Band 4 (GT - LC = 1.00 dB) QPSK									
Bandwidth	1.4M			3M			5M		
Channel	19957	20175	20393	19965	20175	20385	19975	20175	20375
	(Low)	(Mid)	(High)	(Low)	(Mid)	(High)	(Low)	(Mid)	(High)
Frequency (MHz)	1710.7	1732.5	1754.3	1711.5	1732.5	1753.5	1712.5	1732.5	1752.5
Conducted Power (dBm)	23.78	23.56	23.09	23.81	23.63	23.15	23.84	23.61	23.37
Conducted Power (Watts)	0.2388	0.2270	0.2037	0.2404	0.2307	0.2065	0.2421	0.2296	0.2173
EIRP(dBm)	24.78	24.56	24.09	24.81	24.63	24.15	24.84	24.61	24.37
EIRP(Watts)	0.3006	0.2858	0.2564	0.3027	0.2904	0.2600	0.3048	0.2891	0.2735

LTE Band 4 (GT - LC = 1.00 dB) QPSK									
Bandwidth	10M			15M			20M		
Channel	20000	20175	20350	20025	20175	20325	20050	20175	20300
	(Low)	(Mid)	(High)	(Low)	(Mid)	(High)	(Low)	(Mid)	(High)
Frequency (MHz)	1715	1732.5	1750	1717.5	1732.5	1747.5	1720	1732.5	1745
Conducted Power (dBm)	23.79	23.60	23.35	23.82	23.67	23.30	23.85	23.66	23.25
Conducted Power (Watts)	0.2393	0.2291	0.2163	0.2410	0.2328	0.2138	0.2427	0.2323	0.2113
EIRP(dBm)	24.79	24.60	24.35	24.82	24.67	24.30	24.85	24.66	24.25
EIRP(Watts)	0.3013	0.2884	0.2723	0.3034	0.2931	0.2692	0.3055	0.2924	0.2661





LTE Band 4 (GT - LC = 1.00 dB) 16QAM									
Bandwidth	1.4M			3M			5M		
Channel	19957	20175	20393	19965	20175	20385	19975	20175	20375
	(Low)	(Mid)	(High)	(Low)	(Mid)	(High)	(Low)	(Mid)	(High)
Frequency (MHz)	1710.7	1732.5	1754.3	1711.5	1732.5	1753.5	1712.5	1732.5	1752.5
Conducted Power (dBm)	23.67	23.39	23.08	23.69	23.46	23.03	23.69	23.40	23.04
Conducted Power (Watts)	0.2328	0.2183	0.2032	0.2339	0.2218	0.2009	0.2339	0.2188	0.2014
EIRP(dBm)	24.67	24.39	24.08	24.69	24.46	24.03	24.69	24.40	24.04
EIRP(Watts)	0.2931	0.2748	0.2559	0.2944	0.2793	0.2529	0.2944	0.2754	0.2535

LTE Band 4 (GT - LC = 1.00 dB) 16QAM									
Bandwidth	10M			15M			20M		
Channel	20000	20175	20350	20025	20175	20325	20050	20175	20300
	(Low)	(Mid)	(High)	(Low)	(Mid)	(High)	(Low)	(Mid)	(High)
Frequency (MHz)	1715	1732.5	1750	1717.5	1732.5	1747.5	1720	1732.5	1745
Conducted Power (dBm)	23.64	23.45	23.12	23.67	23.48	23.04	23.70	23.48	23.12
Conducted Power (Watts)	0.2312	0.2213	0.2051	0.2328	0.2228	0.2014	0.2344	0.2228	0.2051
EIRP(dBm)	24.64	24.45	24.12	24.67	24.48	24.04	24.70	24.48	24.12
EIRP(Watts)	0.2911	0.2786	0.2582	0.2931	0.2805	0.2535	0.2951	0.2805	0.2582



LTE Band 12 (GT - LC = 0.80 dB) QPSK									
Bandwidth	1.4M			3M			5M		
Channel	23017	23095	23173	23025	23095	23165	23035	23095	23155
	(Low)	(Mid)	(High)	(Low)	(Mid)	(High)	(Low)	(Mid)	(High)
Frequency (MHz)	699.7	707.5	715.3	700.5	707.5	714.5	701.5	707.5	713.5
Conducted Power (dBm)	23.94	24.02	23.89	23.96	24.02	24.01	24.00	23.96	23.94
Conducted Power (Watts)	0.2477	0.2523	0.2449	0.2489	0.2523	0.2518	0.2512	0.2489	0.2477
ERP(dBm)	22.59	22.67	22.54	22.61	22.67	22.66	22.65	22.61	22.59
ERP(Watts)	0.1816	0.1849	0.1795	0.1824	0.1849	0.1845	0.1841	0.1824	0.1816

LTE Band 12 (GT - LC = 0.80 dB) QPSK			
Bandwidth	10M		
Channel	23060	23095	23130
	(Low)	(Mid)	(High)
Frequency (MHz)	704	707.5	711
Conducted Power (dBm)	24.01	24.07	24.01
Conducted Power (Watts)	0.2518	0.2553	0.2518
ERP(dBm)	22.66	22.72	22.66
ERP(Watts)	0.1845	0.1871	0.1845



LTE Band 12 (GT - LC = 0.80 dB) 16QAM									
Bandwidth	1.4M			3M			5M		
Channel	23017	23095	23173	23025	23095	23165	23035	23095	23155
	(Low)	(Mid)	(High)	(Low)	(Mid)	(High)	(Low)	(Mid)	(High)
Frequency (MHz)	699.7	707.5	715.3	700.5	707.5	714.5	701.5	707.5	713.5
Conducted Power (dBm)	23.95	23.95	23.91	23.89	23.97	23.88	23.86	24.03	23.94
Conducted Power (Watts)	0.2483	0.2483	0.2460	0.2449	0.2495	0.2443	0.2432	0.2529	0.2477
ERP(dBm)	22.60	22.60	22.56	22.54	22.62	22.53	22.51	22.68	22.59
ERP(Watts)	0.1820	0.1820	0.1803	0.1795	0.1828	0.1791	0.1782	0.1854	0.1816

LTE Band 12 (GT - LC = 0.80 dB) 16QAM			
Bandwidth	10M		
Channel	23060	23095	23130
	(Low)	(Mid)	(High)
Frequency (MHz)	704	707.5	711
Conducted Power (dBm)	23.92	24.05	23.95
Conducted Power (Watts)	0.2466	0.2541	0.2483
ERP(dBm)	22.57	22.70	22.60
ERP(Watts)	0.1807	0.1862	0.1820



Peak-to-Average Ratio

Mode	LTE Band 2 / 20MHz				
Mod.	QPSK		16QAM		Limit: 13dB
RB Size	1RB	Full RB	1RB	Full RB	Result
Lowest CH	8.55	8.49	8.52	8.35	PASS
Middle CH	8.49	8.46	8.46	8.52	
Highest CH	8.32	8.49	8.43	8.41	

Mode	LTE Band 4 / 20MHz				
Mod.	QPSK		16QAM		Limit: 13dB
RB Size	1RB	Full RB	1RB	Full RB	Result
Lowest CH	8.41	8.55	8.49	8.43	PASS
Middle CH	8.41	8.49	8.38	8.46	
Highest CH	8.43	8.41	8.46	8.41	

Mode	LTE Band 12 / 10MHz				
Mod.	QPSK		16QAM		Limit: 13dB
RB Size	1RB	Full RB	1RB	Full RB	Result
Lowest CH	8.29	8.38	8.46	8.43	PASS
Middle CH	8.43	8.52	8.49	8.49	
Highest CH	8.32	8.52	8.32	8.43	



LTE Band 2 / 20MHz / QPSK

Lowest Channel / 1RB

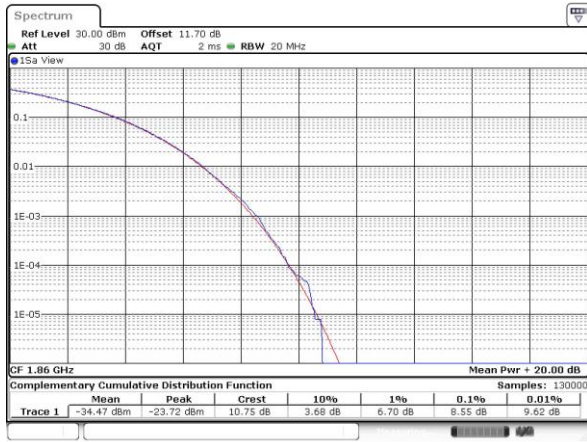

Date: 13.NOV.2018 23:39:28

Lowest Channel / Full RB

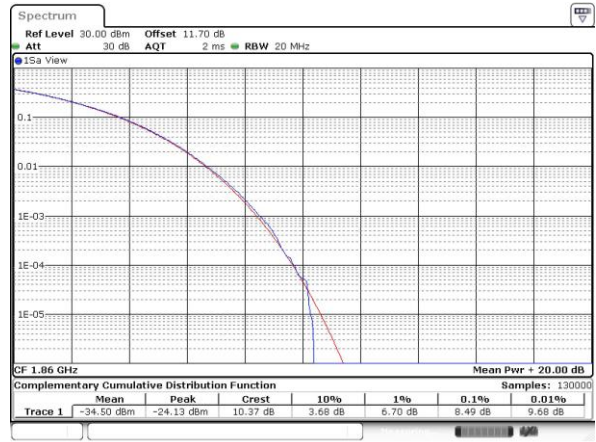

Date: 13.NOV.2018 23:40:32

Middle Channel / 1RB

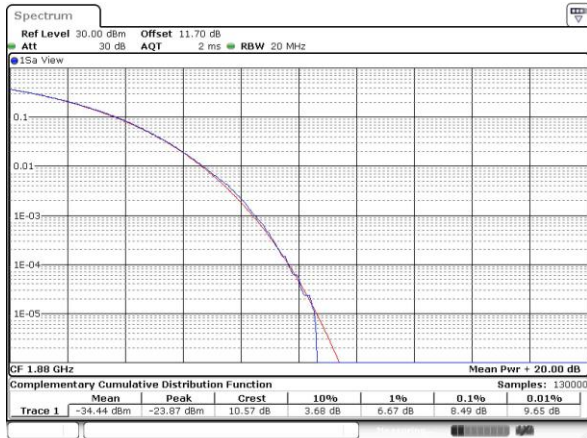

Date: 13.NOV.2018 23:38:41

Middle Channel / Full RB

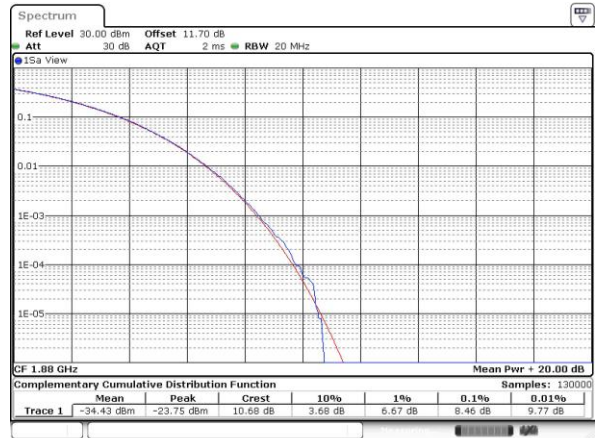

Date: 13.NOV.2018 23:37:50

Highest Channel / 1RB

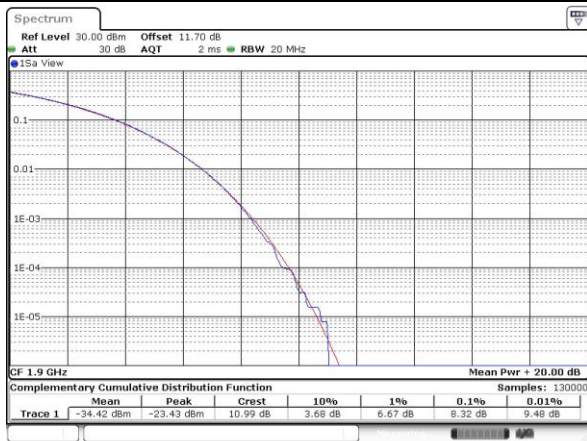

Date: 13.NOV.2018 23:35:50

Highest Channel / Full RB



Date: 13.NOV.2018 23:37:13



LTE Band 2 / 20MHz / 16QAM

Lowest Channel / 1RB



Date: 13.NOV.2018 23:39:47

Lowest Channel / Full RB



Date: 13.NOV.2018 23:40:07

Middle Channel / 1RB



Date: 13.NOV.2018 23:38:19

Middle Channel / Full RB



Date: 13.NOV.2018 23:38:01

Highest Channel / 1RB

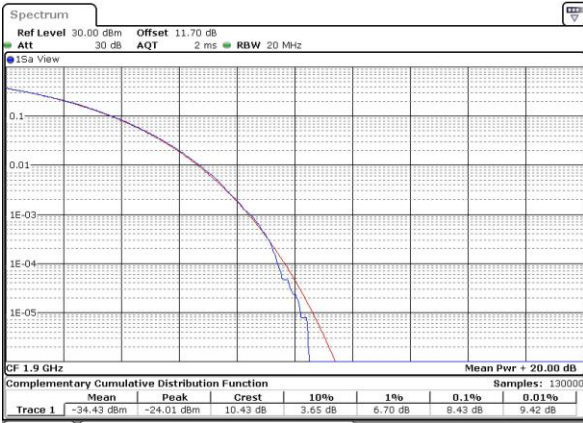

Date: 13.NOV.2018 23:36:02

Highest Channel / Full RB

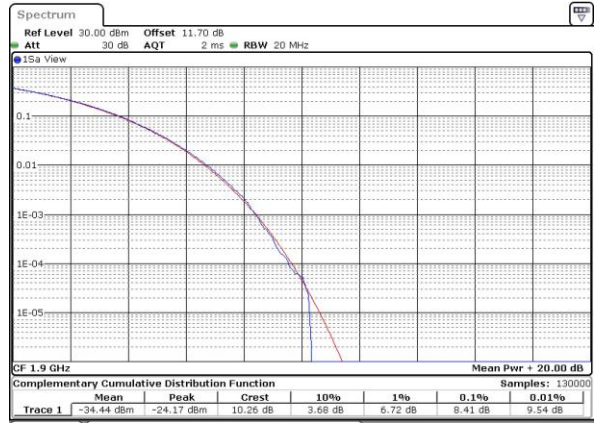

Date: 13.NOV.2018 23:37:00



LTE Band 4 / 20MHz / QPSK

Lowest Channel / 1RB

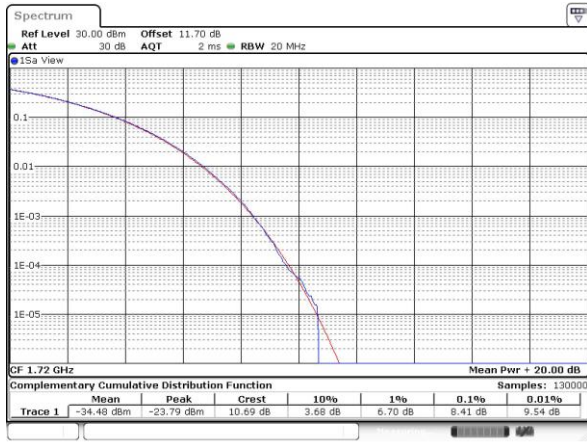

Date: 14.NOV.2018 00:49:38

Lowest Channel / Full RB

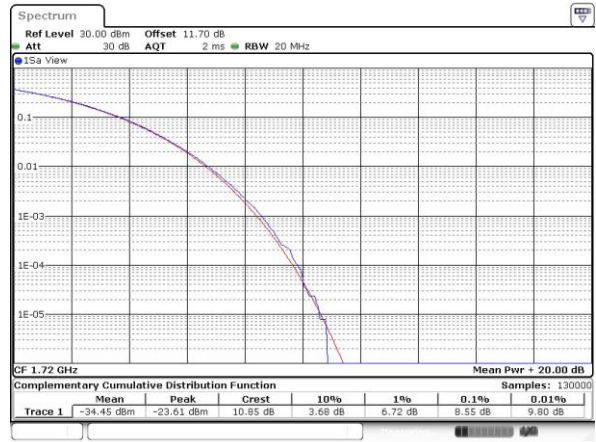

Date: 14.NOV.2018 00:50:46

Middle Channel / 1RB

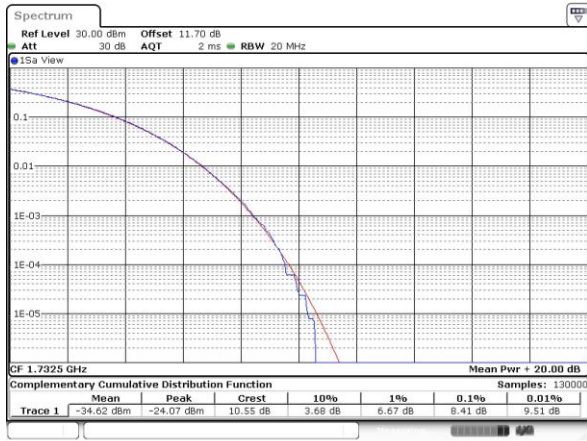

Date: 14.NOV.2018 00:49:08

Middle Channel / Full RB

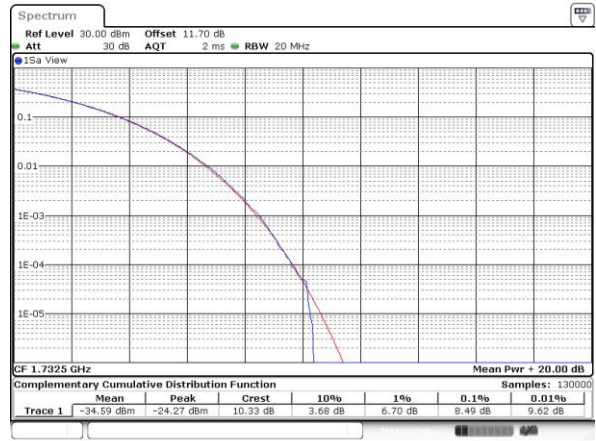

Date: 14.NOV.2018 00:47:54

Highest Channel / 1RB

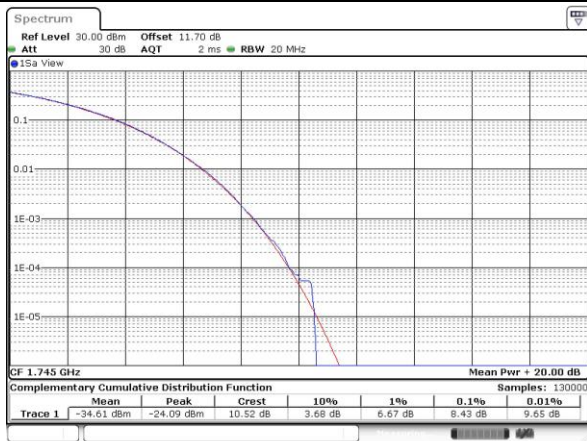

Date: 14.NOV.2018 00:46:25

Highest Channel / Full RB



Date: 14.NOV.2018 00:47:14



LTE Band 4 / 20MHz / 16QAM

Lowest Channel / 1RB

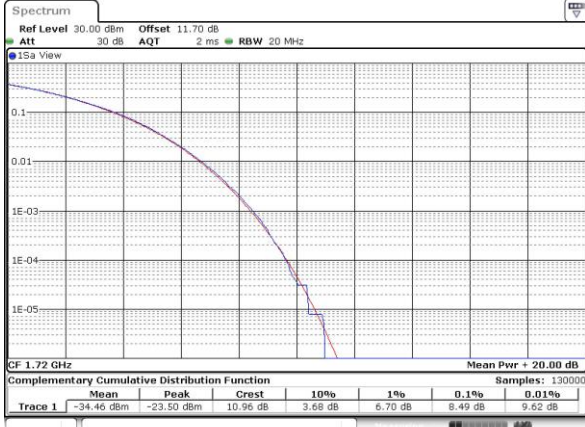

Date: 14.NOV.2018 00:49:48

Lowest Channel / Full RB

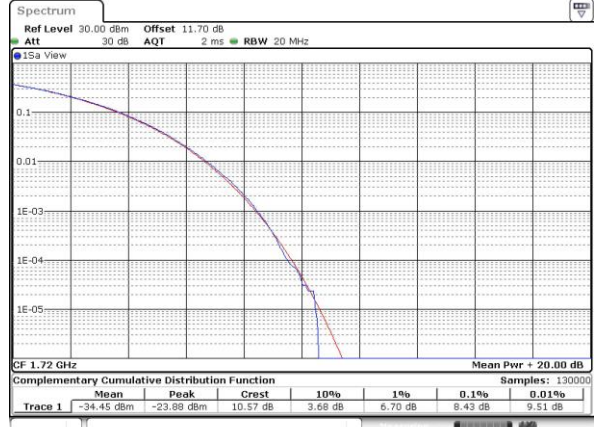

Date: 14.NOV.2018 00:50:14

Middle Channel / 1RB

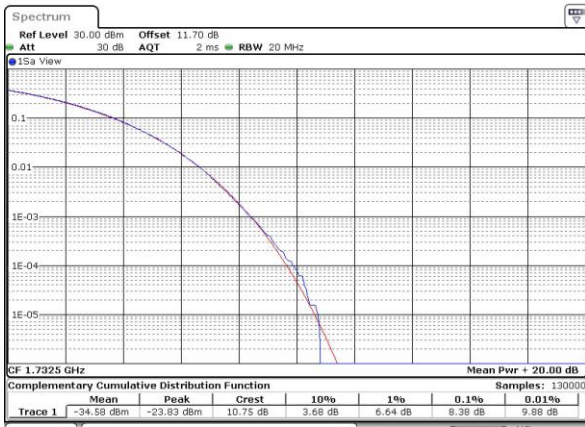

Date: 14.NOV.2018 00:48:56

Middle Channel / Full RB

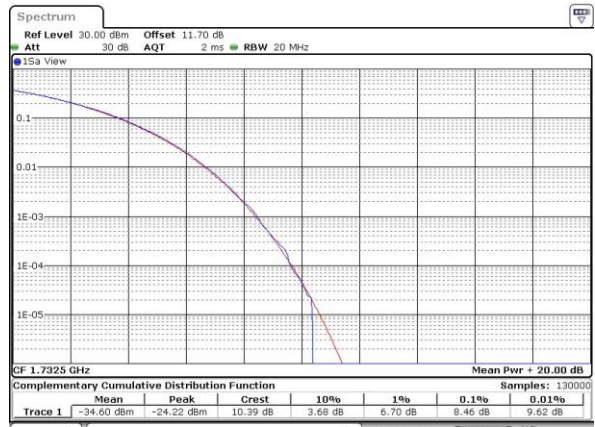

Date: 14.NOV.2018 00:48:14

Highest Channel / 1RB

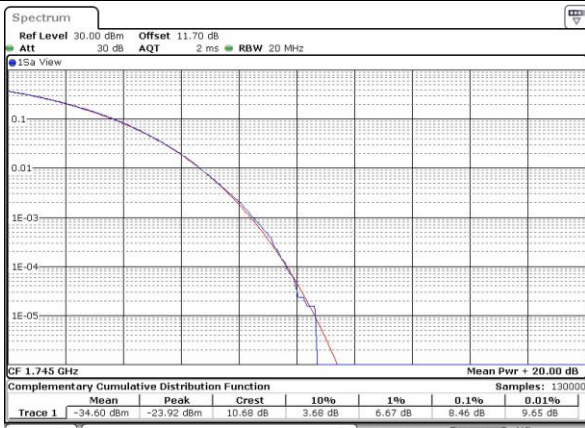

Date: 14.NOV.2018 00:46:34

Highest Channel / Full RB



Date: 14.NOV.2018 00:47:04





LTE Band 12 / 10MHz / QPSK

Lowest Channel / 1RB

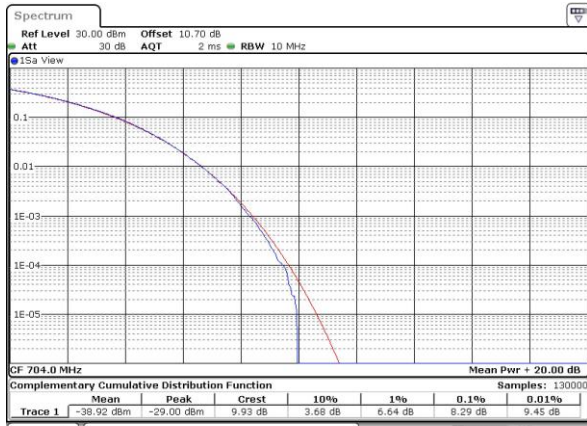

Date: 14.NOV.2018 01:27:34

Lowest Channel / Full RB

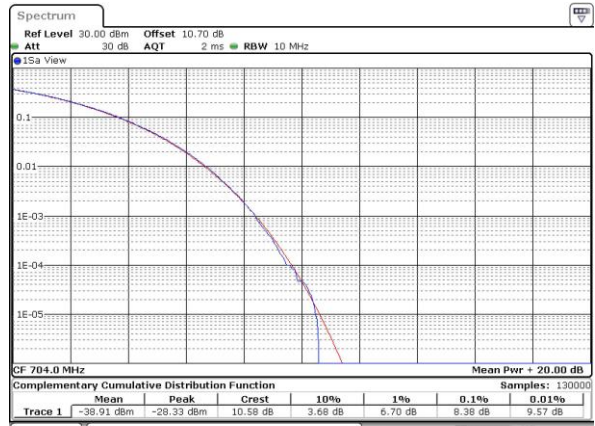

Date: 14.NOV.2018 01:26:39

Middle Channel / 1RB

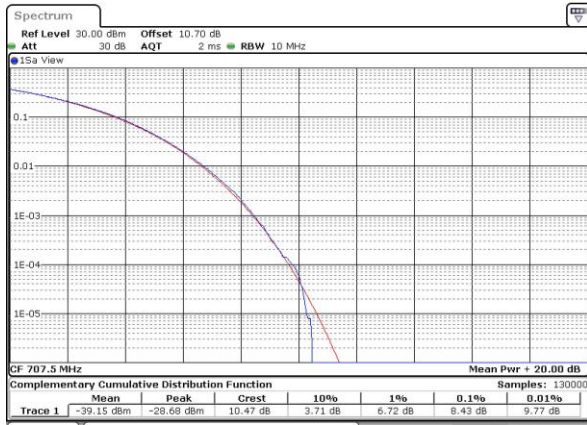

Date: 14.NOV.2018 01:25:48

Middle Channel / Full RB

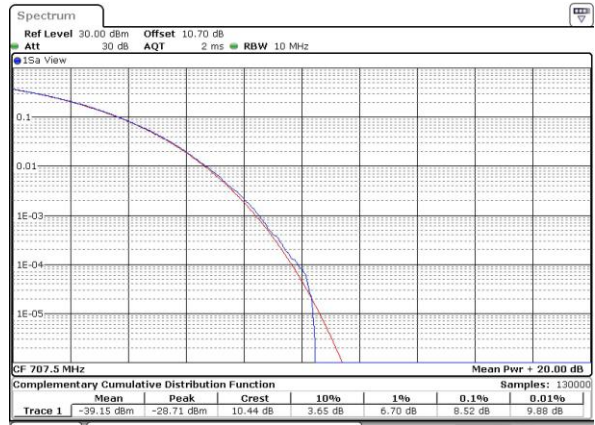

Date: 14.NOV.2018 01:26:06

Highest Channel / 1RB

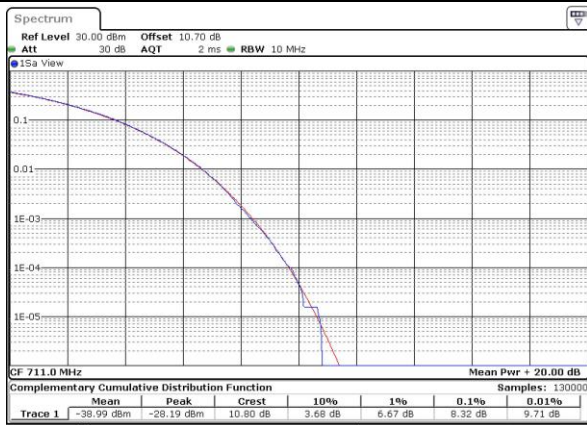

Date: 14.NOV.2018 01:31:27

Highest Channel / Full RB



Date: 14.NOV.2018 01:29:47



LTE Band 12 / 10MHz / 16QAM

Lowest Channel / 1RB



Date: 14.NOV.2018 01:27:22

Lowest Channel / Full RB

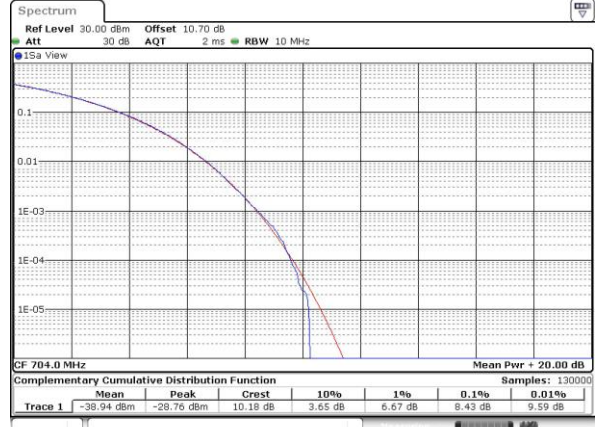

Date: 14.NOV.2018 01:26:54

Middle Channel / 1RB

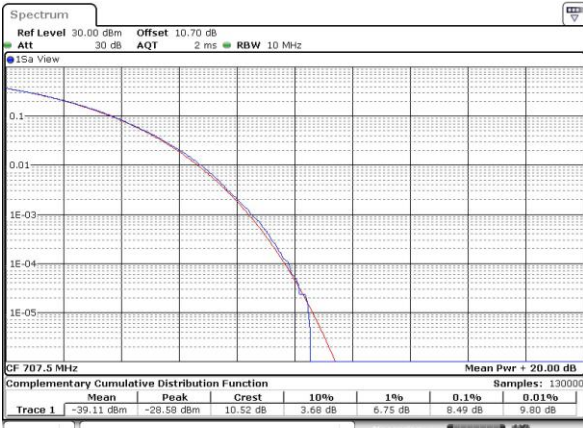

Date: 14.NOV.2018 01:25:37

Middle Channel / Full RB

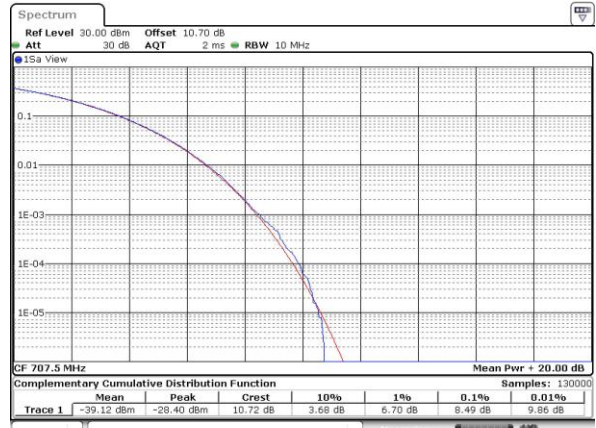

Date: 14.NOV.2018 01:25:19

Highest Channel / 1RB

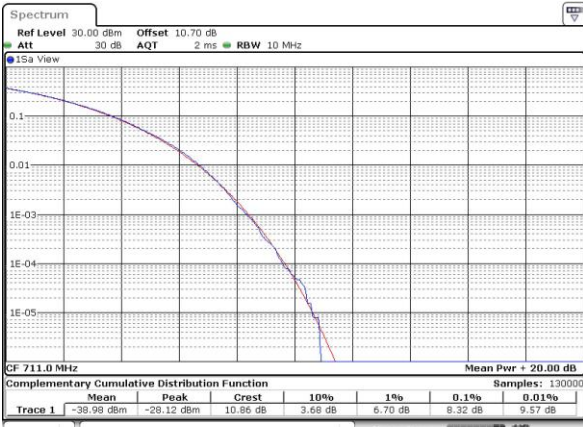

Date: 14.NOV.2018 01:31:17

Highest Channel / Full RB

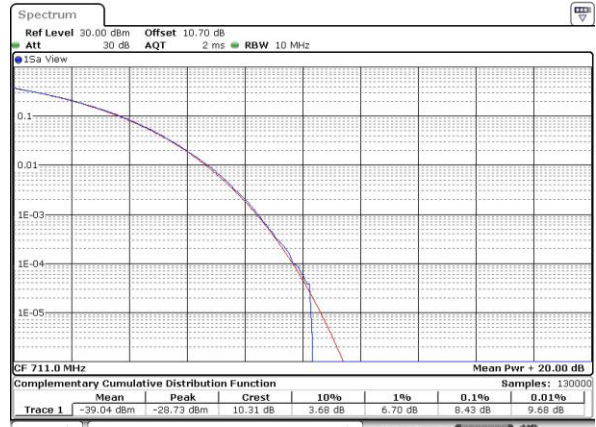

Date: 14.NOV.2018 01:30:02



26dB Bandwidth

Mode	LTE Band 2 : 26dB BW(MHz)											
	1.4MHz		3MHz		5MHz		10MHz		15MHz		20MHz	
Mod.	QPSK	16QAM	QPSK	16QAM	QPSK	16QAM	QPSK	16QAM	QPSK	16QAM	QPSK	16QAM
Lowest CH	-	-	-	-	-	-	1.36	1.48	-	-	-	-
Middle CH	-	-	-	-	-	-	1.46	1.54	-	-	-	-
Highest CH	-	-	-	-	-	-	1.44	1.40	-	-	-	-

Mode	LTE Band 4 : 26dB BW(MHz)											
	1.4MHz		3MHz		5MHz		10MHz		15MHz		20MHz	
Mod.	QPSK	16QAM	QPSK	16QAM	QPSK	16QAM	QPSK	16QAM	QPSK	16QAM	QPSK	16QAM
Lowest CH	-	-	-	-	-	-	1.40	1.32	-	-	-	-
Middle CH	-	-	-	-	-	-	1.34	1.44	-	-	-	-
Highest CH	-	-	-	-	-	-	1.30	1.42	-	-	-	-

Mode	LTE Band 12 : 26dB BW(MHz)											
	1.4MHz		3MHz		5MHz		10MHz		15MHz		20MHz	
Mod.	QPSK	16QAM	QPSK	16QAM	QPSK	16QAM	QPSK	16QAM	QPSK	16QAM	QPSK	16QAM
Lowest CH	-	-	-	-	-	-	1.40	1.36	-	-	-	-
Middle CH	-	-	-	-	-	-	1.38	1.46	-	-	-	-
Highest CH	-	-	-	-	-	-	1.32	1.38	-	-	-	-



LTE Band 2

Lowest Channel / 10MHz / QPSK

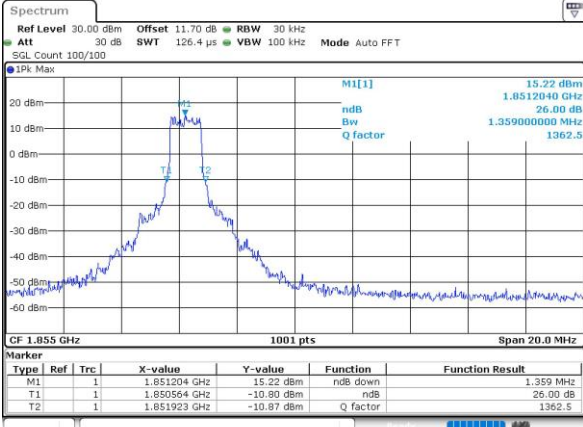

Date: 14.NOV.2018 02:59:35

Lowest Channel / 10MHz / 16QAM

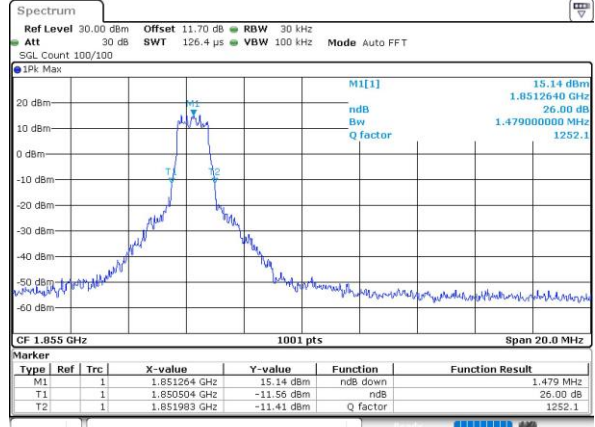

Date: 14.NOV.2018 02:58:51

Middle Channel / 10MHz / QPSK

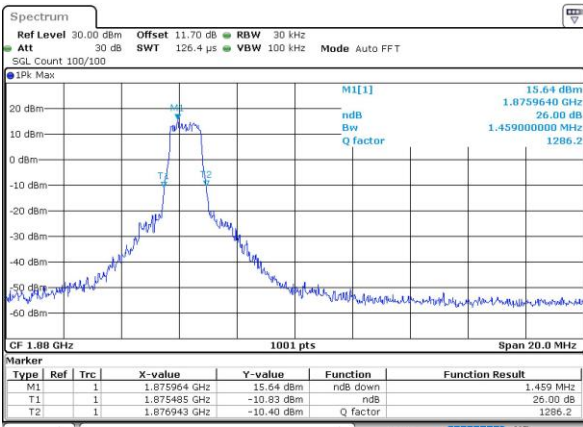

Date: 14.NOV.2018 02:56:43

Middle Channel / 10MHz / 16QAM

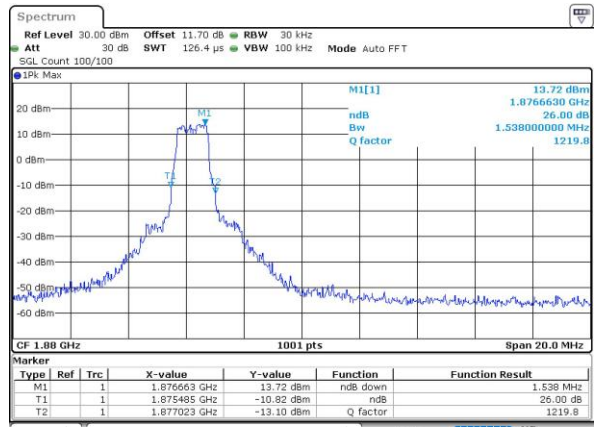

Date: 14.NOV.2018 02:57:08

Highest Channel / 10MHz / QPSK

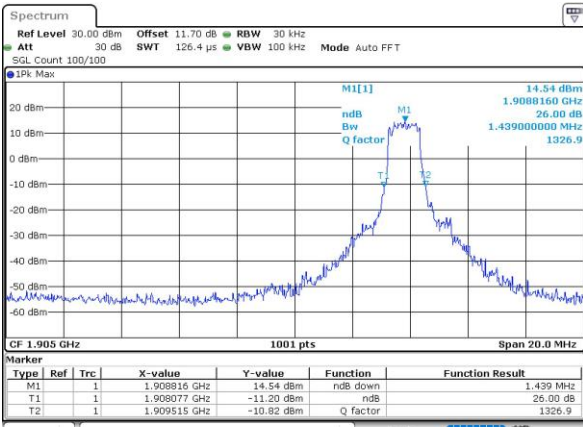

Date: 14.NOV.2018 03:03:46

Highest Channel / 10MHz / 16QAM

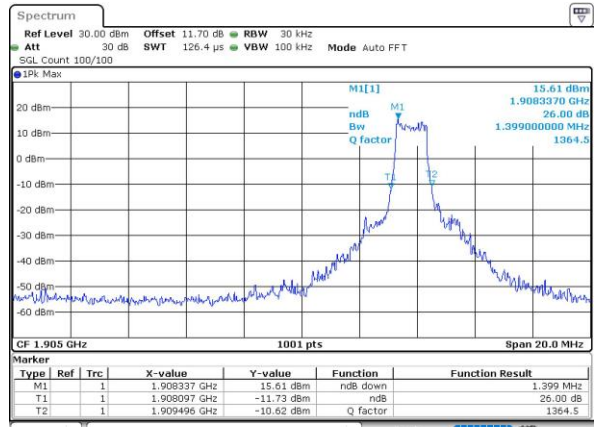

Date: 14.NOV.2018 03:02:32



LTE Band 4

Lowest Channel / 10MHz / QPSK

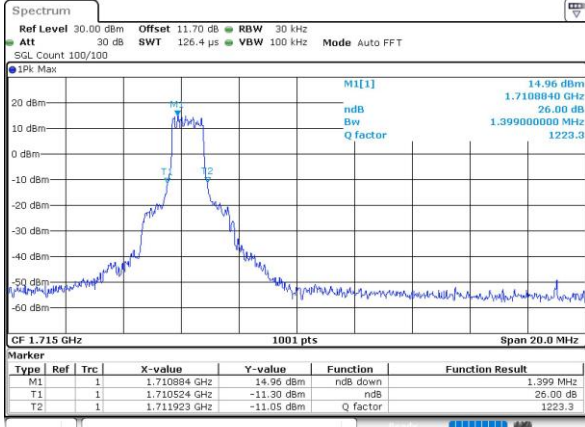

Date: 14.NOV.2018 04:03:44

Lowest Channel / 10MHz / 16QAM

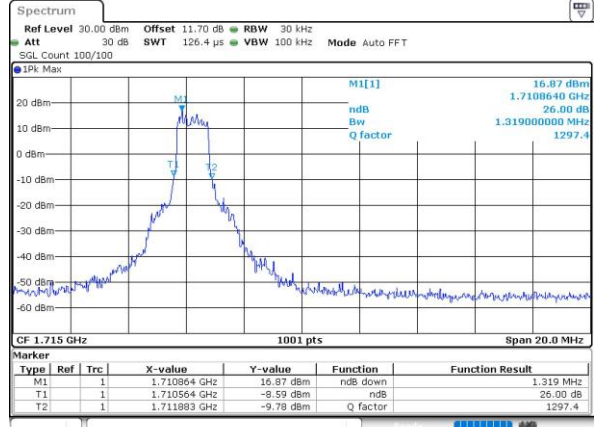

Date: 14.NOV.2018 04:02:53

Middle Channel / 10MHz / QPSK

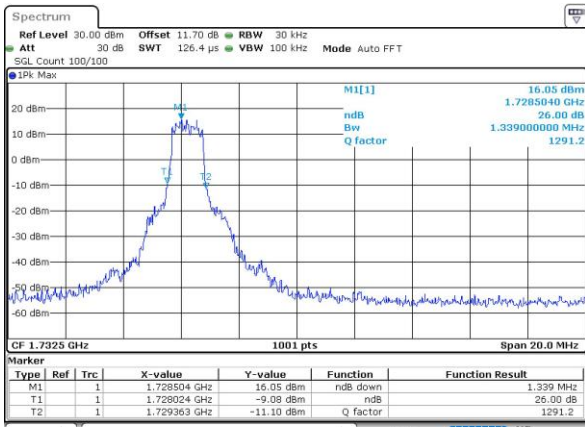

Date: 14.NOV.2018 03:57:29

Middle Channel / 10MHz / 16QAM

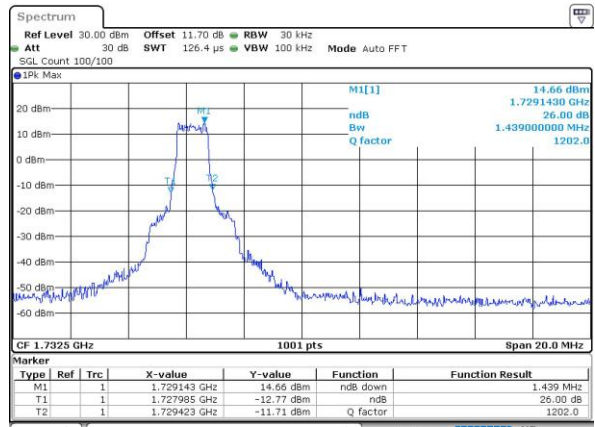

Date: 14.NOV.2018 03:58:23

Highest Channel / 10MHz / QPSK

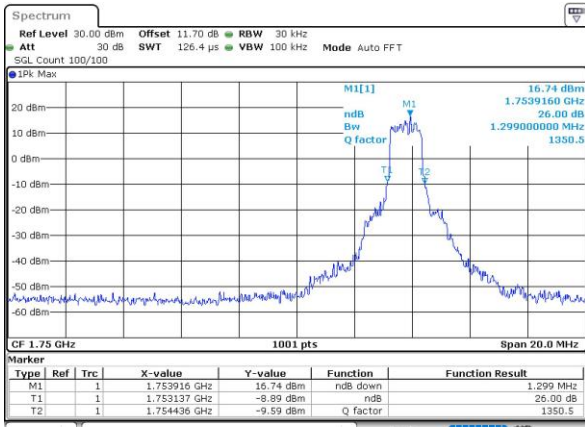

Date: 14.NOV.2018 04:06:09

Highest Channel / 10MHz / 16QAM

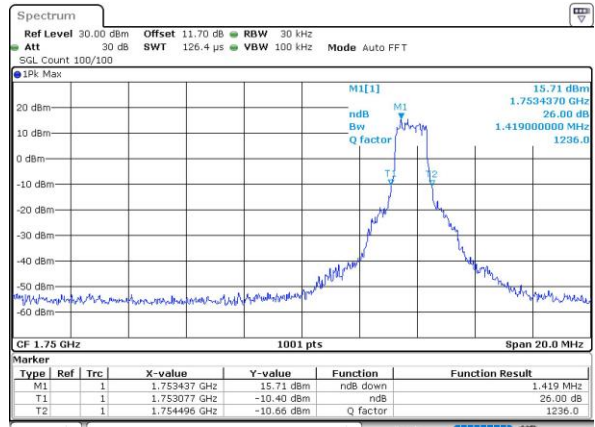

Date: 14.NOV.2018 04:05:34



LTE Band 12

Lowest Channel / 10MHz / QPSK

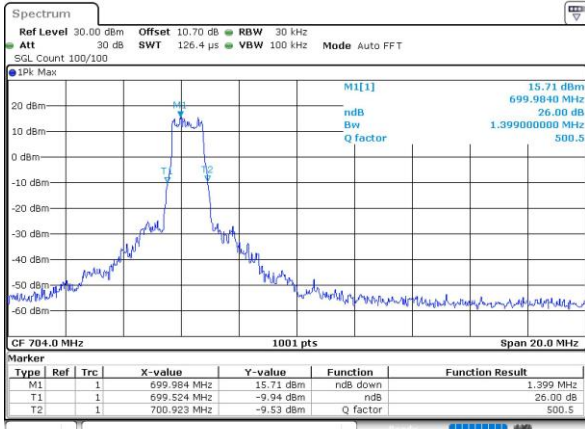

Date: 14.NOV.2018 01:16:30

Lowest Channel / 10MHz / 16QAM

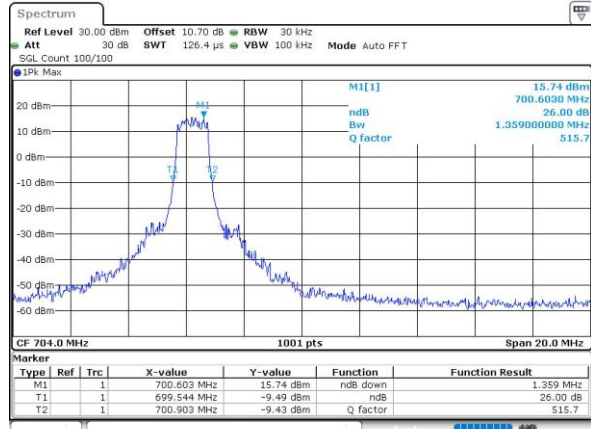

Date: 14.NOV.2018 01:17:36

Middle Channel / 10MHz / QPSK

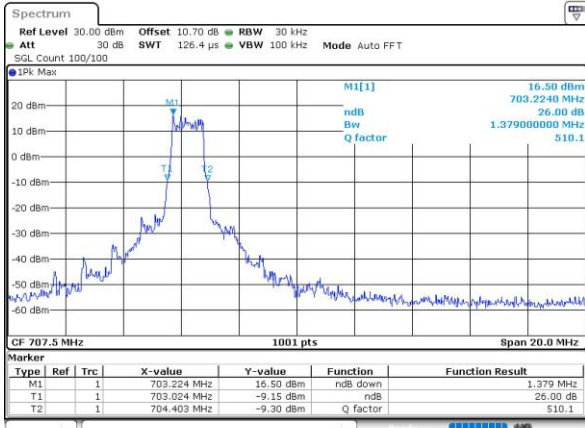

Date: 14.NOV.2018 01:24:27

Middle Channel / 10MHz / 16QAM

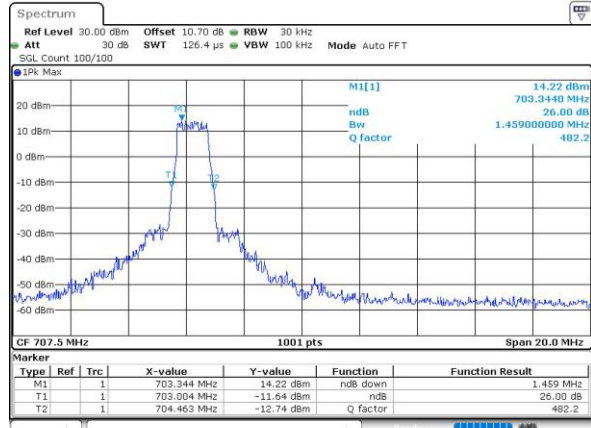

Date: 14.NOV.2018 01:24:50

Highest Channel / 10MHz / QPSK

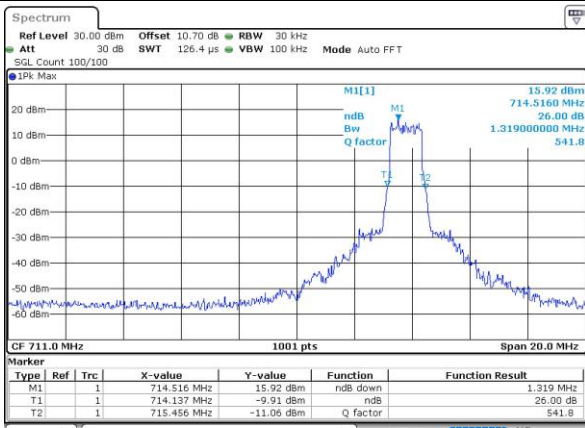

Date: 14.NOV.2018 01:28:38

Highest Channel / 10MHz / 16QAM

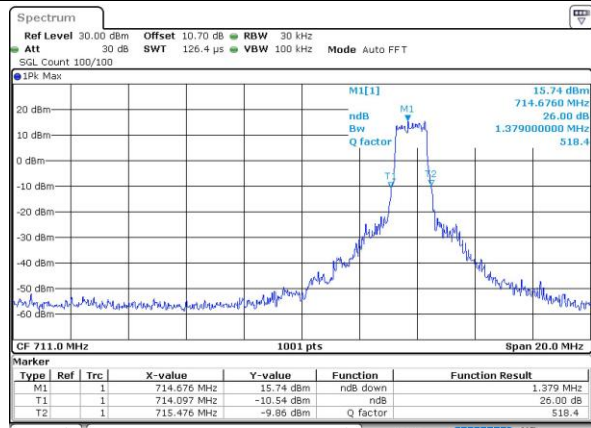

Date: 14.NOV.2018 01:30:25



### Occupied Bandwidth

Mode	LTE Band 2 : 99%OBW(MHz)											
	1.4MHz		3MHz		5MHz		10MHz		15MHz		20MHz	
Mod.	QPSK	16QAM	QPSK	16QAM	QPSK	16QAM	QPSK	16QAM	QPSK	16QAM	QPSK	16QAM
Lowest CH	-	-	-	-	-	-	1.08	1.12	-	-	-	-
Middle CH	-	-	-	-	-	-	1.14	1.1	-	-	-	-
Highest CH	-	-	-	-	-	-	1.1	1.12	-	-	-	-

Mode	LTE Band 4 : 99%OBW(MHz)											
	1.4MHz		3MHz		5MHz		10MHz		15MHz		20MHz	
Mod.	QPSK	16QAM	QPSK	16QAM	QPSK	16QAM	QPSK	16QAM	QPSK	16QAM	QPSK	16QAM
Lowest CH	-	-	-	-	-	-	1.12	1.12	-	-	-	-
Middle CH	-	-	-	-	-	-	1.08	1.1	-	-	-	-
Highest CH	-	-	-	-	-	-	1.1	1.12	-	-	-	-

Mode	LTE Band 12 : 99%OBW(MHz)											
	1.4MHz		3MHz		5MHz		10MHz		15MHz		20MHz	
Mod.	QPSK	16QAM	QPSK	16QAM	QPSK	16QAM	QPSK	16QAM	QPSK	16QAM	QPSK	16QAM
Lowest CH	-	-	-	-	-	-	1.12	1.12	-	-	-	-
Middle CH	-	-	-	-	-	-	1.12	1.1	-	-	-	-
Highest CH	-	-	-	-	-	-	1.1	1.12	-	-	-	-



LTE Band 2

Lowest Channel / 10MHz / QPSK

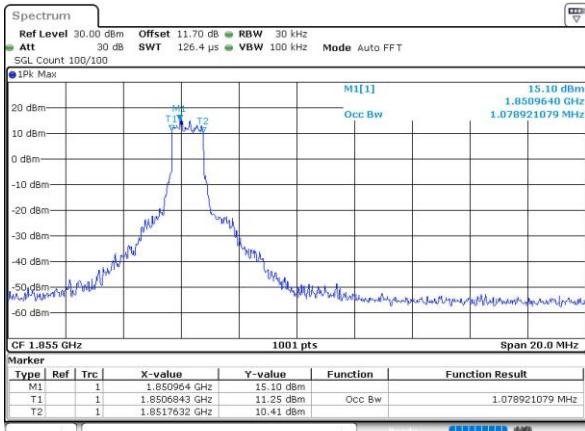

Date: 14.NOV.2018 02:59:24

Lowest Channel / 10MHz / 16QAM

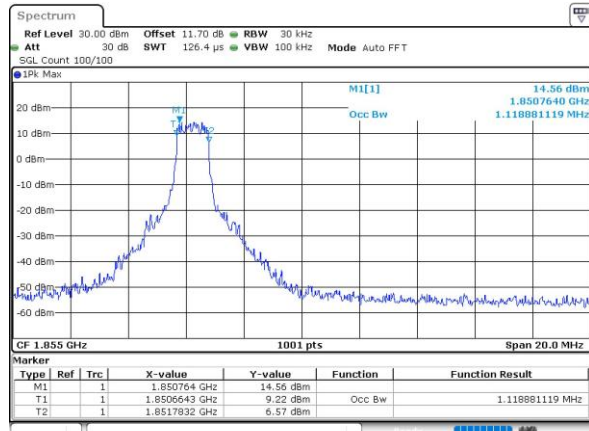

Date: 14.NOV.2018 02:59:03

Middle Channel / 10MHz / QPSK

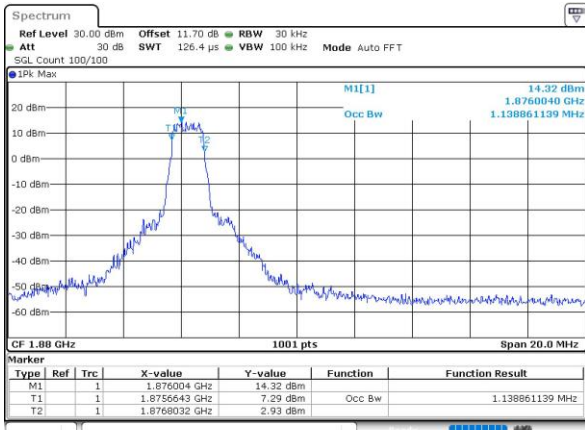

Date: 14.NOV.2018 02:56:32

Middle Channel / 10MHz / 16QAM

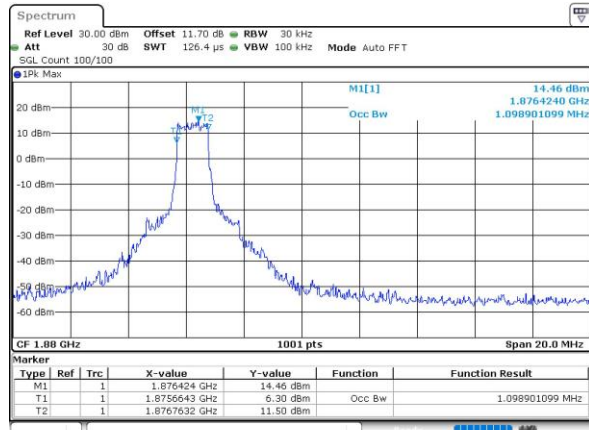

Date: 14.NOV.2018 02:56:56

Highest Channel / 10MHz / QPSK

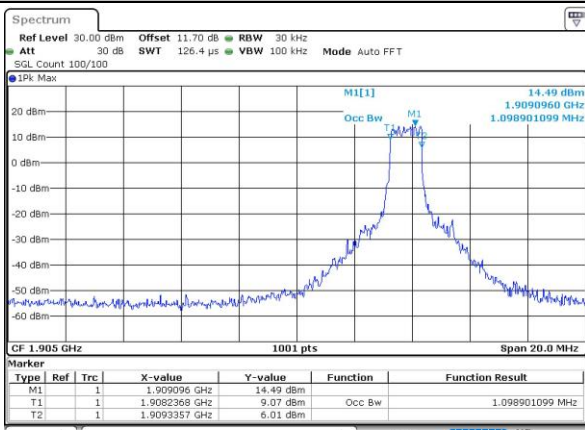

Date: 14.NOV.2018 03:03:36

Highest Channel / 10MHz / 16QAM

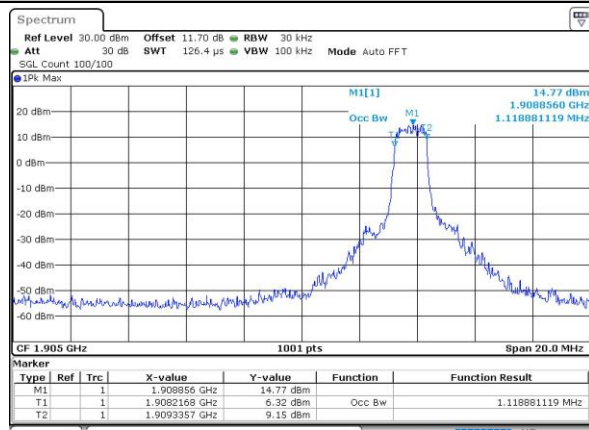

Date: 14.NOV.2018 03:02:20