

TEST REPORT

For

Advanced Card Systems Ltd.

Units 2010-2013, 20th Floor, Chevalier Commercial Centre, 8 Wang Hoi Road,
Kowloon Bay, Hong Kong

FCC ID: V5MACR1281UC

Report Type: Original Report	Product Type: Contactless Smart Card Reader and Writer
Test Engineer: Back Huang	<i>Back Huang</i>
Report Number: RSZ110622004-00	
Report Date: 2011-09-23	
Reviewed By: Merry Zhao EMC Manager	<i>Merry Zhao</i>
Test Laboratory:	Bay Area Compliance Laboratories Corp. (Shenzhen) 6/F, the 3rd Phase of WanLi Industrial Building, ShiHua Road, FuTian Free Trade Zone Shenzhen, Guangdong, China Tel: +86-755-33320018 Fax: +86-755-33320008 www.baclcorp.com.cn

Note: This test report is prepared for the customer shown above and for the equipment described herein. It may not be duplicated or used in part without prior written consent from Bay Area Compliance Laboratories Corp. This report **must not** be used by the customer to claim product certification, approval, or endorsement by NVLAP*, or any agency of the Federal Government.

* This report contains data that are not covered by the NVLAP accreditation and are marked with an asterisk "★" (Rev.2)

TABLE OF CONTENTS

GENERAL INFORMATION.....4

 PRODUCT DESCRIPTION FOR EQUIPMENT UNDER TEST (EUT)4

 OBJECTIVE4

 RELATED SUBMITTAL(S)/GRANT(S).....4

 TEST METHODOLOGY4

 TEST FACILITY4

SYSTEM TEST CONFIGURATION.....6

 JUSTIFICATION6

 EUT EXERCISE SOFTWARE6

 EQUIPMENT MODIFICATIONS6

 LOCAL SUPPORT EQUIPMENT LIST AND DETAILS6

 EXTERNAL I/O CABLE.....6

 CONFIGURATION OF TEST SETUP7

 BLOCK DIAGRAM OF TEST SETUP7

SUMMARY OF TEST RESULTS8

FCC §15.203 - ANTENNA REQUIREMENT.....9

 APPLICABLE STANDARD9

 ANTENNA CONNECTED CONSTRUCTION9

FCC §15.207 – AC LINE CONDUCTED EMISSION10

 MEASUREMENT UNCERTAINTY10

 EUT SETUP10

 EMI TEST RECEIVER SETUP.....11

 TEST PROCEDURE11

 TEST EQUIPMENT LIST AND DETAILS.....11

 TEST RESULTS SUMMARY11

 TEST DATA11

FCC §15.225, §15.205 & §15.209 - RADIATED EMISSIONS TEST14

 MEASUREMENT UNCERTAINTY14

 EUT SETUP14

 EMI TEST RECEIVER SETUP.....15

 CORRECTED AMPLITUDE & MARGIN CALCULATION15

 TEST EQUIPMENT LIST AND DETAILS.....15

 TEST RESULTS SUMMARY15

 TEST DATA16

FCC §15.225(A) (B) (C) – FIELD STRENGTH OF RADIATED EMISSIONS.....18

 APPLICABLE STANDARD18

 EUT SETUP18

 TEST EQUIPMENT LIST AND DETAILS.....18

 TEST DATA18

FCC §15.225(E) - FREQUENCY STABILITY.....22

 APPLICABLE STANDARD22

 TEST PROCEDURE22

 TEST EQUIPMENT LIST AND DETAILS.....22

 TEST DATA22

FCC §15.215(C) – 20 DB BANDWIDTH TESTING.....24
APPLICABLE STANDARD24
TEST PROCEDURE24
TEST EQUIPMENT LIST AND DETAILS.....24
TEST DATA24

GENERAL INFORMATION

Product Description for Equipment Under Test (EUT)

The *Advanced Card Systems Ltd.*'s product, model number: *ACR1281U-C (FCC ID: V5MACR1281UC)* (the "EUT") in this report is a *Contactless Smart Card Reader and Writer*. The EUT is measured approximately 120.48 mm (L) x 71.97 mm (W) x 20.4 mm (H). Rated input voltage: DC 5V from USB Port.

** All measurement and test data in this report was gathered from production sample serial number: RR193-XXXXXX (Assigned by applicant). The EUT was received on 2011-06-22.*

Objective

This Type approval report is prepared on behalf of *Advanced Card Systems Ltd.* in accordance with Part 2, Subpart J, and Part 15, Subparts A, B and C of the Federal Communication Commissions rules.

The objective is to determine the compliance of the EUT with FCC rules, sec 15.203, 15.205, 15.207, 15.209 and 15.225.

Related Submittal(s)/Grant(s)

No Related Submittals.

Test Methodology

All measurements contained in this report were conducted with ANSI C63.4-2009, American National Standard for Methods of Measurement of Radio-Noise Emissions from Low-Voltage Electrical and Electronic Equipment in the range of 9 kHz to 40 GHz.

All radiated and conducted emissions measurement was performed at Bay Area Compliance Lab Corp. (Shenzhen). The radiated testing was performed at an antenna-to-EUT distance of 3 meters.

Test Facility

The Test site used by Bay Area Compliance Laboratories Corp.(Shenzhen) to collect test data is located on the 6/F, the 3rd Phase of WanLi Industrial Building, ShiHua Road, FuTian Free Trade Zone Shenzhen, Guangdong, China.

Test site at Bay Area Compliance Laboratories Corp. (Shenzhen) has been fully described in reports submitted to the Federal Communication Commission (FCC). The details of these reports have been found to be in compliance with the requirements of Section 2.948 of the FCC Rules on December 06, 2010. The facility also complies with the radiated and AC line conducted test site criteria set forth in ANSI C63.4-2009.

The Federal Communications Commission has the reports on file and is listed under FCC Registration No.: 382179. The test site has been approved by the FCC for public use and is listed in the FCC Public Access Link (PAL) database.

Additionally, Bay Area Compliance Laboratories Corp. (Shenzhen) is an ISO/IEC 17025 accredited laboratory, and is accredited by National Voluntary Laboratory Accredited Program (Lab Code 200707-0).



The current scope of accreditations can be found at <http://ts.nist.gov/Standards/scopes/2007070.htm>

SYSTEM TEST CONFIGURATION

Justification

The system was configured for testing in a typical fashion (as normally used by a typical user).

EUT Exercise Software

The software was provided by the manufacture.

Equipment Modifications

Bay Area Compliance Lab Corp. (Shenzhen) has not done any modification on the EUT.

Local Support Equipment List and Details

Manufacturer	Description	Model	Serial Number
DELL	Host PC	1#	N/A
DELL	Keyboard 1#	L100	CNORH656658907BL04TY
DELL	Mouse 1#	MOC5UO	G1B0096D
DELL	LCD 1#	E178WFPC	CN-OWY564-64180-7C4-2SQH

External I/O Cable

Cable Description	Length (m)	From/Port	To
Unshielded Undetachable Power Cable	1.8	Host PC	LISN
Unshielded Undetachable USB Cable	1.0	EUT	Host PC

Configuration of Test Setup

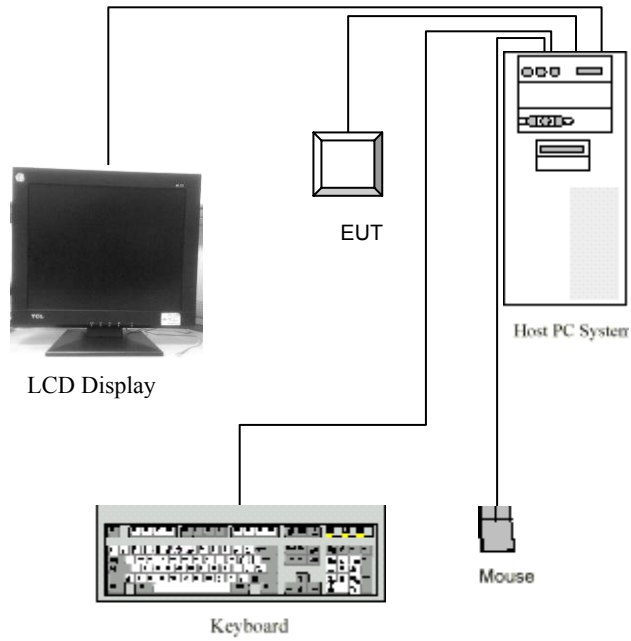

Block Diagram of Test Setup

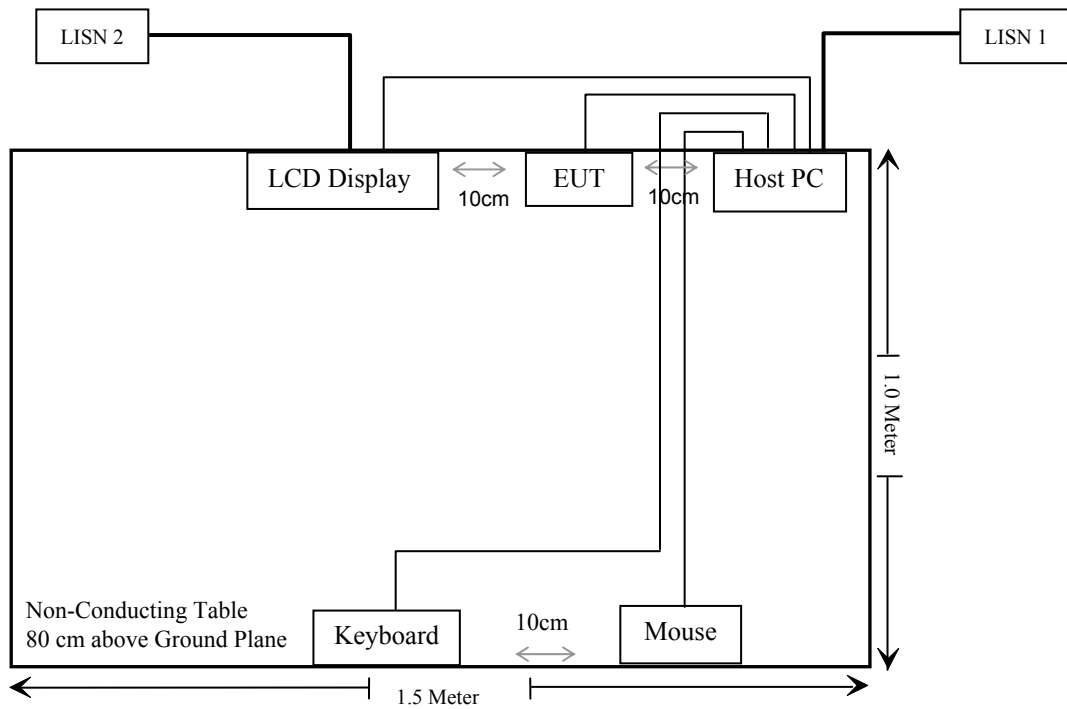

SUMMARY OF TEST RESULTS

FCC Rules	Description of Test	Result
§15.203	Antenna Requirement	Compliance
§15.207	AC Line Conducted Emission	Compliance
§15.225(d) §15.209 §15.205	Radiated Emission Test	Compliance
§15.225(a) (b) (c)	Field Strength of Radiated Emissions	Compliance
§15.225(e)	Frequency Stability	Compliance
§15.215(c)	20 dB Emission Bandwidth	Compliance

FCC §15.203 - ANTENNA REQUIREMENT

Applicable Standard

An intentional radiator shall be designed to ensure that no antenna other than that furnished by the responsible party shall be used with the device. The use of a permanently attached antenna or of an antenna that uses a unique coupling to the intentional radiator shall be considered sufficient to comply with the provisions of this section.

Antenna Connected Construction

The EUT has a printed antenna on PCB, which complies with the Part 15.203. Please see EUT photo for details.

FCC §15.207 – AC LINE CONDUCTED EMISSION

Measurement Uncertainty

All measurements involve certain levels of uncertainties, especially in field of EMC. The factors contributing to uncertainties are spectrum analyzer, cable loss, and LISN.

Based on NIS 81, The Treatment of Uncertainty in EMC Measurements, the best estimate of the uncertainty of any conducted emissions measurement at Bay Area Compliance Lab Corp. (Shenzhen) is ± 2.4 dB(k=2, 95% level of confidence).

EUT Setup

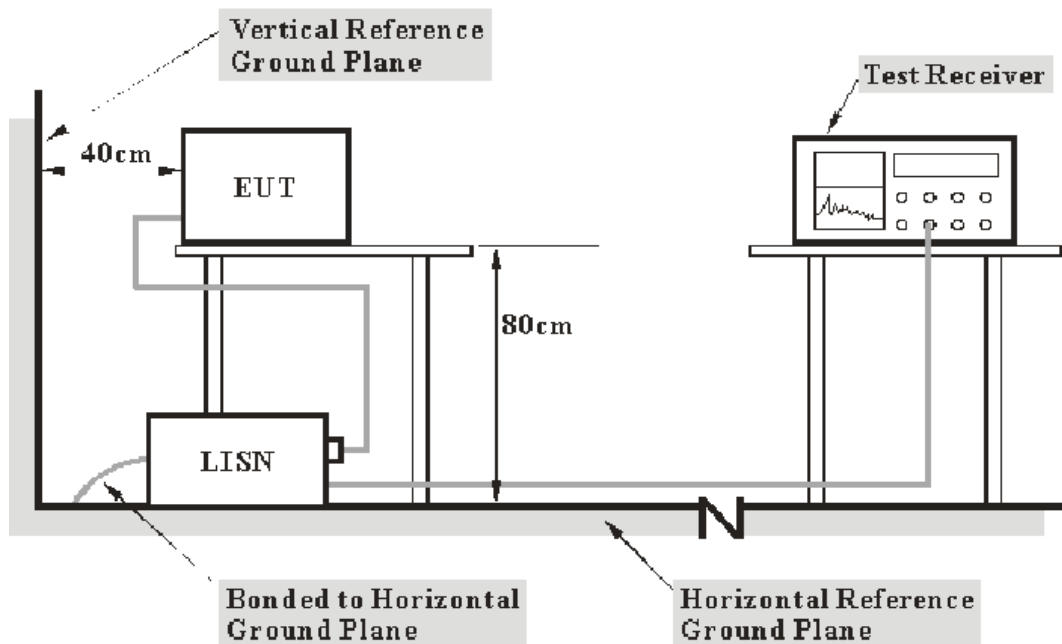

- Note:**
1. Support units were connected to second LISN.
 2. Both of LISNs (AMN) 80 cm from EUT and at the least 80 cm from other units and other metal planes support units.

The setup of EUT is according with per ANSI C63.4-2009 measurement procedure. The specification used was with the FCC Part 15.207.

The external I/O cables were draped along the test table and formed a bundle 30 to 40 cm long in the middle.

The spacing between the peripherals was 10 cm.

The host PC was connected to a 120 VAC/60 Hz power source.

EMI Test Receiver Setup

The EMI test receiver was set to investigate the spectrum from 150 kHz to 30 MHz.

During the conducted emission test, the EMI test receiver was set with the following configurations:

<i><u>Frequency Range</u></i>	<i><u>IF B/W</u></i>
150 kHz – 30 MHz	9 kHz

Test Procedure

During the conducted emission test, the host PC was connected to the outlet of the first LISN, and the display was connected to the outlet of the second LISN.

Maximizing procedure was performed on the six (6) highest emissions of the EUT.

All data was recorded in the Quasi-peak and average detection mode.

Test Equipment List and Details

Manufacturer	Description	Model	Serial Number	Calibration Date	Calibration Due Date
Rohde & Schwarz	EMI Test Receiver	ESCS30	100035	2011-03-03	2012-03-02
Rohde & Schwarz	L.I.S.N.	ESH2-Z5	892107/021	2011-03-09	2012-03-08

* **Statement of Traceability:** Bay Area Compliance Lab Corp. (Shenzhen) attests that all calibrations have been performed in accordance to NVLAP requirements, traceable to the NIST.

Test Results Summary

According to the recorded data in following table, the EUT complied with the FCC Part 15.207, with the worst margin reading of:

6.74 dB at 1.520 MHz in the Line conducted mode

Test Data

Environmental Conditions

Temperature:	25 °C
Relative Humidity:	48 %
ATM Pressure:	100.0 kPa

The testing was performed by Back Huang on 2011-07-26.

Test Mode: Transmitting

AC 120 V/60 Hz, Line:



Frequency (MHz)	Corrected Result (dBμV)	Correction Factor (dB)	Limit (dBμV)	Margin (dB)	Remark (PK/QP/Ave.)
1.520	49.26	10.10	56.00	6.74	QP
1.655	47.37	10.10	56.00	8.63	QP
1.655	36.93	10.10	46.00	9.07	Ave.
2.405	36.12	10.10	46.00	9.88	Ave.
1.520	34.50	10.10	46.00	11.50	Ave.
8.115	37.38	10.10	50.00	12.62	Ave.
2.405	39.48	10.10	56.00	16.52	QP
4.710	29.40	10.10	46.00	16.60	Ave.
4.705	35.24	10.10	56.00	20.76	QP
8.115	38.19	10.10	60.00	21.81	QP
15.230	21.99	10.10	50.00	28.01	Ave.
15.195	27.83	10.10	60.00	32.17	QP

AC 120 V/60 Hz, Neutral:

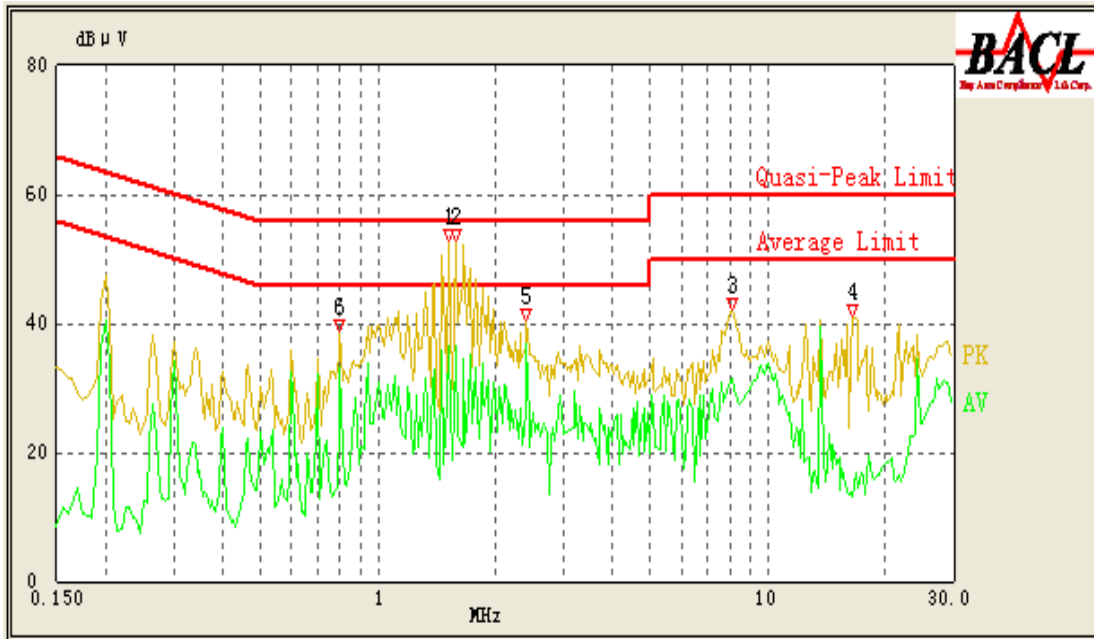

Frequency (MHz)	Corrected Result (dBμV)	Correction Factor (dB)	Limit (dBμV)	Margin (dB)	Remark (PK/QP/Ave.)
1.520	48.82	10.10	56.00	7.18	QP
1.585	46.97	10.10	56.00	9.03	QP
2.405	36.92	10.10	46.00	9.08	Ave.
1.520	36.59	10.10	46.00	9.41	Ave.
1.585	34.67	10.10	46.00	11.33	Ave.
0.800	33.21	10.10	46.00	12.79	Ave.
2.405	38.22	10.10	56.00	17.78	QP
8.070	31.57	10.10	50.00	18.43	Ave.
0.800	36.20	10.10	56.00	19.80	QP
8.075	37.87	10.10	60.00	22.13	QP
16.555	23.91	10.10	60.00	36.09	QP
16.555	13.20	10.10	50.00	36.80	Ave.

FCC §15.225, §15.205 & §15.209 - RADIATED EMISSIONS TEST

Measurement Uncertainty

All measurements involve certain levels of uncertainties, especially in field of EMC. The factors contributing to uncertainties are spectrum analyzer, cable loss, antenna factor calibration, antenna directivity, antenna factor variation with height, antenna phase center variation, antenna factor frequency interpolation, measurement distance variation, site imperfections, mismatch (average), and system repeatability.

Based on NIS 81, The Treatment of Uncertainty in EMC Measurements, the best estimate of the uncertainty of a radiation emissions measurement at Bay Area Compliance Lab Corp. (Shenzhen) is ± 4.0 dB ($k=2$, 95% level of confidence).

The fundamental data was recorded in average detection mode: set the VBW AVE on, and then record the data.

EUT Setup

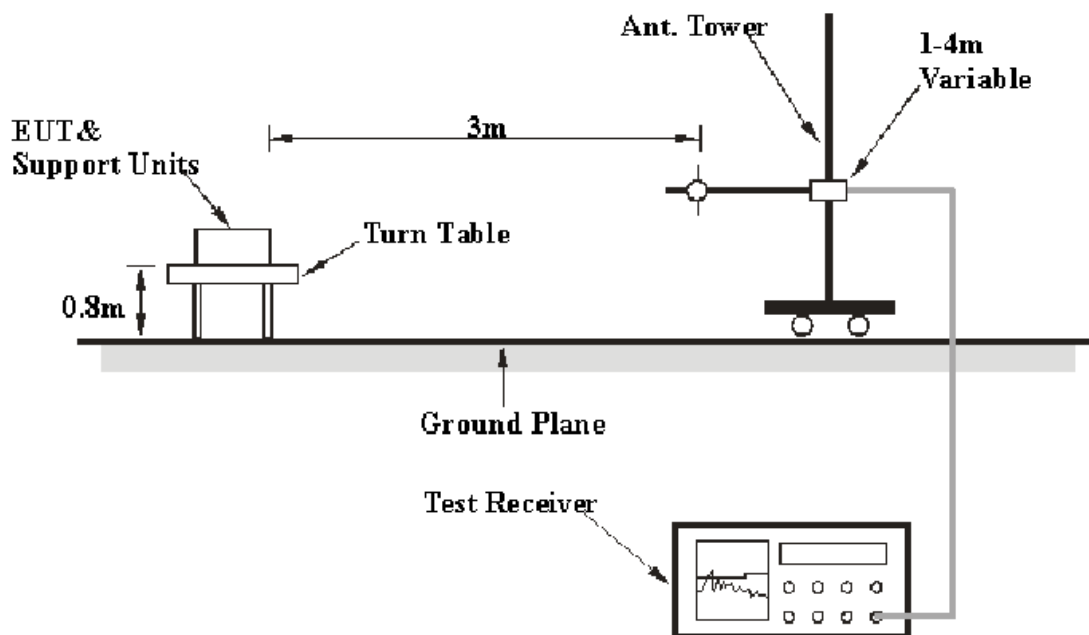

The radiated emission tests were performed in the 3-meter chamber a test site, using the setup accordance with the ANSI C63.4-2009. The specification used was the FCC Part Subpart C limits.

The spacing between the peripherals was 10 cm.

The host PC was connected to a 120 VAC/60 Hz power source.

EMI Test Receiver Setup

According to FCC Rules, 47 CFR 15.33, the EUT emissions were investigated up to 1000 MHz.

During the radiated emission test, the EMI test Receiver was set with the following configurations:

<i>Frequency Range</i>	<i>RBW</i>	<i>Video B/W</i>
9 kHz – 150 kHz	300 Hz	1 kHz
150 kHz – 30 MHz	10 kHz	30 kHz
30 – 1000 MHz	100 kHz	300 kHz

Corrected Amplitude & Margin Calculation

The Corrected Amplitude is calculated by adding the Antenna Loss and Cable Loss, and subtracting the Amplifier Gain from the Amplitude reading. The basic equation is as follows:

$$\text{Corr. Ampl.} = \text{Meter Reading} + \text{Antenna Loss} + \text{Cable Loss} - \text{Amplifier Gain}$$

The “**Margin**” column of the following data tables indicates the degree of compliance with the applicable limit. For example, a margin of 7dB means the emission is 7dB below the maximum limit. The equation for margin calculation is as follows:

$$\text{Margin} = \text{Limit} - \text{Corr. Ampl.}$$

Test Equipment List and Details

Manufacturer	Description	Model	Serial Number	Calibration Date	Calibration Due Date
Rohde & Schwarz	EMI Test Receiver	ESCI	100035	2010-11-11	2011-11-10
HP	Amplifier	8447E	1937A01046	2010-08-02	2011-08-01
Sunol Sciences	Broadband Antenna	JB1	A040904-1	2011-07-05	2012-07-04
ETS	Passive Loop Antenna	6512	00029604	2011-04-27	2012-04-26

* **Statement of Traceability:** Bay Area Compliance Lab Corp. (Shenzhen) attests that all calibrations have been performed per the NVLAP requirements, traceable to NIST.

Test Results Summary

According to the data in the following table, the EUT complied with the FCC Part 15.209 with the worst margin reading of:

1.8 dB at 149.154250 MHz in the Horizontal polarization

Test Data**Environmental Conditions**

Temperature:	25 °C
Relative Humidity:	56 %
ATM Pressure:	100.9 kPa

The testing was performed by Back Huang on 2011-07-21.

Test mode: Transmitting

1) Below 30 MHz:

Indicated		Table Angle Degree	Antenna Height (m)	Detector PK/QP/AV	Correction Factor			Corrected Amplitude (dB μ V/m) @3m	FCC Part 15.225	
Frequency (MHz)	Maximum Reading (dB μ V) @3m				Ant. Factor (dB)	Cable Loss (dB)	Pre-Amp. Gain (dB)		Limit (dB μ V/m) @3m	Result
14.40534	25.16	187	1.6	PK	31.8	0.11	0.0	57.07	69.54	Pass
27.12000	29.54	184	1.6	PK	30.4	0.27	0.0	60.21	69.54	Pass
0.009564	-23.33	162	1.4	PK	87.1	0.05	0.0	63.82	107.99	Pass

2) 30 MHz – 1 GHz:

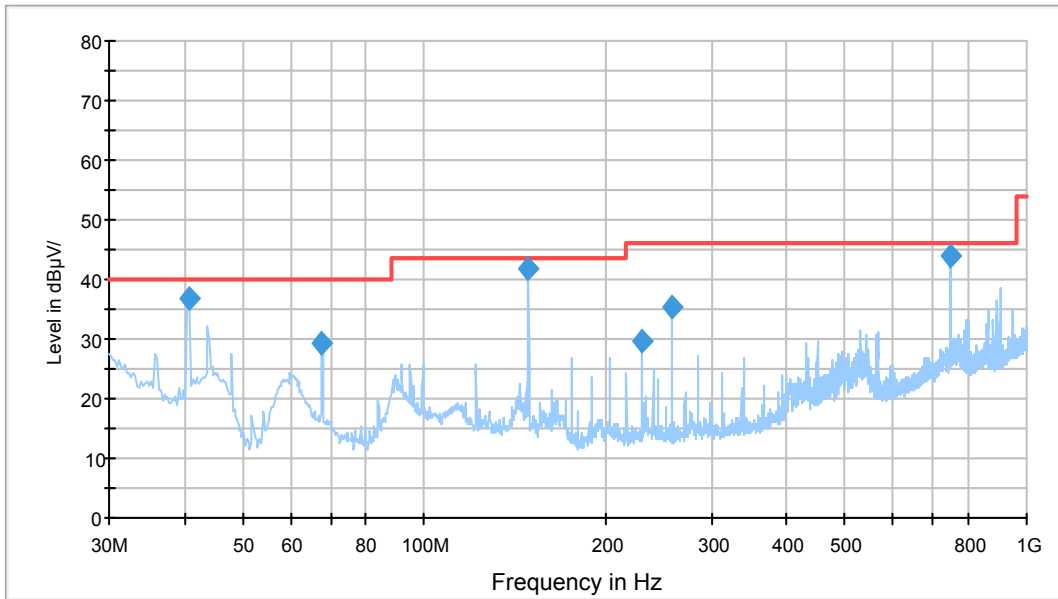

Frequency (MHz)	Corrected Amplitude (dBµV/m)	Antenna Height (cm)	Antenna Polarity (H/V)	Turntable Position (deg)	Correction Factor (dB)	Limit (dBµV/m)	Margin (dB)
149.154250	41.7	169.0	H	321.0	-13.9	43.5	1.8*
749.371500	44.1	187.0	V	52.0	-2.4	46.0	1.9*
40.675250	36.7	225.0	H	68.0	-9.7	40.0	3.3*
67.587500	29.3	135.0	H	237.0	-10.0	40.0	10.7
257.707520	35.3	154.0	V	87.0	-12.6	46.0	10.7
230.547530	29.7	276.0	H	129.0	-12.5	46.0	16.3

*Within measurement uncertainty!

FCC §15.225(a) (b) (c) – FIELD STRENGTH OF RADIATED EMISSIONS

Applicable Standard

As per FCC Part 15.225

(a) The field strength of any emissions within the band 13.553-13.567 MHz shall not exceed 15,848 microvolts/meter at 30 meters.

(b) Within the bands 13.410-13.553 MHz and 13.567-13.710 MHz, the field strength of any emissions shall not exceed 334 microvolts/meter at 30 meters.

(c) Within the bands 13.110-13.410 MHz and 13.710-14.010 MHz the field strength of any emissions shall not exceed 106 microvolts/meter at 30 meters.

EUT Setup

The field strength of radiated emissions tests were performed in the 3-meter chamber test site, using the setup accordance with the ANSI C63.4-2009. The specification used was the FCC Part Subpart C limits.

Test Equipment List and Details

Manufacturer	Description	Model	Serial Number	Calibration Date	Calibration Due Date
HP	Amplifier	8447E	1937A01046	2010-08-02	2011-08-01
Rohde & Schwarz	EMI Test Receiver	ESCI	100035	2010-11-11	2011-11-10
ETS	Passive Loop Antenna	6512	00029604	2011-04-27	2012-04-26

* **Statement of Traceability:** Bay Area Compliance Lab Corp. (Shenzhen) attests that all calibrations have been performed per the NVLAP requirements, traceable to NIST.

Test Data

Environmental Conditions

Temperature:	25 °C
Relative Humidity:	56 %
ATM Pressure:	100.9 kPa

The testing was performed by Back Huang on 2011-07-21.

Test Mode: Transmitting

Test Result: Pass

Indicated			Table Angle Degree	Antenna Height (m)	Detector PK/QP/Ave	Correction Factor			Corrected Amplitude (dBµV/m) @3m	FCC Part 15.225	
Frequency Range (MHz)	Mark point (MHz)	Maximum Reading (dBµV) @3m				Ant. Factor (dB)	Cable Loss (dB)	Pre-Amp. Gain (dB)		Limit (dBµV/m) @3m	Result
13.110-13.410	13.2800	-0.1	181	1.2	QP	32.1	0.20	0.0	32.2	80.5	Pass
13.410-13.553	13.4815	12.1	173	1.4	QP	32.1	0.20	0.0	44.4	90.5	Pass
13.553-13.567	13.5600	34.0	182	1.3	QP	32.1	0.20	0.0	66.3	124	Pass
13.567-13.710	13.5670	21.5	176	1.3	QP	32.1	0.20	0.0	53.8	90.5	Pass
13.710-14.010	13.7170	-0.2	173	1.5	QP	32.1	0.20	0.0	32.1	80.5	Pass

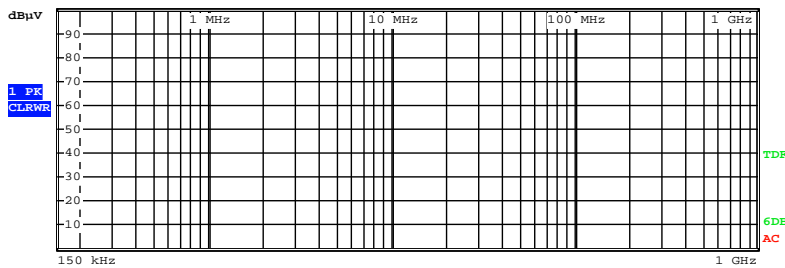
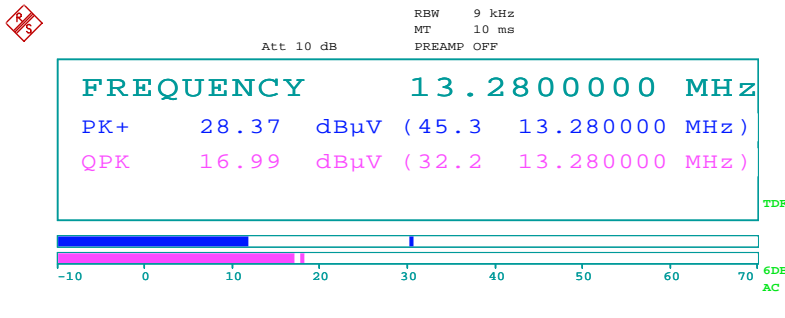

Date: 21.JUL.2011 10:50:54



Att 10 dB RBW 9 kHz
MT 10 ms
PREAMP OFF

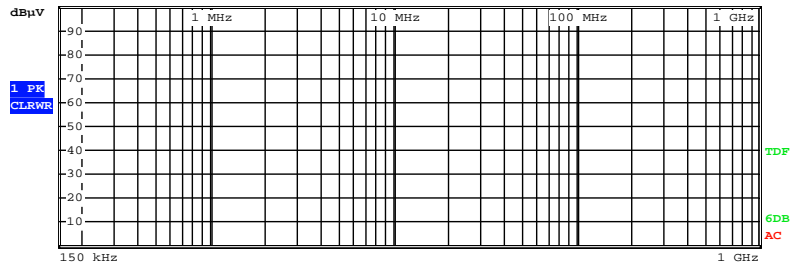
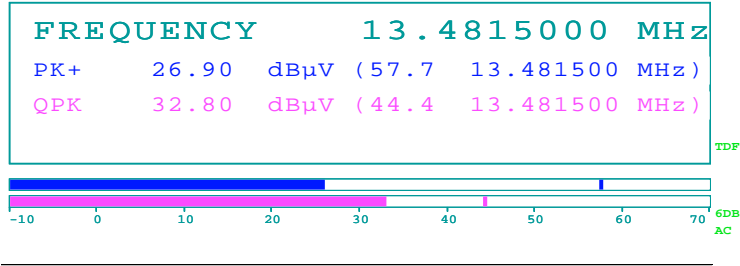

Date: 21.JUL.2011 10:54:59



Att 10 dB RBW 9 kHz
MT 10 ms
PREAMP OFF

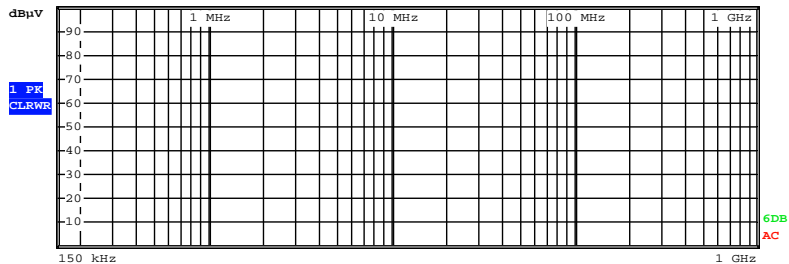
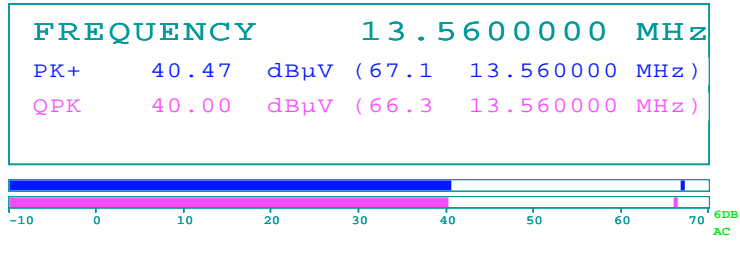

Date: 21.JUL.2011 16:15:19



Att 10 dB RBW 9 kHz
MT 10 ms
PREAMP OFF

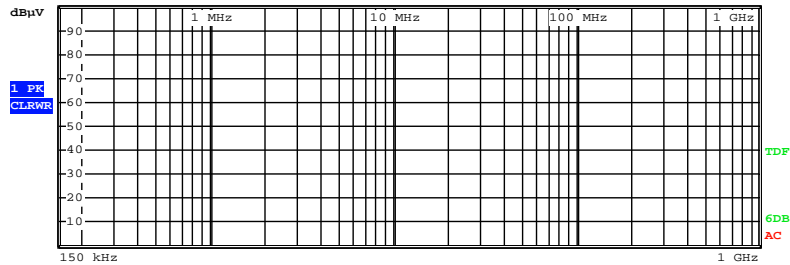
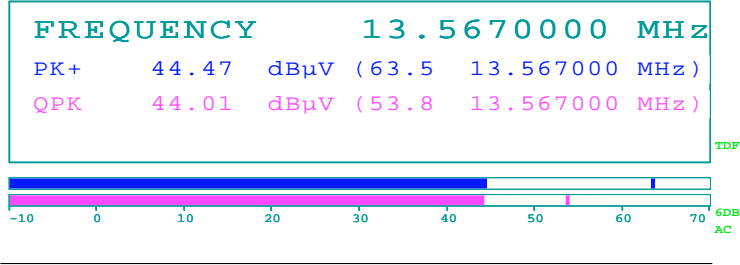

Date: 21.JUL.2011 11:05:33



Att 10 dB RBW 9 kHz
MT 10 ms
PREAMP OFF

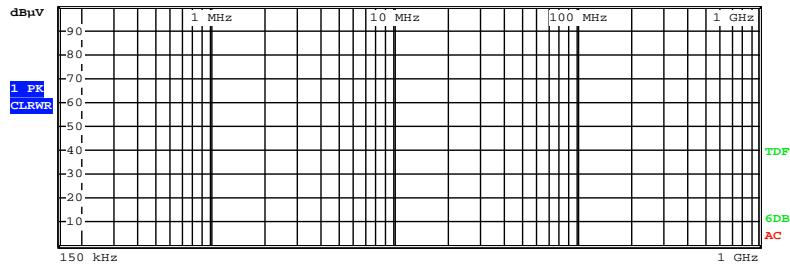
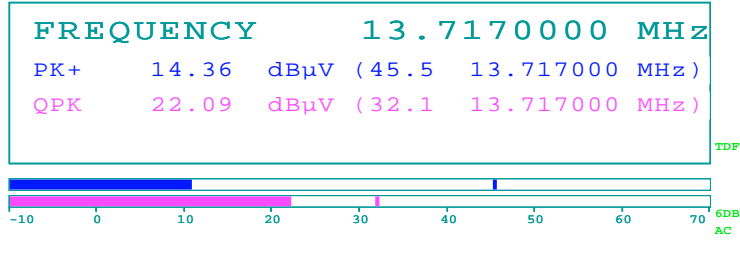

Date: 21.JUL.2011 11:07:13

FCC §15.225(e) - FREQUENCY STABILITY

Applicable Standard

The frequency tolerance of the carrier signal shall be maintained within $\pm 0.01\%$ of the operating frequency over a temperature variation of -20 degrees to $+50$ degrees C at normal supply voltage, and for a variation in the primary supply voltage from 85% to 115% of the rated supply voltage at a temperature of 20 degrees C. For battery operated equipment, the equipment tests shall be performed using a new battery.

Test Procedure

Frequency Stability vs. Temperature: The equipment under test was connected to PC, than to an external AC power supply and loop antenna was connected to a f Spectrum Analyzer. The EUT was placed inside the temperature chamber.

After the temperature stabilized for approximately 20 minutes, the frequency output was recorded from the Spectrum Analyzer.

Frequency Stability vs. Voltage: An external variable AC power supply Source. The voltage was set to 115% of the nominal value and was then decreased until the transmitter light no longer illuminated; i.e., the end point. The output frequency was recorded for each voltage.

Test Equipment List and Details

Manufacturer	Description	Model	Serial Number	Calibration Date	Calibration Due Date
Rohde & Schwarz	EMI Test Receiver	ESCI	100035	2010-11-11	2011-11-10
WUHUAN	Temperature & Humidity Chamber	HTP205	20021115	2011-06-04	2012-06-03

* **Statement of Traceability:** Bay Area Compliance Lab Corp. (Shenzhen) attests that all calibrations have been performed in accordance to NVLAP requirements, traceable to the NIST.

Test Data

Environmental Conditions

Temperature:	25 °C
Relative Humidity:	56 %
ATM Pressure:	100.9 kPa

The testing was performed by Back Huang on 2011-07-22.

Test Result: Pass

Test Mode: Transmitting

Power Supply	Temperature (°C)	Measured Frequency (MHz)	Frequency Error	Part 15.225 Limit
AC 120V	0	13.56065	0.00479351%	±0.01%
	10	13.56088	0.00648968%	±0.01%
	20	13.56082	0.00604720%	±0.01%
	30	13.56055	0.00405605%	±0.01%
	40	13.56059	0.00435103%	±0.01%
	50	13.56072	0.00530973%	±0.01%
Max. = AC 138V	20	13.56128	0.00656342%	±0.01%
Min. = AC 102V	20	13.56103	0.00759587%	±0.01%

FCC §15.215(c) – 20 dB BANDWIDTH TESTING

Applicable Standard

Per FCC Part 15.215(c) Intentional radiators operating under the alternative provisions to the general emission limits, as contained in §§ 15.217 through 15.257 and in Subpart E of this part, must be designed to ensure that the 20 dB bandwidth of the emission, or whatever bandwidth may otherwise be specified in the specific rule section under which the equipment operates, is contained within the frequency band designated in the rule section under which the equipment is operated. The requirement to contain the designated bandwidth of the emission within the specified frequency band includes the effects from frequency sweeping, frequency hopping and other modulation techniques that may be employed as well as the frequency stability of the transmitter over expected variations in temperature and supply voltage. If a frequency stability is not specified in the regulations, it is recommended that the fundamental emission be kept within at least the central 80% of the permitted band in order to minimize the possibility of out-of-band operation.

Test Procedure

1. Check the calibration of the measuring instrument using either an internal calibrator or a known signal from an external generator.
2. Position the EUT without connection to measurement instrument. Turn on the EUT and connect it to measurement instrument. Then set it to any one convenient frequency within its operating range. Set a reference level on the measuring instrument equal to the highest peak value.
3. Measure the frequency difference of two frequencies that were attenuated 20 dB from the reference level. Record the frequency difference as the emission bandwidth.

Test Equipment List and Details

Manufacturer	Description	Model	Serial Number	Calibration Date	Calibration Due Date
Rohde & Schwarz	EMI Test Receiver	ESCI	100035	2010-11-11	2011-11-10
HP	Amplifier	8447E	1937A01046	2010-08-02	2011-08-01
ETS	Passive Loop Antenna	6512	00029604	2011-04-27	2012-04-26

* **Statement of Traceability:** Bay Area Compliance Laboratories Corp. (Shenzhen) attests that all calibrations have been performed per the NVLAP requirements, traceable to NIST.

Test Data

Environmental Conditions

Temperature:	25 °C
Relative Humidity:	56 %
ATM Pressure:	100.9 kPa

The testing was performed by Back Huang on 2011-07-21.

Test Mode: Transmitting

20 dB Emission Bandwidth

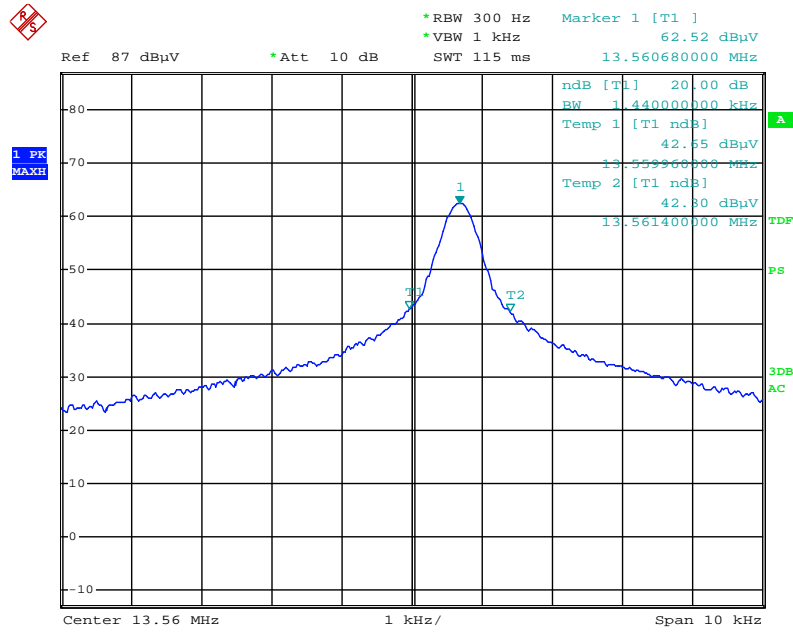

Date: 21.JUL.2011 09:31:23

***** END OF REPORT *****