

Test report

284168-9TRFWL

Date of issue: December 1, 2018

Applicant:

Deltanode Solutions AB

Product:

AWS

Model:

DMR420

FCC ID: V5FDMR002

IC: 11014A-DMR002

Specifications:

FCC Part 27, RSS-131 Issue 3, RSS-139 Issue 3

Lab and test locations

Company name	Nemko Canada Inc.			
Facilities	Ottawa site:	Montréal site:	Toronto site:	Almonte site:
	303 River Road Ottawa, Ontario Canada K1V 1H2 Tel: +1 613 737 9680 Fax: +1 613 737 9691	292 Labrosse Avenue Pointe-Claire, Québec Canada H9R 5L8 Tel: +1 514 694 2684 Fax: +1 514 694 3528	1-130 Saltsman Drive Cambridge, Ontario Canada N3E 0B2 Tel: +1 519 650 4811	1500 Peter Robinson Road West Carleton, Ontario Canada K0A 1L0 Tel: +1 613 256-9117 Fax: +1 613 256-8848
Test site registration	Organization	Recognition numbers and location		
	FCC ISED	CA2040 (Ottawa); Test Firm Registration Number: 175281 CA2040A-4 (Ottawa)		
Website	www.nemko.com			

Tested by	Kevin Rose, Wireless/EMC Specialist
Reviewed by	Russell Grant, Senior Technical Assessor
Date	December 1, 2018
Signature	

Limits of responsibility

Note that the results contained in this report relate only to the items tested and were obtained in the period between the date of initial receipt of samples and the date of issue of the report.

This test report has been completed in accordance with the requirements of ISO/IEC 17025. All results contained in this report are within Nemko Canada's ISO/IEC 17025 accreditation.

Copyright notification

Nemko Canada Inc. authorizes the applicant to reproduce this report provided it is reproduced in its entirety and for use by the company's employees only. Any use which a third party makes of this report, or any reliance on or decisions to be made based on it, are the responsibility of such third parties.

Nemko Canada Inc. accepts no responsibility for damages, if any, suffered by any third party as a result of decisions made or actions based on this report.

© Nemko Canada Inc.

Table of contents

Table of contents	3
Section 1. Report summary	4
1.1 Applicant and manufacturer	4
1.2 Test specifications	4
1.3 Statement of compliance	4
1.4 Exclusions	4
1.5 Test report revision history	4
Section 2. Summary of test results	5
2.1 FCC Part 27, RSS-131 Issue 3, RSS-139 Issue 3 test results	5
Section 3. Equipment under test (EUT) details	6
3.1 Sample information	6
3.2 EUT information	6
3.3 Technical information	6
3.4 Product description and theory of operation	6
3.5 EUT exercise details	6
3.6 EUT setup diagram	7
Section 4. Engineering considerations	8
4.1 Modifications incorporated in the EUT	8
4.2 Technical judgment	8
4.3 Deviations from laboratory tests procedures	8
Section 5. Test conditions	9
5.1 Atmospheric conditions	9
5.2 Power supply range	9
Section 6. Measurement uncertainty	10
6.1 Uncertainty of measurement	10
Section 7. Test equipment	11
7.1 Test equipment list	11
Section 8. Testing data	12
8.1 KDB 935210 D05 3.2, Measuring AGC threshold level	12
8.2 RSS-131 5.2.1, KDB 935210 D05 3.3, Out-of-band-rejection	13
8.3 RSS-131 5.2.2, KDB 935210 D05 3.4, Input-versus-output signal comparison	16
8.4 FCC 27.50(d), RSS-131 5.2.3, RSS-139 6.5, KDB 935210 D05 3.5, Mean output power and amplifier/booster gain	19
8.5 FCC 27.53(h), RSS-139 6.6, KDB 935210 D05 3.6.2, Out-of-band/out-of-block emissions conducted measurements	22
8.6 FCC 27.53(h), RSS-139 6.6, KDB 935210 D05 3.6.3, Spurious emissions conducted measurements	27
8.7 FCC 27.53(h), RSS-139 6.6, KDB 935210 D05 3.8, Spurious emissions radiated measurements	30
Section 9. Setup Photos	32
9.1 Set-up	32
Section 10. Block diagrams of test set-ups	33
10.1 Measuring AGC threshold level, Out-of-band-rejection, Input-versus-output signal comparison, Mean output power and amplifier/booster gain, Spurious emissions conducted measurements, Spurious emissions radiated measurements	33
10.2 Out-of-band/out-of-block emissions conducted measurements	33
10.3 Spurious emissions radiated measurements	34
10.4 Spurious emissions radiated measurements (above 1GHz)	35

Section 1. Report summary

1.1 Applicant and manufacturer

Company name	Deltanode Solutions AB
Address	Hammarby Fabriksvag 61
City	Stockholm
Province/State	
Postal/Zip code	SE-120 30
Country	Sweden

1.2 Test specifications

FCC Part 27	MISCELLANEOUS WIRELESS COMMUNICATIONS SERVICES
935210 D05 Indus Booster Basic Meas v01r02	MEASUREMENTS GUIDANCE FOR INDUSTRIAL AND NON-CONSUMER SIGNAL BOOSTER, REPEATER, AND AMPLIFIER DEVICES
RSS-131 Issue 3	Zone Enhancers
RSS-139 Issue 3	Advanced Wireless Services (AWS) Equipment Operating in the Bands 1710-1780 MHz and 2110-2180 MHz

1.3 Statement of compliance

In the configuration tested, the EUT was found compliant.

Testing was completed against all relevant requirements of the test standard. Results obtained indicate that the product under test complies in full with the requirements tested. The test results relate only to the items tested.

See "Summary of test results" for full details.

1.4 Exclusions

None

1.5 Test report revision history

Revision #	Details of changes made to test report
TRF	Original report issued

Section 2. Summary of test results

2.1 FCC Part 27, RSS-131 Issue 3, RSS-139 Issue 3 test results

KDB 935210 D05 3.2	Measuring AGC threshold level	Reported
RSS-131 5.2.1, KDB 935210 D05 3.3	Out-of-band-rejection	Pass
RSS-131 5.2.2, KDB 935210 D05 3.4	Input-versus-output signal comparison	Pass
FCC 27.50(d), RSS-131 5.2.3, RSS-139 6.5, KDB 935210 D05 3.5	Mean output power and amplifier/booster gain	Pass
FCC 27.53(h), RSS-139 6.6, KDB 935210 D05 3.6.2,	Out-of-band/out-of-block emissions conducted measurements	Pass
FCC 27.53(h), RSS-139 6.6, KDB 935210 D05 3.6.3	Spurious emissions conducted measurements	Pass
FCC 27.54, RSS-131 5.2.4, RSS-139 6.4, KDB 935210 D05 3.7	Frequency stability measurements	N/A ¹
FCC 27.53(h), RSS-139 6.6, KDB 935210 D05 3.8	Spurious emissions radiated measurements	Pass

Notes: ¹The signal booster does not alter the input signal in any way.

Section 3. Equipment under test (EUT) details

3.1 Sample information

Receipt date	November 8, 2018
Nemko sample ID number	NEX 284168-1

3.2 EUT information

Product name	AWS
Model	DMR420
Serial number	10666

3.3 Technical information

Operating band	1710 – 1755 / 2110 – 2155 MHz
Modulation type	CDMA, WCDMA, LTE
Channel Spacing	Standard
Power requirements	110 V _{AC} , ~3 A for entire system tested
Emission designator	1M25F9W, 5M00F9W, 1M40D7W, 3M00D7W, 5M00D7W, 10M0D7W, 15M0D7W, 20M0D7W
Gain	80 dB
Antenna information	External Antenna is not provided EUT used a 50 Ω termination.

3.4 Product description and theory of operation

Off air high power repeater 25 dBm of output power on DL, 25 dBm of output power on UL, 80dB gain in both DL and UL

3.5 EUT exercise details

The EUT was controlled via a Laptop interface with GUI to configure the system. The EUT uses set channels Bandwidths user settable to a maximum of 15 MHz.

3.6 EUT setup diagram

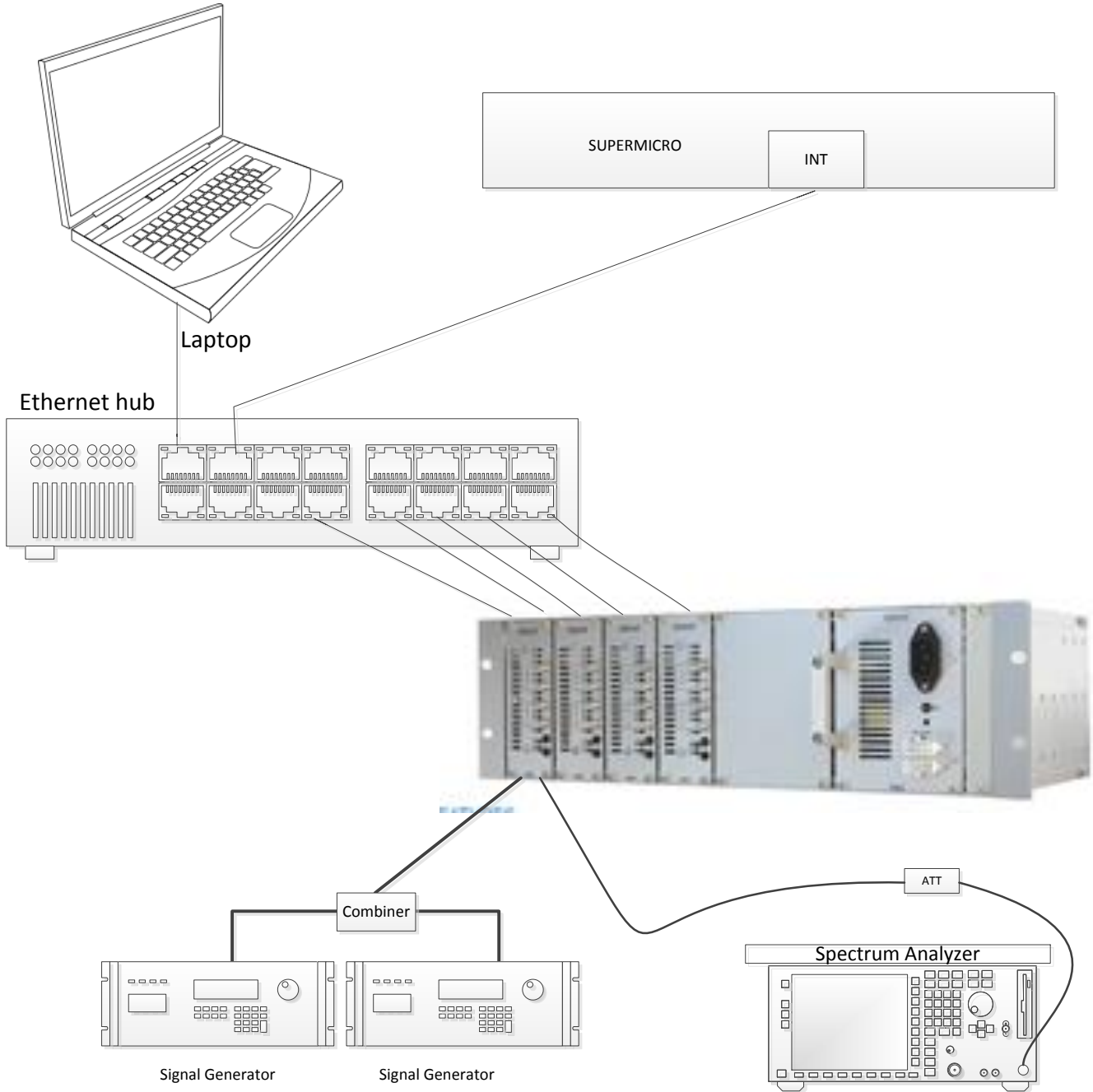

Figure 3.6-1: Setup diagram

Section 4. Engineering considerations

4.1 Modifications incorporated in the EUT

There were no modifications performed to the EUT during this assessment.

4.2 Technical judgment

None

4.3 Deviations from laboratory tests procedures

No deviations were made from laboratory procedures.

Section 5. Test conditions

5.1 Atmospheric conditions

Temperature	15–30 °C
Relative humidity	20–75 %
Air pressure	860–1060 mbar

When it is impracticable to carry out tests under these conditions, a note to this effect stating the ambient temperature and relative humidity during the tests shall be recorded and stated.

5.2 Power supply range

The normal test voltage for equipment to be connected to the mains shall be the nominal mains voltage. For the purpose of the present document, the nominal voltage shall be the declared voltage, or any of the declared voltages $\pm 5\%$, for which the equipment was designed.

Section 6. Measurement uncertainty

6.1 Uncertainty of measurement

Measurement uncertainty budgets for the tests are detailed below. Measurement uncertainty calculations assume a coverage factor of $K = 2$ with 95% certainty.

Test name	Measurement uncertainty, dB
All antenna port measurements	0.55
Conducted spurious emissions	1.13
Radiated spurious emissions	3.78

Section 7. Test equipment

7.1 Test equipment list

Table 7.1-1: Equipment list

Equipment	Manufacturer	Model no.	Serial no.	Asset no.	Cal./Ver. cycle	Next cal./ver.
3 m EMI test chamber	TDK	SAC-3		FA003012	1 year	Aug. 22/19
Flush mount turntable	SUNAR	FM2022		FA003006	—	NCR
Controller	SUNAR	SC110V	050118-1	FA002976	—	NCR
Antenna mast	SUNAR	TLT2	042418-5	FA003007	—	NCR
AC Power source	Chroma			FA003020	—	NCR
Receiver/spectrum analyzer	Rohde & Schwarz	ESR26	101367	FA002969	1 year	Jan. 30/19
Spectrum analyzer	Rohde & Schwarz	FSW43	104437	FA002971	1 year	Mar. 16/19
Horn antenna (1–18 GHz)	ETS-Lindgren	3117	00052793	FA002911	1 year	Aug. 16/19
Preamp (1–18 GHz)	ETS-Lindgren	124334	00224880	FA002956	1 year	Sept 18/19
Bilog antenna (30–2000 MHz)	SUNAR	JB1	A053018-1	FA003009	1 year	Sept. 6/19
Vector Signal Generator	Rohde & Schwarz	SMW200A	101857	FA002970	1 year	Feb. 2/19

Note: NCR - no calibration required, VOU - verify on use

Section 8. Testing data

8.1 KDB 935210 D05 3.2, Measuring AGC threshold level

8.1.1 Definitions and limits

The AGC threshold is the input power at which a 1 dB increase in the input signal power no longer causes a 1 dB increase in the output power.

8.1.2 Test summary

Test date	November 21, 2018	Temperature	23 °C
Test engineer	Kevin Rose	Air pressure	1003 mbar
Verdict	Pass	Relative humidity	39 %

8.1.3 Observations, settings and special notes

Test receiver settings:

Detector mode	RMS (for average), Peak (for peak)
Resolution bandwidth	20 kHz
Integration bandwidth	>OBW
Video bandwidth	>RBW
Trace mode	Power Average (for average), Max Hold (for peak)
Measurement time	Auto

Table 8.1 1: AGC Threshold

Modulation	Frequency, MHz	RF input power AVG, dBm
AWGN	1732.5	-62.59
AWGN	2132.5	-59.45

8.1.4 Test data

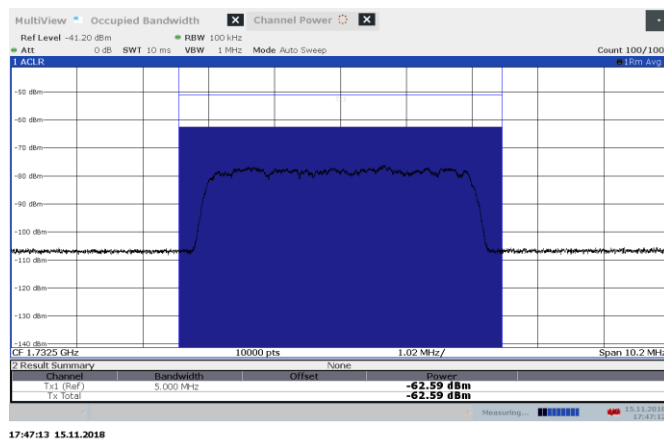

Figure 8.1-1: AWGN AGC +1 1732.5 MHz input power UL

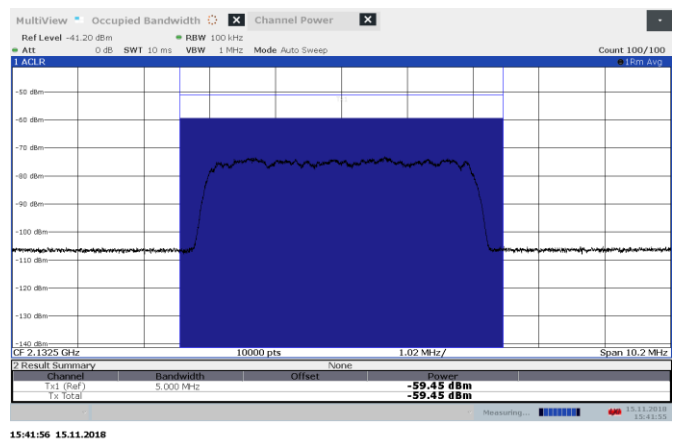

Figure 8.1-2: AWGN AGC +1 2132.5 MHz input power DL

8.2 RSS-131 5.2.1, KDB 935210 D05 3.3, Out-of-band-rejection

8.2.1 Definitions and limits

The gain-versus-frequency response and the 20 dB bandwidth of the zone enhancer shall be reported. The zone enhancer shall reject amplification of other signals outside the passband of the zone enhancer.

8.2.2 Test summary

Test date	November 7, 2018	Temperature	21 °C
Test engineer	Kevin Rose	Air pressure	1000 mbar
Verdict	Pass	Relative humidity	42 %

8.2.3 Observations, settings and special notes

Frequency range	30 MHz to 10 th harmonic
Detector mode	Peak
Resolution bandwidth sweep	100 kHz (below 1 GHz), 1000 kHz (above 1 GHz)
Video bandwidth	>RBW
Trace mode	Max Hold
Measurement time	Auto

8.2.4 Test data

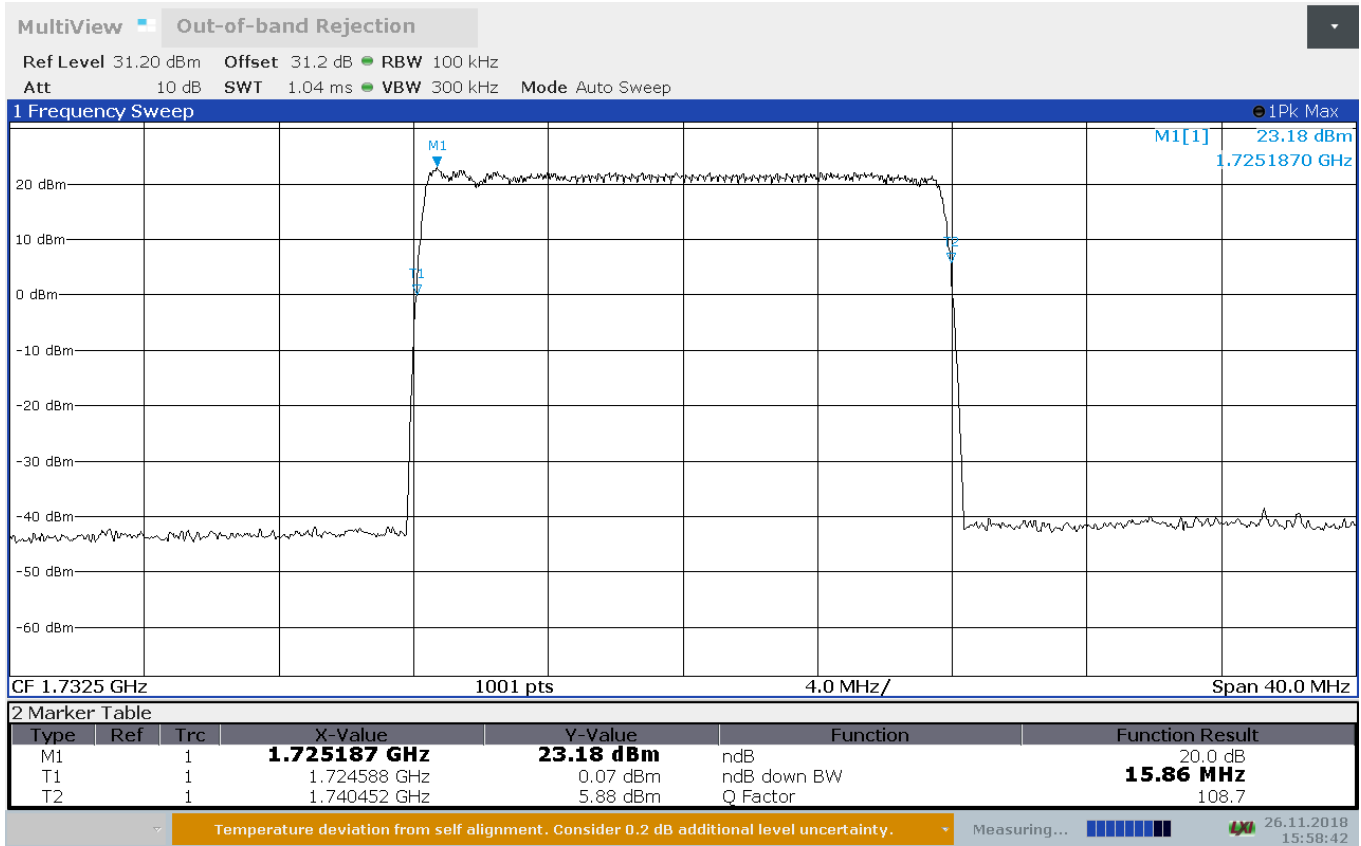

15:58:43 26.11.2018

Figure 8.2-1: Passband UL

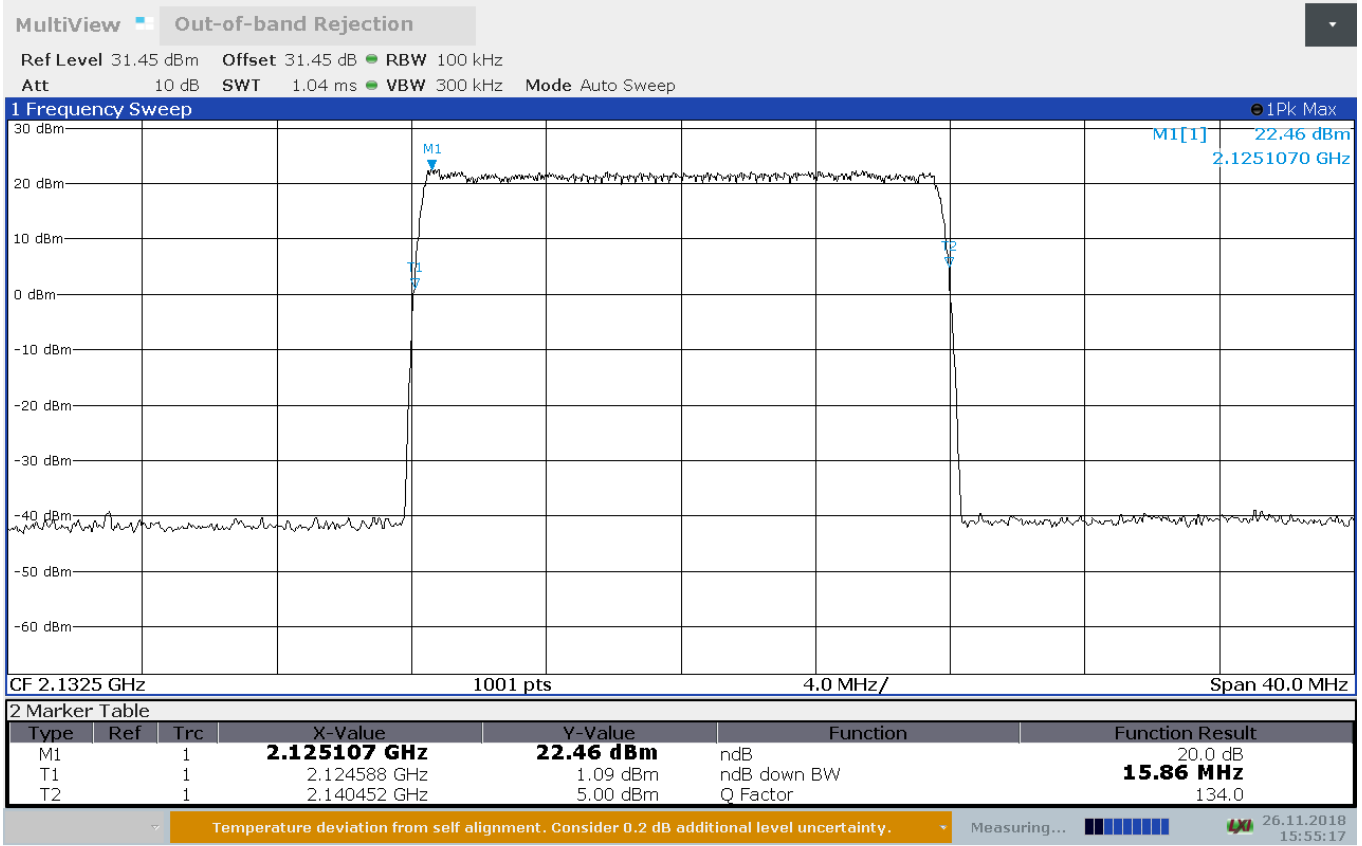

15:55:17 26.11.2018

Figure 8.2-2: Passband DL

* No Output Offset. S/B 41.3dB is odB

8.3 RSS-131 5.2.2, KDB 935210 D05 3.4, Input-versus-output signal comparison

8.3.1 Definitions and limits

The spectral growth of the 26 dB bandwidth of the output signal shall be less than 5% of the input signal spectrum.

A 26 dB bandwidth measurement shall be performed on the input signal and the output signal; alternatively, the 99% OBW can be measured and used. See KDB Publication 971168 [R8] for more information on measuring OBW

8.3.2 Test summary

Test date	October 29, 2018	Temperature	22 °C
Test engineer	Kevin Rose	Air pressure	1001 mbar
Verdict	Pass	Relative humidity	32 %

8.3.3 Observations, settings and special notes

Frequency range	250% of OBW
Detector mode	Peak
Resolution bandwidth	1 % to 5 % of the anticipated OBW
Video bandwidth	>RBW
Trace mode	Max Hold

8.3.4 Test data

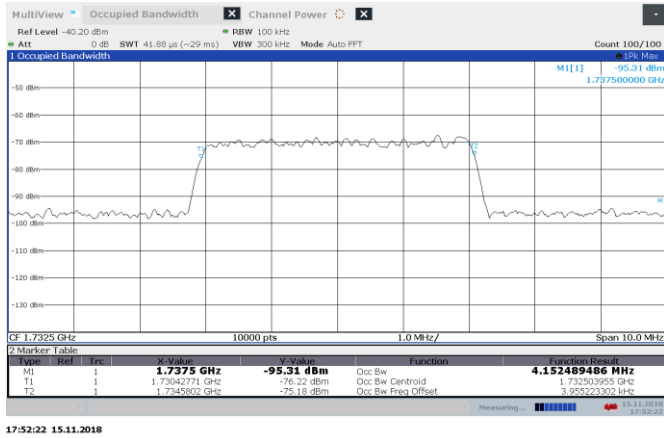

Figure 8.3-1: AWGN AGC -0.5 dB 1732.5 MHz input 99% BW UL

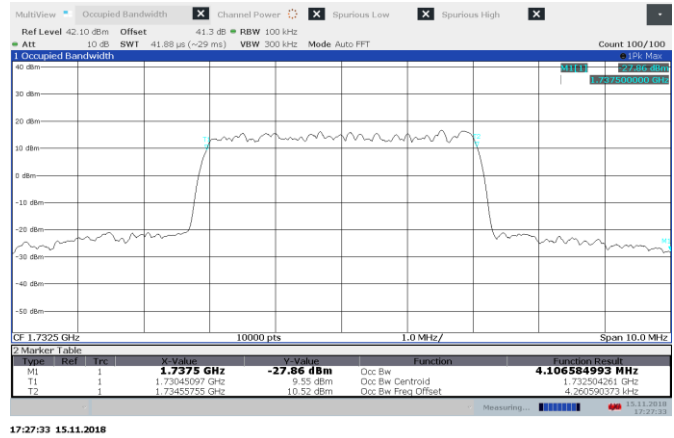

Figure 8.3-2: AWGN AGC -0.5 dB 1732.5 MHz output 99% BW UL

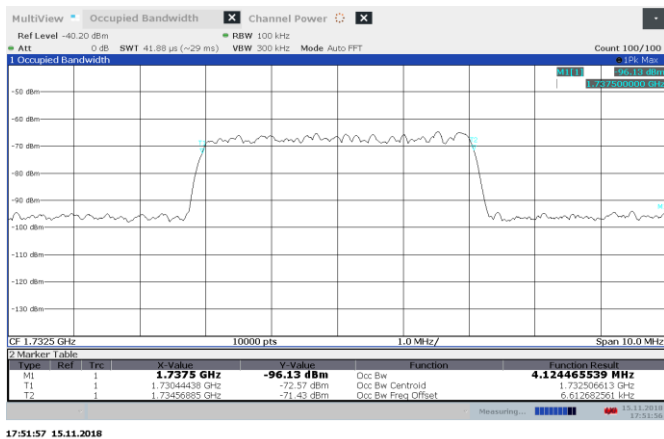

Figure 8.3-3: AWGN AGC +3 dB 1732.5 MHz input 99% BW UL

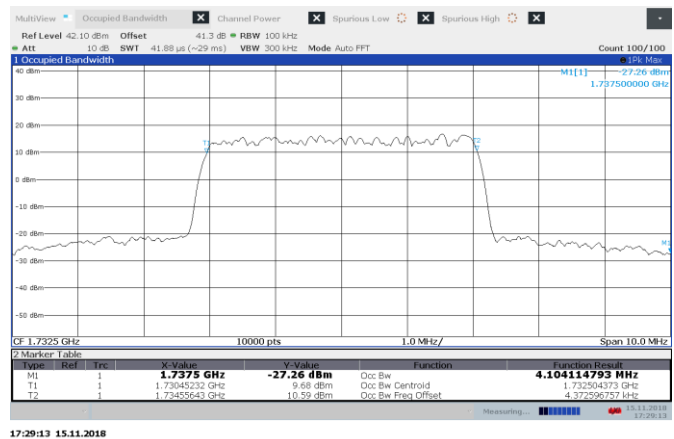

Figure 8.3-4: AWGN AGC +3 dB 1732.5 MHz output 99% BW UL

Section 8
Test name
Specification

Testing data
 Input-versus-output signal comparison
 RSS-131 5.2.2, KDB 935210 D05 3.4

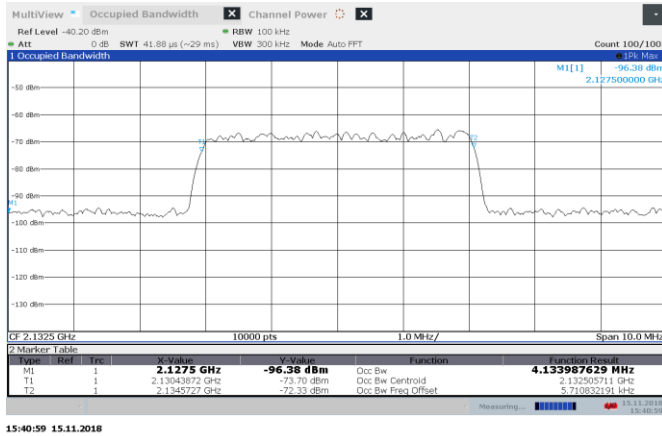

Figure 8.3-5: AWGN AGC -0.5 dB 2132.5 MHz input 99% BW DL

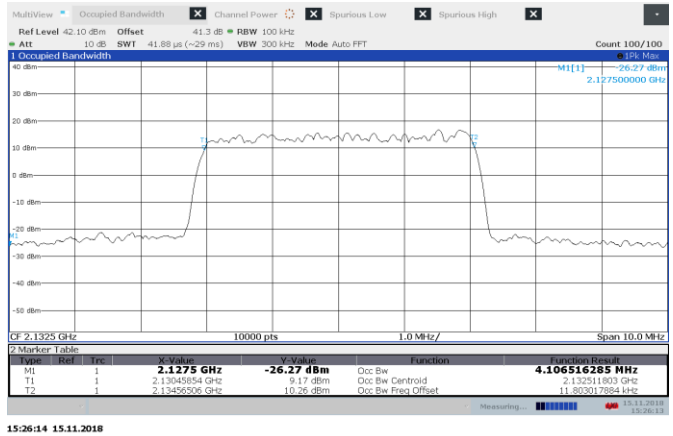

Figure 8.3-6: AWGN AGC -0.5 dB 2132.5 MHz output 99% BW DL

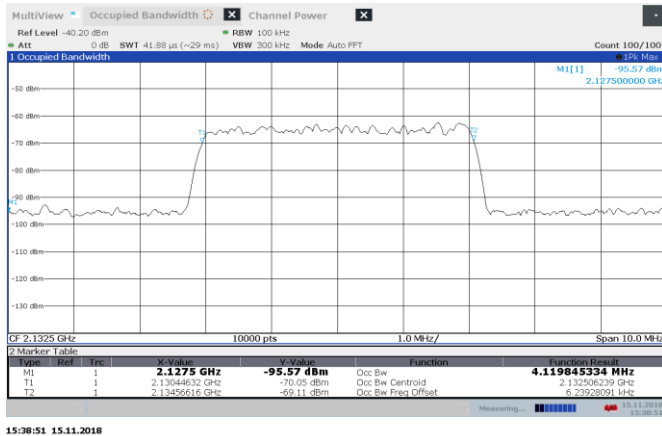

Figure 8.3-7: AWGN AGC +3dB 2132.5 MHz input 99% BW DL

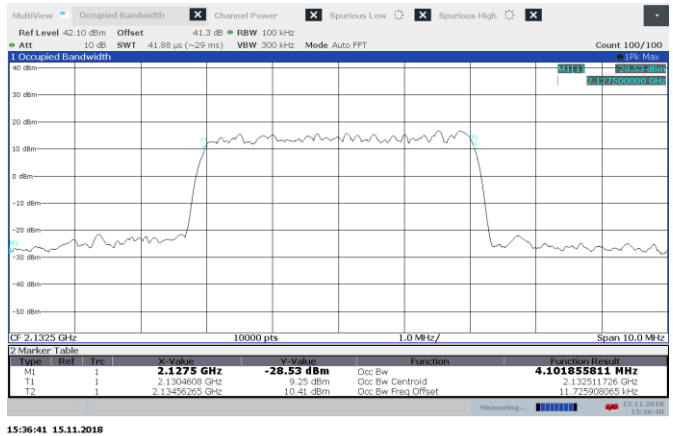

Figure 8.3-8: AWGN AGC +3 dB 2132.5 MHz output 99% BW DL

8.4 FCC 27.50(d), RSS-131 5.2.3, RSS-139 6.5, KDB 935210 D05 3.5, Mean output power and amplifier/booster gain

8.4.1 Definitions and limits

FCC 27.50(d)

- (1) 2110 – 2155 MHz, Low Density, 3280 W EIRP or 3280 W/MHz with an emission bandwidth > 1 MHz
- (2) 2110 – 2155 MHz, High Density, 1640 W EIRP or 1640 W/MHz with an emission bandwidth > 1 MHz
- (4) 1710 – 1755 MHz, 1 W EIRP
- (5) The peak-to-average ratio (PAR) of the transmission may not exceed 13 dB

RSS-131 5.2.3 The zone enhancer gain shall not exceed the nominal gain by more than 1.0 dB. Outside of the 20 dB bandwidth, the gain shall not exceed the gain at the 20 dB point

RSS-139 6.5 refer to SRSP-513. In addition, the peak to average power ratio (PAPR) of the equipment shall not exceed 13 dB for more than 0.1% of the time, using a signal that corresponds to the highest PAPR during periods of continuous transmission.

8.4.2 Test summary

Test date	November 8, 2018	Temperature	23 °C
Test engineer	Kevin Rose	Air pressure	1001 mbar
Verdict	Pass	Relative humidity	39 %

8.4.3 Observations, settings and special notes

Detector mode	RMS (for average), Peak (for peak)
Resolution bandwidth	100 kHz
Integration bandwidth	>OBW
Video bandwidth	>RBW
Trace mode	Power Average (for average), Max Hold (for peak)
Measurement time	Auto

Table 8.4-1: Output power results

Frequency, MHz	RF output power Peak, dBm
1732.5	24.12
Gain = 87.73 dB	PAR = 6.80 dB
2132.5	24.03
Gain = 84.43 dB	PAR = 8.36 dB

8.4.1 Test data

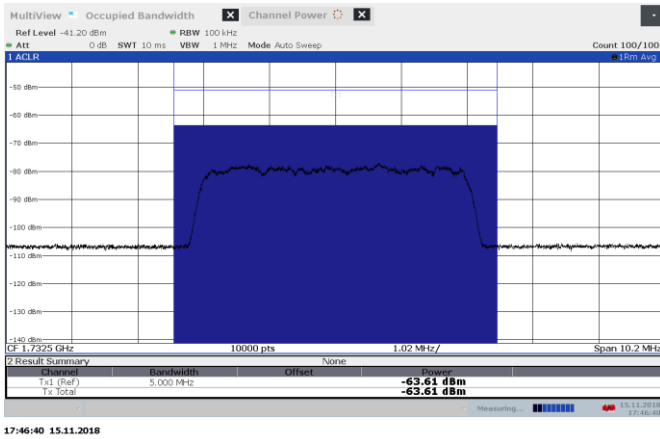

Figure 8.4-1: AWGN AGC—0.5 dB 1732.5 MHz input UL

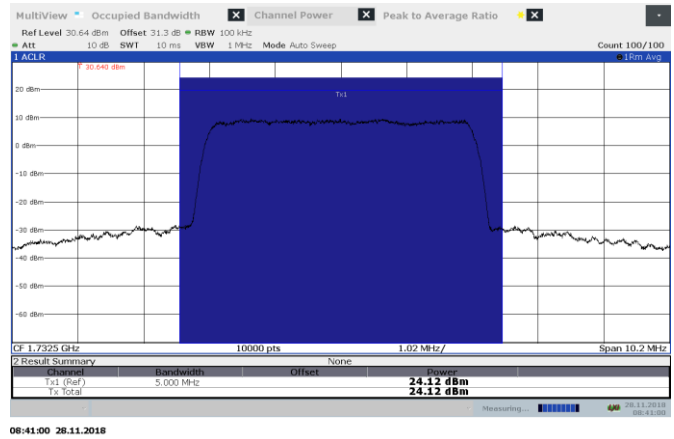

Figure 8.4-2: AWGN AGC—0.5 dB 1732.5 MHz output UL

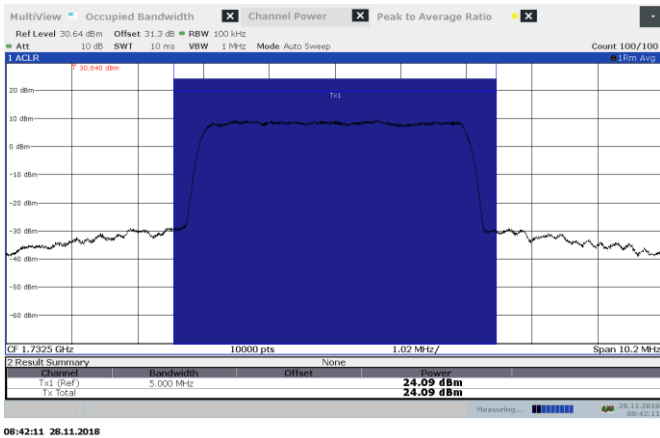

Figure 8.4-3: AWGN AGC +3dB 1732.5 MHz output UL

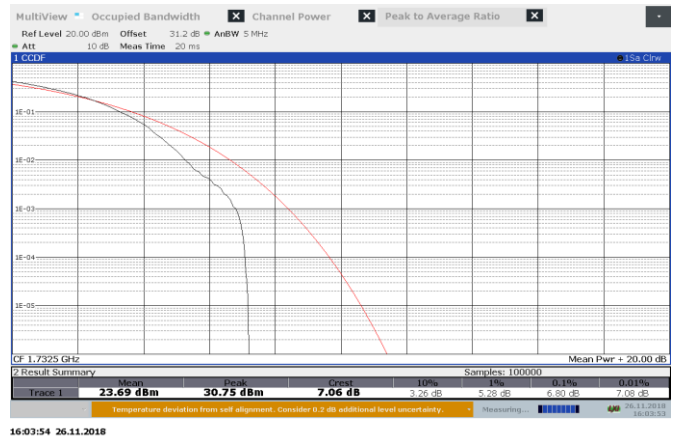

Figure 8.4-4: AWGN AGC—0.5 dB 1732.5 MHz PAPR UL

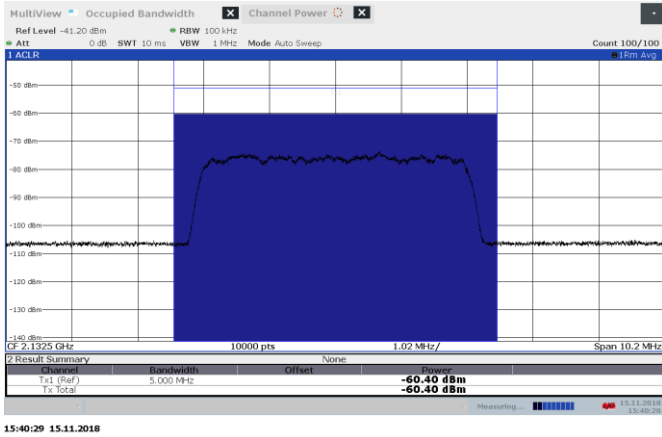

Figure 8.4-5: AWGN AGC—0.5 dB 2132.5 MHz input DL

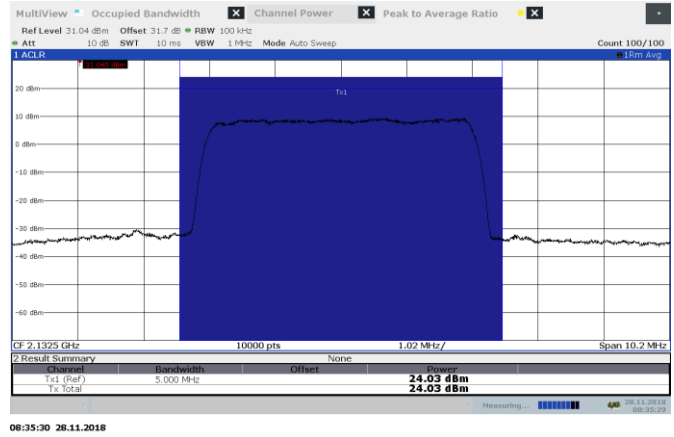

Figure 8.4-6: AWGN AGC—0.5 dB 2132.5 MHz output DL

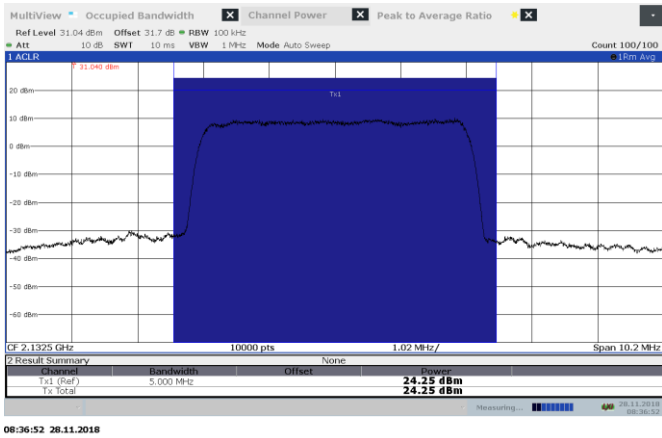

Figure 8.4-7: AWGN AGC +3dB 2132.5 MHz output DL

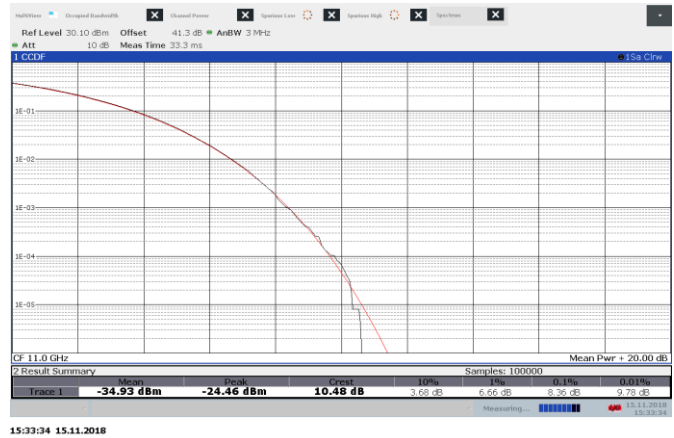

Figure 8.4-8: AWGN AGC—0.5 dB 2132.5 MHz PAPR DL

8.5 FCC 27.53(h), RSS-139 6.6, KDB 935210 D05 3.6.2, Out-of-band/out-of-block emissions conducted measurements

8.5.1 Definitions and limits

FCC 27.53(h) / RSS-139 6.6 The power of any emission outside a licensee's frequency block shall be attenuated below the transmitter power (P) in watts by at least $43 + 10 \log_{10}(P)$ dB.

8.5.2 Test summary

Test date	October 29, 2018	Temperature	23 °C
Test engineer	Kevin Rose	Air pressure	1001 mbar
Verdict	Pass	Relative humidity	39 %

8.5.3 Observations, settings and special notes

Test receiver settings:

Detector mode	RMS
Resolution bandwidth	3 kHz
Integration bandwidth	>OBW
Video bandwidth	>RBW
Trace mode	Power Average (100 sweeps)
Measurement time	Auto

8.5.4 Test data

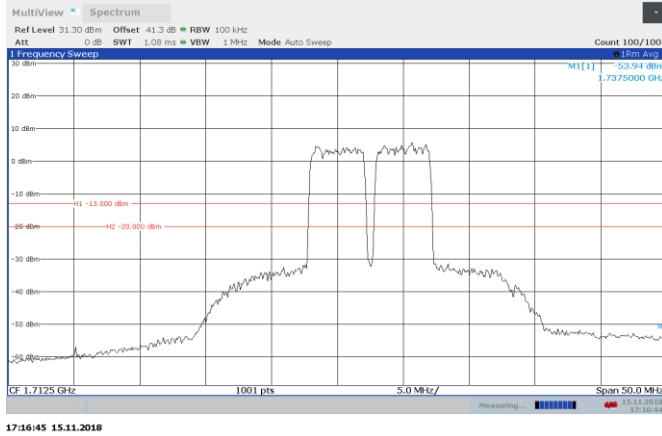

Figure 8.5-1: AWGN 1712.5 and 1717.5 MHz AGC - 0.5dB Out-of-block UL

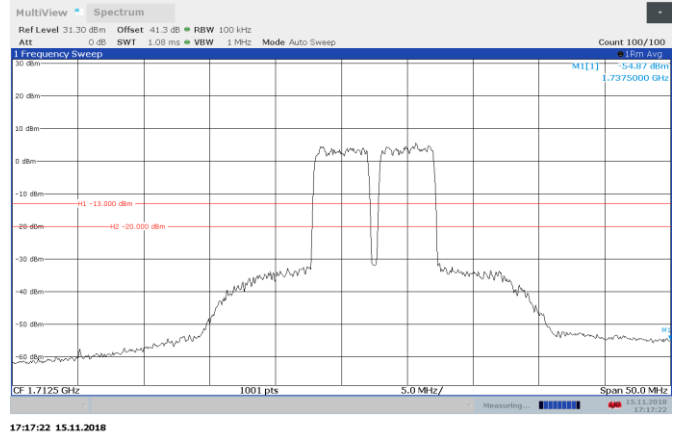

Figure 8.5-2: AWGN 1712.5 and 1717.5 MHz AGC + 3dB Out-of-block UL

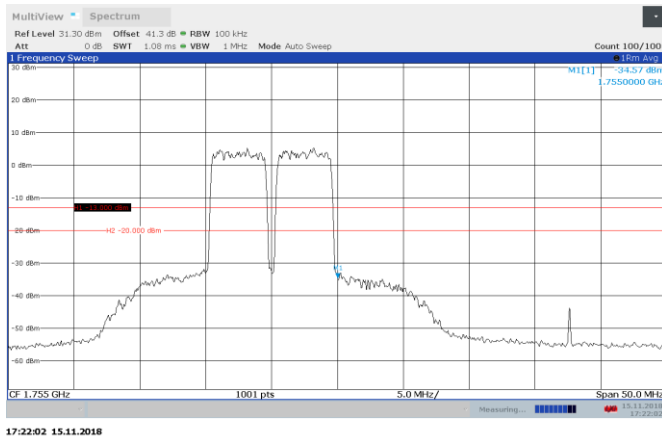

Figure 8.5-3: AWGN 1747.5 and 1752.5 MHz AGC - 0.5dB Out-of-block UL

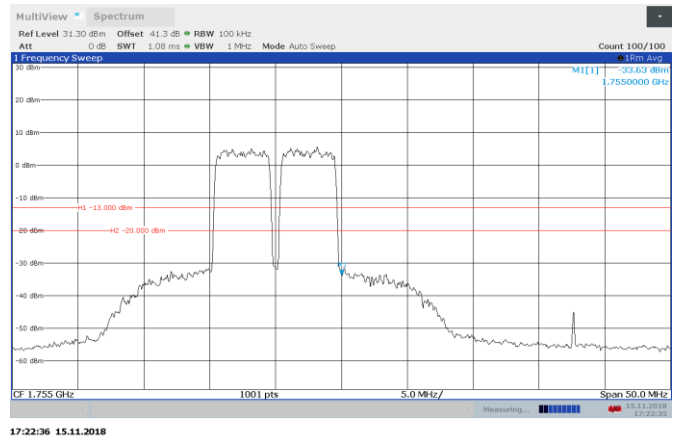

Figure 8.5-4: AWGN 1747.5 and 1752.5 MHz AGC + 3dB Out-of-block UL

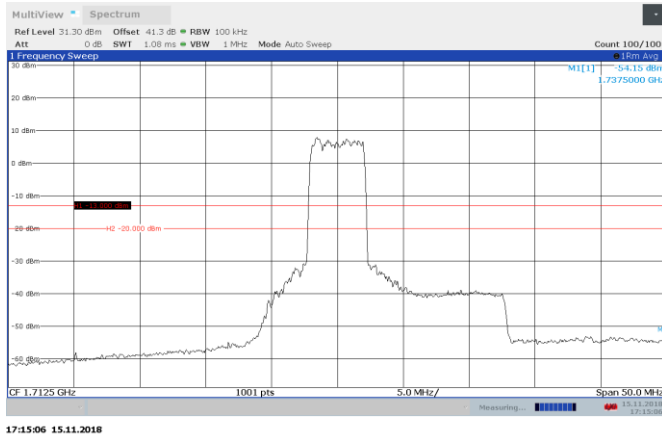

Figure 8.5-5: AWGN 1712.5 MHz AGC - 0.5dB Out-of-block UL

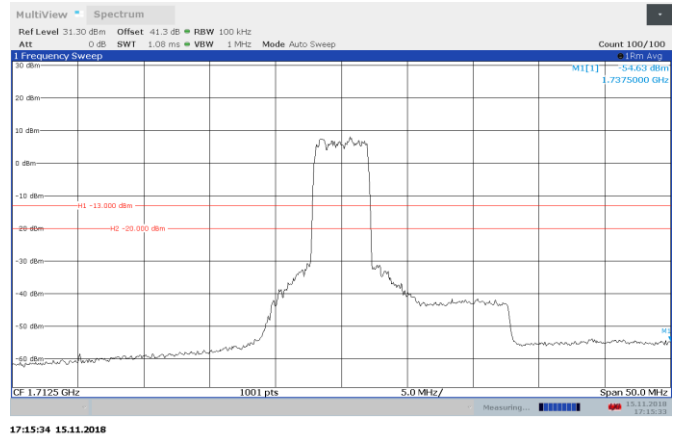

Figure 8.5-6: AWGN 1712.5 MHz AGC + 3dB Out-of-block UL

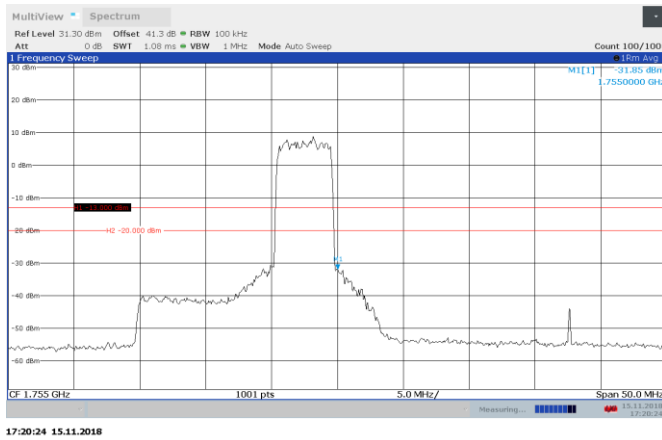

Figure 8.5-7: AWGN 1752.5 MHz AGC - 0.5dB Out-of-block UL

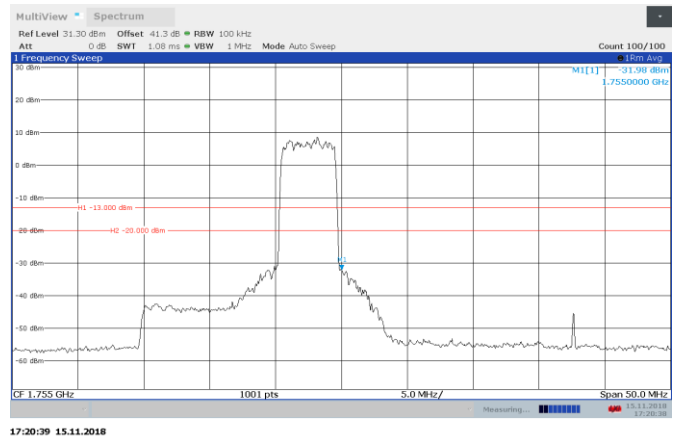

Figure 8.5-8: AWGN 1752.5 MHz AGC + 3dB Out-of-block UL

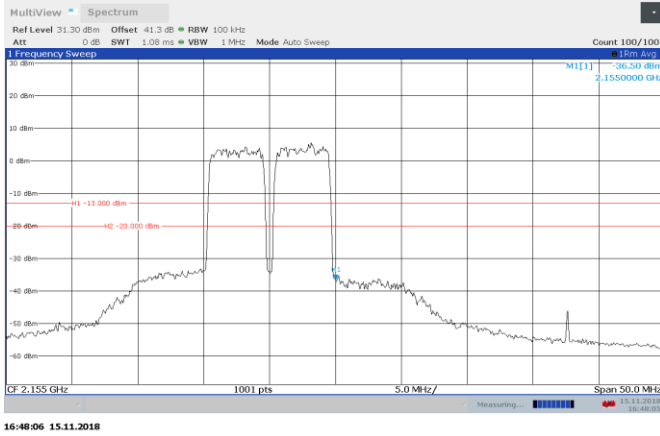

Figure 8.5-9: AWGN 2147.5 and 2152.5 MHz AGC - 0.5dB Out-of-block DL

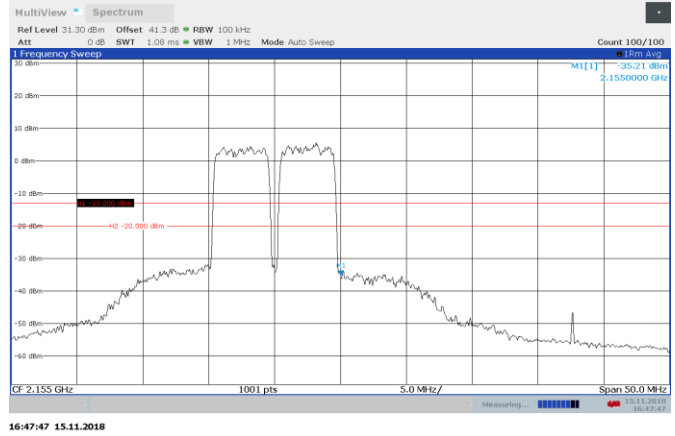

Figure 8.5-10: AWGN 1987.5 and 1992.5 MHz AGC + 3dB Out-of-block DL

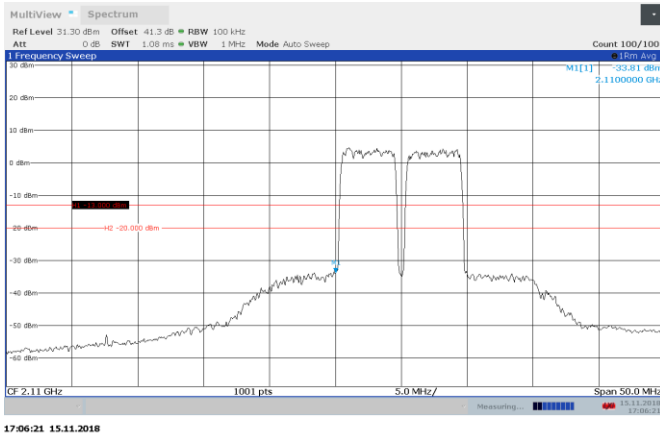

Figure 8.5-11: AWGN 2112.5 and 2117.5 MHz AGC - 0.5dB Out-of-block DL

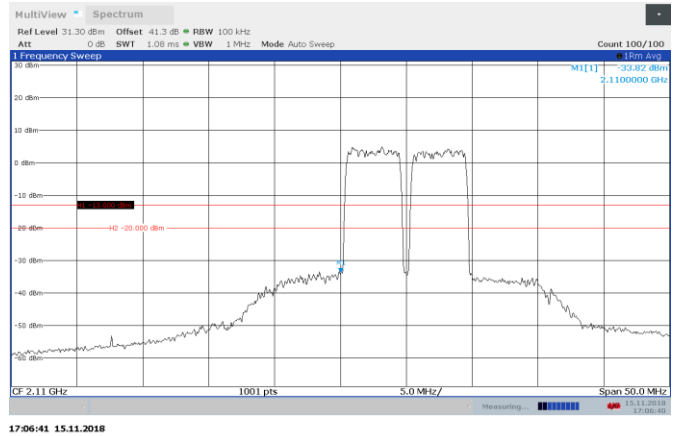

Figure 8.5-12: AWGN 2112.5 and 2117.5 MHz AGC + 3dB Out-of-block DL

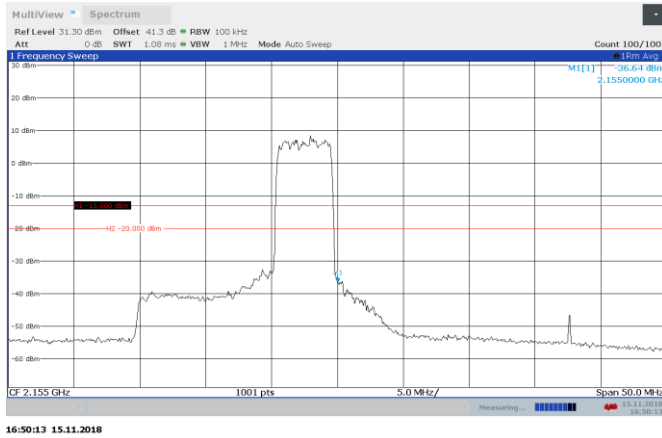

Figure 8.5-13: AWGN 2152.5 MHz AGC - 0.5dB Out-of-block DL

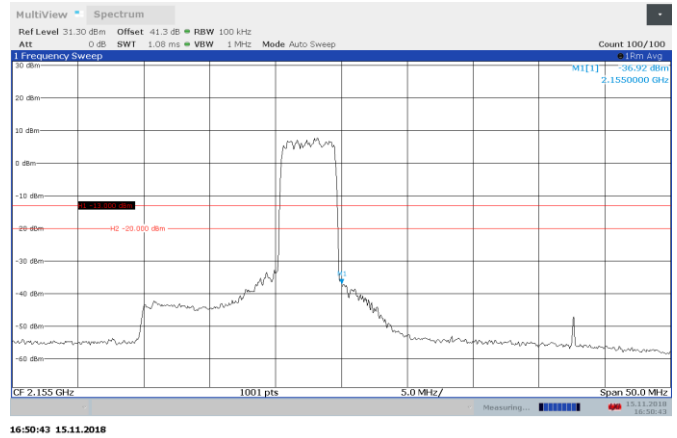

Figure 8.5-14: AWGN 2152.5 MHz AGC+ 3dB Out-of-block DL

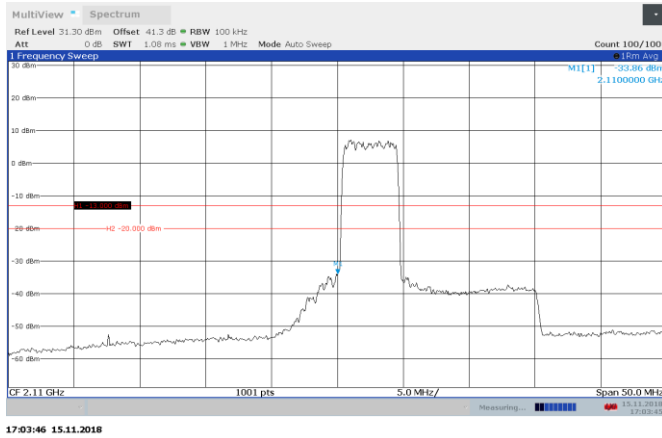

Figure 8.5-15: AWGN 2112.5 MHz AGC - 0.5dB Out-of-block DL

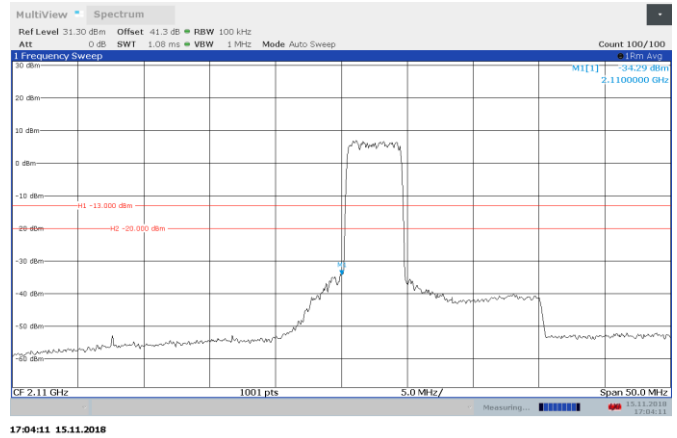

Figure 8.5-16: AWGN 2112.5 MHz AGC + 3dB Out-of-block DL

8.6 FCC 27.53(h), RSS-139 6.6, KDB 935210 D05 3.6.3, Spurious emissions conducted

FCC 27.53(h) / RSS-139 6.6 The power of any emission outside a licensee's frequency block shall be attenuated below the transmitter power (P) in watts by at least $43 + 10 \log_{10}(P)$ dB.

8.6.1 Test summary

Test date	November 8, 2018	Temperature	21 °C
Test engineer	Kevin Rose	Air pressure	1000 mbar
Verdict	Pass	Relative humidity	42 %

8.6.2 Observations, settings and special notes

Frequency range	30 MHz to 10 th harmonic
Detector mode	Peak
Resolution bandwidth sweep	100 kHz (below 1 GHz), 1000 kHz (above 1 GHz)
Video bandwidth	>RBW
Trace mode	Max Hold
Measurement time	Auto

8.6.3 Test data

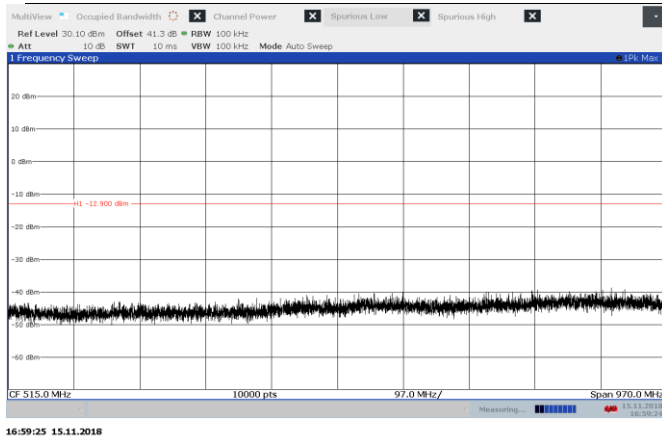

Figure 8.6-1: AWGN 212.5 MHz conducted emission DL 30 – 1000MHz

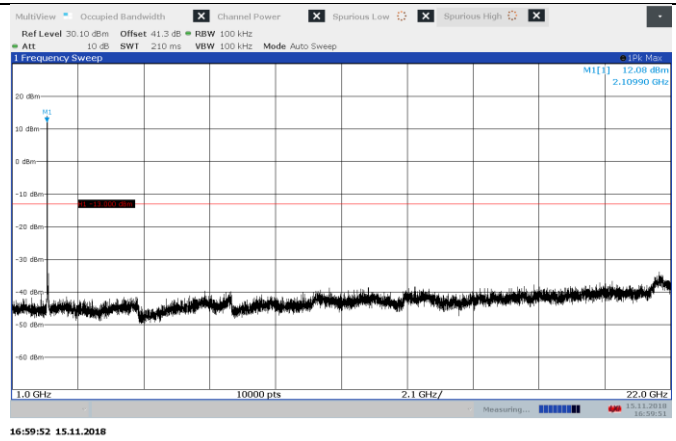

Figure 8.6-2: AWGN 212.5 MHz conducted emission DL 1-22GHz

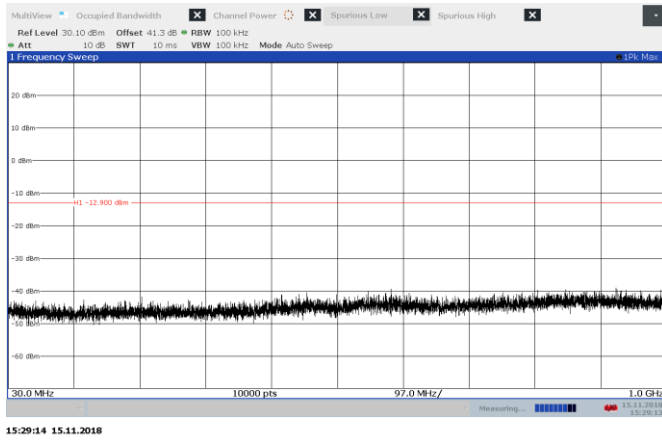

Figure 8.6-3: AWGN 2132.5 MHz conducted emission DL 30 – 1000MHz

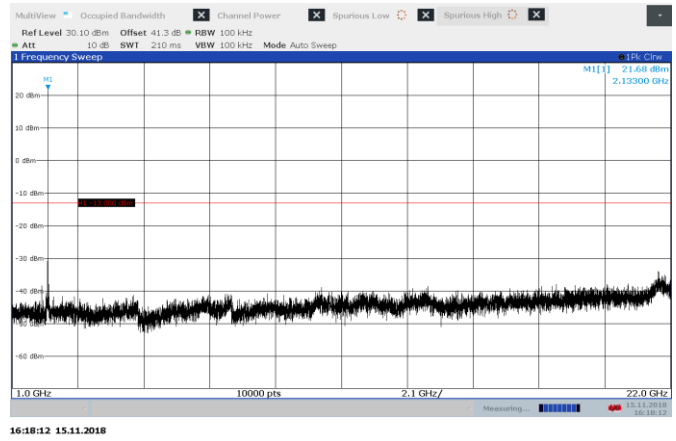

Figure 8.6-4: AWGN 2132.5 MHz conducted emission DL 1-22GHz

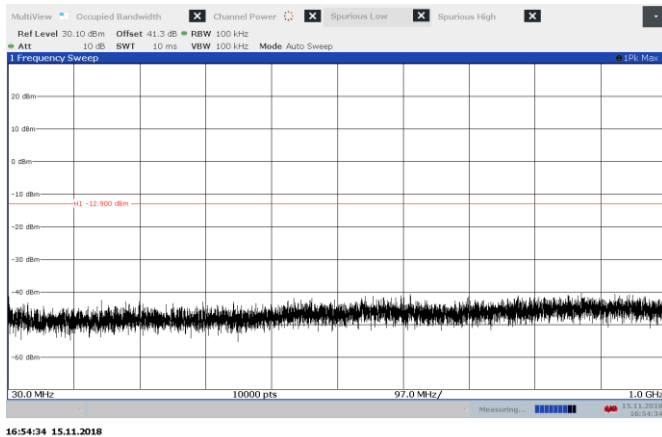

Figure 8.6-5: AWGN 2152.5 MHz conducted emission DL 30 – 1000MHz

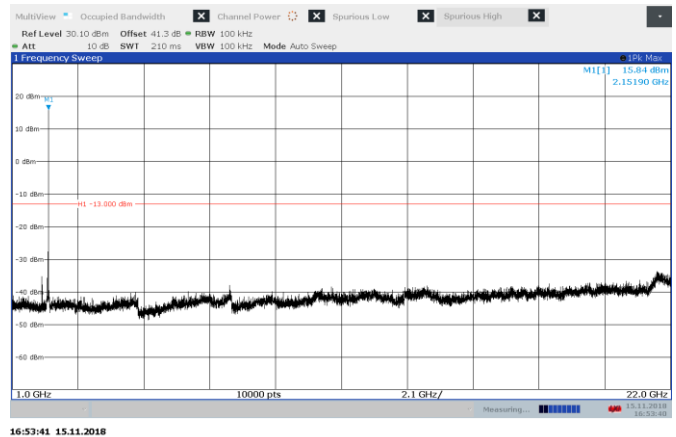
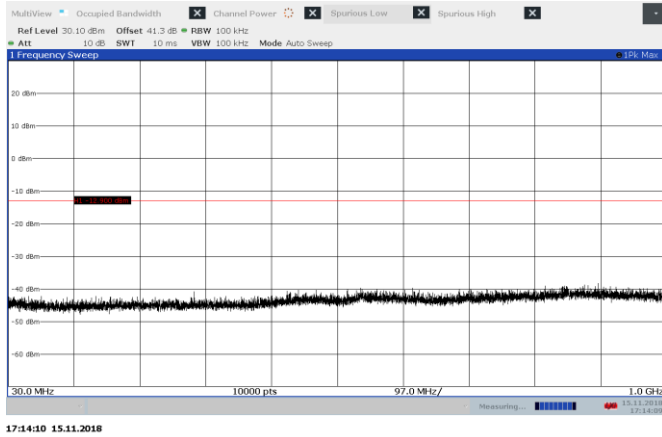
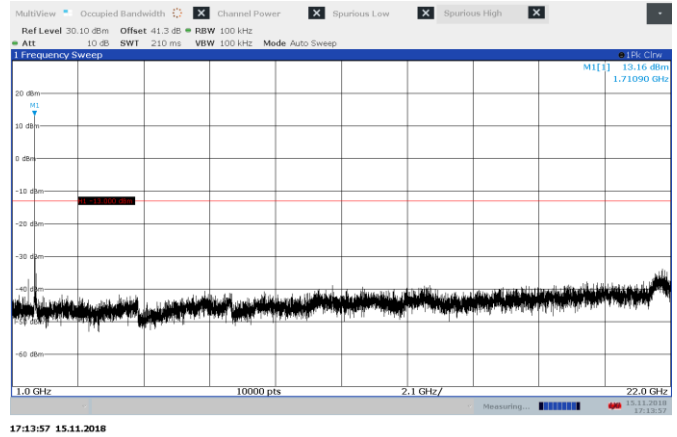

Figure 8.6-6: AWGN 2152.5 MHz conducted emission DL 1-22GHz



17:14:10 15.11.2018

Figure 8.6-7: AWGN 1712.5 MHz conducted emission DL 30 – 100MHz



17:13:57 15.11.2018

Figure 8.6-8: AWGN 1712.5 MHz conducted emission DL 1-22GHz

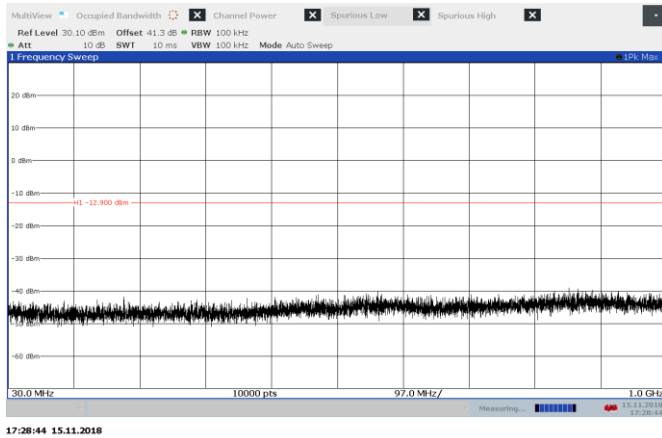

17:28:44 15.11.2018

Figure 8.6-9: AWGN 1732.5 MHz conducted emission DL 30 – 100MHz

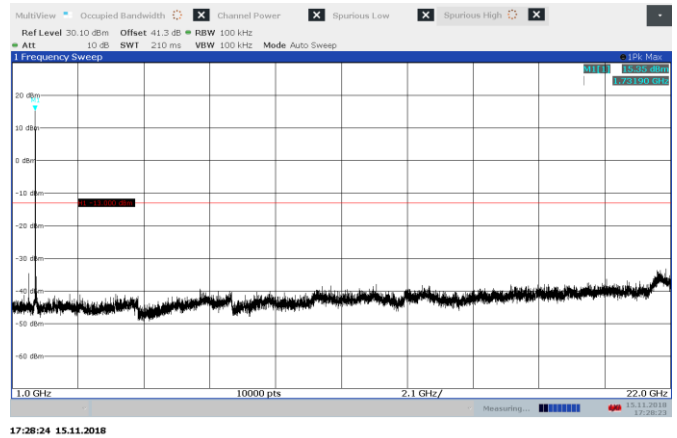

17:28:24 15.11.2018

Figure 8.6-10: AWGN 1732.5 MHz conducted emission DL 1-22GHz

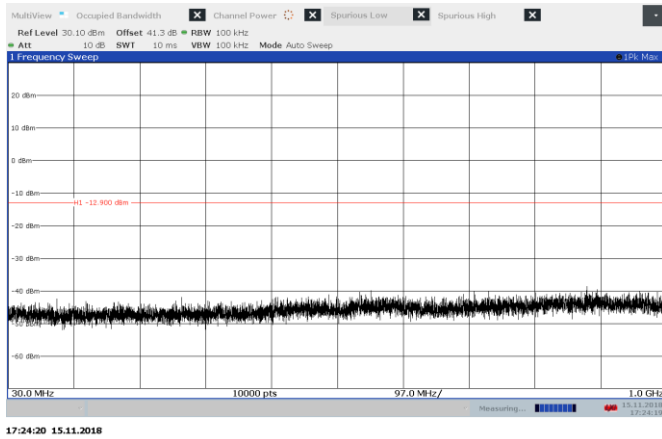

17:24:20 15.11.2018

Figure 8.6-11: AWGN 1752.5 MHz conducted emission DL 30 – 100MHz

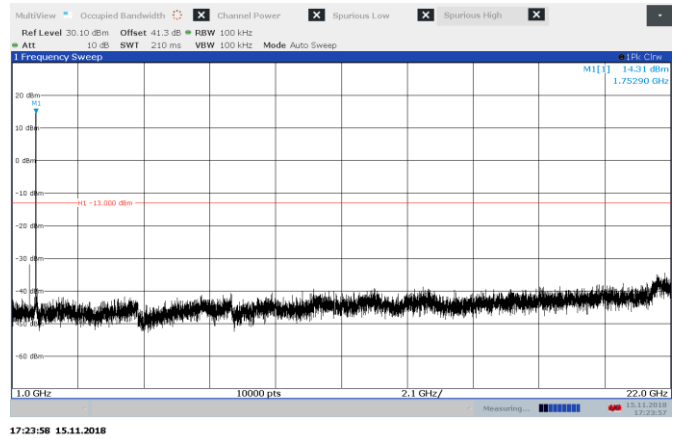

17:23:58 15.11.2018

Figure 8.6-12: AWGN 1752.5 MHz conducted emission DL 1-22GHz

8.7 FCC 27.53(h), RSS-139 6.6, KDB 935210 D05 3.8, Spurious emissions radiated measurements

8.7.1 Definitions and limits

FCC 27.53(h) / RSS-139 6.6 The power of any emission outside a licensee's frequency block shall be attenuated below the transmitter power (P) in watts by at least $43 + 10 \log_{10}(P)$ dB.

8.7.2 Test summary

Test date	June 27, 2018	Temperature	21 °C
Test engineer	Kevin Rose	Air pressure	1000 mbar
Verdict	Pass	Relative humidity	42 %

8.7.3 Observations, settings and special notes

No emissions within 20 dB of the limit were detected.

Receiver settings were:

Frequency range	30 MHz to 10 th harmonic
Detector mode	Peak
Resolution bandwidth	100 kHz (below 1 GHz), 1000 kHz (above 1 GHz)
Video bandwidth	>RBW
Trace mode	Max Hold

8.7.4 Test data

No emissions within 20 dB of the limit were detected.

Section 9. Setup Photos

9.1 Set-up

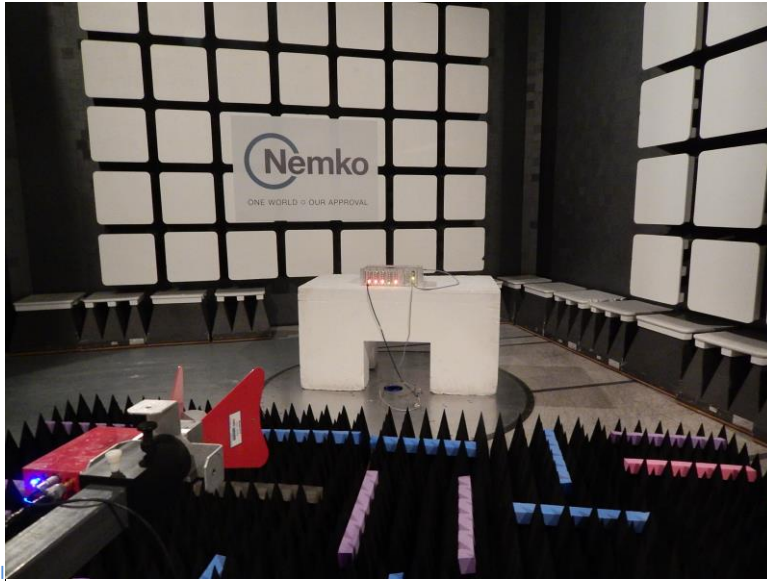

Figure 9.1-1: Radiated setup photo



Figure 9.1-2: Conducted setup photo

Section 10. Block diagrams of test set-ups

10.1 Measuring AGC threshold level, Out-of-band-rejection, Input-versus-output signal comparison, Mean output power and amplifier/booster gain, Spurious emissions conducted measurements, Spurious emissions radiated measurements

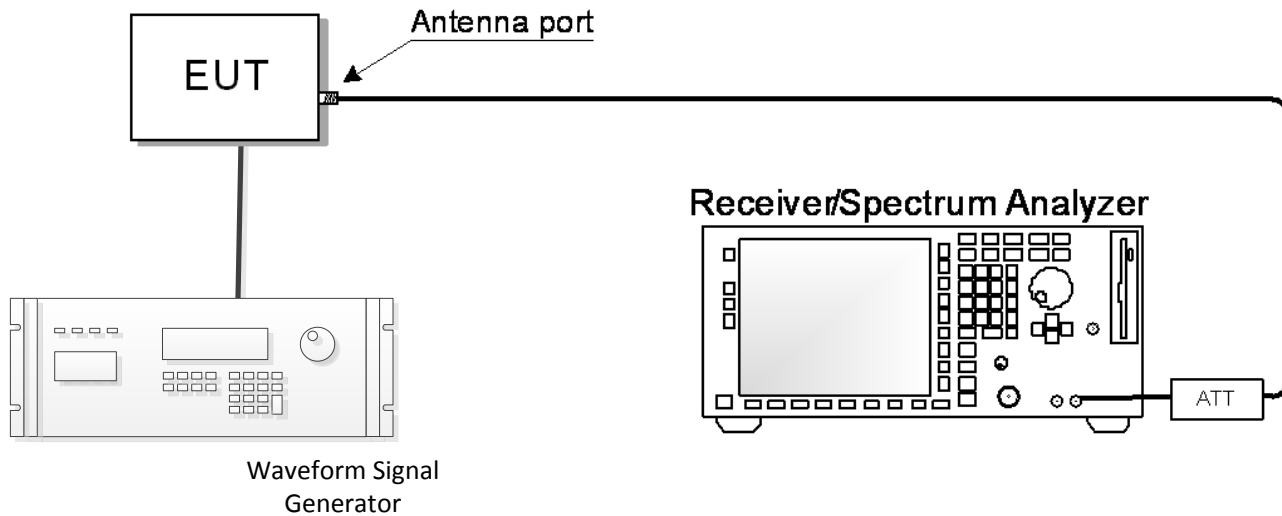

10.2 Out-of-band/out-of-block emissions conducted measurements

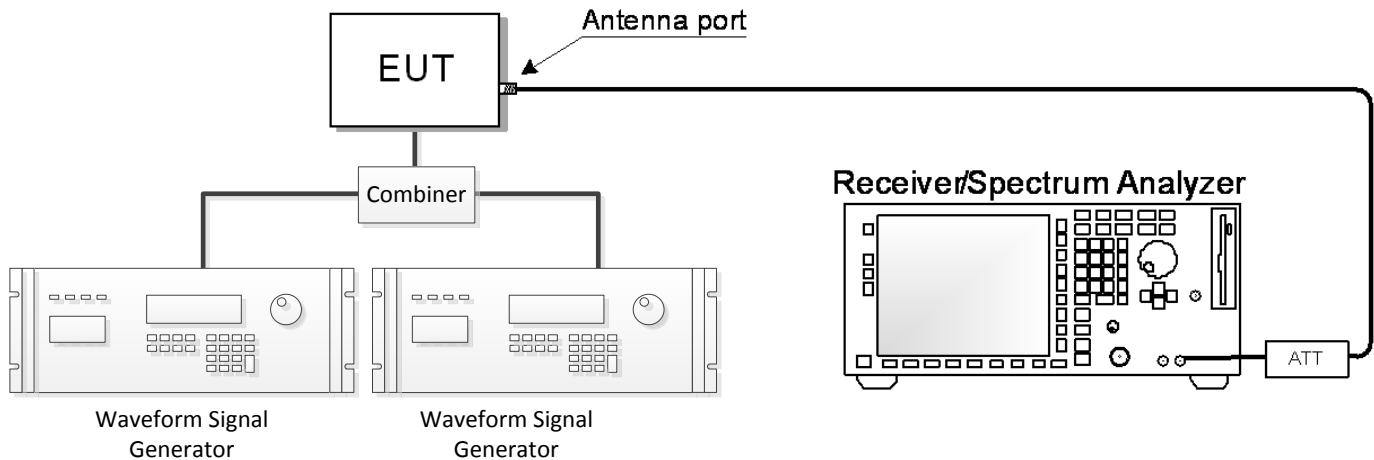

10.3 Spurious emissions radiated measurements

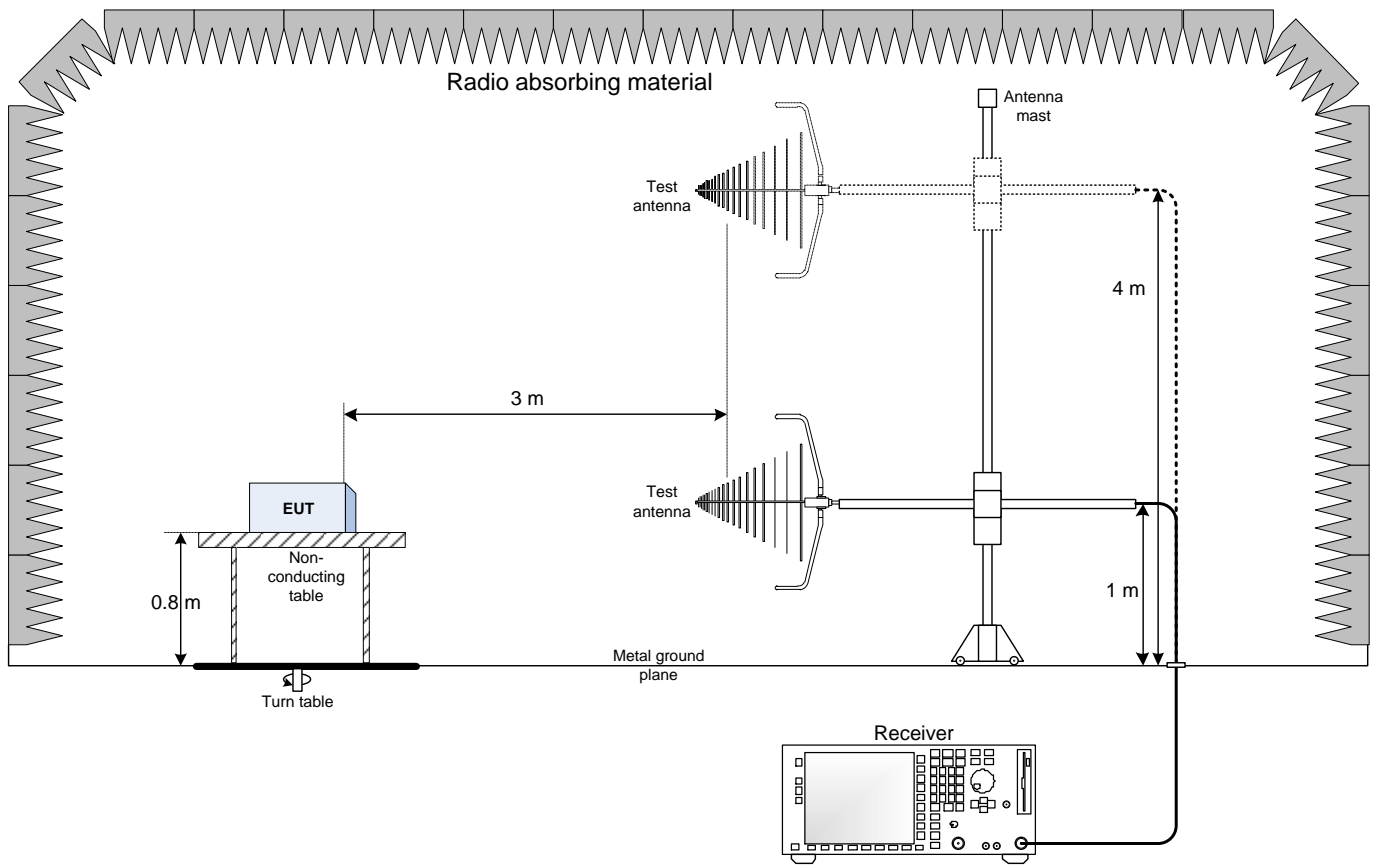

10.4 Spurious emissions radiated measurements (above 1GHz)

