

Ke Mei Ou Laboratory Co., Ltd.

7A, Jiexiangge, JiahuiXincheng, No.3027, Shennan Rd., Futian,
Shenzhen, Guangdong, P.R.China. Zip Code: 518033
Tel: + 86 755 83642690 Fax: + 86 755 83297077
www.kmolab.com

FCC TEST REPORT

Under
FCC 15 Subpart C, Paragraph 15.247: 2007

Operating in 2400 ~ 2483.5 MHz Band

Prepared For :

Shenzhen Gongjin Electronics Co., Ltd.

A211-A213, B201-B210, 2F Baiying Building, 1019# Nanhai Rd., Shekou, Shenzhen,
Guangdong, China

FCC ID: V4VWNA699U8G1
EUT: USB Wireless Card
Model: WNA699U8G.1

September 12, 2008

Report Type: Original Report
Test Engineer: <u>Jacky Huang</u>
Test Date: <u>August 27, 2008</u>
 Review By: _____
Apollo Liu / Manager

The test report consists 34 pages in total. It may be duplicated completely for legal use with the allowance of the applicant. It shall not be reproduced except in full, without the written approval of Ke Mei Ou Laboratory Corporation. The test result in the report only applied to the tested sample.

TABLE OF CONTENTS

1. General Information..... 3

 1. 1 Notes 3

 1. 2 Testing Laboratory 3

 1. 3 Details of Applicant 3

 1. 4 Application Details 3

 1. 5 Test Item 3

 1. 6 Test Standards 3

2. Technical Test..... 4

 2. 1 Summary of Test Results 4

 2. 2 Antenna Requirement 4

3. EUT Modifications..... 4

4. Conducted Power Line Test 5

 4. 1 Test Equipment 5

 4. 2 Test Procedure 5

 4. 3 Test Setup 5

 4. 4 Configuration of the EUT 6

 4. 5 EUT Operating Condition 7

 4. 6 Conducted Power Line Emission Limits 7

 4. 7 Conducted Power Line Test Result 7

5. FCC Part 15.247 Requirements for 802.11b/g Systems 8

 5. 1 Test Equipment 8

 5. 2 Test Procedure 8

 5. 3 Test Setup 8

 5. 4 Configuration of the EUT 8

 5. 5 EUT Operating Condition 8

 5. 6 Limit 8

 5. 7 Test Result 9

6. Transmitter Spurious Radiated Emission at 3 Meters..... 24

 6. 1 Test Equipment 24

 6. 2 Test Procedure 24

 6. 3 Test Setup 24

 6. 4 Configuration of the EUT 24

 6. 5 EUT Operating Condition 24

 6. 6 Limit 25

 6. 7 Test Result 26

7. RF Exposure Requirements..... 28

 7. 1 Test Equipment 28

 7. 2 Limit 28

 7. 3 Test Result 28

8. Photos of Testing..... 29

 8. 1 EUT Test Photographs 29

 8. 2 EUT Detailed Photographs 30

9. FCC ID Label 33

10. Test Equipment 34

1. General Information

1.1 Notes

The test results of this report relate exclusively to the test item specified in 1.5. The KMO Lab does not assume responsibility for any conclusions and generalizations drawn from the test results with regard to other specimens or samples of the type of the equipment represented by the test item. The test report may only be reproduced or published in full. Reproduction or publication of extracts from the report requires the prior written approval of the KMO Lab.

1.2 Testing Laboratory

SinTek Laboratory Co., Ltd.

No.7, Xinshidai Industrial, Guantian Village, Shiyao Town, Bao'an District, Shenzhen, Guangdong China..

Tel: +86 755 27608353 Fax: +86 755 27608359

Site on File with the Federal Communications Commission – United States

Registration Number: 963441

1.3 Details of Applicant

Name : Shenzhen Gongjin Electronics Co., Ltd.

Address : A211-A213, B201-B210, 2F Baiying Building, 1019# Nanhai Rd., Shekou, Shenzhen, Guangdong, China

Contact

Tel

Fax

1.4 Application Details

Date of Receipt of Application : August 27, 2008

Date of Receipt of Test Item : August 28, 2008

Date of Test : August 28~September 12, 2008

1.5 Test Item

Manufacturer : Same Applicant

Address : Same Applicant

Trade Name : N/A

Model No. : WNA699U8G.1

Description : USB Wireless Card

Additional Information

Frequency : 2412MHz~2462MHz

Maximum Range : N/A

Number of Channels : 11

Transmitter Antenna : Internal

Power Supply : DC 5V(From Host)

Modulation Type : IEEE 802.11b: DQPSK, DBPSK, DSSS, and CCK
IEEE 802.11g: BPSK, QPSK, 16QAM, 64QAM

Power Consumption :

1.6 Test Standards

FCC 15 Subpart C, Paragraph 15.247: 2007
--

Note: All radiated measurements were made in all three orthogonal planes. The values reported are the maximum values.

2. Technical Test

2.1 Summary of Test Results

The EUT has been tested according to the following specifications:

Standard	Test Type	Result	Notes
FCC Part 15, Paragraph 15.203	Antenna Requirement	PASS	Complies
FCC Part 15, Paragraph 15.107, 15.207	Conducted Test	N/A	Complies
FCC Part 15.205	Radiated Emission (Restricted Band Requirements)	PASS	Complies
FCC Part 15.109, 15.209	Radiated Emission (Spurious Emission)	PASS	Complies.
FCC Part 15 Subpart C Paragraph 15.247(a)(2)	Spectrum Bandwidth (6dB Bandwidth Measurement)	PASS	Complies.
FCC Part 15 Subpart C Paragraph 15.247(b)(3)	Maximum Peak Power	PASS	Complies
FCC Part 15 Subpart C Paragraph 15.247(c)	100kHz Bandwidth of Frequency Band Edges	PASS	Complies
FCC Part 15 Subpart C Paragraph 15.247(d)	Peak Power Spectral Density	PASS	Complies

* The digital circuit porting of the EUT has been tested and verified to comply with FCC Part 15, Subpart B., Class B Digital Devices and the associated Radio Receiver has also been tested and found to comply with FCC Part 15, Subpart B – Radio Receivers.

2.2 Antenna Requirement

A. Regulation

FCC section 15.203, An intentional radiator shall be designed to ensure that no antenna other than that furnished by the responsible party shall be used with the device. The use of a permanently attached antenna or of an antenna that uses a unique coupling to the intentional radiator shall be considered sufficient to comply with the provisions of Part 15C. The manufacturer may design the unit so that the user can replace a broken antenna, but the use of a standard antenna jack or electrical connector is prohibited. This requirement does not apply to carrier current devices or to devices operated under the provisions of Sections 15.211, 15.213, 15.217, 15.219, or 15.221. Further, this requirement does not apply to intentional radiators that must be professionally installed, such as perimeter protection systems and some field disturbance sensors, or to other intentional radiators which, in accordance with Section 15.31(d), must be measured at the installation site. However, the installer shall be responsible for ensuring that the proper antenna is employed so that the limits in this Part are not exceeded.

B. Result

The EUT no antenna connector for printed antenna. Therefore the EUT complies with Section 15.203 of the FCC rules.

3. EUT Modifications

No modification by test lab.

4. Conducted Power Line Test

4.1 Test Equipment

Please refer to Section 10 this report.

4.2 Test Procedure

The EUT and simulators are connected to the main power through a line impedance stabilization network (L.I.S.N.). This provides a 50 ohm/50uH coupling impedance for the measuring equipment. The peripheral devices are also connected to the main power through a LISN that provides a 50ohm/50uH coupling impedance with 50ohm termination.

Both sides of A.C. line are checked for maximum conducted interference. In order to find the maximum emission., the relative positions of equipment and all of the interface cables must be changed according to ANSI C63.4:2003 on conducted measurement. Conducted emissions were invested over the frequency range from 0.15MHz to 30MHz using a receiver bandwidth of 9kHz.

4.3 Test Setup

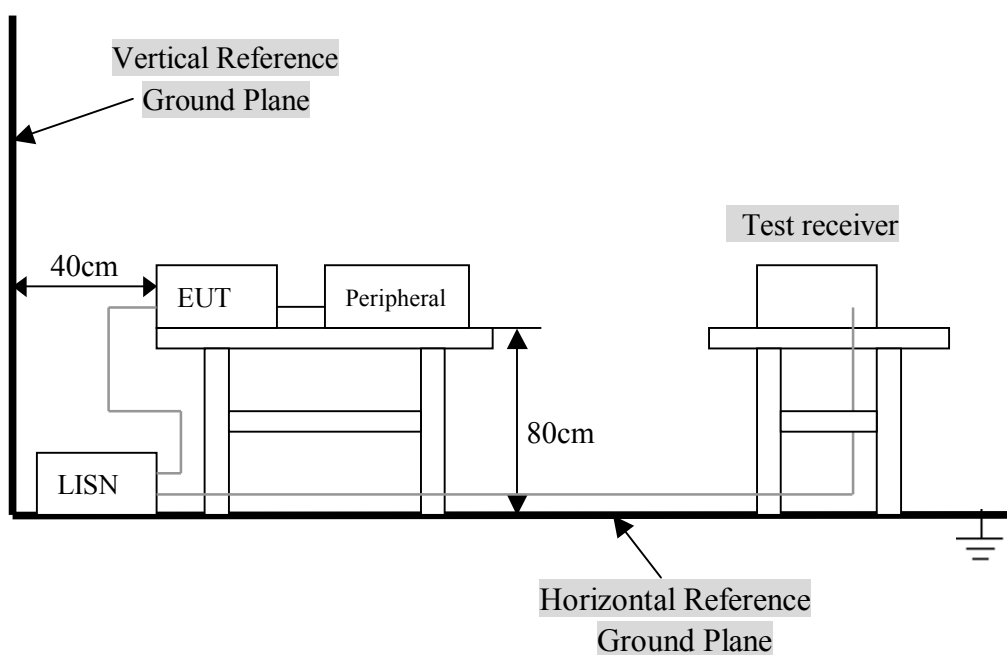

For the actual test configuration, Please refer to the related items – Photos of Testing.

4.4 Configuration of the EUT

The EUT was configured according to ANSI C63.4-2003. EUT was used DC5V. The operation frequency is from 2400MHz~2483.5MHz. Enable the signal transmitted from the EUT to Notebook PC. All interface ports were connected to the appropriate peripherals. All peripherals and cables are listed below.

Note:

- 1) Operating Modes: Each of lowest, middle and highest channel frequencies transmits continuously for emissions measurements. The EUT operates in normal 802.11b/g for occupancy duration and frequency separation.
- 2) Special Test Software & Hardware: Special firmware and hardware provided by the Applicant are installed to allow the EUT to operate in 802.11b/g or at each channel frequency continuously. For example, the transmitter will be operated at each of lowest, middle and highest frequencies individually continuously during testing.
- 3) Transmitter Test Antenna: The EUT is tested with the antenna fitted in a manner typical of normal intended use as an integral / non-integral antenna equipment as describe with the test results.
- 4) Frequency(ies) Tested: 2412MHz, 2437MHz and 2462MHz were pre-tested, The worst case one, was chosen for conducted emission test.
- 5) Above 1GHz, the 2412MHz, 2437MHz and 2462MHz were tested individually.
- 6) Normal Test Modulation: 802.11b/g
- 7) Modulating Signal Source: Internal

* Associated Antenna Descriptions: The antenna used in this product is embedded antenna.

A. EUT

Device	Manufacturer	Model #	FCC ID
USB Wireless Card	Shenzhen Gongjin Electronics Co., Ltd.	WNA699U8G.1	V4VWNA699U8G1

B. Internal Devices

Device	Manufacturer	Model #	FCC ID
N/A			

C. Peripherals

Device	Manufacturer	Model # Serial #	FCC ID/ DoC	Cable
Printer	HP	HP930C	DoC	1.5m unshielded power cord 1.2m unshielded data cable.
Modem	GVC	N/A	DoC	1.5m unshielded power cord 1.2m unshielded data cable.
Notebook	DELL	PP10L	DoC	1.5m unshielded power cord
PC	Dell	2400n	DoC	1.5m unshielded power cord

4. 5 EUT Operating Condition

Operating condition is according to ANSI C63.4 - 2003.

- A. Setup the EUT and simulators as shown on follow.
- B. Enable RF signal and confirm EUT active.
- C. Modulate output capacity of EUT up to specification.

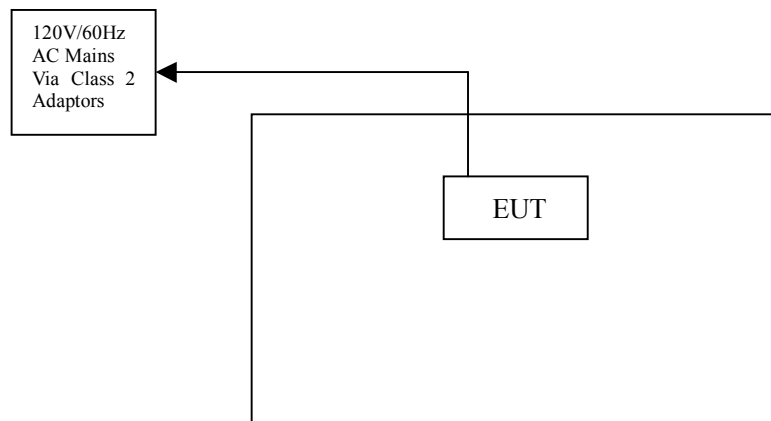

4. 6 Conducted Power Line Emission Limits

FCC Part 15 Paragraph 15.207 (dBuV)		
Frequency Range (MHz)	Class A QP/AV	Class B QP/AV
0.15 – 0.5	79/66	66-56/56-46
0.5 – 5.0	73/60	56/46
5.0 - 30	73/60	60/50

NOTE : In the above table, the tighter limit applies at the band edges.

4. 7 Conducted Power Line Test Result

Owing to the DC operation of EUT, this test item is not performed.

5. FCC Part 15.247 Requirements for 802.11b/g Systems

5.1 Test Equipment

Please refer to Section 10 this report.

5.2 Test Procedure

Refer to FCC 15.247(a)(2), ANSI C63.4: 2003

6 dB Bandwidth:

- Place the EUT on the table and set it in the transmitting mode.
- Remove the antenna from the EUT and then connect a low loss RF cable from the antenna port to the spectrum analyzer.
- Set the spectrum analyzer as RBW = 100 kHz, VBW = RBW, Span = 50 MHz, Sweep = auto.
- Mark the peak frequency and -6dB (upper and lower) frequency.
- Repeat until all the rest channels are investigated.

Peak Power:

The transmitter output is connected to the test receiver. The test receiver is set to the peak power detection. The power is equal to the reading level on test receiver plus cable loss at the EUT RF output terminal.

Band Edges Measurement:

- The transmitter output was connected to the spectrum analyzer via a low lose cable.
- Set both RBW and VBW of spectrum analyzer to 100kHz with suitable frequency span including 100kHz bandwidth from band edge.
- The band edges was measured and recorded.

Peak Power Spectral Density:

- The transmitter output is connected to a test receiver, The spectrum analyzer's resolution bandwidth was set at 3kHz RBW and 30kHz VBW as that of the fundamental frequency. Set the sweep time=span/3kHz.
- The power spectral density was measured and recorded.
- The sweep time is allowed to be longer than span/3kHz for a full response of the mixer in the spectrum analyzer.

5.3 Test Setup

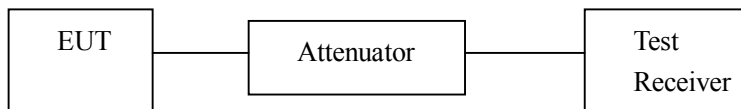

5.4 Configuration of the EUT

Same as section 4.4 of this report

5.5 EUT Operating Condition

Same as section 4.5 of this report.

5.6 Limit

According to §15.247(a)(2), systems using digital modulation techniques may operate in the 902 ~ 928 MHz, 2400 ~ 2483.5 MHz, and 5725 ~ 5850 MHz bands. The minimum 6dB bandwidth shall be at least 500 kHz.

According to §15.247(b)(3), for systems using digital modulation in the bands of 902-928 MHz, 2400-2483.5 MHz, and 5725-5850 MHz: 1 Watt.

According to §15.247(b)(4), the conducted output power limit specified in paragraph (b) of this section is based on the use of antennas with directional gains that do not exceed 6 dBi. Except as shown in paragraph (c) of this section, if transmitting antennas of directional gain greater than 6 dBi are used, the conducted output power from the intentional radiator shall be reduced below the stated values in paragraphs (b)(1), (b)(2), and (b)(3) of this section, as appropriate, by the amount in dB that the directional gain of the antenna exceeds 6 dBi.

According to §15.247(d), in any 100 kHz bandwidth outside the frequency bands in which the spread spectrum intentional radiator is operating, the radio frequency power that is produced by the intentional radiator shall be at least 20 dB below that in the 100 kHz bandwidth within the band that contains the highest level of the desired power, based on either an RF conducted or a radiated measurement, provided the transmitter demonstrates compliance with the peak conducted power limits. In addition, radiated emissions which fall in the restricted bands, as defined in §15.205(a), must also comply with the radiated emission limits specified in 15.209(a) (see Section 15.205(c)).

According to §15.247(e), for digitally modulated systems, the power spectral density conducted from the intentional radiator to the antenna shall not be greater than 8 dBm in any 3 kHz band during any time interval of continuous transmission.

According to §15.247(f), the digital modulation operation of the hybrid system, with the frequency hopping turned off, shall comply with the power density requirements of paragraph (d) of this section.

5.7 Test Result

A. 6 dB Bandwidth

Product	: USB Wireless Card	Test Mode	: IEEE 802.11b/g
Test Item	: 6 dB BW	Temperature	: 25 °C
Test Voltage	: DC 5V (Power by DC Power Supply)	Humidity	: 56%RH
Test Result	: PASS		

IEEE 802.11b

Channel	Frequency (MHz)	Bandwidth (MHz)	FCC Limit (kHz)	Result
Low	2412	12.04	>500 kHz	PASS
Mid	2437	12.12		PASS
High	2462	12.08		PASS

IEEE 802.11g

Channel	Frequency (MHz)	Bandwidth (MHz)	FCC Limit (kHz)	Result
Low	2412	16.56	>500 kHz	PASS
Mid	2437	16.56		PASS
High	2462	16.56		PASS

IEEE 802.11b

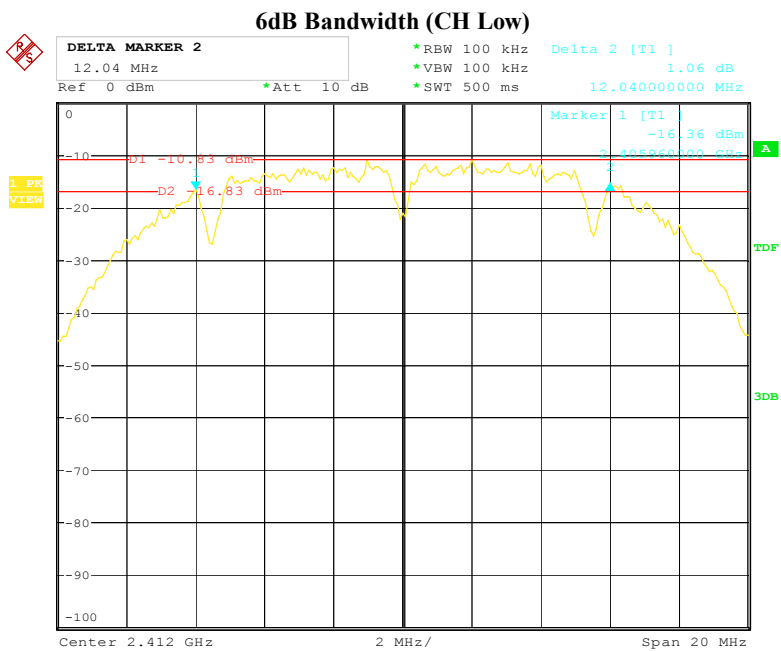

Date: 3.SEP.2008 14:43:36

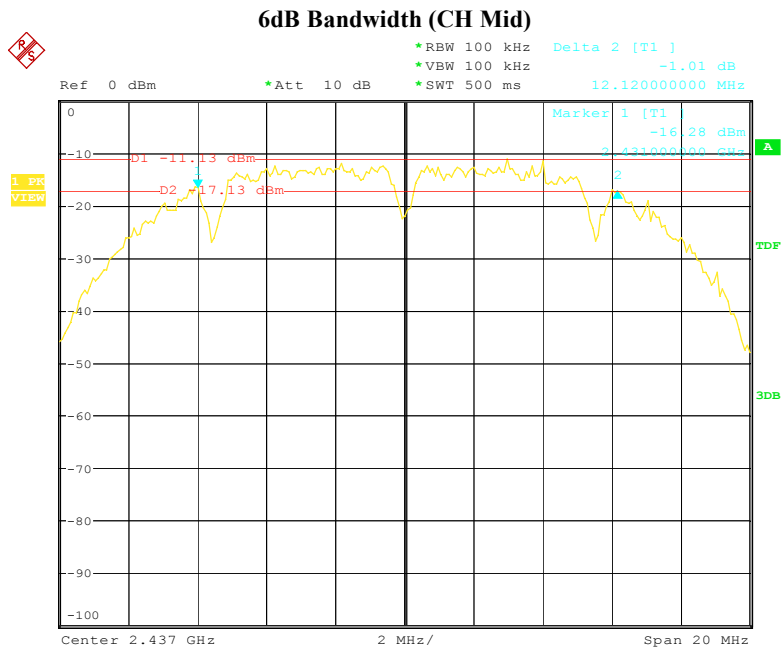

Date: 3.SEP.2008 15:19:20

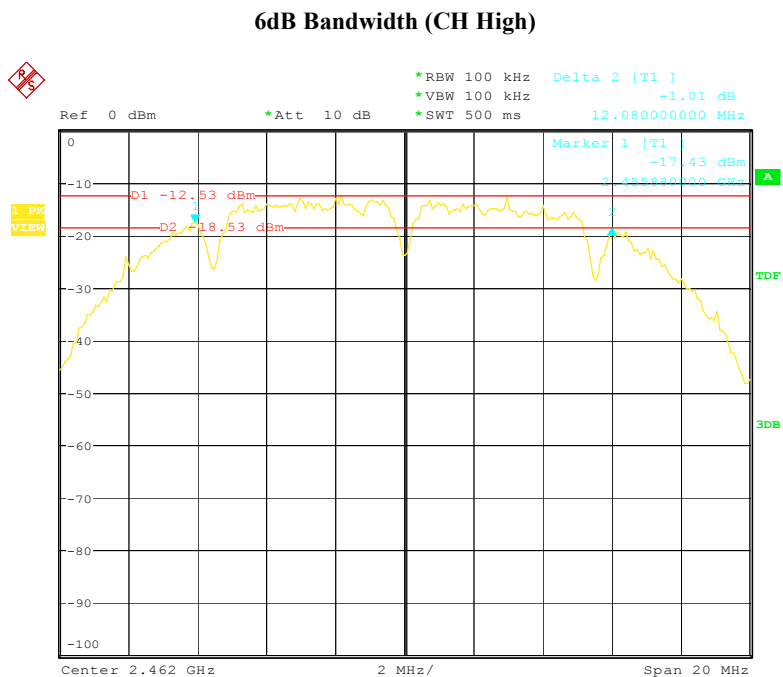

Date: 3.SEP.2008 15:23:38

IEEE 802.11g

6dB Bandwidth (CH Low)

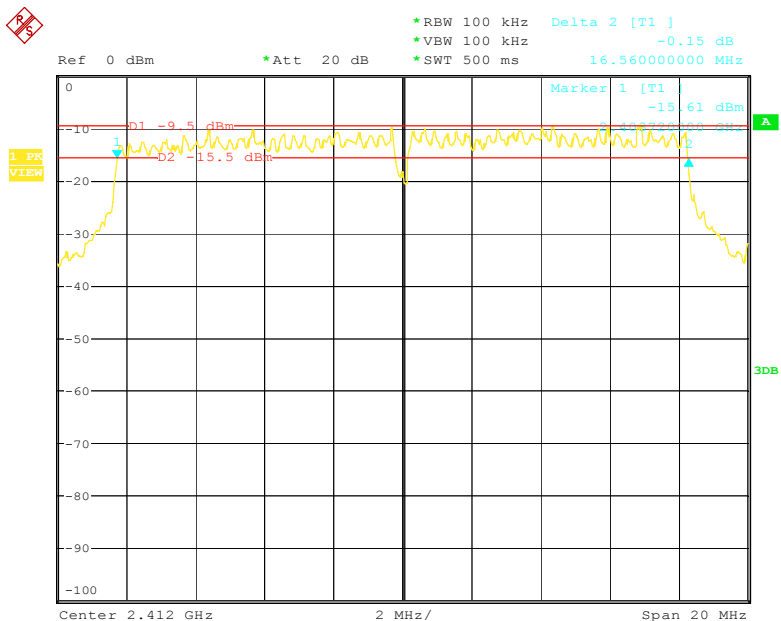

Date: 8.SEP.2008 20:32:33

6dB Bandwidth (CH Mid)

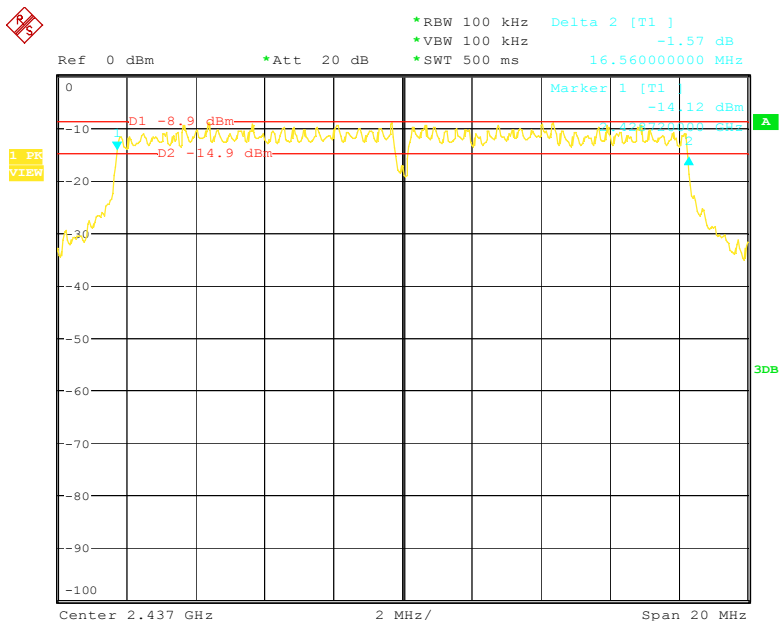

Date: 8.SEP.2008 20:43:13

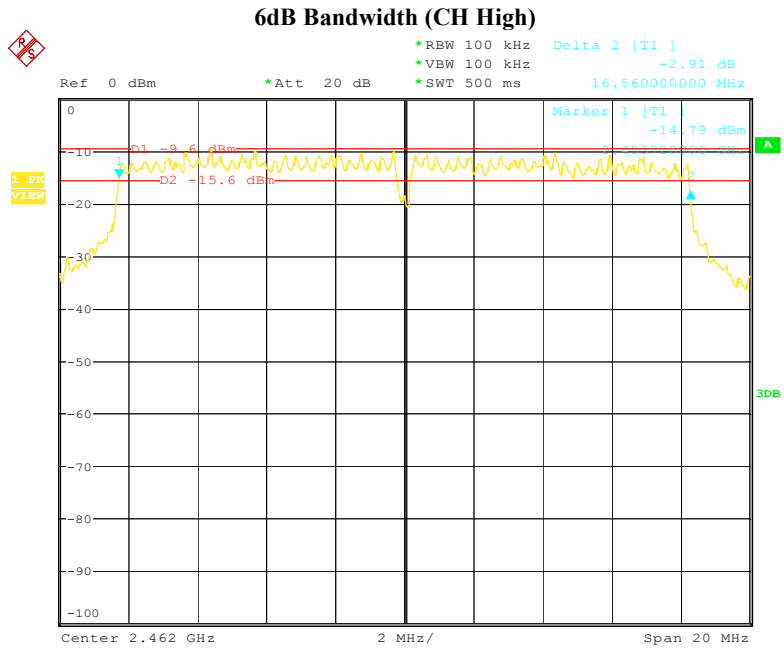

Date: 8.SEP.2008 20:47:18

B. Peak Power

Product	: USB Wireless Card	Test Mode	: IEEE 802.11b/g
Test Item	: Peak Power	Temperature	: 25 °C
Test Voltage	: DC 5V (Power by DC Power Supply)	Humidity	: 56%RH
Test Result	: PASS		

IEEE 802.11b

Channel	Frequency (MHz)	Output Power (dBm)	FCC Limit (W/dBm)	Result
Low	2412	5.60	1.00/30.00	PASS
Mid	2437	5.58		PASS
High	2462	4.98		PASS

IEEE 802.11g

Channel	Frequency (MHz)	Output Power (dBm)	FCC Limit (W/dBm)	Result
Low	2412	6.98	1.00/30.00	PASS
Mid	2437	5.89		PASS
High	2462	4.58		PASS

C. Band Edges Measurement

Product	: USB Wireless Card	Test Mode	: IEEE 802.11b/g
Test Item	: Band Edges Measurement	Temperature	: 25 °C
Test Voltage	: DC 5V (Power by DC Power Supply)	Humidity	: 56%RH
Test Result	: PASS		

IEEE 802.11b

Channel	Detector	Radiated Method Max. Field Strength of Fundamental (dBuV/m)	Conducted Method Between Carrier Max. Power and Local Max. Emission in Restrict Band(dBc)	The Max. Field Strength in Restrict Band (dBuV/m)	Limt @3m (dBuVm) Peak / Average	Margin (dB)
Low	Peak	98.36	54.73	43.63	74.00	-30.37
High	Peak	97.72	54.37	43.35	74.00	-30.65

IEEE 802.11g

Channel	Detector	Radiated Method Max. Field Strength of Fundamental (dBuV/m)	Conducted Method Between Carrier Max. Power and Local Max. Emission in Restrict Band(dBc)	The Max. Field Strength in Restrict Band (dBuV/m)	Limt @3m (dBuVm) Peak	Margin (dB)
Low	Peak	99.14	41.40	57.74	74.00	-16.26
High	Peak	96.68	41.33	55.35	74.00	-18.65

Channel	Detector	Radiated Method Max. Field Strength of Fundamental (dBuV/m)	Conducted Method Between Carrier Max. Power and Local Max. Emission in Restrict Band(dBc)	The Max. Field Strength in Restrict Band (dBuV/m)	Limt @3m (dBuVm) Average	Margin (dB)
Low	Average	92.56	45.39	47.17	54.00	-6.83
High	Average	90.05	42.03	48.02	54.00	-5.98

Note:

- (1) According to step 2 of Marker-Delta Method DA 00-705 (following plots included).
- (2) According to step 3 of Marker-Delta Method:
The Max. Field Strength in Restrict Band = Filed Strength of Fundamental – Between Carrier Max Power and Local Max. Emission in Restrict Band
- (3) The average measurement was not performed when the peak measured data under the limit of average detection. If the readings given are average, peak measurement should also be supplied.

IEEE 802.11b Channel: Low

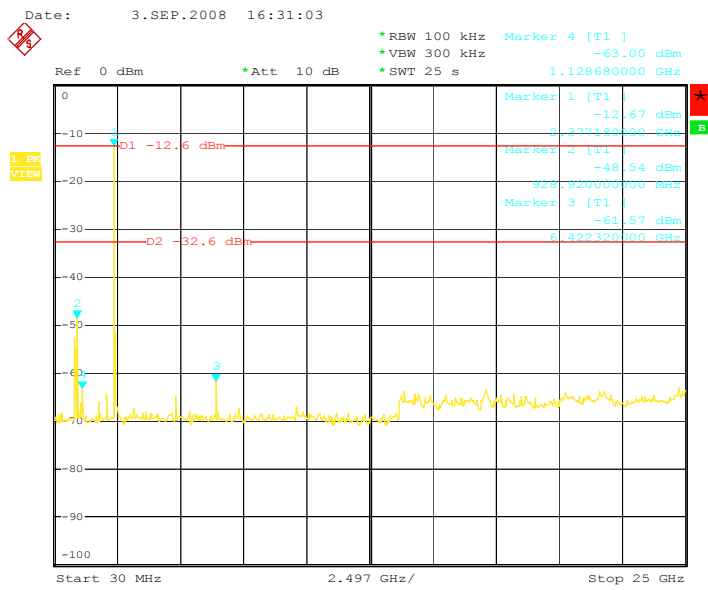
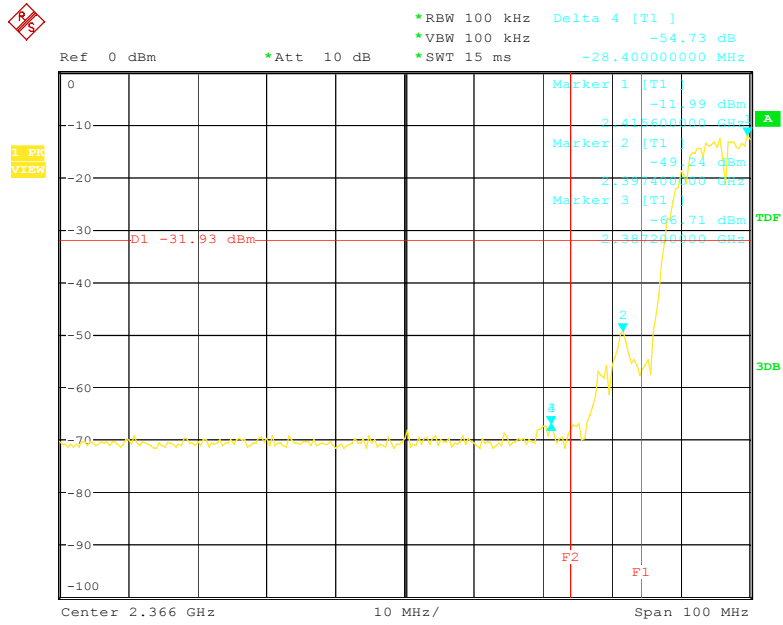

Date: 12.SEP.2008 12:19:52

IEEE 802.11b Channel: High

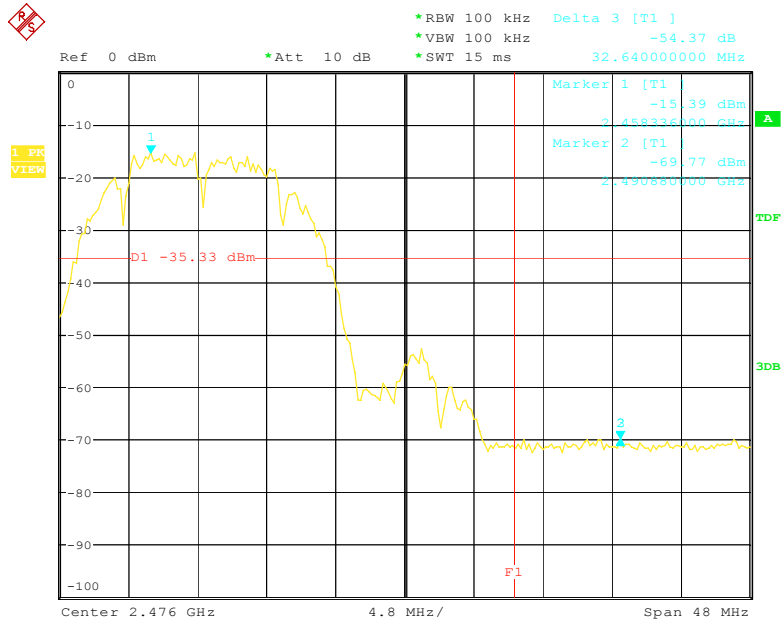

Date: 3.SEP.2008 16:53:31

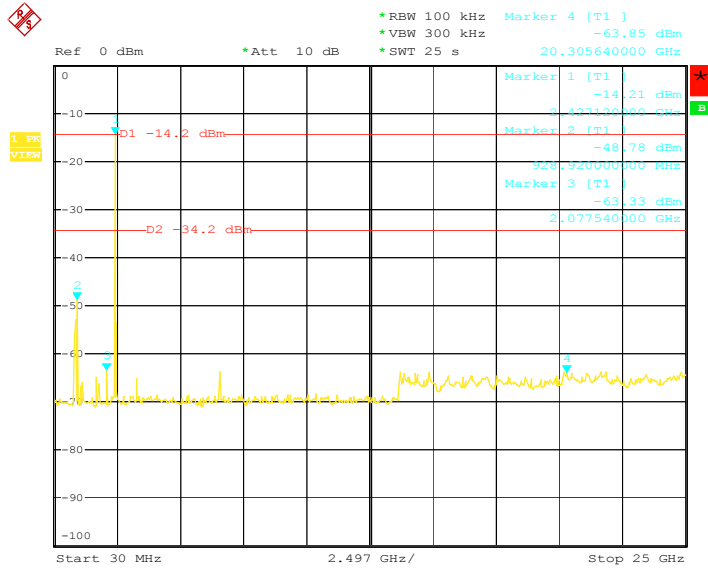

Date: 12.SEP.2008 12:29:28

IEEE 802.11g Channel: Low

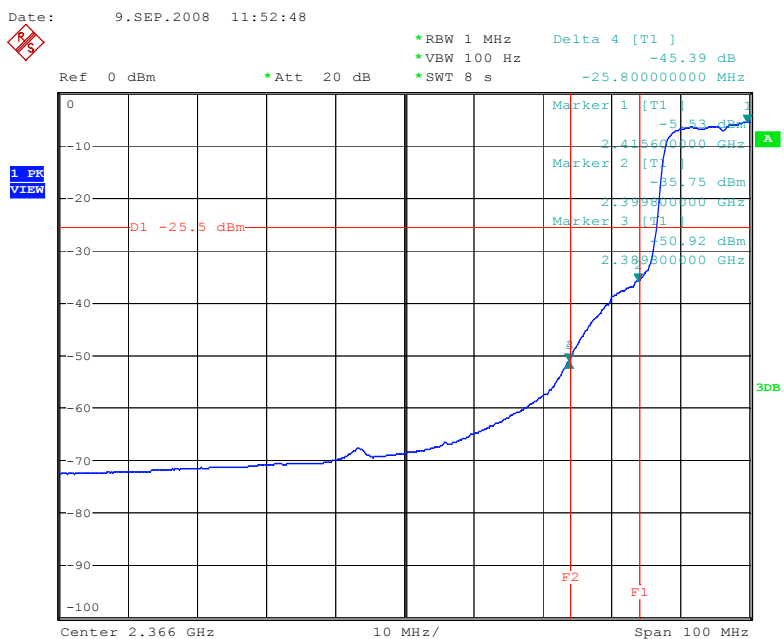
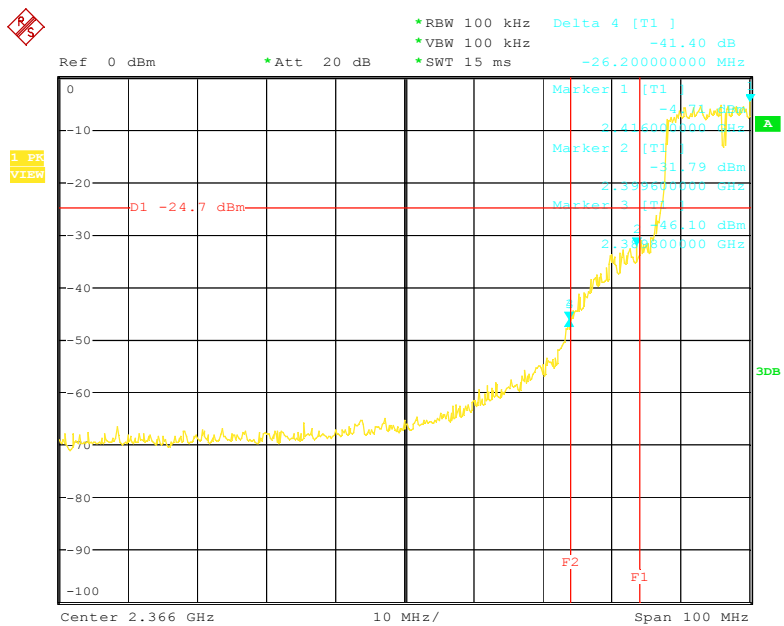

Date: 9.SEP.2008 12:14:03

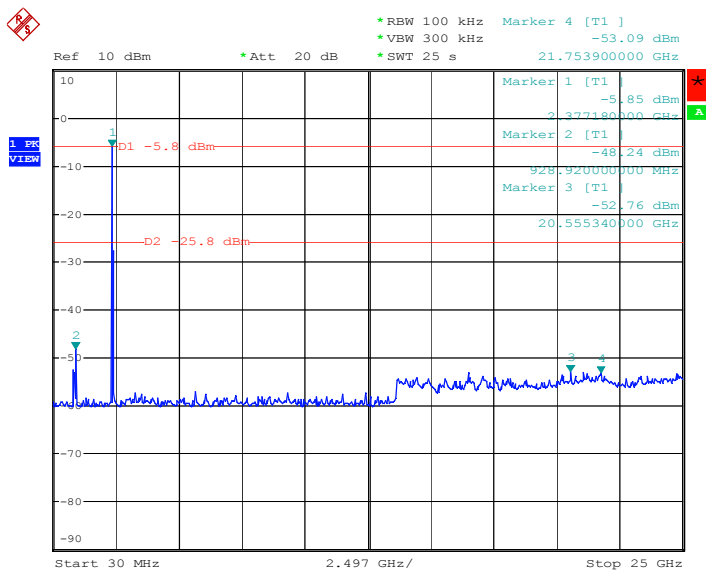

Date: 12.SEP.2008 19:30:00

IEEE 802.11g Channel: High

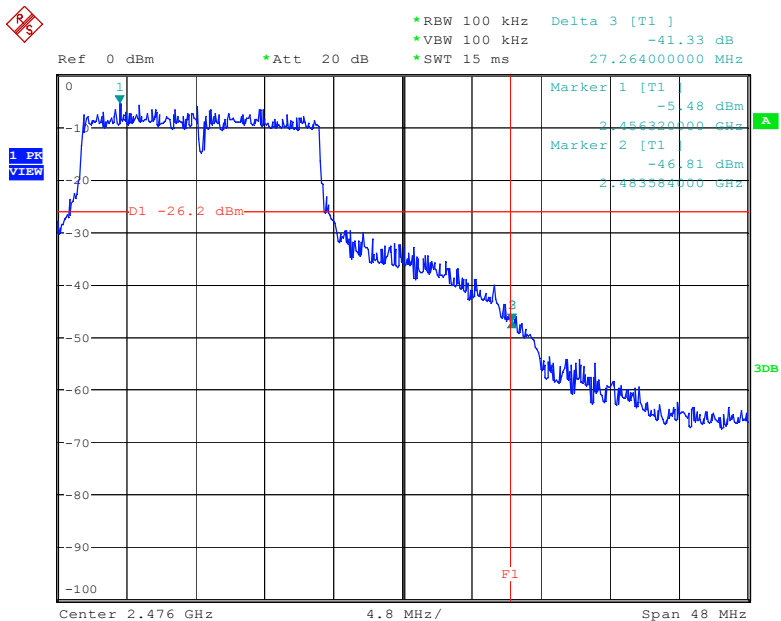

Date: 9.SEP.2008 12:23:51

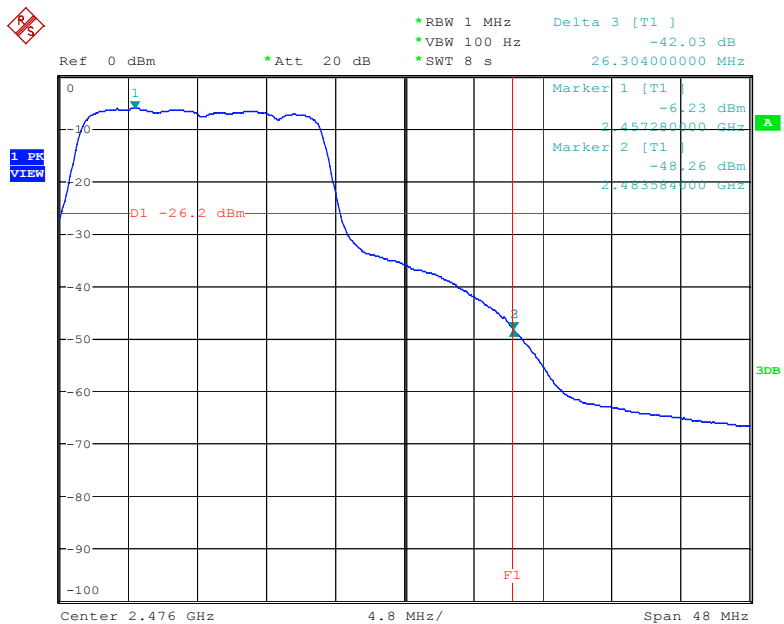

Date: 9.SEP.2008 12:19:07

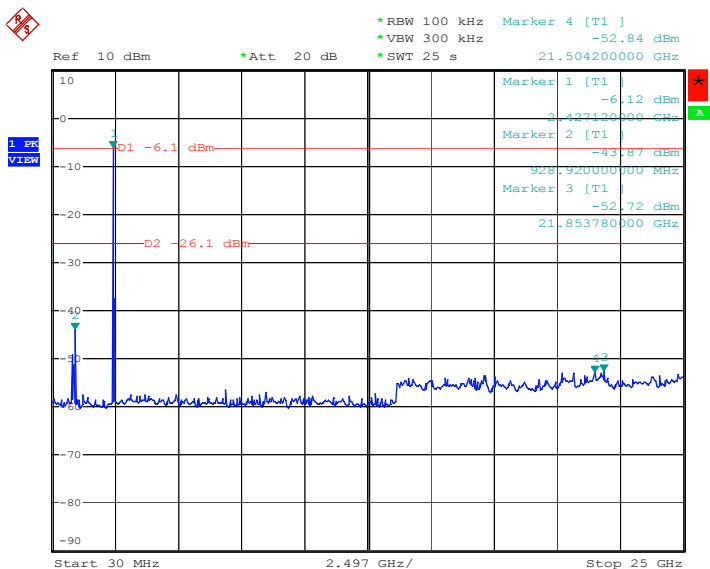

Date: 12.SEP.2008 19:18:25

D. Peak Power Spectral Density

Product	: USB Wireless Card	Test Mode	: IEEE 802.11b/g
Test Item	: Peak Power Spectral Density	Temperature	: 25 °C
Test Voltage	: DC 5V (Power by DC Power Supply)	Humidity	: 56%RH
Test Result	: PASS		

IEEE 802.11b

Channel	Frequency (MHz)	PPSD (dBm)	FCC Limit (dBm)	Result
Low	2412	-27.58	8.00	PASS
Mid	2437	-28.41		PASS
High	2462	-27.79		PASS

IEEE 802.11g

Channel	Frequency (MHz)	PPSD (dBm)	FCC Limit (dBm)	Result
Low	2412	-21.54	8.00	PASS
Mid	2437	-21.92		PASS
High	2462	-24.24		PASS

IEEE 802.11b Channel: Low

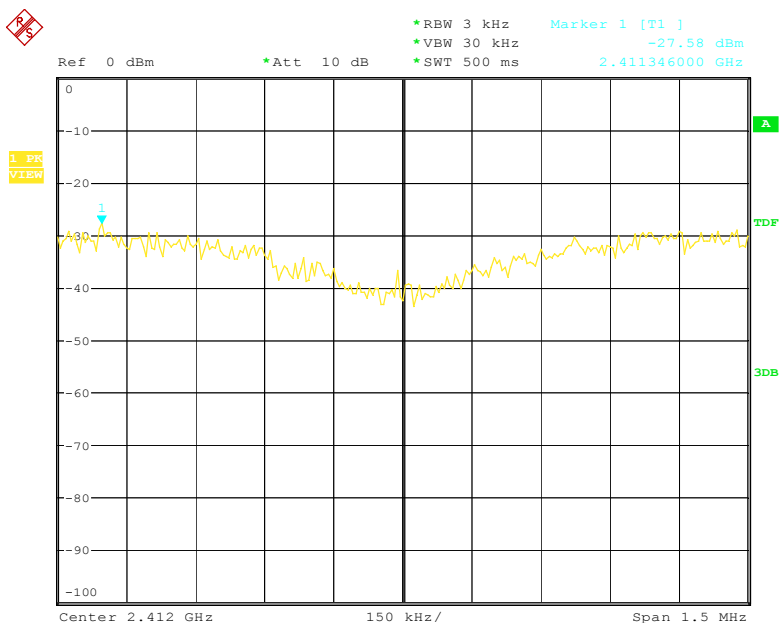

Date: 3.SEP.2008 17:58:09

IEEE 802.11b Channel: Mid

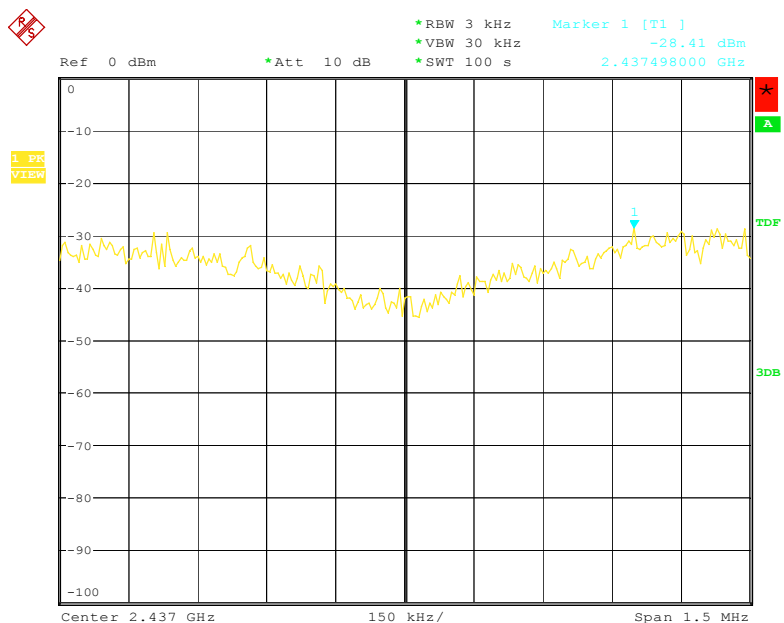

Date: 3.SEP.2008 18:06:05

IEEE 802.11b Channel: High

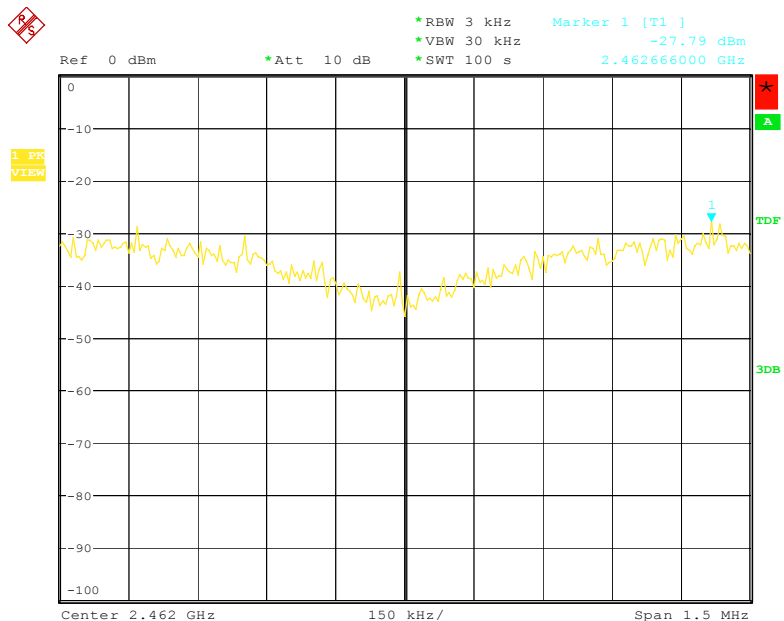

Date: 3.SEP.2008 18:11:01

IEEE 802.11g Channel: Low

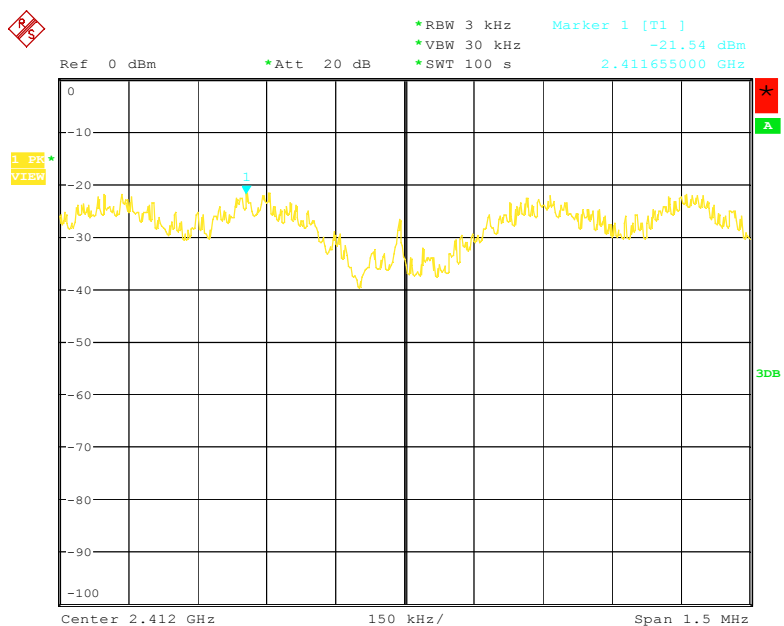

Date: 8.SEP.2008 21:18:02

IEEE 802.11g Channel: Mid

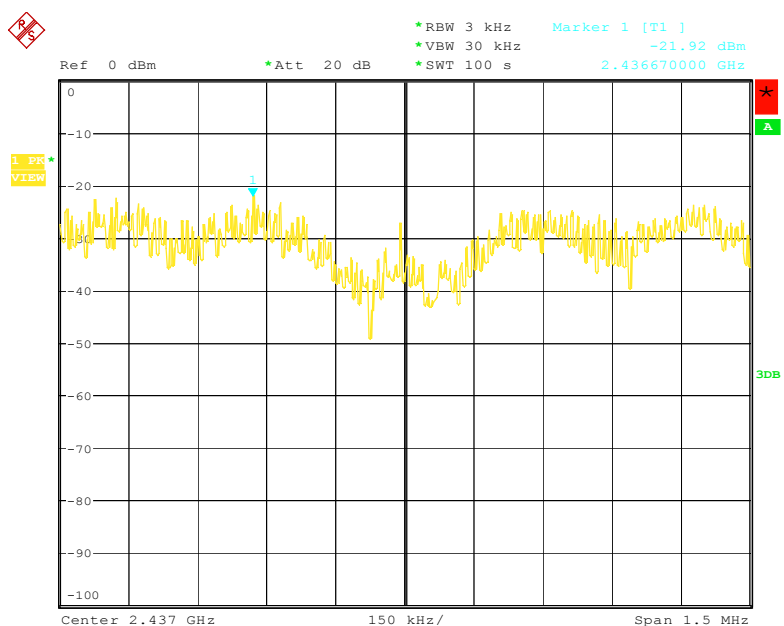

Date: 8.SEP.2008 21:12:06

IEEE 802.11g Channel: High

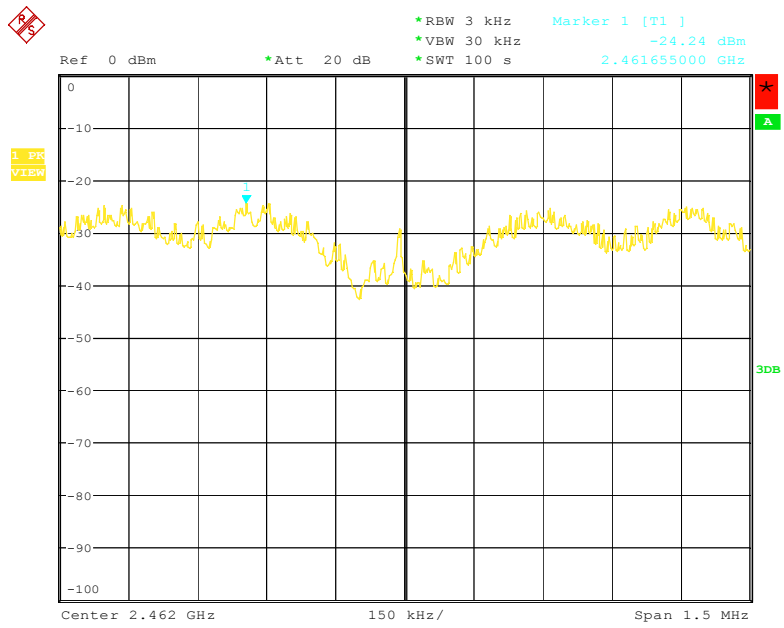

Date: 8.SEP.2008 21:22:44

6. Transmitter Spurious Radiated Emission at 3 Meters

6.1 Test Equipment

Please refer to Section 10 this report.

6.2 Test Procedure

1. The EUT was tested according to ANSI C63.4 - 2003. T
2. The EUT, peripherals were put on the turntable which table size is 1m x 1.5 m, table high 0.8 m. All set up is according to ANSI C63.4-2003.
3. The frequency spectrum from 30 MHz to 1 GHz was investigated. All readings from 30 MHz to 1 GHz are quasi-peak values with a resolution bandwidth of 120 KHz. All readings are above 1 GHz , peak values with a resolution bandwidth of 1 MHz . Measurements were made at 3 meters.
4. The antenna high is varied from 1 m to 4 m high to find the maximum emission for each frequency.
5. Maximizing procedure was performed on the six (6) highest emissions to ensure EUT compliance is with all installation combinations. All data was recorded in the peak detection mode. Quasi-peak readings was performed only when an emission was found to be marginal (within -4 dB of specification limit), and are distinguished with a "QP" in the data table.
6. The antenna polarization: Vertical polarization and Horizontal polarization.

6.3 Test Setup

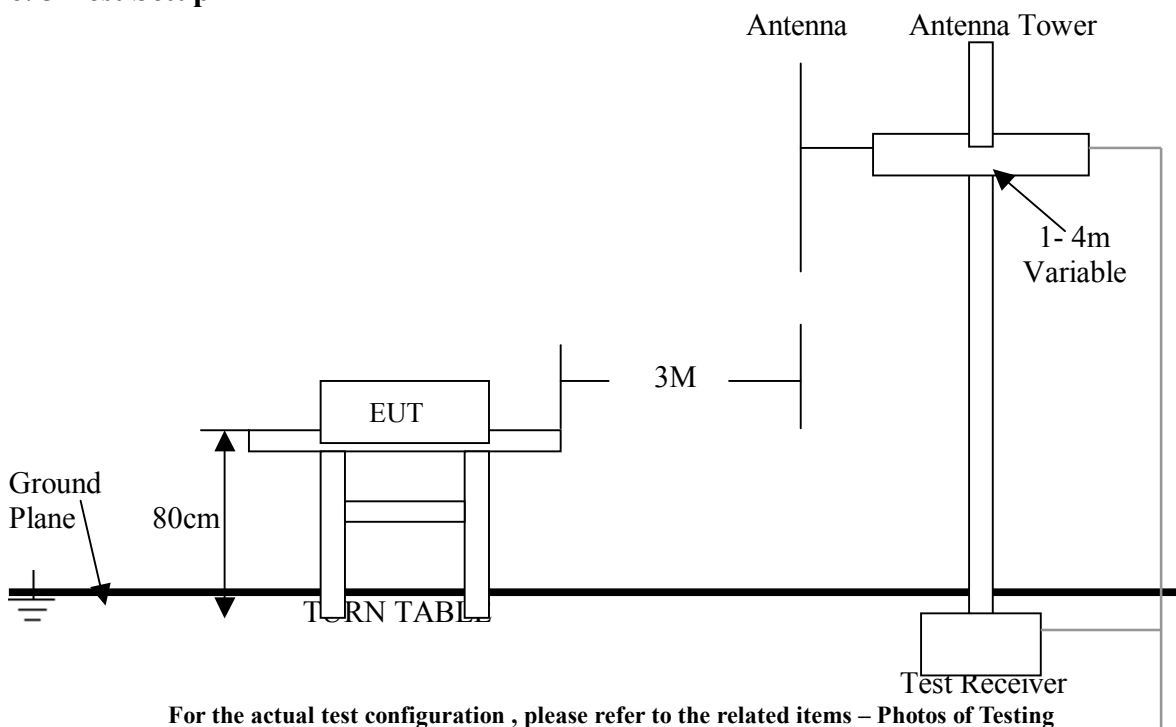

6.4 Configuration of the EUT

Same as section 4.4 of this report

6.5 EUT Operating Condition

Same as section 4.5 of this report.

6.6 Limit

In any 100 KHz bandwidth outside the operating frequency band, the radio frequency power that is produced by modulation products of the spreading sequence, the information sequence and the carrier frequency shall be either at least 20 dB below that in any 100 KHz bandwidth within the band that contains the highest level of the desired power or shall not exceed the general levels specified in section 15.209(a), which lesser attenuation.

All other emissions inside restricted bands specified in section 15.205(a) shall not exceed the general radiated emission limits specified in section 15.209(a)

Note:

Applies to harmonics/spurious emissions that fall in the restricted bands listed in section 15.205. The maximum permitted average field strength is listed in section 15.209.

47 CFR § 15.237(c): The emission limits as specified above are based on measurement instrument employing an average detector. The provisions in section 15.35 for limiting peak emissions apply.

FCC CFR 47, Part 15, Subpart C, Para, 15.205(a) – Restricted Frequency Bands

MHz	MHz	MHz	GHz
0.090–0.110	16.42–16.423	399.9–410	4.5–5.15
10.495–0.505	16.69475–16.69525	608–614	5.35–5.46
2.1735–2.1905	16.80425–16.80475	960–1240	7.25–7.75
4.125–4.128	25.5–25.67	1300–1427	8.025–8.5
4.17725–4.17775	37.5–38.25	1435–1626.5	9.0–9.2
4.20725–4.20775	73–74.6	1645.5–1646.5	9.3–9.5
6.215–6.218	74.8–75.2	1660–1710	10.6–12.7
6.26775–6.26825	108–121.94	1718.8–1722.2	13.25–13.4
6.31175–6.31225	123–138	2200–2300	14.47–14.5
8.291–8.294	149.9–150.05	2310–2390	15.35–16.2
8.362–8.366	156.52475–156.52525	2483.5–2500	17.7–21.4
8.37625–8.38675	156.7–156.9	2655–2900	22.01–23.12
8.41425–8.41475	162.0125–167.17	3260–3267	23.6–24.0
12.29–12.293	167.72–173.2	3332–3339	31.2–31.8
12.51975–12.52025	240–285	3345.8–3358	36.43–36.5
12.57675–12.57725	322–335.4	3600–4400	(2)
13.36–13.41.			

¹ Until February 1, 1999, this restricted band shall be 0.490–0.510 MHz.

² Above 38.6

FCC 47 CFR, Part 15.209(a) – Field Strength Limits within Restricted Frequency Bands

Frequency (MHz)	Field strength (microvolts/meter)	Measurement distance (meters)
0.009–0.490	2400/F(kHz)	300
0.490–1.705	24000/F(kHz)	30
1.705–30.0	30	30
30–88	100**	3
88–216	150**	3
216–960	200**	3
Above 960	500	3

6. 7 Test Result

Product : USB Wireless Card Test Mode : IEEE 802.11b/g
 Test Item : Spurious Radiated Emissions Temperature : 25 °C
 Test Voltage : DC 5V (Power by DC Power Supply) Humidity : 56%RH
 Test Result : **PASS**

IEEE 802.11b Channel: Low

Freq. (MHz)	Emission (dBuV/m) Peak Detector	HORIZ / VERT	Limits (dBuV/m) Peak / Average	Margin (dB)
4824.00	47.92	HORZ	74.0 / 54.0	-26.08
4824.00	52.44	VERT	74.0 / 54.0	-21.56
7236.00	-	HORZ	74.0 / 54.0	-
7236.00	-	VERT	74.0 / 54.0	-
9468.00	-	HORZ	74.0 / 54.0	-
9468.00	-	VERT	74.0 / 54.0	-
12060.00	-	HORZ	74.0 / 54.0	-
12060.00	-	VERT	74.0 / 54.0	-
14472.00	-	HORZ	74.0 / 54.0	-
14472.00	-	VERT	74.0 / 54.0	-
16884.00	-	HORZ	74.0 / 54.0	-
16884.00	-	VERT	74.0 / 54.0	-

IEEE 802.11b Channel: Mid

Freq. (MHz)	Emission (dBuV/m) Peak Detector	HORIZ / VERT	Limits (dBuV/m) Peak / Average	Margin (dB)
4874.00	48.72	HORZ	74.0 / 54.0	-25.28
4874.00	52.16	VERT	74.0 / 54.0	-21.84
7311.00	-	HORZ	74.0 / 54.0	-
7311.00	-	VERT	74.0 / 54.0	-
9748.00	-	HORZ	74.0 / 54.0	-
9748.00	-	VERT	74.0 / 54.0	-
12185.00	-	HORZ	74.0 / 54.0	-
12185.00	-	VERT	74.0 / 54.0	-
14622.00	-	HORZ	74.0 / 54.0	-
14622.00	-	VERT	74.0 / 54.0	-

IEEE 802.11b Channel: High

Freq. (MHz)	Emission (dBuV/m) Peak Detector	HORIZ / VERT	Limits (dBuV/m) Average	Margin (dB)
4924.00	48.68	HORZ	74.0 / 54.0	-25.32
4924.00	52.43	VERT	74.0 / 54.0	-21.57
7386.00	-	HORZ	74.0 / 54.0	-
7368.00	-	VERT	74.0 / 54.0	-
9848.00	-	HORZ	74.0 / 54.0	-
9848.00	-	VERT	74.0 / 54.0	-
12310.00	-	HORZ	74.0 / 54.0	-
12310.00	-	VERT	74.0 / 54.0	-
14772.00	-	HORZ	74.0 / 54.0	-
14722.00	-	VERT	74.0 / 54.0	-

- Note:**
- (1) All Reading Levels below 1GHz are Quasi-Peak, above are peak and average value.
 - (2) Emission Level = Reading Level + Probe Factor + Cable Loss.
 - (3) Receiver setting (Peak Detector) : RBW=1MHz; VBW=1MHz; Span=100MHz
 - (4) Receiver setting (AVG Detector): RBW=1MHz; VBW=30Hz; Span=20MHz
 - (5) The average measurement was not performed when the peak measured data under the limit of average detection. If the readings given are average, peak measurement should also be supplied.
 - (6) Where an emission level is indicated by a -, levels had a margin greater than 20 dB when compared to the limit.

IEEE 802.11g Channel: Low

Freq. (MHz)	Emission (dBuV/m) Peak / AV Detector	HORIZ / VERT	Limits (dBuV/m) Peak / Average	Margin (dB)
4824.00	52.95 / 38.92	HORZ	74.0 / 54.0	-21.05 / 15.06
4824.00	61.60 / 47.49	VERT	74.0 / 54.0	-12.40 / -6.51
7236.00	-	HORZ	74.0 / 54.0	-
7236.00	-	VERT	74.0 / 54.0	-
9468.00	-	HORZ	74.0 / 54.0	-
9468.00	-	VERT	74.0 / 54.0	-
12060.00	-	HORZ	74.0 / 54.0	-
12060.00	-	VERT	74.0 / 54.0	-
14472.00	-	HORZ	74.0 / 54.0	-
14472.00	-	VERT	74.0 / 54.0	-
16884.00	-	HORZ	74.0 / 54.0	-
16884.00	-	VERT	74.0 / 54.0	-

IEEE 802.11g Channel: Mid

Freq. (MHz)	Emission (dBuV/m) Peak / AV Detector	HORIZ / VERT	Limits (dBuV/m) Peak / Average	Margin (dB)
4874.00	51.33 / 36.74	HORZ	74.0 / 54.0	-22.67 / -17.26
4874.00	58.31 / 43.06	VERT	74.0 / 54.0	-15.89 / -10.94
7311.00	-	HORZ	74.0 / 54.0	-
7311.00	-	VERT	74.0 / 54.0	-
9748.00	-	HORZ	74.0 / 54.0	-
9748.00	-	VERT	74.0 / 54.0	-
12185.00	-	HORZ	74.0 / 54.0	-
12185.00	-	VERT	74.0 / 54.0	-
14622.00	-	HORZ	74.0 / 54.0	-
14622.00	-	VERT	74.0 / 54.0	-

IEEE 802.11g Channel: High

Freq. (MHz)	Emission (dBuV/m) Peak / AV Detector	HORIZ / VERT	Limits (dBuV/m) Peak / Average	Margin (dB)
4924.00	50.37 / 35.99	HORZ	74.0 / 54.0	-23.83 / -18.01
4924.00	56.24 / 41.23	VERT	74.0 / 54.0	-17.76 / -12.77
7386.00	-	HORZ	74.0 / 54.0	-
7368.00	-	VERT	74.0 / 54.0	-
9848.00	-	HORZ	74.0 / 54.0	-
9848.00	-	VERT	74.0 / 54.0	-
12310.00	-	HORZ	74.0 / 54.0	-
12310.00	-	VERT	74.0 / 54.0	-
14772.00	-	HORZ	74.0 / 54.0	-
14722.00	-	VERT	74.0 / 54.0	-

- Note:**
- (1) All Reading Levels below 1GHz are Quasi-Peak, above are peak and average value.
 - (2) Emission Level = Reading Level + Probe Factor + Cable Loss.
 - (3) Receiver setting (Peak Detector) : RBW=1MHz; VBW=1MHz; Span=100MHz
 - (4) Receiver setting (AVG Detector): RBW=1MHz; VBW=30Hz; Span=20MHz
 - (5) The average measurement was not performed when the peak measured data under the limit of average detection. If the readings given are average, peak measurement should also be supplied.
 - (6) Where an emission level is indicated by a -, levels had a margin greater than 20 dB when compared to the limit.

7. RF Exposure Requirements

7.1 Test Equipment

Please refer to Section 10 this report.

7.2 Limit

According to FCC 15.247(i), Systems operating under provisions of this section shall be operated in a manner that ensures that the public is not exposed to radio frequency energy levels in excess of the Commissions guidelines.

FCC 1.1310: The criteria listed in the following table shall be used to evaluate the environmental impact of human exposure to radio-frequency (RF) radiation as specified in 1.1307(b)(1) of this chapter.

TABLE 1—LIMITS FOR MAXIMUM PERMISSIBLE EXPOSURE (MPE)

Frequency range (MHz)	Electric field strength (V/m)	Magnetic field strength (A/m)	Power density (mW/cm ²)	Averaging time (minutes)
(A) Limits for Occupational/Controlled Exposures				
0.3–3.0	614	1.63	*(100)	6
3.0–30	1842/f	4.89/f	*(900/f ²)	6
30–300	61.4	0.163	1.0	6
300–1500			f/300	6
1500–100,000			5	6
(B) Limits for General Population/Uncontrolled Exposure				
0.3–1.34	614	1.63	*(100)	30
1.34–30	824/f	2.19/f	*(180/f ²)	30
30–300	27.5	0.073	0.2	30
300–1500			f/1500	30
1500–100,000			1.0	30

f = frequency in MHz

* = Plane-wave equivalent power density

NOTE 1 TO TABLE 1: Occupational/controlled limits apply in situations in which persons are exposed as a consequence of their employment provided those persons are fully aware of the potential for exposure and can exercise control over their exposure. Limits for occupational/controlled exposure also apply in situations when an individual is transient through a location where occupational/controlled limits apply provided he or she is made aware of the potential for exposure.

NOTE 2 TO TABLE 1: General population/uncontrolled exposures apply in situations in which the general public may be exposed, or in which persons that are exposed as a consequence of their employment may not be fully aware of the potential for exposure or can not exercise control over their exposure.

7.3 Test Result

Product	: USB Wireless Card	Test Mode	: IEEE 802.11b/g
Test Item	: RF Exposure	Temperature	: 25 °C
Test Voltage	: DC 5V (Power by DC Power Supply)	Humidity	: 56%RH
Test Result	: PASS		

Evaluation of RF Exposure Compliance Requirements	
MPE Prediction of MPE according to equation from page 19 of OET Bulletin 65, Edition 97-01	
RF Exposure Requirements	Compliance with FCC Rules
S=PG/4πR ² Where: S=Power density P=Power input to antenna G=Power gain of the antenna relative to an isotropic radiator R=Distance to the center of radiation of the antenna	Maximum output power at antenna input terminal: 6.98 dBm = 4.989 mW Prediction distance: 20 cm Antenna gain : 2.0dBi Prediction frequency: 2462MHz MPE limit for uncontrolled exposure at prediction frequency: 1.0 mW/cm ² Power density at 20 cm: Antenna: 0.00199 mW/cm ²

8. Photos of Testing

8.1 EUT Test Photographs

Radiated emission test view



8. 2 EUT Detailed Photographs

EUT top view



EUT bottom view



EUT inside whole view

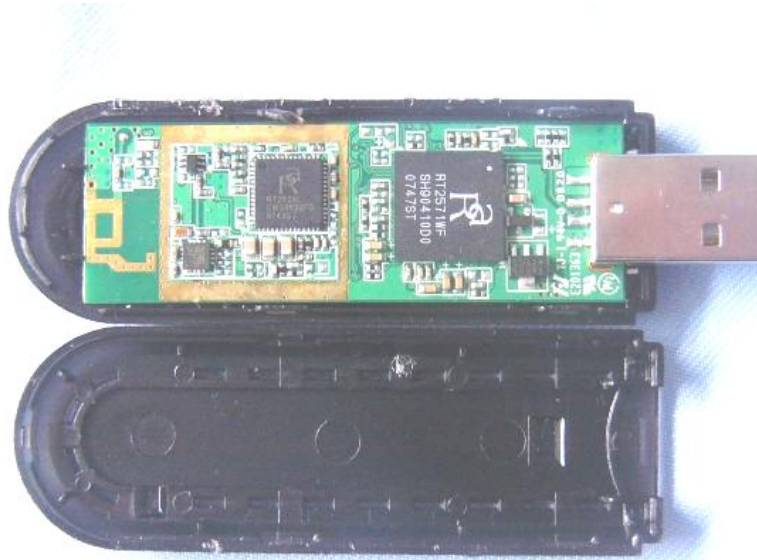

Main & RF board component side

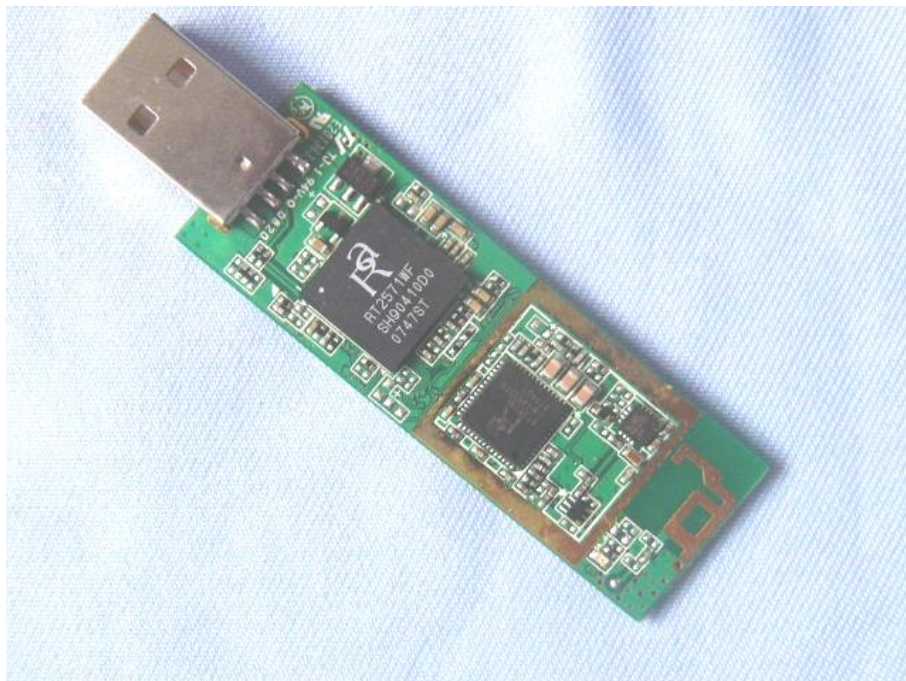

Main & RF board solder side

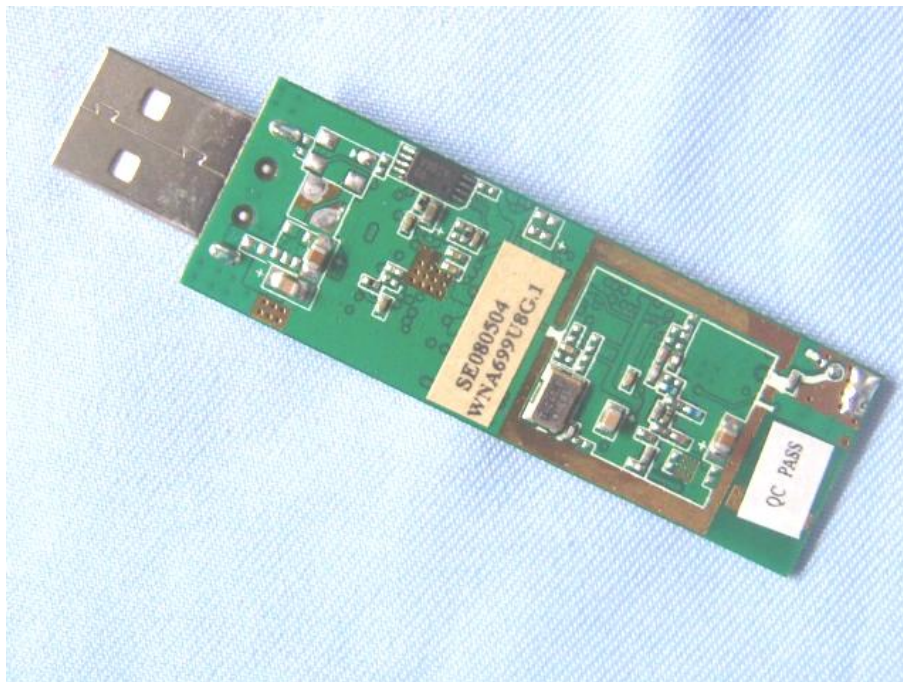

9. FCC ID Label

FCC ID: V4VWNA699U8G1

This device complies with Part 15 of the FCC Rules. Operation is subject to the following two conditions: (1) this device may not cause harmful interference, and (2) this device must accept any interference received, including interference that may cause undesired operation.

The Label must not be a stick-on paper label. The Label on these products must be permanently affixed to the product and readily visible at the time of purchase and must last the expected lifetime of the equipment not be readily detachable.

Proposed Label Location on EUT

EUT Bottom View/Proposed FCC ID Label Location



10. Test Equipment

The following test equipments were used during the radiated & conducted emission test:

Equipment/ Facilities	Manufacturer	Model #	Serial No.	Date of Cal.	Due Date
Turntable	SinTek	N/A	N/A	NCR	NCR
Antenna Tower	SinTek	N/A	N/A	NCR	NCR
OATS	SinTek	N/A	N/A	Oct. 9, 2007	Oct. 9, 2010
EMI Test Receiver	Rohde & Schwarz	ESPI7	100013	July 9, 2008	July 9, 2009
Spectrum Analyzer	Rohde & Schwarz	FSP40	100273	Sep.18, 2007	Sep.18, 2008
Signal Generator	FLUKE	PM5418+Y/C	LO747012	Feb.10, 2008	Feb.10, 2009
Signal Generator	FLUKE	PM5418TX	LO738007	Feb.10, 2008	Feb.10, 2009
Loop Antenna	SCHWARZBECK	FMZB1516	113	Jan. 30, 2008	Jan. 30, 2009
Loop Antenna	Rohde & Schwarz	HFH2-Z2	872096/16	Jan. 30, 2008	Jan. 30, 2009
Trilog-Super Broadband Antenna	SCHWARZBECK	VULB9161	9161-4079	Sep.18, 2007	Sep.18, 2008
Trilog-Super Broadband Antenna	SCHWARZBECK	VULB9161	9161-4080	Sep.18, 2007	Sep.18, 2008
Broad-Band Horn Antenna	SCHWARZBECK	BBHA 9120D	9120D-564	Sep.18, 2007	Sep.18, 2008
Broad-Band Horn Antenna	SCHWARZBECK	BBHA 9120D	9120D-565	Sep.18, 2007	Sep.18, 2008
AMN	Rohde & Schwarz	ESH3-Z5	100196	Oct. 23, 2007	Oct. 23, 2008
AMN	Rohde & Schwarz	ESH3-Z5	100197	Oct. 23, 2007	Oct. 23, 2008
Pulse Limiter	Rohde & Schwarz	ESH3-Z2	N/A	N/A	N/A
Absorbing Clamp	Rohde & Schwarz	MDS-21	N/A	Oct. 29, 2007	Oct. 29, 2008
KMO Shielded Room	KMO	KMO-001	N/A	N/A	N/A
Coaxial Cable with N-Connectors	SCHWARZBECK	AK9515H	95549	Sep.18, 2007	Sep.18, 2008
Power Meter	Rohde & Schwarz	NRVD	100041	Feb.10, 2008	Feb.10, 2009
Radio Communication Test Set	Rohde & Schwarz	CMS 54	846621/024	Feb.10, 2008	Feb.10, 2009
Modulation Analyzer	Hewlett-Packard	8901B	2303A00362	Feb.10, 2008	Feb.10, 2009
Communication Analyzer	Wavetek Stabilock	4032	N/A	Feb. 01, 2008	Feb.01, 2009
Storage Oscilloscope	Tektronix	TDS3052	N/A	Feb. 01, 2008	Feb.01, 2009
Attenuator	Schwarzbeck	20dB	N/A	Feb. 01, 2008	Feb.01, 2009
Attenuator	Rohde & Schwarz	10dB	N/A	Feb. 01, 2008	Feb.01, 2009
SOHO Telephone Switching System	IKE	2000-108C	N/A	Feb.10, 2008	Feb.10, 2009
Temperature Chamber	TABAI	PSL-4GTW	N/A	Feb.10, 2008	Feb.10, 2009