



FCC TEST REPORT

REPORT NO.: RF990128L06
MODEL NO.: Gaw9.5Z97-4
RECEIVED: Jan. 28, 2010
TESTED: Feb. 12 ~ Mar. 01, 2010
ISSUED: Mar. 02, 2010

APPLICANT: Shenzhen Gongjin Electronics Co., Ltd

ADDRESS: A211-A213, B201-B210, 2F Baiying Building,
1019# Nanhai RD, Shekou, Shenzhen,
Guangdong, China. 518067

ISSUED BY: Bureau Veritas Consumer Products Services
(H.K.) Ltd., Taoyuan Branch

LAB ADDRESS: No. 47, 14th Ling, Chia Pau Tsuen, Lin Kou
Hsiang, Taipei Hsien 244, Taiwan, R.O.C.

TEST LOCATION: No. 19, Hwa Ya 2nd Rd, Wen Hwa Tsuen, Kwei
Shan Hsiang, Taoyuan Hsien 333, Taiwan,
R.O.C.

This test report consists of 59 pages in total. It may be duplicated completely for legal use with the approval of the applicant. It should not be reproduced except in full, without the written approval of our laboratory. The client should not use it to claim product endorsement by TAF or any government agencies. The test results in the report only apply to the tested sample.





TABLE OF CONTENTS

1.	CERTIFICATION	4
2.	SUMMARY OF TEST RESULTS	5
2.1	MEASUREMENT UNCERTAINTY	5
3.	GENERAL INFORMATION	6
3.1	GENERAL DESCRIPTION OF EUT	6
3.2	DESCRIPTION OF TEST MODES	8
3.2.1	CONFIGURATION OF SYSTEM UNDER TEST	8
3.2.2	TEST MODE APPLICABILITY AND TESTED CHANNEL DETAIL	9
3.3	GENERAL DESCRIPTION OF APPLIED STANDARDS	11
3.4	DESCRIPTION OF SUPPORT UNITS	11
4.	TEST TYPES AND RESULTS	12
4.1	RADIATED EMISSION MEASUREMENT	12
4.1.1	LIMITS OF RADIATED EMISSION MEASUREMENT	12
4.1.2	TEST INSTRUMENTS	13
4.1.3	TEST PROCEDURES	14
4.1.4	DEVIATION FROM TEST STANDARD	14
4.1.5	TEST SETUP	15
4.1.6	EUT OPERATING CONDITIONS	15
4.1.7	TEST RESULTS	16
4.2	CONDUCTED EMISSION MEASUREMENT	26
4.2.1	LIMITS OF CONDUCTED EMISSION MEASUREMENT	26
4.2.2	TEST INSTRUMENTS	26
4.2.3	TEST PROCEDURES	27
4.2.4	DEVIATION FROM TEST STANDARD	27
4.2.5	TEST SETUP	28
4.2.6	EUT OPERATING CONDITIONS	28
4.2.7	TEST RESULTS	29
4.3	6dB BANDWIDTH MEASUREMENT	37
4.3.1	LIMITS OF 6dB BANDWIDTH MEASUREMENT	37
4.3.2	TEST INSTRUMENTS	37
4.3.3	TEST PROCEDURE	37
4.3.4	DEVIATION FROM TEST STANDARD	37
4.3.5	TEST SETUP	38
4.3.6	EUT OPERATING CONDITIONS	38
4.3.7	TEST RESULTS	39



4.4	MAXIMUM OUTPUT POWER.....	41
4.4.1	LIMITS OF MAXIMUM OUTPUT POWER MEASUREMENT	41
4.4.2	INSTRUMENTS	41
4.4.3	TEST PROCEDURES.....	41
4.4.4	DEVIATION FROM TEST STANDARD	41
4.4.5	TEST SETUP	42
4.4.6	EUT OPERATING CONDITIONS.....	42
4.4.7	TEST RESULTS	43
4.5	POWER SPECTRAL DENSITY MEASUREMENT	44
4.5.1	LIMITS OF POWER SPECTRAL DENSITY MEASUREMENT	44
4.5.2	TEST INSTRUMENTS	44
4.5.3	TEST PROCEDURE	44
4.5.4	DEVIATION FROM TEST STANDARD	44
4.5.5	TEST SETUP	45
4.5.6	EUT OPERATING CONDITION	45
4.5.7	TEST RESULTS	46
4.6	BAND EDGES MEASUREMENT	48
4.6.1	LIMITS OF BAND EDGES MEASUREMENT	48
4.6.2	TEST INSTRUMENTS	48
4.6.3	TEST PROCEDURE	48
4.6.4	DEVIATION FROM TEST STANDARD	48
4.6.5	EUT OPERATING CONDITION	48
4.6.6	TEST RESULTS	49
5.	PHOTOGRAPHS OF THE TEST CONFIGURATION	57
6.	INFORMATION ON THE TESTING LABORATORIES.....	58
7.	APPENDIX A - MODIFICATIONS RECORDERS FOR ENGINEERING CHANGES TO THE EUT BY THE LAB.....	59



1. CERTIFICATION

PRODUCT: 802.11b/g Wireless ADSL 2/2+ Router
MODEL: Gaw9.5Z97-4
BRAND: T&W
APPLICANT: Shenzhen Gongjin Electronics Co., Ltd
TESTED: Feb. 12 ~ Mar. 01, 2010
TEST SAMPLE: ENGINEERING SAMPLE
STANDARDS: FCC Part 15, Subpart C (Section 15.247)
ANSI C63.4-2003

The above equipment (model: Gaw9.5Z97-4) has been tested by **Bureau Veritas Consumer Products Services (H.K.) Ltd., Taoyuan Branch**, and found compliance with the requirement of the above standards. The test record, data evaluation & Equipment Under Test (EUT) configurations represented herein are true and accurate accounts of the measurements of the sample's EMC characteristics under the conditions specified in this report.

PREPARED BY : Polly Chien , **DATE** : Mar. 02, 2010
Polly Chien / Specialist

TECHNICAL ACCEPTANCE : Long Chen , **DATE** : Mar. 02, 2010
Responsible for RF Long Chen / Senior Engineer

APPROVED BY : Gary Chang , **DATE** : Mar. 02, 2010
Gary Chang / Assistant Manager

2. SUMMARY OF TEST RESULTS

The EUT has been tested according to the following specifications:

APPLIED STANDARD: FCC Part 15, Subpart C			
Standard Section	Test Type and Limit	Result	Remark
15.207	AC Power Conducted Emission	PASS	Meet the requirement of limit. Minimum passing margin is -3.34dB at 0.189MHz.
15.247(a)(2)	Spectrum Bandwidth of a Direct Sequence Spread Spectrum System Limit: min. 500kHz	PASS	Meet the requirement of limit.
15.247(b)	Maximum Output Power Limit: max. 30dBm	PASS	Meet the requirement of limit.
15.247(d)	Radiated Emissions Limit: Table 15.209	PASS	Meet the requirement of limit. Minimum passing margin is -1.1dB at 333.21MHz.
15.247(e)	Power Spectral Density Limit: max. 8dBm	PASS	Meet the requirement of limit.
15.247(d)	Band Edge Measurement Limit: 20dB less than the peak value of fundamental frequency	PASS	Meet the requirement of limit.
15.203	Antenna Requirement	PASS	No antenna connector is used.

2.1 MEASUREMENT UNCERTAINTY

Where relevant, the following measurement uncertainty levels have been estimated for tests performed on the EUT as specified in CISPR 16-4-2:

MEASUREMENT	FREQUENCY	UNCERTAINTY
Conducted emissions	150kHz ~ 30MHz	2.44 dB
Radiated emissions	30MHz ~ 200MHz	3.19 dB
	200MHz ~ 1000MHz	3.21 dB
	1GHz ~ 18GHz	2.26 dB
	18GHz ~ 40GHz	1.94 dB

This uncertainty represents an expanded uncertainty expressed at approximately the 95% confidence level using a coverage factor of k=2.



3. GENERAL INFORMATION

3.1 GENERAL DESCRIPTION OF EUT

PRODUCT	802.11b/g Wireless ADSL 2/2+ Router
MODEL NO.	Gaw9.5Z97-4
FCC ID	V4VGAW95Z97-4
POWER SUPPLY	12Vdc
MODULATION TYPE	CCK, DQPSK, DBPSK for DSSS 64QAM, 16QAM, QPSK, BPSK for OFDM
MODULATION TECHNOLOGY	DSSS, OFDM
TRANSFER RATE	802.11b: 11.0/ 5.5/ 2.0/ 1.0Mbps 802.11g: 54.0/ 48.0/ 36.0/ 24.0/ 18.0/ 12.0/ 9.0/ 6.0Mbps
OPERATING FREQUENCY	2412MHz ~ 2462MHz
NUMBER OF CHANNEL	11
MAXIMUM OUTPUT POWER	223.9mW
ANTENNA TYPE	Omni-directional antenna with 5dBi gain
ANTENNA CONNECTOR	NA
DATA CABLE	NA
I/O PORTS	RJ45, RJ11
ACCESSORY DEVICES	AC Adapter

NOTE:

1. The EUT was powered by the following adapters:

Adapter 1	
BRAND:	RUIDE
MODEL:	RD1201000-C55-0MG
INPUT:	100-240Vac, 50/60Hz, 0.6A
OUTPUT:	12Vdc, 1A
POWER LINE:	1.5 m non-shielded cable without core

Adapter 2	
BRAND:	RUIDE
MODEL:	RD1200800-C55-2MG
INPUT:	100-240Vac, 50/60Hz, 0.6A
OUTPUT:	12Vdc, 800mA
POWER LINE:	1.5m non-shielded cable without core

Adapter 3	
BRAND:	Moso
MODEL:	XKD-C1000IC12.0-12W
INPUT:	100-240Vac, 50/60Hz, 0.5A
OUTPUT:	12Vdc, 1A
POWER LINE:	1.5m non-shielded cable without core

Adapter 4	
BRAND:	Moso
MODEL:	XKD-C0800IC12.0-12W
INPUT:	100-240Vac, 50/60Hz, 0.5A
OUTPUT:	12Vdc, 800mA
POWER LINE:	1.5m non-shielded cable without core

2. The EUT, operates in the 2.4GHz frequency range, lets you connect IEEE 802.11g or IEEE 802.11b devices to the network. With its high-speed data transmissions of up to 54Mbps.
3. The above EUT information was declared by manufacturer and for more detailed features description, please refer to the manufacturer's specifications or user's manual.

3.2 DESCRIPTION OF TEST MODES

Eleven channels are provided for 802.11b and 802.11g:

CHANNEL	FREQUENCY	CHANNEL	FREQUENCY
1	2412MHz	7	2442MHz
2	2417MHz	8	2447MHz
3	2422MHz	9	2452MHz
4	2427MHz	10	2457MHz
5	2432MHz	11	2462MHz
6	2437MHz		

3.2.1 CONFIGURATION OF SYSTEM UNDER TEST

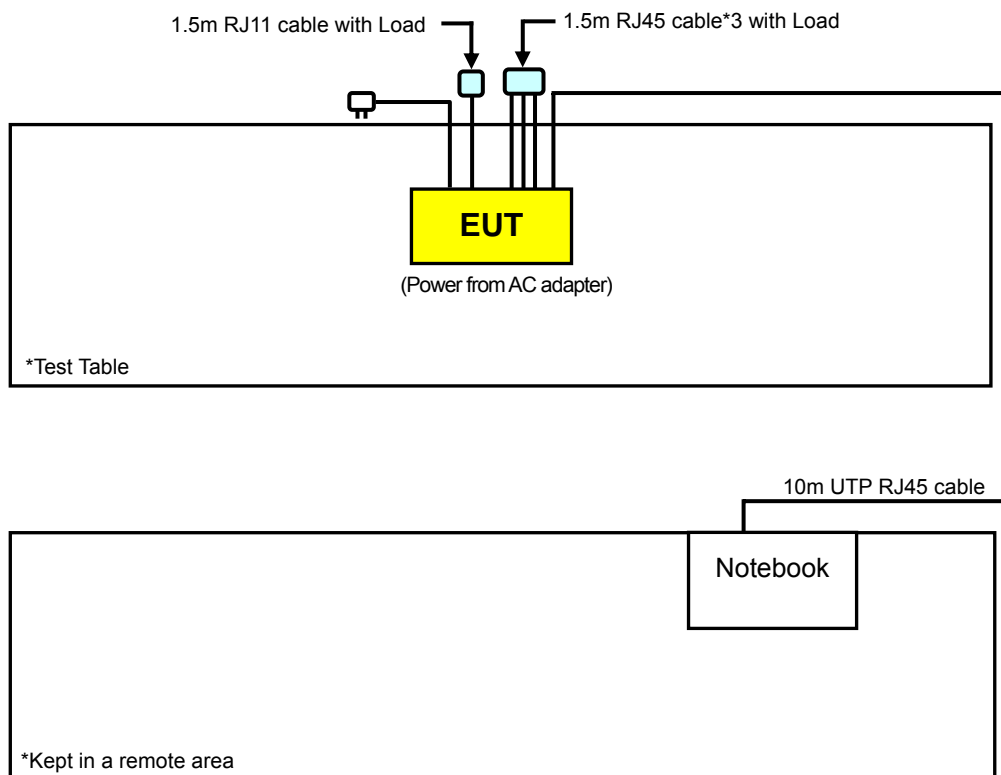

3.2.2 TEST MODE APPLICABILITY AND TESTED CHANNEL DETAIL

EUT CONFIGURE MODE	APPLICABLE TO				DESCRIPTION
	RE \geq 1G	RE<1G	PLC	APCM	
A	-	√	√	-	Power from adapter model 1: RD1201000-C55-0MG
B	√	√	√	√	Power from adapter model 2: RD1200800-C55-2MG
C	-	√	√	-	Power from adapter model 3: XKD-C1000IC12.0-12W
D	-	√	√	-	Power from adapter model 4: XKD-C0800IC12.0-12W

Where **PLC**: Power Line Conducted Emission
RE \geq 1G: Radiated Emission above 1GHz

RE<1G: Radiated Emission below 1GHz
APCM: Antenna Port Conducted Measurement

NOTE: "-" means no effect.

RADIATED EMISSION TEST (ABOVE 1 GHz):

- Pre-Scan has been conducted to determine the worst-case mode from all possible combinations between available modulations, data rates, XYZ axis and antenna ports (if EUT with antenna diversity architecture).
- Following channel(s) was (were) selected for the final test as listed below.

EUT CONFIGURE MODE	MODE	AVAILABLE CHANNEL	TESTED CHANNEL	MODULATION TECHNOLOGY	MODULAT ION TYPE	DATA RATE (Mbps)	ANT. AXIS
B	802.11b	1 to 11	1, 6, 11	DSSS	DBPSK	1.0	X
B	802.11g	1 to 11	1, 6, 11	OFDM	BPSK	6.0	X

RADIATED EMISSION TEST (BELOW 1 GHz):

- Pre-Scan has been conducted to determine the worst-case mode from all possible combinations between available modulations, data rates, XYZ axis and antenna ports (if EUT with antenna diversity architecture).
- Following channel(s) was (were) selected for the final test as listed below.

EUT CONFIGURE MODE	MODE	AVAILABLE CHANNEL	TESTED CHANNEL	MODULATION TECHNOLOGY	MODULAT ION TYPE	DATA RATE (Mbps)	ANT. AXIS
A, B, C, D	802.11g	1 to 11	1	OFDM	BPSK	6.0	X

POWER LINE CONDUCTED EMISSION TEST:

- Pre-Scan has been conducted to determine the worst-case mode from all possible combinations between available modulations, data rates and antenna ports (if EUT with antenna diversity architecture).
- Following channel(s) was (were) selected for the final test as listed below.

EUT CONFIGURE MODE	MODE	AVAILABLE CHANNEL	TESTED CHANNEL	MODULATION TECHNOLOGY	MODULATION TYPE	DATA RATE (Mbps)
A, B, C, D	802.11g	1 to 11	1	OFDM	BPSK	6.0

BANDEDGE MEASUREMENT:

- Pre-Scan has been conducted to determine the worst-case mode from all possible combinations between available modulations, data rates, XYZ axis and antenna ports (if EUT with antenna diversity architecture).
- Following channel(s) was (were) selected for the final test as listed below.

EUT CONFIGURE MODE	MODE	AVAILABLE CHANNEL	TESTED CHANNEL	MODULATION TECHNOLOGY	MODULATION TYPE	DATA RATE (Mbps)
B	802.11b	1 to 11	1, 11	DSSS	DBPSK	1.0
B	802.11g	1 to 11	1, 11	OFDM	BPSK	6.0

ANTENNA PORT CONDUCTED MEASUREMENT:

- This item includes all test value of each mode, but only includes spectrum plot of worst value of each mode.
- Pre-Scan has been conducted to determine the worst-case mode from all possible combinations between available modulations, data rates and antenna ports (if EUT with antenna diversity architecture).
- Following channel(s) was (were) selected for the final test as listed below.

EUT CONFIGURE MODE	MODE	AVAILABLE CHANNEL	TESTED CHANNEL	MODULATION TECHNOLOGY	MODULATION TYPE	DATA RATE (Mbps)
B	802.11b	1 to 11	1, 6, 11	DSSS	DBPSK	1.0
B	802.11g	1 to 11	1, 6, 11	OFDM	BPSK	6.0

TEST CONDITION:

APPLICABLE TO	ENVIRONMENTAL CONDITIONS	INPUT POWER	TESTED BY
RE \geq 1G	24deg. C, 64%RH, 1016 hPa	120Vac, 60Hz	Match Tsui
RE<1G	25deg. C, 70%RH, 1012 hPa	120Vac, 60Hz	Lori Chiu
PLC	24deg. C, 64%RH, 1014 hPa	120Vac, 60Hz	Match Tsui
APCM	24deg. C, 64%RH, 1016 hPa	120Vac, 60Hz	Match Tsui

3.3 GENERAL DESCRIPTION OF APPLIED STANDARDS

The EUT is a RF product. According to the specifications of the manufacturer, it must comply with the requirements of the following standards:

FCC Part 15, Subpart C (15.247)

ANSI C63.4-2003

All test items have been performed and recorded as per the above standards.

NOTE: The EUT is also considered as a kind of computer peripheral, because the connection to computer is necessary for typical use. It has been verified to comply with the requirements of FCC Part 15, Subpart B, Class B (DoC). The test report has been issued separately.

3.4 DESCRIPTION OF SUPPORT UNITS

The EUT has been tested as an independent unit together with other necessary accessories or support units. The following support units or accessories were used to form a representative test configuration during the tests.

NO.	PRODUCT	BRAND	MODEL NO.	SERIAL NO.	FCC ID
1	NOTEBOOK	DELL	D830	10026042688	NA

NO.	SIGNAL CABLE DESCRIPTION OF THE ABOVE SUPPORT UNITS
1	10m UTP RJ45 cable.

NOTE: 1. All power cords of the above support units are non shielded (1.8m).
2. Item 1 acted as a communication partner to transfer data.

4. TEST TYPES AND RESULTS

4.1 RADIATED EMISSION MEASUREMENT

4.1.1 LIMITS OF RADIATED EMISSION MEASUREMENT

Emissions radiated outside of the specified bands, shall be according to the general radiated limits in 15.209 as following:

FREQUENCIES (MHz)	FIELD STRENGTH (microvolts/meter)	MEASUREMENT DISTANCE (meters)
0.009 ~ 0.490	2400 / F(kHz)	300
0.490 ~ 1.705	24000 / F(kHz)	30
1.705 ~ 30.0	30	30
30 ~ 88	100	3
88 ~ 216	150	3
216 ~ 960	200	3
Above 960	500	3

NOTE:

1. The lower limit shall apply at the transition frequencies.
2. Emission level (dBuV/m) = 20 log Emission level (uV/m).
3. As shown in 15.35(b), for frequencies above 1000MHz, the field strength limits are based on average detector, however, the peak field strength of any emission shall not exceed the maximum permitted average limits, specified above by more than 20dB under any condition of modulation.

4.1.2 TEST INSTRUMENTS

DESCRIPTION & MANUFACTURER	MODEL NO.	SERIAL NO.	DATE OF CALIBRATION	DUE DATE OF CALIBRATION
Test Receiver ROHDE & SCHWARZ	ESI7	838496/016	Dec. 29, 2009	Dec. 28, 2010
Spectrum Analyzer ROHDE & SCHWARZ	FSP40	100041	May 13, 2009	May 12, 2010
BILOG Antenna SCHWARZBECK	VULB9168	9168-155	Apr. 29, 2009	Apr. 28, 2010
HORN Antenna SCHWARZBECK	BBHA 9120D	9120D-209	Jul. 01, 2009	Jun. 30, 2010
HORN Antenna SCHWARZBECK	BBHA 9170	BBHA9170242	Dec. 25, 2009	Dec. 24, 2010
Preamplifier Agilent	8449B	3008A01961	Nov. 04, 2009	Nov. 03, 2010
Preamplifier Agilent	8447D	2944A10738	Nov. 04, 2009	Nov. 03, 2010
RF signal cable HUBER+SUHNNER	SUCOFLEX 104	274041/4	Aug. 28, 2009	Aug. 27, 2010
RF signal cable HUBER+SUHNNER	SUCOFLEX 104	283397/4	Aug. 28, 2009	Aug. 27, 2010
Software ADT.	ADT_Radiated_ V7.6.15.9.2	NA	NA	NA
Antenna Tower inn-co GmbH	MA 4000	010303	NA	NA
Antenna Tower Controller inn-co GmbH	CO2000	019303	NA	NA
Turn Table ADT.	TT100.	TT93021704	NA	NA
Turn Table Controller ADT.	SC100.	SC93021704	NA	NA

- NOTE:**
1. The calibration interval of the above test instruments is 12 months and the calibrations are traceable to NML/ROC and NIST/USA.
 2. The test was performed in HwaYa Chamber 4.
 3. The horn antenna and HP preamplifier (model: 8449B) are used only for the measurement of emission frequency above 1GHz if tested.
 4. The FCC Site Registration No. is 988962.
 5. The IC Site Registration No. is IC7450F-4.

4.1.3 TEST PROCEDURES

- a. The EUT was placed on the top of a rotating table 0.8 meters above the ground at a 3 meters semi-anechoic chamber. The table was rotated 360 degrees to determine the position of the highest radiation.
- b. The EUT was set 3 meters away from the interference-receiving antenna, which was mounted on the top of a variable-height antenna tower.
- c. The antenna is a broadband antenna, and its height is varied from one meter to four meters above the ground to determine the maximum value of the field strength. Both horizontal and vertical polarizations of the antenna are set to make the measurement.
- d. For each suspected emission, the EUT was arranged to its worst case and then the antenna was tuned to heights from 1 meter to 4 meters and the rotatable table was turned from 0 degrees to 360 degrees to find the maximum reading.
- e. The test-receiver system was set to Peak Detect Function and Specified Bandwidth with Maximum Hold Mode.
- f. If the emission level of the EUT in peak mode was lower than the limit specified, then testing could be stopped and the peak values of the EUT would be reported. Otherwise the emissions would be re-tested one by one using peak, quasi-peak or average method as specified and then reported in a data sheet.

NOTE:

1. The resolution bandwidth and video bandwidth of test receiver/spectrum analyzer is 120kHz for Peak detection (PK) and Quasi-peak detection (QP) at frequency below 1GHz.
2. The resolution bandwidth of test receiver/spectrum analyzer is 1 MHz and video bandwidth is 3MHz for Peak detection at frequency above 1GHz.
3. The resolution bandwidth of test receiver/spectrum analyzer is 1MHz and the video bandwidth is 10Hz for Average detection (AV) at frequency above 1GHz.
4. All modes of operation were investigated and the worst-case emissions are reported.

4.1.4 DEVIATION FROM TEST STANDARD

No deviation.

4.1.5 TEST SETUP

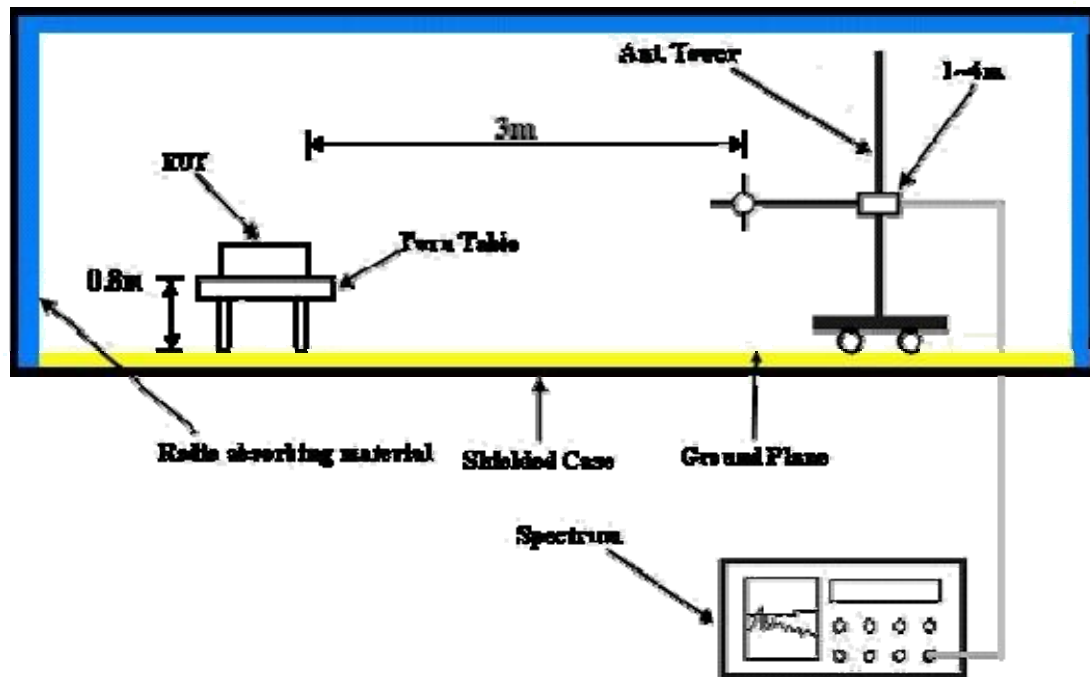

For the actual test configuration, please refer to the attached file (Test Setup Photo)

4.1.6 EUT OPERATING CONDITIONS

- a. Placed the EUT on the testing table.
- b. Prepared notebook system to act as a communication partner and placed it outside of testing area.
- c. The communication partner connected with EUT via a RJ45 cable and run a test program (provided by manufacturer) to enable EUT under transmission condition continuously at specific channel frequency.
- d. The necessary accessories enable the EUT in full functions.



A D T

4.1.7 TEST RESULTS

802.11b

EUT TEST CONDITION		MEASUREMENT DETAIL	
CHANNEL	Channel 1	FREQUENCY RANGE	1 ~ 25GHz
INPUT POWER	120Vac, 60 Hz	DETECTOR FUNCTION	Peak (PK) Average (AV)
ENVIRONMENTAL CONDITIONS	24deg. C, 64%RH 1016 hPa	TESTED BY	Match Tsui

ANTENNA POLARITY & TEST DISTANCE: HORIZONTAL AT 3 M								
NO.	FREQ. (MHz)	EMISSION LEVEL (dBuV/m)	LIMIT (dBuV/m)	MARGIN (dB)	ANTENNA HEIGHT (m)	TABLE ANGLE (Degree)	RAW VALUE (dBuV)	CORRECTION FACTOR (dB/m)
1	2386.00	57.7 PK	74.0	-16.3	1.32 H	180	24.20	33.50
2	2386.00	46.8 AV	54.0	-7.2	1.32 H	180	13.30	33.50
3	*2412.00	102.2 PK			1.32 H	50	68.60	33.60
4	*2412.00	97.9 AV			1.32 H	50	64.30	33.60
5	2494.50	56.8 PK	74.0	-17.2	1.32 H	180	22.90	33.90
6	2494.50	47.0 AV	54.0	-7.0	1.32 H	180	13.10	33.90
7	4824.00	48.5 PK	74.0	-25.5	1.18 H	310	8.50	40.00
8	4824.00	37.2 AV	54.0	-16.8	1.18 H	310	-2.80	40.00
ANTENNA POLARITY & TEST DISTANCE: VERTICAL AT 3 M								
NO.	FREQ. (MHz)	EMISSION LEVEL (dBuV/m)	LIMIT (dBuV/m)	MARGIN (dB)	ANTENNA HEIGHT (m)	TABLE ANGLE (Degree)	RAW VALUE (dBuV)	CORRECTION FACTOR (dB/m)
1	2386.00	62.6 PK	74.0	-11.4	1.20 V	183	29.10	33.50
2	2386.00	51.9 AV	54.0	-2.1	1.20 V	183	18.40	33.50
3	*2412.00	113.4 PK			1.20 V	238	79.80	33.60
4	*2412.00	109.1 AV			1.20 V	238	75.50	33.60
5	2494.50	61.2 PK	74.0	-12.8	1.08 V	79	27.30	33.90
6	2494.50	52.3 AV	54.0	-1.7	1.08 V	79	18.40	33.90
7	4824.00	49.1 PK	74.0	-24.9	1.00 V	333	9.10	40.00
8	4824.00	38.6 AV	54.0	-15.4	1.00 V	333	-1.40	40.00

- REMARKS:**
1. Emission level (dBuV/m) = Raw Value (dBuV) + Correction Factor (dB/m).
 2. Correction Factor (dB/m) = Antenna Factor (dB/m) + Cable Factor (dB).
 3. The other emission levels were very low against the limit.
 4. Margin value = Emission level – Limit value.
 5. “ * “: Fundamental frequency.



A D T

EUT TEST CONDITION		MEASUREMENT DETAIL	
CHANNEL	Channel 6	FREQUENCY RANGE	1 ~ 25GHz
INPUT POWER	120Vac, 60 Hz	DETECTOR FUNCTION	Peak (PK) Average (AV)
ENVIRONMENTAL CONDITIONS	24deg. C, 64%RH 1016 hPa	TESTED BY	Match Tsui

ANTENNA POLARITY & TEST DISTANCE: HORIZONTAL AT 3 M								
NO.	FREQ. (MHz)	EMISSION LEVEL (dBuV/m)	LIMIT (dBuV/m)	MARGIN (dB)	ANTENNA HEIGHT (m)	TABLE ANGLE (Degree)	RAW VALUE (dBuV)	CORRECTION FACTOR (dB/m)
1	2357.00	55.9 PK	74.0	-18.1	1.32 H	45	22.60	33.30
2	2357.00	46.3 AV	54.0	-7.7	1.32 H	45	13.00	33.30
3	*2437.00	100.2 PK			1.32 H	45	66.50	33.70
4	*2437.00	95.8 AV			1.32 H	45	62.10	33.70
5	7311.00	55.7 PK	74.0	-18.3	1.00 H	182	9.30	46.40
6	7311.00	43.3 AV	54.0	-10.7	1.00 H	182	-3.10	46.40
ANTENNA POLARITY & TEST DISTANCE: VERTICAL AT 3 M								
NO.	FREQ. (MHz)	EMISSION LEVEL (dBuV/m)	LIMIT (dBuV/m)	MARGIN (dB)	ANTENNA HEIGHT (m)	TABLE ANGLE (Degree)	RAW VALUE (dBuV)	CORRECTION FACTOR (dB/m)
1	2357.00	59.1 PK	74.0	-14.9	1.43 V	96	25.80	33.30
2	2357.00	49.2 AV	54.0	-4.8	1.43 V	96	15.90	33.30
3	*2437.00	111.3 PK			1.10 V	95	77.60	33.70
4	*2437.00	106.9 AV			1.10 V	95	73.20	33.70
5	7311.00	60.1 PK	74.0	-13.9	1.52 V	67	13.70	46.40
6	7311.00	52.7 AV	54.0	-1.3	1.52 V	67	6.30	46.40

- REMARKS:**
1. Emission level (dBuV/m) = Raw Value (dBuV) + Correction Factor (dB/m).
 2. Correction Factor (dB/m) = Antenna Factor (dB/m) + Cable Factor (dB).
 3. The other emission levels were very low against the limit.
 4. Margin value = Emission level – Limit value.
 5. “ * “: Fundamental frequency.



A D T

EUT TEST CONDITION		MEASUREMENT DETAIL	
CHANNEL	Channel 11	FREQUENCY RANGE	1 ~ 25GHz
INPUT POWER	120Vac, 60 Hz	DETECTOR FUNCTION	Peak (PK) Average (AV)
ENVIRONMENTAL CONDITIONS	24deg. C, 64%RH 1016 hPa	TESTED BY	Match Tsui

ANTENNA POLARITY & TEST DISTANCE: HORIZONTAL AT 3 M								
NO.	FREQ. (MHz)	EMISSION LEVEL (dBuV/m)	LIMIT (dBuV/m)	MARGIN (dB)	ANTENNA HEIGHT (m)	TABLE ANGLE (Degree)	RAW VALUE (dBuV)	CORRECTION FACTOR (dB/m)
1	2382.80	56.3 PK	74.0	-17.7	1.31 H	53	22.90	33.40
2	2382.80	46.8 AV	54.0	-7.2	1.31 H	53	13.40	33.40
3	*2462.00	101.0 PK			1.31 H	53	67.20	33.80
4	*2462.00	96.7 AV			1.31 H	53	62.90	33.80
5	2483.50	55.9 PK	74.0	-18.1	1.31 H	53	22.10	33.80
6	2483.50	47.0 AV	54.0	-7.0	1.31 H	53	13.20	33.80
7	7386.00	55.8 PK	74.0	-18.2	1.00 H	179	9.20	46.60
8	7386.00	43.5 AV	54.0	-10.5	1.00 H	179	-3.10	46.60

ANTENNA POLARITY & TEST DISTANCE: VERTICAL AT 3 M								
NO.	FREQ. (MHz)	EMISSION LEVEL (dBuV/m)	LIMIT (dBuV/m)	MARGIN (dB)	ANTENNA HEIGHT (m)	TABLE ANGLE (Degree)	RAW VALUE (dBuV)	CORRECTION FACTOR (dB/m)
1	2382.80	60.0 PK	74.0	-14.0	1.12 V	145	26.60	33.40
2	2382.80	50.1 AV	54.0	-3.9	1.12 V	145	16.70	33.40
3	*2462.00	111.9 PK			1.09 V	104	78.10	33.80
4	*2462.00	107.3 AV			1.09 V	104	73.50	33.80
5	2483.50	55.6 PK	74.0	-18.4	1.09 V	104	21.80	33.80
6	2483.50	47.3 AV	54.0	-6.7	1.09 V	104	13.50	33.80
7	7386.00	59.3 PK	74.0	-14.7	1.69 V	64	12.70	46.60
8	7386.00	52.3 AV	54.0	-1.7	1.69 V	64	5.70	46.60

- REMARKS:**
1. Emission level (dBuV/m) = Raw Value (dBuV) + Correction Factor (dB/m).
 2. Correction Factor (dB/m) = Antenna Factor (dB/m) + Cable Factor (dB).
 3. The other emission levels were very low against the limit.
 4. Margin value = Emission level – Limit value.
 5. “ * “: Fundamental frequency.



802.11g

EUT TEST CONDITION		MEASUREMENT DETAIL	
CHANNEL	Channel 1	FREQUENCY RANGE	1 ~ 25GHz
INPUT POWER	120Vac, 60 Hz	DETECTOR FUNCTION	Peak (PK) Average (AV)
ENVIRONMENTAL CONDITIONS	24deg. C, 64%RH 1016 hPa	TESTED BY	Match Tsui

ANTENNA POLARITY & TEST DISTANCE: HORIZONTAL AT 3 M								
NO.	FREQ. (MHz)	EMISSION LEVEL (dBuV/m)	LIMIT (dBuV/m)	MARGIN (dB)	ANTENNA HEIGHT (m)	TABLE ANGLE (Degree)	RAW VALUE (dBuV)	CORRECTION FACTOR (dB/m)
1	2390.00	56.3 PK	74.0	-17.7	1.37 H	49	22.80	33.50
2	2390.00	46.9 AV	54.0	-7.1	1.37 H	49	13.40	33.50
3	*2412.00	99.3 PK			1.37 H	49	65.70	33.60
4	*2412.00	88.9 AV			1.37 H	49	55.30	33.60
5	2489.00	56.6 PK	74.0	-17.4	1.37 H	49	22.70	33.90
6	2489.00	46.9 AV	54.0	-7.1	1.37 H	49	13.00	33.90
7	#7236.00	57.1 PK	79.3	-22.2	1.11 H	360	10.90	46.20
8	#7236.00	44.1 AV	68.9	-24.8	1.11 H	360	-2.10	46.20
ANTENNA POLARITY & TEST DISTANCE: VERTICAL AT 3 M								
NO.	FREQ. (MHz)	EMISSION LEVEL (dBuV/m)	LIMIT (dBuV/m)	MARGIN (dB)	ANTENNA HEIGHT (m)	TABLE ANGLE (Degree)	RAW VALUE (dBuV)	CORRECTION FACTOR (dB/m)
1	2390.00	67.1 PK	74.0	-6.9	1.13 V	154	33.60	33.50
2	2390.00	51.5 AV	54.0	-2.5	1.13 V	154	18.00	33.50
3	*2412.00	111.8 PK			1.10 V	123	78.20	33.60
4	*2412.00	101.6 AV			1.10 V	123	68.00	33.60
5	2489.00	60.8 PK	74.0	-13.2	1.41 V	159	26.90	33.90
6	2489.00	49.9 AV	54.0	-4.1	1.41 V	159	16.00	33.90
7	#7236.00	66.5 PK	91.8	-25.3	1.38 V	68	20.30	46.20
8	#7236.00	51.7 AV	81.6	-29.9	1.38 V	68	5.50	46.20

- REMARKS:**
1. Emission level (dBuV/m) = Raw Value (dBuV) + Correction Factor (dB/m).
 2. Correction Factor (dB/m) = Antenna Factor (dB/m) + Cable Factor (dB).
 3. The other emission levels were very low against the limit.
 4. Margin value = Emission level – Limit value.
 5. “ * “: Fundamental frequency.
 6. “#”:The radiated frequency is out the restricted band.



A D T

EUT TEST CONDITION		MEASUREMENT DETAIL	
CHANNEL	Channel 6	FREQUENCY RANGE	1 ~ 25GHz
INPUT POWER	120Vac, 60 Hz	DETECTOR FUNCTION	Peak (PK) Average (AV)
ENVIRONMENTAL CONDITIONS	24deg. C, 64%RH 1016 hPa	TESTED BY	Match Tsui

ANTENNA POLARITY & TEST DISTANCE: HORIZONTAL AT 3 M								
NO.	FREQ. (MHz)	EMISSION LEVEL (dBuV/m)	LIMIT (dBuV/m)	MARGIN (dB)	ANTENNA HEIGHT (m)	TABLE ANGLE (Degree)	RAW VALUE (dBuV)	CORRECTION FACTOR (dB/m)
1	2358.80	56.4 PK	74.0	-17.6	1.00 H	12	23.10	33.30
2	2358.80	46.7 AV	54.0	-7.3	1.00 H	12	13.40	33.30
3	*2437.00	98.7 PK			1.34 H	52	65.00	33.70
4	*2437.00	88.1 AV			1.34 H	52	54.40	33.70
5	7311.00	54.6 PK	74.0	-19.4	1.00 H	12	8.20	46.40
6	7311.00	42.2 AV	54.0	-11.8	1.00 H	12	-4.20	46.40
ANTENNA POLARITY & TEST DISTANCE: VERTICAL AT 3 M								
NO.	FREQ. (MHz)	EMISSION LEVEL (dBuV/m)	LIMIT (dBuV/m)	MARGIN (dB)	ANTENNA HEIGHT (m)	TABLE ANGLE (Degree)	RAW VALUE (dBuV)	CORRECTION FACTOR (dB/m)
1	2358.80	60.0 PK	74.0	-14.0	1.45 V	107	26.70	33.30
2	2358.80	48.5 AV	54.0	-5.5	1.45 V	107	15.20	33.30
3	*2437.00	111.2 PK			1.11 V	95	77.50	33.70
4	*2437.00	101.1 AV			1.11 V	95	67.40	33.70
5	7311.00	62.1 PK	74.0	-11.9	1.58 V	64	15.70	46.40
6	7311.00	48.4 AV	54.0	-5.6	1.58 V	64	2.00	46.40

- REMARKS:**
1. Emission level (dBuV/m) = Raw Value (dBuV) + Correction Factor (dB/m).
 2. Correction Factor (dB/m) = Antenna Factor (dB/m) + Cable Factor (dB).
 3. The other emission levels were very low against the limit.
 4. Margin value = Emission level – Limit value.
 5. “ * ”: Fundamental frequency.



EUT TEST CONDITION		MEASUREMENT DETAIL	
CHANNEL	Channel 11	FREQUENCY RANGE	1 ~ 25GHz
INPUT POWER	120Vac, 60 Hz	DETECTOR FUNCTION	Peak (PK) Average (AV)
ENVIRONMENTAL CONDITIONS	24deg. C, 64%RH 1016 hPa	TESTED BY	Match Tsui

ANTENNA POLARITY & TEST DISTANCE: HORIZONTAL AT 3 M								
NO.	FREQ. (MHz)	EMISSION LEVEL (dBuV/m)	LIMIT (dBuV/m)	MARGIN (dB)	ANTENNA HEIGHT (m)	TABLE ANGLE (Degree)	RAW VALUE (dBuV)	CORRECTION FACTOR (dB/m)
1	2383.00	56.7 PK	74.0	-17.3	1.04 H	42	23.30	33.40
2	2383.00	46.6 AV	54.0	-7.4	1.04 H	42	13.20	33.40
3	*2462.00	98.5 PK			1.04 H	42	64.70	33.80
4	*2462.00	88.1 AV			1.04 H	42	54.30	33.80
5	2483.50	60.1 PK	74.0	-13.9	1.02 H	37	26.30	33.80
6	2483.50	47.6 AV	54.0	-6.4	1.02 H	37	13.80	33.80
7	7386.00	58.4 PK	74.0	-15.6	1.04 H	42	11.80	46.60
8	7386.00	42.3 AV	54.0	-11.7	1.04 H	42	-4.30	46.60
ANTENNA POLARITY & TEST DISTANCE: VERTICAL AT 3 M								
NO.	FREQ. (MHz)	EMISSION LEVEL (dBuV/m)	LIMIT (dBuV/m)	MARGIN (dB)	ANTENNA HEIGHT (m)	TABLE ANGLE (Degree)	RAW VALUE (dBuV)	CORRECTION FACTOR (dB/m)
1	2383.00	61.9 PK	74.0	-12.1	1.13 V	137	28.50	33.40
2	2383.00	49.3 AV	54.0	-4.7	1.13 V	137	15.90	33.40
3	*2462.00	111.5 PK			1.10 V	103	77.70	33.80
4	*2462.00	101.1 AV			1.10 V	103	67.30	33.80
5	2483.50	71.2 PK	74.0	-2.8	1.10 V	143	37.40	33.80
6	2483.50	52.0 AV	54.0	-2.0	1.10 V	143	18.20	33.80
7	7386.00	61.3 PK	74.0	-12.7	1.70 V	65	14.70	46.60
8	7386.00	46.3 AV	54.0	-7.7	1.70 V	65	-0.30	46.60

- REMARKS:**
1. Emission level (dBuV/m) = Raw Value (dBuV) + Correction Factor (dB/m).
 2. Correction Factor (dB/m) = Antenna Factor (dB/m) + Cable Factor (dB).
 3. The other emission levels were very low against the limit.
 4. Margin value = Emission level – Limit value.
 5. “ * “: Fundamental frequency.

BELOW 1GHz WORST-CASE DATA : 802.11g

EUT TEST CONDITION		MEASUREMENT DETAIL	
CHANNEL	Channel 1	FREQUENCY RANGE	Below 1000MHz
INPUT POWER	120Vac, 60 Hz	DETECTOR FUNCTION	Quasi-Peak
ENVIRONMENTAL CONDITIONS	25deg. C, 70%RH 1012 hPa	TESTED BY	Lori Chiu
TEST MODE	A		

ANTENNA POLARITY & TEST DISTANCE: HORIZONTAL AT 3 M								
NO.	FREQ. (MHz)	EMISSION LEVEL (dBuV/m)	LIMIT (dBuV/m)	MARGIN (dB)	ANTENNA HEIGHT (m)	TABLE ANGLE (Degree)	RAW VALUE (dBuV)	CORRECTION FACTOR (dB/m)
1	166.00	38.1 QP	43.5	-5.4	1.50 H	106	24.10	14.00
2	210.72	39.9 QP	43.5	-3.6	1.00 H	73	28.70	11.20
3	249.60	44.6 QP	46.0	-1.4	1.00 H	250	30.70	13.90
4	333.21	43.7 QP	46.0	-2.3	1.00 H	67	28.40	15.30
5	500.42	40.4 QP	46.0	-5.6	1.50 H	220	19.90	20.50
6	667.63	39.0 QP	46.0	-7.0	1.00 H	316	14.70	24.30
7	741.51	39.3 QP	46.0	-6.7	1.00 H	175	13.80	25.50
8	813.45	39.4 QP	46.0	-6.6	1.00 H	175	13.10	26.30
ANTENNA POLARITY & TEST DISTANCE: VERTICAL AT 3 M								
NO.	FREQ. (MHz)	EMISSION LEVEL (dBuV/m)	LIMIT (dBuV/m)	MARGIN (dB)	ANTENNA HEIGHT (m)	TABLE ANGLE (Degree)	RAW VALUE (dBuV)	CORRECTION FACTOR (dB/m)
1	33.79	35.5 QP	40.0	-4.5	1.00 V	10	21.70	13.80
2	249.60	39.1 QP	46.0	-6.9	1.00 V	73	25.20	13.90
3	333.21	38.1 QP	46.0	-7.9	1.00 V	151	22.80	15.30
4	424.59	37.1 QP	46.0	-8.9	1.00 V	151	18.40	18.70
5	459.59	36.6 QP	46.0	-9.4	1.00 V	151	17.00	19.60
6	500.42	38.2 QP	46.0	-7.8	1.50 V	250	17.70	20.50

- REMARKS:**
1. Emission level (dBuV/m) = Raw Value (dBuV) + Correction Factor (dB/m).
 2. Correction Factor (dB/m) = Antenna Factor (dB/m) + Cable Factor (dB).
 3. The other emission levels were very low against the limit.
 4. Margin value = Emission level – Limit value.



A D T

EUT TEST CONDITION		MEASUREMENT DETAIL	
CHANNEL	Channel 1	FREQUENCY RANGE	1 ~ 25GHz
INPUT POWER	120Vac, 60 Hz	DETECTOR FUNCTION	Peak (PK) Average (AV)
ENVIRONMENTAL CONDITIONS	25deg. C, 70%RH 1016 hPa	TESTED BY	Match Tsui
TEST MODE	B		

ANTENNA POLARITY & TEST DISTANCE: HORIZONTAL AT 3 M								
NO.	FREQ. (MHz)	EMISSION LEVEL (dBuV/m)	LIMIT (dBuV/m)	MARGIN (dB)	ANTENNA HEIGHT (m)	TABLE ANGLE (Degree)	RAW VALUE (dBuV)	CORRECTION FACTOR (dB/m)
1	166.00	37.5 QP	43.5	-6.0	1.50 H	88	23.50	14.00
2	210.72	38.5 QP	43.5	-5.0	1.50 H	67	27.30	11.20
3	249.60	44.8 QP	46.0	-1.2	1.00 H	58	30.90	13.90
4	333.21	44.9 QP	46.0	-1.1	1.00 H	43	29.60	15.30
5	500.42	38.9 QP	46.0	-7.1	2.00 H	19	18.40	20.50
6	741.51	40.3 QP	46.0	-5.7	1.00 H	169	14.80	25.50
7	813.45	39.9 QP	46.0	-6.1	1.00 H	175	13.60	26.30
8	1000.10	47.1 QP	54.0	-6.9	1.50 H	319	18.30	28.80
ANTENNA POLARITY & TEST DISTANCE: VERTICAL AT 3 M								
NO.	FREQ. (MHz)	EMISSION LEVEL (dBuV/m)	LIMIT (dBuV/m)	MARGIN (dB)	ANTENNA HEIGHT (m)	TABLE ANGLE (Degree)	RAW VALUE (dBuV)	CORRECTION FACTOR (dB/m)
1	51.29	34.7 QP	40.0	-5.3	1.00 V	328	21.50	13.20
2	249.60	38.9 QP	46.0	-7.1	1.00 V	73	25.00	13.90
3	333.21	37.8 QP	46.0	-8.2	1.50 V	133	22.50	15.30
4	459.59	37.4 QP	46.0	-8.6	1.00 V	151	17.80	19.60
5	500.42	37.5 QP	46.0	-8.5	1.00 V	247	17.00	20.50
6	875.67	35.7 QP	46.0	-10.3	1.00 V	169	8.20	27.50

- REMARKS:**
1. Emission level (dBuV/m) = Raw Value (dBuV) + Correction Factor (dB/m).
 2. Correction Factor (dB/m) = Antenna Factor (dB/m) + Cable Factor (dB).
 3. The other emission levels were very low against the limit.
 4. Margin value = Emission level – Limit value.



A D T

EUT TEST CONDITION		MEASUREMENT DETAIL	
CHANNEL	Channel 1	FREQUENCY RANGE	1 ~ 25GHz
INPUT POWER	120Vac, 60 Hz	DETECTOR FUNCTION	Peak (PK) Average (AV)
ENVIRONMENTAL CONDITIONS	25deg. C, 70%RH 1016 hPa	TESTED BY	Match Tsui
TEST MODE	C		

ANTENNA POLARITY & TEST DISTANCE: HORIZONTAL AT 3 M								
NO.	FREQ. (MHz)	EMISSION LEVEL (dBuV/m)	LIMIT (dBuV/m)	MARGIN (dB)	ANTENNA HEIGHT (m)	TABLE ANGLE (Degree)	RAW VALUE (dBuV)	CORRECTION FACTOR (dB/m)
1	210.72	37.9 QP	43.5	-5.6	1.00 H	70	26.70	11.20
2	249.60	44.5 QP	46.0	-1.5	1.00 H	241	30.60	13.90
3	333.21	44.8 QP	46.0	-1.2	1.50 H	85	29.50	15.30
4	500.42	38.3 QP	46.0	-7.7	2.00 H	304	17.80	20.50
5	741.51	40.5 QP	46.0	-5.5	1.00 H	160	15.00	25.50
6	813.45	40.7 QP	46.0	-5.3	1.00 H	166	14.40	26.30
7	1000.10	46.0 QP	54.0	-8.0	1.50 H	319	17.20	28.80

ANTENNA POLARITY & TEST DISTANCE: VERTICAL AT 3 M								
NO.	FREQ. (MHz)	EMISSION LEVEL (dBuV/m)	LIMIT (dBuV/m)	MARGIN (dB)	ANTENNA HEIGHT (m)	TABLE ANGLE (Degree)	RAW VALUE (dBuV)	CORRECTION FACTOR (dB/m)
1	35.73	34.2 QP	40.0	-5.8	1.00 V	10	19.80	14.40
2	119.34	38.4 QP	43.5	-5.1	1.00 V	217	27.00	11.40
3	249.60	38.8 QP	46.0	-7.2	1.00 V	265	24.90	13.90
4	333.21	40.3 QP	46.0	-5.7	1.50 V	118	25.00	15.30
5	500.42	37.1 QP	46.0	-8.9	1.00 V	202	16.60	20.50
6	834.84	35.0 QP	46.0	-11.0	1.00 V	187	8.30	26.70

- REMARKS:**
1. Emission level (dBuV/m) = Raw Value (dBuV) + Correction Factor (dB/m).
 2. Correction Factor (dB/m) = Antenna Factor (dB/m) + Cable Factor (dB).
 3. The other emission levels were very low against the limit.
 4. Margin value = Emission level – Limit value.

EUT TEST CONDITION		MEASUREMENT DETAIL	
CHANNEL	Channel 1	FREQUENCY RANGE	Below 1000MHz
INPUT POWER	120Vac, 60 Hz	DETECTOR FUNCTION	Quasi-Peak
ENVIRONMENTAL CONDITIONS	25deg. C, 70%RH 1012 hPa	TESTED BY	Lori Chiu
TEST MODE	D		

ANTENNA POLARITY & TEST DISTANCE: HORIZONTAL AT 3 M								
NO.	FREQ. (MHz)	EMISSION LEVEL (dBuV/m)	LIMIT (dBuV/m)	MARGIN (dB)	ANTENNA HEIGHT (m)	TABLE ANGLE (Degree)	RAW VALUE (dBuV)	CORRECTION FACTOR (dB/m)
1	140.72	35.0 QP	43.5	-8.5	2.00 H	85	21.90	13.10
2	210.72	37.4 QP	43.5	-6.1	1.50 H	67	26.20	11.20
3	250.00	43.3 QP	46.0	-2.7	1.00 H	114	29.40	13.90
4	333.21	44.1 QP	46.0	-1.9	1.00 H	79	28.80	15.30
5	741.51	39.9 QP	46.0	-6.1	1.00 H	172	14.40	25.50
6	813.45	40.8 QP	46.0	-5.2	1.00 H	163	14.50	26.30
ANTENNA POLARITY & TEST DISTANCE: VERTICAL AT 3 M								
NO.	FREQ. (MHz)	EMISSION LEVEL (dBuV/m)	LIMIT (dBuV/m)	MARGIN (dB)	ANTENNA HEIGHT (m)	TABLE ANGLE (Degree)	RAW VALUE (dBuV)	CORRECTION FACTOR (dB/m)
1	33.79	35.9 QP	40.0	-4.1	1.50 V	22	22.10	13.80
2	105.73	35.0 QP	43.5	-8.5	1.00 V	121	23.40	11.60
3	249.60	39.0 QP	46.0	-7.0	2.00 V	142	25.10	13.90
4	333.21	35.1 QP	46.0	-10.9	1.50 V	118	19.80	15.30
5	529.58	35.1 QP	46.0	-10.9	1.00 V	196	14.00	21.10
6	813.45	36.3 QP	46.0	-9.7	1.50 V	139	10.00	26.30

- REMARKS:**
1. Emission level (dBuV/m) = Raw Value (dBuV) + Correction Factor (dB/m).
 2. Correction Factor (dB/m) = Antenna Factor (dB/m) + Cable Factor (dB).
 3. The other emission levels were very low against the limit.
 4. Margin value = Emission level – Limit value.

4.2 CONDUCTED EMISSION MEASUREMENT

4.2.1 LIMITS OF CONDUCTED EMISSION MEASUREMENT

FREQUENCY OF EMISSION (MHz)	CONDUCTED LIMIT (dB μ V)	
	Quasi-peak	Average
0.15-0.5	66 to 56	56 to 46
0.5-5	56	46
5-30	60	50

- NOTE:**
1. The lower limit shall apply at the transition frequencies.
 2. The limit decreases in line with the logarithm of the frequency in the range of 0.15 to 0.50 MHz.
 3. All emanations from a class A/B digital device or system, including any network of conductors and apparatus connected thereto, shall not exceed the level of field strengths specified above.

4.2.2 TEST INSTRUMENTS

DESCRIPTION & MANUFACTURER	MODEL NO.	SERIAL NO.	DATE OF CALIBRATION	DUE DATE OF CALIBRATION
Test Receiver ROHDE & SCHWARZ	ESCS30	100288	Sep. 24, 2009	Sep. 23, 2010
RF signal cable Woken	5D-FB	Cable-HYCO2-01	Dec. 31, 2009	Dec. 30, 2010
LISN ROHDE & SCHWARZ	ESH2-Z5	100100	Aug. 24, 2009	Aug. 23, 2010
LISN ROHDE & SCHWARZ	ESH3-Z5	100311	Jul. 29, 2009	Jul. 28, 2010
Software ADT	ADT_Cond_ V7.3.7	NA	NA	NA

- NOTE:**
1. The calibration interval of the above test instruments is 12 months and the calibrations are traceable to NML/ROC and NIST/USA.
 2. The test was performed in HwaYa Shielded Room 2.
 3. The VCCI Site Registration No. is C-2047.

4.2.3 TEST PROCEDURES

- a. The EUT was placed 0.4 meters from the conducting wall of the shielded room with EUT being connected to the power mains through a line impedance stabilization network (LISN). Other support units were connected to the power mains through another LISN. The two LISNs provide 50 ohm/ 50uH of coupling impedance for the measuring instrument.
- b. Both lines of the power mains connected to the EUT were checked for maximum conducted interference.
- c. The frequency range from 150kHz to 30MHz was searched. Emission levels under (Limit - 20dB) was not recorded.

NOTE: All modes of operation were investigated and the worst-case emissions are reported.

4.2.4 DEVIATION FROM TEST STANDARD

No deviation.

4.2.5 TEST SETUP

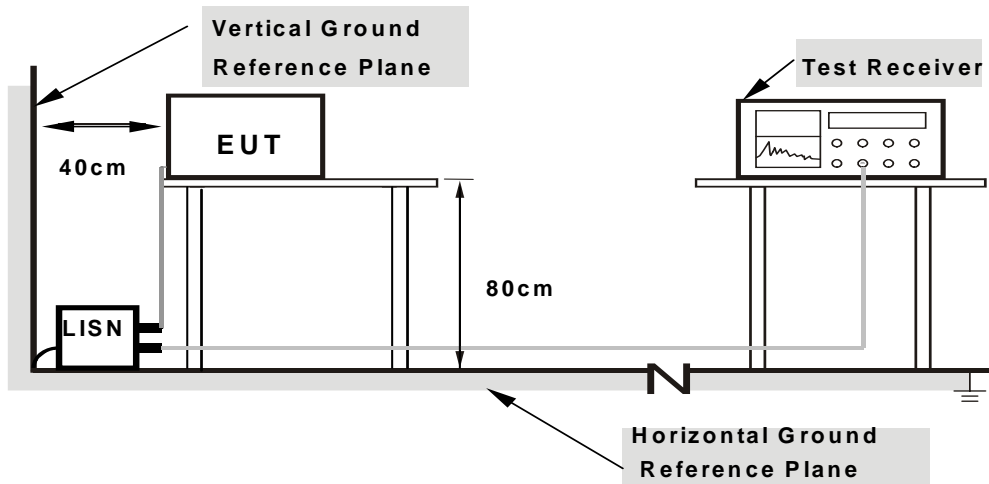

- Note:**
1. Support units were connected to second LISN.
 2. Both of LISNs (AMN) are 80 cm from EUT and at least 80 cm from other units and other metal planes

For the actual test configuration, please refer to the attached file (Test Setup Photo).

4.2.6 EUT OPERATING CONDITIONS

Same as 4.1.6.

4.2.7 TEST RESULTS

CONDUCTED WORST-CASE DATA: 802.11g

PHASE	Line 1	6dB BANDWIDTH	9kHz
TEST MODE	A		

No	Freq. [MHz]	Corr. Factor (dB)	Reading Value		Emission Level		Limit		Margin	
			[dB (uV)]		[dB (uV)]		[dB (uV)]		(dB)	
			Q.P.	AV.	Q.P.	AV.	Q.P.	AV.	Q.P.	AV.
1	0.193	0.16	49.63	-	49.79	-	63.91	53.91	-14.12	-
2	0.388	0.18	42.57	-	42.75	-	58.10	48.10	-15.35	-
3	0.517	0.19	41.73	-	41.92	-	56.00	46.00	-14.08	-
4	1.553	0.27	41.58	-	41.85	-	56.00	46.00	-14.15	-
5	3.109	0.33	44.19	-	44.52	-	56.00	46.00	-11.48	-
6	6.188	0.35	43.41	-	43.76	-	60.00	50.00	-16.24	-

- REMARKS:**
1. Q.P. and AV. are abbreviations of quasi-peak and average individually.
 2. "-": The Quasi-peak reading value also meets average limit and measurement with the average detector is unnecessary.
 3. The emission levels of other frequencies were very low against the limit.
 4. Margin value = Emission level - Limit value
 5. Correction factor = Insertion loss + Cable loss
 6. Emission Level = Correction Factor + Reading Value.

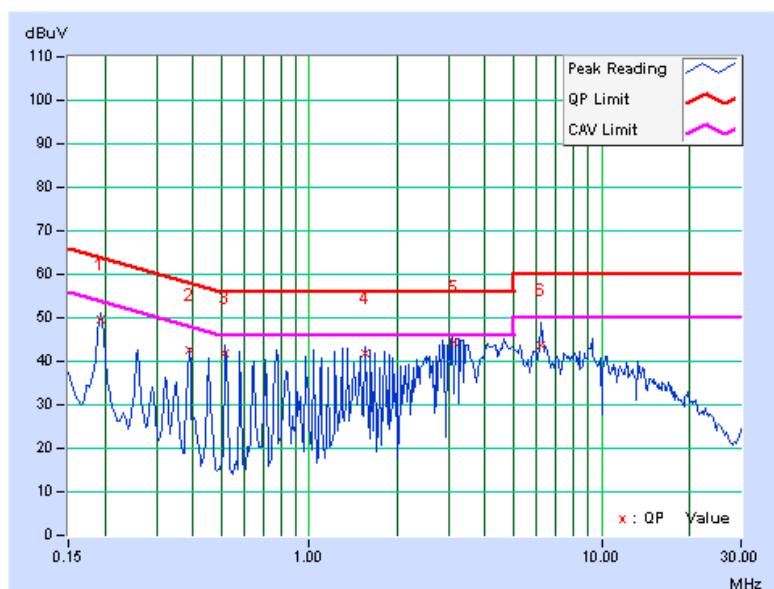

PHASE	Line 2	6dB BANDWIDTH	9kHz
TEST MODE	A		

No	Freq. [MHz]	Corr. Factor (dB)	Reading Value		Emission Level		Limit		Margin	
			[dB (uV)]		[dB (uV)]		[dB (uV)]		(dB)	
			Q.P.	AV.	Q.P.	AV.	Q.P.	AV.	Q.P.	AV.
1	0.193	0.13	50.22	-	50.35	-	63.91	53.91	-13.56	-
2	0.387	0.16	39.15	-	39.31	-	58.13	48.13	-18.82	-
3	0.518	0.17	39.76	-	39.93	-	56.00	46.00	-16.07	-
4	1.031	0.22	38.52	-	38.74	-	56.00	46.00	-17.26	-
5	3.291	0.34	42.64	-	42.98	-	56.00	46.00	-13.02	-
6	6.210	0.39	42.46	-	42.85	-	60.00	50.00	-17.15	-

- REMARKS:**
1. Q.P. and AV. are abbreviations of quasi-peak and average individually.
 2. "-": The Quasi-peak reading value also meets average limit and measurement with the average detector is unnecessary.
 3. The emission levels of other frequencies were very low against the limit.
 4. Margin value = Emission level - Limit value
 5. Correction factor = Insertion loss + Cable loss
 6. Emission Level = Correction Factor + Reading Value.

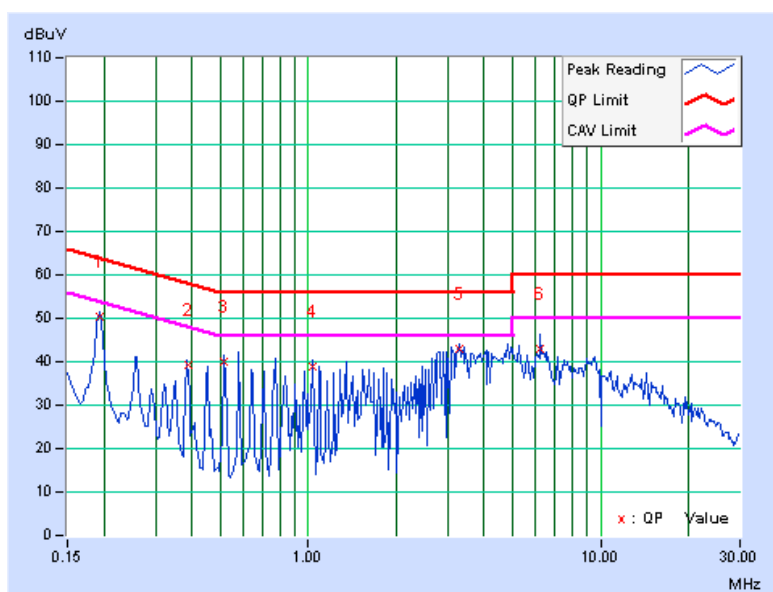

PHASE	Line 1	6dB BANDWIDTH	9kHz
TEST MODE	B		

No	Freq. [MHz]	Corr. Factor (dB)	Reading Value		Emission Level		Limit		Margin	
			[dB (uV)]		[dB (uV)]		[dB (uV)]		(dB)	
			Q.P.	AV.	Q.P.	AV.	Q.P.	AV.	Q.P.	AV.
1	0.189	0.16	60.58	47.02	60.74	47.18	64.08	54.08	-3.34	-6.90
2	0.244	0.16	53.96	40.42	54.12	40.58	61.97	51.97	-7.84	-11.38
3	0.425	0.18	46.76	-	46.94	-	57.36	47.36	-10.42	-
4	0.564	0.19	41.84	-	42.03	-	56.00	46.00	-13.97	-
5	3.039	0.33	37.88	-	38.21	-	56.00	46.00	-17.79	-
6	9.422	0.35	37.08	-	37.43	-	60.00	50.00	-22.57	-

- REMARKS:**
1. Q.P. and AV. are abbreviations of quasi-peak and average individually.
 2. "-": The Quasi-peak reading value also meets average limit and measurement with the average detector is unnecessary.
 3. The emission levels of other frequencies were very low against the limit.
 4. Margin value = Emission level - Limit value
 5. Correction factor = Insertion loss + Cable loss
 6. Emission Level = Correction Factor + Reading Value.

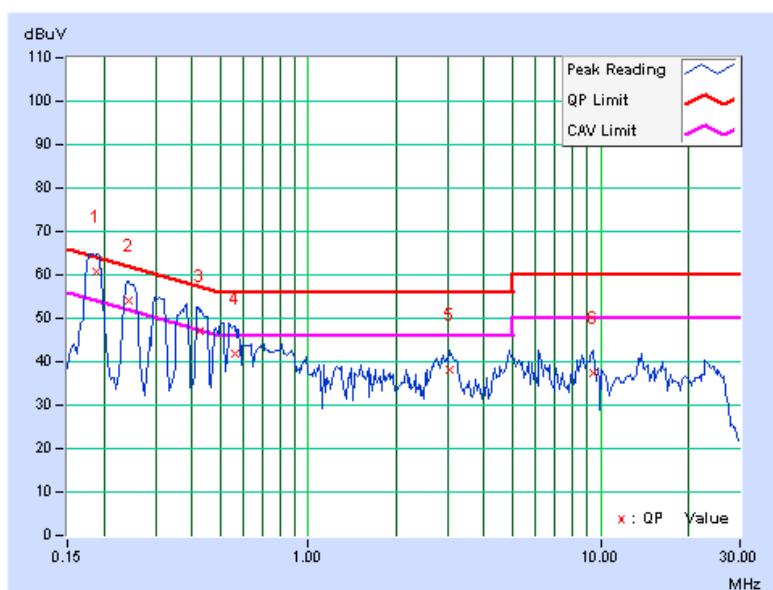

PHASE	Line 2	6dB BANDWIDTH	9kHz
TEST MODE	B		

No	Freq. [MHz]	Corr. Factor (dB)	Reading Value		Emission Level		Limit		Margin	
			[dB (uV)]		[dB (uV)]		[dB (uV)]		(dB)	
			Q.P.	AV.	Q.P.	AV.	Q.P.	AV.	Q.P.	AV.
1	0.181	0.13	57.86	45.86	57.99	45.99	64.43	54.43	-6.44	-8.44
2	0.248	0.14	50.49	-	50.63	-	61.84	51.84	-11.21	-
3	0.443	0.16	45.89	-	46.05	-	57.01	47.01	-10.95	-
4	0.552	0.18	43.15	-	43.33	-	56.00	46.00	-12.67	-
5	2.965	0.33	40.20	-	40.53	-	56.00	46.00	-15.47	-
6	6.148	0.39	42.93	-	43.32	-	60.00	50.00	-16.68	-

- REMARKS:**
1. Q.P. and AV. are abbreviations of quasi-peak and average individually.
 2. "-": The Quasi-peak reading value also meets average limit and measurement with the average detector is unnecessary.
 3. The emission levels of other frequencies were very low against the limit.
 4. Margin value = Emission level - Limit value
 5. Correction factor = Insertion loss + Cable loss
 6. Emission Level = Correction Factor + Reading Value.

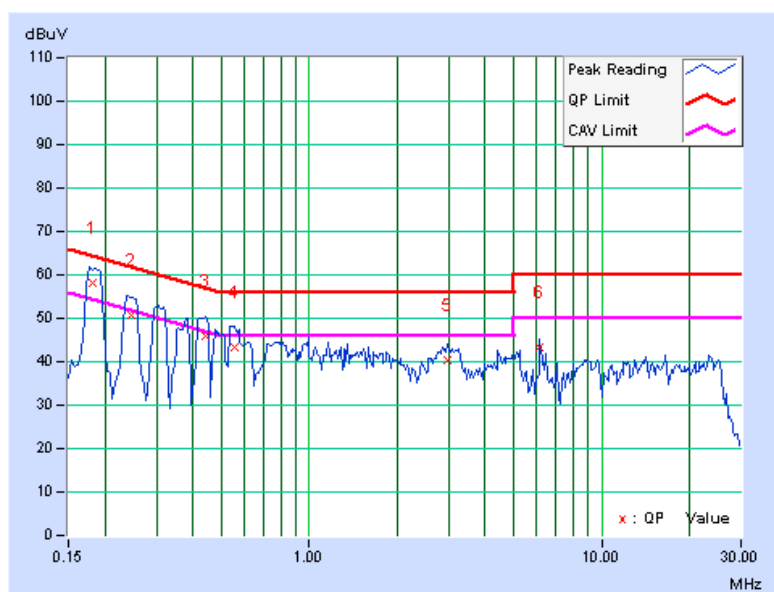

PHASE	Line 1	6dB BANDWIDTH	9kHz
TEST MODE	C		

No	Freq. [MHz]	Corr. Factor (dB)	Reading Value		Emission Level		Limit		Margin	
			[dB (uV)]		[dB (uV)]		[dB (uV)]		(dB)	
			Q.P.	AV.	Q.P.	AV.	Q.P.	AV.	Q.P.	AV.
1	0.175	0.16	56.30	45.86	56.46	46.02	64.74	54.74	-8.28	-8.72
2	0.231	0.16	48.26	-	48.42	-	62.43	52.43	-14.00	-
3	0.990	0.23	33.56	-	33.79	-	56.00	46.00	-22.21	-
4	4.711	0.35	33.01	-	33.36	-	56.00	46.00	-22.64	-
5	11.980	0.41	40.04	-	40.45	-	60.00	50.00	-19.55	-
6	16.836	0.57	38.36	-	38.93	-	60.00	50.00	-21.07	-

- REMARKS:**
1. Q.P. and AV. are abbreviations of quasi-peak and average individually.
 2. "-": The Quasi-peak reading value also meets average limit and measurement with the average detector is unnecessary.
 3. The emission levels of other frequencies were very low against the limit.
 4. Margin value = Emission level - Limit value
 5. Correction factor = Insertion loss + Cable loss
 6. Emission Level = Correction Factor + Reading Value.

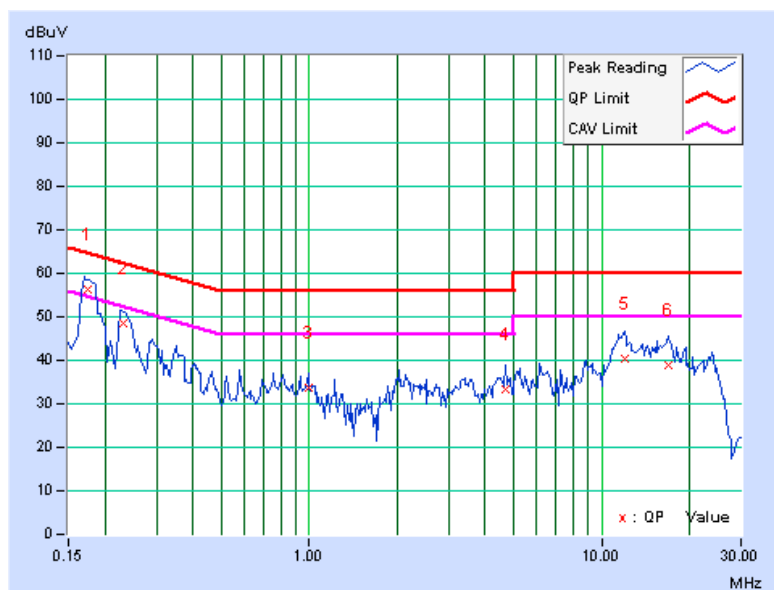

PHASE	Line 2	6dB BANDWIDTH	9kHz
TEST MODE	C		

No	Freq. [MHz]	Corr. Factor (dB)	Reading Value		Emission Level		Limit		Margin	
			[dB (uV)]		[dB (uV)]		[dB (uV)]		(dB)	
			Q.P.	AV.	Q.P.	AV.	Q.P.	AV.	Q.P.	AV.
1	0.172	0.13	57.34	46.52	57.47	46.65	64.86	54.86	-7.39	-8.21
2	0.232	0.13	48.69	-	48.82	-	62.38	52.38	-13.55	-
3	0.814	0.20	32.01	-	32.21	-	56.00	46.00	-23.79	-
4	4.594	0.37	35.06	-	35.43	-	56.00	46.00	-20.57	-
5	11.160	0.49	39.68	-	40.17	-	60.00	50.00	-19.83	-
6	16.988	0.76	37.49	-	38.25	-	60.00	50.00	-21.75	-

- REMARKS:**
1. Q.P. and AV. are abbreviations of quasi-peak and average individually.
 2. "-": The Quasi-peak reading value also meets average limit and measurement with the average detector is unnecessary.
 3. The emission levels of other frequencies were very low against the limit.
 4. Margin value = Emission level - Limit value
 5. Correction factor = Insertion loss + Cable loss
 6. Emission Level = Correction Factor + Reading Value.

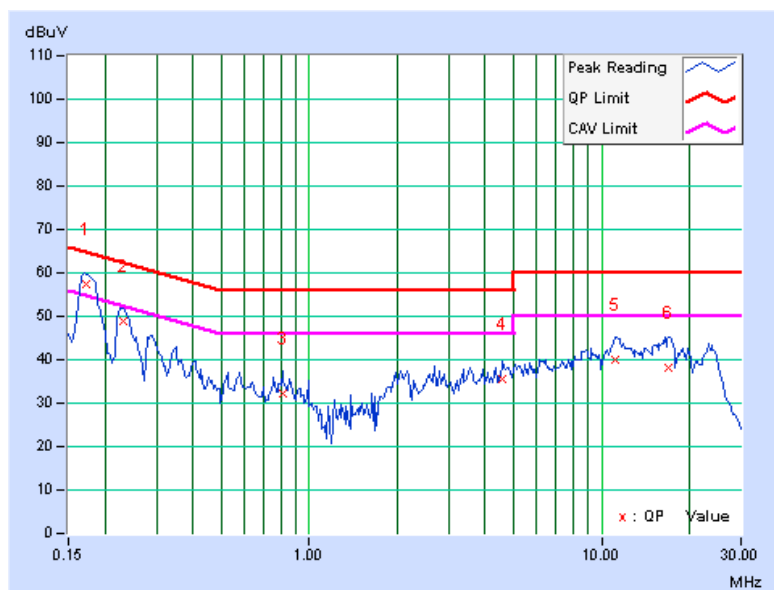

PHASE	Line 1	6dB BANDWIDTH	9kHz
TEST MODE	D		

No	Freq. [MHz]	Corr. Factor (dB)	Reading Value		Emission Level		Limit		Margin	
			[dB (uV)]		[dB (uV)]		[dB (uV)]		(dB)	
			Q.P.	AV.	Q.P.	AV.	Q.P.	AV.	Q.P.	AV.
1	0.150	0.16	59.40	38.50	59.56	38.66	66.00	56.00	-6.44	-17.34
2	0.185	0.16	57.64	46.82	57.80	46.98	64.25	54.25	-6.45	-7.27
3	0.232	0.16	50.36	-	50.52	-	62.38	52.38	-11.85	-
4	0.380	0.18	40.96	-	41.14	-	58.27	48.27	-17.13	-
5	2.199	0.31	36.85	-	37.16	-	56.00	46.00	-18.84	-
6	9.340	0.35	42.29	-	42.64	-	60.00	50.00	-17.36	-

- REMARKS:**
1. Q.P. and AV. are abbreviations of quasi-peak and average individually.
 2. "-": The Quasi-peak reading value also meets average limit and measurement with the average detector is unnecessary.
 3. The emission levels of other frequencies were very low against the limit.
 4. Margin value = Emission level - Limit value
 5. Correction factor = Insertion loss + Cable loss
 6. Emission Level = Correction Factor + Reading Value.

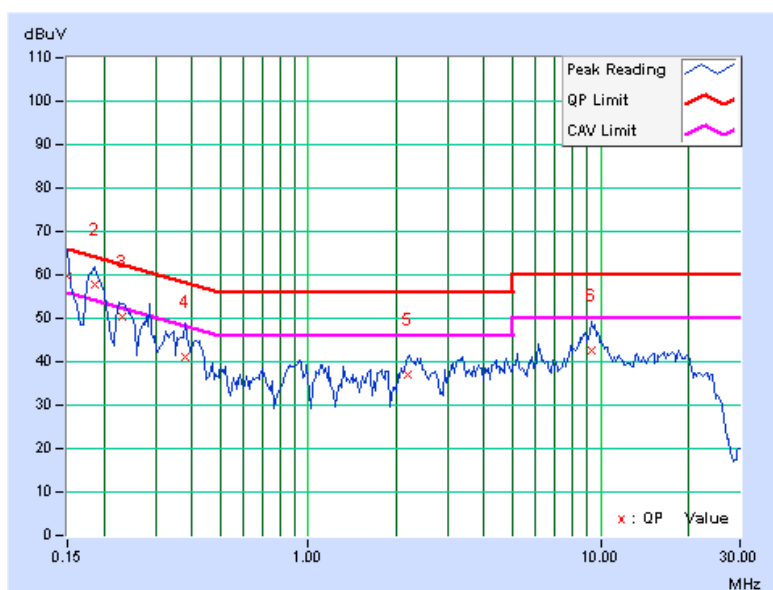

PHASE	Line 2	6dB BANDWIDTH	9kHz
TEST MODE	D		

No	Freq. [MHz]	Corr. Factor (dB)	Reading Value		Emission Level		Limit		Margin	
			[dB (uV)]		[dB (uV)]		[dB (uV)]		(dB)	
			Q.P.	AV.	Q.P.	AV.	Q.P.	AV.	Q.P.	AV.
1	0.150	0.12	60.40	38.89	60.52	39.01	66.00	56.00	-5.48	-16.99
2	0.184	0.13	58.82	47.63	58.95	47.76	64.31	54.31	-5.36	-6.55
3	0.231	0.13	51.41	-	51.54	-	62.43	52.43	-10.88	-
4	0.420	0.16	42.15	-	42.31	-	57.46	47.46	-15.15	-
5	2.195	0.31	34.97	-	35.28	-	56.00	46.00	-20.72	-
6	9.352	0.43	43.72	-	44.15	-	60.00	50.00	-15.85	-

- REMARKS:**
1. Q.P. and AV. are abbreviations of quasi-peak and average individually.
 2. "-": The Quasi-peak reading value also meets average limit and measurement with the average detector is unnecessary.
 3. The emission levels of other frequencies were very low against the limit.
 4. Margin value = Emission level - Limit value
 5. Correction factor = Insertion loss + Cable loss
 6. Emission Level = Correction Factor + Reading Value.

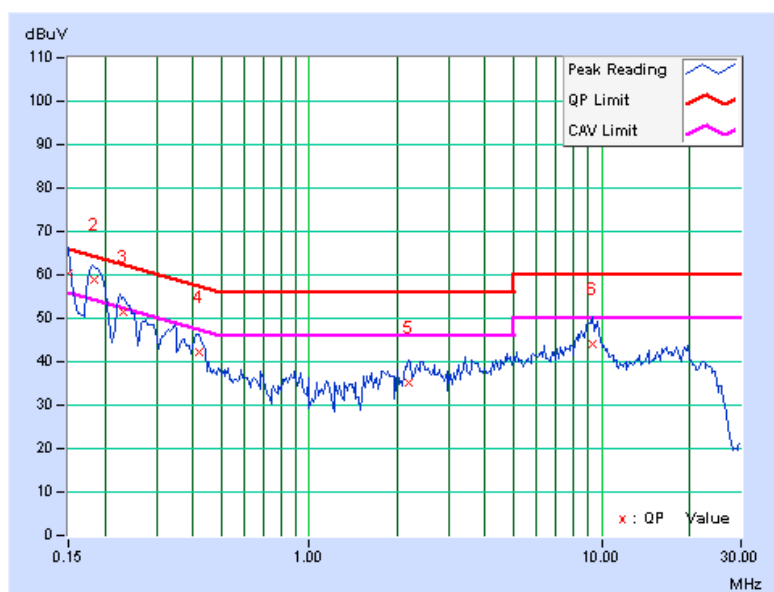

4.3 6dB BANDWIDTH MEASUREMENT

4.3.1 LIMITS OF 6dB BANDWIDTH MEASUREMENT

The minimum of 6dB Bandwidth Measurement is 0.5 MHz.

4.3.2 TEST INSTRUMENTS

DESCRIPTION & MANUFACTURER	MODEL NO.	SERIAL NO.	DATE OF CALIBRATION	DUE DATE OF CALIBRATION
R&S SPECTRUM ANALYZER	FSP40	100040	Jul. 07, 2009	Jul. 06, 2010

NOTE: The calibration interval of the above test instruments is 12 months and the calibrations are traceable to NML/ROC and NIST/USA.

4.3.3 TEST PROCEDURE

The transmitter output was connected to the spectrum analyzer through an attenuator. The bandwidth of the fundamental frequency was measured by spectrum analyzer with 100kHz RBW and 300kHz VBW. The 6dB bandwidth is defined as the total spectrum the power of which is higher than peak power minus 6dB.

4.3.4 DEVIATION FROM TEST STANDARD

No deviation.

4.3.5 TEST SETUP

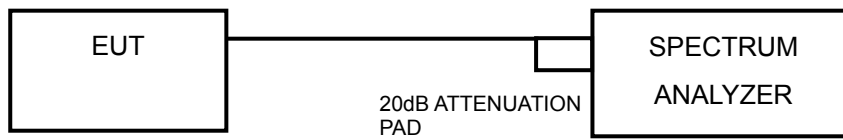

4.3.6 EUT OPERATING CONDITIONS

The software provided by client to enable the EUT under transmission condition continuously at lowest, middle and highest channel frequencies individually.

4.3.7 TEST RESULTS

802.11b

CHANNEL	CHANNEL FREQUENCY (MHz)	6dB BANDWIDTH (MHz)	MINIMUM LIMIT (MHz)	PASS / FAIL
1	2412	10.07	0.5	PASS
6	2437	10.06	0.5	PASS
11	2462	10.11	0.5	PASS

CH 11

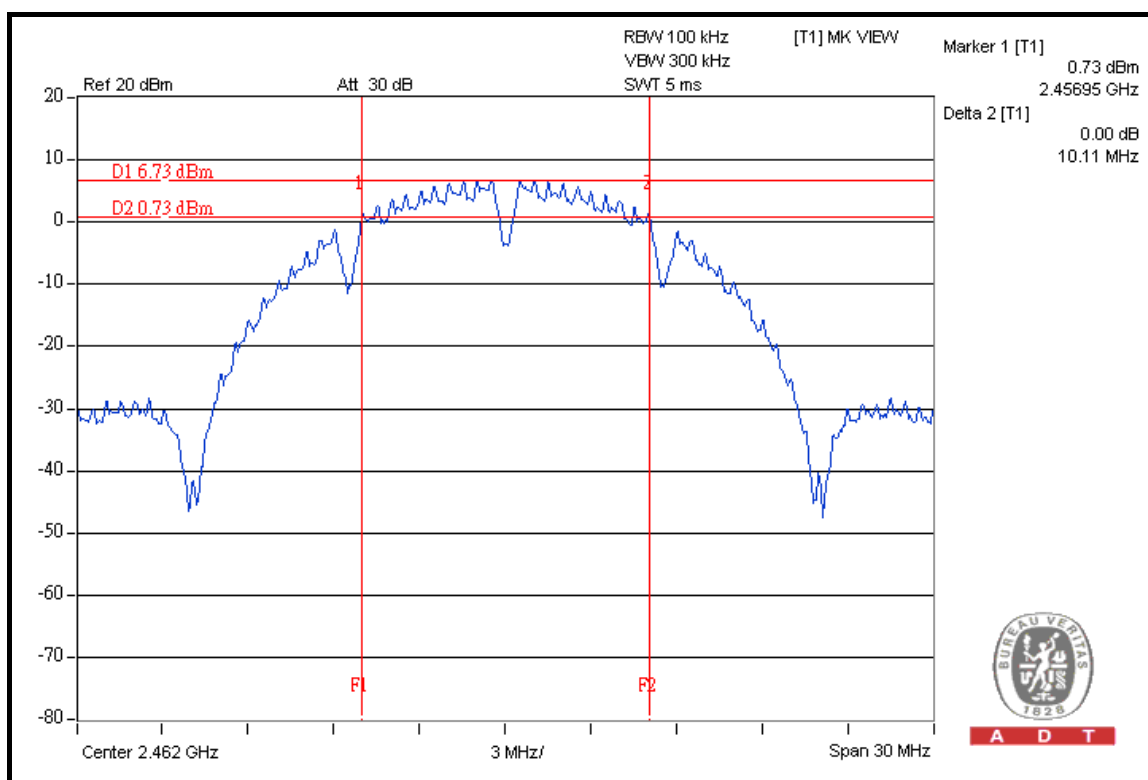



A D T

802.11g

CHANNEL	CHANNEL FREQUENCY (MHz)	6dB BANDWIDTH (MHz)	MINIMUM LIMIT (MHz)	PASS / FAIL
1	2412	16.49	0.5	PASS
6	2437	16.46	0.5	PASS
11	2462	16.45	0.5	PASS

CH 1

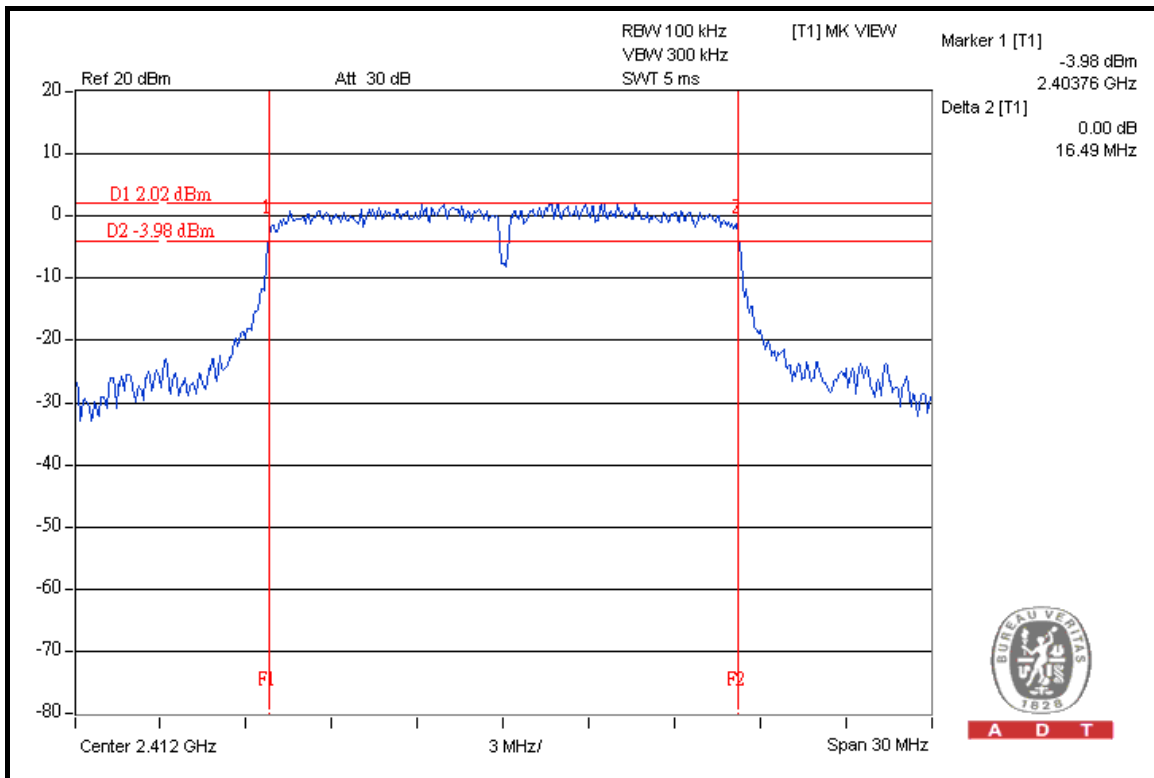

4.4 MAXIMUM OUTPUT POWER

4.4.1 LIMITS OF MAXIMUM OUTPUT POWER MEASUREMENT

The Maximum Output Power Measurement is 30dBm.

4.4.2 INSTRUMENTS

DESCRIPTION & MANUFACTURER	MODEL NO.	SERIAL NO.	DATE OF CALIBRATION	DUE DATE OF CALIBRATION
High Speed Peak Power Meter	ML2495A	0824012	Aug. 10, 2009	Aug. 09, 2010
Power Sensor	MA2411B	0738138	Aug. 10, 2009	Aug. 09, 2010

NOTE:

1. The calibration interval of the above test instruments is 12 months and the calibrations are traceable to NML/ROC and NIST/USA.
2. Measurement Bandwidth of ML2495A is 65MHz greater than 6dB bandwidth of emission.

4.4.3 TEST PROCEDURES

A power sensor was used on the output port of the EUT. A power meter was used to read the response of the power sensor. Record the power level.

4.4.4 DEVIATION FROM TEST STANDARD

No deviation.

4.4.5 TEST SETUP

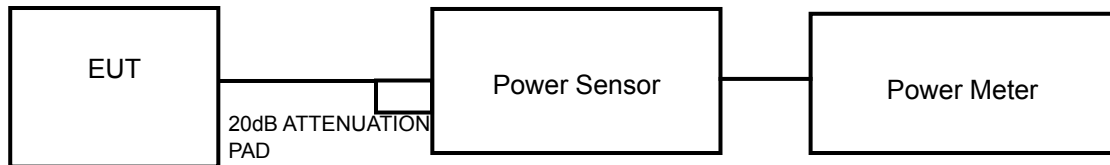

4.4.6 EUT OPERATING CONDITIONS

Same as Item 4.3.6.

4.4.7 TEST RESULTS

802.11b

CHAN	CHANNEL FREQUENCY (MHz)	POWER OUTPUT (mW)	POWER OUTPUT (dBm)	POWER LIMIT (dBm)	PASS/FAIL
1	2412	141.3	21.5	30	PASS
6	2437	79.4	19.0	30	PASS
11	2462	89.1	19.5	30	PASS

802.11g

CHAN	CHANNEL FREQUENCY (MHz)	POWER OUTPUT (mW)	POWER OUTPUT (dBm)	POWER LIMIT (dBm)	PASS/FAIL
1	2412	223.9	23.5	30	PASS
6	2437	199.5	23.0	30	PASS
11	2462	199.5	23.0	30	PASS



4.5 POWER SPECTRAL DENSITY MEASUREMENT

4.5.1 LIMITS OF POWER SPECTRAL DENSITY MEASUREMENT

The Maximum of Power Spectral Density Measurement is 8dBm.

4.5.2 TEST INSTRUMENTS

DESCRIPTION & MANUFACTURER	MODEL NO.	SERIAL NO.	DATE OF CALIBRATION	DUE DATE OF CALIBRATION
R&S SPECTRUM ANALYZER	FSP40	100040	Jul. 07, 2009	Jul. 06, 2010

NOTE: The calibration interval of the above test instruments is 12 months and the calibrations are traceable to NML/ROC and NIST/USA.

4.5.3 TEST PROCEDURE

The transmitter output was connected to the spectrum analyzer through an attenuator, the bandwidth of the fundamental frequency was measured with the spectrum analyzer using 3kHz RBW and 30kHz VBW, set sweep time = span/3kHz. The power spectral density was measured and recorded.

The sweep time is allowed to be longer than span/3kHz for a full response of the mixer in the spectrum analyzer.

4.5.4 DEVIATION FROM TEST STANDARD

No deviation.

4.5.5 TEST SETUP

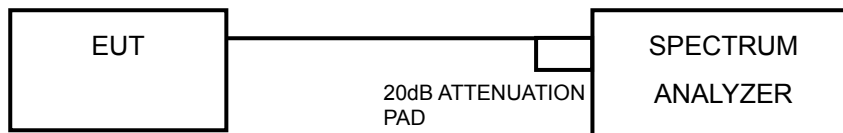

4.5.6 EUT OPERATING CONDITION

Same as Item 4.3.6.



A D T

802.11g

CHANNEL	CHANNEL FREQUENCY (MHz)	RF POWER LEVEL IN 3 kHz BW (dBm)	MAXIMUM LIMIT (dBm)	PASS/FAIL
1	2412	-12.2	8	PASS
6	2437	-12.6	8	PASS
11	2462	-12.5	8	PASS

CH 1

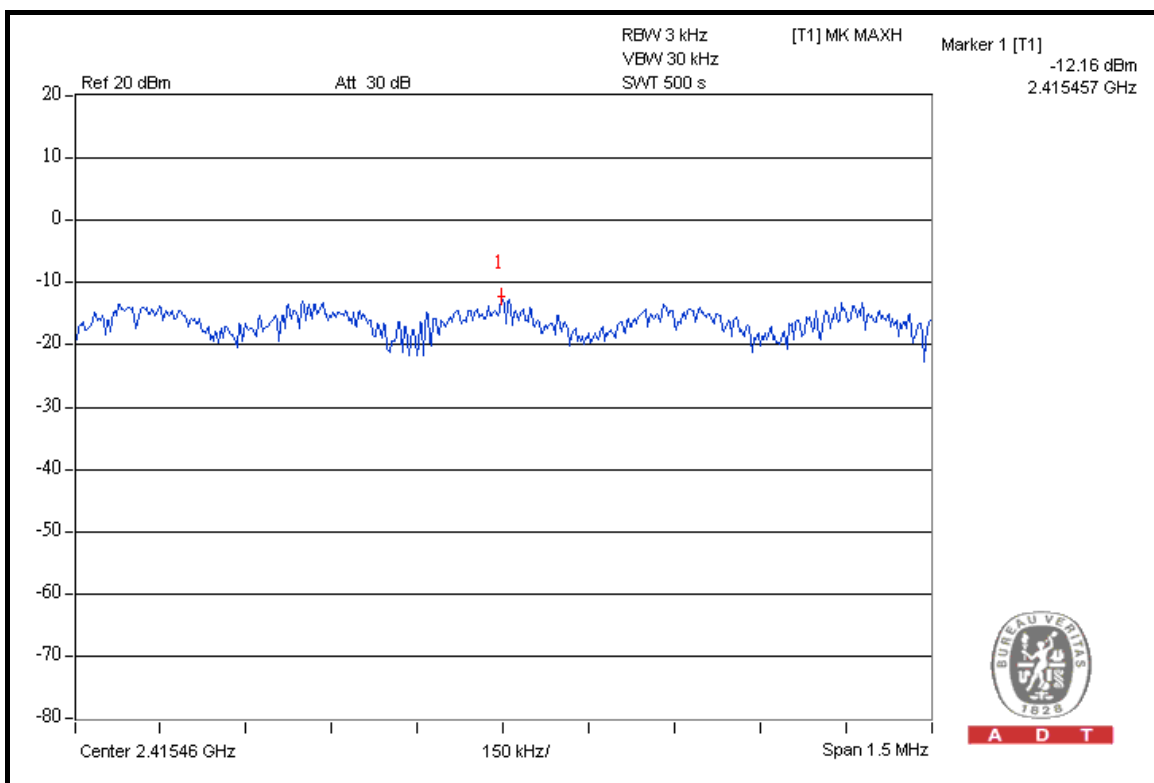

4.6 BAND EDGES MEASUREMENT

4.6.1 LIMITS OF BAND EDGES MEASUREMENT

Below –20dB of the highest emission level of operating band (in 100kHz Resolution Bandwidth).

4.6.2 TEST INSTRUMENTS

DESCRIPTION & MANUFACTURER	MODEL NO.	SERIAL NO.	DATE OF CALIBRATION	DUE DATE OF CALIBRATION
R&S SPECTRUM ANALYZER	FSP40	100040	Jul. 07, 2009	Jul. 06, 2010

NOTE: The calibration interval of the above test instruments is 12 months and the calibrations are traceable to NML/ROC and NIST/USA.

4.6.3 TEST PROCEDURE

The transmitter output was connected to the spectrum analyzer via a low lose cable. Set both RBW and VBW of spectrum analyzer to 100kHz and 300kHz with suitable frequency span including 100MHz bandwidth from band edge. The band edges was measured and recorded.

The spectrum plots (Peak RBW = 100kHz, VBW = 300kHz; Average RBW = 1MHz, VBW = 10Hz) are attached on the following pages.

4.6.4 DEVIATION FROM TEST STANDARD

No deviation.

4.6.5 EUT OPERATING CONDITION

Same as Item 4.3.6.

4.6.6 TEST RESULTS

The spectrum plots are attached on the following pages. D1 line indicates the highest level, and D2 line indicates the 20dB offset below D1. It shows compliance with the requirement in part 15.247(d).

802.11b

RESTRICT BAND (2310 ~ 2390 MHz)

FREQUENCY (MHz)	FUNDAMENTAL EMISSION (dBuV/m)	DELTA (dB)	MAXIMUM FIELD STRENGTH IN RESTRICT BAND (dBuV/m)	LIMIT (dBuV/m)
2412.00 (PK)	113.4	53.14	60.26	74.00
2412.00 (AV)	109.1	56.40	52.70	54.00

RESTRICT BAND (2483.5 ~ 2500 MHz)

FREQUENCY (MHz)	FUNDAMENTAL EMISSION (dBuV/m)	DELTA (dB)	MAXIMUM FIELD STRENGTH IN RESTRICT BAND (dBuV/m)	LIMIT (dBuV/m)
2462.00 (PK)	111.9	54.74	57.16	74.00
2462.00 (AV)	107.3	65.38	41.92	54.00

NOTE:

- Delta = Amplitude between the peak of the fundamental and the peak of the band edge emission. Please check following 3 pages.
- Maximum field strength in restrict band = Fundamental emission – Delta.



A D T

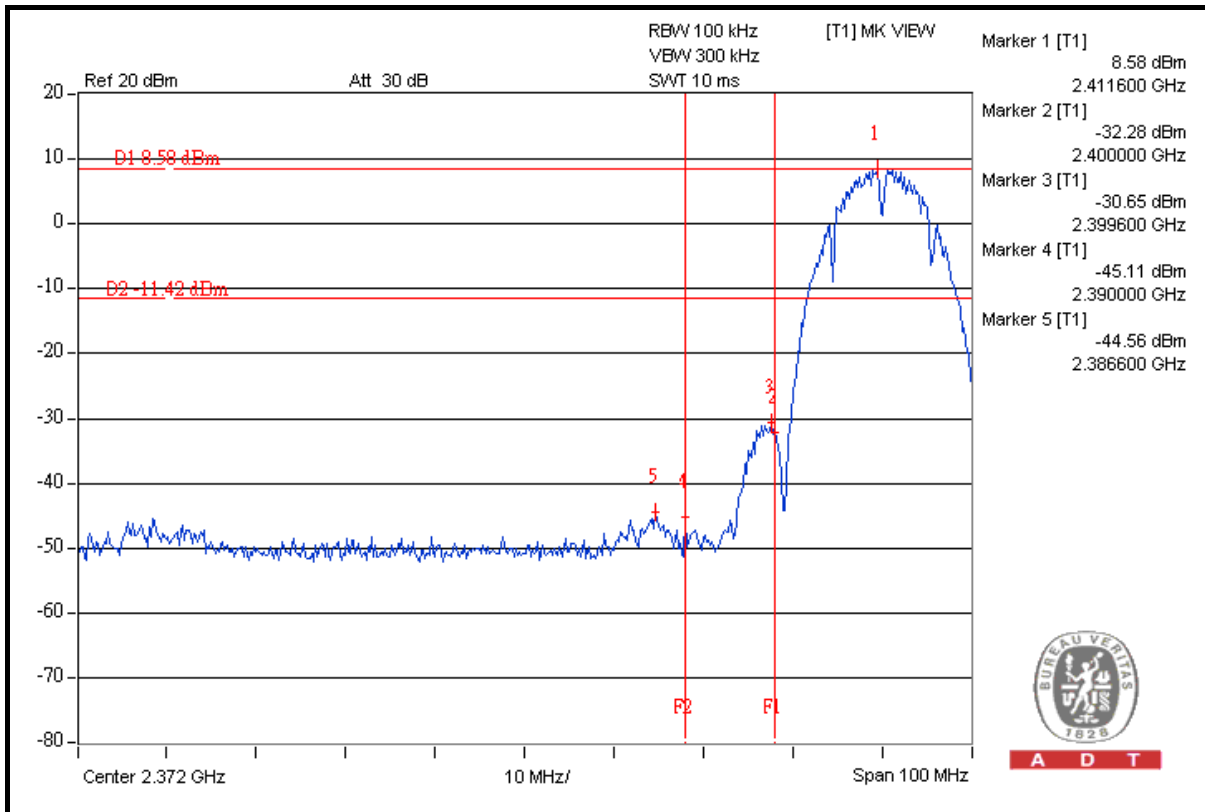

A D T

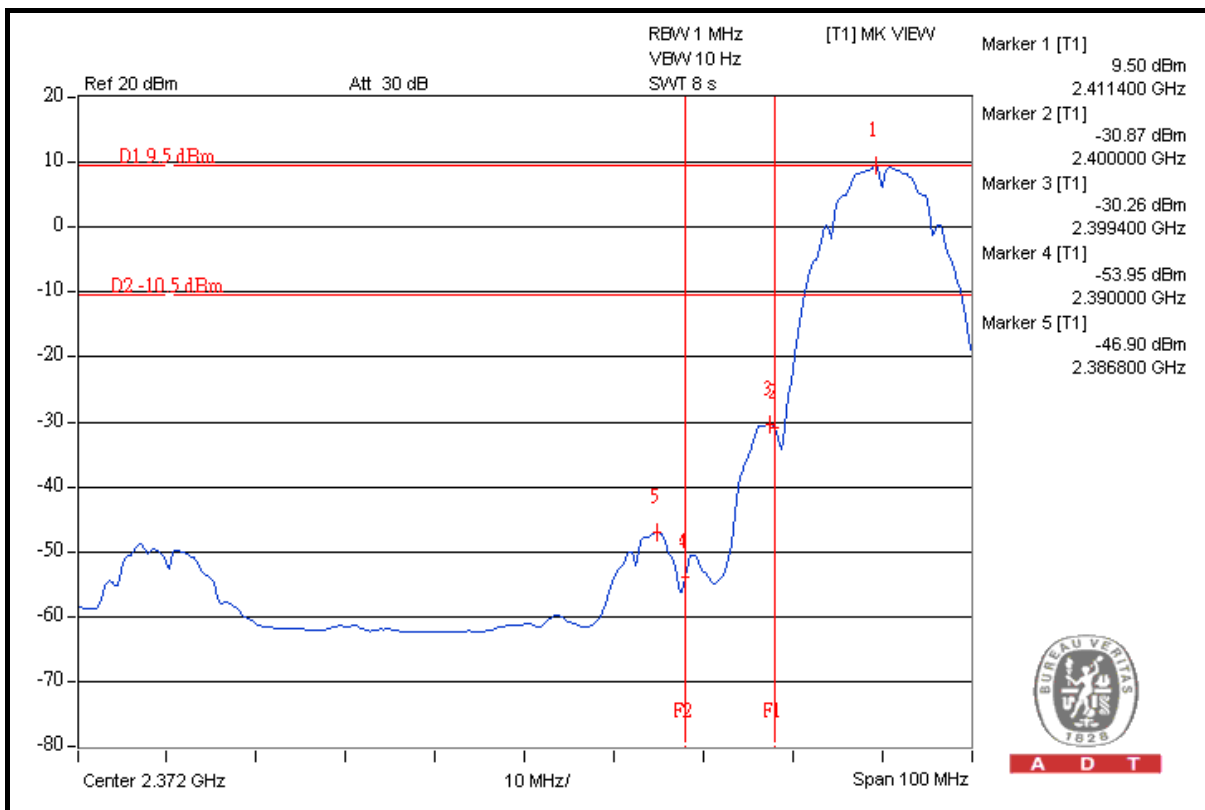

A D T



A D T

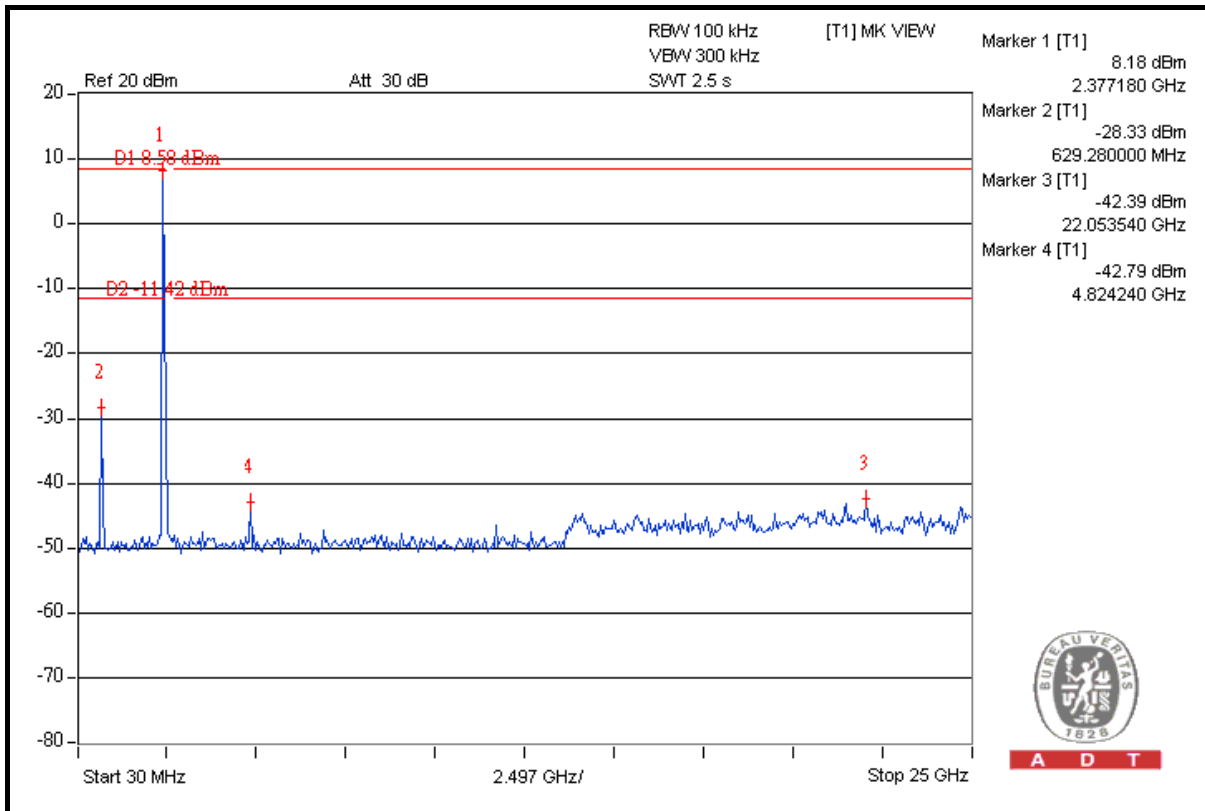

A D T

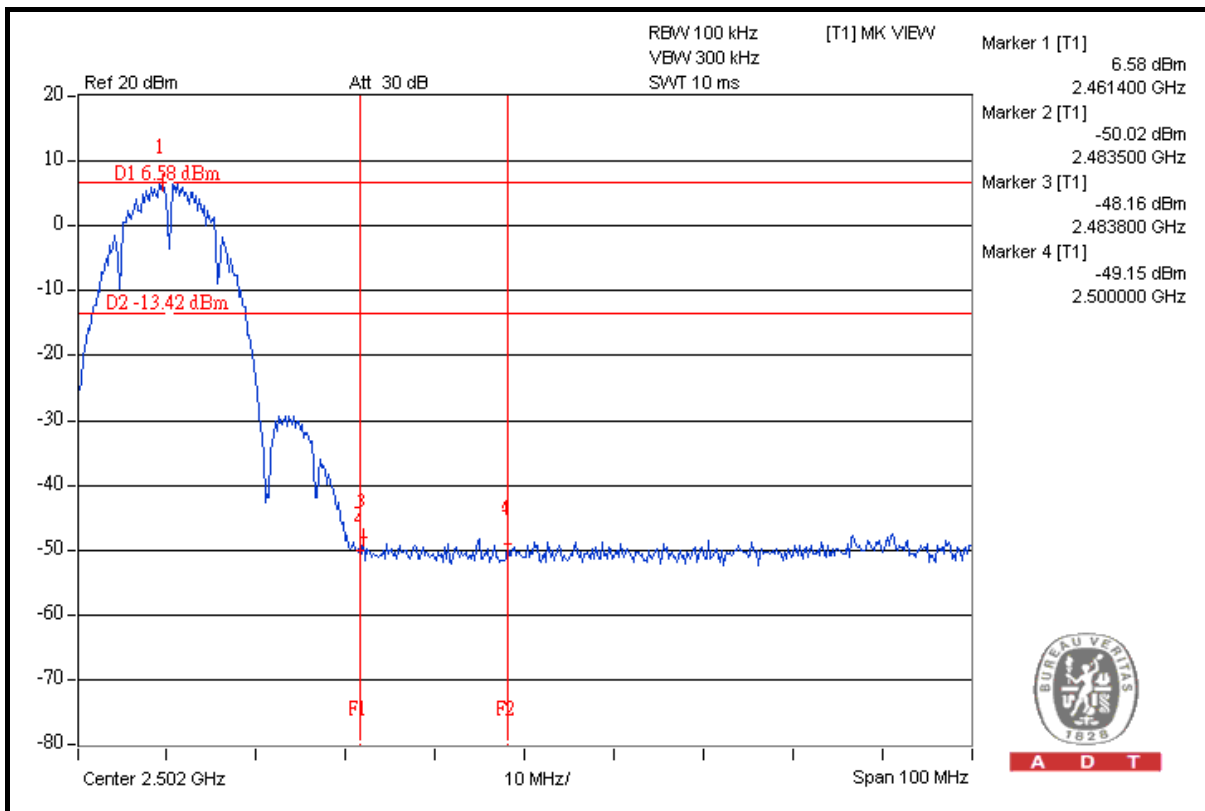

A D T



A D T

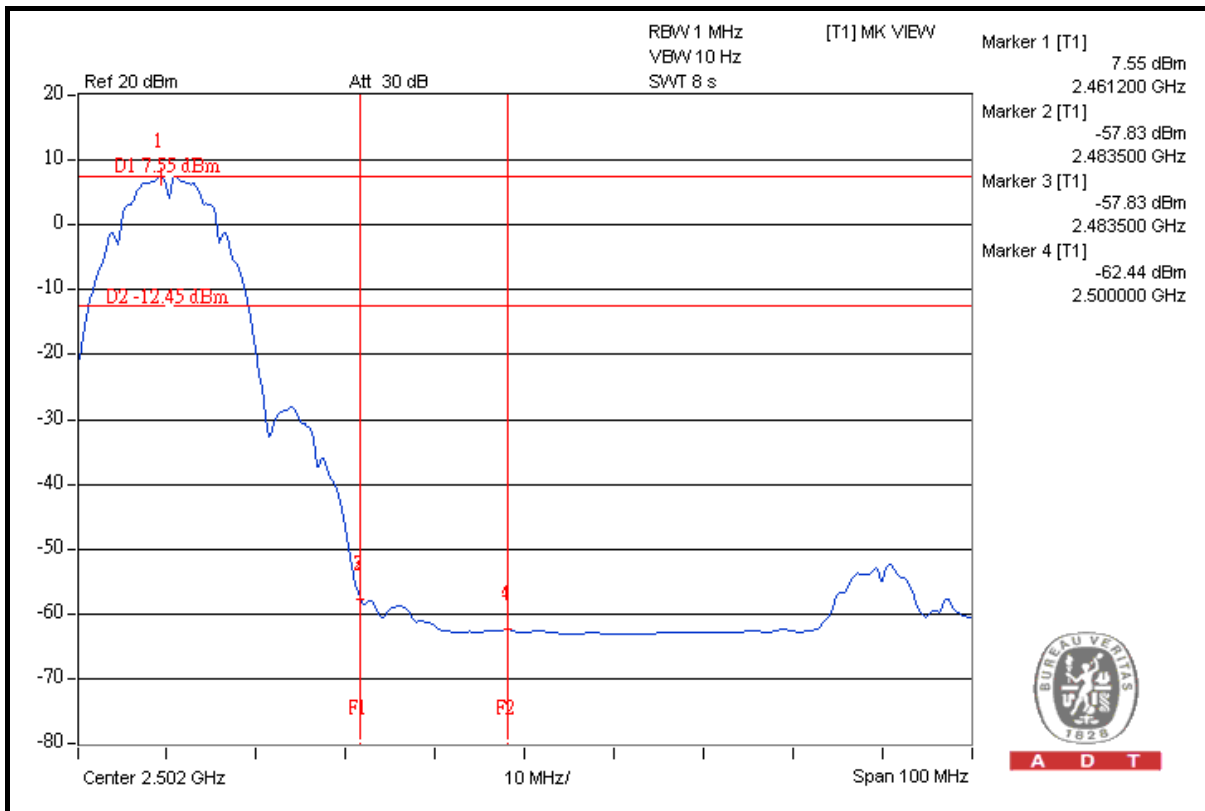

A D T

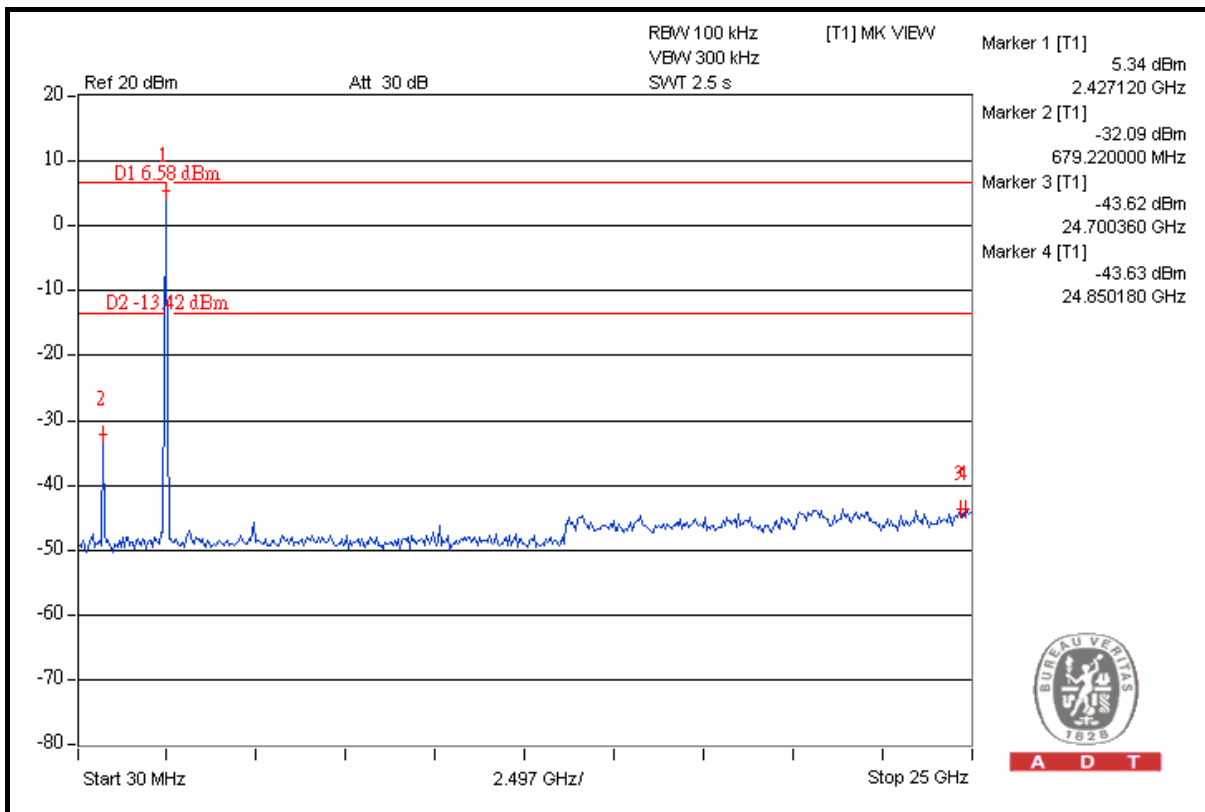

A D T

802.11g

RESTRICT BAND (2310 ~ 2390 MHz)

FREQUENCY (MHz)	FUNDAMENTAL EMISSION (dBuV/m)	DELTA (dB)	MAXIMUM FIELD STRENGTH IN RESTRICT BAND (dBuV/m)	LIMIT (dBuV/m)
2412.00 (PK)	111.8	45.59	66.21	74.00
2412.00 (AV)	101.6	49.23	52.37	54.00

RESTRICT BAND (2483.5 ~ 2500 MHz)

FREQUENCY (MHz)	FUNDAMENTAL EMISSION (dBuV/m)	DELTA (dB)	MAXIMUM FIELD STRENGTH IN RESTRICT BAND (dBuV/m)	LIMIT (dBuV/m)
2462.00 (PK)	111.5	41.99	69.51	74.00
2462.00 (AV)	101.1	48.65	52.45	54.00

NOTE:

- Delta = Amplitude between the peak of the fundamental and the peak of the band edge emission. Please check following 3 pages.
- Maximum field strength in restrict band = Fundamental emission – Delta.



A D T

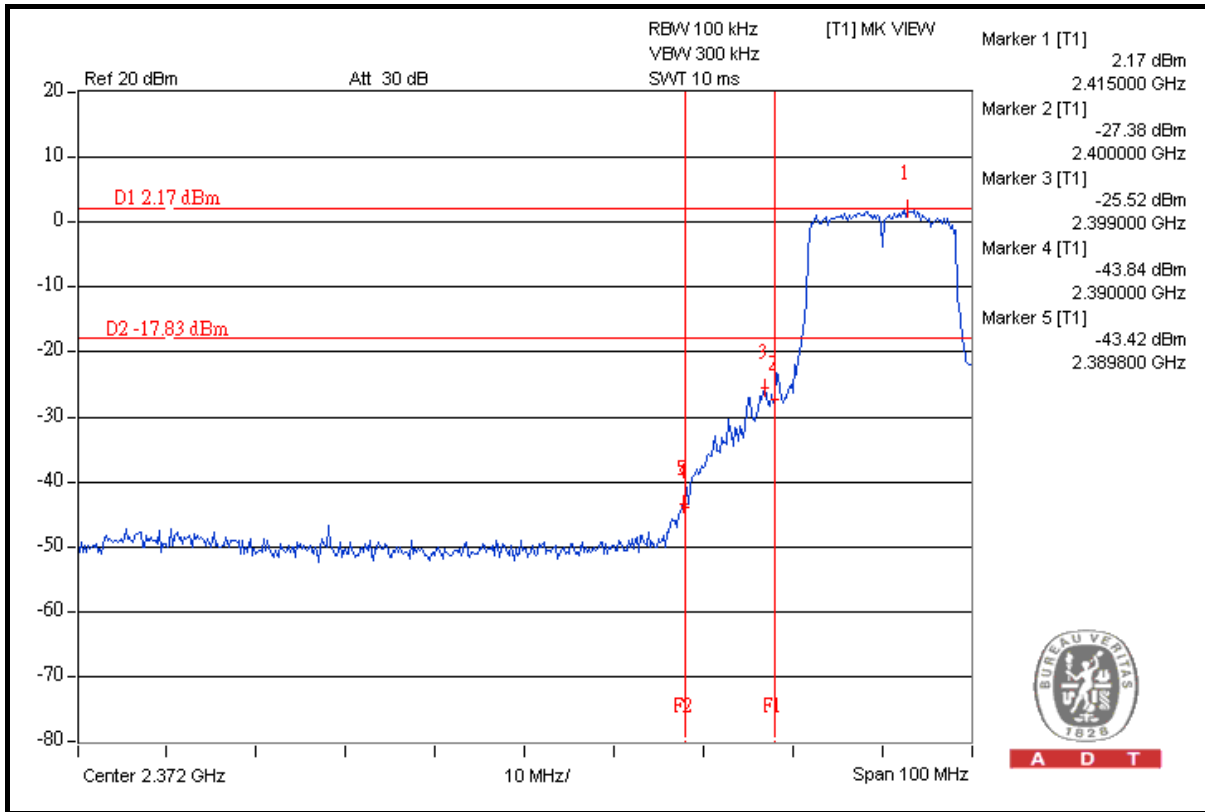

A D T

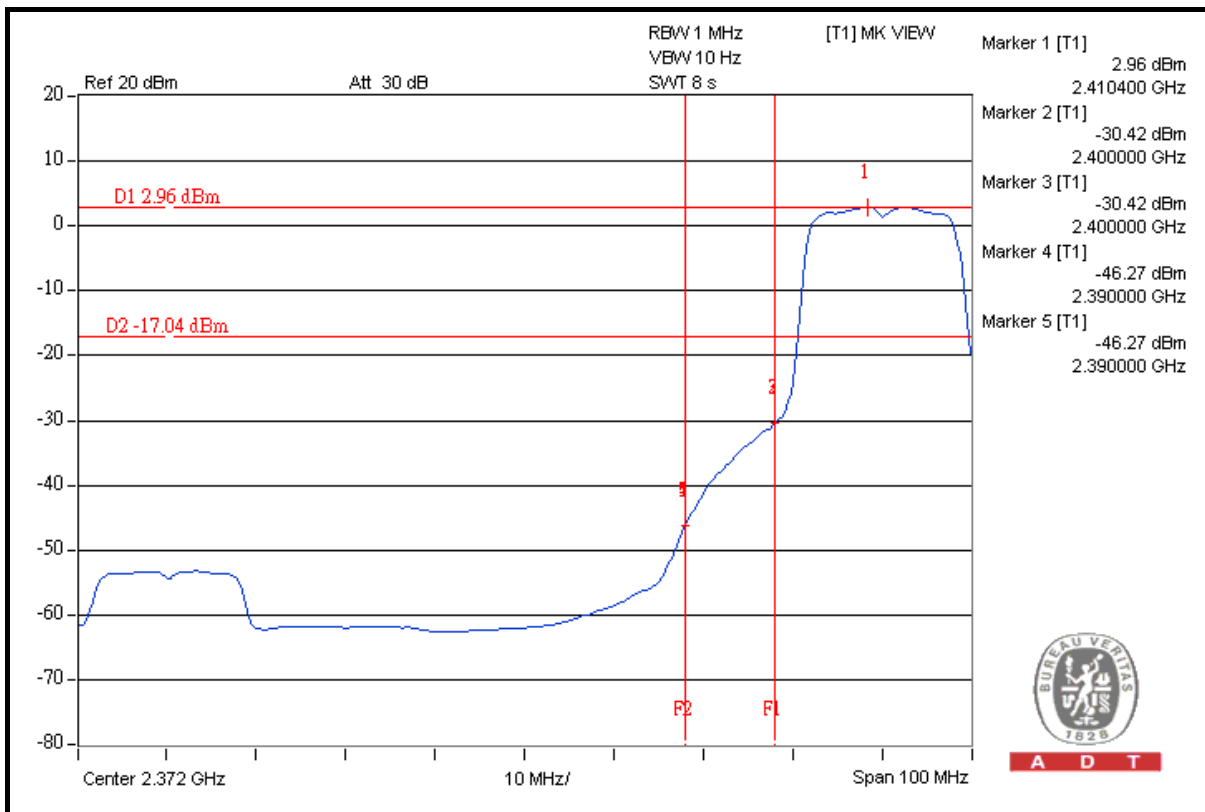

A D T



A D T

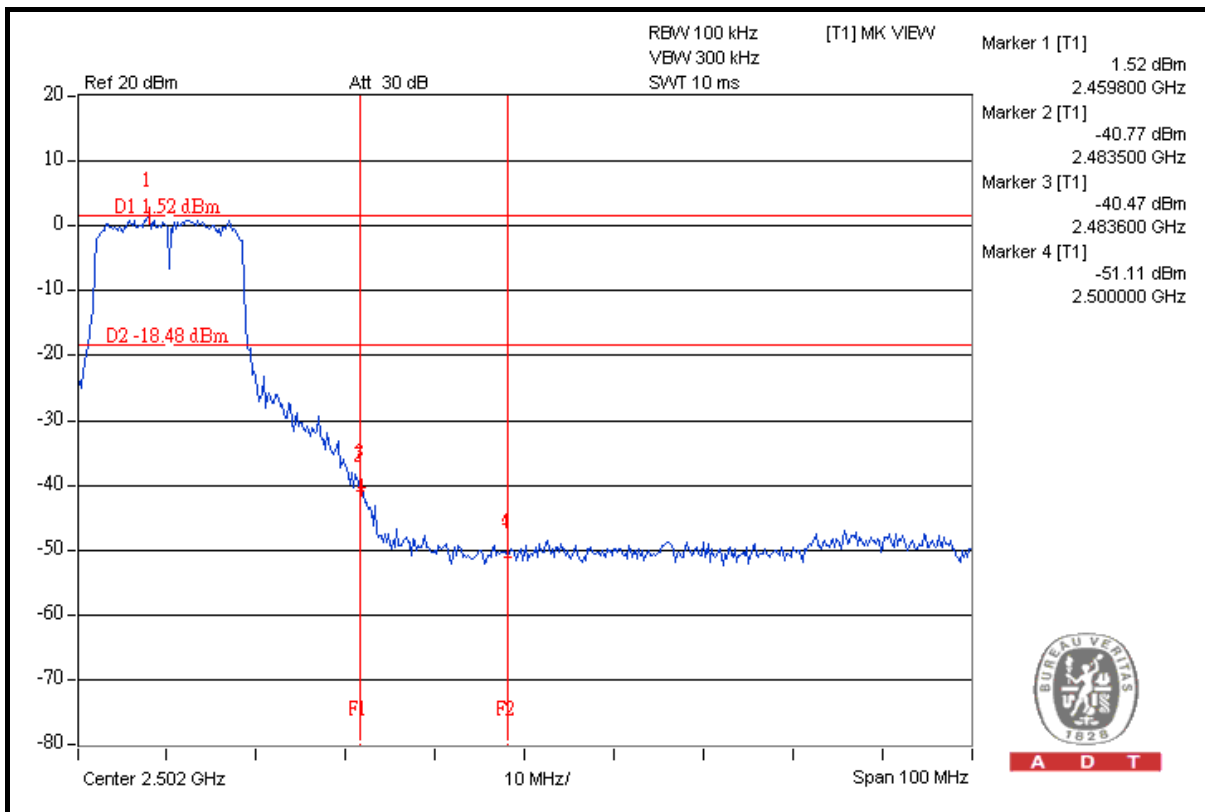
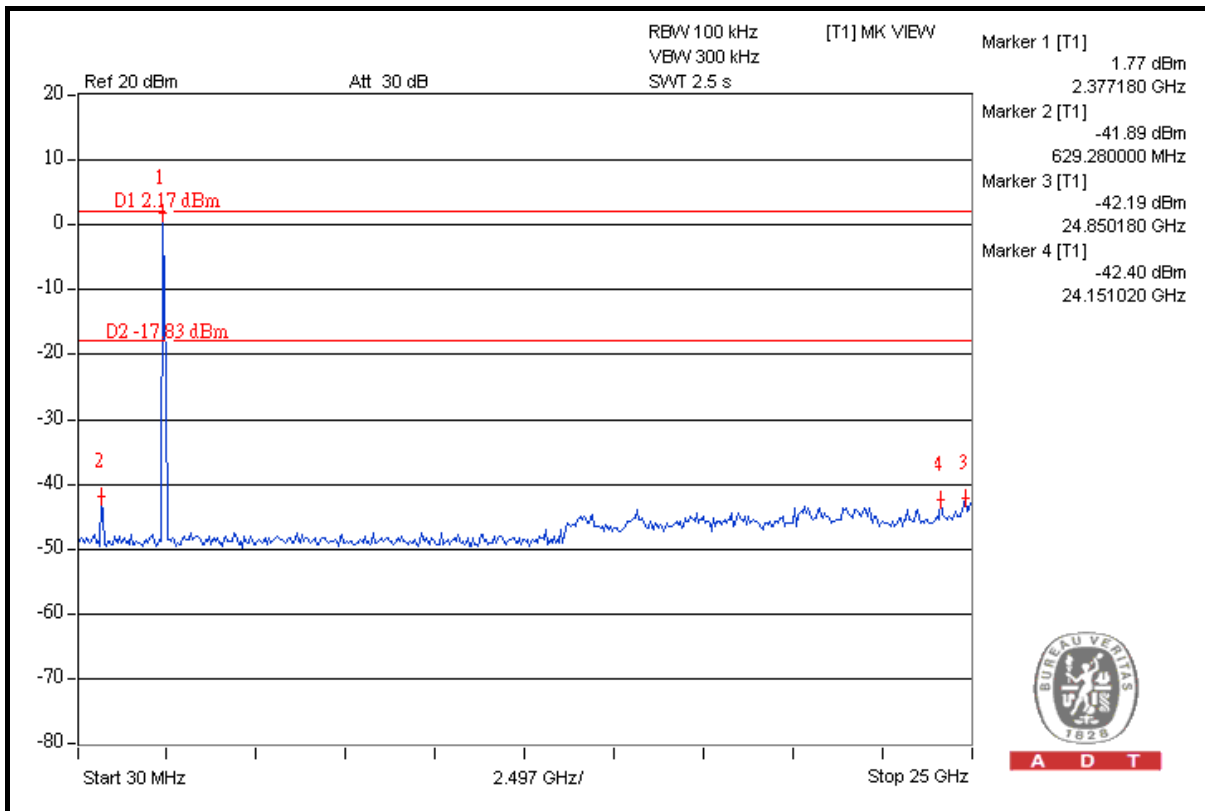



A D T

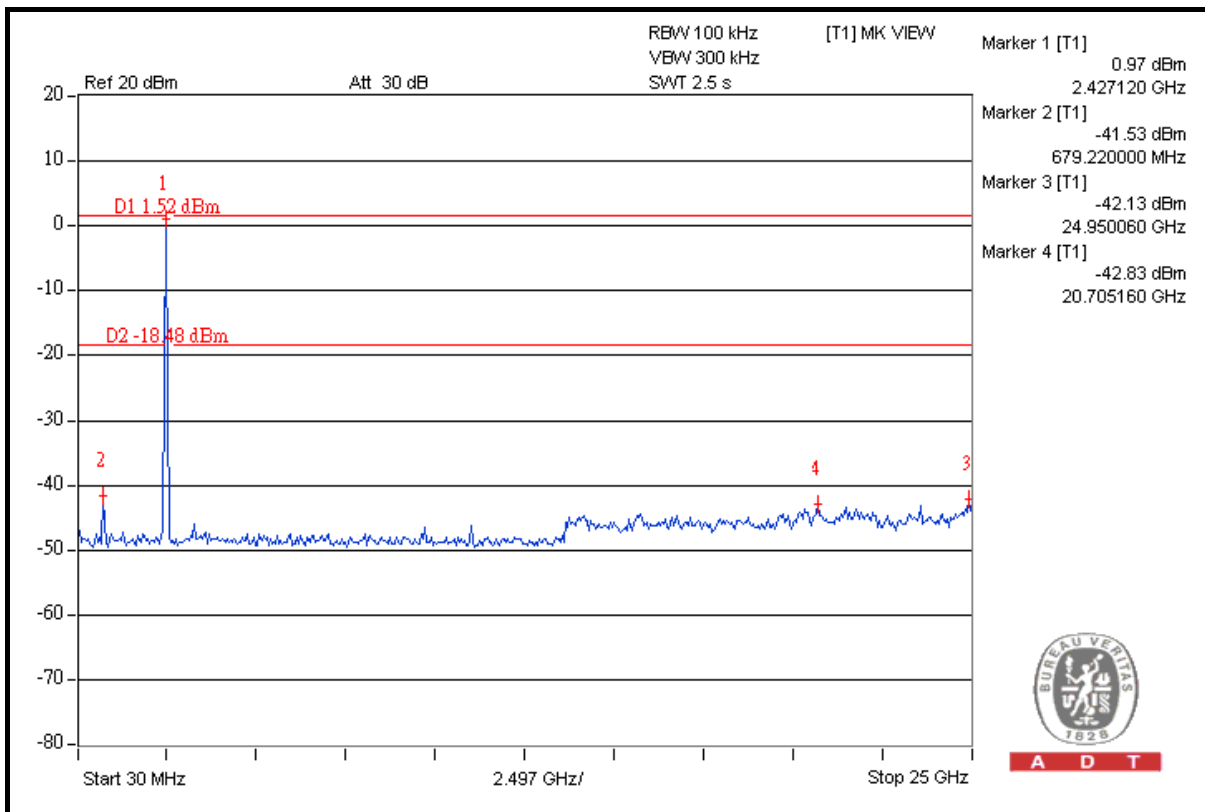
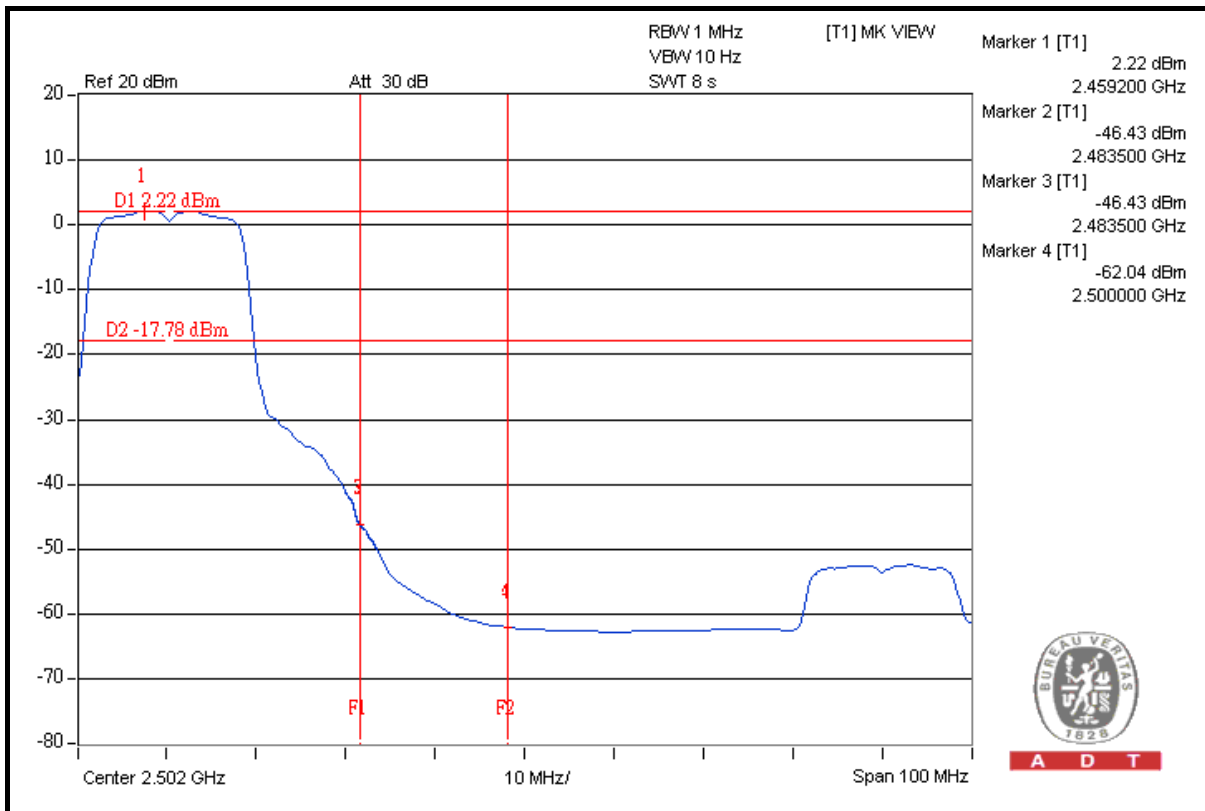

5. PHOTOGRAPHS OF THE TEST CONFIGURATION

Please refer to the attached file (Test Setup Photo).

6. INFORMATION ON THE TESTING LABORATORIES

We, Bureau Veritas Consumer Products Services (H.K.) Ltd., Taoyuan Branch, were founded in 1988 to provide our best service in EMC, Radio, Telecom and Safety consultation. Our laboratories are accredited and approved according to ISO/IEC 17025.

Copies of accreditation certificates of our laboratories obtained from approval agencies can be downloaded from our web site: www.adt.com.tw/index.5/phtml. If you have any comments, please feel free to contact us at the following:

Linko EMC/RF Lab:

Tel: 886-2-26052180

Fax: 886-2-26051924

Hsin Chu EMC/RF Lab:

Tel: 886-3-5935343

Fax: 886-3-5935342

Hwa Ya EMC/RF/Safety Telecom Lab:

Tel: 886-3-3183232

Fax: 886-3-3185050

Web Site: www.adt.com.tw

The address and road map of all our labs can be found in our web site also.

7. APPENDIX A - MODIFICATIONS RECORDERS FOR ENGINEERING CHANGES TO THE EUT BY THE LAB

No any modifications are made to the EUT by the lab during the test.

--- END ---